

CONTENTS

Introduction	1
• Welcome	1
• Features	1
• Included In Your Package	2
Setting Up And Adjusting Your Phone	3
• Selecting The Location	3
• Connecting The Telephone Line	3
• Connecting The Telephone Cords	4
• Power To The Base & Charger Units	5
• Wall Installation	6
• Attaching The Belt Clip	9
• Installing The Battery	10
• Charging The Battery	10
• Charging Second Battery	11
• Low Battery Indicator	11
• Cleaning Battery & Charging Unit Contacts	12
Handset Use	13
• ANA9620 Handset Controls	13
• Using The Handset	14
• Answering A Call	15
• Making A Call	15
Programming Functions	16
• PBX Or PSTN	16
• Program Mode Setup	16
• Programming XFER In PBX	17
• Programming CONF In PBX	18
• Using The Feature Buttons	19
• PBX Features	19
• PSTN Features	22
Accessories	24
• Optional Head Set	24
• Optional Backup Adapter	24
• Other Accessories & Parts	25
Troubleshooting	26
Specifications	27

WELCOME

Congratulations on your purchase of the Uniden **ANA9620** Cordless Telephone. The **ANA9620** is designed and engineered to exacting standards for reliability, long life, and outstanding performance. To get the most from your **ANA9620**, please read this Owner's Manual thoroughly. To familiarize you with the features of your cordless phone, refer to the handset and base illustration foldout from the rear cover.

FEATURES

- Super Long Range 900 MHz Digital
- 2-line, 16-digit LCD Display
- PBX or PSTN Operating Mode
- Single button access to: CONFERENCE, HOLD, TRANSFER, PAUSE, FLASH/REDIAL, and MUTE features
- Redial Capability up to the last 3 numbers dialed
- AutoStandby
- Any Key Answer
- AutoTalk
- Auto Line Select
- Silent Alert
- Ringer and Handset Volume Controls
- Four Ringer Tones
- Out of Range Protection
- Low Battery Protection System

PSTN or PBX

The **ANA9620** is designed to work on a standard telephone line (PSTN) or an analog PBX port (PBX).

TIP

To get the most from your phone, please read this owner's manual thoroughly.

WARNING

If any of these items are missing or damaged, contact your PBX Administrator or the Uniden Parts Department at (800)554-3988, 8:00 a.m. to 5:00 p.m. Central, Monday through Friday, or contact us on the web at www.uniden.com.

INCLUDED IN YOUR PACKAGE

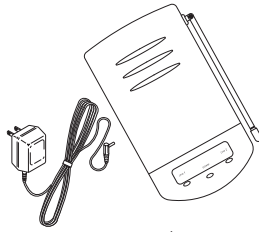

Base with
AC adapter AD9500



Handset



2 Rechargeable
Batteries

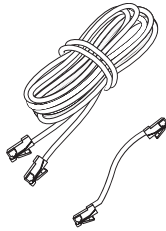

Telephone Cords

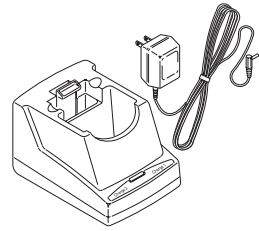

Charging Unit with
AC adapter AD960



Belt Clip

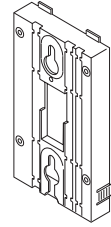

Wall Plate Adapter

- This Owner's Manual
- Precautions and Important Safety Instructions

If your **ANA9620** is not performing to your expectations, try the steps listed in the Troubleshooting Section of this Guide. If you are still unable to resolve the problem, contact your PBX Administrator or the Uniden Technical Support Department.



TIP

Before choosing a location for your phone, read the "Installation Considerations" included in the "Precautions and Important Safety Instructions" brochure.

SETTING UP AND ADJUSTING YOUR PHONE

SELECTING THE LOCATION

Select a location for the **ANA9620** to avoid excessive heat or humidity. The base of your **ANA9620** can be placed on a desk or tabletop near a standard 120V AC outlet and telephone line jack. The base can also be mounted on a *standard* AT&T or GTE wall plate using the included wall mount adapter. Keep the base and handset away from sources of electrical noise (motors, fluorescent lighting, computers).

CONNECTING THE TELEPHONE LINE

There are three types of phone outlets:

▼ 1) *Modular Jack*

Plug the telephone line cord from the base into a standard modular telephone jack(s). (**Note:** If you do not have a modular jack, contact your local telephone company for information on the installation of these jacks.)

▼ 2) *4-Prong Jack*

An adapter (not included) is required. The adapter plugs into the 4-prong jack and the telephone line cord plugs into the adapter.

▼ 3) *Hard-wired Jack*

A modular jack converter (not included) is required. You may need to rewire when connecting the converter (making color-coded connections).



Your Uniden telephone dealer or a telephone supply store can advise you on the proper adapter or converter.

TIP

To setup PSTN or PBX, refer to page 16.

CONNECTING THE TELEPHONE CORDS

The **ANA9620** must be connected to a PSTN or an analog PBX port telephone line.

CAUTION:

- Never install telephone wiring during a lightning storm.
- Never touch uninsulated telephone wires or terminals unless the telephone line has been disconnected at the network interface.
- Use caution when installing or modifying telephone lines.

▼ *Single Cord, 2-Line Combined Telephone Cord Installation*

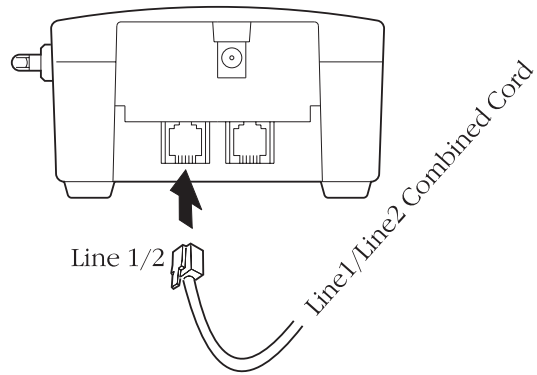

▼ *Two cord, Two-Line Telephone Cord Installation*

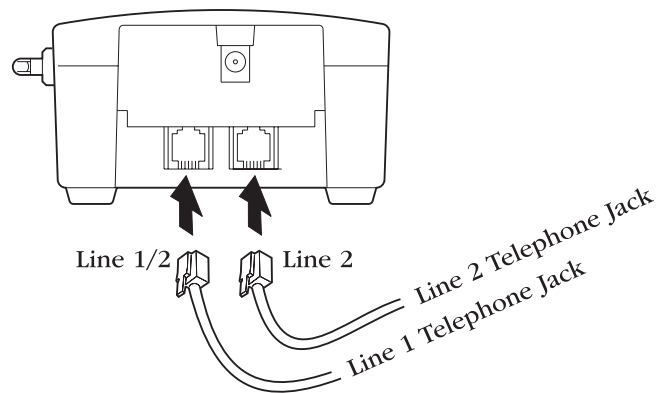

POWER TO THE BASE & CHARGER UNITS



Use only the Uniden AC adapter AD9500 supplied with this base.

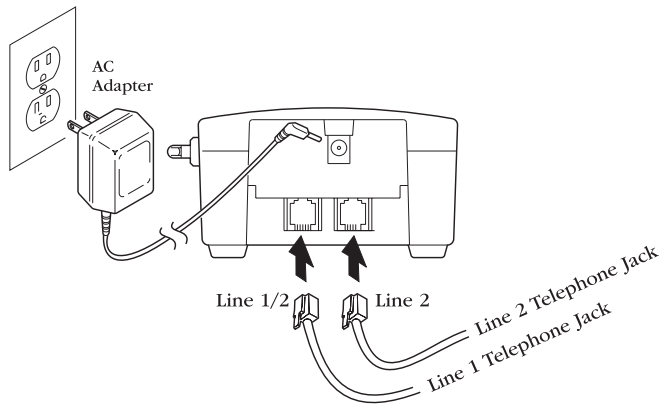

The unique design of your **ANA9620** allows you to place the handset in the charging unit with or without the belt clip attached. The charging unit also has the ability to charge a second battery with or without the handset being charged. The battery can be recharged either in or out of the handset.



Route the power cord where it will not create a trip hazard, or where it could become chafed and create a fire or other electrical hazards.

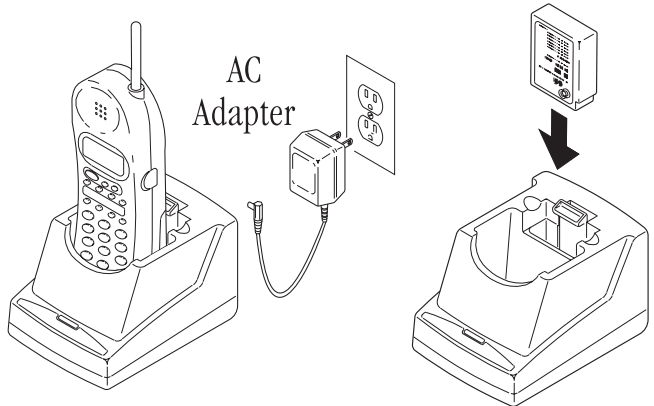

Use only the Uniden AC adapter AD960 supplied with this charging unit.

WALL INSTALLATION

▼ *Standard Wall Plate Mounting*

These phones are designed to be mounted on a standard AT&T or GTE wall plate. To attach the wall mount stand to the base:

1. Slide the wall mount stand into the notches at the top of the base, rotate the wall mount stand down and snap it into place.

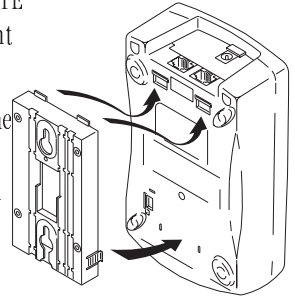

2. Plug the AC adapter into the base as previously described.
3. Place the AC adapter cord inside the molded channel of the wall mount stand.
4. Plug one end of the short telephone cord into the **LINE(s)** jack on the base. Then place the telephone cord(s) inside the molded channel(s) on the bottom of the wall mount stand.
5. Plug the other end of the short telephone cord into the modular wall jack.

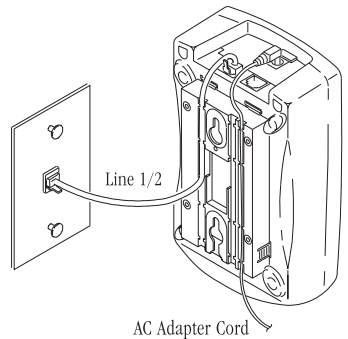

6. Place the base on the posts of the wall plate and push down until it is firmly seated.

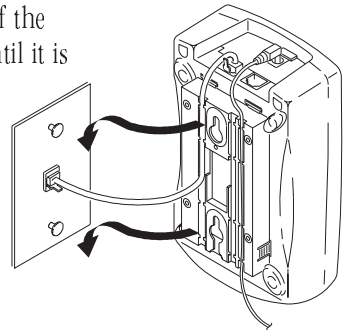

7. Plug the AC adapter into a standard 120V AC wall outlet.



Use only the Uniden AC adapter AD9500 supplied with this base.



NOTE: DO NOT use an outlet controlled by a wall switch.

▼ **Direct Wall Mounting**

If you do not have a standard wall plate, you can mount your phone directly on a wall. Before mounting your phone, consider the following:

- Select a location away from electrical cables, pipes, or other items behind the mounting location that could cause a hazard when inserting screws into the wall.
- Make sure the wall material is capable of supporting the weight of the base.
- Use #10 screws with anchoring devices suitable for the wall material where the base will be placed.

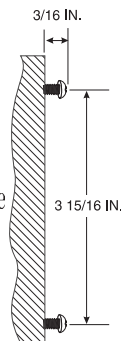

1. Insert two mounting screws $3\frac{15}{16}$ inches apart. Allow about $\frac{3}{16}$ of an inch between the wall and screw heads for mounting the phone.
2. Plug and secure the AC adapter cord by following steps 2 and 3 of the **Standard Wall Plate Mounting**.
3. Plug one end of the telephone line cord into the **LINE(s)** jack on the base. Then place the telephone cord(s) inside the molded channel(s) on the bottom of the wall mount stand.

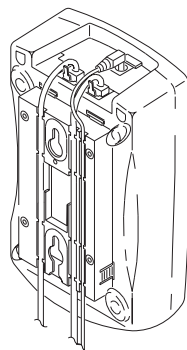

4. Place the base on the posts of the wall screws and push down until it is firmly seated.

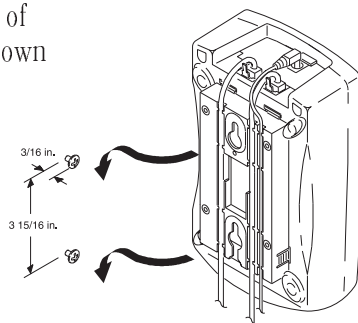

5. Plug the other end of the short telephone cord into a telephone wall jack.
6. Plug the AC adapter into a standard 120V AC wall outlet by following step 7 of the **Standard Wall Plate Mounting**.



Use only the Uniden AC adapter AD9500 supplied with this base.

▼ Charging Unit Wall Mounting

The charging unit is also designed to be wall mounted. Before mounting your charging unit, consider the following:

- Select a location away from electrical cables, pipes, or other items behind the mounting location that could cause a hazard when inserting screws into the wall.
- Make sure the wall material is capable of supporting the weight of the charging unit.
- Use #10 screws with anchoring devices suitable for the wall material where the charging unit will be placed.

1. Insert two mounting screws 1-1/2 inches apart. Allow about 3/16 of an inch between the wall and screw heads for mounting the phone.

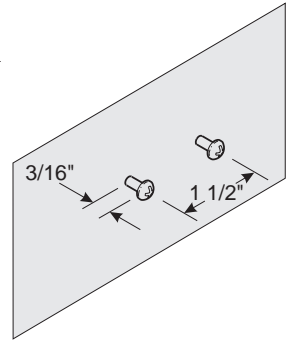

2. Plug the AC adapter into the charging unit as previously described. Wrap the AC adapter cord around the strain relief.

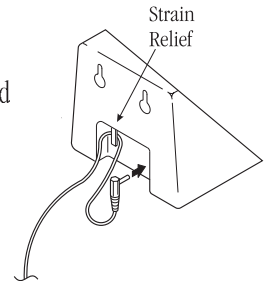

3. Place the charging unit on the posts of the wall screws and push down until it is firmly seated.

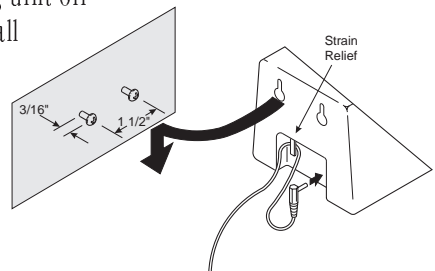

4. Plug the AC adapter into a standard 120V AC wall outlet.

ATTACHING THE BELT CLIP

You can use the belt clip to attach the handset to your belt or pocket for convenient portability.

1. Snap the tab out of the belt clip notch on the top of the handset.

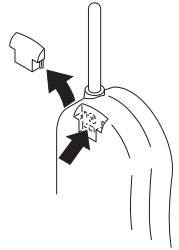

2. Slide the clip into the tab slot.

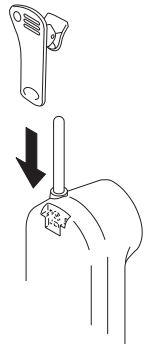

3. Press firmly until it snaps into place.

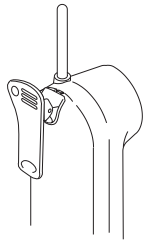

4. To remove, press the retaining clip in toward the belt clip blade and slide the clip up at the same time. Once the belt clip is removed remember to re-install the cover tab.

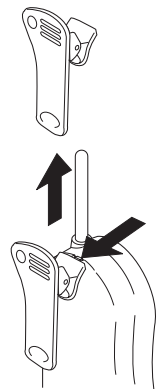



Use only the sealed lead-acid battery (part # BT9000) supplied with this phone.



Charge the battery without interruption for 5 hours.



The Charge 1 indicator light does not go off, even when the charge is complete.

INSTALLING THE BATTERY

1. Remove the battery cover by pressing the latch and sliding the cover down and off of the handset.

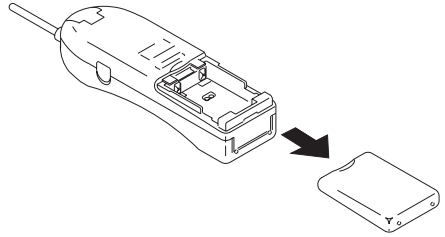

2. Slide the battery down into the handset.

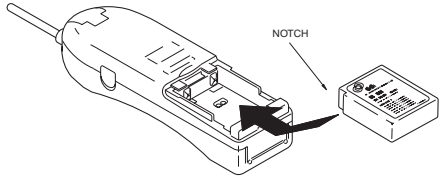

Note: The **ANA9620** has a low battery protection system which allows the battery to be replaced while in operation, as long as it is replaced within 20 seconds.

3. Place the cover and slide the cover up until it latches into the handset.

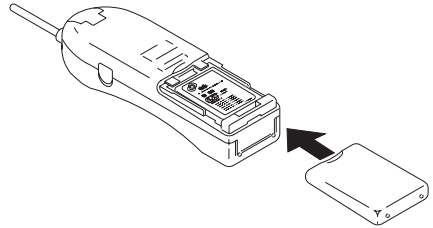

CHARGING THE BATTERY

The rechargeable sealed lead-acid battery must be fully charged before using your **ANA9620** for the first time.

1. Place the handset in the front slot of the charging unit.
2. Make sure the **CHARGE 1** indicator lights. If the **CHARGE 1** indicator doesn't light, check to see that the AC adapter is plugged in, and that the handset is making good contact with the charging unit. Two charge pockets are available on the ANA9620, with separate indicator lights for each. The handset battery and the second battery may be charged simultaneously.

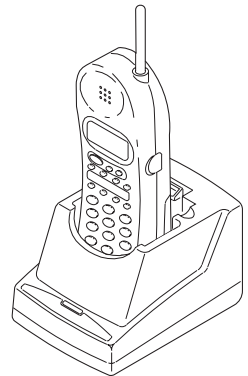

IMPORTANT

You can leave the second battery in the second slot. It will not overcharge.

NOTE

Charge the battery without interruption for 5 hours.

CHARGING SECOND BATTERY

The charger unit of your **ANA9620** is equipped to charge the second battery with or without the handset in the front slot.

1. Slide the second battery into the second slot in the charging unit until the retaining clip snaps over the top of the battery.
2. Make sure the **CHARGE 2** indicator lights. If the **CHARGE 2** indicator doesn't light, check to see that the AC adapter is plugged in, and that the battery is making good contact with the charging unit.
3. When charging is complete, the **CHARGE 2** indicator goes off. Press the latch to remove the battery. If you don't need the battery immediately, leave it in the charging compartment; it will not overcharge. If you place a fully charged battery in the **CHARGE 2** slot, the **CHARGE 2** LED lights briefly when you insert the battery.
4. You can replace the **ANA9620** battery during a call. You have up to 20 seconds to replace the battery.

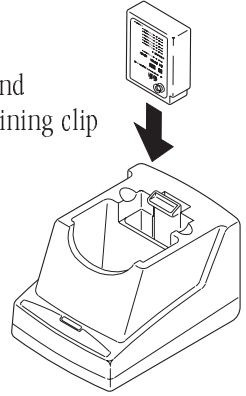

LOW BATTERY INDICATOR

When the handset battery is low and needs to be charged, you will see the **batt low** icon in the display.

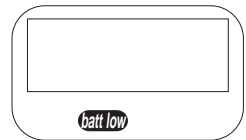

On A Call	In Standby Mode
Only the talk button operates.	None of the buttons operate.
Handset beeps once every 3 seconds.	Handset beeps every 15 seconds
Complete your call as quickly as possible	Cannot make call.
Replace battery within 20 seconds to continue call.	Replace battery before making a call.

Return the handset to the charging unit for charging or replace the handset battery with another charged battery .

NOTE

Do not clean the charging unit without first checking to ensure that it has been unplugged.

CLEANING BATTERY & CHARGING UNIT CONTACTS

To maintain a good charge, it is important to clean all charging contacts on the handset, second battery and charging unit about once a month. Use a pencil eraser or other contact cleaner. Do not use any liquids or solvents.

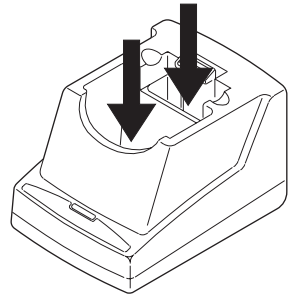

Before using your **ANA9620**, be sure to raise the antenna to the vertical position.

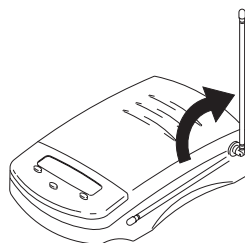

Note: Operation of the **ANA9620** is performed using the handset out of the charging unit.

ANA9620 HANDSET CONTROLS

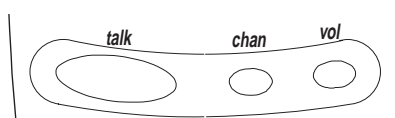

Condition	Action	LCDDisplay
Handset Earpiece Volume (talk mode)	Press vol on the front of the handset to select a high or low earpiece volume level.	No display indications.
Ringer select (standby mode)	Press vol on the front of the handset to select one of the following settings:	
	Ring type A (High)	
	Ring type A (Low)	
	Ring Type B (High)	
	Ring Type B (Low)	
Ring Off (Silent Alert)		

USING THE HANDSET

When you pick up the handset and press **talk**, you will see:

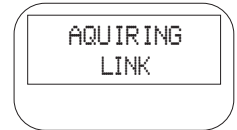

After the connection has been made between the handset and base, the display will show the lines currently connected:



Or, you may see one of the following:

Condition	Indicator	LCD Screen
no connection to base	error tone	no service
channel busy	error tone	no display indication.
line in use	l1 or l2 indicator blinks.	l1 line in use or l2 line in use

If the handset is at the range limit of the **ANA9620**, or no power is going to the base, you may see:

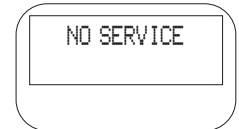

Take the following action:

	During a Call	In Standby Mode
Condition	Sound is Muted	Can't make or answer calls (Phone may ring intermittently)
Action	Move back in range within 20 seconds or check power to the base.	Move back within range or check power to the base.

ANSWERING A CALL

When you receive a call, the handset rings and you will see:

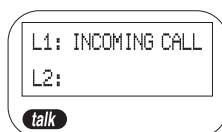

Handset in the Charging Unit	Handset out of Charging Unit
Pick up the handset. The AutoTalk feature allows you to answer the call immediately.	Press talk . Or press any key on the numeric keypad, or HOLD , PAUSE or FLASH/RDL .
When you finish the call, place the handset back in the charging unit. AutoStandby automatically hangs up the phone. —OR— Press talk to hang up the phone.	

MAKING A CALL

Press talk.

The **ANA9620** selects the last line used. If one line is busy, the phone automatically selects an available line.

OR

Press L1 or L2.



When you hear a dial tone, enter the number you are calling.

To hang up, press **talk**.

REDIAL FUNCTION

The **ANA9620** stores up to the last three phone numbers you dialed. To redial these numbers:

1. Press **FLASH/RDL**

The last number dialed appears in the display.

To scroll through the remaining two numbers, press **FLASH/RDL** again.

2. When the desired number appears, press **talk**, **L1** or **L2** to redial.

PBX OR PSTN

In the Programming mode, you can select either Analog PBX or PSTN (Public Service Telephone Network) operation. The default is PSTN.

Available features of each mode of operation are illustrated in the table below.



Feature	Analog PBX	PSTN
Conference	Conference by PBX	Connect Lines 1 & 2
Transfer	Transfer by PBX	Not Available



Note: Both Conference and Transfer commands must be programmed to their respective keys before these features can be used.

PROGRAM MODE SETUP

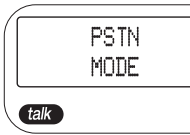
To enter the Program mode, perform the following steps:

- At **Standby**, press and hold the **#**, ***** keys. While holding the **#** and ***** keys, press and hold the **talk** key until a short beep is heard and the handset LCD displays:
 
- Press the **chan** or **vol** keys to switch between and PSTN Analog PBX modes.
- Press the **talk** key to enter your selection into memory. The handset LCD displays: The phone returns to **Standby**.
 

For operation in **PSTN mode**, see page 19. For operation in **PBX mode**, see page 17.

PROGRAMMING XFER IN PBX



Note: Before programming these commands, contact your PBX Administrator to obtain programming codes.

The **XFER** key can be programmed for special use, such as causing a “Hook Flash” followed by a special number or function.

The Hook Flash is used to send a signal to the PBX system to initiate a transfer.

For example – to program the **XFER** key for “Hook Flash” and the **9** key for outside transfers only:

Press and hold **PAUSE** for two seconds.

The talk icon blinks



Press **FLASH/RDL**.



Press **9**.



Press **XFER**.



Press **XFER**.



For the **ANA9620**, the transfer key is operated by the Hook-Flash function. Program your system transfer code with the assistance of the PBX System Administrator.



NOTE

The conference key can be programmed for special use, such as causing a “Hook Flash” followed by a special number or function.

PROGRAMMING CONF IN PBX

Your PBX system’s configuration determines how the conference feature works. Contact your PBX administrator for exact operation details. The example below is just a representation.

For example – to program the **CONF** key for “Hook Flash” :

Press and hold **PAUSE** for two seconds. The **talk** icon blinks.



Press **FLASH/RDL**.



Press **9**.



Press **CONF**.

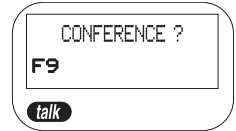

Press **CONF**.



For the **ANA9620**, the conference key is operated by the Hook-Flash function. Program your system conference code with the assistance of the PBX System Administrator.

NOTE

The exact operation of the Feature Buttons depends on how your PBX system is configured. Contact your PBX Administrator for more information.

USING THE FEATURE BUTTONS

▼ *Placing a Call “on Hold”*

Press **HOLD**. You will hear a “beep” and see:

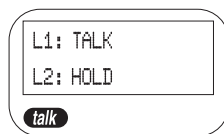

To resume the call, press **L1** or **L2** or **talk**.

▼ *Transferring A Call*

The **XFER** key must be programmed before use. Refer to the “PROGRAMMING XFER IN PBX” section. Press **XFER** (TRANSFER), you will hear a “beep,” and you will see:



Dial the target number.



When the receiving party answers, press **XFER** to complete the transfer.



Note: The transfer feature is not available in PSTN mode.

▼ *Connecting a PBX Conference Call*

Refer to the “PROGRAMMING CONF IN PBX” section.

1. To connect a second party to a call in progress, press **CONF** (CONFERENCE). You will hear a “beep,” and see:



2. Dial the second party’s number.
3. When the other party answers, press **CONF** to have a three-way conversation.



Note: In PBX mode, multiline conferencing is available according to the configuration of the PBX system.

PBX Features

▼ **L1** Key

Press the **L1** key to initiate a call on Line 1.

▼ **L2** Key

Press the **L2** key to initiate a call on Line 2.

▼ **CONF**

In PBX mode, the **CONF** key must first be programmed. Refer to the section entitled “PROGRAMMING CONF IN PBX.”

▼ **XFER**

Press **XFER** (TRANSFER), you will hear a “beep.”

Dial the target number.

When the receiving party answers, press **XFER** to complete call.

Note: This feature is only available in PBX mode.

▼ **HOLD**

Press once, you will hear a “beep” and the call is placed on hold.

Press **L1**, **L2** or **talk** to resume the call.

▼ **PAUSE**

In PBX mode, the **PAUSE** key is used to program the **CONF** and **XFER** feature buttons. Refer to the sections entitled “PROGRAMMING XFER IN PBX” and “PROGRAMMING CONF IN PBX.”

▼ **FLASH/RDL**

Press once to cause a “Hook Flash” while on a call.

In **Standby** mode, you can redial any one of the last three numbers previously dialed.

▼ MUTE

This key turns the handset MIC on or off while in **talk** mode. It toggles between on and off.

▼ vol KEY

This key selects the ringer volume level or tone (or silent alert) during **Standby**, and handset earpiece audio level during a call. The same key also selects the item during programming mode.

▼ chan KEY

The **ANA9620** automatically selects the clearest of three channels during a call for maximum audio quality. But, if you hear static or noise during a call, press **chan** to select a clear channel.

PSTN Features

▼ **L1** Key

Press the **L1** key to initiate a call on Line 1.

▼ **L2** Key

Press the **L2** key to initiate a call on Line 2.

▼ **CONF**

To connect a second party to a call in progress:

1. Press **HOLD**, to place the current call on hold.

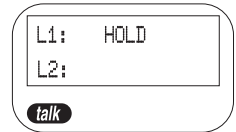

2. Press L2.



3. Dial the other person's number.
4. When the other party answers, press **CONF** to have a three-way conversation.



▼ **XFER**

Note: This feature is not available in PSTN mode.

▼ **HOLD**

Press once, you will hear a "beep" and the call is placed on hold.

Press **L1**, **L2** or **talk** to resume the call.

▼ **PAUSE**

Press once to cause a four second pause while dialing a number.

▼ **FLASH/RDL**

Press once to cause a “Hook Flash” while on a call.

In **Standby** mode, you can redial any one of the last three numbers previously dialed.

▼ **MUTE**

This key turns the handset MIC on or off while in **talk** mode. It toggles between on and off.

▼ **vol Key**

This key selects the ringer volume level or tone (or silent alert) during **Standby**, and handset earpiece audio level during a call. The same key also selects the item during programming mode.

▼ **chan Key**

The **ANA9620** automatically selects the clearest of three channels during a call for maximum audio quality. But, if you hear static or noise during a call, press **chan** to select a clear channel.

OPTIONAL HEAD SET

The optional headset (EXP9530) provides a “Hands-Free” Option for the **ANA9620**. With the headset installed, you can use the belt clip to carry the handset, and conduct a conversation using the headset.

To install the optional headset, open the cover over the headset jack and plug the headset in.

No other settings are needed.

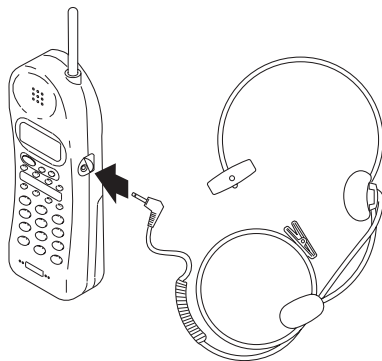

Operation of the **ANA9620** using the headset is exactly the same as using the handset. However, you will hear through the head set earphone, and talk through the headset microphone. The handset earphone and microphone (mouthpiece) are disconnected.

OPTIONAL BACKUP ADAPTER

The optional backup adapter (EXP9505) provides protection against losing a call in case of AC power failure. The backup adapter contains a battery that provides enough power for you to complete the call and hang up.

▼ *To install the backup adapter:*

1. Disconnect the standard AC adapter from the **ANA9620** base.
2. Plug the backup adapter into the EXP9505 jack.
3. Plug the wire from the EXP9505 into the **DC IN** jack of the base.

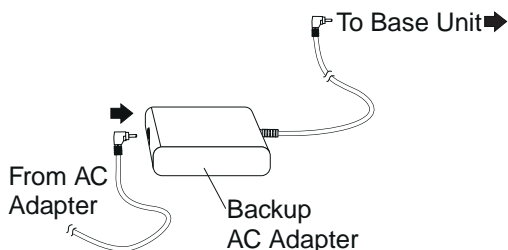

OTHER ACCESSORIES & PARTS

For the following optional accessories and replacement parts contact your PBX Administrator.

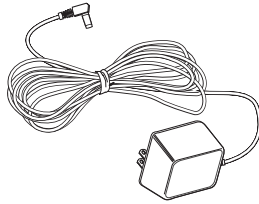

AC Adapter Part # AD9500
for the Base

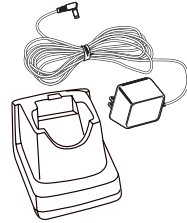

Charger and AC Adapter
EXP9685

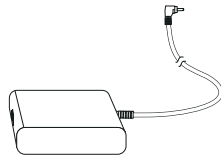

Backup Adapter
EXP9505



500 mAh Battery
BT-9000

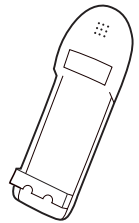

Leather Case
EXP9683



Head Set
EXP9530

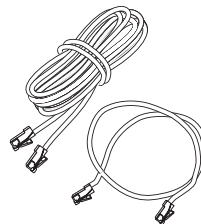

Telephone Cord

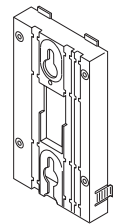

BaseWall Mount
EXP9660



Belt Clip
EXP9602



Belt Clip
EXP9603

- Operating Guide - OMANA9620

If your **ANA9620** Cordless Telephone is not performing to your expectations, try these steps. If you are still unable to resolve the problems, contact your PBX Administrator or the Uniden Technical Support Department.

Note: Do not attempt to service this unit yourself. All service must be done by qualified service personnel.

Problem	Suggestion
Charge light won't come on when handset is placed in charging unit.	<ul style="list-style-type: none"> • Make sure the AC adapter is plugged into the base and wall outlet. • Make sure handset is properly seated in charging unit. • Make sure the sealed lead-acid battery is properly placed in the handset. • Make sure that the charging contacts on the handset and charging unit are clean.
Conversation interrupted frequently.	<ul style="list-style-type: none"> • Make sure that the base antenna is fully vertical. • Move closer to the base. • Check for LOW BATT warning.
Warning tone and NO SERVICE message.	<ul style="list-style-type: none"> • Move closer to the base.
Handset doesn't ring.	<ul style="list-style-type: none"> • Sealed lead-acid battery may be weak. Charge the battery for 5-6 hours. • Make sure the base antenna is fully vertical. • The handset may be too far away from the base. • Ensure the ringer ON/OFF switch is in the ON position.

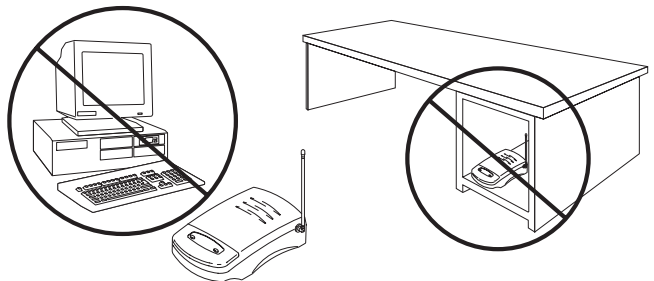

GENERAL

The **ANA9620** complies with FCC parts 15 and 68, and IC standards.

Frequency Control	:Phase Lock Loop
Modulation	:FM
Operating Temperature	: -10° to 50° C

BASE

Receive/Transmit Frequency	:902 MHz to 928 MHz
Power Requirements	:10V DC from supplied AC adapter
Size	:4 1/4 in. W x 7 1/2 in. D x 2 1/4 in. H
Weight	:Approx. 15.4 oz.

HANDSET

Receive/Transmit Frequency	:902 MHz to 928 MHz
Power Requirements	:Rechargeable sealed lead acid battery
Size	:2 1/4 in. W x 1 1/2 in. D x 8 1/2 in. H with antenna
Weight	:Approx. 8.8 oz. with battery
Battery	:Capacity 500 mAh, 4.0V
Talk Mode	:5 hours (typical)
Standby Mode	:40 hours (typical)

Specifications shown are typical and subject to change without notice.

Covered under one or more of the following U.S. patents:
4,511,761, 4,523,058, 4,595,795, 4,597,104, 4,797,916,
4,803,491, 5,157,686, 5,253,268 and other patents pending

UNYL3203000 ©1998 Uniden America Corporation.
Printed in the China All rights reserved.

HANDSET CONTROLS & FUNCTIONS

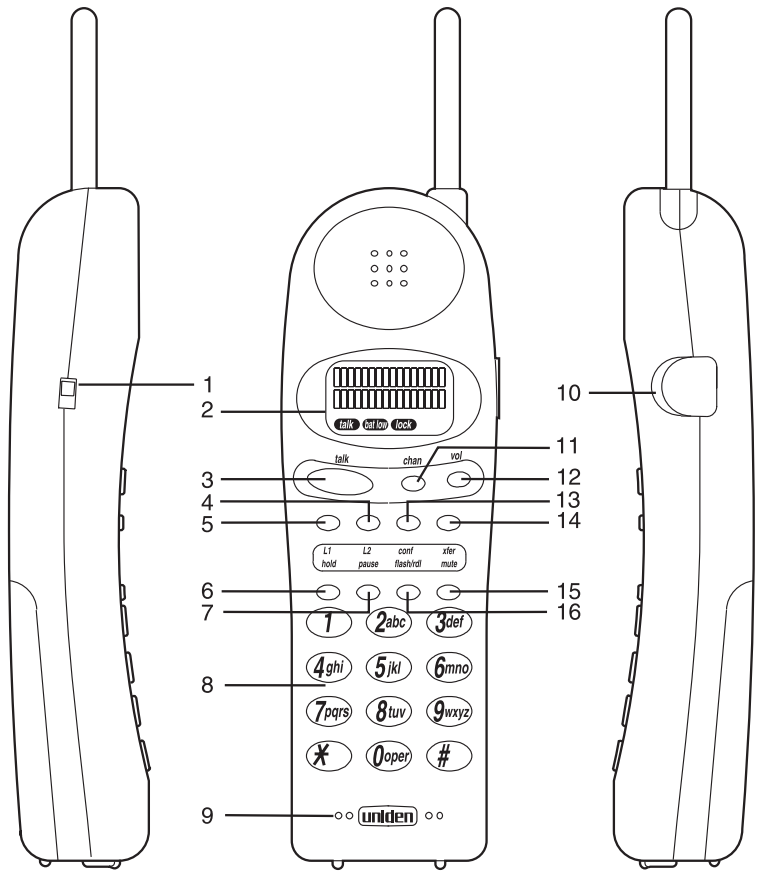

- | | |
|-------------------------------|---|
| 1. Ringer ON/OFF switch | 9. Microphone |
| 2. Message Display | 10. Headset Jack |
| 3. Talk (talk) Key | 11. Channel (chan) Key |
| 4. L2 Key | 12. Volume (vol) Key |
| 5. L1 Key | 13. Conference (CONF) Key |
| 6. Hold (HOLD) Key | 14. Transfer (XFER) Key
(PBX mode only) |
| 7. Pause (PAUSE) Key | 15. Mute (MUTE) Key |
| 8. Numeric Keypad | 16. Flash/Redial (FLASH/RDL) Key |

BASE CONTROLS & FUNCTIONS

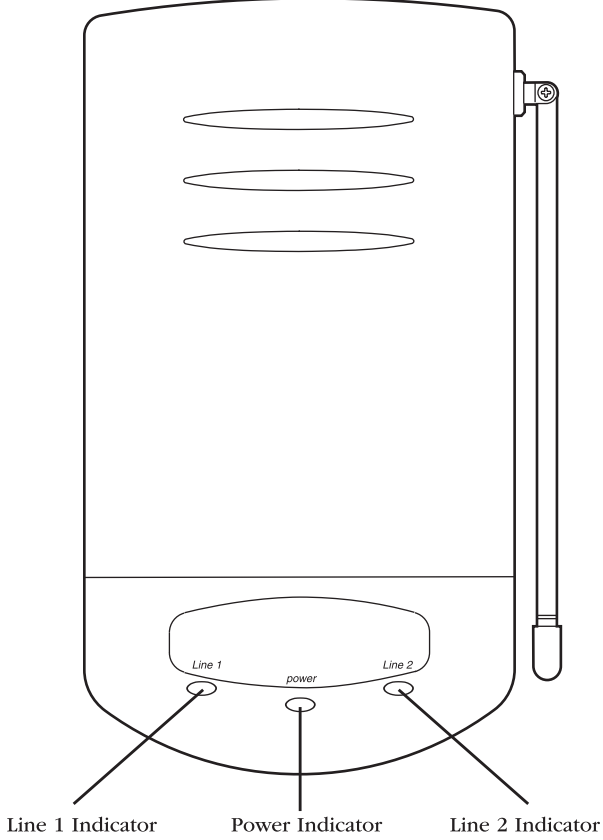

Free Manuals Download Website

<http://myh66.com>

<http://usermanuals.us>

<http://www.somanuals.com>

<http://www.4manuals.cc>

<http://www.manual-lib.com>

<http://www.404manual.com>

<http://www.luxmanual.com>

<http://aubethermostatmanual.com>

Golf course search by state

<http://golfingnear.com>

Email search by domain

<http://emailbydomain.com>

Auto manuals search

<http://auto.somanuals.com>

TV manuals search

<http://tv.somanuals.com>