

DECT2188 Series User's Guide

What's in the box?

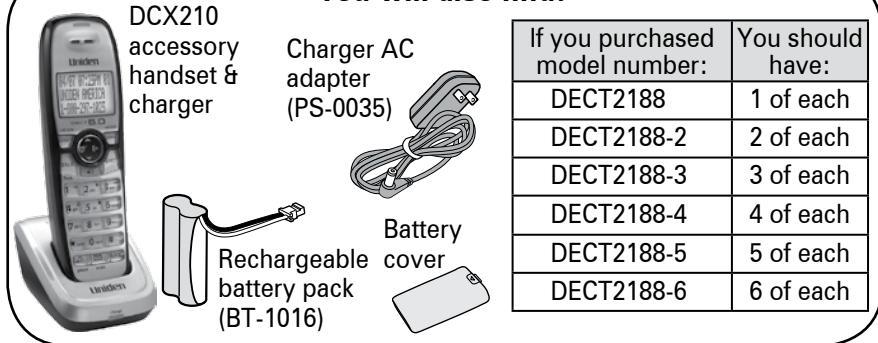

You will also find:



If any items are missing or damaged, contact our Customer Care Line immediately. Never use damaged products!

Need Help? Get answers 24/7 at our website: www.uniden.com.

If You...	Contact Uniden's...	Phone Number
have a question or problem	Customer Care Line*	817-858-2929 or 800-297-1023
need a replacement part or accessory	Parts Department*	800-554-3988
need special assistance due to a disability	Accessibility Help Line	800-874-9314 (voice or TTY)

* During regular business hours, Central Standard Time. Visit our website for detailed business hours.

What's in the manual?

Installing Your Phone	1	Using Call Transfer	18
Set Up the Base	1	Using the Intercom	18
Test the Connection	3	Using Special Features	19
Set Up the Accessory Handset(s) ..	3	Using Your Phone During a	
Changing from Tone to Pulse		Power Failure	19
Dialing	4	Using Do Not Disturb	19
Getting to Know Your Phone	5	Using Call Block	19
Parts of the Base	5	Using Voice Message Notification	20
Parts of the Handset	7	Using the Answering System	21
Reading the Displays	8	Setting Up Your Answering	
Using the Menus	9	System	21
Using the Base Menu	9	Getting Your Messages	22
Using the Handset Menus	10	Screening Your Calls	23
Entering Text on Your Phone	11	Using the System While You're	
Using Your Phone	12	Away from Home	24
Using the Speakerphone	12	Solving Problems	25
Changing the Volume	13	Weak or Hard To Hear Audio	26
Using the Redial List	13	Noise or Static On The Line	27
Using Caller ID and Call Waiting ..	13	Resetting and Registering	
Using Seven-Digit Dialing	14	Handsets	28
Using the Phonebook	15	Handling Liquid Damage	29
Chain Dialing	16	Important Information	30
Finding a Lost Handset	16	Terms Used In This Guide	30
Using Multi-station Features	17	Specifications	30
Expanding Your Phone	17	Battery Information	30
Using Conference Calling	17	Compliance information	31
Using Privacy Mode	17	One-year Limited Warranty	33

Important Safety Instructions!

When using your telephone equipment, basic safety precautions should always be followed to reduce the risk of fire, electric shock and injury to persons, including the following:

- **This unit is NOT waterproof.** DO NOT expose this unit to rain or moisture.
- Do not use this product near water, for example, near a bath tub, wash bowl, kitchen sink or laundry tub, in a wet basement or near a swimming pool.
- Avoid using a telephone (other than a cordless type) during an electrical storm. There may be a remote risk of electric shock from lightning.
- Do not use the telephone to report a gas leak in the vicinity of the leak.
- Use only the power cord and batteries indicated in this manual. Do not dispose of batteries in a fire. They may explode. Check with local codes for possible special disposal instructions.
- Do not place the handset in any charging cradle without the battery installed and the battery cover securely in place.

SAVE THESE INSTRUCTIONS!

Installing Your Phone

Set Up the Base

Attach the stand

Before you attach the stand, you have to decide if you want the phone to rest on a desk or hang on a wall.

For desktop use

1. Turn the stand so the word **DESK** is right-side up (it will be on the right).
2. Insert the tabs into the notches marked **DESK** at the top of the base.
3. Press in on the latch and slip it into the notch.

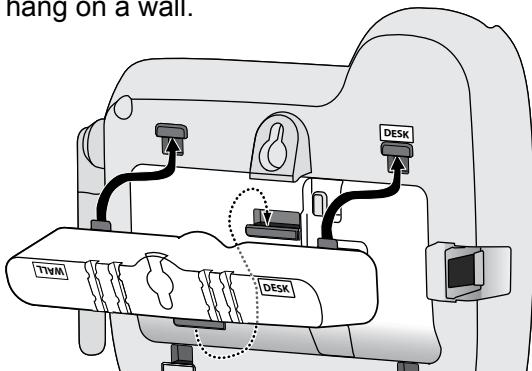

For wall mount use

1. Turn the stand so the word **WALL** is right-side up (it will be on the right).
2. Insert the tabs into the notches marked **WALL** at the bottom of the base.
3. Press in on the latch and slip it into the notch.

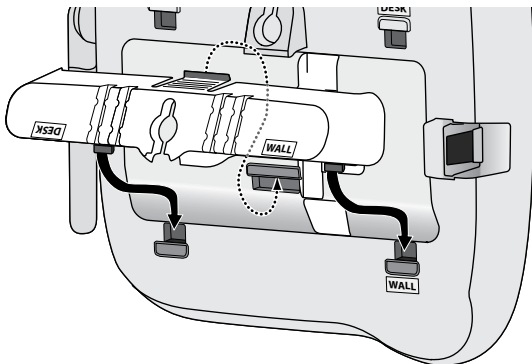

To remove the stand

Press in on the latch and slide it out of the notch.

Connect the corded handset

Use the coiled cord to connect the corded handset to the connector on the left side of the base.

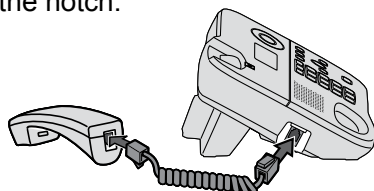

For wall mount use only

1. On the front of the base, pull the clip (that holds the corded handset in place) out of its slot.
2. Rotate the clip 180 degrees.
3. Flip it from front to back and slide it back into the slot.

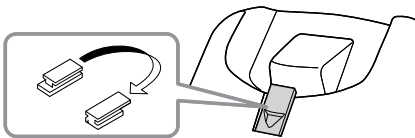

Connect the power and telephone cords

1. Connect the base AC adapter to the **AC IN 7.8V** jack and the telephone cord to the **TEL LINE** jack. Route the cords as shown:

For desktop use

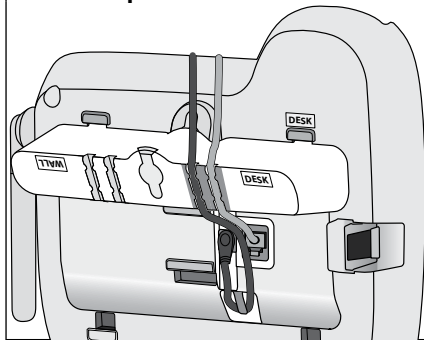

For wall mount use

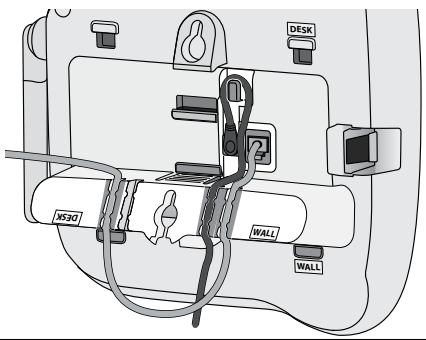

2. Plug the AC adapter into a standard 120 V AC power outlet, and connect the telephone cord to a standard telephone wall jack.

Place the phone on the wall

Place the mounting slots over the pins on the wall plate, and slide the base down to lock it into place.

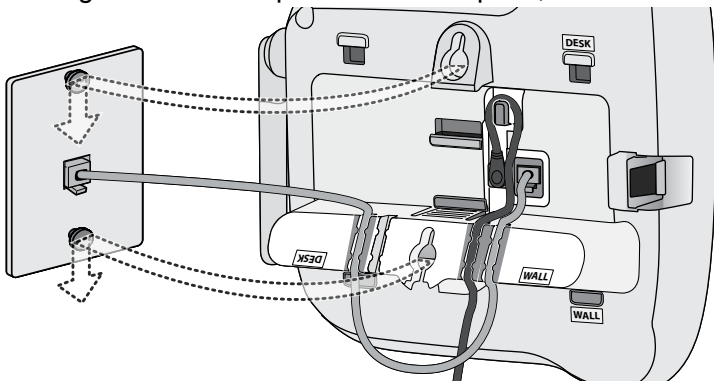

Test the Connection

Pick up the corded handset from the base. You should hear a dial tone and the display on the base should say *Talk*. When you get a dial tone, make a quick test call.

If...	Try...
the display says <i>Check Tel Line</i> or you don't hear a dial tone	checking the connection between the base and the phone jack.
you keep hearing a dial tone	changing to pulse dialing (see page 4).
there's a lot of noise or static	see page 27 for tips on avoiding interference.

Set Up the Accessory Handset(s)

If your phone came packaged with accessory handsets, follow the steps below to get your cordless handsets ready for use.

Install the battery

1. Unpack all handsets, battery packs, and battery covers. If any handset has the battery cover already attached, press in on the notch and slide the cover down and off.
2. Line up the red and black wires on the battery pack with the label inside the handset.
3. Push the battery pack connector in until it clicks into place. Tug gently on the wires to make sure the battery pack is securely connected.

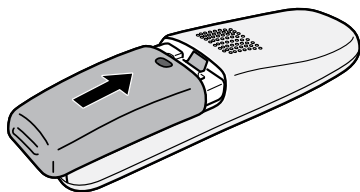
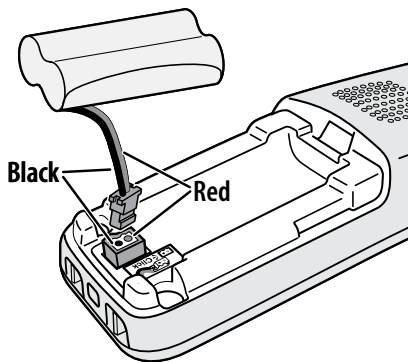
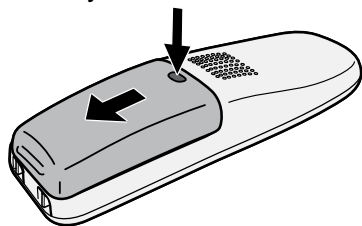

4. Place the cover over the battery compartment and slide it up into place.

Connect the charger

1. Connect a charger AC adapter to each charger's **AC IN 8V** jack and set the plug into the notch as shown. (These adapters might already be connected.)
2. Plug the other end of the adapter into a standard 120V AC power outlet.
3. Place each handset in a charger with the display facing forward. The **CHARGE** light should turn on.

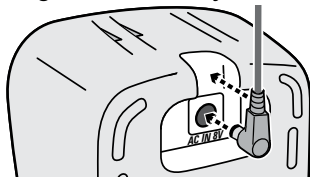

If...	Try...
the CHARGE light doesn't turn on	- reseating the handset. - checking the AC adapter connection. - seeing if the outlet is controlled by a wall switch.

Charge all handsets completely (about 15 hours) before using them.

Test the connection

Pick up each handset and press **TALK**. You should hear a dial tone, and the display should say *Talk*. (Press **END** to hang up.)

If you can't get a dial tone or the handset display says *Unavailable*, try moving the handset closer to the base or resetting it (see page 28).

Changing from Tone to Pulse Dialing

Phones can communicate with the telephone network in two different ways: tone (DTMF) or pulse dialing. If you know your phone company uses pulse dialing or you can't make your test call, follow these steps:

1. With the phone in standby, press **MENU/SELECT** on a cordless handset. (You must use a cordless handset for this procedure.)
2. Use **UP** or **DOWN** to highlight *Global Setup*, then press **MENU/SELECT**.
3. Use **UP** or **DOWN** to highlight *Dial mode*, then press **MENU/SELECT**.
4. Highlight *Pulse*, then press **MENU/SELECT**. The phone sounds a confirmation tone. Try making another test call.

If you use pulse dialing and you need to send DTMF tones during a call (if you're using an automated response system, for example), press ***** to temporarily switch to tone dialing. When the call ends, the phone automatically returns to pulse dialing mode.

Getting to Know Your Phone

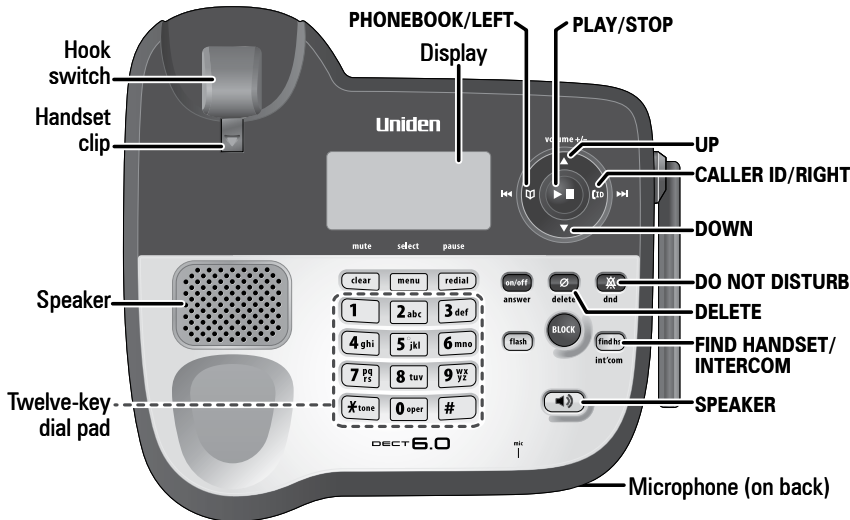

Parts of the Base

If the key name is spelled out on the key itself, it's not labeled in the drawing below.



Base keys and how they work

Key name (and icon)	What it does
CLEAR/MUTE	<ul style="list-style-type: none"> - While this station is ringing: mute the ringer for this call only. - During a call: mute the microphone. - While entering text: delete one character, or press & hold to delete all the characters.
MENU/SELECT	<ul style="list-style-type: none"> - In standby: open the menu. - In the menu or any list: select the highlighted item.
REDIAL/PAUSE	<ul style="list-style-type: none"> - In standby: open the redial list. - While entering a phone number: insert a 2-second pause.
PLAY/STOP (▶■)	<ul style="list-style-type: none"> - In standby: start playing messages. - While a message is playing: stop playing messages. - In the menu or any list: exit the menu completely.

Key name (and icon)	What it does
PHONEBOOK/ LEFT 	<ul style="list-style-type: none"> - In standby or during a call: open the phonebook. - In any menu or list: go up one level. (If you are already at the top level, the phone exits the menu and returns to the previous operation.) - During text entry: move the cursor to the left. - In the first 2 seconds of a message: go to the previous message. - Anytime after that: go to the beginning of this message.
CALLER ID/ RIGHT 	<ul style="list-style-type: none"> - In standby or during a call: open the Caller ID list. - During text entry: move the cursor to the right. - While a message is playing: skip to the next message.
UP (▲)	<ul style="list-style-type: none"> - In standby: increase the ringer volume. - During a normal call: increase the earpiece volume. - During a speakerphone call or while a message is playing: increase the speaker volume. - In the menu or any list: move the cursor up one line.
DOWN (▼)	<ul style="list-style-type: none"> - In standby: decrease the ringer volume. - During a normal call: decrease the earpiece volume. - During a speakerphone call or while a message is playing: decrease the speaker volume. - In the menu or any list: move the cursor down one line.
ON/OFF	<ul style="list-style-type: none"> - In standby: turn the answering system on or off.
DELETE (Ø)	<ul style="list-style-type: none"> - While a message is playing: delete this message. - In standby: delete all messages.
DO NOT DISTURB (X)	<ul style="list-style-type: none"> - In standby: turn the Do Not Disturb feature on or off (see page 19).
FLASH	<ul style="list-style-type: none"> - During a call: switch to a waiting call.
BLOCK	<ul style="list-style-type: none"> - While the phone is ringing: add the incoming caller ID to the call block list (block the call).
FIND HANDSET/ INTERCOM	<ul style="list-style-type: none"> - In standby: page a handset using the intercom. - During a call: put the call on hold & start a call transfer.
SPEAKER 	<ul style="list-style-type: none"> - In standby: start a speakerphone call (get a dial tone). - During a normal call: switch to the speakerphone. - During a speakerphone call: hang up.

Parts of the Handset

If the key name is spelled out on the key itself, it's not labeled in the drawing to the right.

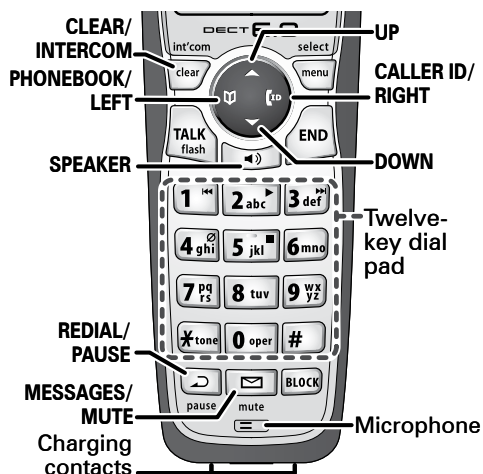

Handset keys and how they work

Key name (and icon)	What it does
UP (▲)	<ul style="list-style-type: none"> - In standby: increase the ringer volume. - During a call: increase the call volume. - In the menu or any list: move the cursor up one line.
CALLER ID/RIGHT (ID)	<ul style="list-style-type: none"> - In standby or during a call: open the Caller ID list. - During text entry: move the cursor to the right.
DOWN (▼)	<ul style="list-style-type: none"> - In standby: decrease the ringer volume. - During a call: decrease the call volume. - In the menu or any list: move the cursor down one line.
MENU/SELECT	<ul style="list-style-type: none"> - In standby: open the menu. - In the menu or any list: select the highlighted item.
END	<ul style="list-style-type: none"> - During a call: hang up. - In the menu or any list: exit & go to standby.
CLEAR/INTERCOM	<ul style="list-style-type: none"> - In standby: page another station using the intercom. - During a call: put the call on hold & start a call transfer. - While entering text: delete one character, or press & hold to delete all the characters.
PHONEBOOK/LEFT (M)	<ul style="list-style-type: none"> - In standby or during a call: open the phonebook. - In the menu: go back to the previous screen. - During text entry: move the cursor to the left.
TALK/FLASH	<ul style="list-style-type: none"> - In standby: start a telephone call (get a dial tone). - During a call: switch to a waiting call.

Key name (and icon)	What it does
SPEAKER (🔊)	- Switch a normal call to the speakerphone (& back).
REDIAL/PAUSE (↶)	- In standby: open the redial list. - While entering a phone number: insert a 2-second pause.
BLOCK	- While the phone is ringing: add the incoming Caller ID information to the call block list (block the call).
MESSAGES/MUTE (✉)	- In standby: access your answering system. - During a call: mute the microphone. - While the phone is ringing: mute the ringer for this call only.

Reading the Displays

On the base

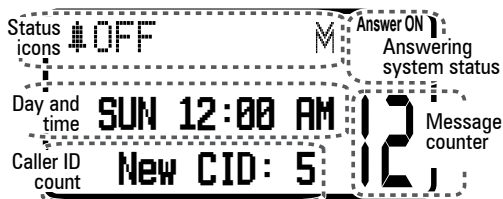

On the handset

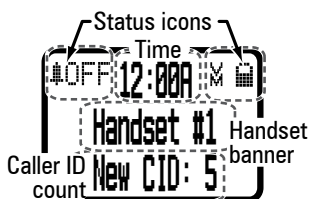

The table below shows the possible icons and what they mean. Since the icons appear based on what you're doing with the phone, you won't ever see all of these icons at the same time.

Icon	What it means
🔊/OFF	The ringer is turned off: this station will not ring when a call comes in.
M	You have a voice message waiting (see the section titled "Using Voice Message Notification" on page 20).
P	Privacy Mode is on: no other station can join your call.
🔊	The speakerphone is on.
🔇	The microphone is muted, & the caller can't hear you.
T	(Handset only) T-coil mode is on. (See "Do you use a T-coil hearing aid?" on page 27.)
🔋	(Handset only) The battery is 1) fully charged, 2) half charged, 3) getting low, or 4) empty.

Using the Menus

The menus are designed to be as easy as possible. Some users don't even need the manual once they know how to perform these actions:

Open the menu	Press MENU/SELECT .
Move the cursor	The arrow cursor on the left side of the line shows which menu item is currently highlighted. Use UP to move the cursor up & DOWN to move it down.
Select an option	Move the cursor to highlight the option, then press MENU/SELECT .
Go up one screen	Press PHONEBOOK/LEFT .
Close the menu	On the handset, press END ; on the base, press PLAY/STOP . (If you open the menu during a call, use PHONEBOOK/LEFT to back out of the menu without hanging up.)

If you don't press any keys for thirty seconds, the phone times out and exits the menu. (When setting the day and time, the time-out period is extended to two minutes.)

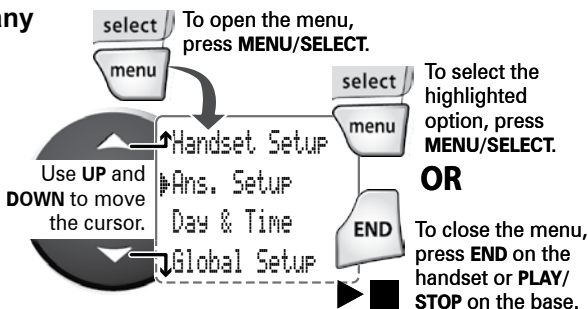

Using the Base Menu

You have the following options from the base:

<i>VMWI Reset</i>	Reset the voice message waiting indicator to bring it back into sync with your voice mail service (see p. 20).
<i>Call Blocking</i>	Block unwanted calls from up to 20 phone numbers and manage your call block list (see p. 19).
<i>Base Language</i>	Change the display language.
<i>Register Handset</i>	Register additional handsets to the base or re-register a handset that you had to reset for some reason (see "Resetting and Registering Handsets" on page 28).

Using the Handset Menus

Handset Setup

You can change these settings separately for each cordless handset.

<i>T-coil</i>	Turn on T-coil mode to reduce noise on some hearing aids (see "Do you use a T-coil hearing aid?" on p. 27).
<i>Ringer Tones</i>	Choose one of four melodies or three tones for the handset's main ring tone. As you highlight each ring tone, the phone plays a sample of the tone. When you hear the tone you want, press MENU/SELECT .
<i>Personal Ring</i>	Turn on the personal ring feature. If you have Caller ID, this feature lets you assign special ring tones to anyone in your phonebook: this handset will use the special ring tone when that person calls.
<i>Autotalk</i>	Turn on Auto Talk so you can answer the phone just by picking up the handset from the cradle (without having to press any buttons).
<i>Any Key Answer</i>	Turn on Any Key Answer so you can answer the phone by pressing a key on the twelve-key dial pad.
<i>Banner</i>	Change the name used on the handset's display.
<i>Handset Language</i>	Change the display language.
<i>Key Touch Tone</i>	Have the keypad sound a tone when you press a key.

Ans. Setup

This menu controls the options and settings for your answering system (see "Ans. Setup menu options" on page 21).

Day & Time

You need to set the day & time so messages get the right time stamp.

1. Use **UP & DOWN** to choose the day of the week; press **MENU/SELECT**.
2. Use the number keypad to enter the hour and minutes.
3. Use **UP & DOWN** to select *AM* or *PM*; press **MENU/SELECT**.

Global Setup

The settings on this menu apply to all cordless handsets and the base. Before changing these settings, make sure the phone is in standby and all handsets are within range of the base. (Only one handset at a time can change these settings.)

<i>Area Code</i>	Enter your area code so the phone hides the area code on incoming local calls (see "Using Seven-digit Dialing" on p. 14).
<i>Dial Mode</i>	Change the way your phone communicates with the telephone network (see "Changing from Tone to Pulse Dialing" on p. 4).
<i>Set Line Mode</i>	Do not change this setting unless instructed to by customer service.

Call Blocking

This menu lets you block unwanted calls from up to 20 phone numbers and manage your call block list (see p. 19).

Entering Text on Your Phone

When you want to enter text into your phone (for example, a name in the phonebook), use the twelve-key dial pad to enter the letters printed on the number keys. Here's how it works:

- ◆ The phone enters the letters in the order they appear on the key. For example, if you press the number key 2 once, the phone enters the letter *A*. Press 2 twice for *B*, and three times for *C*.
- ◆ If you press the key again after the last letter, the phone starts the same letter sequence with small letters. If you press 2 four times in a row, the phone enters *a* (small letter). Press 2 five times for *b*, and six times for *c*.
- ◆ If you see the icon [*Aa*] in the display, the phone enters capital letters first (*A B C*), then small letters (*a b c*), then the number on the key (2). The icon [*aA*] means the phone starts at the small letters, so it enters small letters first, then the number on the key, then capital letters.
- ◆ The phone automatically uses a capital letter for the first letter and any letter right after a space; all other times, it uses small letters.
- ◆ If two letters in a row use the same number key, enter the first letter, then use **CALLER ID/RIGHT** to move the cursor to the next position to enter the second letter.

Switch between capital & small letters	Press * .
Move the cursor	Press PHONEBOOK/LEFT to move the cursor to the left or CALLER ID/RIGHT to move the cursor to the right.
Leave a blank space	Press POUND (#) .

Erase one letter	Move the cursor to the letter you want to erase and press CLEAR (CLEAR/INTERCOM on the handset; CLEAR/MUTE on the base).
Erase the entire entry	Press & hold CLEAR .
Enter punctuation or a symbol	Press 0 to rotate through the available symbols.

Using Your Phone

To...	From the base	From a cordless handset
make a call	Dial the number, then pick up the corded handset.	Dial the number, then press TALK/FLASH .
answer a call	Pick up the corded handset.	Press TALK/FLASH .
hang up	Return the handset to the cradle.	Press END or return the handset to the cradle.
mute the microphone during a call	Press CLEAR/MUTE . Press again to turn the microphone back on.	Press MESSAGES/MUTE . Press again to turn the microphone back on.
put a call on hold	Press FIND HANDSET/INTERCOM . If the call is on hold for 5 minutes, it will be disconnected.	Press CLEAR/INTERCOM .
return to a call on hold	Pick up the handset or press SPEAKER .	Press TALK/FLASH .
mute the ringer for this call only	While the phone is ringing, press CLEAR/MUTE .	While the phone is ringing, press MESSAGES/MUTE .

Using the Speakerphone

Both the handset and the base have a speakerphone. To use the base speaker, press **SPEAKER** instead of using the corded handset. To use the handset speaker, press **SPEAKER** instead of **TALK/FLASH**.

To...	From the base	From a handset
make a call: Dial the number, then	Press SPEAKER .	Press SPEAKER .
answer a call	Press SPEAKER .	Press SPEAKER .
switch a call to the speakerphone	Press SPEAKER .	Press SPEAKER .
switch back to the earpiece	Pick up the corded handset.	Press SPEAKER .
hang up a speakerphone call	Press SPEAKER .	Press END .

Changing the Volume

You can set the volume of the ringer, the earpiece, and the speakerphone separately for the base and each cordless handset. For each item, press **UP** to make it louder or **DOWN** to make it softer. The available volume levels and how change them are listed below:

Change the	When	On the base	On a handset
ringer volume	the phone is in standby	select <i>Off, Low, Medium, or High</i>	select <i>Off, Low, Medium, or High</i>
earpiece volume	you are on a normal call	choose one of 6 volume levels	choose one of 6 volume levels
speaker volume	you use the speakerphone for a call or getting messages	choose one of 10 volume levels	choose one of 6 volume levels

Using the Redial List

The phone saves the last 5 numbers you dial on each station. To open the redial list, press **REDIAL/PAUSE**; use **UP** and **DOWN** to scroll through the list. To close the list, press **PHONEBOOK/LEFT**. With the phone in standby, open the list and find the number you want. Then:

to redial the selected number	On the handset, press TALK/FLASH ; on the base, pick up the corded handset.
to delete the number	Press MENU/SELECT & select <i>Delete Entry</i> .
to save it to the phonebook	Press MENU/SELECT & select <i>Store Into Pb</i> .

Using Caller ID and Call Waiting

You have to subscribe to Caller ID, Call Waiting, and Caller ID on Call Waiting services to use the features described in this section: contact your telephone provider for more information.

When a call comes in, the phone displays the caller's number and name (if available). The phone saves the information for the last 30 received calls to the *CID list*. When it's in standby, the phone displays how many calls came in since the last time you checked the CID list.

Open the CID list	Press CALLER ID/RIGHT .
Scroll through the CID list	Press DOWN to scroll through the list from newest to oldest. Press UP to scroll from oldest to newest.
Close the CID list	Press PHONEBOOK/LEFT .

Dialing from the Caller ID list

1. Find the entry you want to dial.
2. If the number is a toll or long distance call, but there's no 1 at the front of the CID record, press * to add the 1.
3. On the handset, press TALK/FLASH to dial the number. On the base, pick up the corded handset.

(You can also press TALK/FLASH or pick up the corded handset before opening the CID list. Find the number you want to dial, then press MENU/SELECT.)

Caller ID menu options

With the phone in standby, open the CID list and find the number you want. Press MENU/SELECT to open the Caller ID menu; choose one of these options:

<i>Delete Entry</i>	Erase this Caller ID number.
<i>Store Into Pb</i>	Add this number to this station's phonebook. The phone prompts you to enter a name & edit the number; cordless handsets also prompt you to choose a personal ring.
<i>Delete All</i>	Erase this station's CID list. (This does not affect the CID lists saved on any other stations.)
<i>Add Call Block</i>	(Handset only) Add this number to your call block list (see page 19).

Using Call Waiting

If you get a Call Waiting call, the phone sounds a tone and displays any CID information received for the waiting call. Press FLASH (TALK/FLASH on a handset) to switch between your current call and the waiting call; remember, each time you switch, there is a short pause before you're connected to the other caller.

Using Seven-Digit Dialing

If you can make a local call by dialing only seven digits instead of ten, you can tell the phone to hide your local area code in the CID list.

Do not enter an area code if your phone company requires ten-digit dialing. You might not be able to dial from the CID list.

1. With the phone in standby, open the menu and select *Global Setup*, then select *Area Code*.
2. Use the number keypad (0-9) to enter your three-digit area code.
3. Press **MENU/SELECT** when you're finished.
 - ◆ The phone uses the programmed code as a filter. When calls come in, the phone compares the area code to the programmed one. If they match, the phone hides the area code in the CID list.
 - ◆ While reviewing the list, press **#** to toggle the area code off & on.

Using the Phonebook

Each station can store up to 70 entries in its phonebook.

Open/close the phonebook	Press PHONEBOOK .
Scroll through the entries	Press DOWN to scroll through the phonebook from A to Z or UP to scroll from Z to A.
Jump to entries that start with a certain letter	Press the number key corresponding to the letter you want to jump to.
Dial an entry	<ol style="list-style-type: none"> 1. Find the entry you want to dial. 2. On a handset, press TALK/FLASH. On the base, pick up the corded handset.

Phonebook menu options

Open the phonebook with the phone in standby, then press **MENU/SELECT** to open the phonebook menu. Choose one of these options:

<i>Create New</i>	Add an entry to your phonebook. The phone will prompt you to enter the name & phone number. (Cordless handsets will also prompt you to choose a personal ring.)
<i>Copy All</i>	Copy the whole phonebook to another station. (You must have at least one accessory handset to use this multi-station feature.)
<i>Delete All</i>	Erase all the entries in this station's phonebook. (This does not affect the entries saved on any other stations.)

Phonebook entry options

With the phone in standby, open the phonebook and find the entry you want. Press **MENU/SELECT** to open the individual phonebook entry menu. Choose one of these options:

<i>Edit</i>	Edit this entry. The phone will prompt you to enter the name & phone number. (Cordless handsets will also prompt you to choose a personal ring.)
<i>Copy</i>	Copy this entry to another station. (You must have at least one accessory handset to use this multi-station feature.)
<i>Delete</i>	Erase this entry.

Chain Dialing

- ◆ If you often have to enter a series of digits or a code number during a call, you can save that code number to a phonebook entry and use the phonebook to send the code number.
- ◆ Enter the code number (up to 20 digits) into the phonebook just like a regular phonebook entry. Be sure to enter the code number into the phonebook exactly as you would enter it during a call.
- ◆ When you hear the prompt that tells you to enter the number, open the phonebook and find the entry that contains your code number. Press **MENU/SELECT** to transmit the code. The phone transmits the code number exactly as you entered it in the phonebook. Or, if you change your mind, use **PHONEBOOK/LEFT** to close the phonebook.

Finding a Lost Handset

With the phone in standby, press **FIND HANDSET/INTERCOM** on the base. Select the handset you want to find, or select *All* to page all handsets at the same time. The paged handset(s) will beep for 1 minute or until you press **FIND HANDSET/INTERCOM** again or press **TALK/FLASH** followed by **END** on the handset.

Using Multi-station Features

The expandable base works together with the accessory handsets to give you some useful multi-station features. (A station can be any cordless handset or the base.) You must have at least one accessory handset to use the features in this section.

Expanding Your Phone

- ◆ Your base supports a total of six DCX210 accessory handsets, including any that were supplied with your phone.
- ◆ Your base might be compatible with other Uniden accessory handsets: please visit our website for a list of compatible handsets.
- ◆ Accessory handsets must be registered to the base before you can use them. Handsets that aren't registered display a *Handset not registered* message. For instructions on registering handsets to this base, see page 28 or the manual for the accessory handset.
- ◆ Any accessory handsets that came packaged with the base are already registered to that base for you.
- ◆ If a handset was previously registered to a base, you have to reset it so you can register it to a new base (see page 28 for DCX210).

Using Conference Calling

When an outside call comes in, the base and two cordless handsets can join in a conference call with the outside caller. To join the call, just pick up the base corded handset or press **TALK/FLASH** on a cordless handset. To leave the conference call, hang up normally; the other station remains connected to the call. (You can also use the speakerphone for a conference call, just like you can with a normal call.)

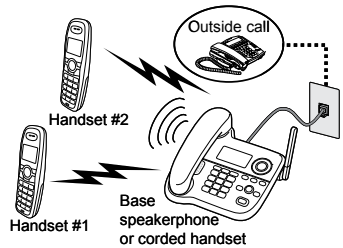

Using Privacy Mode

You can prevent other stations from joining a call. Start your call as usual, then press **MENU/SELECT**: the display shows *Call Privacy*. Press **MENU/SELECT** again to turn privacy mode on (you'll see a  in the display). When you hang up, privacy mode turns off automatically. As long as you have privacy mode on, no other stations can interrupt your call. To allow another station to join the call, just turn privacy mode off by repeating the process above (press **MENU/SELECT** twice).

Using Call Transfer

To...	From the base	From a cordless handset
transfer a call	<ol style="list-style-type: none"> 1. Press FIND HANDSET/INTERCOM to put the call on hold. 2. Select the station you want to transfer the call to, or select <i>A//</i> to page all the stations at the same time. <p>When the other station accepts the call, you'll be disconnected, but you can join the call again.</p>	1. Press CLEAR/INTERCOM to put the call on hold.
cancel a transfer	Press SPEAKER to return to the call.	Press TALK/FLASH to return to the call.
accept a transferred call	<ol style="list-style-type: none"> 1. To answer the page & speak to the transferring station, pick up the corded handset. 2. To accept the call, press SPEAKER. 	<p>press CLEAR/INTERCOM.</p> <p>press TALK/FLASH.</p>

Using the Intercom

Here are some things you need to know about using the intercom:

- ◆ Whenever the phone is in standby, you can make an intercom call between stations without using the phone line.
- ◆ You can make an intercom call from any station, but only two stations can be in an intercom call at any time.
- ◆ If an outside call comes in during an intercom call, the phone shows the CID information. If the other station hasn't answered the page, the phone cancels the page so you can answer the incoming call.

To...	From the base	From a cordless handset
make an intercom page	<ol style="list-style-type: none"> 1. Press FIND HANDSET/INTERCOM. 2. Select the station you want to talk with, or select <i>A//</i> to page all the stations at the same time. 	1. Press CLEAR/INTERCOM .
cancel a page	Press FIND HANDSET/INTERCOM .	Press END .
answer an intercom page	Press FIND HANDSET/INTERCOM or pick up the corded handset.	Press CLEAR/INTERCOM or TALK/FLASH .
leave an intercom call	Press FIND HANDSET/INTERCOM .	Press END .
answer an outside call during an intercom call	Press SPEAKER .	Press TALK/FLASH .

Using Special Features

Using Your Phone During a Power Failure

Because it includes a corded handset, your phone can perform several of its functions during a power failure. The following features will operate during a power failure (all other features are disabled):

- ◆ Making and receiving calls with the base corded handset.
- ◆ Changing the volume on the corded handset.
- ◆ Using Call Waiting on a base corded handset call.
- ◆ Entering pauses when dialing from the base corded handset.

While the power is out, the base uses a special ringer; you cannot adjust the volume of this ringer.

Using Do Not Disturb

- ◆ The *Do Not Disturb* or *DND* feature turns off the ringers of the base and all handsets at the same time.
- ◆ With the phone in standby, press and hold **DO NOT DISTURB** on the base. The phone automatically turns on the answering system and shows *Do Not Disturb* in the display on all stations.
- ◆ To cancel, press **DO NOT DISTURB** again.

If you turn the answering system off while DND is on, the phone turns off DND along with the answering system.

Using Call Block

If you subscribe to Caller ID, you can save phone numbers to the call block list. When a call comes in, the phone compares the received phone number to the numbers on the call block list. If the phone number is on the list, the phone replaces the caller's name with *Call Blocked* and disconnects the call. (The caller hears a reject tone.)

The call block list holds 20 entries, and all stations share the same list. You can add entries through the *Call Blocking* menu, by selecting *Add Call Block* in the CID menu, or by blocking incoming calls. (Only one station can edit the call block list at a time.)

Blocking incoming calls

When the phone rings, wait until the display shows the Caller ID information (usually after the second ring). If you want to block the

call and add this number to the call block list, press **BLOCK**. When the phone asks you to confirm, press **MENU/SELECT** or **BLOCK**.

Blocking an incoming call from an "Unknown" or "Private" number is the same as selecting *Unknown Number* or *Private Number* from the Call Blocking menu.

Call Blocking menu options

With the phone in standby, open the menu and select *Call Blocking*. Choose one of these options:

<i>View Number</i>	See the numbers on your call block list.
<i>Create New</i>	(Handset only) Add an entry to your call block list. The phone will prompt you to enter a name & phone number.
<i>Private Number</i>	(Handset only) Block all calls from numbers reported by CID as "Private." (This does not count as one of the 20 entries.)
<i>Unknown Number</i>	(Handset only) Block all calls from numbers reported by CID as "Unknown". (This does not count as one of the 20 entries.)

Call block entry options

With the phone in standby, open the call block list and find the entry you want. Press **MENU/SELECT** to open the individual entry menu. Choose one of these options:

<i>Edit</i>	(Handset only) Edit this entry. The phone will prompt you to edit the name & phone number.
<i>Delete</i>	Erase this entry from the list & allow calls from this number.

Using Voice Message Notification

This feature supports Frequency-Shift Keying (FSK) message notification. Contact your voice mail provider for more details.

If you subscribe to a voice mail service, your phone can notify you when you have a new message waiting. When you have new messages, the voice message icon (📞) appears in the display, and the new message light (at the top of the handset) blinks.



Resetting the voice message indicator

If the voice message icon remains after you check your messages, you can reset it. From the base, open the menu and select *VMWI Reset*. Select **Yes** to reset the indicator.

Using the Answering System

Setting Up Your Answering System

You can set up your answering system from any handset.

To...	Follow these steps
Record your personal outgoing message or greeting	<p>Your greeting can be between 2 seconds and 30 seconds long. If you don't record an outgoing message, the system uses a pre-recorded greeting: <i>Hello, no one is available to take your call. Please leave a message after the tone.</i></p> <ol style="list-style-type: none">1. Press MESSAGES/MUTE to access the answering system. Wait until the system finishes its announcements, or press 5 (STOP) to skip them.2. Press 8.3. Wait for the system to say "Record greeting," then begin speaking.4. When you're finished, press 8 to stop recording. The system plays back your new greeting.5. To keep this greeting, press END. To re-record it, go back to step 2.
Switch between the pre-recorded greeting & your own greeting	<ol style="list-style-type: none">1. Press MESSAGES/MUTE to access the answering system. Wait until the system finishes its announcements, or press 5 (STOP) to skip them.2. Press 6. The system plays back the greeting it is currently using.3. Press 6 again to switch greetings.
Delete your greeting	<ol style="list-style-type: none">1. Switch to your personal greeting following the steps above.2. While the system is playing back your greeting, press 4.

Ans. Setup menu options

You can change the answering system options from any handset. Just open the menu and select **Ans. Setup**.

Security Code	Enter a 2-digit PIN so you can access your answering system from any touch-tone phone (see page 24).
Ring Time	Set the number of rings (2 , 4 , or 6) before the answering system answers the phone. Choose Toll Saver (TS) to have the system pick up after 2 rings if you have new messages or after 4 rings if you don't.

<i>Record Time</i>	Set the amount of time callers have to leave a message, either 1 minute or 4 minutes. Choose <i>Announce Only</i> if you don't want the system to let callers to leave a message.
<i>Message Alert</i>	Have the system beep every 15 seconds when you have a new message; the beeping stops when you listen to all your new messages. (To mute the alert without listening to your messages, press any key on the base.)
<i>Ans. Language</i>	Change the language of the system's voice prompts.
<i>Call Screen</i>	Turn on the call screen feature so you can hear callers as they leave messages on the base speaker (see page 23).
<i>Ans. On/off</i>	Turn your answering system on or off. (To turn your system on or off from the base, just press ON/OFF.)

Getting Your Messages

Accessing your answering system from a handset

You can access your system from a handset whenever the phone is in standby.

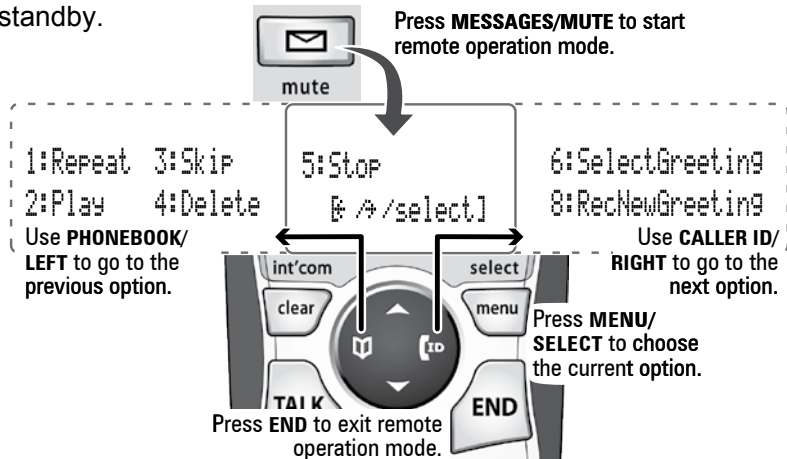

- ◆ During remote operation, the phone beeps to let you know it's waiting for your next command.
- ◆ You can press the number key next to the commands instead of scrolling through them.
- ◆ If you don't press any keys for 30 seconds, the phone returns to standby.
- ◆ Only one handset can access the system at a time.

How to operate your answering system

To...	From the base	From a handset (remote operation)
play new messages	Press PLAY/STOP The system announces the number of new & old messages, then plays the first new message followed by the day & time it was received. Then the system plays the new messages in the order they were received.	Press MESSAGES/MUTE .
restart the current message	Press PHONEBOOK/LEFT .	Press 1 or select <i>1:Repeat</i> .
replay previous messages	Press PHONEBOOK/LEFT repeatedly until you hear the message you want to replay.	Press 1 or select <i>1:Repeat</i> repeatedly until you hear the message you want to replay.
skip a message	Press CALLER ID/RIGHT .	Press 3 or select <i>3:Skip</i> .
delete a message	While the message is playing, press DELETE .	While the message is playing, press 4 or select <i>4>Delete</i> .
delete all of your messages	With the phone in standby, press DELETE . When the system asks you to confirm, press DELETE again.	Not available.
play old messages	After the system plays the new messages, press PLAY/STOP again.	press 2 or select <i>2:Play</i> .
end the operation	Press PLAY/STOP .	Press END .

Screening Your Calls

Another feature your answering system gives you is *call screening*. While the system is taking a message, you can hear the caller on the base speaker (if you turn on *Call Screen*) or from a handset.

To...	From the base	From a handset
hear the caller leaving a message	Just listen to the caller over the speaker.	Press MESSAGES/MUTE .
answer the call	Pick up the corded handset.	Press TALK/FLASH .
mute the call screen without answering	Press CLEAR/MUTE .	Press END or return the handset to the cradle.

- ◆ If you mute the call screen, the system continues taking the message: it just stops playing through the speaker.
- ◆ Only one handset at a time can screen calls. If another handset is screening the call, the handset beeps and returns to standby.

Using the System While You're Away from Home

You can also operate your answering system from any touch-tone phone. Before you can use this feature, you have to program a security code.

Programming a security code

1. With the phone in standby, open the menu from any handset.
2. Select *Ans. Setup*, then select *Security Code*.
3. Use the number keypad to enter a two-digit security code (01 to 99). Press MENU/SELECT when you're finished.

Remember to make a note of your new security code!

Dialing in to your system

1. Call your telephone number and wait for the system to answer. (If your answering system is off, it will answer after about ten rings and sound a series of beeps instead of your greeting.)
2. During the greeting (or beeps), press 0 and **immediately** enter your security code. (You have 3 tries to enter you security code: if you enter it wrong 3 times, the system hangs up and returns to standby.)
3. The system announces the current time, the number of messages stored in memory, and a help prompt. Then it starts beeping intermittently to let you know it's waiting for your command.
4. When you hear the intermittent beeping, enter a command from the chart to the right.

If you don't press any keys for 15 seconds, the phone will hang up and return to standby.

0-1	Repeat message
0-2	Play message
0-3	Skip message
0-4	Delete message
0-5	Stop playback
0-6	Turn the system on
0-9	Turn the system off
1-0	Hear help prompts

Solving Problems

If you have any trouble with your phone, try these simple steps first. If you still have a question, call our Customer Care Line listed on the front cover.

If...	Try...
No stations can make or receive calls.	<ul style="list-style-type: none">- Checking the telephone cord connection.- Disconnecting the base AC adapter. Wait a few minutes, then reconnect it.
One cordless handset can't make or receive calls.	<ul style="list-style-type: none">- Moving the handset closer to the base.- Resetting the handset.
A station can make calls, but it won't ring.	<ul style="list-style-type: none">- Making sure the ringer is turned on.- Making sure Do Not Disturb is turned off.
I can't make or receive calls while the power is out.	<ul style="list-style-type: none">- Making sure you using the corded handset on the base.- Checking the telephone cord connection.
A cordless handset's display won't turn on.	<ul style="list-style-type: none">- Charging the battery for 15-20 hours.- Checking the battery pack connection.
A cordless handset is not working.	<ul style="list-style-type: none">- Charging the battery for 15-20 hours.- Checking the battery pack connection.- Resetting the handset.
A cordless handset says <i>Unavailable</i> .	<ul style="list-style-type: none">- Moving the handset closer to the base.- Seeing if another station has Privacy Mode on.- Making sure the base is plugged in.
No stations will display any Caller ID information.	<ul style="list-style-type: none">- Letting calls ring at least twice before answering.- Seeing if the call was placed through a switchboard.- Checking with your telephone service provider to make sure your Caller ID service is active.
I can't dial from the Caller ID list.	<ul style="list-style-type: none">- Making sure you entered the correct area code. If you have to dial all 10 digits, you need to delete the area code (see Seven-digit Dialing on page 14).
Caller ID displays briefly & then clears.	<ul style="list-style-type: none">- You may have to change the line mode. Contact customer service for more information.
I can't transfer calls.	<ul style="list-style-type: none">- Resetting all the handsets.
I can't get two cordless handsets to talk to the caller.	<ul style="list-style-type: none">- Making sure both handsets are registered to this base.- Making sure no station is in Privacy Mode.

If...	Try...
The phone keeps ringing if I answer on an extension.	- You may have to change the line mode. Contact customer service for more information.
The answering system does not work.	- Making sure the answering system is turned on. - Making sure the base AC adapter is not plugged into an that's controlled by a wall switch.
The answering system won't record messages.	- Making sure the <i>Record Time</i> is not set to <i>Announce Only</i> . - Deleting messages (the memory may be full).
A handset can't access the answering system.	- Making sure no other handset is using the system. - Making sure the phone is in standby.
My outgoing message is gone.	- Seeing if there was a power failure. You may have to re-record your personal outgoing message.
I can't hear the base speaker.	- Making sure call screening is turned on. - Changing the base speaker volume.
Messages are incomplete.	- The incoming messages may be too long. Remind callers to leave a brief message. - Deleting messages (the memory may be full).
The system keeps recording if I answer on an extension.	- You may have to change the line mode. Contact customer service for more information.
I can't register a handset.	- Seeing if there are 6 handsets registered to this base. - Resetting the handset.

Weak or Hard To Hear Audio

If a caller's voice sounds weak or soft, the signal might be blocked by large metal objects or walls; you might also be too far from the base, or the handset's battery may be weak.

- ◆ Try moving around while you're on a call or moving closer to the base to see if the sound gets louder.
- ◆ Make sure the handset's battery is fully charged.
- ◆ Try adjusting the earpiece volume or the audio tone (see below).

Adjust the audio tone

During a call, open the menu and select *Audio Tone*. Choose one of the three audio tone options: *High Tone*, *Natural Tone* (recommended for hearing aid users), or *Low Tone*. You may have to experiment to figure out which audio tone works best for you.

Noise or Static On The Line

Interference is the most common cause of noise or static on a cordless phone. Here are some common sources of interference:

- ◆ electrical appliances, especially microwave ovens
- ◆ computer equipment, especially wireless LAN equipment and DSL modems
- ◆ radio-based wireless devices, such as room monitors, wireless controllers, or wireless headphones or speakers
- ◆ large florescent light fixtures (especially if they give off a buzzing noise)
- ◆ other services that use your phone line, like alarm systems, intercom systems, or broadband Internet service

Do you use a T-Coil hearing aid?

If you have a hearing aid equipped with a telecoil (T-coil) feature, the interaction between the hearing aid & digital cordless phones can cause noise in the handset. If you have a T-coil hearing aid & you have problems with noise on the line, try turning on *T-coil* mode. Open the menu. Select *Handset Setup*, then select *T-coil*.

Using T-coil mode can shorten the handset's talk time; make sure to watch the battery status and keep the battery charged.

Here are some hints for when the static is...

on 1 handset or in 1 location:	on all handsets or in all locations:
<ul style="list-style-type: none">- Check nearby for one of the common interference sources.- Try moving the handset away from a suspected source, or try moving the suspected source so it's not between the handset & the base.- Try moving closer to the base. There is always more noise at the edges of the base's range. If the handset displays an <i>Out of Range</i> message, you need to move closer to the base.	<ul style="list-style-type: none">- Check near the base for the source of interference.- Try moving the base away from a suspected source, or turn off the source if possible.- If the base has an adjustable antenna, try raising the antenna so it stands straight up.- If you have any service that uses the phone line, you might need a filter (see below).

Installing a line filter or DSL filter

Sometimes, broadband Internet services that use the telephone line can interfere with phones. One of these services—DSL—often causes static on telephones. A DSL filter or telephone line filter usually solves

this problem. The technician who installed your DSL service might have left some filters for you; if not, call your DSL provider or look in any electronics store.

Plug the DSL filter into the telephone wall jack and plug your phone's base into the filter. Make a test call to make sure the noise is gone.

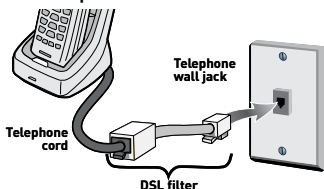

Resetting and Registering Handsets

If you are having trouble with a cordless handset or if you want to replace one, you need to clear the registration information from the base and the handset:

Do you have the base the handset is registered to?	
Yes	No
<ol style="list-style-type: none"> 1. Press & hold END and # until the <i>System Reset</i> menu appears (about 5 seconds). 2. Select <i>Deregister HS</i>. The display lists all registered handsets. 3. Select the handset you want to reset. 4. When the phone asks you to confirm, select <i>Yes</i>. The handset clears its information from the base & deletes its own link to the base. 	<ol style="list-style-type: none"> 1. Press & hold END and # until the <i>System Reset</i> menu appears (about 5 seconds). 2. Select <i>Base Unavailable</i>. 3. When the phone asks you to confirm, select <i>Yes</i>. The handset deletes its own link without contacting the base.

When you reset a handset (or if you buy a new one), that handset displays a *Handset Not Registered* message. If you see this message on a handset, you need to register it to a base before you can use it.

Registering a handset

1. On the base, open the menu and select *Register Handset*. The display should say *Handset Registering*.
2. On the handset you want to register, press and hold **POUND (#)** until the handset display says *Handset Registering* (about 2 seconds).
3. In about 30 seconds, the handset display should say *Registration Complete*. Press **TALK/FLASH** and make sure you get a dial tone.

If...	Try...
- you don't hear a dial tone - the display says <i>Registration Failed</i>	Making sure the handset is fully charged, then start over at step 1.

To register a handset to a different base, see the section "Expanding Your Phone" in the user's guide for the other base.

Handling Liquid Damage

Moisture and liquid can damage your cordless phone.

- ◆ If the handset or base is exposed to moisture or liquid, but only the exterior plastic housing is affected, wipe off the liquid, and use as normal.
- ◆ If moisture or liquid has entered the plastic housing (i.e. liquid can be heard in the phone or liquid has entered the handset battery compartment or vent openings on the base), follow these steps:

Handset	Base
<ol style="list-style-type: none"> 1. Remove the battery cover & disconnect the battery. 2. Let dry for at least 3 days with the battery disconnected and the cover off for ventilation. 3. After the handset dries, reconnect the battery pack and replace the cover. Recharge the battery fully (15-20 hours) before using. 	<ol style="list-style-type: none"> 1. Disconnect the AC adapter to cut off the power. 2. Disconnect the telephone cord. 3. Let dry for at least 3 days before reconnecting.

IMPORTANT: You must unplug the telephone line while recharging the battery pack to avoid charge interruption.

CAUTION! DO NOT use a microwave oven to speed up the drying process. This will cause permanent damage to the handset, base and the microwave oven.

Important Information

Terms Used In This Guide

Accessory Handset	An extra handset that can register to and be used with an expandable phone base. All accessory handsets must be registered to a base.
Base	The main part of the phone. It connects to your phone line and lets you make and receive calls. Most bases also have a cradle to store a handset.
CIDCW	(CID on Call Waiting.) A service that shows CID for calls that come in during another call.
Call Waiting	A service that lets you receive calls while you are on another call.
Caller ID	(Also called CID.) A service that shows the name and number of incoming callers.
Charger	A cradle that stores and charges a handset but doesn't connect to the phone line.
Cradle	The part of the phone that stores a handset. While in a cradle, a handset is always in standby, and any keys are locked.
During a call	The station is currently on a call or has activated a dial tone.
Handset	1) A cordless handset that you use to dial the phone and talk to callers. 2) A corded handset that attaches to a base with a coiled cord.
In standby	The phone is inactive: there is no dial tone, no station is on a call or listening to messages.
Station	Any handset or the base.

Specifications

		Base	Charger
AC adapter	Part number	PS-0034	PS-0035
	Input voltage	120V AC, 60 Hz	120V AC, 60 Hz
	Output voltage	7.8V AC @ 450mA	8V AC @ 300mA
Battery pack	Part number	BT-1016	
	Capacity	500mAh, 2.4V DC	

- ♦ Use only the supplied AC adapters.
- ♦ Be sure to use the proper adapter for the base & any chargers.
- ♦ Do not place the power cord where it creates a trip hazard or where it could become chafed & create a fire or electrical hazard.
- ♦ Do not place the base in direct sunlight or subject it to high temperatures.

Battery Information

- ♦ Fully charged, the battery should provide about 10 hours of talk time and about 7 days of standby time. For best results, return the handset to the cradle after each call to keep it fully charged.
- ♦ Keep an eye on the battery status icon. When the battery gets too low, the handset shows a low battery alert. If you hear a strange beep during a call, check the display: if you see the low battery alert, finish your conversation as quickly as possible and return the handset to the cradle. If the handset is in standby, none of the keys will operate.
- ♦ With normal use, the battery should last about one year. Replace the battery when the talk time becomes short even when the battery is charged. To buy a replacement battery, call the Parts Department listed on the front cover.

Rechargeable Nickel-Metal-Hydride Battery Warning

CAUTION! Risk of explosion if battery is replaced by an incorrect type! Dispose of used batteries according to the instructions. Do not open or mutilate the battery. Disconnect the battery before shipping this product.

- This equipment contains a rechargeable Nickel-Metal-Hydride battery.
- The rechargeable batteries contained in this equipment may explode if disposed of in a fire.
- Nickel is a chemical known to state of California to cause cancer.
- Do not short-circuit the battery.
- Do not charge the rechargeable battery pack used in this equipment with in any charger other than the one designed to charge this battery pack as specified in the owner's manual. Using another charger may damage the battery pack or cause the battery pack to explode.

Rechargeable Batteries Must Be Recycled or Disposed of Properly.

Uniden works to reduce lead content in PVC coated cords in our products & accessories.

Warning! The cords on this product and/or accessories contain lead, a chemical known to the State of California to cause birth defects or other reproductive harm. Wash hands after handling.

Compliance information

FCC Part 68 information

This equipment complies with Part 68 of the FCC rules & the requirements adopted by the ACTA. On the bottom of this equipment is a label that contains, among other information, a product identifier in the format US: AAAEQ##TXXXX. If requested, this number must be provided to the phone company.

An applicable Universal Service Order Codes (USOC) certification for the jacks used in this equipment is provided (i.e., RJ11C) in the packaging with each piece of approved terminal equipment. A plug & jack used to connect this equipment to the premises wiring & telephone network must comply with the applicable FCC Part 68 rules & requirements adopted by the ACTA. A compliant telephone cord & modular plug is provided with this product. It is designed to be connected to a compatible modular jack that is also compliant. See installation instructions for details.

The REN is used to determine the number of devices that may be connected to a phone line. Excessive RENs on a phone line may result in devices not ringing in response to an incoming call. In most but not all areas, the sum of RENs should not exceed five (5.0). To be certain of the number of devices that may be connected to a line, as determined by the total RENs, contact the telephone provider. The REN for this product is part of the product identifier that has the format US:AAAEQ##TXXXX. The digits represented by ## are the REN without a decimal point (e.g., 03 is a REN of 0.3).

If this equipment causes harm to the telephone network, the telephone company will notify you in advance that temporary discontinuance of service may be required. But if advance notice isn't practical, the telephone company will notify the customer as soon as possible. Also, you will be advised of your right to file a complaint with the FCC if you believe it is necessary. The telephone company may make changes in its facilities, equipment, operations or procedures that could affect the operation of the equipment. If this happens the telephone company

will provide advance notice in order for you to make necessary modifications to maintain uninterrupted service.

Please follow instructions for repairing, if any (e.g. battery replacement section); otherwise do not substitute or repair any parts of the device except as specified in this manual. Connection to party line service is subject to state tariffs. Contact the state public utility commission, public service commission or corporation commission for information. This equipment is hearing aid compatible.

Should you experience trouble with this equipment, please contact a factory service center or other authorized service agent. If the equipment is causing harm to the telephone network, the telephone company may request that you disconnect the equipment until the problem is resolved.

NOTICE: According to telephone company reports, AC electrical surges, typically resulting from lightning strikes, are very destructive to telephone equipment connected to AC power sources. To minimize damage from these types of surges, a surge arrester is recommended.

Changes or modifications to this product not expressly approved by the manufacturer, or operation of this product in any way other than as detailed by the owner's manual, could void your authority to operate this product.

FCC Part 15 information

This device complies with part 15 of the FCC rules. Operation is subject to the following two conditions: (1) This device may not cause harmful interference, & (2) This device must accept any interference received, including interference that may cause undesired operation. Privacy of communications may not be ensured when using this phone.

FCC PART 15.105(b): Note: This equipment has been tested & found to comply with the limits for a Class B digital device, pursuant to part 15 of the FCC Rules. These limits are designed to provide reasonable protection against harmful interference in a residential installation. This equipment generates, uses & can radiate radio frequency energy &, if not installed & used in accordance with the instructions, may cause harmful interference to radio communications. However, there is no guarantee that interference will not occur in a particular installation. If this equipment does cause harmful interference to radio or television reception, which can be determined by turning the equipment off & on, the user is encouraged to try to correct the interference by one or more of the following measures:

- ♦ Reorient or relocate the receiving antenna.
- ♦ Increase the separation between the equipment and receiver.
- ♦ Connect the equipment into an outlet on a circuit different from that to which the receiver is connected.
- ♦ Consult the dealer or an experienced radio/TV technician for help.

To insure the safety of users, the FCC has established criteria for the amount of radio frequency energy various products may produce depending on their intended usage. This product has been tested & found to comply with the FCC's exposure criteria. For body worn operation, the FCC RF exposure guidelines were also met when used with the Uniden accessories supplied or designed for this product. Use of other accessories may not ensure compliance with FCC RF exposure guidelines & should be avoided.

The antenna(s) used for the base-unit must be installed to provide a separation distance of at least 20 cm from all persons & must not be collocated or operated in conjunction with any other antenna or transmitter.

If your home has wired alarm equipment connected to a phone line, be sure that installing the system does not disable your alarm equipment. If you have questions about what will disable alarm equipment, contact your telephone company or a qualified installer.

Industry Canada (I.C.) Notice

Terminal equipment

NOTICE: This equipment meets the applicable **Industry Canada Terminal Equipment** Technical Specifications. This is confirmed by the registration number. The abbreviation *IC* before the registration number signifies that registration was performed based on a Declaration of Conformity indicating that Industry Canada technical specifications were met. It does not imply that Industry Canada approved the equipment.

NOTICE: The Ringer Equivalence Number (REN) for this terminal equipment is marked on the equipment itself. The REN assigned to each terminal equipment provides an indication of the maximum number of terminals allowed to be connected to a telephone interface. The termination on an interface may consist of any combination of devices subject only to the requirement that the sum of the Ringer Equivalence Numbers of all the devices does not exceed 5.

Radio equipment

The term *IC* before the radio certification number only signifies that Industry Canada technical specifications were met. Operation is subject to the following two conditions: (1) this device may not cause interference, & (2) this device must accept any interference, including interference that may cause undesired operation of the device. "Privacy of communications may not be ensured when using this telephone".

One-year Limited Warranty

Important: Evidence of original purchase is required for warranty service.

WARRANTOR: UNIDEN AMERICA CORPORATION ("Uniden") ELEMENTS OF WARRANTY: Uniden warrants, for one year, to the original retail owner, this Uniden Product to be free from defects in materials & craftsmanship with only the limitations or exclusions set out below.

WARRANTY DURATION: This warranty to the original user shall terminate & be of no further effect 12 months after the date of original retail sale. The warranty is invalid if the Product is (A) damaged or not maintained as reasonable or necessary, (B) modified, altered, or used as part of any conversion kits, subassemblies, or any configurations not sold by Uniden, (C) improperly installed, (D) serviced or repaired by someone other than an authorized Uniden service center for a defect or malfunction covered by this warranty, (E) used in any conjunction with equipment or parts or as part of any system not manufactured by Uniden, or (F) installed or programmed by anyone other than as detailed by the owner's manual for this product.

STATEMENT OF REMEDY: In the event that the product does not conform to this warranty at any time while this warranty is in effect, warrantor will either, at its option, repair or replace the defective unit & return it to you without charge for parts, service, or any other cost (except shipping & handling) incurred by warrantor or its representatives in connection with the

performance of this warranty. Warrantor, at its option, may replace the unit with a new or refurbished unit. THE LIMITED WARRANTY SET FORTH ABOVE IS THE SOLE & ENTIRE WARRANTY PERTAINING TO THE PRODUCT & IS IN LIEU OF & EXCLUDES ALL OTHER WARRANTIES OF ANY NATURE WHATSOEVER, WHETHER EXPRESS, IMPLIED OR ARISING BY OPERATION OF LAW, INCLUDING, BUT NOT LIMITED TO ANY IMPLIED WARRANTIES OF MERCHANTABILITY OR FITNESS FOR A PARTICULAR PURPOSE. THIS WARRANTY DOES NOT COVER OR PROVIDE FOR THE REIMBURSEMENT OR PAYMENT OF INCIDENTAL OR CONSEQUENTIAL DAMAGES. Some states do not allow this exclusion or limitation of incidental or consequential damages so the above limitation or exclusion may not apply to you.

LEGAL REMEDIES: This warranty gives you specific legal rights, & you may also have other rights which vary from state to state. This warranty is void outside the United States of America & Canada.

PROCEDURE FOR OBTAINING PERFORMANCE OF WARRANTY: If, after following the instructions in the owner's manual you are certain that the Product is defective, pack the Product carefully (preferably in its original packaging). Disconnect the battery from the Product & separately secure the battery in its own separate packaging within the shipping carton. The Product should include all parts & accessories originally packaged with the Product. Include evidence of original purchase & a note describing the defect that has caused you to return it. The Product should be shipped freight prepaid, by traceable means, to warrantor at:

Uniden America Service
4700 Amon Carter Blvd.
Fort Worth, TX 76155

As an Energy Star® Partner, Uniden has determined that this product meets the Energy Star® guidelines for energy efficiency. Energy Star® is a U.S. registered mark.



- Uniden® is a registered trademark of Uniden America Corporation.
- Call waiting, CID, CIDCW, and Voice Mail are telephone line services. Your phone supports these services, but you have to arrange for them through your telephone provider. Contact your provider for details.
- The pictures in this manual are for example only. Your phone may not look exactly like the pictures.

May be covered under one or more of the following U.S. patents:

5,801,466	5,825,161	5,864,619	5,893,034	5,912,968	5,915,227	5,929,598
5,930,720	5,960,358	5,987,330	6,044,281	6,070,082	6,076,052	6,125,277
6,253,088	6,314,278	6,321,068	6,418,209	6,618,015	6,714,630	6,782,098
6,788,920	6,788,953	6,839,550	6,889,184	6,901,271	6,907,094	6,914,940
6,940,867	6,953,118	7,023,176	7,030,819	7,146,160	7,203,307	7,206,403
7,310,398						

Other patents pending.

Free Manuals Download Website

<http://myh66.com>

<http://usermanuals.us>

<http://www.somanuals.com>

<http://www.4manuals.cc>

<http://www.manual-lib.com>

<http://www.404manual.com>

<http://www.luxmanual.com>

<http://aubethermostatmanual.com>

Golf course search by state

<http://golfingnear.com>

Email search by domain

<http://emailbydomain.com>

Auto manuals search

<http://auto.somanuals.com>

TV manuals search

<http://tv.somanuals.com>