

Uniden®

UNIDEN
CORDLESS
TELEPHONES

DECT1560 Series



Table of Contents

Welcome	5	Manual Conventions	17
Accessibility	5	Parts of the Handset	18
Installing the Phone	6	Parts of the Base	19
Choosing the Best Location	6	Using the Interface	20
Installing the Battery	7	Reading the Display.....	20
Connecting the AC adapter.....	8	Using the Four-way Function Key.....	21
To the base.....	8	Using the Handset Menu	21
To the DCX150 charging cradle (for multi-handset packs only)	8	Entering Text from Your Handset	22
Charging the Handset.....	9	Basic Setup	23
Connecting to the Phone Line.....	10	Selecting a Language	23
Testing the Connection	11	Setting the Time	23
Changing the dial mode	12	Activating Personal Ring.....	24
Expanding Your Phone	13	Activating the Key Touch Tone	24
Adding accessory handsets	13	Setting Up the Phonebook	25
Registering accessory handsets	13	Creating Phonebook Entries	25
Using Multiple Bases	14	Finding a Phonebook Entry.....	26
Registering the handset to another base	14	Editing an Existing Phonebook Entry.....	26
Selecting the base.....	15	Storing Caller ID or Redial Numbers in the Phonebook.....	27
Getting to Know Your New Phone	16	Deleting a Single Phonebook Entry	27
Features.....	16	Deleting all Phonebook Entries.....	28
Terminology Used in this Manual	17	Copying Phonebook Entries to Another Handset....	28

Customizing Your Handsets	29	Adjusting the Audio Tone	37
Changing the Handset Banner.....	29	Activating T-Coil Mode	37
Selecting a Ring Tone	29	Finding a Lost Handset	38
Activating AutoTalk.....	30	Using Hold, Conference and Transfer	38
Activating Any Key Answer	30	Placing a Call on Hold.....	38
Using Your Phone	31	Conferencing.....	38
Making a Call from the Phonebook.....	32	Transferring a Call.....	39
Chain dialing from the phonebook.....	32	Answering a transferred call	39
Switching to the Handset Speakerphone		Using Special Features	40
During a Call.....	32	Privacy Mode	40
Using Caller ID, Call Waiting, and Redial Lists	33	Using the Intercom.....	40
Using the Caller ID List	33	Making an intercom page	40
Making a Call from a Caller ID Record	33	Answering an intercom page	41
Seven-digit dialing	34	Muting the Microphone	41
Deleting Caller ID Numbers	34	Tone Dialing Switch Over.....	41
Using Call Waiting.....	35	Using a Voice Mail Service	42
Redialing a Number	35	Setting the voice mail signaling tone	42
Deleting a Redial Record	35	Programming one-touch voice mail access.....	43
Adjusting the Ringer, Earpiece and		Resetting the voice message waiting indicator ..	43
Speaker Volume	36	Wall Mounting the Base	44
Adjusting the Ringer Volume.....	36	Maintenance	46
Muting the Ringer (One call only)	36	Specifications.....	46
Adjusting the Earpiece Volume	36	Battery Information.....	46
Adjusting the Speaker Volume.....	36		

Battery life	46	Terminal equipment	58
Low battery alert	47	Radio equipment	58
Cleaning the charging contacts	47	One Year Limited Warranty.....	59
Battery replacement and handling	47	Index	60
Power Failures	47		
Troubleshooting	48		
Common Issues	48		
Weak or Hard to Hear Audio	50		
Noise or Static on the Line.....	50		
Installing a telephone line filter or DSL filter	51		
Resetting the Handset	51		
Resetting the Handset Without the Base	52		
Changing the Line Mode for Multiple Extensions....	53		
Traveling Out of Range	53		
Liquid Damage.....	54		
Precautions!	55		
Rechargeable Nickel-Cadmium Battery Warning ...	55		
Rechargeable Nickel-Cadmium Batteries Must Be Recycled or Disposed of Properly	55		
Important Safety Instructions	56		
The FCC Wants You To Know	56		
Radio interference	58		
Cordless telephone privacy	58		
I.C. Notice	58		

Welcome

Thank you for purchasing a Uniden Multi-Handset phone.

Note: Illustrations in this manual are used for explanation purposes. Some illustrations in this manual may differ from the actual unit.

As an Energy Star® Partner, Uniden has determined that this product or product models meets the Energy Star® guidelines for energy efficiency. Energy Star® is a U.S. registered mark.

Uniden is a registered trademark of Uniden America Corporation.



Accessibility

Uniden provides a customer service hotline for accessibility questions. If you have a disability and need customer service assistance or if you have any questions about how Uniden's products can accommodate persons with disabilities, please call the accessibility voice/TTY line: 1-800-874-9314.

Our customer care hours as well as accessibility information can be found on our website, www.uniden.com, under the "Accessibility" link. If your call is received outside of our business hours, you can leave us a message and we will call you back.

May be covered under one or more of the following U.S. patents:







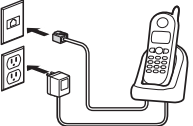
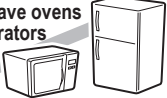
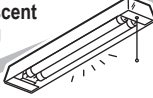

5,491,745	5,533,010	5,574,727	5,581,598	5,606,598	5,650,790	5,660,269	5,663,981
5,671,248	5,717,312	5,732,355	5,754,407	5,758,289	5,768,345	5,787,356	5,794,152
5,801,466	5,825,161	5,864,619	5,893,034	5,912,968	5,915,227	5,929,598	5,930,720
5,960,358	5,987,330	6,044,281	6,070,082	6,076,052	6,125,277	6,253,088	6,314,278
6,321,068	6,418,209	6,618,015	6,714,630	6,782,098	6,788,920	6,788,953	6,839,550
6,889,184	6,901,271	6,907,094	6,914,940	6,940,867	6,953,118	7,023,176	7,030,819
7,146,160	7,203,307	7,206,403	7,310,398	7,460,663			

Other patents pending.

Installing the Phone

Choosing the Best Location

When choosing a location for your new phone, here are some important guidelines you should consider:

PLACE YOUR BASE	TRY TO AVOID		
 <p>Near an AC outlet and a telephone wall jack.</p>	<ul style="list-style-type: none">• Microwave ovens• Refrigerators 	<ul style="list-style-type: none">• Fluorescent lighting 	<ul style="list-style-type: none">• Other cordless telephones 
 <p>In a centrally-located open area.</p>	<ul style="list-style-type: none">• TVs• Other electronics 	<ul style="list-style-type: none">• Personal computers• Wireless LAN equipment 	<ul style="list-style-type: none">• Areas with a lot of background noise 
<ul style="list-style-type: none">• Direct sunlight• Extreme temperatures 	<ul style="list-style-type: none">• Dust• Excessive moisture 	<ul style="list-style-type: none">• Shock• Vibration 	

Notes: For maximum range:

- Keep both the base and handset antennas free of obstruction.
- When the handset is not in use, place the handset in an upright position.
- Metal and reinforced concrete may affect cordless telephone performance.

Installing the Battery

Use only the Uniden BT-1007 or BT-1015 rechargeable battery pack supplied with your cordless telephone.

- ① Unpack all handsets, battery packs, and battery covers. (If the battery cover is on the handset, press in on the notch and slide the cover off.)

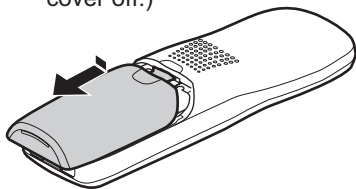

- ② Line up the battery pack connector with the jack inside the handset. (The battery connector will only fit one way.)

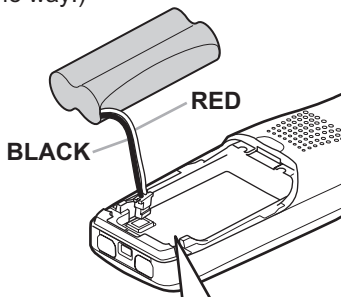

- ③ Push the battery pack connector in firmly. (You should hear it click into place.) Gently tug on the battery wires to make sure the connection is secure.

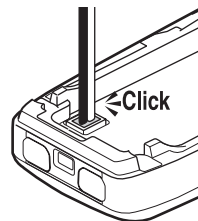

- ④ Place the cover over the battery compartment and slide it up into place.

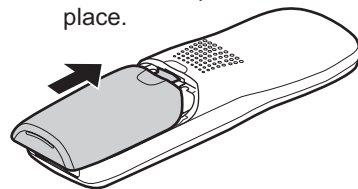

Connecting the AC adapter

To the base

To avoid risk of fire and shock, only use the Uniden PS-0035 AC adapter with the base.

- 1 Connect the AC adapter to the **AC IN 8V** jack on the back of the base.

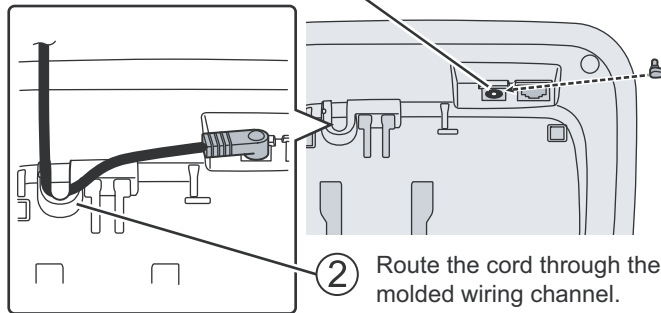

- 3 Connect the AC adapter to a standard 120V AC wall outlet.

Don't put any power cord where people might trip over it or step on it. If a power cord becomes chafed or worn out, it can create a fire or electrical hazard.

To the DCX150 charging cradle (for multi-handset packs only)

Use only the Uniden PS-0035 AC adapter with the DCX150 charging cradle.

- 1 Connect the AC adapter to the **AC IN 8V** jack as shown. (It may already be connected.)

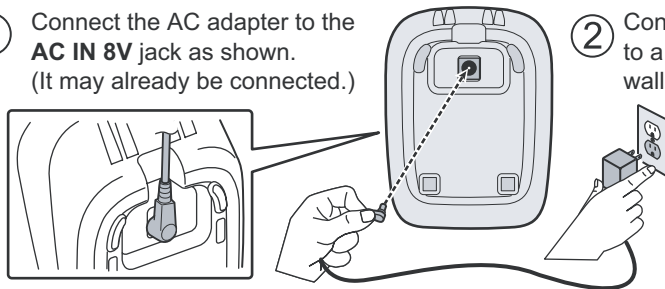

Charging the Handset

- 1 Place the handset in the base cradle with the display facing forward.

- 2 If you have an accessory handset, place it in the charging cradle with the display facing forward.

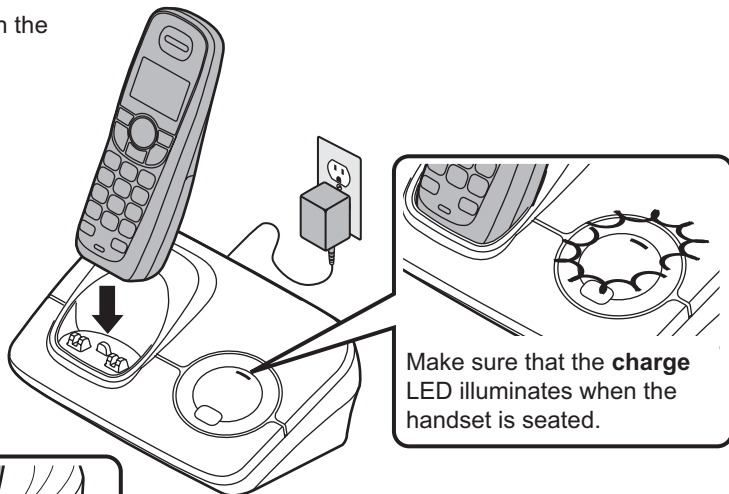
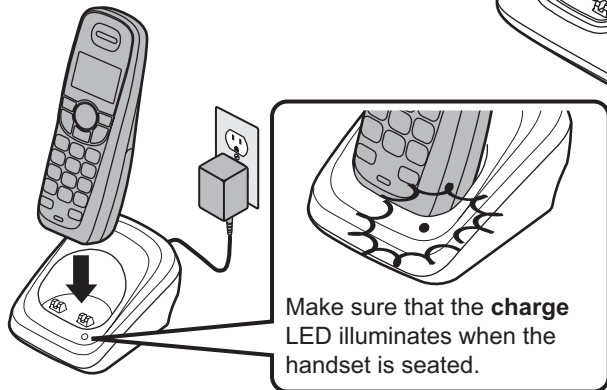

? What if the **charge** LED doesn't light up?



- Reseat the handset; make sure the contacts on the bottom of the handset are lined up with the contacts in the charging cradle.
- Check the AC adapter connection.
- Make sure you are not using an outlet that's controlled by a wall switch.

- 3 Charge your handset at least 15 to 20 hours before plugging into the phone line.

Connecting to the Phone Line

Make sure that the battery pack is fully charged.

- 1 Connect the telephone cord to the **TEL LINE** jack.

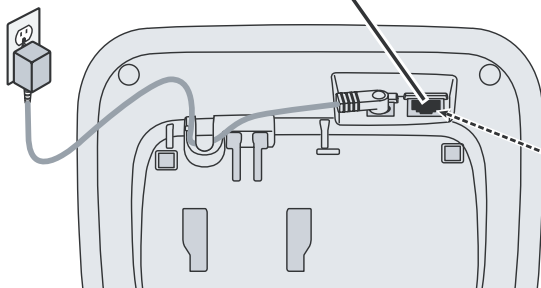

- 2 Connect the telephone cord to a telephone wall jack.

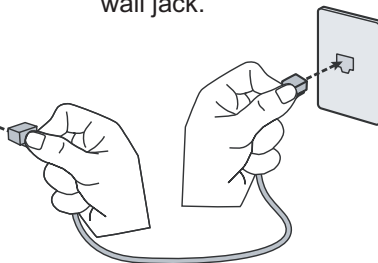

- ? What if *Check TEL Line* appears on the handset display?

💡 The telephone cord may not be connected correctly. Check the telephone cord connection.

- ? Do you have DSL or any high-speed Internet service delivered through your phone line?

💡 Try putting a DSL filter between the base and the wall jack. Without a filter, telephone-line-based Internet services can interfere with standard phones.

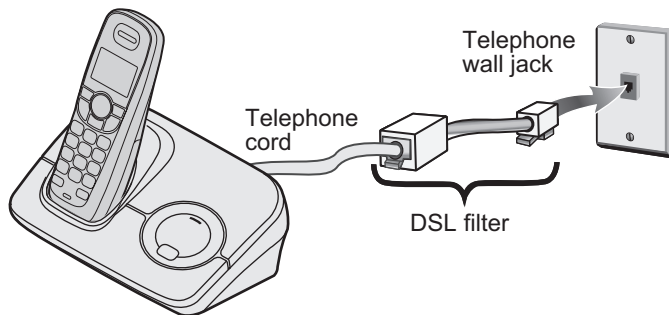

Testing the Connection

① Pick up the handset from the cradle and press **TALK/FLASH**. You should hear a dial tone, and the display should show *Talk*.

? What if I can't hear a dial tone?

💡 Check the telephone cord connection on the base.

? What if the display doesn't show *Talk*?

- 💡 • Check the battery pack connection in the handset.
- Make sure the battery pack is fully charged.
- Make sure the AC adapter cord is securely connected to the **AC IN 8V** jack and a standard power outlet.
- Try resetting the handset (see page 51).

② Make a quick test call, and then press **END** to hang up.

? What if there is a lot of static?

💡 Check the sources of interference described in Choosing the Best Location (see page 6): is the base near any of those?

? What if the call doesn't go through?

💡 Try changing the dialing mode (see the next section).

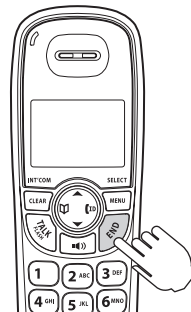
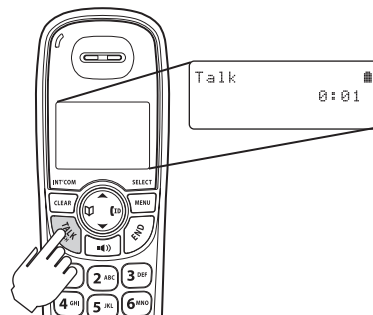

Note: Make sure you can get a dial tone on any accessory handsets that were packaged with your phone.

Changing the dial mode

Your phone can communicate with the telephone network in two different ways: tone dialing or pulse dialing. These days, most base networks use a method called tone dialing, so your phone comes programmed for tone dialing. If your phone company uses pulse dialing, you will need to change your phone's dial mode. If you don't get a dial tone or can't connect to the telephone network, please follow the steps below to modify your phone's settings:

- 1) Press **MENU/SELECT**.
- 2) Select the *Global Setup* menu, and then the *Dial Mode* submenu.
- 3) Scroll ▼ to highlight *Pulse*.
- 4) Press **MENU/SELECT**. You will hear a confirmation tone.

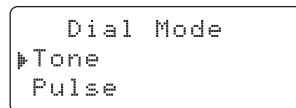

If you ever need to change the dial mode back to tone dialing, follow the same procedure, but select *Tone* in step 3.

NOW YOU ARE READY TO USE YOUR PHONE!

Expanding Your Phone

Adding accessory handsets

Your phone supports a total of six cordless handsets, including any that were supplied with your phone. You can now place a fully-featured cordless handset anywhere AC power is available to connect the charging cradle.

- Your phone is compatible with the following Uniden DECT6.0 accessory handsets: DCX150, DCX200, and DCX300. (Please visit our website at www.uniden.com for the most up-to-date list of compatible handsets.)
- If you purchase any accessory handsets separately, you must register the handsets to the base before you can use them. (Accessory handsets that come packaged with a base are already registered to that base.)

Registering accessory handsets

When charged, registered handsets display a handset ID number. Handsets that have not been registered display:

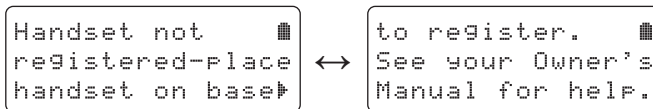

To register a DCX150 accessory handset:

- 1) Charge the handset completely. (See page 8 for instructions on connecting the charger and page 9 for instructions on charging the handset.)
- 2) Place the handset in the base cradle for about thirty seconds. *Handset Registering* will appear in the LCD.
- 3) When the handset has registered to the base, the LCD will display *Registration complete* then show the handset ID number.

If the display shows *Registration failed*, repeat the process again.

To register a DCX200 or DCX300 accessory handset:

- 1) Charge the handset completely. (See the manual supplied with the accessory handset for instructions on connecting the charger and charging the handset.)
- 2) Disconnect the base AC adapter. Then press and hold **FIND** while you reconnect the adapter. Keep holding **FIND** until the **charge** LED starts to blink.

- 3) On the handset, press and hold **#** until the handset beeps and displays *Handset Registering*.
- 4) When the handset has registered to the base, the LCD will display *Registration complete* then show the handset ID number.

If the display shows *Registration failed*, repeat the process again.

Note: If a handset has ever been registered to a base, reset the handset before you register it to a new base (see *Resetting the Handset* on page 51). Or to use multiple bases, see the next section.

Using Multiple Bases

The handsets supplied with your phone can be registered to a total of four different bases. Compatible bases include the DECT1500 series and the WXI2077 series. (See our website or contact Customer Service for an up-to-date list of compatible models.)

Note: To confirm how many bases the handset is registered to, open the *Select Base* submenu (follow the step 1 of *Selecting the base* on page 15). Press **END** to close the list and return to standby.

Registering the handset to another base

To register a handset to another base:

- 1) Make sure the handset battery is fully charged.
- 2) If the other base has an LCD display:
 - With the phone in standby, press **MENU/SELECT** on the base. Move the cursor to select the *Register Handset* menu, and then press **MENU/SELECT**. *Handset Registering* will appear.

If the other base **does not** have an LCD display:

- Disconnect the base AC adapter. Then press and hold the **Find Handset** key* while you reconnect the adapter. Keep holding the **Find Handset** key until the **charge** LED starts to blink.

*This key might be labeled **Find** or **Find HS**.

- 3) On the handset, press **MENU/SELECT**. Select the *Register Base* menu. *Handset Registering* will appear in the display. (After step 2, you have thirty seconds to complete this step 3 before the system returns to standby.)

- 4) Wait approximately thirty seconds. *Registration complete* will be displayed to indicate the handset has been registered to the base and a handset ID will be automatically assigned. The handset assigns its own ID to this base, too. (Since the base ID is based on the order in which the handset was registered to the different bases, a base may have different IDs on each handset.)

If *Registration failed* appears in the LCD, please try these steps again.

Note: The handset will stay connected to the new base until you select a different base (see below).

Selecting the base

After you register your handset to more than one base, you can set the handset to automatically search for a new base if the base it's currently connected is unavailable or out of range. You can also manually select which base you want the handset to connect to; for example, if you have one base with an answering machine, you can connect to that base to check messages from the handset.

- 1) With the phone in standby, press **MENU/SELECT**. Select the *Handset Setup* menu, and then the *Select Base* submenu.
- 2) Move the cursor to select the base you want to connect to, or choose *Auto* to have the handset automatically search for and select base.
- 3) Press **MENU/SELECT**. *Searching* will appear in the display.
- 4) When the base is found, the handset will return to standby. If the base is not found, "*Searching*" continues to appear. You can repeat the procedure listed above to return back to the original connection or to find the different base.

Note: You cannot change bases during a call.

Getting to Know Your New Phone

Features

- 1.9GHz DECT 6.0 expandable system
- Expands up to 6 handsets
- Caller ID/Call Waiting with phonebook match
- Store 30 Caller ID numbers
- 70-number phonebook with alphabetical search
- Personalized ring and display name by party
- Transfer single listing or entire phonebook
- Speakerphone on handset
- 7 ringer options on handset (3 tones/4 melodies)
- Last 5 number redial
- Trilingual menu displays (English, Spanish, or French)
- Call transfer
- Conferencing
- Intercom

Terminology Used in this Manual

Accessory Handsets	Additional handsets that can register to the base, allowing you to add handsets without connecting another phone line. This base supports a total of six cordless handsets; see page 13 for compatible handsets.
Base	The main part of the phone that connects to your phone line and lets you make and receive calls.
Charging cradle	A cradle that comes with an accessory handset and charges the handset battery pack. It connects to power but does not connect to a phone line.
CID	Caller ID is available from your telephone provider and is offered to users on a subscription basis. With this service, you will be able to see the incoming caller information such as name and phone number.
CID/CW	Caller ID with Call Waiting is available by subscription from your telephone provider. With this service, you will be able to view incoming caller information while on a call with another user.
Global Settings	Any settings that apply to all registered handsets and the base. These features are available by selecting “ <i>Global Setup</i> ” or “ <i>Day & Time</i> ” in the handset menu. Only one handset can change global settings at a time, and you have to make sure the phone is not currently being used. If you have multiple bases, the different bases have each global settings; select the base before changing the global setting (see Selecting the base on page 15).
Standby	The handset and the base are not in use. (It doesn’t matter whether the handset is in the cradle: the TALK/FLASH or ■(▶) hasn’t been pressed, and there is no dial tone.)
Talk	A dial tone has been enabled, so you can dial and carry on a conversation with an outside party.

Manual Conventions

This manual uses several different type styles to help you distinguish between different parts of the phone:

- ***Bold italic*** text indicates a key or button on the phone
- *Italic* text indicates text on the display, such as menu options, prompts, and confirmation messages
- **lower case bold** text indicates a status light on the phone
- **ALL CAPITALS BOLD** indicates a connection jack on the base or charging cradle

Parts of the Handset

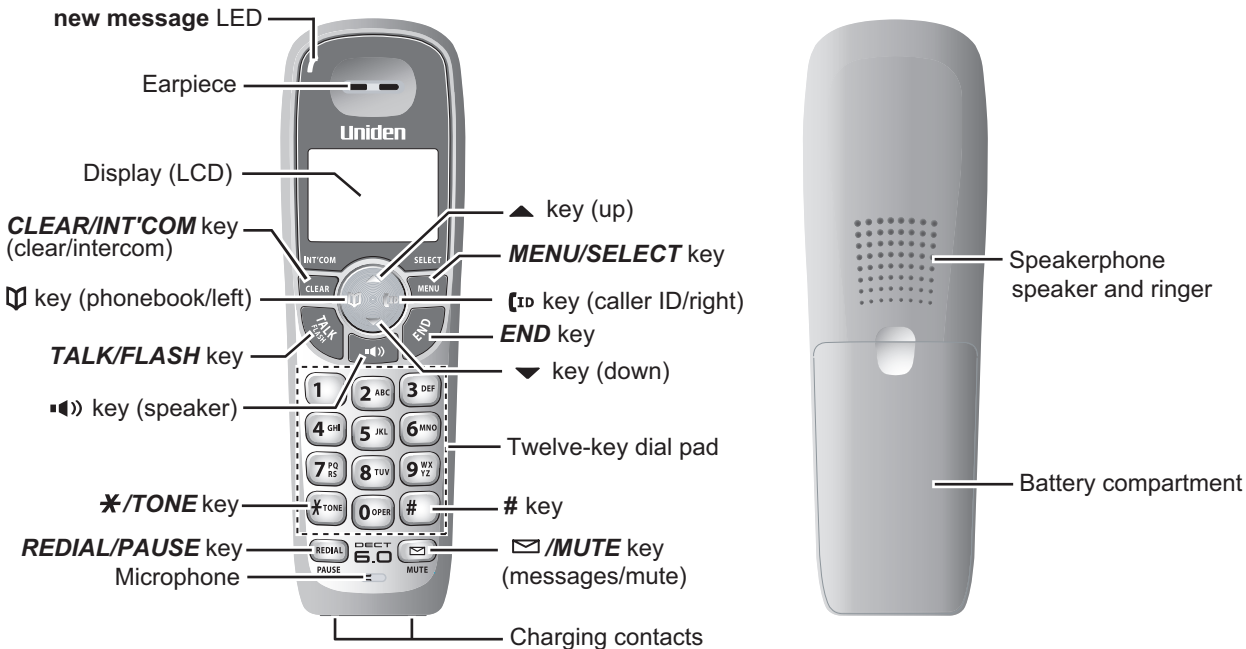

Parts of the Base



Using the Interface

Reading the Display

In standby

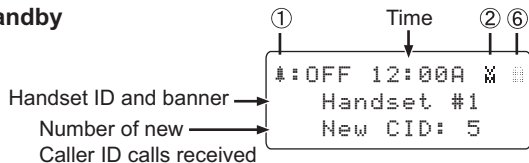

During a call

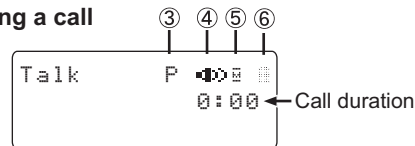

①		The ringer off icon indicates that the ringer is turned off.
②		The voice mail icon appears when you have messages waiting in your voice mailbox.
③		The privacy icon appears when the Privacy Mode is turned on.
④		The speaker icon appears when the speaker phone is in use.
		The T-coil icon appears when the T-coil Mode is turned on.
⑤		The mute icon appears while the microphone is muted.
⑥		The battery icon indicates the handset battery status: full, medium, low, and empty.

Using the Four-way Function Key

Your handset has a four-way function key that allows you to move the cursor on the display and access the most commonly used features at the touch of a button.

- Press the left side of the key to open the phonebook.
- Press the right side of the key to open the Caller ID list.
- Press the top of the key to increase the ringer volume (while the phone is in standby) or speaker volume (while you are on a call).
- Press the bottom of the key to decrease the ringer volume (while the phone is in standby) or speaker volume (while you are on a call).

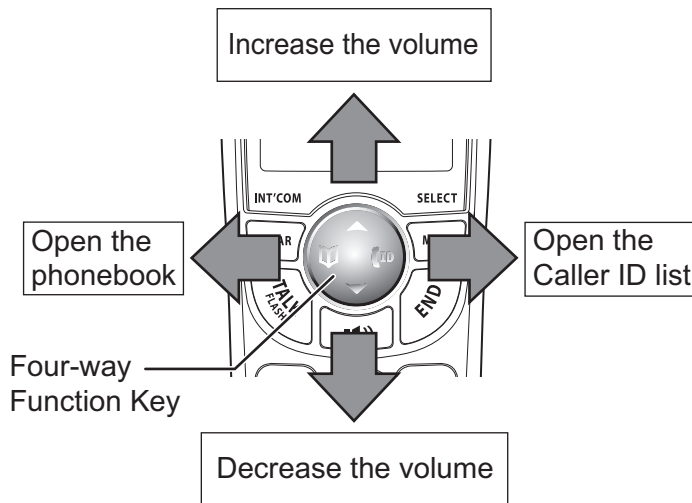

Using the Handset Menu

- To open the menu, press the **MENU/SELECT** key.
- The arrow cursor on the left side of the line shows which menu item is currently highlighted. Use ▲ on the four-way function key to move the cursor up and ▼ to move the cursor down.
- To select the highlighted option, press **MENU/SELECT**.
- To go back to the previous screen, press **left** on the four-way function key.
- To exit the menu, press **END**.
- If you don't press any keys for thirty seconds, the phone will time out and exit the menu. (When setting the day and time, the time-out period is extended to two minutes.)
- For *Global Setup* and *Day & Time* menu options, make sure the line is not in use and the handsets are within range of the base.

Entering Text from Your Handset

You can use the number keypad on your handset to enter text by referring to the letters printed on each number key. When you press the number key in a text entry field, the phone displays the first letter printed on the number key. Press the number key twice to display the second letter and three times to display the third.

- When [Aa] appears on the display, capital letters are displayed first, then lower case letters, and then the number on the key.
- When [aA] appears on the display, lower case letters are displayed first, then the number on the key, and then capital letters.
- When you input the first letter or a letter after a blank space, the default mode is [Aa]. From the next letter, the mode changes to [aA] automatically.
- You can switch back and forth the mode manually between [Aa] and [aA]. Press ***/TONE**; the case (small/capital) of the letter entered changes also.

If two letters in a row use the same number key, enter the first letter, then use **right** on the four-way function key to move the cursor to the next position to enter the second letter.

For example, to enter the word "Movies":

- 1) Press **6** once to enter *M*.
- 2) Use **right** on the four-way function key to move the cursor to the right.
- 3) Press **6** three times to enter *o*.
- 4) Press **8** three times to enter *v*.
- 5) Press **4** three times to enter *i*.
- 6) Press **3** two times to enter *e*.
- 7) Press **7** four times to enter *s*.
- 8) Press **MENU/SELECT** to end your text entry.

	Number of times key is pressed (when [Aa] appears on the display)								
keys	1	2	3	4	5	6	7	8	9
1	1								
2 ABC	A	B	C	a	b	c	2		
3 DEF	D	E	F	d	e	f	3		
4 GHI	G	H	I	g	h	i	4		
5 JKL	J	K	L	j	k	l	5		
6 MNO	M	N	O	m	n	o	6		
7 PQRS	P	Q	R	p	q	r	s	7	
8 TUV	T	U	V	t	u	v	8		
9 WXYZ	W	X	Y	Z	w	x	y	z	9
0 OPER	&	<	>	<	>	/	(blank)	-	-
	.	,	:	?	!	@	'	"	*
	#	0							

If you make a mistake while entering a name, use **right** or **left** on the four-way function key to move the cursor to the incorrect character. Press **CLEAR/INT'COM** to erase the wrong character, and then enter the correct character. To delete all characters, press and hold **CLEAR/INT'COM**.

Basic Setup

Selecting a Language

Your handset supports three languages: English, French and Spanish. You can set the handset's language individually. Once you select a language, the menus on the handset will display in that language. The default language is English.

- 1) Press **MENU/SELECT**.
- 2) Select the *Handset Setup* menu, and then the *Handset Language* submenu.
- 3) Move the cursor to choose *English*, *Français* (French) or *Español* (Spanish).
- 4) Press **MENU/SELECT**. You will hear a confirmation tone.

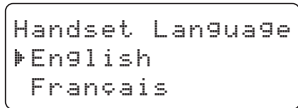

Handset Language
▶English
Français

Setting the Time

To change the time shown in the display, follow the steps listed below.

- 1) Press **MENU/SELECT**.
- 2) Move the cursor to *Day & Time* and press **MENU/SELECT**.
- 3) Use ▲ and ▼ to select the day of the week, and press **MENU/SELECT**.

Note: The day of the week does not appear on the handset display.

- 4) Use the number keypad (**0** through **9**) to enter the hour and minutes.
- 5) Use ▲ and ▼ to select *AM* or *PM*, and press **MENU/SELECT**. You hear a confirmation tone.

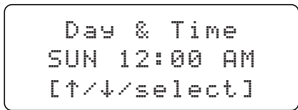

Day & Time
SUN 12:00 AM
[↑/↓/select]

Activating Personal Ring

You can assign special ringer tones to anyone in your phonebook. When your phone gets a call, it looks up the Caller ID information in your phonebook. If you've assigned a personal ringer to that number, the phone uses it so you know who is calling. To turn the personal ringing on or off, follow these steps:

- 1) Press **MENU/SELECT**.
- 2) Select the *Handset Setup* menu, and then the *Personal Ring* submenu.
- 3) Move the cursor to select *On* or *Off*.
- 4) Press **MENU/SELECT**. You will hear a confirmation tone.

```
Personal Ring
▶On
Off
```

Activating the Key Touch Tone

Key Touch Tone is the tone your keypad makes when keys are pressed. You can turn this tone on or off.

- 1) Press **MENU/SELECT**.
- 2) Select the *Handset Setup* menu, and then the *Key Touch Tone* submenu.
- 3) Move the cursor to select *On* or *Off*.
- 4) Press **MENU/SELECT**. You will hear a confirmation tone.

```
Key Touch Tone
▶On
Off
```

Setting Up the Phonebook

Each handset has its own separate phonebook that holds up to seventy names and numbers. When a handset's phonebook is full, the handset beeps and shows *Memory Full* on the display. You cannot add any names and numbers in that handset's phonebook until you delete some of the existing ones.

You can also use the phonebook entries to store a group of numbers (up to twenty digits) that you may need to enter once your call connects. This is referred to as chain dialing. (See Chain dialing from the phonebook on page 32.)

Creating Phonebook Entries

To store names and numbers in your phonebook, please follow these steps:

- 1) With the phone in standby, press  (on the left side of the four-way key).
- 2) To create a new phonebook entry, press **MENU/SELECT**. Select the *Create New* menu. *Edit Name* appears.

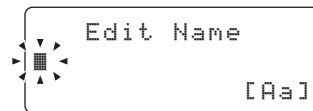

- 3) **Enter the name for this entry (EDIT NAME).**

Use the keypad to enter a name for this entry; the name can contain up to sixteen characters. (See Entering Text from Your Handset on page 22 for instructions on entering text.) If you do not want to enter a name for this entry, your phone will store this entry as *No Name*. Press **MENU/SELECT** when you are finished.

- 4) **Enter the number for this entry (EDIT NUMBER).**

Once you have stored a name, *Edit Number* appears next. Use the number keypad to enter the phone number; the phone number can contain up to twenty digits. If you need the phone to pause between digits when it's dialing (for example, to enter an extension or an access code), press **REDIAL/PAUSE** to insert a two-second pause. You will see a *P* in the display. You can also use more than one pause together if two seconds is not long enough. Each pause counts as one digit. Press **MENU/SELECT** when you are finished.

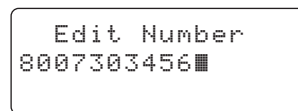

5) Assign a personal ring tone for this entry (PERSONAL RING).

You can attach a special ring tone to each phonebook entry; the phone will use this ring tone when this person calls. Use ▲ and ▼ to select one of the seven different ring tone options (see Selecting a Ring Tone on page 29 for a complete list of ring tones). As you scroll through the tones, you will hear a sample of each tone (unless the handset ringer volume is set to off). When you hear the ring tone you want to use, press **MENU/SELECT**. If you do not want to use a personal ring tone for this phonebook entry, choose *No Selection*; the phone will use your standard ring tone setting.

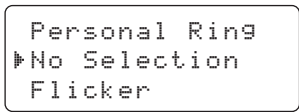

6) You will hear a tone confirming that the new entry has been stored, and *Done!* appears in the display.

Finding a Phonebook Entry

Press **Ⓜ** to open the phonebook. Phonebook entries are stored in alphabetical order. To scroll through the phonebook from A to Z, press ▼. To scroll through the phonebook from Z to A press ▲.

You can also use the letters on the number keys to jump to a name that starts with that letter. For example, to search for an entry beginning with the letter M, press **6** once. The phonebook jumps to the first entry that begins with the letter you entered; you can then use ▲ and ▼ to scroll to other entries.

To close the phonebook and return to standby, press **END**. If you are looking up a phonebook entry during a call and want to close the phonebook, press **Ⓜ** again instead of **END**.

Editing an Existing Phonebook Entry

- 1) With the phone in standby, press **Ⓜ** to open the phonebook.
- 2) Find the entry you want to edit and press **MENU/SELECT**.
- 3) Select *Edit*. Follow the steps for Creating Phonebook Entries on page 25. If you do not wish to change the information at any step, simply press **MENU/SELECT** to go to the next step.

Storing Caller ID or Redial Numbers in the Phonebook

You can store Caller ID records or redial numbers in the phonebook so you can use them later. Go to the Caller ID or redial list and select the number you want to store. (If the Caller ID information did not include the number, then you will not be able to store it.)

- 1) With the phone in standby, press **[\square]** to open the Caller ID list or **REDIAL/PAUSE** to open the redial list.
- 2) Use **▲** and **▼** to scroll through the Caller ID records or redial numbers. When you come to the information you want to store, press **MENU/SELECT**.

Note: If you need to add (or delete) a “1” to the beginning of the Caller ID phone number, press *** /TONE** (see page 33). If you need to add (or delete) the stored area code to the Caller ID phone number, press **#** (see page 34).

- 3) Select *Store into PB*. *Edit Name* appears. If the phone number is already stored in memory, you will hear a beep, and *This data is already saved!* appears in the display. The number will not be stored.
- 4) Continue by following the steps for Creating Phonebook Entries on page 25.

Deleting a Single Phonebook Entry

- 1) With the phone in standby, press **[\square]**.
- 2) Find the entry that you want to delete and press **MENU/SELECT**.
- 3) Select *Delete*. *Delete Entry?* appears in the display.
- 4) Move the cursor to select Yes.
- 5) Press **MENU/SELECT**. You will hear a confirmation tone, and *Deleted!* appears in the display.

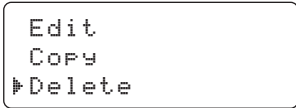

```
Edit
Copy
▶Delete
```

Deleting all Phonebook Entries

- 1) With the phone in standby, press **⏏**.
- 2) Press **MENU/SELECT**, and then select *Delete All*. *Delete All?* appears in the display.
- 3) Move the cursor to select *Yes*.
- 4) Press **MENU/SELECT**. You will hear a confirmation tone, and *Deleted!* appears in the display.

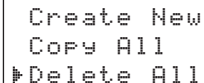

```
Create New
Copy All
▶Delete All
```

Copying Phonebook Entries to Another Handset

If you have more than one handset, you can transfer phonebook entries from one handset to another without having to re-enter names and numbers. You can transfer one phonebook entry at a time or all phonebook entries at once.

- 1) With the phone in standby, press **⏏**.
- 2) To copy one entry, find the phonebook entry you want to copy. Press **MENU/SELECT**, and then select *Copy*. To copy all entries, press **MENU/SELECT**, and then select *Copy All*.
- 3) Move the cursor to select the handset which you want to transfer the entries to and then press **MENU/SELECT**. If you select *Copy All*, *Are you sure?* appears on the display screen. Move the cursor to select *Yes*, and then press **MENU/SELECT**.
- 4) The phonebook entries will be transferred to the designated handset. During the copy process, the receiving handset shows *Receiving* and the ID of the sending handset.
- 5) When the transfer is completed, *Done!* appears on the handset.

Notes: • The handsets must be currently connected to the same base (see page 15).

- If the handset you want to transfer to already has seventy entries in its phonebook, you will hear a beep, and *Not enough memory in receiving unit* appears on the display.
- If the selected handset is out of range or data transfer is cancelled, *Unavailable* appears in the display. Phonebook listings will not be transferred.

Customizing Your Handsets

All of the following options are set separately for each handset, so you can customize a handset for each room in your house.

Changing the Handset Banner

Each handset will display a banner name once it is registered to the base. The default banner is Handset #1, Handset #2, etc. You can change the name your phone displays by changing the banner display. If you have more than one handset, the banner name identifies your handset.



- 1) Press **MENU/SELECT**.
- 2) Select the *Handset Setup* menu, and then the *Banner* submenu.
- 3) Use the keypad to enter or edit the banner name. (See Entering Text from Your Handset on page 22 for detailed instructions on entering text.)
- 4) Press **MENU/SELECT**. You will hear a confirmation tone.

Note: When you have multiple bases and even if the handset ID is changed when you switch to a different base, the handset will keep the banner name.

Selecting a Ring Tone

You may choose from four melodies or three tones for your phone's primary ring tone. Each handset can use a different ring tone or melody. The available ring tones are as listed:

Melodies	Fur Elise (<i>Elise</i>)	Tones	Flicker
	We Wish You A Merry Christmas (<i>Merry-Xmas</i>)		Clatter
	Aura Lee (<i>Aura Lee</i>)		Wake Up
	Star Spangled Banner (<i>Star Spngl</i>)		

- 1) Press **MENU/SELECT**.
- 2) Select the *Handset Setup* menu, and then the *Ringer Tones* submenu.
- 3) Move the cursor to select a ring tone. As each ring tone is highlighted, you will hear a sample (unless the handset ringer volume is set to off).
- 4) When you hear the tone you want to use, press **MENU/SELECT**. You will hear a confirmation tone.

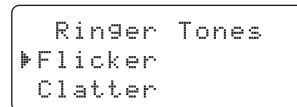

Activating AutoTalk

AutoTalk allows you to answer the phone simply by picking up the handset from the cradle. You do not have to press a button to answer the call.

- 1) Press **MENU/SELECT**.
- 2) Select the *Handset Setup* menu, and then the *AutoTalk* submenu.
- 3) Move the cursor to select *On* or *Off*.
- 4) Press **MENU/SELECT**. You will hear a confirmation tone.

A screenshot of a mobile phone's menu screen. The text is displayed in a monospaced font. At the top, it says "AutoTalk". Below that, there are two options: "On" and "Off". A small cursor icon is positioned to the left of the "Off" option, indicating it is currently selected.

```
AutoTalk
On
Off
```

Activating Any Key Answer

Any Key Answer allows you to answer the phone by pressing any key on the twelve-key dial pad.

- 1) Press **MENU/SELECT**.
- 2) Select the *Handset Setup* menu, and then the *Any Key Answer* submenu.
- 3) Move the cursor to select *On* or *Off*.
- 4) Press **MENU/SELECT**. You will hear a confirmation tone.

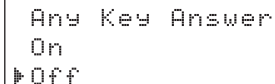

A screenshot of a mobile phone's menu screen. The text is displayed in a monospaced font. At the top, it says "Any Key Answer". Below that, there are two options: "On" and "Off". A small cursor icon is positioned to the left of the "Off" option, indicating it is currently selected.

```
Any Key Answer
On
Off
```

Using Your Phone

	From a cordless handset	From a handset speakerphone
Making a call	1) Pick up the handset from the cradle. 2) Press TALK/FLASH . 3) Listen for the dial tone. 4) Dial the number. OR 1) Pick up the handset from the cradle. 2) Dial the number. 3) Press TALK/FLASH .	1) Pick up the handset from the cradle. 2) Press ■(▶) . 3) Listen for the dial tone. 4) Dial the number. OR 1) Pick up the handset from the cradle. 2) Dial the number. 3) Press ■(▶) .
Answering a call	1) Pick up the handset. (If AutoTalk is on, the phone will answer when you pick up the handset from the cradle.) 2) Press TALK/FLASH . (If Any Key Answer is on, you can also press any key on the dial pad.)	1) Pick up the handset. 2) Press ■(▶) .
Hanging up	Press END or return the handset to the cradle.	



Making a Call from the Phonebook

- 1) With the phone in standby, press  to open the phonebook.
- 2) Find the phonebook entry you want to call (see Finding a Phonebook Entry on page 26).
- 3) Press **TALK/FLASH** or  to dial the number.



Note: You can also press **TALK/FLASH** or  before you open the phonebook. Find the phone number you want to dial, and then press **MENU/SELECT**.

Chain dialing from the phonebook

If you often have to enter a series of digits or a code number during a call, you can save that code number to a phonebook entry. When your call connects, just use the phonebook to transmit the saved code number. (This is referred to as chain dialing.)

- 1) Enter the code number (up to twenty digits) into the phonebook (see Creating Phonebook Entries on page 25). Be sure to enter the code number into the phonebook exactly as you would enter it during a call.
- 2) During a call, when you hear the prompt that tells you to enter the code number, press .
- 3) Use  or  to select the phonebook entry that contains the digits you want to send.
- 4) Press **MENU/SELECT**. The phone sends the digits of the code number exactly as you saved them in the phonebook entry.

Switching to the Handset Speakerphone During a Call

To switch a normal call to the speakerphone, press  on the handset. To switch from a speakerphone call to a normal call, press .

Using Caller ID, Call Waiting, and Redial Lists

If you subscribe to Caller ID service from your phone company, your phone will show you the caller's phone number and name (if available) whenever a call comes in. If you subscribe to Caller ID on Call Waiting, the phone will also show you the name and the number of any call that comes in while you're on the line.

Using the Caller ID List

You can store up to thirty Caller ID numbers in each handset. Caller ID records are stored from newest to oldest. Once your Caller ID list is full, the oldest record will be automatically deleted when a new call is received. When you have new Caller ID records (that is, records you have not reviewed yet) and the phone is in standby, the handset will display the number of new Caller ID calls received. (See page 20.)

```
12/21 12:00PM *  
Jane Smith  
214-555-1234
```

To open the Caller ID list, press **[ID** (on the right side of the four-way key). The phone will show the latest record. Use **▲** and **▼** to scroll through the list. (New records have an asterisk next to the received time.)

Making a Call from a Caller ID Record

- 1) With the phone in standby, press **[ID** to open the Caller ID list.
- 2) Use **▲** and **▼** to find the Caller ID record you want to dial.
- 3) If you need to add (or delete) a "1" to the beginning of the displayed phone number, press *** / TONE**.
- 4) Press **TALK/FLASH** or **[M]** to dial the number.

Note: You can also press **TALK/FLASH** or **[M]** before you open the caller ID list. Find the phone number you want to dial, and then press **MENU/SELECT**.



What's this "add or delete a 1" about?



- Any phone number in the Caller ID records might (or might not!) have a "1" at the front, depending on how different phone companies send the Caller ID information.
- The phone dials the number exactly as it appears in the Caller ID record.
- If the phone number is a long distance or toll call, but the Caller ID record does not have a "1" in front of the number, press *** / TONE** to add it. If the phone number is a local or non-toll call, but the Caller ID record has a "1" in front of the number, press *** / TONE** to delete it.

Seven-digit dialing

If you can make a local call by dialing only seven digits instead of ten, you can tell the phone to hide your local area code in the Caller ID list; any calls from outside your area code will show all ten digits. This setting applies to the base and all handsets currently connected to the same base.

To program your local area code:

- 1) Press **MENU/SELECT**.
- 2) Select the *Global Setup* menu, and then the *Area Code* submenu.
- 3) Use the number keypad (**0** through **9**) to enter a three-digit area code. If an area code has already been stored, it appears in the display. Press **CLEAR/INT'COM** to delete the stored code, and then enter a new one.
- 4) Press **MENU/SELECT**. You will hear a confirmation tone.

Note: If you have multiple bases, select the base before programming the area code (see page 15).

- The phone uses the stored area code as a filter. When a call comes in, the phone compares the incoming area code to the code programmed on the phone. If the two codes match, the handset hides the area code in the Caller ID list.
- When you are reviewing the Caller ID list, you can show the hidden area code by pressing **#**. Press **#** again to hide the area code.
- When you dial from a Caller ID record or store a Caller ID record in the phonebook, the phone dials or stores the digits exactly as they appear on the display. If you need to use ten digits, be sure to press **#** to show the area code before you dial or store the number. (See page 27 to store a Caller ID record in the phonebook.)

Deleting Caller ID Numbers

To delete only one Caller ID number, press **ID** when the phone is in standby, and then find the number you want to delete. Press **MENU/SELECT** and select *Delete Entry*. When the phone asks you to confirm, select **Yes**.

To delete all the Caller ID numbers, press **ID** when the phone is in standby. Press **MENU/SELECT** and select *Delete All*. When the phone asks you to confirm, select **Yes**.

- Notes:
- When you delete a Caller ID number, you delete it permanently.
 - Caller ID numbers are stored separately in each handset. Deleting a record from one handset will not delete the record from any other handsets.

Using Call Waiting

If you have Call Waiting service and a second call comes in when you are on the phone, a call waiting tone will sound. Press **TALK/FLASH** to accept the waiting call. There is a short pause, and then you will hear the new caller. To return to the original caller, press **TALK/FLASH**.

Note: You must subscribe to Call Waiting service for this feature to operate. Not all features are available in all areas.



```
Talk
Jane Smith
214-555-1234
```

Redialing a Number

You can quickly redial the last five numbers dialed on each handset.

- 1) With the phone in standby, press the **REDIAL/PAUSE** to open the redial list.
- 2) Use ▲ and ▼ or **REDIAL/PAUSE** to scroll through the redial list.
- 3) When you find the number you want to dial, press **TALK/FLASH** or ■◀▶).

Notes:

- If the number exceeds 32 digits, only the first 32 digits are retained in redial memory.
- If the redial memory is empty, *Empty* appears in the display and you will hear a beep.
- You can also press **TALK/FLASH** or ■◀▶) before you open the redial list. Find the phone number you want to dial, and then press **MENU/SELECT**.

Deleting a Redial Record

If you want to delete a phone number from the redial list, follow the steps below:

- 1) With the phone in standby, press **REDIAL/PAUSE**.
- 2) Use ▲ and ▼ to scroll through the redial list.
- 3) When you find the redial number you want to delete, press **MENU/SELECT** and select *Delete Entry*.
- 4) When the phone asks you to confirm, select Yes. The redial number is deleted.

Adjusting the Ringer, Earpiece and Speaker Volume

Adjusting the Ringer Volume

You can choose from four ringer volume settings (off, low, medium, and high) separately on each handset.

- 1) With the phone in standby, press ▲ or ▼. The display shows the current volume level and the handset sounds the ringer at that level.
- 2) Use ▲ to make the ringer volume louder or use ▼ to make it softer or turn it completely off.
- 3) When you hear the ringer volume level you want to use, stop pressing keys. The handset will use the new ringer volume starting with the next incoming call.

Note: If you set the ringer volume to *Off*, the handset won't ring. If you have any accessory handsets, other handsets will ring according to their individual settings.

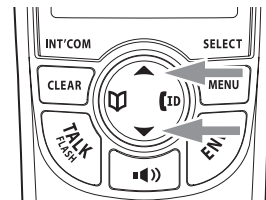

Muting the Ringer (One call only)

While the phone is ringing, press /MUTE or END to mute the ringer for this call. The phone will ring again on the next call. (The handset must be off the cradle to mute the ringer.)

Adjusting the Earpiece Volume

You can choose from six volume levels for the handset earpiece. To adjust the earpiece volume while on a call, press ▲ (to make it louder) or ▼ (to make it softer). The handset display shows the current volume level for the earpiece.

Adjusting the Speaker Volume

You can choose from six volume levels for the handset speaker while on a speakerphone call. To adjust the handset speaker volume, press ▲ (to make it louder) or ▼ (to make it softer). The handset display shows the current volume level for the handset speaker.

Note: The handset earpiece and the handset speaker have separate volume settings.

Adjusting the Audio Tone

If you aren't satisfied with the audio quality of your phone, you can adjust the Audio Tone of the earpiece while on a call. Your phone gives you three audio tone options: low, natural and high; the default setting, Natural Tone, is recommended for hearing aid users. Audio tone adjustments only apply to the earpiece, not the speakerphone.

To adjust the audio tone:

- 1) While on a call, press **MENU/SELECT**.
- 2) Move the cursor to select *Audio Tone*, and then press **MENU/SELECT**.
- 3) Move the cursor to select desired option (*High Tone*, *Natural Tone*, or *Low Tone*), and then press **MENU/SELECT**. Selected option appears in the display for two seconds, and then the display returns to normal.

Activating T-Coil Mode

Digital cordless phones generate magnetic signals that can cause noise on hearing aids equipped with a telecoil ("T" coil) feature. This phone includes a special "T-coil" mode that, when activated, reduces the magnetic noise generated by the handset.

- 1) With the phone in standby, press **MENU/SELECT**.
- 2) Select the *Handset Setup* menu, and then the *T-coil* submenu.
- 3) Move the cursor to select *On* or *Off*.
- 4) Press **MENU/SELECT**. You will hear a confirmation tone.

When the T-coil mode is turned on, **T** appears in the display during a call.

Note: Using the T-coil mode may shorten the handset battery's talk time; make sure you always return the handset to the charging cradle when not in use. Only activate T-coil mode if you experience problems using the handset with a T-coil-equipped hearing aid.

Finding a Lost Handset

To locate a misplaced handset, press **FIND** on the base when the phone is in standby. The handsets connected to the paging base will beep for one minute, and **PAGING** appears on the handset display. To cancel paging, press **FIND** again or any key on the found handset.

Note: Handsets that are not currently connected to this base will not be paged.

Using Hold, Conference and Transfer

Placing a Call on Hold

- 1) During a call, press **CLEAR/INT'COM** to place the caller on hold. If you leave a caller on hold for more than ten seconds, the display screen will read, *Line On Hold*.
- 2) To return to the party on hold, press **TALK/FLASH** or **⏏**. The phone will return to the holding party.

Notes:

- You can only place a caller on hold for five minutes. Once five minutes has passed, that party's line will be disconnected and the phone will return to standby.

- While a call is on hold, Call Waiting and CID on Call Waiting do not work.

Conferencing

If you have more than one handset, up to three people can participate in a conference call. A three-way conference call consists of an outside line and two handsets. You can easily join a call already in progress. The handsets must be currently connected to the same base (see page 15).

- 1) Press **TALK/FLASH** or **⏏** to join the call.
- 2) To hang up, return the handset to the cradle or press **END**. The other party will still be connected to the call.

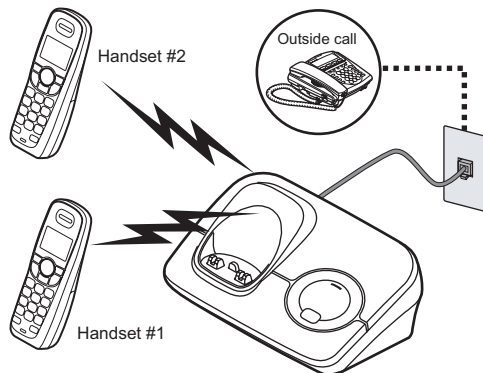

Transferring a Call

You can transfer a call from one handset to another. The handsets must be currently connected to the same base (see page 15).

- 1) During a call, press **CLEAR/INT'COM**.
- 2) Use ▲ or ▼ to select the handset you want to transfer the call to, and then press **MENU/SELECT**. Select *All* to page all other handsets. The call will automatically be placed on hold, and a paging tone sounds. To cancel the transfer, press **TALK/FLASH** or **⏏**.
- 3) When another handset accepts the transferred call, you will be disconnected. If you want to rejoin the call, press **TALK/FLASH** or **⏏** again.

Answering a transferred call

When a handset receives a call transfer, it sounds a paging tone; handsets also show the ID of the handset that is paging. To accept the call transfer:

- 1) To answer the page and speak to the transferring handset, press **TALK/FLASH** or **CLEAR/INT'COM**.

Note: If AutoTalk is on, the handset will automatically answer the page when you pick up the handset from the cradle. If Any Key Answer is on, you can also press any key on the handset's dial pad.

- 2) To accept the call and speak to the caller, press **TALK/FLASH** on the receiving handset.
- 3) When you accept the transferred call, the transferring handset will be disconnected.

Only the first handset to answer the transfer page will be connected to the call. If the transfer page is not picked up within one minute, the operation will be canceled.

Using Special Features

Privacy Mode

Privacy mode prevents other handsets (that are connected to the same base) from interrupting your call. As long as your handset is in privacy mode, other handsets can't join your call or make any calls of their own: their displays will show *Unavailable*.

- 1) While on a call, press **MENU/SELECT**.
- 2) Select *Call Privacy. Privacy Mode On* appears in the display for two seconds;  appears and remains in the display until the feature is turned off.



To turn privacy mode off, repeat the procedure listed above. *Privacy Mode Off* appears.

Note: Privacy mode does not affect handsets that are connected to a different base or extension phone.

Using the Intercom

You can use the intercom to talk to another handset without using the phone line. The handsets must be currently connected to the same base (see page 15).

Making an intercom page

- 1) With the phone in standby, press **CLEAR/INT'COM**.
- 2) Use  or  to select the handset you want to talk with, and then press **MENU/SELECT**. Select *All* to page all other handsets.
- 3) To cancel the intercom page, press **END**.

Notes: Intercom paging will be cancelled if any of the following things occur:

- You receive an outside call or an intercom page while selecting the other handset.
- You do not select a handset within thirty seconds.
- Your handset is out of range (*Out Of Range* appears in the display).
- The party does not answer the page within one minute.
- The party is busy.
- The party is out of range (*Unavailable* appears in the display).

Answering an intercom page

When the intercom page tone sounds, the display will show the ID of the handset that is paging.



- 1) Press **TALK/FLASH** or **CLEAR/INT'COM**.

Note: If AutoTalk is on, the handset will automatically answer the page when you pick up the handset from the cradle. If Any Key Answer is on, you can also press any key on the handset's dial pad.

- 2) To hang up an intercom call, press **END**.

Muting the Microphone

Mute turns off the microphone so the caller can't hear you. This only works while you are on a call.

- 1) Press **MUTE**. *Mute On* and  appear in the display;  remains while muting is on.
- 2) To cancel muting, press **MUTE** again. *Mute Off* appears.

Tone Dialing Switch Over

If your phone is set to pulse dialing, you can temporarily switch to tone dialing after the call connects. This feature is useful when you need tone dialing to use automated menu systems, such as telephone bank tellers, telephone prescription refills, customer support menus, etc. Make your call normally. Once your call connects, press ***TONE** on the handset. Any digits you enter from then on will be sent with tone dialing. When this particular call ends, the phone automatically returns to pulse dialing.

See Changing the dial mode on page 12 for instructions on setting your phone for pulse or tone dialing.

Using a Voice Mail Service

If you subscribe to a voice mail service, you can use your phone to access your voice mailbox. When there are messages waiting in your voice mailbox, the **new message** LED on the handset flashes, and  appears in the handset display.

If you program your access number into your phone, you can simply press /**MUTE** to access your voice mail. Your voice mail service provider should provide you with the access number, signaling tone, and other specifics when you enroll.

Setting the voice mail signaling tone

If you are having trouble with your message waiting indicator on your phone not illuminating when you have waiting messages, you will need to contact your service provider and inquire as to which type of message notification signal — either Frequency Shift Keying (FSK) or Stutter Dial Tone (SDT) — their service uses.

If your voice mail service uses an FSK message signal to alert you of a new voice mail message, you must turn off the Voice Mail Tone. If your voice mail service uses an SDT message signal to alert you of new voice mail messages, you can leave the Voice Mail Tone on.

Follow the instructions below to set up your cordless phone settings:

- 1) Press **MENU/SELECT**. Select the *Global Setup* menu, and then the *Voice Mail Tone* submenu.
- 2) Move the cursor to set the SDT Voice Mail Tone to *On* or *Off*.
- 3) Press **MENU/SELECT**. You hear a confirmation tone.

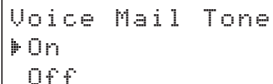

Voice Mail Tone
▶ On
Off

Programming one-touch voice mail access

You can program your voice mail access number to the Voice Mail key /**MUTE** on each handset so you can get your messages at the touch of a button. Your voice mail service provider will supply you with the access number (this may be simply a phone number).

To edit the voice mail number, follow the steps below:

- 1) Press **MENU/SELECT**.
- 2) Move the cursor to select the *Handset Setup* menu and press **MENU/SELECT**.
- 3) Move the cursor to select *Edit Voice Mail* and press **MENU/SELECT**.
- 4) Enter your personal access number (up to twenty digits). If you need to have the phone wait before sending the next digits, press **REDIAL/PAUSE** to insert a two-second pause in the dialing sequence. For a longer pause, press **REDIAL/PAUSE** multiple times. A P appears in the display each time you press **REDIAL/PAUSE** and each pause counts as one digit.
- 5) Press **MENU/SELECT** when you are finished. You will hear a confirmation tone.

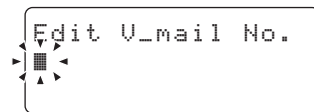

Resetting the voice message waiting indicator

When you receive a new voice mail message, the **new message** LED on the top of the handset flashes and  appears in the handset display. In the event your message waiting light gets out of sync with your phone company's voice messaging system, you can manually reset it back to the "No messages waiting" state.

- 1) Press and hold **FIND** on the base for five seconds.
Note: The handsets connected to the base will start to beep, however, keep pressing for five seconds.
- 2) A beep sounds and the message alert tone is reset.

Wall Mounting the Base

This phone can be mounted on any standard telephone wall plate using an optional wall-mount bracket. You can purchase a wall-mount bracket by calling the Uniden Parts Department. (See the back cover page for contact information.)

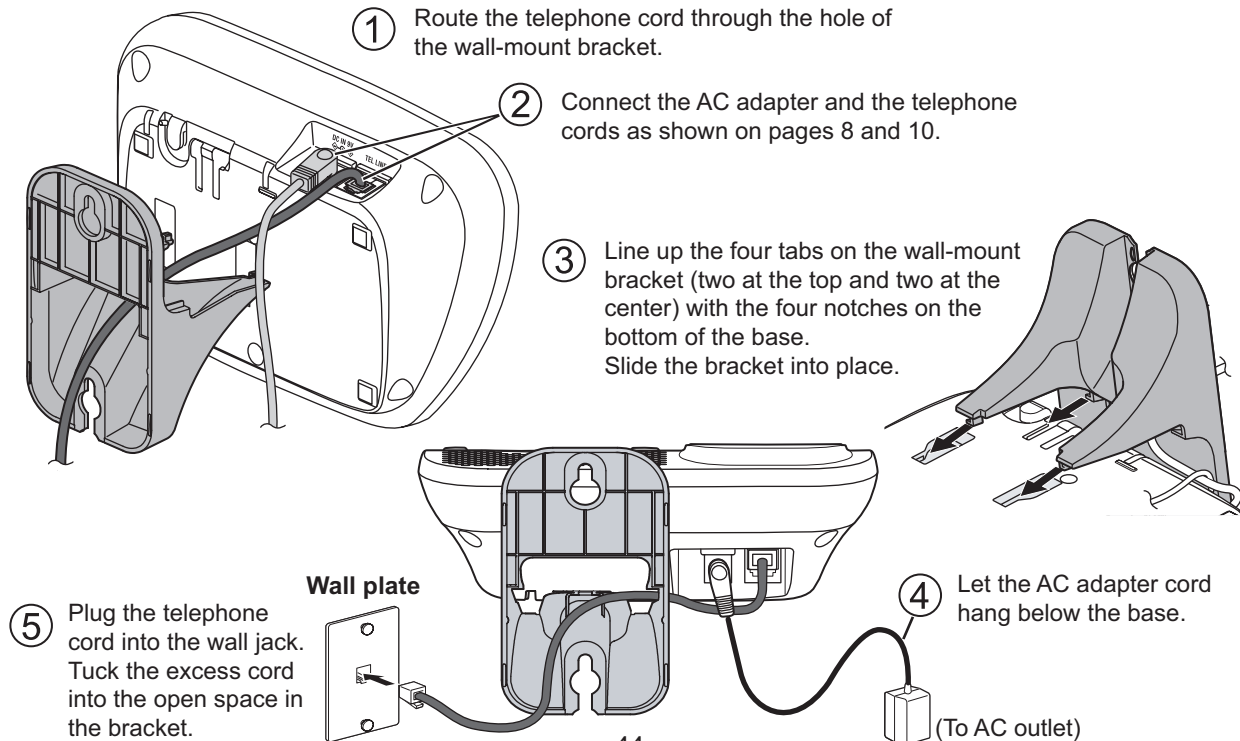

- ⑥ Place the mounting slots over the pins on the wall plate.

- ⑦ Slide the base down to lock it into place.

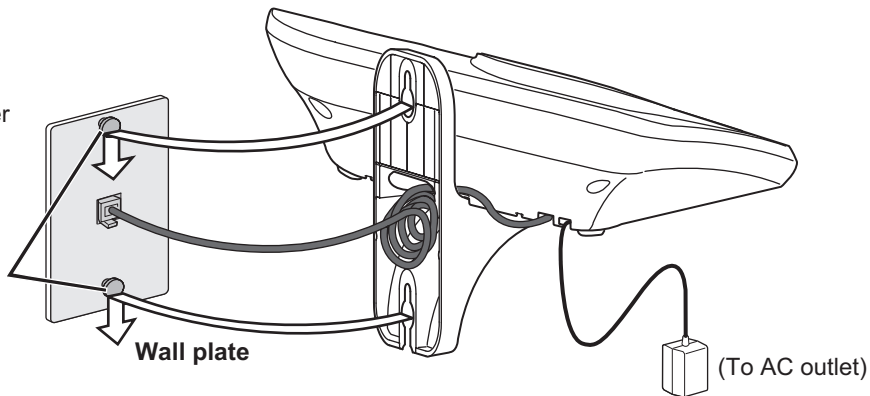

Removing the wall-mount bracket

At the bottom of the base, pinch the two "nose" of the wall-mount bracket as shown, and then slide the bracket away from the base.

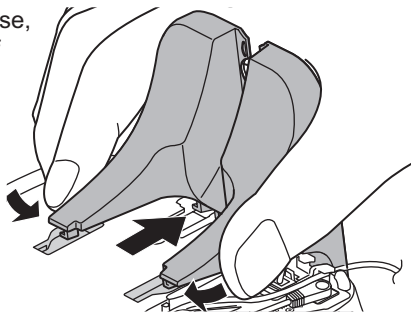

Note: Mounting the phone directly on the wall

- Be sure the wall is capable of supporting the weight of the phone, and use the proper type of anchoring device for the wall material.
- Insert two #10 screws (minimum length of $1 \frac{3}{8}$ inches, not supplied) into the wall, $3 \frac{15}{16}$ inches apart.
- Leave the screw heads $\frac{1}{8}$ inch away from the wall to allow room for mounting the phone.
- Align the mounting slots over the screws and slide the base down into place as shown above.

Maintenance

Specifications

Operating temperature	32° F to 122° F (0° C to 50° C)		
AC adapter		Base	Charging cradle
	Part number	PS-0035	PS-0035
	Input voltage	120V AC, 60 Hz	120V AC, 60 Hz
	Output voltage	8V DC @ 300mA	8V DC @ 300mA
Battery pack	Part number	BT-1007	BT-1015
	Capacity	500mAh, 2.4V DC	or 650mAh 2.4V DC

Notes:

- Use only the supplied AC adapters.
- Be sure to use the proper adapter for the base and any chargers.
- Do not place the power cord where it creates a trip hazard or where it could become chafed and create a fire or electrical hazard.
- Do not place the base in direct sunlight or subject it to high temperatures.

Battery Information

Battery life

With average use, your handset battery provides more than ten hours of talk time and approximately seven days of standby time. You can achieve optimum battery life and performance by returning the handset to the base or charging cradle after each use. When your handset is left off of the cradle, the battery will gradually discharge even if the handset is not being used. The actual talk time duration will be reduced in proportion to the amount of time the handset is off of the cradle.

Low battery alert

When the battery pack is very low, the phone is programmed to eliminate functions in order to save power. When *Low Battery - Charge Handset* appears in the handset display and the phone is in standby, none of the keys will operate. If you are on a call, complete your conversation as quickly as possible, and return the handset to the cradle.

The battery pack needs to be charged when the empty battery icon appears.

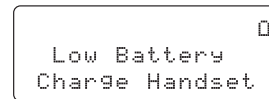

Cleaning the charging contacts

To maintain a good charge, clean the charging contacts on the handset once a month. Dampen a cloth with plain water. Gently rub the damp cloth over the charging contacts until all visible dirt is removed. Dry the contacts thoroughly before returning the handset to the cradle.

Caution: Do not use paint thinner, alcohol, or other chemical products. Doing so may discolor the surface of the telephone and damage the finish.

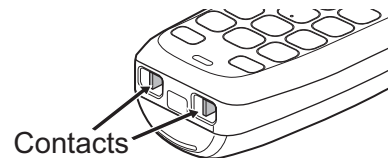

Battery replacement and handling

With average use, your phone's battery should last approximately one year. To order replacement batteries, please contact Uniden's Parts Department. The contact information is listed on the back cover page.

Caution:

- Use only battery pack BT-1007 or BT-1015.
- Do not remove the batteries from the handset to charge them.
- Never throw the battery into a fire, disassemble, or heat them.
- Do not remove or damage the battery casing.

Power Failures

During a power failure, you will not be able to make or receive calls with the phone. To avoid damage from an electrical spike when the power comes back on, we recommend you unplug your phone during power outages.

Troubleshooting

Common Issues

If your phone is not performing to your expectations, please try these simple steps first. If these steps do not solve your problem, please call our Customer Hotline (see the back cover for contact information).

When you have this problem...	Try...
The charge LED won't illuminate when the handset is placed in the cradle.	<ul style="list-style-type: none">• Checking the AC adapter connection (see page 8).• Re-seating the handset in the cradle.
No handsets can make or receive calls.	<ul style="list-style-type: none">• Checking the telephone cord connection. If <i>Check TEL Line</i> appears on the handset display, the telephone cord may not be connected correctly (see page 10).• Disconnecting the base AC adapter. Wait a few minutes, then reconnect it (see page 8).• Changing the dial mode (see page 12).
A single handset can't make or receive calls (but other handsets can).	<ul style="list-style-type: none">• Moving the handset closer to the base.• Resetting the handset (see page 51).
A handset can make calls, but it doesn't ring or receive a page.	<ul style="list-style-type: none">• Making sure the ringer isn't turned off (see page 36).
A handset is not working.	<ul style="list-style-type: none">• Checking the battery pack connection (see page 7).• Charging the battery for 15-20 hours.• Resetting the handset (see page 51).

When you have this problem...	Try...
A handset says Unavailable.	<ul style="list-style-type: none"> • Moving the handset closer to the base. • Seeing if another handset has Privacy Mode turned on (see page 40). • Making sure the base is plugged in (see page 8).
The phone keeps ringing when I answer on an extension.	<ul style="list-style-type: none"> • You may have to change the line mode. Contact customer service for more information (see page 53).
No handsets will display any Caller ID information.	<ul style="list-style-type: none"> • Checking to see if the call was placed through a switchboard. • Asking your telephone company to verify your Caller ID service is current. There may be a problem with your Caller ID service. • Letting incoming calls ring at least twice before answering.
Caller ID displays briefly and then clears.	<ul style="list-style-type: none"> • You may have to change the line mode. Contact customer service for more information (see page 53).
I can't register a handset at the base.	<ul style="list-style-type: none"> • Seeing if you already have 6 handsets registered to this base. • Seeing if you already registered this handset to 4 bases. • Resetting the handset (see page 51).
A handset doesn't communicate with other handsets.	<ul style="list-style-type: none"> • Making sure all handsets are registered to and currently connected to the same base (see pages 14 and 15). • Resetting the problem handsets (see page 51).
I can't transfer calls.	<ul style="list-style-type: none"> • Making sure all handsets are registered to and currently connected to the same base (see pages 14 and 15). • Resetting the problem handsets (see page 51).

When you have this problem...	Try...
I can't get two handsets to talk to an outside caller.	<ul style="list-style-type: none"> • Checking to see that there are not two handsets already using the conference feature (see page 38). • Making sure another handset is not in Privacy Mode (see page 40). • Making sure both handsets are registered to and currently connected to the same base (see pages 14 and 15).
The new message LED (Voice Mail Waiting Indicator) flashes, but there are no new messages.	<ul style="list-style-type: none"> • Resetting the Voice Mail Waiting Indicator (see page 43).

Weak or Hard to Hear Audio

If the caller's voice sounds weak or soft, the signal might be blocked by large metal objects or walls; you might also be too far from the base, or the handset's battery may be weak.

- Try adjusting the volume of the earpiece (see page 36) or the audio tone (see page 37).
- Try moving around while you're on a call or moving closer to the base to see if the sound gets louder.
- Make sure the handset's battery is fully charged.

Noise or Static on the Line

The most common cause of noise or static on a cordless phone is interference: other wireless or electronic devices can radiate energy that disturbs the radio signal between the base and the handset (much like overhead power lines can cause static on your car radio). Some common household sources of interference are

- electrical appliances, especially microwave ovens
- computer equipment, especially wireless LAN equipment and DSL modems
- radio-based wireless devices, such as room monitors, wireless controllers, or wireless headphones or speakers
- large fluorescent light fixtures (particularly ones that give off a "buzzing" noise)
- other services that use your phone line, like alarm systems, intercom systems, or broadband Internet service

<p>For static on only one handset or in a specific location:</p> <ul style="list-style-type: none"> • Check nearby for one of the common interference sources. • Try moving the handset away from a suspected source, or try moving the suspected source so it's not between the handset and the base. 	<p>For static on more than one handset:</p> <ul style="list-style-type: none"> • Check near the base for the source of interference. • Try moving the base away from a suspected source, or try turning off the source if possible. • If you have any services that might use your phone line, see if you need a filter on the phone line.
--	---

Installing a telephone line filter or DSL filter

Any broadband Internet service that uses your telephone line might interfere with standard phones. The most common type of these services, DSL, often causes static on your telephone. Fortunately, an easy-to-install filter removes this static from the line. Technicians who install DSL service usually leave several filters for the customers; if you can't find them, call your DSL provider or look in any electronics store.

Just plug the DSL filter into the telephone wall jack and then plug your phone's base into the filter. Make a test call to make sure the noise is gone.

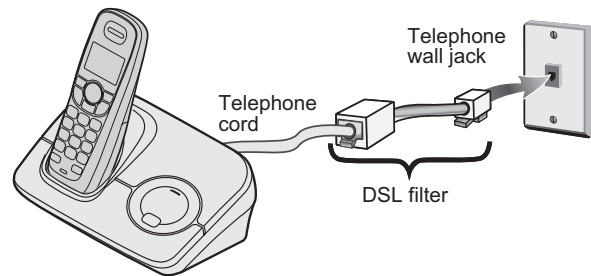

Resetting the Handset

You may need to reset your handset in the following instances:

- You lose a handset and purchase a new one.
- You get the message Registration Failed when you try to register the handset.
- You are unable to register any handsets to the base.
- When you register new handsets to the base, the handset IDs do not match. (For example, the handset registers as "Handset #4" but you only have two handsets.)
- When you are instructed to by one of Uniden's call center representatives.

- 1) Select the base you want to de-register the handset from (see Selecting the base on page 15).
- 2) Press and hold **END** and **#** for more than five seconds. Select *Deregister HS*.
- 3) Select the handset which you are operating, and then press **MENU/SELECT**.
- 4) The phone will ask you to confirm the deregistration. Select Yes. The selected handset will clear its registration information only from the base it is currently connected to, and then delete the link to the base from its own memory.
- 5) When the base information is deleted, the handset displays *Handset not registered-place handset on base to register*. See your Owner's Manual for help.
- 6) Re-register the handset to the base (see Registering accessory handsets on page 13).

If the handset cannot contact the base, it will display *Out Of Range*. Make sure the handset is in range of the base and the base is connected to power; you can also reset the handset without the base (see the next section).

Resetting the Handset Without the Base

If your original base is not available for some reason, you can still reset the handset and use it with another base.

- 1) Press and hold **END** and **#** for at least five seconds.
- 2) Move the cursor to select *Base Unavailable* and then press **MENU/SELECT**.
- 3) Select the base which you want to de-register from, and then press **MENU/SELECT**. *Base Unavailable* appears.
- 4) Move the cursor to select Yes, and then press **MENU/SELECT**. You hear a confirmation tone, and the handset deletes its own base information without contacting the base. If the handset was registered to only one base, it displays *Handset not registered-place handset on base to register*. See your Owner's Manual for help. If the handset is still registered to another base, it searches for the other base and then returns to standby.
- 5) Register the handset to the new base (see Registering accessory handsets on page 13).

Changing the Line Mode for Multiple Extensions

Line mode refers to the method that telephones use to signal each other that an extension is in use. Customer service may recommend changing the line mode if you have any of the following problems:

- Your phone keeps ringing after someone answers on an extension phone.
 - Your answering system doesn't stop recording when you answer on an extension phone.
 - Caller ID displays briefly and then clears.
- 1) If you have multiple bases, select the base that is having problems (see page 15).
 - 2) Press **MENU/SELECT**.
 - 3) Select the *Global Setup* menu, and then the *Set Line Mode* submenu.
 - 4) *If Instructed by Customer Service Press [select]* appears. Press **MENU/SELECT**.
 - 5) Move the cursor to select *Type - A*, *Type - B*, or *Off*.
 - 6) Press **MENU/SELECT**. You will hear a confirmation tone.

Traveling Out of Range

When the handset is in standby, the handset will display *Out Of Range*.

During a call, if you move your handset too far from your base, noise may increase. If you pass the range limit of the base, the handset will beep, display *Out Of Range*, and then go to standby. The base will maintain the connection for thirty seconds after the handset goes out of range. If you move the handset back within range of the base within thirty seconds, press **TALK/FLASH** or **■(▶)** to pick up the call again.

Note: If it is set to automatically select the available base, the handset will begin searching for another base thirty seconds after going out of range. (see *Selecting the base* on page 15).

Liquid Damage

Moisture and liquid can damage your cordless phone.

- If the handset or base is exposed to moisture or liquid, but only the exterior plastic housing is affected, wipe off the liquid, and use as normal.
- If moisture or liquid has entered the plastic housing (i.e. liquid can be heard in the phone or liquid has entered the handset battery compartment or vent openings on the base), follow the steps below. After following these steps, if your cordless telephone does not work, please call our Customer Service Hotline (see the back cover page).

Handset	Base
<ol style="list-style-type: none">1) Remove the battery cover and leave it off for ventilation.2) Disconnect the battery pack. Leave the battery cover off and the battery pack disconnected for at least 3 days.3) Once the handset is completely dry, reconnect the battery pack and the battery cover.4) Recharge the handset's battery pack for 15 to 20 hours before using.	<ol style="list-style-type: none">1) Disconnect the AC adapter from the base, cutting off electrical power.2) Disconnect the telephone cord from the base.3) Let dry for at least 3 days.

IMPORTANT: You must unplug the telephone line while recharging the battery packs to avoid charge interruption.

CAUTION: **DO NOT use a microwave oven to speed up the drying process. This will cause permanent damage to the handset, base and the microwave oven.**

Precautions!

Before you read anything else, please observe the following:

Warning!

Uniden America Corporation DOES NOT represent this unit to be waterproof. To reduce the risk of fire, electrical shock, or damage to the unit, DO NOT expose this unit to rain or moisture.

Rechargeable Nickel-Cadmium Battery Warning

- This equipment contains a rechargeable nickel-cadmium battery.
- The rechargeable batteries contained in this equipment may explode if disposed of in a fire.
- Nickel and Cadmium are a chemical known to state of California to cause cancer.
- Do not short-circuit the battery.
- Do not charge the rechargeable battery pack used in this equipment with in any charger other than the one designed to charge this battery pack as specified in the owner's manual. Using another charger may damage the battery pack or cause the battery pack to explode.

Rechargeable Batteries Must Be Recycled or Disposed of Properly.

Rechargeable Nickel-Cadmium Batteries Must Be Recycled or Disposed of Properly



- Uniden voluntarily participates in an RBRC® industry program to collect and recycle nickel-cadmium batteries at the end of their useful life, when taken out of service within the United States.
- The RBRC® program provides a convenient alternative to placing used nickel-cadmium batteries into the trash or municipal waste stream, which is illegal in some areas.
- Through the RBRC® program, Uniden makes it easy for you to drop off the used battery at local retailers of replacement nickel-cadmium batteries. You may also contact your local recycling center for information on where to return the used battery. Please call 1-800-8-BATTERY for information on Ni-Cd battery recycling in your area. Uniden's involvement in this program is part of its commitment to protecting our environment and conserving natural resources.
- RBRC® is a registered trademark of the Rechargeable Battery Recycling Corporation.

Uniden works to reduce lead content in our PVC coated cords in our products and accessories.

Warning!

The cords on this product and/or accessories contain lead, a chemical known to the State of California to cause birth defects or other reproductive harm. Wash hands after handling.

Important Safety Instructions

When using your telephone equipment, basic safety precautions should always be followed to reduce the risk of fire, electric shock and injury to persons, including the following:

1. Do not use this product near water, for example, near a bath tub, wash bowl, kitchen sink or laundry tub, in a wet basement or near a swimming pool.
2. Avoid using a telephone (other than a cordless type) during an electrical storm. There may be a remote risk of electric shock from lightning.
3. Do not use the telephone to report a gas leak in the vicinity of the leak.
4. Use only the power cord and batteries indicated in this manual. Do not dispose of batteries in a fire. They may explode. Check with local authorities for possible battery disposal instructions.
5. Do not disassemble any component of this product.

SAVE THESE INSTRUCTIONS

CAUTION

Risk of explosion if battery is replaced by an incorrect type. Dispose of used batteries according to the instructions. Do not open or mutilate the battery, and disconnect the battery before shipping this product.

The FCC Wants You To Know

This equipment complies with Part 68 of the FCC rules and the requirements adopted by the ACTA. On the bottom of this equipment is a label that contains, among other information, a product identifier in the format US:AAAEQ##TXXXX. If requested, this number must be provided to the telephone company.

An applicable Universal Service Order Codes (USOC) certification for the jacks used in this equipment is provided (i.e., RJ11C) in the packaging with each piece of approved terminal equipment. A plug and jack used to connect this equipment to the premises wiring and telephone network must comply with the applicable FCC Part 68 rules and requirements adopted by the ACTA. A compliant telephone cord and modular plug is provided with this product. It is designed to be connected to a compatible modular jack that is also compliant. See installation instructions for details.

The REN is used to determine the number of devices that may be connected to a telephone line. Excessive RENs on a telephone line may result in the devices not ringing in response to an incoming call. In most but not all areas, the sum of RENs should not exceed five (5.0). To be certain of the number of devices that may be connected to a line, as determined by the total RENs, contact the telephone provider. For products approved after July 23, 2001, the REN for this product is part of the product identifier that has the format US:AAAEQ##TXXXX. The digits represented by ## are the REN without a decimal point (e.g., 03 is a REN of 0.3). For earlier products, the REN is separately shown on the label.

If this equipment causes harm to the telephone network, the telephone company will notify you in advance that temporary discontinuance of service may be required. But if advance notice isn't practical, the telephone company will notify the customer as soon as possible. Also, you will be advised of your right to file a complaint with the FCC if you believe it is necessary. The telephone

company may make changes in its facilities, equipment, operations or procedures that could affect the operation of the equipment. If this happens the telephone company will provide advance notice in order for you to make necessary modifications to maintain uninterrupted service.

Please follow instructions for repairing, if any (e.g. battery replacement section); otherwise do not substitute or repair any parts of the device except as specified in this manual. Connection to party line service is subject to state tariffs. Contact the state public utility commission, public service commission or corporation commission for information. This equipment is hearing aid compatible.

Should you experience trouble with this equipment, please contact Uniden customer service at 800-297-1023. If the equipment is causing harm to the telephone network, the telephone company may request that you disconnect the equipment until the problem is resolved.

NOTICE: According to telephone company reports, AC electrical surges, typically resulting from lightning strikes, are very destructive to telephone equipment connected to AC power sources. To minimize damage from these types of surges, a surge arrester is recommended.

Changes or modifications to this product not expressly approved by Uniden, or operation of this product in any way other than as detailed by the owner's manual, could void your authority to operate this product.

This device complies with part 15 of the FCC rules. Operation is subject to the following two conditions: (1) This device may not cause harmful interference, and (2) This device must accept any interference received, including interference that may cause undesired operation. Privacy of communications may not be ensured when using this phone.

To insure the safety of users, the FCC has established criteria for the amount of radio frequency energy various products may produce depending on their intended usage. This product has been tested and found to comply with the FCC's exposure criteria. For body worn operation, the FCC RF exposure guidelines were also met when used with the Uniden accessories supplied or designed for this product. Use of other accessories may not ensure compliance with FCC RF exposure guidelines and should be avoided.

The antenna(s) used for the base-unit must be installed to provide a separation distance of at least 20 cm from all persons and must not be collocated or operated in conjunction with any other antenna or transmitter.

If your home has wired alarm equipment connected to a phone line, be sure that installing the system does not disable your alarm equipment. If you have questions about what will disable alarm equipment, contact your telephone company or a qualified installer.

Note: This equipment has been tested and found to comply with the limits for a Class B digital device, pursuant to part 15 of the FCC Rules. These limits are designed to provide reasonable protection against harmful interference in a residential installation. This equipment generates, uses and can radiate radio frequency energy and, if not installed and used in accordance with the instructions, may cause harmful interference to radio communications. However, there is no guarantee that interference will not occur in a particular installation. If this equipment does cause harmful interference to radio or television reception, which can be determined by turning the equipment off and on, the user is encouraged to try to correct the interference by one or more of the following measures:

--Reorient or relocate the receiving antenna.

--Increase the separation between the equipment and receiver.

- Connect the equipment into an outlet on a circuit different from that to which the receiver is connected.
- Consult the dealer or an experienced radio/TV technician for help.

Radio interference

Radio interference may occasionally cause buzzing and humming in your cordless handset, or clicking noises in the base. This interference is caused by external sources such as TV, refrigerator, vacuum cleaner, fluorescent lighting, or electrical storm. Your unit is NOT DEFECTIVE. If these noises continue and are too distracting, please check around your home to see what appliances may be causing the problem. In addition, we recommend that the base not be plugged into a circuit that also powers a major appliance because of the potential for interference. In the unlikely event that you consistently hear other voices or distracting transmissions on your phone, you may be receiving radio signals from another cordless telephone or other source of interference.

Finally, it should be noted that some cordless telephones operate at frequencies that may cause interference to nearby TVs and VCRs. To minimize or prevent such interference, the base of the cordless telephone should not be placed near or on top of a TV or VCR. If interference is experienced, moving the cordless telephone farther away from the TV or VCR will often reduce or eliminate the interference.

Cordless telephone privacy

Cordless telephones are radio devices. Communications between the handset and base of your cordless telephone are accomplished by means of radio waves which are broadcast over the open airways. Because of the inherent physical properties of radio waves, your communications can be received by radio receiving devices other than your own cordless telephone unit. Consequently, any communications using your cordless telephone may not be private.

I.C. Notice

Terminal equipment

NOTICE: This equipment meets the applicable Industry Canada Terminal Equipment Technical Specifications. This is confirmed by the registration number. The abbreviation, IC, before the registration number signifies that registration was performed based on a Declaration of Conformity indicating that Industry Canada technical specifications were met. It does not imply that Industry Canada approved the equipment.

NOTICE: The Ringer Equivalence Number (REN) for this terminal equipment is marked on the equipment itself. The REN assigned to each terminal equipment provides an indication of the maximum number of terminals allowed to be connected to a telephone interface. The termination on an interface may consist of any combination of devices subject only to the requirement that the sum of the Ringer Equivalence Numbers of all the devices does not exceed five.

Radio equipment

The term "IC:" before the radio certification number only signifies that Industry Canada technical specifications were met.

Operation is subject to the following two conditions: (1) this device may not cause interference, and (2) this device must accept any interference, including interference that may cause undesired operation of the device. "Privacy of communications may not be ensured when using this telephone."

One Year Limited Warranty

Important: Evidence of original purchase is required for warranty service. **WARRANTOR:** UNIDEN AMERICA CORPORATION ("Uniden") **ELEMENTS OF WARRANTY:** Uniden warrants, for one year, to the original retail owner, this Uniden Product to be free from defects in materials and craftsmanship with only the limitations or exclusions set out below. **WARRANTY DURATION:** This warranty to the original user shall terminate and be of no further effect 12 months after the date of original retail sale. The warranty is invalid if the Product is (A) damaged or not maintained as reasonable or necessary, (B) modified, altered, or used as part of any conversion kits, subassemblies, or any configurations not sold by Uniden, (C) improperly installed, (D) serviced or repaired by someone other than an authorized Uniden service center for a defect or malfunction covered by this warranty, (E)

used in any conjunction with equipment or parts or as part of any system not manufactured by Uniden, or (F) installed or programmed by anyone other than as detailed by the owner's manual for this product. **STATEMENT OF REMEDY:** In the event that the product does not conform to this warranty at any time while this warranty is in effect, warrantor will either, at its option, repair or replace the defective unit and return it to you without charge for parts, service, or any other cost (except shipping and handling) incurred by warrantor or its representatives in connection with the performance of this warranty. Warrantor, at its option, may replace the unit with a new or refurbished unit. **THE LIMITED WARRANTY SET FORTH ABOVE IS THE SOLE AND ENTIRE WARRANTY PERTAINING TO THE PRODUCT AND IS IN LIEU OF AND EXCLUDES ALL OTHER WARRANTIES OF ANY NATURE WHATSOEVER, WHETHER EXPRESS, IMPLIED OR ARISING BY OPERATION OF LAW, INCLUDING, BUT NOT LIMITED TO ANY IMPLIED WARRANTIES OF MERCHANTABILITY OR FITNESS FOR**

A PARTICULAR PURPOSE. THIS WARRANTY DOES NOT COVER OR PROVIDE FOR THE REIMBURSEMENT OR PAYMENT OF INCIDENTAL OR CONSEQUENTIAL DAMAGES.

Some states do not allow this exclusion or limitation of incidental or consequential damages so the above limitation or exclusion may not apply to you.

LEGAL REMEDIES: This warranty gives you specific legal rights, and you may also have other rights which vary from state to state. This warranty is void outside the United States of America and Canada. **PROCEDURE FOR OBTAINING PERFORMANCE OF WARRANTY:** If, after following the instructions in the owner's manual you are certain that the Product is defective, pack the Product carefully (preferably in its original packaging). Disconnect the battery from the Product and separately secure the battery in its own separate packaging within the shipping carton. The Product should include all parts and accessories originally packaged with the Product. Include evidence of original purchase and a note describing the defect that has caused you to return it. The Product should be shipped freight prepaid, by traceable means, to warrantor at:

Uniden America Service

4700 Amon Carter Blvd.
Fort Worth, TX 76155

Index

A

Accessibility	5
Accessory handsets	13
Answering calls.....	31
Any key answer	30
Area code	34
Audio tone	37
AutoTalk.....	30

B

Banner	29
--------------	----

Base

Installing	8
Multiple bases	14
Parts of the base	19
Wall mounting	44

Battery

Battery life	46
Installing.....	7
Low battery alert.....	47
Replacement and handling	47

C

Caller ID.....	33
Deleting Caller ID records	34

Making calls from	33
Call waiting	35
Chain dialing.....	32
Conferencing	38

D

Dial mode	12, 41
-----------------	--------

F

FCC statements.....	56
Finding a handset.....	38
Four-way function key	21

H

Handset

Accessory handsets	13
Banner.....	29
Choosing a ringer.....	29
Copying phonebook entries	28
Entering text.....	22
Finding	38
Parts of the handset.....	18
Reading the display.....	20
Registering.....	13, 14
Resetting	51, 52
Hanging up	31
Hold	38

I

Installation	6
Intercom.....	40

K

Key touch tone.....	24
---------------------	----

L

Language.....	23
Line mode for base.....	53
Liquid damage	54
Low battery alert.....	47

M

Maintenance.....	46
Making calls.....	31
Using Caller ID	33
Using redial	35
Using the phonebook	32
Multiple bases.....	14
Mute	
Microphone	41
Ringer.....	36

N

Noise	50
-------------	----

O	
Out of range.....	53
P	
Personal ring	24
Phonebook	25
Copying entries	28
Creating new entries	25
Deleting entries	27, 28
Editing entries	26
Finding entries.....	26
Making a call from	32
Storing Caller ID or redial numbers	27
Privacy mode.....	40
Pulse dialing	12, 41
R	
Redial	
Deleting a record.....	35
Making a calls with.....	35
Ringer	
Choosing a handset ringer.....	29
Muting	36
Personal ring	24
Volume	36
S	
Safety notices	56
Selecting the base	15
Seven-digit dialing	34
Static.....	50
T	
Text, entering	22
Tone dialing	12, 41
Transferring a call	39
Troubleshooting.....	48
V	
Voice mail	42
Programming.....	43
Tone	42
Waiting indicator reset.....	43
Volume, adjusting	36
W	
Wall mounting the base	44
Warranty	59

Memo

Memo



VISIT OUR WEBSITE AT
WWW.UNIDEN.COM IF YOU...

- ...HAVE A QUESTION OR A PROBLEM.
Or call our Customer Hotline at 1-817-858-2929 or 1-800-297-1023 during regular business hours.*
- ...ARE LOOKING FOR A PART OR ACCESSORY.
Or call our Parts Department at 1-800-554-3988 during regular business hours.*
- ...NEED SPECIAL ASSISTANCE DUE TO A DISABILITY.
Or call our Accessibility help line at 1-800-874-9314 (voice or TTY).

Free Manuals Download Website

<http://myh66.com>

<http://usermanuals.us>

<http://www.somanuals.com>

<http://www.4manuals.cc>

<http://www.manual-lib.com>

<http://www.404manual.com>

<http://www.luxmanual.com>

<http://aubethermostatmanual.com>

Golf course search by state

<http://golfingnear.com>

Email search by domain

<http://emailbydomain.com>

Auto manuals search

<http://auto.somanuals.com>

TV manuals search

<http://tv.somanuals.com>