

Uniden®

DXAI 5188-2

SERIES

OWNER'S

MANUAL

OWNER'S MANUAL

Contents

Welcome/Features	4	Storing and Editing the RocketDial	31
Controls and Functions	5	Making Calls with the RocketDial	31
Getting Started		Deleting the RocketDial	32
Installing the Phone	7	Caller ID Features	
Mounting the Main Base Unit on a Wall	12	Caller ID and CIDCW (Caller ID on Call Waiting)	33
Register Handsets to the Main Base Before Using!	14	When the Telephone Rings	33
When to Re-register Handsets	15	Viewing the Caller ID Message List	34
Call Transfer Feature	15	Deleting Information from the Caller ID List	35
Setting Menu Display Options	16	Making a Call from the Caller ID List	37
Basics		Storing Caller ID Messages in Memory Dialing	38
Making and Receiving Calls	19	The Integrated Answering Device	
Adjusting the Handset Ringer and Earpiece Volume	20	The Integrated Answering Device	39
Tone Dialing Switch Over	21	Features	39
Traveling Out-of-Range	21	Turning the Answering System On/Off	40
Selecting a Different Channel	22	Setting Up Your Answering System	41
Find Handsets	22	Using Your Answering System	49
Using Call Waiting	22	Additional Information	
Memory Dialing		Changing the Digital Security Code	56
Storing Phone Numbers and Names in Speed Dial Memory	23	Installing the Beltclip	56
Steps for Entering Names and Special Characters	25	Headset Installation	57
Making Calls from Speed Dial Memory	26	Note on Power Sources	57
Chain Dialing	27	Maintenance	57
Editing a Stored Name and/or Phone Number	28	Troubleshooting	58
Erasing a Stored Name and Phone Number	30	General Information	63
RocketDial		Precautions & Warranty	64
RocketDial	31	I.C. Notice	66
		Index	67

Welcome

Congratulations on your purchase of the Uniden dual handset cordless telephone. This cordless phone is designed and engineered to exacting standards for reliability, long life, and outstanding performance.

Note: Some illustrations in this manual may differ from the actual unit for explanation purposes. The color of your cordless telephone may vary.

Features

- 5.8 GHz Extended Range Technology
- Dual Handset System
(Extra Handset & Charger Included)
- Integrated Telephone Answering Device (ITAD) (Trilingual Announcement Option)
- Voice Prompted ITAD Setup Menu
- 3 Line Backlit Display
- Caller ID/Caller ID on Call Waiting
- 30 Caller ID Memory Locations
- 10 Speed Dial Memory
- One-Touch RocketDial
- Call Transfer from Handset to Handset
- Find handset Locator
- Earpiece Volume Control
- Ringer Levels (High-Low-Off)
- Hearing Aid Compatible
- Desk or Wall Mountable

Be sure to visit our web site: www.uniden.com

Uniden® and RocketDial® are registered trademarks of Uniden America Corporation. AutoTalk, AutoStandby, UltraClear Plus, Random Code and AutoSecure are trademarks of Uniden America Corporation.

Controls and Functions

Handsets

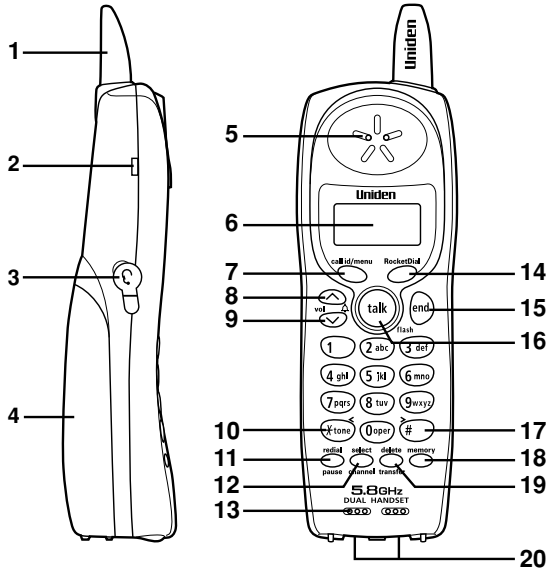

1. Handset antenna
2. Beltclip hole
3. Jack for optional headset
4. Handset battery compartment
5. Handset earpiece
6. LCD display
7. call id (Caller ID)/menu key
8. vol/ Δ / \wedge (volume & scroll) key
9. vol/ Δ / \vee (volume & scroll) key
10. * /tone/ \leftarrow (left cursor) key
11. redial/pause key
12. select/channel key
13. Handset microphone and ringer speaker
14. RocketDial key
15. end key
16. talk/flash key
17. #/ \rightarrow (right cursor) key
18. memory key
19. delete/transfer key
20. Handset charging contacts

Main Base Unit

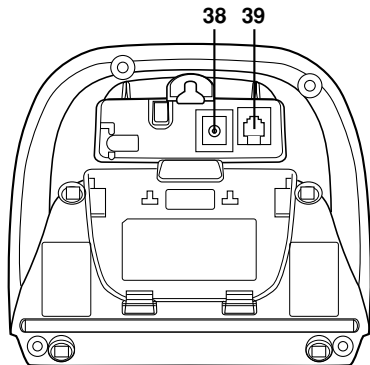
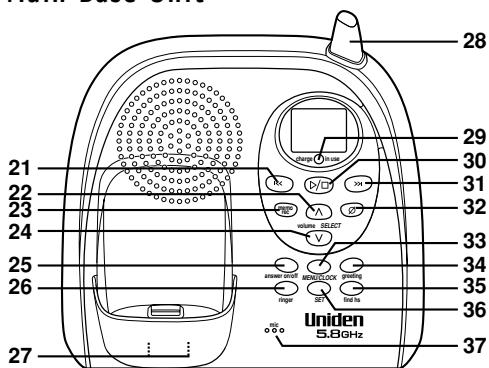

21. <<< (repeat/rewind) key
22. volume/SELECT ^ (up) key
23. memo/rec (record) key
24. volume/SELECT v (down) key
25. answer on/off key
26. ringer key
27. Base charging contacts
28. Base antenna
29. charge/in use LED
30. >| (play/stop) key
31. >>| (skip/fast forward) key
32. ∅ (delete) key
33. MENU/CLOCK key
34. greeting key
35. find hs key
36. SET key
37. mic (microphone)
38. DC IN 9V jack
39. Telephone line jack
40. Charging contacts
41. Charge LED
42. DC IN 9V jack

Extra Charging Cradle (for Second Handset)

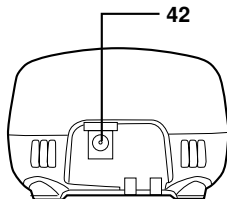
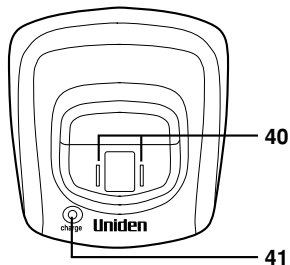

Installing the Phone

Do the following steps:

- A. Choose the best location
- B. Install the rechargeable battery packs into both handsets
- C. Connect the main base unit and charging cradle

A. Choose the best location

When choosing a location for your new phone, here are some important guidelines you should consider:

Avoid heat sources, such as radiators, air ducts, and sunlight

Avoid television sets and other electronic equipment

Choose a central location

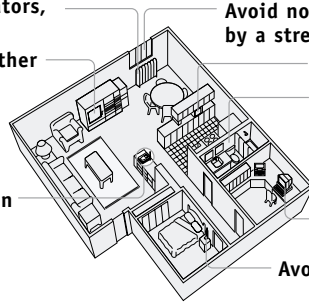

Avoid noise sources such as a window by a street with heavy traffic

Avoid microwave ovens

Avoid excessive moisture, extremely low temperatures, dust, mechanical vibration, or shock

Avoid personal computers

Avoid other cordless telephones

- The location should be close to both a phone jack and a continuous power outlet (one which is not connected to a switch).
- The handsets and the main base should be kept away from sources of electrical noise such as motors, microwave ovens, and fluorescent lighting.
- The base can be placed on a desk, tabletop, or mounted on a standard wall plate.



If your home has specially wired alarm equipment connected to the telephone line, be sure that installing the system does not disable your alarm equipment.

If you have questions about what will disable your alarm equipment, contact your telephone company or a qualified installer.



- For optimum performance use only the Uniden BT-800 rechargeable battery pack supplied with your phone.
- Replacement batteries are also available through the Uniden Parts Department at (800) 554-3988, Monday through Friday from 8:00 a.m. to 5:00 p.m. or online at www.uniden.com

B. Install the rechargeable battery packs into both handsets

Both handsets are powered by a rechargeable battery packs. The battery recharges automatically when the handset is placed in the main base unit or charging cradle.

- 1) Press down on the handset battery case cover (use the finger indentation for a better grip) and slide the cover downward to remove.
- 2) Plug the battery pack connector (red & black wires) into the jack inside the battery compartment. (The connector notches fit into the grooves of the jack only one way.) Match the wire colors to the polarity label in the battery compartment, connect the battery, and listen for a click to insure connection.
- 3) Make sure you have a good connection by slightly pulling on the battery wires. If the connection is secure, the battery jack will remain in place.
- 4) Place the battery case cover back on the handset by sliding it upwards until it clicks into place.

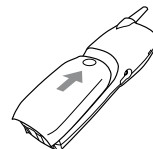
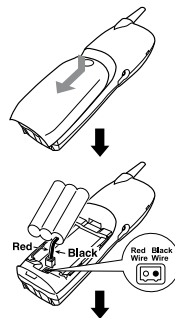

Low battery alert

When the battery pack is very low and needs to be charged, the phone is programmed to eliminate functions in order to save power. If the phone is not in use, **Low Battery** flashes on the LCD and none of the keys will operate. If the phone is in use, **Low Battery** flashes and the handset beeps. Complete your call as quickly as possible and return the handset to either cradle for charging.

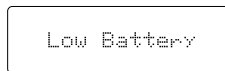

The last number dialed in the redial memory, the Menu display options, the names and the numbers stored in the memory locations or CID list are retained for up to 30 minutes while you replace the battery pack.

Cleaning the battery charging contacts

To maintain a good charge, it is important to clean the charging contacts on the handsets, main base unit and charging cradle once a month. Using water only, dampen a cloth to clean the charging contacts. Then make sure to go back over the charging contacts with a dry cloth before returning the handsets to the main base unit or charging cradle to charge.

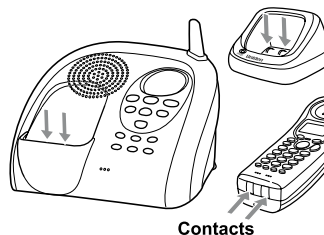

Do not use paint thinner, benzene, alcohol, or other chemical products. Doing so may discolor the surface of the telephone and damage the finish.



- Even when the battery pack is not being used, it will gradually discharge over a long period of time. For optimum performance, be sure to return the handset to either cradle after a telephone call.
- **Talk Mode** - The handset is off either cradle and the **talk/flash** key has been pressed, enabling a dial tone.
- **Standby Mode** - The handset may be sitting in or off either charging cradle but is NOT in use. The **talk/flash** key has not been pressed and there is no dial tone.



Use only the supplied AD-314 AC adapter for the main base and AD-310 for the charging cradle. Do not use any other AC adapter.

C. Connect the main base unit and charging cradle

- 1) Connect each AC adapter to the **DC IN 9V** jack and to each standard 120V AC wall outlet.
- 2) Place one handset in the main base unit and the other in the charging cradle.
- 3) Make sure that the **charge/in use** and **charge** LED illuminate. If the LED does not illuminate, check to see that the AC adapter is plugged in and that the handset makes good contact with the cradle's charging contacts.
- 4) Place the handset in the main base unit and one handset in the charging cradle for 15-20 hours without interruption. The main base or charging cradle unit's LED light (labeled **charge/in use** or **charge**) illuminates once the handset is placed in the main base or charging cradle. The LED light will illuminate whether the battery pack is connected or not.

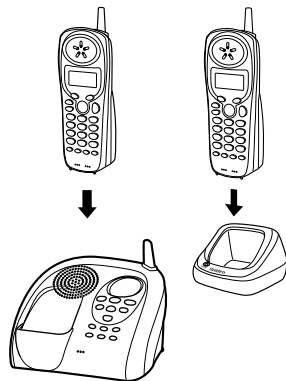
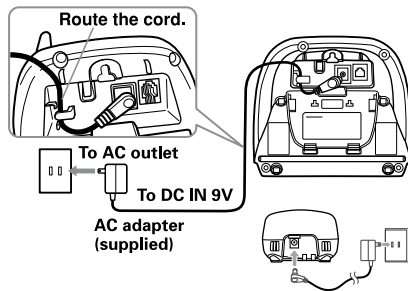

If the main base **charge/in use** or charging cradle **charge** LED light does not illuminate:

- Check to see if the AC adapter is plugged into both cradles and the electrical wall outlet properly. (Use only the supplied AC adapters. Do not use any other AC adapters.)
- Check to see if both handsets are sitting correctly in each cradle and making good contact with each cradles charging contacts.

- 5) Once the handset battery pack is fully charged, connect the telephone line cord to the **TEL LINE** jack and to a telephone outlet.



If your telephone outlet isn't modular, contact your telephone company for assistance.



Modular

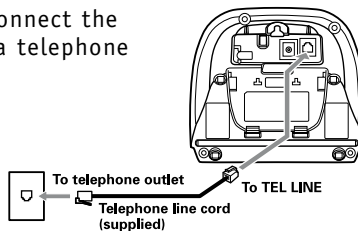

- Place the handsets in the main base and charging cradle with the keypad facing forward for charging.
- Place the power cord where it does not create a trip hazard or where it could become chafed and create a fire or electrical hazard.



DO NOT use an AC outlet controlled by a wall switch.

Mounting the Main Base Unit on a Wall

Standard wall plate mounting

This phone can be mounted on any standard wall plate.

- 1) Snap the wall mount adapter into the notches on the bottom of the base.
- 2) Plug the AC adapter into the **DC IN 9V** jack.
- 3) Wrap the AC adapter cord inside the molded wiring channel as shown.
- 4) Plug the AC adapter into a standard 120V AC wall outlet.
- 5) Plug the telephone line cord into the **TEL LINE** jack. Wrap the cord inside the molded wiring channel as shown.
- 6) Plug the telephone line cord into the telephone outlet.
- 7) Align the mounting slots on the base with the mounting posts on the wall. Then push in and down until the phone is firmly seated.

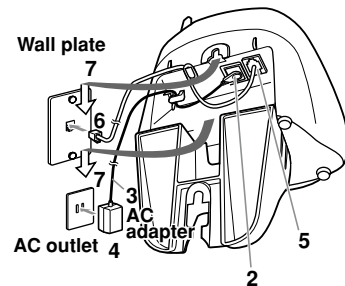
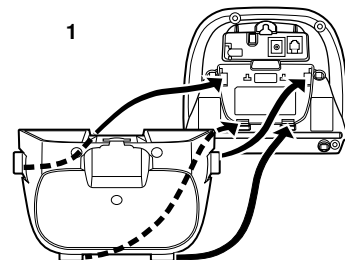

Direct wall mounting

If you don't have a standard wall plate, you can mount your phone directly to the wall. Before doing this, consider the following:

- Avoid electrical cables, pipes, or other items behind the mounting location that could cause a hazard when inserting screws into the wall.
- Try to mount your phone within 5 feet of a working phone jack to avoid excessive lengths.
- Make sure the wall material is capable of supporting the weight of the base and handset.
- Use #10 screws (minimum length of 1-3/8 inches) with anchoring devices suitable for the wall material where the main base unit will be placed.

1) Insert two mounting screws into the wall (with their appropriate anchoring device), 3-15/16 inches apart.

Allow about 1/8 of an inch between the wall and screw heads for mounting the phone.

2) Refer to steps 1 through 7 on page 12 to mount the telephone.

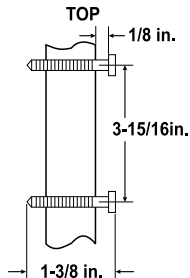



- When you charge the handsets, Caller ID summary screen and the name of the handset, **HS1** appears. If **HS2** appears, you are charging the handset No. 2.

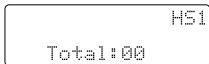

- The charging cradle can be used to charge either handset.

Register Handsets to the Main Base Before Using!

Whichever handset you choose to charge in the main base will automatically register to the base.

The second handset (charging in the extra charging cradle) **MUST** also be registered to the main base before use. Follow the steps below to register the second handset.

- 1) Be sure both handsets are fully charged.
- 2) Remove the handset from the charging cradle, and place it in the main base. The **charge/in use** LED light on the main base will begin to flash, indicating that the registration is taking place.
- 3) Wait for at least 5 seconds before removing the handset from the main base.
- 4) Once both handsets are registered, it doesn't matter which handset is placed in the main base or the charging cradle.

When to Re-register Handsets

You'll need to re-register the handsets if any of the following things occur. Follow steps on page 14 to re-register the handset.

- 1) Each time the digital security code is changed, you will need to re-register the second handset. Refer to page 56 for details regarding the Digital Security Code.
- 2) When the main base is without power for more than 30 minutes, both handsets will need to be re-registered.
- 3) If the second handset's battery becomes very low, the handset must be recharged for 15-20 hours and re-registered to the main base unit.

Call Transfer Feature

Your cordless phone allows you to transfer outside calls from handset to handset, only one handset at a time can talk with an outside caller. The second handset cannot go off hook to listen to conversations or make an outgoing call while the other handset is in use.

To transfer a call

- 1) During a call, press **delete/transfer**. The call will automatically be placed on hold and the transfer tone sounds.
- 2) When the other handset receives the call, the transfer tone stops.
To cancel the transfer and return to the caller, press **delete/transfer** or **talk/flash** on the handset.



Hold
Transfer Call

To receive a transfer call (from the second handset)

Pick up the handset from the base (when AutoTalk is set to on), or pick up the handset and press **talk/flash** to answer the transferred call. Additionally, you can answer the transferred call by pressing any number key, *** /tone/ < or #/ >** (when AutoTalk is set to on).



Transfer Call



note

- Make sure to return the handsets to the charging cradles after each phone call.
- If you transfer the call and it is not picked up after 5 minutes, the call will be disconnected.



The cordless phone features include **AutoTalk™** and **AutoStandby™**. AutoStandby allows you to hang up by simply returning the handset to the main base or charging cradle.

Setting Menu Display Options

There are five setup options, AutoTalk, CIDCW (Caller ID on Call Waiting), Area Code, Dial Mode and Language.

CIDCW and Dial Mode options can only be set by using Handset 1. If you try to set by using Handset 2, you will not see these options listed on the LCD screen. (Handset 1 shows H51 in the display while the phone is charging.)

Setting AutoTalk and CIDCW

- 1) Press and hold **call id/menu**. The following screen appears.
- 2) Use **vol/ Δ / ^** or **vol/ Δ / v** to move the pointer to the selection that you would like to change.
Press **select/channel** to toggle between On and Off.
- 3) Press **end** and return the handset to the main base unit to complete the setting. The handset returns to standby mode.

▶ Auto Talk	: Off
Area Code	:
Language	: Eng

▶ Auto Talk	: Off
CIDCW	: On
Area Code	:

AutoTalk allows you to answer the phone without pressing the **talk/flash** key. If the phone rings when AutoTalk is on, simply remove the handset from either charging cradle and the phone automatically answers the call. If the phone rings when AutoTalk is off, you must press **talk/flash** to answer the call.

Entering your Area Code

If you enter a 3-digit area code number in the Area Code option, your local area code does not appear in Caller ID messages. Do not program this option if your calling area requires 10-digit dialing. When reviewing Caller ID messages, you will see only the local seven digit number. For calls received from outside your local area code, you will see a full 10-digit number.

1) When the phone is in standby mode, press and hold **call id/menu**. The following screen appears.

```

Auto Talk  :Off
CIDCW     :On
Area Code  :
  
```

2) Press **vol/ ▲ / ▼** to move the pointer to Area Code.

```

Auto Talk  :Off
CIDCW     :On
▸Area Code :
  
```

3) Press **select/channel**. If an area code has been already stored, the phone displays it.

```

Auto Talk  :Off
CIDCW     :On
▸Area Code : █
  
```

4) Use the number keys (**0 - 9**) to enter a 3-digit area code. To change a previously-entered area code, use the **delete/transfer** to backspace.

5) Press **select/channel**. A confirmation tone sounds and the displayed area code is entered.

6) Press **end** to complete the setting. The handset returns to standby mode.

Choosing the dialing mode

Most phone systems use tone dialing. However, some phone systems (such as those in rural areas) still use pulse dialing. Your Uniden phone supports both tone and pulse dialing. The default setting is tone dialing. If your dialing system uses pulse dialing, follow the steps below to change the dialing mode:



- If you are not sure of your dialing system, set for tone dialing and make a trial call. If the call connects, leave the setting as is. Otherwise, set for pulse dialing.
- If your phone system requires pulse dialing and you need to send the DTMF tones during a call, you can temporarily switch over to tone dialing. (Refer to "Tone Dialing Switch Over" on page 21.)

- 1) Be sure you are using handset 1. Handset 1 shows H51 in its display while the phone is charging.
- 2) When the phone is in standby mode, press and hold **call id/menu**. The following screen appears.
- 3) Press **vol/ Δ/ ∇** three times to select Dial.
- 4) Press **select/channel** to set the phone to Pulse dialing.
- 5) Press **end** and return the handset to the main base unit to complete the setting. The handset returns to standby mode.

```
▶Auto Talk :Off
CIDCW      :On
Area Code  :
```

```
CIDCW      :On
Area Code  :
▶Dial      :Tone
```

Setting the language

There are three languages to choose from; English, French and Spanish.

- 1) When the phone is in standby mode, press and hold **call id/menu**. The following screen appears.
- 2) Use **vol/ Δ/ ∇** to move the pointer to Language.
- 3) Press **select/channel** to select Eng, Fr. or Esp.
- 4) Press **end** or return the handset to the main base unit or charging cradle to complete the setting. The handset returns to standby mode.

```
▶Auto Talk :Off
CIDCW      :On
Area Code  :
```

```
Area Code  :
Dial       :Tone
▶Language  :Eng
```

Making and Receiving Calls

	Handset on Main Base or Charging Cradle	Handset off Main Base or Charging Cradle
Receiving a call	Remove the handset (AutoTalk: on) or remove the handset and press talk/flash (AutoTalk: off).	Press talk/flash (AutoTalk: off), or press talk/flash , * /tone/ < , #/ > or any number key (AutoTalk: on).
Making a call	<ol style="list-style-type: none"> 1) Remove the handset. 2) Press talk/flash. 3) Listen for the dial tone. 4) Dial the number. <p style="text-align: center;">OR</p> <ol style="list-style-type: none"> 1) Remove the handset. 2) Dial the number, then press talk/flash. 	<ol style="list-style-type: none"> 1) Press talk/flash. 2) Listen for the dial tone. 3) Dial the number. <p style="text-align: center;">OR</p> <p>Dial the number, then press talk/flash.</p>
Hanging up	Press end or return the handset to the main base or charging cradle (AutoStandby).	
Redialing	<ol style="list-style-type: none"> 1) Remove the handset. 2) Press talk/flash. 3) Listen for the dial tone. 4) Press redial/pause. <p style="text-align: center;">OR</p> <ol style="list-style-type: none"> 1) Remove the handset. 2) Press redial/pause, then press talk/flash. 	<ol style="list-style-type: none"> 1) Press talk/flash. 2) Listen for the dial tone. 3) Press redial/pause. <p style="text-align: center;">OR</p> <p>Press redial/pause, then press talk/flash.</p>



Refer to page 16 "Setting Menu Display Options" to turn On the AutoTalk feature if desired.

Adjusting the Handset Ringer and Earpiece Volume

Handset ringer tone and volume

Press the volume up key or volume down key (labeled as *vol/▲/▲* or *vol/▲/▼*) in standby mode to select one of five ringer tone/volume combinations.

Earpiece volume

To change the earpiece volume, press *vol/▲/▲* or *vol/▲/▼* keys during a call. This setting will remain in effect after the telephone call has ended.

Temporarily Mute Ringer

If the handset is off the base, simply press *end* to temporarily mute the incoming ring. The ringer will sound with the next incoming call.

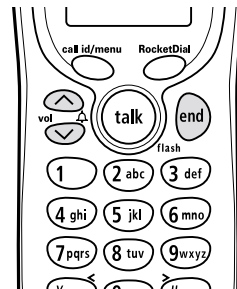

Tone Dialing Switch Over

If your telephone company requires pulse dialing, you can switch over to tone dialing after the call connects. This feature is useful when you need tone dialing to use automated systems, such as telephone bank tellers, telephone prescription refills, customer support menus, etc.

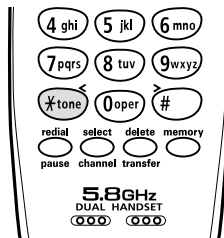

If your phone is set to pulse dialing mode, make your call normally. Once your call connects, press the ***/tone/**<. Enter the desired number. These digits will be sent as tone dialing. Once the call ends, the tone mode is canceled and pulse dialing mode resumes.

Traveling Out-of-Range

During a call, as you begin to move your handset too far from your main base unit, noise increases. If you pass the range limits of the main base unit, your call will terminate within 1 minute.



The **UltraClear Plus™** true compander circuitry virtually eliminates background noise. This innovative technology, together with 20 different channels, provides you with the best possible reception during all your conversations.

Selecting a Different Channel

If you encounter interference while using your phone, you can manually change the phone's channel for clear operation. This function works only when the phone is in use. Press **select/channel**. Scanning appears on the display, indicating the phone is changing to another channel. For more information on interference, refer to page 65 under "Precautions".

Find Handsets

To locate the handsets, press **find hs** on the main base. The handset beeps for 60 seconds.

The paging tone stops when you press any key on either handset, when you press **find hs** on the base, or when you receive an incoming call.

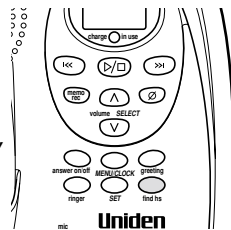

Using Call Waiting

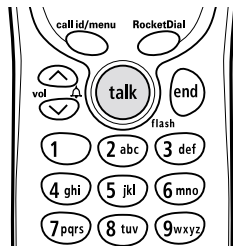

If you have Call Waiting service, you can receive calls while on the line.

- 1) If a call comes in while you are on the phone, you will hear a call waiting tone. If you have CIDCW activated, you will see the name and number of the incoming caller.
- 2) Press **talk/flash** to accept the waiting call. After a short pause, you will hear the new caller.
- 3) To return to the original caller, press **talk/flash** again.

Storing Phone Numbers and Names in Speed Dial Memory

Memory Dialing allows you to dial a number using just a few key presses. Your cordless telephone stores up to 10 names/numbers in each handset.

- 1) With the phone in standby mode, press **memory**. Select Memory is displayed.
- 2) Enter (**0 - 9**) to select the speed dial number where you would like to store this entry. You can also scroll through the list with **vol/▲/△** and **vol/△/▼**.
- 3) Press **memory** or **select/channel**.
- 4) Press **memory** or **select/channel**. The Store Name screen appears and a cursor flashes indicating that the display is ready for the name to be entered.

If the selected speed dial number is already assigned, the Edit screen appears. You can select **Edit** to edit this entry, select **Delete** to delete this entry, or select **Go Back** to choose another speed dial number.

- 5) Enter a name according to the instructions below. If no name is required, go to step 6.
 - The name can be up to 13 characters.
 - See the "Steps for Entering Names and Special Characters" (see page 25).
 - Use **#/>** and ***/tone/<** to move the cursor to the desired location.
 - Use **delete/transfer** to delete characters as needed.
 - Press and hold **delete/transfer** to delete all the characters.

```
Select Memory
01▶
02 JOHN DOE
```

```
01:(Empty)
Press Select
to edit
```

```
Store Name
█
```

```
▶Edit Memory01
Delete Memory01
Go Back
```



In memory dialing operation, you must press a key within 30 seconds or the phone will return to standby mode. If you return the handset to the main base or charging cradle, the phone will return to standby mode also.

6) Press **memory** or **select/channel**. Store Number is displayed.
The cursor flashes indicating that the display is ready for the number to be entered.

```
Store Number
█
```

7) Use the keypad to enter the phone number; each number can be up to 20 digits.
If you need the phone to pause during the dialing sequence, press **redial/pause** to insert a two-second delay between the numbers. You can enter multiple pauses to increase the delay. Each pause counts as a digit. The display shows a P for every pause.

```
Store Number
8007303456█
```

8) Press **memory** or **select/channel**. You will hear a confirmation tone, and the following screen appears.
Memory storage is complete.
After about 2 seconds, the screen displays the list of the entries in Speed Dial Memory.

```
Memory01 Stored
```

9) Press **end** to exit memory setup mode. The phone returns to standby.

```
01▶Movies
02 JOHN DOE
03 MOM AND DAD
```

Steps for Entering Names and Special Characters

Refer to the letters on the number keys to select the desired characters.

With each press of a numeric key, the displayed character appears in the following order: Upper case letters first, lower case letters next and finally the number corresponding to the key.

If you make a mistake while entering a name

Use ***/tone/<** or **#/>** to move the cursor to the incorrect character.

Press **delete/transfer** to erase the wrong character, then enter the correct character.

To delete all characters, press and hold **delete/transfer**.

For example, to enter **Movies**.

- 1) Press **6** then press **#/>** to move the cursor to the right.
- 2) Press **6** six times.
- 3) Press **8** six times.
- 4) Press **4** six times.
- 5) Press **3** five times.
- 6) Press **7** eight times.

	Number of times key is pressed								
keys	1	2	3	4	5	6	7	8	9
1	1								
2abc	A	B	C	a	b	c	2		
3def	D	E	F	d	e	f	3		
4ghi	G	H	I	g	h	i	4		
5jkl	J	K	L	j	k	l	5		
6mno	M	N	O	m	n	o	6		
7pqrs	P	Q	R	S	P	q	r	s	7
8tuv	T	U	U	t	u	v	8		
9wxyz	W	X	Y	Z	w	x	y	z	9
0oper	*	#	-	&	<	>	(blank)	0	



If the next character uses the same number key, you must press **#/>** to move the cursor over. Otherwise the next time you press the number key, it changes the character that was previously set.

Making Calls from Speed Dial Memory

Memory dialing from Standby Mode

- 1) Press **memory**. The handset displays your programmed speed dial memory.
- 2) Enter the number (**0 - 9**), or press **vol/▲/▼** or **vol/▲/▲** to select the speed dial number you would like to dial.
- 3) Press **talk/flash**. Connecting changes to Talk, and the volume setting appears on the display. Then the displayed number is dialed.

```
Select Memory
01 Movies
02 JOHN DOE
```

```
Talk
8007303456
```

To cancel speed dialing, press **end**. The handset returns to standby mode.

Speed dialing from Talk Mode

1) Press **talk/flash**. Connecting appears.

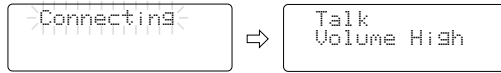

2) After the display changes from Connecting to Talk, press **memory**.

3) Enter a number (**0 - 9**), or press **vol/▲/△** or **vol/▲/▽** to select the memory location of the desired phone number. If you press **select/channel**, the number is dialed.

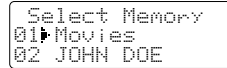

4) To hang up, press **end**.

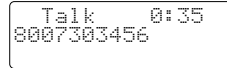

Chain Dialing

The memory locations on the handset are not limited to phone numbers. You can also store a group of numbers (up to 20 digits) that you need to enter once your call connects. This is referred to as Chain Dialing.

An example of this is a bank account number. Once you have called your bank and are prompted to enter the account number, press **memory** and select the location number where the special number has been stored. Then press **select/channel**.

Store your special number with an identifying name. (Refer to "Storing Phone Numbers and Names in Speed Dial Memory" on page 23.)

Editing a Stored Name and/or Phone Number

- 1) With the phone in standby mode, press **memory**. Select Memory is displayed.
- 2) Enter (0 - 9) to select the speed dial number where you would like to edit this entry. You can also scroll through the list with the **vol/▲/▲** and **vol/▲/▼**. Press **memory** or **select/channel**.
- 3) Press **memory** or **select/channel** again. The following screen appears with the memory location number that you have selected.
- 4) Press **vol/▲/▲** or **vol/▲/▼** to select Edit MemoryXX, then press **memory** or **select/channel**. The following screen appears. The cursor flashes indicating that the display is ready for the name to be edited. When a name has not been stored, the cursor appears at the beginning of the second line.
- 5) Use the number keys, *** /tone/ <**, **# />**, or **delete/transfer** to edit the name. (See page 25.) To edit only the phone number, skip this step.
- 6) Press **memory** or **select/channel**. The following screen appears. The cursor flashes indicating that the display is ready for the number to be edited.

```
Select Memory
01▶Movies
02 JOHN DOE
```

```
01:Movies
8007303456
```

```
▶Edit Memory01
Delete Memory01
Go Back
```

```
Store Name
Movies█
```

```
Store Number
8007303456█
```

7) Use the number key, ***** /*tone*/ **<**, **#**/ **>**, *redial/pause* or *delete/transfer* to edit the phone number. The phone number cannot exceed 20 digits (see page 24).

If you don't want to change the phone number, skip this step.

8) Press *memory* or *select/channel*. If you changed either name or phone number, a confirmation display shows up. If it is correct, press *vol/Δ/∧* to select **Yes** and press *select/channel*. You hear a confirmation tone, and the following screen appears. The memory storage is complete. For example, if you edit a name and number into memory location number 01, the display shows **Memory01 Stored**. After about 2 seconds, the screen displays the list of the entries in Speed Dial Memory.

9) Press *end* to return to standby mode.

```
Replace Memory?  
Yes  
▶No
```

```
Memory01 Stored
```

```
01▶Movies  
02 JOHN DOE  
03 MOM AND DAD
```

Erasing a Stored Name and Phone Number

- 1) With the phone in standby mode, press **memory**. Select Memory is displayed.
- 2) Enter a number (**0 - 9**), or press **vol/▲/△** or **vol/▲/▽** to select the memory location you would like to erase.
- 3) Press **memory** or **select/channel**.
- 4) Press **memory** or **select/channel** again.
The Edit screen appears with the memory location number that you have selected in the display.
- 5) Press **vol/▲/▽** to move the pointer down to Delete MemoryXX.
- 6) Press **memory** or **select/channel**. The Delete MemoryXX? screen appears.
- 7) Press **vol/▲/△** to move the pointer to Yes.
- 8) Press **select/channel** or **delete/transfer**.
You hear a confirmation tone, and the MemoryXX Deleted screen appears.
- 9) After about 2 seconds, the display returns to the Select Memory screen. You may delete the information in another memory location (return to step 2) or press **end** to return to standby mode.

```
Select Memory
01▶ Movies
02 JOHN DOE
```

```
02: JOHN DOE
5452930
```

```
▶ Edit Memory02
Delete Memory02
Go Back
```

```
Delete Memory02?
Yes
▶ No
```

```
Memory02 Deleted
```

```
01 Movies
02▶
03 MOM AND DAD
```

RocketDial

You can store your most frequently-called number in the RocketDial location. The RocketDial allows you to dial a number with one key press. (There is no need to press *talk/flash*. The phone will automatically dial the number stored.) If you subscribe to voice mail service, you can store your access number in this location.

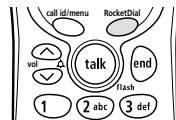

Storing and Editing the RocketDial

- 1) When the phone is in standby mode, press and hold **RocketDial**. The following display appears.

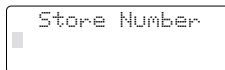

If the Edit screen appears, there is a number already stored. Press **vol/▲/△** or **vol/▲/▽** to select Edit Number, then press **select/channel**.

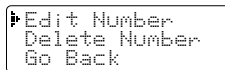

- 2) Store the number by following step 7 under "Storing Phone Numbers and Names in Speed Dial Memory" on page 24.

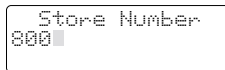

- 3) Press **select/channel**.

You hear a confirmation tone, and the Number Stored screen appears. Memory storage is complete.

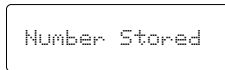

Making Calls with the RocketDial

When the phone is in standby mode, simply press **RocketDial**. The number stored in the RocketDial memory location is instantly dialed.



- The number stored in RocketDial is independent from the numbers stored in Speed Dial Memory.
- If the RocketDial does not have a stored number, the handset will beep rapidly and the phone will not dial.

Deleting the RocketDial

- 1) When the phone is in standby mode, press and hold **RocketDial**. The following display appears.
- 2) Press **vol/▲/∧** or **vol/▲/∇** to select Delete Number.
- 3) Press **select/channel**. The following display appears.
- 4) Press **vol/▲/∧** to move the pointer to Yes.
- 5) Press **select/channel** or **delete/transfer**. You hear a confirmation tone, and the following display appears. After about 2 seconds, the handset returns to standby mode.

```
▶ Edit Number
Delete Number
Go Back
```

```
Delete Number?
Yes
▶ No
```

```
Number Deleted
```

Caller ID and CIDCW (Caller ID on Call Waiting)

You must subscribe to Caller ID services through your local telephone provider to use these features. When the telephone rings, the Caller ID feature allows you to view the caller's name, phone number, date and time of call. With CIDCW (Caller ID on Call Waiting), you will hear a Call Waiting tone while you are on a call, and the Caller ID data is displayed. To accept the waiting call, press *talk/flash*. Additionally, you can dial a number stored in the Caller ID list or save data to your Memory dial list.

When the Telephone Rings

When the Caller ID message is received, the display shows the caller's phone number along with the date and time. The incoming call information is stored in the Caller ID record. If the Caller ID service includes the caller's name, the caller's name appears on the display (up to 15 letters).

The date and time received	5/11 12:30PM
Caller's name	Jane Smith
Caller's phone number	214-555-1234

You may receive any one of the following messages:

When invalid data is received	Incomplete Data
When a private name is received	Private Name
When a private number is received	Private Number
When an unknown name is received	Unknown Name
When an unknown number is received	Unknown Number

note Data errors appear as ■ .



- If you answer a call before the Caller ID message is received (for example, before the second ring), the Caller ID message will not appear.
- When the call is received via a telephone company that does not offer Caller ID service, the caller's phone number and name do not appear. (This includes international calls.)
- When the call is via a private branch exchange (PBX), the caller's phone number and name may not appear.



Viewing the Caller ID Message List

The Caller ID list stores information for up to 30 messages (Caller ID names/numbers) - even unanswered calls.

- In Caller ID operation, if no key is pressed for more than 30 seconds, an error tone sounds and the handset returns to standby mode.
- If a call comes in via a telephone system that does not offer Caller ID service, no information is stored.
- Each message can be up to 15 characters for the phone number and the name.
- The number of calls from the same Caller ID appears next to the received time. Once you view the new message, the number will be cleared and disappear.

1) Press **call id/menu**.

The summary screen appears. The screen shows the number of new messages and total messages.

```
Caller ID
New :01
Total:02
```

2) Press **vol/▲/▼** to display the latest Caller ID message.

```
5/17 12:30PM 03
Jane Smith
214-555-1234
```

3) Press **vol/▲/▼** to see the next message. Or press **vol/▲/▼** key to see the previous message.

4) Press **end** to return to standby mode.

Deleting Information from the Caller ID List

The cordless phone stores up to 30 messages (Caller ID names/numbers) in each handset. If the phone receives the 31st message, the oldest one in the list is automatically deleted. Caller ID data can also be deleted manually.

Deleting a Caller ID message

- 1) Press **call id/menu**. Display the message to be deleted from the Caller ID list by pressing **vol/▲/▲** or **vol/▲/▼**.
- 2) Press **delete/transfer**.
- 3) Press **vol/▲/▲** or **vol/▲/▼** to select Yes or No.
- 4) Press **select/channel** or **delete/transfer**.

```
5/17 12:30PM 03  
Jane Smith  
214-555-1234
```

```
Delete Message?  
▶Yes  
No
```

When the pointer is at Yes:

You hear a confirmation tone and the Caller ID message is deleted. The next Caller ID message is then displayed.

When the pointer is at No:

The display returns to the Caller ID message.

Deleting all Caller ID names/numbers

- 1) With the phone in standby mode, press **call id/menu**.
- 2) Press **delete/transfer**.

```
Caller ID  
New :01  
Total:02
```



- While using the Delete All? or Delete Message? screen, if no key is pressed for more than 30 seconds, an error tone sounds, and the telephone returns to standby mode.
- If you get an incoming call or page, the deleting operation is canceled, and you can answer the call or page.

3) Press **vol/▲/△** or **vol/▲/▽** to select Yes or No.

```
Delete All?  
Yes  
▶No
```

4) Press **select/channel** or **delete/transfer**.

When the pointer is at Yes:

You hear a confirmation tone and all stored Caller ID messages are deleted.

```
Caller ID  
Total:00
```

When the pointer is at No:

The display returns to the summary screen.

```
Caller ID  
New :01  
Total:02
```

Making a Call from the Caller ID List

You can place a call from the Caller ID list.

- 1) Press **call id/menu**. Select the phone number that you want to dial by pressing **vol/▲/△** or **vol/▲/▼**.
- 2) To add a "1" to the front of the displayed Caller ID number (for a long distance call), press **1**. To delete a "1" from the front of the displayed caller ID number, press **1** again.
- 3) Press **talk/flash**. The displayed phone number dials automatically.



You can place a call from Talk Mode. Press **talk/flash**, then press **call id/menu**. Select the phone number that you want to dial by pressing **vol/▲/△** or **vol/▲/▼**, then press **select/channel**. The displayed phone number will be dialed.

```
5/17 12:30PM 03  
Jane Smith  
214-555-1234
```

```
Talk  
2145551234
```



- You cannot make a call from the Caller ID list if your cordless telephone is connected to a private branch exchange (PBX).
- When a long distance call has been set, **1** appears in the display.



You cannot store a Caller ID message if no phone number appears in the message.

Storing Caller ID Messages in Memory Dialing

Messages (Caller ID names/numbers) shown in the Caller ID list can be stored in memory dialing.

- 1) Press **call id/menu**, then press **vol/▲/△** or **vol/▲/▽** to select the desired phone number from the Caller ID list.
- 2) Press **memory**.
- 3) Enter a number (**0 - 9**), or press **vol/▲/△** or **vol/▲/▽** to select the memory location to be stored.
- 4) Press **select/channel**.
You hear a confirmation tone, and the number is stored in memory. The display returns to the Caller ID list.



If a number has already been stored in the selected memory number location, a confirmation screen is displayed. Press **vol/▲/△** to select **Yes**. Press **select/channel** to overwrite. The display returns to the Caller ID list.

```
5/17 12:30PM 03  
Jane Smith  
214-555-1234
```

```
Select Memory  
01  
02 JOHN DOE
```

```
5/17 12:30PM 03  
Jane Smith  
214-555-1234
```

```
Replace Memory?  
Yes  
No
```

The Integrated Answering Device

The cordless phone has a built-in answering system that answers and records incoming calls. You can also use your answering system to record a conversation, leave a voice memo message, or to announce a special outgoing message to callers when you're away from your phone.

Features

- Digital Tapeless Recording
- Up to 13 Minutes of Recording Time
- Call Screening
- Personal or Pre-recorded Outgoing Message
- Voice Prompts (English, French or Spanish)
- Time and Day Announcement
- Remote Message Retrieval
- Toll Saver
- Conversation Recording
- Voice Memo
- Selectable ringer options (high, low or off)

Digital Tapeless Recording allows you to quickly review, save, or delete the messages you choose. You will never have to worry about a tape wearing out, jamming, or resetting improperly.

The Integrated Answering System is easy and convenient to use, but **please read** through all of the instructions carefully.

Turning the Answering System On/Off



- 1) To turn the answering system on, press **answer on/off**. The system will announce “Answering system is on.” The current greeting message will be played, and you will hear a confirmation tone. The message counter displays the number of messages stored in memory. If the display flashes, then there are new messages waiting for you.
- 2) To turn the answering system off, press **answer on/off** again. After the announcement “Answering system is off,” the message counter display will no longer be illuminated. To turn the answering system back on, press **answer on/off**.

Setting Up Your Answering System

Answering System Setting

To set the following six functions you must enter the menu mode.

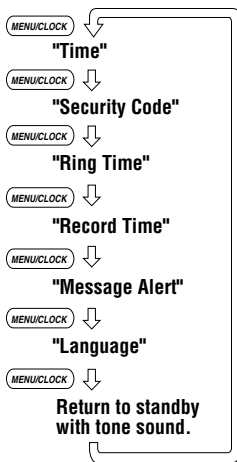

- To scroll through the menu options, repeatedly press **MENU/CLOCK** in standby mode. The system returns to standby after the last menu option. You hear a confirmation tone to indicate standby mode.
- If any of the following occurs during menu setup, the system returns to standby. Start over the procedure of the setting.
 - Press *talk/flash*
 - Press the ▷/□ key
 - Receive a call
- If the system remains idle for about 5 seconds after the announcement, the system returns to standby. Once **volume/SELECT/∧** or **volume/SELECT/∨** is pressed, the idle time is extended to 10 seconds.



- For your convenience, voice prompts will guide you through the menu mode.
- After the setting, press the ▷/□ key to exit the menu mode, or **MENU/CLOCK** to move to the next menu option.



Press and hold **volume/SELECT/∧** or **volume/SELECT/∇** to quickly scroll through the numbers on the display.

Setting the Time

The clock on the cordless phone's answering system starts when power is supplied to the base. Follow these steps to set the clock to the correct time.



- 1) Press **MENU/CLOCK** in standby mode.
The system announces "Time," the current time and the instructions for setting the time.
- 2) Press **volume/SELECT/∧** or **volume/SELECT/∇** until the correct day is announced. The numbers [1] through [7] are displayed on the base.
- 3) Press **SET** to select the day.
- 4) Press **volume/SELECT/∧** or **volume/SELECT/∇** until you hear the correct hour setting. The numbers [1] through [12] are displayed on the base as each hour is announced.
- 5) Press **SET** to select the hour.
- 6) Press **volume/SELECT/∧** or **volume/SELECT/∇** until you hear the correct minute setting. The numbers [00] through [59] are displayed on the base as each minute is announced.

- 7) Press **SET** to select the minute.
- 8) Press **volume/SELECT/∧** or **volume/SELECT/∨** until you hear the correct AM or PM setting. The message counter displays [*A*] or [*P*].
- 9) Press **SET** to select the AM/PM setting.

You hear a confirmation tone, then the announcement "Time" and the time and day are announced for your review. After a few seconds, the system announces "To set security code, press menu again."

Setting a Personal Security Code (PIN)

To play your messages from a remote location, you need to enter a two-digit Personal Identification Number (PIN) code (01-99). To select a PIN, perform the following steps:

- 1) Press **MENU/CLOCK** twice in standby mode.
The system announces "Security code," and the current PIN code is announced as it is displayed on the base. Then the system announces the instructions for setting the PIN code.
- 2) Press **volume/SELECT/∧** or **volume/SELECT/∨** until the desired number appears.
- 3) Press **SET** to select the PIN code. You hear a confirmation tone, then the announcement "Security code" followed by the new PIN code. After a few seconds, the system announces "To set ring time, press menu again."



The PIN code is set to "80" when you purchase the cordless phone.

Setting the Ring Time

The ring time setting allows you to set the number of rings the caller hears before your answering system plays the outgoing message. You can set the ring time to answer after two, four, or six rings. Setting [٤5] (Toll Saver), the answering system picks up after two rings if you have new messages, and after four rings if there are none. This way, if you make a long distance call to check your messages, you can hang up after the second ring to avoid billing charges.

1) Press **MENU/CLOCK** three times in standby mode.

You hear "Ring time" and the current ring time ([٢] 2, [٤] 4, [٤] 6, [٤5] Toll saver), and it is displayed on the base. Then you hear the instructions for setting the ring time.

2) Press **volume/SELECT/ ^** or **volume/SELECT/ v** until the desired ring time appears.

3) Press **SET** to select the new ring time. You hear a confirmation tone, then the announcement "Ring time" followed by the new ring time. After a few seconds, the system announces "To set record time, press menu again."

Selecting the Message Record Time

You have three record time options. The options "1 minute" or "4 minutes" set the duration for recording the incoming messages. "Announce only" answers the call with the preset greeting or your personal greeting but prevents the caller from leaving a message.

- 1) Press **MENU/CLOCK** four times in standby mode.
You hear "Record time" and the current recording time ([/] 1 minute, [4] 4 minutes, [#] Announce only, No recording), and it is displayed on the base. Then you hear the instructions for setting the record time.
- 2) Press **volume/SELECT/^** or **volume/SELECT/∨** until the desired time appears.
- 3) Press **SET** to select the new recording time. You will hear a confirmation tone, then the announcement "Record time" followed by the new recording time. After a few seconds, the system announces "To set message alert, press menu again."

▼ Announce only feature

The announce only feature plays a prerecorded outgoing message "Hello, no one is available to take your call. Please call again." It will not allow the caller to leave a message. To set "Announce only," follow the steps above.

To scroll between the prerecorded message or your own personal greeting, press **greeting** when the outgoing message is played. If you want to use your own greeting or want to omit the prompt "to leave a message from your greeting," refer to "Recording a personal outgoing message (Greeting)" on page 47.



After setting the Announce only feature, you may want to change your outgoing message not to prompt the caller to leave a message. However, the prerecorded message changes automatically.

Setting the Message Alert tone

Message Alert feature lets you know you have new messages by sounding a short beeping tone. If you set the Message Alert to On and when a new message is received, the alert tone will sound every 15 seconds.

- 1) Press **MENU/CLOCK** five times in standby mode.
You hear “Message alert” and the current setting ([*Off*] Off or [*On*] On), and it is displayed on the base. Then you hear the instructions for setting the Message Alert.
- 2) Press **volume/SELECT/∧** or **volume/SELECT/∨** to make your selection.
- 3) Press **SET** to select the new setting. You hear a confirmation tone, then the announcement “Message alert” followed by the current setting you have selected. After a few seconds, the system announces “To set language, press menu again.” When the first new message is received, the alert tone will begin to sound.

Turning the Message Alert tone off by pressing any key.

- 1) To quickly turn Message Alert tone off, **press any key** on the base unit and the tone will **automatically deactivate**. To reset, go back into the menu setup mode (steps 1 - 3 above.)

Turning Message Alert tone off when you're away from your phone.

- 1) When all **new messages** are played back using the remote playback feature (see page 54) the Message Alert tone will automatically deactivate. The tone will not deactivate until all messages are played back.

Selecting the Language

The answering system voice announcements can be heard in English, French or Spanish. To choose the language of the answering system voice announcements:

- 1) Press **MENU/CLOCK** six times in standby mode.
You hear the announcement "Language, English" followed by the instructions for setting the language. The current setting ([E], [F] or [S]) appears on the base.
- 2) Press **volume/SELECT/∧** or **volume/SELECT/∨** to select the desired language.
- 3) Press **SET**. A confirmation tone is heard along with the setting in the language selected.

Setting Your Outgoing Message (Greeting)

When you receive a call, the answering system automatically plays either a preset message or your own greeting.

▼Preset message

The following message is prerecorded:

"Hello, no one is available to take your call. Please leave a message after the tone."



See "Selecting the Message Record Time," page 45 on how to set the announce only feature.

▼Recording a personal outgoing message (Greeting)

- 1) Press and hold **greeting** in standby mode.
You will hear the announcement "Record greeting" and a confirmation tone.
[- -] flashes on the message counter.



- You can record a greeting more than 2 seconds up to 30 seconds long.
- Position yourself as near to the base as possible and speak clearly when recording your outgoing message.

- 2) Start recording your message. You have 30 seconds, and the message counter starts to count down [30] to [1] every second.
- 3) When you are finished recording your greeting, press **greeting**, the ▷/□ key or **SET**. You will hear a confirmation tone, and then your greeting plays back for you.

▼ Choosing between the two outgoing messages

Press **greeting** in standby mode. Then press **greeting** again when the outgoing message is played. This switches between the prerecorded greeting and the personal greeting. After the greeting finishes playing, you will hear a confirmation tone is heard.



To delete the personal Greeting, press the ∅ key during the announcement and the system announces "Greeting has been deleted."

Setting the Base Ringer Volume

You will hear three ringer options. One allows you to turn the ringer off. The other two are volume levels.

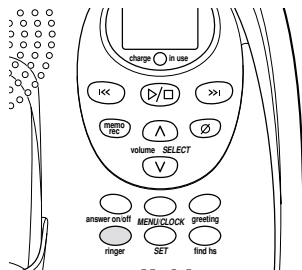

- 1) Press **ringer**.

You hear the ringer at the current volume level ([H ,] High, [L o] Low, [OF] off) (if you set the base ringer volume to off, "Ringer off" is announced) and it is displayed on the base.

- 2) Press **ringer** repeatedly until the desired ringer option appears.
- 3) The system displays the new ringer volume.



When you have set the base ringer to off and the handset is on the base, you will still hear the ringer from the handset.

Temporarily Mute the Base Ringer

Press the \triangleright/\square key to temporarily mute the incoming ring. The ringer will sound with the next incoming call.

Adjusting the Speaker Volume Level

You can adjust the volume of the base speaker by pressing **volume/SELECT/∧** or **volume/SELECT/∨** on the base. Press **volume/SELECT/∧** for louder or **volume/SELECT/∨** for softer while the base speaker is being used except for menu mode. The numbers [0]- [9] are displayed on the base indicating the volume levels. [0] being the softest and [9] being the loudest.

Using Your Answering System

The message counter displays the number of messages stored in memory. If the display flashes, then there are new messages waiting for you. The flashing number represents the number of new messages, not total messages. The cordless phone is designed to play your new messages first. After you play all your new messages, you can then play your old messages.



When the answering system is full, [FL] is displayed on the base, and the system announces "No remaining time." You should delete some messages so that the system can record new messages. (Refer to "Deleting a Message" on page 52.)



When you press **volume/SELECT/∧** at 9 or **volume/SELECT/∨** at 0, an error tone sounds.



To stop playing your messages, press the ▷/□ key again at any time.

Playing your messages



- 1) Press the ▷/□ key in standby mode.
The system announces the number of new and old messages. The LED displays the number of new messages, and the number flashes. The day and time that each message was received is announced after the message is played. The message counter displays the number of current messages stored.
When all new messages have been played, you hear a confirmation tone and an announcement “End of messages.” The system returns to standby.
- 2) After you have reviewed your new messages, you can play your old messages by again pressing the ▷/□ key. Once you have listened to a new message, it becomes an old message. The old messages will be played in the order in which they were received.

Repeating a message

- 1) Press the ▷/□ key to review your messages. The number of stored messages are announced.
- 2) After a message has played for a few seconds, press the ◀◀ key to replay the message. If you have several messages, press the ◀◀ key repeatedly until you return to the message you want to replay.

- 3) Press the ▷/□ key at any time to stop reviewing messages and return to standby. The message counter shows the number of messages stored in memory.

To quickly scroll backward through a message, press and hold the ◀◀ key.

Skipping a message

- 1) Press the ▷/□ key to review your messages. The number of messages is announced.
- 2) Press the >>| key at anytime to skip to the next message. Each time the >>| key is pressed, the system scans forward one message. If you have several messages, press the >>| key repeatedly to find the message you want to play.
- 3) Press the ▷/□ key at any time to stop reviewing your messages and return to standby. The message counter shows the number of messages stored in memory.

To quickly scroll forward through a message, press and hold the >>| key.



When you press the \emptyset key, you are permanently deleting the message. Once deleted, the message cannot be replayed.

Deleting a Message



To maintain maximum record time, delete the old messages.

- 1) Press the \triangleright/\square key to review your messages.
- 2) Press the \emptyset key anytime during the message to delete.
- 3) You will hear a confirmation tone and the message is deleted.

You can also delete all the messages.

- 1) Press the \emptyset key in standby mode. You will hear an announcement "To delete all messages, press delete again."
- 2) Press the \emptyset key again. You will hear a confirmation tone and [\square] is displayed on the base. All the messages are deleted.

When you try to delete all messages without first listening to your new messages, you hear several short beeps followed by an announcement "Please playback all messages." This protects you from accidentally erasing messages you have not yet reviewed.

Voice memo



The voice memo function allows you to record messages (more than 2 seconds up to 4 minutes).

- 1) Press and hold **memo rec** in standby mode. You hear an announcement “Record memo message” and a tone. [- -] flashes on the message counter.
- 2) Start your recording.
- 3) When you have finished, press the ▷/□ key, **memo rec** or **SET** to stop recording. You hear a confirmation tone and the system returns to standby.

Recording a conversation

You can record up to 10 minutes of conversation while you are using your phone. Any conversation that lasts less than 2 seconds will not be recorded.

- 1) During a conversation from the handset, press and hold **memo rec**. The unit begins recording with a confirmation tone and [- -] flashes on the message counter.

A beep that can be heard by both parties sounds during recording.

note

If you receive a call waiting tone while recording a conversation, press **talk/flash** to accept the waiting call. The recording feature continues recording the new call. The original call is put on hold.

- 2) To stop recording, press the ▷/□ key or **memo rec**. You hear a confirmation tone. Transferring a call also stops recording.

note

- The voice memo function is completely independent of the greeting message.
- The voice memo messages are recorded as incoming messages.
- When the answering system is full, [FL] appears on the message counter and recording is terminated.
- A recorded conversation is treated as a typical message and will be added to the stored messages.
- When recording a conversation, all dialing features except for flash operation (see “Using Call Waiting” on page 22) are disabled. Stop recording if you need to enable any other handset keys.

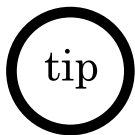

For your convenience remote operation cards are provided for you to use while away from home (located backward of this manual).



You must enter a command within 15 seconds of entering command waiting mode or the answering system automatically hangs up and returns to standby.

Remote access

You can operate your answering system from a remote location using any touch-tone telephone. Use this function to check for recorded messages, to play or delete messages, even to record a new greeting message.

- 1) Call your telephone number.
- 2) During the greeting message, press **0** and enter your PIN code.
(See "Setting a Personal Security Code (PIN)," page 43).
- 3) The answering system announces the current time and the number of messages stored in memory. Then you hear "To play incoming messages, press zero two.
For help, press one zero."
- 4) You may continue to listen to the voice prompts, or you may select a command from the following chart:

Command	Function
0 then 1	Repeat a Message
0 then 2	Playing Incoming Messages
0 then 3	Skipping a Message
0 then 4	Deleting a Message
0 then 5	Stop Operation
0 then 6	Answering System On
0 then 7	Memo Record/Stop*
0 then 8	Greeting Message Record/Stop*
0 then 9	Answer System Off
1 then 0	Help

* For Memo Record and Greeting Message Record function, the first time you enter the corresponding command, it starts the Recording function. If you want to stop the recording, enter the command again.

- 5) After all of the instructions have played, you hear intermittent beeps indicating that the system is in the command waiting mode. You may enter another command at this time from the chart.
- 6) When you are finished, hang up to exit the system. The answering system automatically returns to standby.

Turn on the answering system remotely

If you have forgotten to turn on your answering system, you can turn it on remotely from any touch-tone telephone.

- 1) Call your telephone number.
- 2) Wait ten rings until the system answers. You hear a beep.
- 3) Press **0** and then enter your PIN code. The answering system announces the number of messages stored in memory. You hear "To play incoming messages, press zero two. For help, press one zero."
- 4) Press **0** then **6** to turn the answering system on. You hear the outgoing message and a confirmation tone.
- 5) Hang up the phone and subsequent calls will be answered by the system.

Changing the Digital Security Code

To protect you against misbilled calls which might result from your phone being activated by other equipment, the cordless phone provides **AutoSecure™** (which electronically locks your phone when each handset is in the main base or charging cradle) and **Random Code™** digital security (which automatically selects one of over 262,000 digital security codes for each handset and main base).

If the handset battery pack is completely discharged or the battery pack is removed, the digital security code will be lost. If this happens, a new security code is set automatically the next time the battery pack is charged.

In the rare situation that you suspect another cordless telephone is using the same security code, you can change the code.

- 1) Remove the handset from the main base unit or charging cradle. Press and hold **find hs** on the main base.
- 2) While holding **find hs**, place the handset in the main base unit, and leave the handset in the main base for more than 3 seconds.
- 3) Remove the handset from the main base. Then place the second handset in the main base unit and wait for more than 3 seconds. You do not need to press **find hs** this time.
- 4) Press **talk/flash** on one handset. Once you make sure **talk** appears on the display, press **end**. Then, try with the second handset. If each handset displays **talk**, a new security code is set. Otherwise, return to step 1 and try again.

Installing the Beltclip

To attach the beltclip

Insert the beltclip into the holes on each side of the handset. Press down until it clicks.

To remove the beltclip

Pull both sides of the beltclip to release the tabs from the holes.

Headset Installation

Your phone may be used with an optional headset, the Uniden HS910. To use this feature, insert the headset plug into the headset jack. Your phone is ready for hands-free conversations. (Headset may be purchased by calling the Uniden Parts Department or visiting the web site, see the QUICK REFERENCE GUIDE included in your package.)



Note on Power Sources

Battery replacement and handling

When the operating time becomes short, even after a battery is recharged, please replace the battery. With normal usage, your battery should last about one year. Please contact your place of purchase or the Uniden Parts Department for a replacement battery.

Warning: To avoid the risk of personal injury or property damage from fire or electrical shock, only use the Uniden battery model and Uniden adapter model specifically designated for this product.

Power Failure

During the period that the power is off, you will not be able to make or receive calls with the telephone.

Caution

- Use only the specified Uniden battery packs.
- Do not remove the battery from the headset to charge it.
- Never throw the battery into a fire, disassemble it, or heat it.
- Do not remove or damage the battery casing.

Maintenance

To maintain a good charge, it is important to clean the charging contacts on the handsets, main base unit and charging cradle once a month. Using water only, dampen a cloth to clean the charging contacts. Then, make sure to go back over the charging contacts with a dry cloth.

Caution

Do not use paint thinner, benzene, alcohol, or other chemical products. Doing so may discolor the surface of the telephone and damage the finish.

Troubleshooting

If your phone is not performing to your expectations, please try these simple steps first.

Symptom	Suggestion
The charge/in use or charge LED won't illuminate when the handset is placed in the main base or charging cradle.	<ul style="list-style-type: none">• Make sure the AC adapters are plugged into each charging cradle and wall outlet.• Make sure both handsets are properly seated in each charging cradle.• Make sure the charging contacts on the handsets, main base and charging cradle are clean.
The audio sounds weak and/or scratchy.	<ul style="list-style-type: none">• Move the handset and/or main base to a different location away from metal objects or appliances and try again.• Press <i>select/channel</i> to help eliminate background noise.• Make sure that the handset is not too far from the main base.
Can't make or receive calls.	<ul style="list-style-type: none">• Re-register both handsets (see page 14).• Check both ends of the base telephone line cord.• Make sure the AC adapter is plugged into the main base and wall outlet.• Disconnect the AC adapter for a few minutes, then reconnect it.• Make sure that you are not too far from the main base.• Check the dialing mode.

Symptom	Suggestion
The handset doesn't ring or receive a page.	<ul style="list-style-type: none"> • Re-register both handsets (see page 14). • The battery pack may be weak. Charge the battery for 15-20 hours. • The handset may be too far away from the main base unit. • Place the main base unit away from appliances or metal objects. • Check the battery pack to ensure there is a secure connection. • Make sure ringer volume isn't set to turned off.
Severe noise interference.	<ul style="list-style-type: none"> • Keep both handsets away from microwave ovens, computers, remote control toys, wireless microphones, alarm systems, intercoms, room monitors, fluorescent lights, electrical appliances, other cordless telephones and other devices that use electricity. • Move to another location or turn off the source of interference.
The Caller ID does not display.	<ul style="list-style-type: none"> • The call was answered before the second ring. The Caller ID is displayed between the first and second ring. • The call was placed through a switchboard. • Your Caller ID service may not be active; contact your local telephone service provider. • Charge the handset.
Handset No.1 or No.2 is not working.	<ul style="list-style-type: none"> • Make sure the battery pack is connected to the handset and fully charged. • Re-register the non-functional handset.

Symptom	Suggestion
Unavailable message is displayed on the LCD screen of the handset.	<ul style="list-style-type: none"> • Make sure the other handset is not already in use. Both handsets cannot be in talk mode at the same time. • Place the handset in the main base for at least 5 seconds to re-register to the main base. • Make sure the handset is not too far from the main base when trying to use.
The handset doesn't communicate with the main base or the other handset.	<ul style="list-style-type: none"> • Re-register both handsets (see page 14).
No 3-way conversation.	<ul style="list-style-type: none"> • Only one handset at a time can talk with an outside caller. To allow the other handset to talk to the caller, transfer the call.
The answering system does not work.	<ul style="list-style-type: none"> • Make sure the the AC adapter is plugged into the base and wall outlet. • Make sure the answering system is turned on.
The answering system does not record any messages.	<ul style="list-style-type: none"> • Set the record time to either the one minute or four minute option. • The memory may be full. Delete some or all of the saved messages.
Messages are incomplete.	<ul style="list-style-type: none"> • The incoming messages may be too long. Remind callers to leave a brief message. • The memory may be full. Delete some or all of the saved messages.

Symptom	Suggestion
After a power failure, the outgoing message is deleted.	<ul style="list-style-type: none"> • Record your personal outgoing message again. The default message should remain.
No sound on the base unit speaker during call monitoring or message playback.	<ul style="list-style-type: none"> • Adjust the speaker volume on the base unit.
Cannot access remote call-in features from another touch-tone phone.	<ul style="list-style-type: none"> • Make sure you're using the correct PIN code. • Make sure that the touch-tone phone you're using can transmit the tone for at least two seconds. If it cannot, you may have to use another phone to access your messages.
If you still have a problem.	<ul style="list-style-type: none"> • Call our customer hotline at 1-800-297-1023.

Liquid Damage

Moisture and liquid can damage your cordless phone. In case of accidental submersion, please read the following steps.

Case	Action
If the handset or base is exposed to moisture or liquid, but liquid only affects the exterior plastic housing.	Wipe off the liquid, and use as normal.
If moisture or liquid has entered the plastic-housing (i.e. liquid can be heard in the phone or liquid has entered the handset battery compartment or vent openings on the base).	<p>Handset:</p> <ol style="list-style-type: none">1. Remove the battery cover and leave it off for ventilation.2. Remove the battery pack by disconnecting.3. Leave the battery cover off and the battery pack disconnected for at least 3 days.4. Once the handset is completely dry, reconnect the battery pack and the battery cover.5. Recharge the handset's battery pack for 20 hours before using again. <p>Base:</p> <ol style="list-style-type: none">1. Disconnect the AC adapter from the main base unit, cutting off electrical power.2. Disconnect the telephone cord from the main base unit.3. Let dry for at least 3 days. <p>IMPORTANT: You must unplug the telephone line while recharging the battery pack to avoid charge interruption.</p> <p>CAUTION: DO NOT use a microwave oven to speed up the drying process. This will cause permanent damage to the handset, base and the microwave oven.</p> <p>After following these steps, if your cordless telephone does not work, please send to: Uniden America Corporation Parts and Service Division 4700 Amon Carter Blvd. Ft. Worth, TX76155 1-800-554-3988. Monday through Friday 8 a.m. to 5 p.m. CST</p>

General Information

The phone complies with FCC Parts 15 and 68.
Operating temperature: -10° to 50°C (+14°F to +122°F)

AC Adapter Information

	(For the base)	(For the charging cradle)
AC Adapter part number:	AD-314	AD-310
Input Voltage:	120V AC 60Hz	120V AC 60Hz
Output Voltage:	9V DC 350 mA	9V DC 210 mA

Battery Information

Battery part number: BT-800
Capacity: 800 mAh, 3.6V



You can also use BT-905, but its usage time is less than BT-800.
Purchase BT-800 at Uniden Website www.uniden.com.

Frequency

925.181-927.451 MHz
5739.320-5746.130 MHz



- To avoid damage to the phone use only Uniden AD-314, AD-310 and BT-800 (or BT-905 having less usage time) with your phone.
- If the handset is left off of the base, the actual Talk mode duration will be reduced respective to the amount of time the handset is off the base.

Recharge your phone on a regular basis by returning the handset to the base after each phone call. When the operating time becomes short, even after the battery is recharged, please replace the battery. With normal usage, the battery should last about one year.

A replacement Uniden adapter and battery may be purchased at your local Uniden dealer or by contacting the Uniden Parts Department (800) 554-3988. Hours are from 8:00 a.m. to 5:00 p.m. Central Time, Monday through Friday. We can also be reached on the web at www.uniden.com.

Specifications, features, and availability of optional accessories are all subject to change without prior notice.

Precautions!

Before you read anything else, please observe the following:

Warning!

Uniden America Corporation DOES NOT represent this unit to be waterproof. To reduce the risk of fire, electrical shock, or damage to the unit, DO NOT expose this unit to rain or moisture.

Rechargeable Nickel-Cadmium Battery Warning

- This equipment contains a rechargeable nickel-cadmium battery.
- Cadmium is a chemical known to the State of California to cause cancer.
- The rechargeable nickel-cadmium battery contained in this equipment may explode if disposed of in a fire.
- Do not short-circuit the battery.
- Do not charge the rechargeable nickel-cadmium battery used in this equipment in any charger other than the one designed to charge this battery as specified in the owner's manual. Using another charger may damage the battery or cause the battery to explode.

Rechargeable Nickel-Cadmium Batteries Must Be Recycled or Disposed of Properly

- Uniden voluntarily participates in an RBRC® industry program to collect and recycle nickel-cadmium batteries at the end of their useful life, when taken out of service within the United States. The RBRC® program provides a convenient alternative to placing used nickel-cadmium batteries into the trash or municipal waste stream, which is illegal in some areas.
- Through the RBRC® program, Uniden makes it easy for you to drop off the used battery at local retailers of replacement nickel-cadmium batteries. You may also contact your local recycling center for information on where to return the used battery. Please call 1-800-8-BATTERY for information on Ni-Cd battery recycling in your area. Uniden's involvement in this program is part of its commitment to protecting our environment and conserving natural resources.
- RBRC® is a registered trademark of the Rechargeable Battery Recycling Corporation.



The exclamation point within an equilateral triangle is intended to alert the user to the presence of important operating and maintenance (servicing) instructions in the literature accompanying the appliance.

Uniden works to reduce lead content in our PVC coated cords in our product and accessories.

Warning!

The cords on this products and/or accessories contain lead, a chemical known to the State of California to cause birth defects or other reproductive harm. **Wash hands after handling.**

Important Safety Instructions

When using your telephone equipment, these basic safety precautions should always be followed to reduce the risk of fire, electrical shock, and injury to persons:

1. Read and understand all instructions.
2. Follow all warnings and instructions marked on the product.
3. Unplug this product from the wall outlet before cleaning. Use a dry cloth for cleaning without liquid or aerosol cleaners.
4. Do not use this product near water; for example, near a bathtub, wash bowl, kitchen sink or laundry tub, in a wet basement, or near a swimming pool.
5. Do not place this product on an unstable cart, stand, or table. The telephone may fall, causing serious damage to the unit.
6. Slots and openings in the cabinet and the back or bottom are provided for ventilation. To protect the product from overheating, these openings must not be blocked or covered. This product should never be placed near or over a radiator or heat register. This product should not be placed in a built-in installation unless proper ventilation is provided.
7. This product should be operated only from the type of power source indicated on the marking label. If you are not sure of the type of power supply to your home, consult your dealer or local power company.
8. Do not allow anything to rest on the power cord. Do not locate this product where the cord will be damaged by persons walking on it.
9. Do not overload wall outlets and extension cords, as this can result in the risk of fire or electrical shock.
10. Never push objects of any kind into this product through cabinet slots, as they may touch dangerous voltage points or short out parts that could result in a risk of fire or electric shock. Never spill liquid of any kind on the product.
11. To reduce the risk of electric shock, do not disassemble this product. Take it to qualified service personnel when service or repair work is required. Opening or removing covers may expose you to dangerous voltages or other risks. Incorrect reassembly can cause electric shock when the appliance is subsequently used.
12. Unplug this product from the wall outlet and refer servicing to qualified service personnel under the following conditions:
 - A. When the power supply cord is damaged or frayed.
 - B. If liquid has been spilled into the product.
 - C. If the product has been exposed to rain or water.
 - D. If the product does not operate normally when following the operating instructions. (Adjust only those controls that are covered by the operating instructions. Improper adjustment of other controls may result in damage and will often require extensive repair work by a qualified technician.)

E. If the product has been dropped or the cabinet has been damaged.

F. If the product exhibits a distinct change in performance.

13. Do not use the telephone to report a gas leak in the vicinity of the leak.

Additional Battery Safety Precautions

Caution! To reduce the risk of fire or injury to persons by the battery, read and follow these instructions:

1. Use only the Uniden battery pack specified in the owner's manual.
2. Do not dispose of the battery pack in a fire. The cell may explode. Check the nickel-cadmium battery disposal package insert for disposal instructions.
3. Do not open or mutilate the battery pack. Released electrolyte is corrosive and may cause damage to the eyes or skin. It may be toxic if swallowed.
4. Exercise care in handling the battery in order not to short the battery with conducting materials such as rings, bracelets, and keys. The battery or conductor may overheat and cause burns.
5. Charge the battery pack provided with or identified for use with this product only in accordance with the instructions and limitations specified in the owner's manual provided for this product.
6. Observe proper polarity orientation between the battery pack and battery charger.

SAVE THESE INSTRUCTIONS!

Important Electrical Considerations

Unplug all electrical appliances when you know an electrical storm is approaching. Lightning can pass through your household wiring and damage any device connected to it. This phone is no exception.

The FCC Wants You To Know

Changes or modifications to this product not expressly approved by Uniden, or operation of this product in any way other than as detailed by the owner's manual, could void your authority to operate this product. Your telephone complies with Part 68 of FCC Rules. You must, upon request, provide the FCC registration number and the REN to your telephone company. Both numbers are on the main base unit.

- NOTE:**
- You must not connect your phone to:
 - coin-operated systems
 - most electronic key telephone systems

This device complies with Part 15 of the FCC rules. Operation is subject to the following two conditions: (1) This device may not cause harmful interference, and (2) This device must accept any interference received, including interference that may cause undesired Operation. Privacy Of Communications May Not Be Ensured When Using This Phone.

Range

Your new phone is designed to achieve the maximum possible range by transmitting and receiving according to the highest specifications set forth by the FCC. We have rated this phone to operate at a maximum distance with the qualification that the range depends upon the environment in which the telephone is used. Many factors limit range, and it would be impossible to include all the variables in our rating. The Maximum Range rating of this phone is meant to be used as a means of comparison against other range claims.

Telephone Line Problems

The FCC has granted the telephone company the right to disconnect service in the event that your phone causes problems on the telephone line. Also, the telephone company may make changes in facilities and services which may affect the operation of your unit. However, your telephone company must give adequate notice in writing prior to such actions to allow you time for making necessary arrangements to continue uninterrupted service.

If you are having trouble with your telephone service, you must first disconnect your phone to determine if it is the cause of your problem. If you determine that it is the cause, you must leave it disconnected until the trouble has been corrected.

Radio Interference

Radio interference may occasionally cause buzzing and humming in your cordless handset, or clicking noises in the base. This interference is caused by external sources such as TV, refrigerator, vacuum cleaner, fluorescent lighting, or electrical storm. Your unit is NOT DEFECTIVE. If these noises continue and are too distracting, please check around your home to see what appliances may be causing the problem.

In addition, we recommend that the base not be plugged into a circuit that also powers a major appliance because of the potential for interference. Be certain that antenna on the unit is fully extended. In the unlikely event that you consistently hear other voices or distracting transmissions on your phone, you may be receiving radio signals from another cordless telephone or other source of interference. If you cannot eliminate this type of interference, you need to change to a different channel.

Finally, it should be noted that some cordless telephones operate at frequencies that may cause interference to nearby TVs and VCRs. To minimize or prevent such interference, the base of the cordless telephone should not be placed near or on top of a TV or VCR. If interference is experienced, moving the cordless telephone farther away from the TV or VCR will often reduce or eliminate the interference.

More Than One Cordless Telephone

If you want to use more than one cordless telephone in your home, they must operate on different channels. Press the channel key to select a channel that provides the clearest communication.

Cordless Telephone Privacy

Cordless telephones are radio devices. Communications between the handset and base of your cordless telephone are accomplished by means

of radio waves which are broadcast over the open airways. Because of the inherent physical properties of radio waves, your communications can be received by radio receiving devices other than your own cordless telephone unit. Consequently, any communications using your cordless telephone may not be private.

Installation Considerations

Selecting a Location

Before choosing a location for your new phone, there are some important guidelines you should consider:

- The location should be close to both a phone jack and continuous power outlet. (A continuous power outlet is an AC outlet which does not have a switch to interrupt its power.)
- Keep the base and handset away from sources of electrical noise such as motors or fluorescent lighting.
- Be sure there is sufficient space to fully extend the base antenna.
- The base can be placed on a desk or tabletop or mounted on a standard telephone wall plate.
- You should charge your new phone for 15-20 hours before completing the installation or using the handset.

Telephone Line Outlets

There are two types of phone outlets:

Modular Jack

Most phone equipment available now uses modular jacks. Phone cords are fitted with a molded plastic connector which plugs into this type of jack. If you do not have modular phone jacks, contact your local telephone company for information about their installation.

Hardwired Jack

Some equipment is wired directly to a phone jack, and these types of installations require a modular jack converter. This type of installation is not difficult; however, you should contact your Uniden telephone dealer or a telephone supply store for advice about the proper adapter or converter for your particular situation.

Connecting the Telephone Cords

Consider these safety guidelines before connecting the telephone cords:

Caution!

- *Never install telephone wiring during a lightning storm.*
- *Never touch uninsulated telephone wires or terminals unless the telephone line has been disconnected.*
- *Use caution when installing or modifying telephone lines.*

Applying Power to the Base

This phone requires an AC outlet, without a switch to interrupt power, and the included AC adapter. To relieve strain on the DC plug when the phone is placed on a desk or table, wrap the power cord around the strain relief notch on the back of the base.

NOTE: *Place the power cord so that it does not create a trip hazard, or where it could become chafed and create a fire or other electrical hazards.*

One Year Limited Warranty

Important: Evidence of original purchase is required for warranty service. **WARRANTOR:** UNIDEN AMERICA CORPORATION ("Uniden")

ELEMENTS OF WARRANTY: Uniden warrants, for one year, to the original retail owner, this Uniden Product to be free from defects in materials and craftsmanship with only the limitations or exclusions set out below.

WARRANTY DURATION: This warranty to the original user shall terminate and be of no further effect 12 months after the date of original retail sale. The warranty is invalid if the Product is (A) damaged or not maintained as reasonable or necessary, (B) modified, altered, or used as part of any conversion kits, subassemblies, or any configurations not sold by Uniden, (C) improperly installed, (D) serviced or repaired by someone other than an authorized Uniden service center for a defect or malfunction covered by this warranty, (E) used in any conjunction with equipment or parts or as part of any system not manufactured by Uniden, or (F) installed or programmed by anyone other than as detailed by the owner's manual for this product.

STATEMENT OF REMEDY: In the event that the product does not conform to this warranty at any time while this warranty is in effect, warrantor will either, at its option, repair or replace the defective unit and return it to you without charge for parts, service, or any other cost (except shipping and handling) incurred by warrantor or its representatives in connection with the performance of this warranty. Warrantor, at its option, may replace the unit with a new or refurbished unit. **THE LIMITED WARRANTY SET FORTH ABOVE IS THE SOLE AND ENTIRE WARRANTY PERTAINING TO THE PRODUCT AND IS IN LIEU OF AND EXCLUDES ALL OTHER WARRANTIES OF ANY NATURE WHATSOEVER, WHETHER EXPRESS, IMPLIED OR ARISING BY OPERATION OF LAW, INCLUDING, BUT NOT LIMITED TO ANY IMPLIED WARRANTIES OF MERCHANTABILITY OR FITNESS FOR A PARTICULAR PURPOSE. THIS WARRANTY DOES NOT COVER OR PROVIDE FOR THE REIMBURSEMENT OR PAYMENT OF INCIDENTAL OR CONSEQUENTIAL DAMAGES.** Some states do not allow this exclusion or limitation of incidental or consequential damages so the above limitation or exclusion may not apply to you.

LEGAL REMEDIES: This warranty gives you specific legal rights, and you may also have other rights which vary from state to state. This warranty is void outside the United States of America and Canada.

PROCEDURE FOR OBTAINING PERFORMANCE OF WARRANTY: If, after following the instructions in the owner's manual you are certain that the Product is defective, pack the Product carefully (preferably in its original packaging). The Product should include all parts and accessories originally packaged with the Product. Include evidence of original purchase and a note describing the defect that has caused you to return it. The Product should be shipped freight prepaid, by traceable means, to warrantor at:

Uniden America Corporation

Parts and Service Division
4700 Amon Carter Blvd. Fort Worth, TX 76155

(800) 297-1023, 8 a.m. to 5 p.m. Central, Monday through Friday

I.C. Notice

TERMINAL EQUIPMENT

NOTICE: This equipment meets the applicable Industry Canada Terminal Equipment Technical Specifications. This is confirmed by the registration number. The abbreviation, IC, before the registration number signifies that registration was performed based on a Declaration of Conformity indicating that Industry Canada technical specifications were met. It does not imply that Industry Canada approved the equipment.

NOTICE: The Ringer Equivalence Number (REN) for this terminal equipment is marked on the equipment itself. The REN assigned to each terminal equipment provides an indication of the maximum number of terminals allowed to be connected to a telephone interface. The termination on an interface may consist of any combination of devices subject only to the requirement that the sum of the Ringer Equivalence Numbers of all the devices does not exceed five.

RADIO EQUIPMENT

The term "IC:" before the radio certification number only signifies that Industry Canada technical specifications were met.

Operation is subject to the following two conditions: (1) this device may not cause interference, and (2) this device must accept any interference, including interference that may cause undesired operation of the device. "Privacy of communications may not be ensured when using this telephone".

Index

A	
AC adapter information	63
Adjusting ringer and earpiece volume	20
Announce only feature	45
Answering system	
Deleting a message	52
Playing a message	50
Recording a conversation	53
Remote access	54
Repeating a message	50
Skipping a message	51
Turning on/off	40
B	
Battery pack	
Information	63
Install	8
Maintenance	9, 57
Preparing and charging	11
Replacement and handling	57
Beltclip installation	56
C	
Caller ID	
Caller ID service	33
Call Waiting	22
Deleting	35
Making a call	37
Viewing	34
Clock	42
Channel	22
Connection	10
D	
Dial mode	17
Digital security code	56
E, F, G	
Earpiece volume	20
General information	63
Find handset	22
H	
Headset installation	57
I, J, K, L	
I.C. Notice	66
Installing the phone	7
Interference	65
Language	18, 47
M, N, O	
Maintenance	57
Making a call	19
Menu mode	16
Message alert	46
Mounting on a wall	12
Outgoing message	47

P, Q	
Personal security code (PIN code) ..	43
Precautions	64

R	
Receiving a call	19
Redialing a call	19
Remote access	54
Ring time	44
Ringer tone and volume	20
RocketDial	31

S	
Setting menu display options	16
Setting up the handset	8
Speed dialing	
Editing a stored name and/or phone number	28
Erasing a stored name and phone number	30
Making calls from Speed Dial Memory	26
Storing phone numbers and names	23

T, U, V, W, X, Y, Z	
Technical information	63
Troubleshooting	58
Warranty	65

Note

Remote Operation Card

C U T

REMOTE OPERATION CARD

Uniden®

Remote access away from home

Turn on the answering system remotely

1. Call your phone number from a touch-tone phone.
 2. During the outgoing message, press 0 and enter your PIN code. The answering system announces the number of messages stored in memory and the help menu. The phone stands by for you to enter a command.
 3. To quit, hang up the phone.
1. Call your phone and let it ring 10 times until it answers.
 2. Press 0 and enter your PIN code.
 3. Press 0 then 5 to stop the announcement.
 4. Press 0 then 6 to turn the answering system on.

C U T

REMOTE OPERATION CARD

Uniden®

Remote access away from home

Turn on the answering system remotely

1. Call your phone number from a touch-tone phone.
 2. During the outgoing message, press 0 and enter your PIN code. The answering system announces the number of messages stored in memory and the help menu. The phone stands by for you to enter a command.
 3. To quit, hang up the phone.
1. Call your phone and let it ring 10 times until it answers.
 2. Press 0 and enter your PIN code.
 3. Press 0 then 5 to stop the announcement.
 4. Press 0 then 6 to turn the answering system on.

C U T

REMOTE OPERATION CARD

Uniden®

Remote access away from home

Turn on the answering system remotely

1. Call your phone number from a touch-tone phone.
 2. During the outgoing message, press 0 and enter your PIN code. The answering system announces the number of messages stored in memory and the help menu. The phone stands by for you to enter a command.
 3. To quit, hang up the phone.
1. Call your phone and let it ring 10 times until it answers.
 2. Press 0 and enter your PIN code.
 3. Press 0 then 5 to stop the announcement.
 4. Press 0 then 6 to turn the answering system on.

C U T

REMOTE OPERATION CARD

Uniden®

Remote access away from home

Turn on the answering system remotely

1. Call your phone number from a touch-tone phone.
 2. During the outgoing message, press 0 and enter your PIN code. The answering system announces the number of messages stored in memory and the help menu. The phone stands by for you to enter a command.
 3. To quit, hang up the phone.
1. Call your phone and let it ring 10 times until it answers.
 2. Press 0 and enter your PIN code.
 3. Press 0 then 5 to stop the announcement.
 4. Press 0 then 6 to turn the answering system on.

Remote Operation Card

C U T

Task	Key
Repeat a Message	0 1
Playing Incoming Messages	0 2
Skipping a Message	0 3
Deleting a Message	0 4
Stop Operation	0 5
Answering System On	0 6
Memo Record/Stop	0 7
Greeting Message Record/Stop	0 8
Answer System Off	0 9
Help menu	1 0

C U T

Task	Key
Repeat a Message	0 1
Playing Incoming Messages	0 2
Skipping a Message	0 3
Deleting a Message	0 4
Stop Operation	0 5
Answering System On	0 6
Memo Record/Stop	0 7
Greeting Message Record/Stop	0 8
Answer System Off	0 9
Help menu	1 0

C U T

Task	Key
Repeat a Message	0 1
Playing Incoming Messages	0 2
Skipping a Message	0 3
Deleting a Message	0 4
Stop Operation	0 5
Answering System On	0 6
Memo Record/Stop	0 7
Greeting Message Record/Stop	0 8
Answer System Off	0 9
Help menu	1 0

C U T

Task	Key
Repeat a Message	0 1
Playing Incoming Messages	0 2
Skipping a Message	0 3
Deleting a Message	0 4
Stop Operation	0 5
Answering System On	0 6
Memo Record/Stop	0 7
Greeting Message Record/Stop	0 8
Answer System Off	0 9
Help menu	1 0

At Uniden, we'll take care of you!

If you need any assistance with this product, please call our Customer Hotline at **1-800-297-1023**

or visit our web site at www.uniden.com

PLEASE DO NOT RETURN THIS PRODUCT TO THE PLACE OF PURCHASE.

Our Uniden representatives will be happy to help you with any matters regarding the operation of this unit, available accessories, or any other related matters.

Thank you for purchasing a Uniden product.

Hours: M-F 8:00 AM to 5:00 PM CST.



For information on the accessibility features of this product, please call

1-800-874-9314 (V/TTY)

May be covered under one or more of the following U.S. patents:

4,523,058	4,595,795	4,797,916	5,381,460	5,426,690	5,434,905
5,491,745	5,493,605	5,533,010	5,574,727	5,581,598	5,650,790
5,660,269	5,661,780	5,663,981	5,671,248	5,696,471	5,717,312
5,732,355	5,754,407	5,758,289	5,768,345	5,787,356	5,794,152
5,801,466	5,825,161	5,864,619	5,893,034	5,912,968	5,915,227
5,929,598	5,930,720	5,960,358	5,987,330	6,044,281	6,070,082
6,125,277	6,253,088	6,314,278	6,418,209		

FOR
ACCESSORIES,
GO ONLINE @
WWW.UNIDEN.COM

REGISTER ONLINE TODAY!
THANK YOU FOR BUYING A UNIDEN PRODUCT.

A World Without Wires | **Uniden**[®]

Free Manuals Download Website

<http://myh66.com>

<http://usermanuals.us>

<http://www.somanuals.com>

<http://www.4manuals.cc>

<http://www.manual-lib.com>

<http://www.404manual.com>

<http://www.luxmanual.com>

<http://aubethermostatmanual.com>

Golf course search by state

<http://golfingnear.com>

Email search by domain

<http://emailbydomain.com>

Auto manuals search

<http://auto.somanuals.com>

TV manuals search

<http://tv.somanuals.com>