

**QUICK
EASY STEPS**
FOR SETTING UP YOUR PHONE!
SEE YOUR QUICK REFERENCE GUIDE SECTION

Uniden®



900MHz

DUAL HANDSET SYSTEM WITH CALLER ID

DXI 386-2
OWNER'S MANUAL

www.uniden.com

Contents

Welcome/Features	2	Making Calls with Memory Dialing	27
Quick Reference Guide	3	Chain Dialing	28
Controls and Functions	4	Editing a Stored Name and/or Phone Number	29
Getting Started		Erasing a Stored Name and Phone Number	31
Read this First	6	RocketDial	
Checking the Package Contents	7	RocketDial	32
Setting up the Phone	8	Storing and Editing the RocketDial	32
Before Using, Register Extra Handset to		Making Calls with the RocketDial	32
Main Base Unit	12	Deleting the RocketDial	33
When to Re-register Handsets	13	Caller ID Features	
Call Transfer Feature	13	Caller ID	34
Mounting the Main Base Unit on a Wall	14	When the Telephone Rings	34
Terminology	15	Viewing the Caller ID Message List	35
Setting Menu Options	16	Deleting Information from the Caller ID List	36
Basics		Using the Caller ID List	38
Making and Receiving Calls	19	Additional Information	
Adjusting the Handset Ringer and		Changing the Digital Security Code	40
Earpiece Volume	20	Installing the Beltclip	40
Redial	21	Headset Installation	40
Tone Dialing Switch-over	21	Note on Power Sources	41
Traveling Out-of-Range	21	Maintenance	41
Selecting a Different Channel	22	Troubleshooting	42
Page	22	General Information	44
Flash and Call Waiting	22	Precautions & Warranty	45
Memory Dialing		I.C. Notice	47
Storing Phone Numbers and Names	23	Index	48
Steps for Entering Names and Special Characters	25		

Welcome

Congratulations on your purchase of the Uniden DXI386-2 series cordless telephone. This phone is designed and engineered to exacting standards for reliability, long life, and outstanding performance.

Note: Some illustrations in this manual may differ from the actual unit for explanation purpose. The color of your cordless phone may vary.



As an ENERGY STAR® Partner, Uniden has determined that this product or product models meets the ENERGY STAR® guidelines for energy efficiency. ENERGY STAR® is a U.S. registered mark.

Features

- Dual Handsets
- 900 MHz Extended Range Technology
- 3 Line Backlit Display
- Caller ID and Call Waiting Caller ID (each handset)
- RocketDial (each handset)
- 10 Number Memory Dialing (each handset)
- The Keypad Facing Forward Charging
- 32 Digit Redial
- Flash and Pause
- Tone/Pulse Dialing
- Page/Find handset
- 7 Hour Talk Time/10 Day Standby Time
- Handset Earpiece and Ringer Volume Control
- Hearing Aid Compatible
- 20 Channel Autoscan
- Call Transfer

The DXI386-2 series features include **AutoTalk™** and **AutoStandby™**. AutoTalk allows you to answer a call by just removing the handset from the main base so you don't have to waste time pushing buttons or flipping switches. AutoStandby allows you to hang up by simply returning the handset to the main base.

The **UltraClear Plus™** true compander circuitry virtually eliminates background noise. This innovative technology, together with 20 different channels, provides you with the best possible reception during all your conversations.

To protect you against misbilled calls which might result from your phone being activated by other equipment, the DXI386-2 series has **Random Code™** digital security which automatically selects one of over 260,000 digital security codes for the handset and base. Also, the **AutoSecure™** feature electronically locks your phone when the handset is in the main base.

RocketDial™ is a one touch speed dial key that automatically dials your most important or frequently called number. The number dialed, is a preset number stored by the user.

Call Transfer allows you to transfer outside calls from handset to handset, only one handset at a time can talk with an outside caller.

Be sure to visit our web site: www.uniden.com

Uniden® is a registered trademark of Uniden America Corporation.

AutoTalk, AutoStandby, UltraClear Plus, Random Code, AutoSecure, and RocketDial are trademarks of Uniden America Corporation.

Step 1 Charging the Batteries

TO INSTALL THE HANDSET BATTERIES

- 1 Remove the cover.

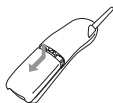

- 2 Connect the battery pack connector with the correct polarity.

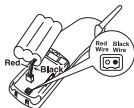

- 3 Replace the cover.



TO PLUG INTO AC POWER

- 1 Plug AC adapter cord into the main base unit and extra charging cradle and then into a 120V AC outlet.

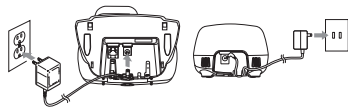

- 2 Place one handset in the main base and place the other handset in the extra charging cradle. It does not matter which handset is placed in the main base and extra charging cradle.

Note: You must charge the batteries continuously for 15 - 20 hours before using the phone.

Step 2 Connecting

CONNECT TO A PHONE LINE

When the handset battery pack is fully charged, after 15-20 hours of charging, plug the telephone cord into the main base unit and then into a telephone wall jack.

Your phone is set for tone dialing. If your local network requires pulse dialing, please see "Choose the dialing mode" on page 17.

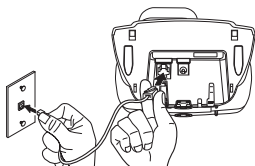

Step 3 Before Using, Register Extra Handset to Base

- 1 After fully charging the handsets, remove the handset from the extra charging cradle and place it in the main base unit. (Base LED light will begin to flash indicating registration is occurring.)
- 2 Wait for at least 5 seconds before removing the extra handset from the main base.

Congratulations, the registration has been completed, and your dual handset cordless phone is ready for use!

Step 4 Setting Up the Caller ID

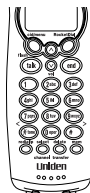

Note: Three Caller ID options are available: AutoTalk, Caller ID on Call Waiting (CIDCW), and Area ID.

Note: CIDCW can only be changed on HS1.

TO CHANGE CALLER ID OPTIONS

- 1 Press and hold *cid/menu*.
- 2 Press \wedge or \vee to move the pointer to an option.
- 3 Press *select/channel* to change the option setting.
- 4 Press *end* and return the handset to the main base.

Controls and Functions

Dual Handsets

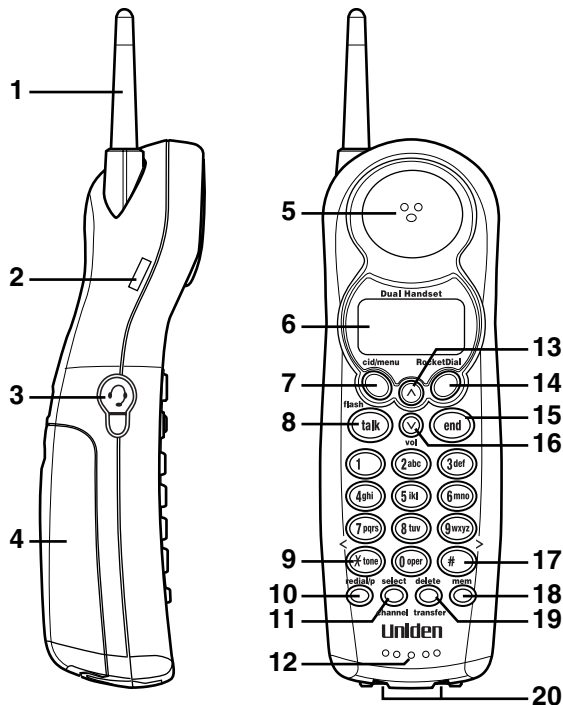

1. Handset antenna
2. Beltclip holes
3. Optional headset jack
4. Handset battery compartment
5. Handset earpiece
6. LCD display
7. Caller ID/menu key
8. Talk/flash key
9. * /tone/left cursor (<) key
10. Redial/pause (p) key
11. Select/channel key
12. Handset microphone and ringer speaker
13. Volume up (^) key
14. RocketDial key
15. End key
16. Volume down (v) key
17. # /right cursor (>) key
18. Memory (mem) key
19. Delete/transfer key
20. Handset charging contacts

Main Base

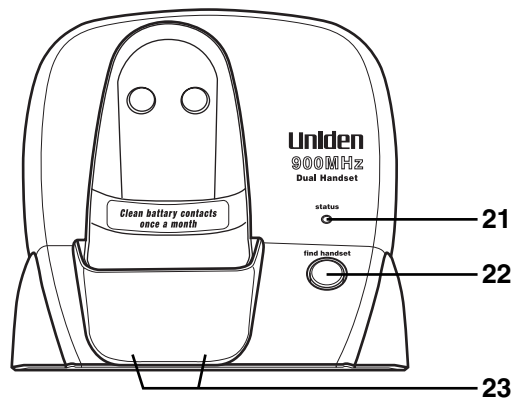

- 21. Status LED
- 22. Find handset key
- 23. Base charging contacts
- 24. Telephone line jack
- 25. DC IN 9V jack
- 26. Charging contacts
- 27. Charge LED
- 28. DC IN 9V jack

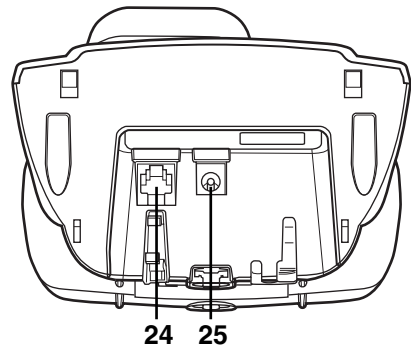

Extra Charging Cradle

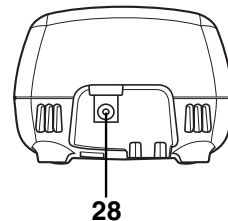
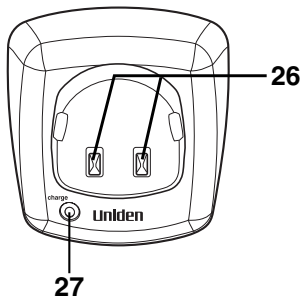

Read this First

This cordless telephone must be set up before use. Follow these steps:

Step 1 (page 7)

Unpack the telephone and accessories.

Step 2 (page 8)

Next, choose the best location to set up the main base unit.



Step 3 (page 9 to 11)

Then, insert the battery packs into the handsets. Connect the main base unit and extra charging cradle. You must charge the battery packs for **15-20 hours before plugging into the telephone line and using the phone.**



Step 4 (page 12)

After fully charging the handsets, remove the handset from the extra charging cradle and place it in the main base cradle for at least 5 seconds.

note

Conveniently, your cordless phone allows you to transfer outside calls from handset to handset, simply by pressing the **transfer** key. Not to worry, conversations will not be interrupted; only one handset at a time can talk with an outside caller. The second handset cannot go off hook to listen to conversations or make an outgoing call while the other handset is in use.

Checking the Package Contents

Make sure you have received the following items in the package. If any of these items are missing or damaged, contact the Uniden Parts Department.

- **Main base unit (1)**
- **Handset (2)**
- **AC adapter (2)**
- **Rechargeable battery (2)**
- **Telephone cord (1)**
- **Beltclip (2)**
- **Extra charging cradle (1)**
- **This owner's manual**
- **Other printed materials**

Uniden Parts Department at (800) 554-3988
Hours: M-F 7:00 a.m. to 5:00 p.m. CST. We can also be
reached on the web at www.uniden.com

Setting up the Phone

Do the following steps:

- A. Choose the best locations
- B. Install the battery packs
- C. Connect the main base unit and the extra charging cradle

A. Choose the best location

Before choosing a location for your new phone, read the INSTALLATION CONSIDERATIONS included in the PRECAUTIONS AND IMPORTANT SAFETY INSTRUCTIONS brochure. Here are some important guidelines you should consider:

Avoid heat sources, such as radiators, air ducts, and sunlight

Avoid television sets and other electronic equipment

Choose a central location

Avoid noise sources such as a window by a street with heavy traffic

Avoid microwave ovens

Avoid excessive moisture, extremely low temperatures, dust, mechanical vibration, or shock

Avoid personal computers

Avoid other cordless telephones

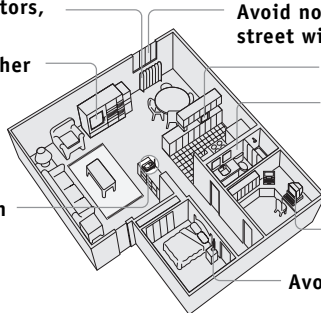

- The location should be close to both a phone jack and a continuous power outlet which is not switchable.
- Keep the main base and handsets away from sources of electrical noise such as motors, microwave ovens, and fluorescent lighting.
- The main base can be placed on a desk, tabletop, or mounted on a standard wall plate.

B. Install the battery packs

Charge the battery packs for at least 15-20 hours before plugging the phone line into your phone.

- 1) Press in on the battery cover release and slide the cover down until it comes off.
- 2) Connect the battery pack connector observing correct polarity (black and red wires) to the jack inside the battery compartment.

Do not exert any force on this connection. It could cause damage to the battery or to the handset. The plastic connectors will fit together in only one way. Once you are certain that you have made a good connection, then insert the battery pack into the battery compartment. Do not pinch the wires.

- 3) Securely close the battery compartment cover by sliding it up until it snaps into place.
- 4) Place one handset in the main base with the keypad facing forward. Place the other handset in the extra charging cradle.

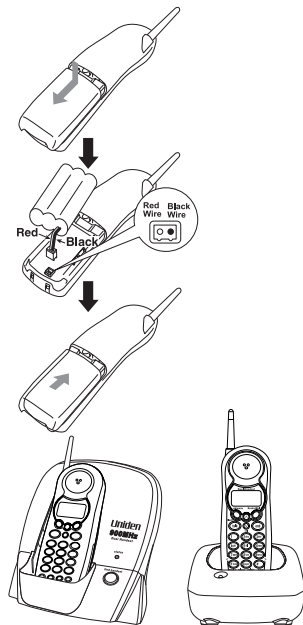

- Use only the Uniden battery (BT-905) supplied with your phone. Replacement batteries are also available through the Uniden Parts Department. (See page 7.)
- Place the extra handset in the charger with the keypad facing forward for 15-20 hours before use.



Even when the battery pack is not being used, it will gradually discharge over a long period of time. For optimum performance, be sure to return the handset to the main base unit after a telephone call.

Battery use time (per charge)

From fully charged (15-20 hours charge time)

- Seven hours continuous use
- Ten days when the handset is in the standby mode

Low Battery Alert

When the battery pack is very low and needs to be charged, the phone is programmed to eliminate functions in order to save power. If the phone is not in use, "Low Battery" appears on the LCD and none of the keys will operate.

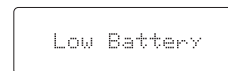

If the phone is in use, "Low Battery" flashes and the handset beeps. Complete your conversation as quickly as possible and return the handset to the main base unit for charging.



The last number dialed in the redial memory, the names and the numbers stored in the memory locations are retained for up to 30 minutes while you replace the battery pack.

Cleaning the Battery Charging Contacts

To maintain a good charge, it is important to clean the battery contacts on the handsets and main base unit as well as the extra charging cradle with a dry cloth or a pencil eraser about once a month.

Do not use any liquids or solvents.

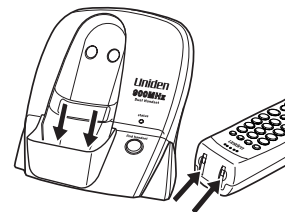

contacts

C. Connect the main base unit and the extra charging cradle

- 1) Connect the AC adapter to the DC IN 9V jack and to a standard 120V AC wall outlet.
- 2) Set the main base and extra charging cradle on a desk or tabletop, and place one handset in the main base unit and one in the extra charging cradle.
- 3) Make sure that the **status** LED illuminates. If the LED does not illuminate, check to see that the AC adapter is plugged in and that the handset makes good contact with the main base charging contacts.

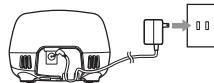
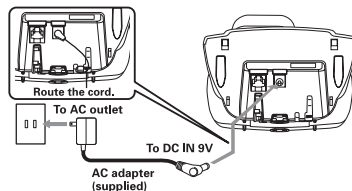

- note**
- Use only the supplied AD-311 AC adapter. Do not use any other AC adapter.
 - Connect the AC adapter to a continuous power supply.
 - Place the main base unit close to the AC outlet so that you can unplug the AC adapter easily.
- After installing the battery packs in the handsets, charge your handsets at least **15-20 hours before plugging into the phone line**. Once the handsets battery packs are fully charged, connect the telephone line cord to the main base and telephone wall outlet.
- 4) Connect the telephone line cord to the **TEL LINE** jack and to a telephone outlet once the handset is fully charged.



If your telephone outlet isn't modular, contact your telephone company for assistance.

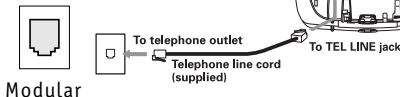

Place the handset in the main base with the keypad facing forward for charging.



Place the power cord so that it does not create a trip hazard or where it could become chafed and create a fire or electrical hazard.



- When you charge the handset, Caller ID summary screen and the name of the handset, HS1 appears. If HS2 appears, you are charging the handset No.2.

New	:01	HS1
Total	:02	

- The smaller cradle is simply an extra charging device for either handset.

Before Using, Register Extra Handset to the Main Base Unit

When the dual handsets are removed from the packaging, the handset that is placed in the main base unit first (to charge battery for 15-20 hours), will automatically be registered to the main base unit. (It does not matter which handset you choose to place in the main base unit first).

You will also need to register the extra handset by placing it in the main base cradle. The extra handset WILL NOT operate properly until the registration has been completed. Once the handset is registered, it is ready for use.

Follow these simple steps to register:

- 1) First, install the battery packs in both handsets. Place either handset in the main base cradle, then place the extra handset in the extra charging cradle. Charge both handsets **for 15-20 hours**.
- 2) After fully charging both batteries, remove the handset in the extra charging cradle, and place it in the main base cradle. The LED light on the main base will begin to flash, indicating that the registration is taking place between the extra handset and the main base.
- 3) Wait for at least 5 seconds before removing the handset from the main base.

Congratulations, the registration has been completed, and your dual handset cordless phone is ready for use!



- If the extra handset's battery becomes very low, the handset must be recharged for 15-20 hours and re-registered to the main base unit.
- Make sure to return the handsets to the charging cradles after each phone call.
- If you transfer the call and it is not picked up after 5 minutes, the call will be disconnected.

When to Re-register Handsets

- 1) You'll need to re-register the extra handset (follow steps on page 12) each time the digital security code is changed. Refer to page 40 for details regarding the Digital Security Code.
- 2) When there is a power failure for more than one hour
If power failure occurs (e.g. due to electrical storm or if the unit is unplugged during a move), both handsets will need to be re-registered. To re-register, follow the same registration process on page 12.

Call Transfer Feature

Conveniently, your cordless phone allows you to transfer outside calls from handset to handset, simply by pressing the **transfer** key. Not to worry, conversations will not be interrupted; only one handset at a time can talk with an outside caller. The second handset cannot go off hook to listen to conversations or make an outgoing call while the other handset is in use.

To transfer a call (to the second handset)

- 1) Press **delete/transfer** during a call. The call will automatically be placed on hold and the transfer tone sounds.
- 2) When the other handset receives the call, the transfer tone stops. To cancel the transfer, press **delete/transfer** or **talk/flash** on the handset.

Hold
Transfer Call

To receive a transferred call (from the second handset)

Pick up the handset (when AutoTalk is set to On), or pick up the handset and press **talk/flash** to answer the transferred call. Additionally, you can answer the transferred call by pressing any number key, ***/tone/<**, or ***/>** (when AutoTalk is set to On).

Transfer Call



DO NOT use an AC outlet controlled by a wall switch.

Mounting the Main Base Unit on a Wall

Standard wall plate mounting

This phone can be mounted on any standard wall plate.

- 1) Plug the AC adapter into the **DC IN 9V** jack.
- 2) Wrap the AC adapter cord inside the molded wiring channel as shown.
- 3) Plug the AC adapter into a standard 120V AC wall outlet.
- 4) Plug the telephone line cord into the **TEL LINE** jack. Wrap the cord inside the molded wiring channel as shown.
- 5) Plug the telephone line cord into the telephone outlet.
- 6) Align the mounting slots on the main base with the mounting posts on the wall. Then push in and down until the phone is firmly seated.

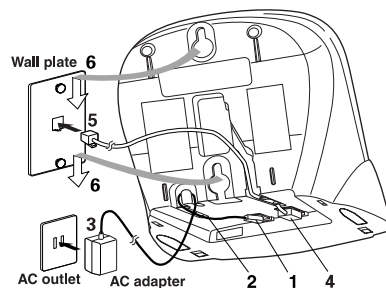

Direct wall mounting

If you don't have a standard wall plate, you can mount your phone directly to the wall. Before doing this, consider the following:

- Avoid electrical cables, pipes, or other items behind the mounting location that could cause a hazard when inserting screws into the wall.
- Try to mount your phone within 5 feet of a working phone jack to avoid excessive lengths.
- Make sure the wall material is capable of supporting the weight of the main base and handset.
- Use #10 screws (minimum length of 1-3/8 inches) with anchoring devices suitable for the wall material where the main base unit will be placed.

1) Insert two mounting screws into the wall, (with their appropriate anchoring device), 3-15/16 inches apart. Allow about 1/8 of an inch between the wall and screw heads for mounting the phone.

2) Refer to steps 1 through 6 on page 14 to mount the telephone.

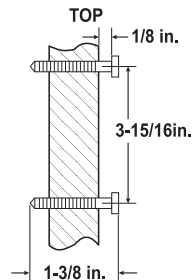

Terminology

Throughout this manual, terms such as Standby and Talk Mode are used. Below is the terminology explanation.

- **Standby Mode** - The handset is not in use, off the main base or extra charging cradle, and *talk/flash* has not been pressed. A dial tone is not present.
- **Talk Mode** - The handset is off the main base or extra charging cradle and *talk/flash* has been pressed enabling a dial tone.



- AutoTalk and Area Code settings can be also changed from handset 2. The following screen appears.

```
1▶Auto Talk:Off
2 Area Code:
```

- CIDCW On/Off setting can be changed from handset 1. To confirm which handset is HS1, look at the display indicating "HS1" or "HS2".
- If your calling area requires 10-digit dialing, do not program this option.

Setting Menu Options

There are four setup options available. They are Caller ID options [AutoTalk, CIDCW (Caller ID on Call Waiting), Area Code] and Dial Mode.

AutoTalk allows you to answer the phone without pressing the **talk/flash** button. If the phone rings when AutoTalk is on, simply remove the handset from the main base and the phone automatically answers the call. If the phone rings when AutoTalk is off, you must press **talk/flash** to answer the call.

Caller ID options

To change your AutoTalk and CIDCW:

1) Press and hold **cid/menu**. The following screen appears.

```
1▶Auto Talk:Off
2 CIDCW      :On
3 Area Code:
```

2) Use **^** and **v** or a number key (1 and 2) to move the pointer to the selection that you would like to change.

Press **select/channel** to toggle between "On" and "Off" for AutoTalk and CIDCW.

3) Press **end** and return the handset to the main base unit. The handset returns to the standby mode.

To enter your Area Code

If you enter a 3-digit area code number in the Area Code option, your local area code does not appear in Caller ID messages. Do not program this option, if your calling area requires 10-digit dialing.

When reviewing Caller ID messages, you will see only the local seven digit number. For calls received from outside your local area code, you will see a full 10-digit number.

1) When the phone is in the standby mode, press and hold **cid/menu**. The Caller ID setting screen appears.

```
1▶Auto Talk:Off
2 CIDCW      :On
3 Area Code:
```

2) Press **3** or press **∨** twice to select "Area Code".

```
1 Auto Talk:Off
2 CIDCW      :On
3▶Area Code:
```

3) Press **select/channel**.

```
1 Auto Talk:Off
2 CIDCW      :On
3 Area Code:█
```

4) Use the number keys (**0 to 9**), **#/ >**, ***/tone/ <** or **delete/transfer** to enter the 3-digit area code.

5) Press **select/channel**. A confirmation tone sounds and the displayed area code is entered.

6) Press **end** or return the handset to the main base unit. The handset returns to the standby mode.

When the area code has already been stored in memory, the stored area code will be displayed. To change it, use the **delete/transfer** and number keys to enter the new area code.

Then press **select/channel**. A confirmation tone sounds.

To complete the setting, press **end** or return the handset to the main base unit.

note

```
1 Auto Talk:Off
2 CIDCW      :On
3 Area Code:817
```

note

Make sure your battery pack is fully charged before choosing the dial mode.

Choosing the dialing mode

Most phone systems use tone dialing which sends DTMF tones through the phone lines. However some phone systems still use pulse dialing such as in rural areas. The default setting is tone dialing. Depending on your dialing system, set the mode as follows:



Dialing mode can only be changed from handset 1.

To confirm which handset is HS1, look at the display indicating "HS1" or "HS2".

- 1) When the phone is in the standby mode, press and hold **cid/menu**. The following screen appears.
- 2) Press **4** or press **▼** three times to select "Dial".
- 3) Press **select/channel** to toggle between "Tone" and "Pulse" for each setting.
- 4) Press **end** and return the handset to the main base unit. The handset returns to the standby mode.
 - If you are not sure of your dialing system, set for tone dialing. Make a trial call. If the call connects, leave the setting as is, otherwise set for pulse dialing.
 - If your phone system requires pulse dialing and you need to send the DTMF tones for certain situations during a call, you may "switch-over" to tone dialing. (Refer to "Tone Dialing Switch-over" on page 21.)

```
1▶Auto Talk:Off
2 CIDCW      :On
3 Area Code:
```

```
2 CIDCW      :On
3 Area Code:
4▶Dial       :Tone
```

Making and Receiving Calls



Refer to page 16 "Setting Menu Options" to turn on the AutoTalk feature if desired.

	Handset On Base	Handset Off Base
To answer a call	Pick up the handset (AutoTalk) or pick up the handset and press talk/flash .	Press talk/flash , any number, */tone/ < or #/ > (AutoTalk).
To make a call	1) Pick up the handset. 2) Press talk/flash . 3) Listen for the dial tone. 4) Dial the number. OR	1) Press talk/flash . 2) Listen for the dial tone. 3) Dial the number. OR
	1) Pick up the handset. 2) Dial the number, then press talk/flash .	Dial the number, then press talk/flash .
To hang up	Press end , or return the handset to the main base or extra charging cradle (AutoStandby).	
To redial	1) Pick up the handset. 2) Press talk/flash . 3) Listen for the dial tone. 4) Press redial/p . OR	1) Press talk/flash . 2) Listen for the dial tone. 3) Press redial/p . OR
	1) Pick up the handset. 2) Press redial/p , then press talk/flash .	Press redial/p , then press talk/flash .

Adjusting the Handset Ringer and Earpiece Volume





If you select “Ringer Off”, “<Ringer Off>” appears on the display when you make or receive calls, or charging the handset.

Handset ringer tone and volume

Press \wedge or \vee in standby mode to select one of five ringer tones and volume combinations.

Earpiece volume

Pressing \wedge or \vee during a call will change the earpiece volume of the handset. This setting will remain in effect after the telephone call has ended.

Volume Maximum  Volume High  Volume Medium  Volume Low



When you press \wedge in Maximum mode or \vee in Low mode, the handset beeps rapidly.

Ringer Mute

You can temporarily mute the ringer tone. When the handset is off the main base and the phone is ringing, press **end** to stop the incoming ring. The ringer tone will return to normal starting with the next incoming call.

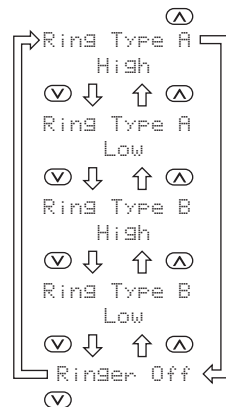

Redial

The **redial/p** key redials the last number dialed. The redialed number can be up to 32 digits long.

Tone Dialing Switch-over

Some telephone companies use equipment that requires pulse dialing (sometimes referred to as rotary dialing). If you need to enter tone dialing digits, you can switch-over to tone dialing during the call. For example, entering your bank account number after you have called your bank.

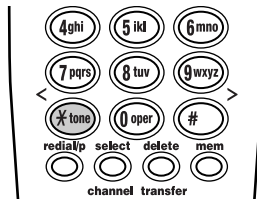

Initially make your call with the pulse dialing mode. Once your call connects, press ***/tone/ <**. Enter the desired number. These digits will be sent as tone dialing. Once the call ends, the tone mode is canceled and pulse dialing mode resumes.

Traveling Out-of-Range

During a call, as you begin to move your handset too far from your base unit, noise increases. If you pass the range limits of the main base unit, your call will terminate within 5 minutes.



- The tone feature only applies when the dial mode is set to pulse.
- This special number can be stored in a memory location. This is referred to as Chain Dialing (See page 28.)



You can change the phone's channel by pressing the **select/channel** key on either handset.



You can cancel paging by pressing the find handset key on the main base.

Selecting a Different Channel

If you encounter interference while using your phone, you can manually change the phone's channel for clear operation. This function works only when the phone is in use.

Press **select/channel**. "Scanning" appears on the display, indicating the phone is changing to another channel. For more information on interference, refer to "Precautions" on page 45.

Page

To locate the handset (while it's off the main base), press **find handset** on the main base. Both handsets beep for 60 seconds.

Paging of both handsets is canceled when pressing any key on either handset.

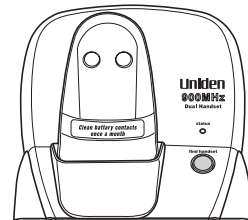

Flash and Call Waiting

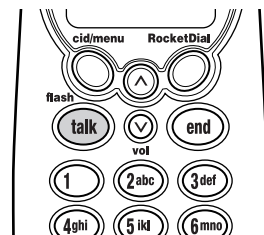

If you have "Call Waiting" service and a call waiting tone sounds while you are on a call, press **talk/flash** to accept the waiting call. There is a short pause, then you will hear the new caller. To return to the original caller, press **talk/flash** again.



You must subscribe through your local telephone company to receive Call Waiting Service.

Storing Phone Numbers and Names

Memory Dialing allows you to dial a number using just a few key presses. Your DXI386-2 series stores 10 names/numbers in each handset.

1) Press and hold **mem** until "Memory Store" is displayed.

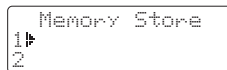
A rectangular screen with a monospaced font. The text reads "Memory Store" at the top. Below it, there are two options: "1" with a right-pointing arrow and "2".

```
Memory Store
1→
2
```

2) Press **^** or **v**, or enter a number (0 - 9) to select the memory location where you would like to store the number.

3) Press **select/channel**. The following screen appears and a cursor flashes indicating that the display is ready for the name to be entered.

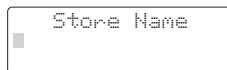
A rectangular screen with a monospaced font. The text reads "Store Name" at the top. Below it, there is a small square cursor.

```
Store Name
█
```

If this screen appears, the selected memory location is already stored. Then you must either edit the entry in this location, delete the entry in this location, or select "Go Back" to choose another location.

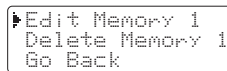
A rectangular screen with a monospaced font. The text reads "Edit Memory 1", "Delete Memory 1", and "Go Back" on three lines. A right-pointing arrow is to the left of the first line.

```
Edit Memory 1
Delete Memory 1
Go Back
```

4) To enter a name (up to 14 characters), use the number keys.

- See the "Steps for entering names and special characters". (See pages 25-26)
- Use **#/>** and ***/tone/<** to move the cursor to the desired location.
- Use **delete/transfer** to delete characters as needed.
- Press and hold **delete/transfer** to delete all the characters.
- If a name is not required, go to step 5.



You have 30 seconds after pressing **mem** to enter the number you wish to store. Otherwise, an error tone will sound.



The pause feature is useful for long distance calling, credit card dialing, or sequences that require a pause between digits.

5) Press **select/channel**. "Store Number" is displayed.
The cursor flashes indicating that the display is ready for the number to be entered.

```
Store Number
█
```

6) Use the number keys to enter the phone number.
The phone number cannot exceed 20 digits.
Use **redial/p** to enter a pause in the dialing sequence.
The display shows a "P". Each pause counts as one digit and represents a two second delay of time between the digits.
Use **delete/transfer** to delete digits as needed.

```
Store Number
8002971023█
```

7) Press **select/channel**. You will hear a confirmation tone, and the following screen appears. Memory storage is complete.

```
Memory 7 Stored
```

For example, if you store a name and number into memory location number 7, the display shows "Memory 7 Stored".

```
Memory Store
7▶UNIDEN CORP
8 <Memory 8>
```

After about 2 seconds, "Memory Store" is displayed. Repeat steps 2 - 7 to store more numbers.

8) Press **end** to return to standby mode.

Steps for Entering Names and Special Characters

Refer to the letters on the number keys to select the desired characters.

With each press of a numeric key, the displayed character appears in the following order: Upper case letters first, lower case letters next and finally the number corresponding to the key.

	Number of times key is pressed								
keys	1	2	3	4	5	6	7	8	9
1	1								
2abc	A	B	C	a	b	c	2		
3def	D	E	F	d	e	f	3		
4ghi	G	H	I	g	h	i	4		
5jkl	J	K	L	j	k	l	5		
6mno	M	N	O	m	n	o	6		
7pqrs	P	Q	R	S	P	q	r	s	7
8tuv	T	U	V	t	u	v	8		
9wxyz	W	X	Y	Z	w	x	y	z	9
0	*	#	-	&	()	(blank)	0	

If you make a mistake while entering a name

Use ***/tone/<** or ***/>** to move the cursor to the incorrect character. Press **delete/transfer** to erase the wrong character, then enter the correct character. To delete all characters, press and hold **delete/transfer**.

For example, to enter **Uniden**;

- 1) Pick up the handset and press and hold **mem**.
- 2) Enter a number or press **^**, **v** to select a memory location number.
- 3) Press **select/channel**.
- 4) Press **8** twice.
- 5) Press **6** five times.
- 6) Press **4** six times.
- 7) Press **3** four times, then press **#/>** to move the cursor to the right.



If the next character uses the same number key, you must press **#/>** to move the cursor over. Otherwise the next time you press the number key, it changes the character that was previously set.

- 8) Press **3** five times.
- 9) Press **6** five times.
- 10) When finished, press **select/channel**.

To continue to store the telephone number, proceed to step 6 on page 24.

Making Calls with Memory Dialing

Memory dialing from Standby Mode

1) Press **mem**.

The handset displays your programmed memory locations.

```
1▶UNIDEN CORP
2 JOHN DOE
3 MOM AND DAD
```

2) Press **∨** or **∧**, or enter the number (0 - 9) to select the memory location you would like to dial.

3) Press **talk/flash**. "Connecting" and the number you would like to dial appear on the display. Then the displayed number is dialed.

```
>Connecting<
0123456789012
```

Display a Programmed Number

Use **#/>** and ***/tone/<** to toggle between the names display and the numbers display.

Program name

Program number

```
1 UNIDEN CORP
2 JOHN DOE
3▶MOM AND DAD
```



```
1 8002971023
2 5452930
3▶8175551212
```



When the stored phone number has 15 or more digits, "▶" is displayed next to the 13th digit. Press **#/>** to see the extra digits and ***/tone/<** to return.

```
5 012345678901
6▶0118135543290▶
7
```



- If you press **select/channel** before **talk/flash**, you can confirm the name and the number stored in the selected memory location.
- To exit the memory dialing function without dialing, press **end**. The handset returns to standby.
- Whenever you are using a memory menu screen, you must press a key within 30 seconds or the phone will return to standby.



If you select a memory location that does not have a stored number, an error tone sounds and the phone will not dial.

Memory dialing from Talk Mode

1) Press **talk/flash**. "Connecting" appears.



2) After the display changes from "Connecting" to "Talk", press **mem**.

3) Enter a number (0 - 9) to select the memory location of the desired phone number. The selected phone number is displayed. Then the number is dialed.

4) To hang up, press **end**.

Chain Dialing

The memory locations on the handset are not limited to phone numbers. You can also store a group of numbers (up to 20 digits) that you need to enter once your call connects. This is referred to as Chain Dialing.

An example of this is a bank account number. Once you have called your bank, and are prompted to enter the account number, simply press **mem** and the location number where the special number has been stored.

Store your special number with an identifying name. (Refer to "Storing Phone Numbers and Names" on page 23.)

Editing a Stored Name and/or Phone Number

- 1) Press and hold **mem** until "Memory Store" is displayed.
- 2) Press **^** or **v**, or enter a number (0 - 9) to select the memory location you would like to edit.
- 3) Press **select/channel**.
The following screen appears with the memory location number that you have selected in the display.
- 4) Press **^** or **v** to select "Edit Memory", then press **select/channel**. The following screen appears. The cursor flashes indicating that the display is ready for the name to be edited. When a name has not been stored, the cursor appears at the beginning of the second line.
- 5) Use the number keys, ***/tone/<**, ***/>**, or **delete/transfer** to edit the name. (See page 23.)
To edit only the phone number, skip this step.
- 6) Press **select/channel**. The following screen appears.
The cursor flashes indicating that the display is ready for the number to be edited.

```
Memory Store
1 UNIDEN CORP
2 JOHN DOE
```

```
Edit Memory 2
Delete Memory 2
Go Back
```

```
Store Name
UNIDEN CORP
```

```
Store Number
8002971023
```

- 7) Use the number key, **redial/p** or **delete/transfer** to edit the phone number.
The phone number cannot exceed 20 digits. (See page 24.)
If you don't want to change the phone number, skip this step.
- 8) Press **select/channel**. You hear a confirmation tone, and the following screen appears. The memory storage is complete.
For example, if you store a name and number into memory location number 1, the display shows "Memory 1 Stored".
After about 2 seconds, "Memory Store" is displayed.
- 9) Press **end** to return to standby mode.

```
Memory 1 Stored
```

```
Memory Store  
1▶UNIDEN CORP  
2 JOHN DOE
```

Erasing a Stored Name and Phone Number

- 1) Press and hold **mem** until "Memory Store" is displayed.
- 2) Press **^** or **v**, or enter a number (0 - 9) to select the memory location you would like to erase.
- 3) Press **select/channel**.
The following screen appears with the memory location number that you have selected in the display.
- 4) Press **v** to move the pointer down to "Delete Memory".
- 5) Press **select/channel**. The following confirmation screen appears.
- 6) Press **^** to move the pointer to "Yes".
- 7) Press **select/channel** or **delete/transfer**.
You hear a confirmation tone, and the following screen appears.
- 8) After about 2 seconds, the display returns to the "Memory Store" screen.
You may delete the information in another memory location (return to step 2) or press **end** to return to standby mode.

```
Memory Store
1 UNIDEN CORP
2 JOHN DOE
```

```
Memory Store
1 UNIDEN CORP
2 JOHN DOE
```

```
Edit Memory 2
Delete Memory 2
Go Back
```

```
Edit Memory 2
Delete Memory 2
Go Back
```

```
Delete Memory 2?
Yes
No
```

```
Memory 2 Deleted
```

```
Memory Store
2 MOM AND DAD
3
```



- Memory location for the RocketDial is independent from the memory location for Memory dial.

- If the RocketDial does not have a stored number, an error tone sounds and the phone will not dial.

RocketDial

You can store your most frequently dialed number in the RocketDial location in each handset. The RocketDial allows you to dial a number with one key press. (There is no need to press *talk/flash*. The phone will automatically dial the number stored.)

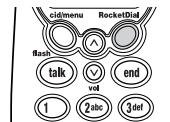

Storing and Editing the RocketDial

- 1) When the phone is in the standby mode, press and hold **RocketDial**. Following display appears.
If this screen appears, there is a number already stored. Press \wedge or \vee to select "Edit Number", then press *select/channel*.
- 2) Store the number by following step 6 under "Storing Phone Numbers and Names" on page 24.
- 3) Press *select/channel*.
You hear a confirmation tone, and the following screen appears. Memory storage is complete.

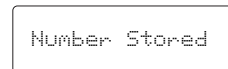
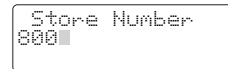
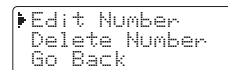
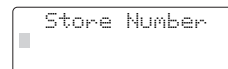

Making Calls with the RocketDial

When the phone is in the standby mode, simply press **RocketDial**. The number stored in the RocketDial memory location is instantly dialed.

Deleting the RocketDial

- 1) When the phone is in the standby mode, press and hold **RocketDial**. Following display appears.
- 2) Press **^** or **v** to select "Delete Number".
- 3) Press **select/channel**. Following display appears.
- 4) Press **^** to move the pointer to "Yes".
- 5) Press **select/channel** or **delete/transfer**.
You hear a confirmation tone, and the following display appears. After about 2 seconds, the handset returns to standby mode.

```
▸ Edit Number
Delete Number
Go Back
```

```
Delete Number?
Yes
▸ No
```

```
Number Deleted
```



- If you answer a call before the Caller ID message is received (Example: before the second ring), the Caller ID message will not appear.
- When the call is received via a telephone company that does not offer Caller ID service, the caller's phone number and name do not appear. (This includes international calls.)
- When the call is via a private branch exchange (PBX), the caller's phone number and name may not appear.

Caller ID

You must subscribe to Caller ID service to use this feature.

When the telephone rings, the Caller ID feature allows you to view the caller's name and phone number on the display before you answer the phone.

The handset displays the phone number of the incoming call, the name, and time. Additionally, you can dial the displayed number and store the information for memory dialing.

Make sure you have turned on the Caller ID/Call Waiting feature. (See page 16.)

When the Telephone Rings

- 1) When the Caller ID message is received, the display shows the caller's phone number along with the date and time. The incoming call information is stored in the Caller ID record. If the Caller ID service includes the caller's name, the caller's name appears on the display (up to 15 letters).

The date and time received — 5/11 12:30PM
Caller's name — UNIDEN CORP
Caller's phone number — 800-297-1023

Here are some typical displays;

When the phone number and name data are received

5/11 12:30PM
UNIDEN CORP
800-297-1023

When invalid data is received

Incomplete Data

When a private name is received

5/11 12:30PM
Private Name
800-297-1023

When a private number is received

5/11 12:30PM
UNIDEN CORP
Private Number

When an unknown name is received When an unknown number is received

```
5/11 12:30PM  
Unknown Name  
800-297-1023
```

```
5/11 12:30PM  
UNIDEN CORP  
Unknown Number
```

- 2) When you pick up the phone, the display changes to "Connecting". (AutoTalk feature is set to on.)



Data errors appear as "■".

Viewing the Caller ID Message List

The Caller ID list stores information for up to 30 incoming calls in each handset - even unanswered calls.

- 1) Press **cid/menu**.

The summary screen appears.

The screen shows the number of new messages and total messages.

```
New :01  
Total:02
```

- 2) Press **▼** to display the latest Caller ID message.

```
5/17 12:30PM 03  
UNIDEN CORP  
800-297-1023
```

- 3) Press **▼** to see the next message. Or press **▲** to see previous message.

- 4) Press **end** to return to standby mode.



- In Caller ID operation, if no key is pressed for more than 30 seconds, an error tone sounds and the telephone returns to the standby mode.
- If a call comes in via a telephone system that does not offer Caller ID service, no information is stored.
- Each message can be up to 15 characters for the phone number and the name.
- The number of calls from the same Caller ID appears next to the received time. Once you read the new message, the number will clear and disappear.



- While using the "Delete All?" or "Delete Message?" screen if no key is pressed for more than 30 seconds, an error tone sounds and the telephone returns to standby.
- If you get an incoming call, a transferring call or page, the deleting operation is canceled and you can answer the call or page.

Deleting Information from the Caller ID List

The DXI386-2 series stores up to 30 messages in each handset. If the phone receives the 31st message, the oldest one in the list is automatically deleted. Caller ID data can also be deleted manually.

Deleting a Caller ID message

- 1) Press **cid/menu**. Display the message to be deleted from the Caller ID list by pressing **^** or **v**.
- 2) Press **delete/transfer**.
- 3) Press **^** or **v** to select "Yes" or "No".
- 4) Press **select/channel** or **delete/transfer**.

```
5/17 12:30PM 03
UNIDEN CORP
800-297-1023
```

```
Delete Message?
▶Yes
No
```

When the pointer is at "Yes":

A confirmation tone sounds and the Caller ID message is deleted. The next Caller ID message is then displayed.

When the pointer is at "No":

The display returns to the Caller ID message.

Deleting all Caller ID names/numbers

- 1) Press **cid/menu**.
- 2) Press **delete/transfer**.

```
New :01
Total:02
```

```
Delete All?
Yes
▶No
```

3) Press **^** or **v** to select "Yes" or "No".

4) Press **select/channel** or **delete/transfer**.

When the pointer is at "Yes":

A confirmation tone sounds and all stored Caller ID messages are deleted.

```
Total:00
```

When the pointer is at "No":

The display returns to the summary screen.

```
New :01  
Total:02
```



- You cannot make a call from the Caller ID list if your DXI386-2 series is connected to private branch exchange (PBX).
- When a long distance call has been set, "1" appears in the display.

Using the Caller ID List

Calling a party from the Caller ID list

You can place a call from the Caller ID list. The DXI386-2 series stores up to 30 messages in each handset.

- 1) Press ***cid/menu***. Select the phone number that you want to dial by pressing **^** or **v**.
- 2) Press ***talk/flash***. The displayed phone number dials automatically.

```
5/17 12:30PM 03
UNIDEN CORP
800-297-1023
```

```
>Connecting<
8002971023
```

Long Distance calls and Area Code Setting/Cancellation

Pressing **1** while the incoming Caller ID information is displayed (in step 1) will place the prefix "1" in the display to set up for a long distance call. Pressing **3** will set or cancel an area code setting.

Dial edit

You can temporarily edit the Caller ID number that is displayed by pressing ***select/channel***. A cursor appears in the display. Press ***delete/transfer*** to move the cursor left, enter the new phone number you would like to dial and then press ***talk/flash***. This will not change the number in the Caller ID list memory.

Storing Caller ID messages in Memory dialing

Messages shown in the Caller ID list can be stored in memory dialing. Using the incoming call information (i.e., Caller ID list), the phone number of the party on the Caller ID list can be stored in memory.

1) Press **cid/menu**.

Select the phone number to be stored from the Caller ID list by pressing **^** or **v**.

```
5/17 12:30PM 03
UNIDEN CORP
800-297-1023
```

2) Press **mem**.

```
Select Location
1 |
2 JONE DOE
```

3) Press **^** and **v** or enter a number (0 - 9) to select the memory location to be stored.

4) Press **select/channel**.

You hear a confirmation tone, and the number is stored in memory.

```
5/17 12:30PM 03
UNIDEN CORP
800-297-1023
```

The display returns to the Caller ID list.



If a message has already been stored in the selected memory number location, a confirmation screen is displayed. Press **^** to select "Yes". Press **select/channel** to overwrite. The display returns to the Caller ID list.

```
Replace Memory?
Yes
| No
```



You can not store a Caller ID message if no phone number appears in the message.



- You can change the phone's digital security code on either handset. However, you must re-register the other handset (not used to change the digital security code) back to the main base unit. See registration on page 12.
- If the handset battery pack is completely discharged or the battery pack is removed, the digital security code will be lost. If this happens, a new security code is set automatically next time the battery pack is charged in the main base.

Changing the Digital Security Code

The digital security code is an identification code used to connect the handset and the main base unit. This cordless telephone uses a digital security code to prevent unauthorized access to your base unit. This security code prevents other cordless handset from making calls through your base unit. Normally, setting the code is not necessary.

The first time you charge your handset, the security code is automatically set. In the rare situation that you suspect another cordless telephone is using the same security code, you can change the code.

- 1) Remove the handset from the main base unit. Press and hold ***find handset*** on the main base.
- 2) The handset begins emitting a paging sound. While holding ***find handset***, place the handset on the main base unit. The paging sound stops.
Leave the handset on the main base for more than 3 seconds. A new random security code is set.

Installing the Beltclip

To attach the beltclip

Insert the beltclip into the holes on each side of the handset. Press down until it clicks.

To remove the beltclip

Pull both sides of the beltclip to release the tabs from the holes.

Headset Installation

Your phone may be used with an optional headset, the Uniden HS910. To use this feature, insert headset plug into the headset jack.

Your phone is ready for hands-free conversations.

(Headset may be purchased by calling the Uniden Parts Department or visiting the web site. See Page 7.)

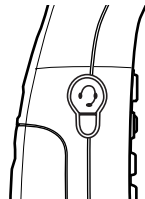

Note on Power Sources

Battery replacement and handling

When the operating time becomes short, even after a battery is recharged, please replace the battery.

With normal usage, your battery should last about one year.

Please contact your place of purchase or the Uniden Parts Department for a replacement battery.

Warning: To avoid the risk of personal injury or property damage from fire or electrical shock, only use the Uniden battery model and Uniden adapter model specifically designated for this product.

Power Failure

During the period that the power is off, you will not be able to make or receive calls with the telephone.

Caution

- Use only specified Uniden battery pack (BT-905).
- Do not remove the battery from the handset to charge it.
- Never throw the battery into a fire, disassemble it, or heat it.
- Do not remove or damage the battery casing.

Maintenance

When slightly dirty

Wipe with a soft, dry cloth.

When very dirty

Wipe with a soft cloth that has been dampened with diluted, neutral detergent.

Dry with a dry cloth.

When the charging terminals become dirty

Wipe with a dry cloth or a pencil eraser, if necessary.

(See page 10 for the location of charging terminals.)

Caution

Do not use paint thinner, benzene, alcohol, or other chemical products. Doing so may discolor the surface of the telephone and damage the finish.

Troubleshooting

If your phone is not performing to your expectations, please try these simple steps first.

Symptom	Suggestion
The status LED or charge LED won't illuminate when the handset is placed in the main base.	<ul style="list-style-type: none">• Make sure the AC adapters are plugged into each charging cradle and wall outlet.• Make sure both handsets are properly seated in each charging cradle.• Make sure the charging contacts on both handsets and charging cradles are clean.
The audio sounds weak and/or scratchy.	<ul style="list-style-type: none">• Move the handset and/or base to a different location away from metal objects or appliances and try again.• Press select/channel to help eliminate background noise.• Make sure that you are not too far from the main base.
Can't make or receive calls.	<ul style="list-style-type: none">• Re-register both handsets (See page 12).• Check both ends of the main base telephone line cord.• Make sure the AC adapter is plugged into the main base and wall outlet.• Disconnect the AC adapter for a few minutes, then reconnect it.• Make sure that you are not too far from the main base.
The handset doesn't ring or receive a page.	<ul style="list-style-type: none">• Re-register both handsets (See page 12).• The battery pack may be weak. Charge the battery for 15-20 hours.• The handset may be too far away from the main base unit.• Place the main base unit away from appliances or metal objects.• Make sure the volume setting is not Ringer off
Severe noise interference.	<ul style="list-style-type: none">• Keep the handset away from microwave ovens, computers, remote control toys, wireless microphones, alarm systems, intercoms, room monitors, fluorescent lights, and electrical appliances.• Move to another location or turn off the source of interference.

Symptom	Suggestion
The Caller ID does not display.	<ul style="list-style-type: none"> • The handset was picked up before the second ring. • The call was placed through a switch board. • Call your local telephone company to verify your Caller ID service is current.
Handset No.1 or No.2 not working.	<ul style="list-style-type: none"> • Make sure the battery pack is connected to the handset and fully charged. • Place the extra handset in the main base for 5 seconds.
"Unavailable" message is displayed on the LCD screen of the handset.	<ul style="list-style-type: none"> • Make sure the other handset is not already in use. Both handsets cannot be in talk mode at the same time. • Place the handset for at least 5 seconds to re-register to the main base. • Make sure the handset is not too far from the main base when trying to use.
The handset doesn't communicate with the main base or the other handset.	<ul style="list-style-type: none"> • Re-register both handsets (See page 12). • Make sure that you registered the extra handset.
No 3-way conversation.	<ul style="list-style-type: none"> • Only one handset at a time can talk with an outside caller. To allow the other handset to talk to the caller, transfer the call.
"Low Battery" message is displayed on the LCD screen.	<ul style="list-style-type: none"> • Place the handset back in either cradle to recharge over night.
If you still have a problem.	<ul style="list-style-type: none"> • Call our customer hotline at 1-800-297-1023.

General Information

The phone complies with FCC Parts 15 and 68.

Operating temperature: -10° to 50°C (+14°F to +122°F)

AC Adapter Information

AC Adapter part number: AD-311
Input Voltage: 120V AC 55 mA
Output Voltage: 9V DC 210 mA

Battery Information

Battery part number: BT-905
Capacity: 600 mAh, 3.6V
Battery use time (per charge)
From fully charged
Talk mode duration: 7 hours
Standby mode duration: 10 days

 If the handset is left off of the main base, the actual Talk mode duration will be reduced respective to the amount of time the handset is off the main base.

Recharge your phone on a regular basis by returning the handset to the main base after each phone call. When the operating time becomes short, even after the battery is recharged, please replace the battery. With normal usage, the battery should last about one year.

A replacement Uniden adapter and battery may be purchased at your local Uniden dealer or by contacting the Uniden Parts Department (800) 554-3988. Hours are from 7:00 a.m. to 5:00 p.m. Central Time, Monday through Friday. We can also be reached on the web at www.uniden.com

Specifications, features, and availability of optional accessories are all subject to change without prior notice.

Precautions!

Before you read anything else, please observe the following:

Warning!

Uniden America Corporation DOES NOT represent this unit to be water-proof. To reduce the risk of fire, electrical shock, or damage to the unit, DO NOT expose this unit to rain or moisture.

Rechargeable Nickel-Cadmium Battery Warning

- This equipment contains a rechargeable nickel-cadmium battery.
- Cadmium is a chemical known to the State of California to cause cancer.
- The rechargeable nickel-cadmium battery contained in this equipment may explode if disposed of in a fire.
- **Do not** short-circuit the battery.
- Do not charge the rechargeable nickel-cadmium battery used in this equipment in any charger other than the one designed to charge this battery as specified in the owner's manual. Using another charger may damage the battery or cause the battery to explode.

Rechargeable Nickel-Cadmium Batteries Must Be Recycled or Disposed of Properly

- Uniden voluntarily participates in an RBRC® industry program to collect and recycle nickel-cadmium batteries at the end of their useful life, when taken out of service within the United States. The RBRC® program provides a convenient alternative to placing used nickel-cadmium batteries into the trash or municipal waste stream, which is illegal in some areas.
- Through the RBRC® program, Uniden makes it easy for you to drop off the used battery at local retailers of replacement nickel-cadmium batteries. You may also contact your local recycling center for information on where to return the used battery. Please call 1-800-8-BATTERY for information on Ni-Cd battery recycling in your area. Uniden's involvement in this program is part of its commitment to protecting our environment and conserving natural resources.
- RBRC® is a registered trademark of the Rechargeable Battery Recycling Corporation.



The exclamation point within an equilateral triangle is intended to alert the user to the presence of important operating and maintenance (servicing) instructions in the literature accompanying the appliance.

Important Safety Instructions

When using your telephone equipment, these basic safety precautions should always be followed to reduce the risk of fire, electrical shock, and injury to persons:

1. Read and understand all instructions.
2. Follow all warnings and instructions marked on the product.
3. Unplug this product from the wall outlet before cleaning. Use a dry

cloth for cleaning without liquid or aerosol cleaners.

4. Do not use this product near water; for example, near a bathtub, wash bowl, kitchen sink or laundry tub, in a wet basement, or near a swimming pool.
5. Do not place this product on an unstable cart, stand, or table. The telephone may fall, causing serious damage to the unit.
6. Slots and openings in the cabinet and the back or bottom are provided for ventilation. To protect the product from overheating, these openings must not be blocked or covered. This product should never be placed near or over a radiator or heat register. This product should not be placed in a built-in installation unless proper ventilation is provided.
7. This product should be operated only from the type of power source indicated on the marking label. If you are not sure of the type of power supply to your home, consult your dealer or local power company.
8. Do not allow anything to rest on the power cord. Do not locate this product where the cord will be damaged by persons walking on it.
9. Do not overload wall outlets and extension cords, as this can result in the risk of fire or electrical shock.
10. Never push objects of any kind into this product through cabinet slots, as they may touch dangerous voltage points or short out parts that could result in a risk of fire or electric shock. Never spill liquid of any kind on the product.
11. To reduce the risk of electric shock, do not disassemble this product. Take it to qualified service personnel when service or repair work is required. Opening or removing covers may expose you to dangerous voltages or other risks. Incorrect reassembly can cause electric shock when the appliance is subsequently used.
12. Unplug this product from the wall outlet and refer servicing to qualified service personnel under the following conditions:
 - A. When the power supply cord is damaged or frayed.
 - B. If liquid has been spilled into the product.
 - C. If the product has been exposed to rain or water.
 - D. If the product does not operate normally when following the operating instructions. (Adjust only those controls that are covered by the operating instructions. Improper adjustment of other controls may result in damage and will often require extensive repair work by a qualified technician.)
 - E. If the product has been dropped or the cabinet has been damaged.
 - F. If the product exhibits a distinct change in performance.
13. Do not use the telephone to report a gas leak in the vicinity of the leak.

Additional Battery Safety Precautions

Caution! To reduce the risk of fire or injury to persons by the battery, read and follow these instructions:

1. Use only Uniden battery pack specified in the owner's manual.
2. Do not dispose of the battery pack in a fire. The cell may explode. Check the nickel-cadmium battery disposal package insert for disposal instructions.
3. Do not open or mutilate the battery pack. Released electrolyte is corrosive and may cause damage to the eyes or skin. It may be toxic if swallowed.
4. Exercise care in handling the battery in order not to short the bat-

- tery with conducting materials such as rings, bracelets, and keys. The battery or conductor may overheat and cause burns.
5. Charge the battery pack provided with or identified for use with this product only in accordance with the instructions and limitations specified in the owner's manual provided for this product.
 6. Observe proper polarity orientation between the battery pack and battery charger.

SAVE THESE INSTRUCTIONS!

Important Electrical Considerations

Unplug all electrical appliances when you know an electrical storm is approaching. Lightning can pass through your household wiring and damage any device connected to it. This phone is no exception.

Warning!

Please do not attempt to unplug any appliance during an electrical storm.

The FCC Wants You To Know

Changes or modifications to this product not expressly approved by Uniden, or operation of this product in any way other than as detailed by the owner's manual, could void your authority to operate this product. The equipment cannot be used on public coin phone service provided by the telephone company. Connection to party line service is subject to state tariffs. (Contact the state public utility commission, public service commission or corporation commission for information.)

Range

Your new phone is designed to achieve the maximum possible range by transmitting and receiving according to the highest specifications set forth by the FCC. We have rated this phone to operate at a maximum distance with the qualification that the range depends upon the environment in which the telephone is used. Many factors limit range, and it would be impossible to include all the variables in our rating. The Maximum Range rating of this phone is meant to be used as a means of comparison against other range claims.

Telephone Line Problems

The FCC has granted the telephone company the right to disconnect service in the event that your phone causes problems on the telephone line. Also, the telephone company may make changes in facilities and services which may affect the operation of your unit. However, your telephone company must give adequate notice in writing prior to such actions to allow you time for making necessary arrangements to continue uninterrupted service.

If you are having trouble with your telephone service, you must first disconnect your phone to determine if it is the cause of your problem. If you determine that it is the cause, you must leave it disconnected until the trouble has been corrected.

Radio Interference

Radio interference may occasionally cause buzzing and humming in your cordless handset, or clicking noises in the base. This interference is caused by external sources such as TV, refrigerator, vacuum cleaner, fluorescent lighting, or electrical storm. Your unit is NOT DEFECTIVE. If these noises continue and are too distracting, please check around your home to see what appliances may be causing the problem. In addition,

we recommend that the base not be plugged into a circuit that also powers a major appliance because of the potential for interference. Be certain that the antenna on the unit is fully extended when needed. In the unlikely event that you consistently hear other voices or distracting transmissions on your phone, you may be receiving radio signals from another cordless telephone or other source of interference. If you cannot eliminate this type of interference, you need to change to a different channel.

Finally, it should be noted that some cordless telephones operate at frequencies that may cause interference to nearby TVs and VCRs. To minimize or prevent such interference, the base of the cordless telephone should not be placed near or on top of a TV or VCR. If interference is experienced, moving the cordless telephone farther away from the TV or VCR will often reduce or eliminate the interference.

More Than One Cordless Telephone

If you want to use more than one cordless telephone in your home, they must operate on different channels. Press the channel key to select a channel that provides the clearest communication.

Cordless Telephone Privacy

Cordless telephones are radio devices. Communications between the handset and base of your cordless telephone are accomplished by means of radio waves which are broadcast over the open airways. Because of the inherent physical properties of radio waves, your communications can be received by radio receiving devices other than your own cordless telephone unit. Consequently, any communications using your cordless telephone may not be private.

Installation Considerations

Selecting a Location

Before choosing a location for your new phone, there are some important guidelines you should consider:

- The location should be close to both a phone jack and continuous power outlet. (A continuous power outlet is an AC outlet which does not have a switch to interrupt its power.)
- Keep the base and handset away from sources of electrical noise such as motors or fluorescent lighting.
- Be sure there is sufficient space to fully extend the base antenna.
- The base can be placed on a desk or tabletop or mounted on a standard telephone wall plate.
- You should charge your new phone for 15-20 hours before completing the installation or using the handset.

Telephone Line Outlets

There are two types of phone outlets:

Modular Jack

Most phone equipment available now uses modular jacks. Phone cords are fitted with a molded plastic connector which plugs into this type of jack. If you do not have modular phone jacks, contact your local telephone company for information about their installation.

Hardwired Jack

Some equipment is wired directly to a phone jack, and these types of installations require a modular jack converter. This type of installation is not difficult; however, you should contact your Uniden telephone dealer or a telephone supply store for advice about the proper adapter or con-

verter for your particular situation.

Connecting the Telephone Cords

Consider these safety guidelines before connecting the telephone cords:

Caution!

- Never install telephone wiring during a lightning storm.
- Never touch uninsulated telephone wires or terminals unless the telephone line has been disconnected.
- Use caution when installing or modifying telephone lines.

Applying Power to the Base

This phone requires an AC outlet, without a switch to interrupt power, and the included AC adapter. To relieve strain on the DC plug when the phone is placed on a desk or table, wrap the power cord around the strain relief notch on the bottom of the base.

NOTE: Place the power cord so that it does not create a trip hazard, or where it could become chafed and create a fire or other electrical hazards.

Adapter Safety Features

If the AC adapter furnished with this phone has a polarized line plug (a plug having one blade wider than the other), this plug will fit into the power outlet only one way. If you are unable to insert the plug fully into the outlet, try reversing the plug.

Do not alter the shape of the blades of the polarized plug!

NOTE: If you cannot plug the AC adapter into the outlet, contact someone about replacing the outlet.

Plug the AC Adapter into a standard 120 VAC wall outlet.

Do not use an outlet controlled by a wall switch.



Use only the Uniden AC Adapter supplied with this phone.

One Year Limited Warranty

Important: Evidence of original purchase is required for warranty service.

WARRANTOR: UNIDEN AMERICA CORPORATION ("Uniden")

ELEMENTS OF WARRANTY: Uniden warrants, for one year, to the original retail owner, this Uniden Product to be free from defects in materials and craftsmanship with only the limitations or exclusions set out below.

WARRANTY DURATION: This warranty to the original user shall terminate and be of no further effect 12 months after the date of original retail sale. The warranty is invalid if the Product is (A) damaged or not maintained as reasonable or necessary, (B) modified, altered, or used as part of any conversion kits, subassemblies, or any configurations not sold by Uniden, (C) improperly installed, (D) serviced or repaired by someone other than an authorized Uniden service center for a defect or malfunction covered by this warranty, (E) used in any conjunction with equipment or parts or as part of any system not manufactured by Uniden, or (F) installed or programmed by anyone other than as detailed by the owner's manual for this product.

STATEMENT OF REMEDY: In the event that the product does not conform

to this warranty at any time while this warranty is in effect, warrantor will either, at its option, repair or replace the defective unit and return it to you without charge for parts, service, or any other cost (except shipping and handling) incurred by warrantor or its representatives in connection with the performance of this warranty. Warrantor, at its option, may replace the unit with a new or refurbished unit. **THE LIMITED WARRANTY SET FORTH ABOVE IS THE SOLE AND ENTIRE WARRANTY PERTAINING TO THE PRODUCT AND IS IN LIEU OF AND EXCLUDES ALL OTHER WARRANTIES OF ANY NATURE WHATSOEVER, WHETHER EXPRESS, IMPLIED OR ARISING BY OPERATION OF LAW, INCLUDING, BUT NOT LIMITED TO ANY IMPLIED WARRANTIES OF MERCHANTABILITY OR FITNESS FOR A PARTICULAR PURPOSE. THIS WARRANTY DOES NOT COVER OR PROVIDE FOR THE REIMBURSEMENT OR PAYMENT OF INCIDENTAL OR CONSEQUENTIAL DAMAGES.** Some states do not allow this exclusion or limitation of incidental or consequential damages so the above limitation or exclusion may not apply to you.

LEGAL REMEDIES: This warranty gives you specific legal rights, and you may also have other rights which vary from state to state. This warranty is void outside the United States of America.

PROCEDURE FOR OBTAINING PERFORMANCE OF WARRANTY: If, after following the instructions in the owner's manual you are certain that the Product is defective, pack the Product carefully (preferably in its original packaging). The Product should include all parts and accessories originally packaged with the Product. Include evidence of original purchase and a note describing the defect that has caused you to return it. The Product should be shipped freight prepaid, by traceable means, to warrantor at:

Uniden America Corporation

Parts and Service Division

4700 Amon Carter Blvd., Fort Worth, TX 76155

(800) 297-1023, 8 a.m. to 5 p.m. Central, Monday through Friday

I.C. Notice

TERMINAL EQUIPMENT

NOTICE: This equipment meets the applicable Industry Canada Terminal Equipment Technical Specifications. This is confirmed by the registration number. The abbreviation, IC, before the registration number signifies that registration was performed based on a Declaration of Conformity indicating that Industry Canada technical specifications were met. It does not imply that Industry Canada approved the equipment.

NOTICE: The Ringer Equivalence Number (REN) for this terminal equipment is marked on the equipment itself. The REN assigned to each terminal equipment provides an indication of the maximum number of terminals allowed to be connected to a telephone interface. The termination on an interface may consist of any combination of devices subject only to the requirement that the sum of the Ringer Equivalence Numbers of all the devices does not exceed five.

RADIO EQUIPMENT

The term “IC:” before the radio certification number only signifies that Industry Canada technical specifications were met.

Operation is subject to the following two conditions: (1) this device may not cause interference, and (2) this device must accept any interference, including interference that may cause undesired operation of the device. “Privacy of communications may not be ensured when using this telephone”.

Index

A

- AC adapter information 44
- Adjusting ringer and earpiece volume 20

B

- Battery pack
 - Information 44
 - Install 9
 - Maintenance 10, 41
 - Preparing and charging 11
 - Replacement and handling 41
- Beltclip installation 40

C

- Caller ID
 - Caller ID service 34
 - Call Waiting 22
 - Deleting 36
 - Setting Caller ID options 16
 - Using 38
 - Viewing 35
- Call Transfer Feature 13
- Channel 22
- Connection 11

D

- Dial mode 17
- Digital security code 40

E, F, G

- Earpiece volume 20
- Extra Handset 12
- General information 44

H

- Headset installation 40

I, J, K, L

- I.C. Notice 47
- Interference 45

M, N, O

- Maintenance 41
- Making a call 19
- Memory dialing
 - Editing a stored name and/or phone number 29
 - Erasing a stored name and phone number 31
 - Making calls with memory dialing 27
 - Storing phone numbers and names 23
- Mounting on a wall 14

P, Q

- Package contents 7
- Paging 22
- Precautions 45

R

- Receiving a call 19
- Redialing a call 19, 21
- Ringer tone and volume 20
- RocketDial 32

S

- Setting Menu Options 16
- Setting up the Phone 8
- Setting up the Handset 9

T, U, V, W, X, Y, Z

- Troubleshooting 42
- Warranty 46

At Uniden, we'll take care of you!

If you need any assistance with this product, please call our Customer Hotline at

1-800-297-1023

PLEASE DO NOT RETURN THIS PRODUCT TO THE PLACE OF PURCHASE.

Our Uniden representatives will be happy to help you with any matters regarding the operation of this unit, available accessories, or any other related matters.

Thank you for purchasing a Uniden product.

Hours: M-F 8:00 AM to 5:00 PM CST.



For information on the accessibility features of this product, please call

1-800-874-9314 (V/TTY)



Uniden®

May be covered under one or more of the following U.S. patents:

4,511,761	4,523,058	4,595,795	4,797,916	5,381,460	5,426,690
5,434,905	5,491,745	5,533,010	5,543,605	5,574,727	5,581,598
5,650,790	5,660,269	5,661,780	5,663,981	5,671,248	5,696,471
5,717,312	5,732,355	5,754,407	5,758,289	5,768,345	5,787,356
5,794,152	5,801,466	5,825,161	5,838,721	5,864,619	5,893,034
5,912,968	5,915,227	5,929,598	5,930,720	5,960,358	5,987,330
6,044,281	6,070,082	6,125,277	6,253,088		

©2002 Uniden America Corporation, Fort Worth, Texas

Custom manufactured in China.

Contains additional foreign articles.

UCZZ01365ZA

Free Manuals Download Website

<http://myh66.com>

<http://usermanuals.us>

<http://www.somanuals.com>

<http://www.4manuals.cc>

<http://www.manual-lib.com>

<http://www.404manual.com>

<http://www.luxmanual.com>

<http://aubethermostatmanual.com>

Golf course search by state

<http://golfingnear.com>

Email search by domain

<http://emailbydomain.com>

Auto manuals search

<http://auto.somanuals.com>

TV manuals search

<http://tv.somanuals.com>