

# Uniden®

## Cordless Telephone EXLI 8962

### Owner's Manual

Getting Started

Basics



Thank you for your purchase of the Uniden EXLI 8962 cordless telephone. Please read this Owner's Manual carefully before using your cordless telephone to ensure proper use. After reading the manual, please keep it in a safe place and refer to it when necessary.

©1999 Uniden America Corporation

# Introduction

Thank you for choosing the Uniden EXLI 8962 cordless telephone. This phone is designed to exacting standards that provide reliability, long life and outstanding performance.

**Note: Some illustrations in this manual may differ from the actual unit for explanation purposes.**

## Features

- Long Distance Manager
- 900 MHz Extended Range
- Secure Digital Transmission
- Caller ID and Call Waiting Caller ID
- 50 Number Caller ID memory
- 20 Number Memory
- 32 Digit Redial
- 3 Redial Memories
- Flash and Pause
- Pulse / Tone Dialing
- 7 Day Standby Battery Life
- 7 Hour Talk Time
- Handset Earpiece and Ringer Volume Control

# Table of contents

## Getting Started

- Read this first** ..... 4
- Step 1: Checking the package contents ..... 5
- Step 2: Setting up the base unit ..... 6
- Step 3: Preparing the battery pack ..... 9
- Step 4: Entering your area code ..... 11

## Basics

- Making calls** ..... 12
  - On-hook dialing ..... 12
  - Off-hook dialing ..... 13
  - Redialing ..... 14
- Receiving calls** ..... 16

## Telephone Features

- Memory storing ..... 18
  - Storing phone numbers and names ..... 18
- Memory dialing ..... 20
  - Making calls with memory dialing ..... 20
- Memory editing ..... 22
  - Editing a stored name and/or phone number ..... 22
- Memory erasing ..... 24
  - Erasing a stored name and phone number ..... 24
- On-hook dial editing ..... 25
- Mute ..... 26
- LDM (Long Distance Manager) ..... 27
- Paging ..... 30

## Caller ID Features

- Caller ID service ..... 31
  - Setting the Caller ID options ..... 31
  - When the telephone rings ..... 32
- Viewing the Caller ID message list ..... 33
  - Deleting information from the Caller ID list ..... 34
- Using the Caller ID list ..... 36
  - Calling a party from the Caller ID list ..... 36
  - Storing Caller ID message in Memory dialing ..... 37
- Using "Caller ID with call waiting" service ..... 38

## Additional Information

- Changing the digital security code ..... 39
- Mounting the base unit on a wall ..... 40
- Installing the beltclip ..... 42
- Headset installation ..... 42
- Note on power sources ..... 43
- Maintenance ..... 43
- Troubleshooting ..... 44
- Specifications ..... 45
- Index** ..... 46

## Read this first

This cordless telephone must be set up before use. Follow these steps;

### Step 1 (page 5)

Unpack the telephone and accessories.

### Step 2 (page 6 to 8)

Next, choose the best location to set up the base unit.

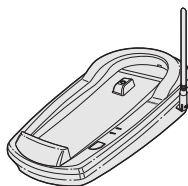

Base unit

### Step 3 (page 9 to 10)

Then, insert the battery pack into the handset.  
You have to charge the battery pack for more than 12 hours before using the phone.



Handset

### Step 4 (page 11)

Finally, store your area code in the memory to use the Caller ID service, unless your calling area requires 10 digits dialing.



Handset

### About the digital security code

This cordless telephone uses a digital security code to prevent unauthorized access to your base unit. This security code prevents other cordless handsets from making calls through your base unit.

A random security code will be assigned automatically between your base unit and handset when you charge the battery pack for the first time.

If you want to reset the security code, see page 38.

# Step 1

## Checking the package contents

Make sure you have received the following items in the package.

If any of these items are missing or damaged, contact the **Uniden Parts Department** (see below).

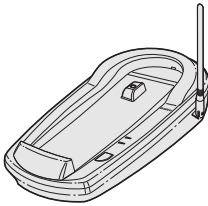

• Base unit



• Handset

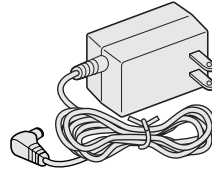

• AC adapter (AD-420)

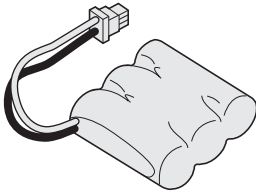

• Rechargeable battery pack (BT-905)

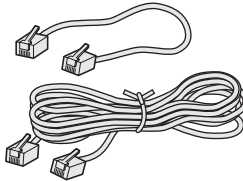

• Telephone line cord (2)

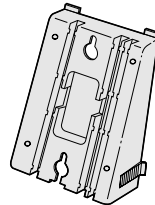

• Wall mount adapter

- This Owner's Manual
- Precautions and Important Safety Instructions
- Registration Card

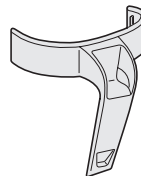

• Beltclip

### Uniden Parts Department

(800) 554-3988

Hours are 8:30 a.m. to 5:00 p.m. Central Time, Monday through Friday.

We can also be reached on the web at [www.uniden.com](http://www.uniden.com).

## Step 2

### Setting up the base unit

Do the following steps.

- Choose the best location
- Connect the base unit
- Choose the dialing mode

#### Choose the best location

Before choosing a location for your new phone, read the INSTALLATION CONSIDERATIONS included in the PRECAUTIONS AND IMPORTANT SAFETY INSTRUCTIONS brochure. Here are some important guidelines you should consider:

**Avoid heat sources, such as radiators, air ducts, and sunlight**

**Avoid television sets and other electronic equipment**

**Avoid noise sources such as a window by a street with heavy traffic**

**Avoid microwave oven**

**Avoid excessive moisture, extremely low temperatures, dust, mechanical vibration, or shock**

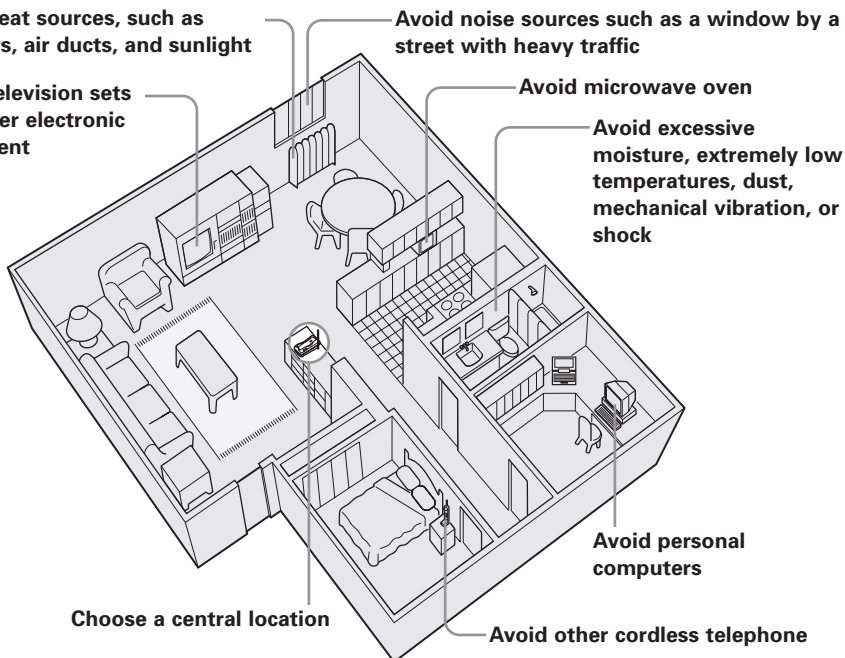

- You should charge your handset for 15-20 hours before using the phone.
- The location should be close to both a phone jack and a continuous power outlet which is not switchable.
- Keep the base and handset away from sources of electrical noise such as motors and fluorescent lighting.
- Be sure there is sufficient space to raise the base antenna fully vertical.
- The base can be placed on a desk, tabletop or mounted on a standard wall plate.
- If your second phone line has a separate jack, place your phone so you can access both jacks.

## Step 2 (continued)

### Connect the base unit

If you want to install the base unit on the wall, see page 39.

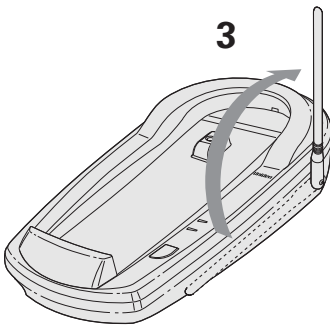
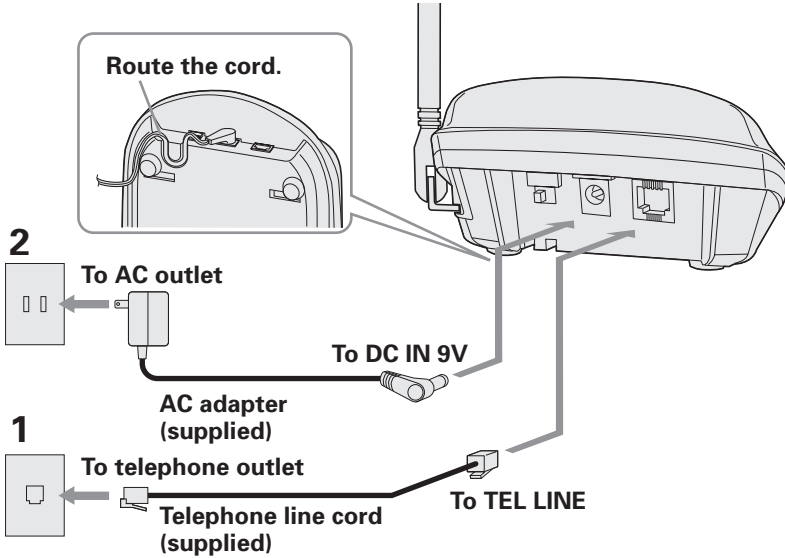

- 1** Connect the telephone line cord to the **TEL LINE** jack and to a telephone outlet.
- 2** Connect the AC adapter to the **DC IN 9V** jack and to a standard 120VAC wall outlet.
- 3** Set the base unit on a desk or tabletop and place the handset on the base unit. Then raise the antenna to a vertical position.

#### Note

Place the power cord so it does not create a trip hazard, or where it could become chafed and create a fire or electrical hazard.

## Step 2 (continued)

### Notes

- Use only the supplied AD-420 AC adapter. Do not use any other AC adapter.
- Connect the AC adapter to a continuous power supply.
- Place the base unit close to the AC outlet so that you can unplug the AC adapter easily.

### Tips

- If your telephone outlet isn't modular, contact your telephone company for assistance.

### Polarity of the plug

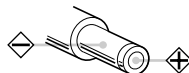

### Modular



## Choose the dialing mode

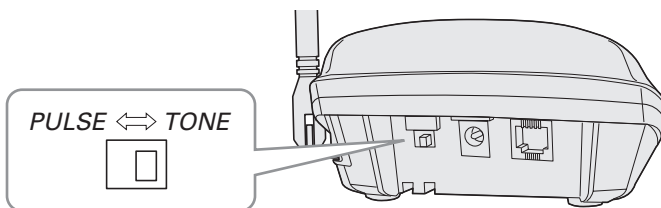

Depending on your dialing system, set the TONE/PULSE switch as follows:

If your dialing system is	Set the switch to
Tone	TONE
Pulse	PULSE

### If you aren't sure of your dialing system

Make a trial call with the TONE/PULSE switch set to TONE.

If the call connects, leave the switch as is; otherwise, set to PULSE.



## Step 3

# Preparing the battery pack

Charge the battery pack for more than 12 hours before you start using your phone.

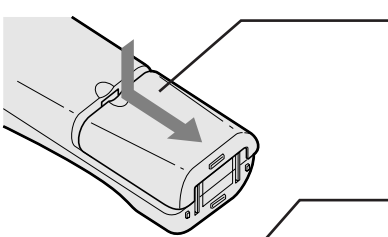

- 1** Press and slide the battery compartment cover toward the bottom of the unit.

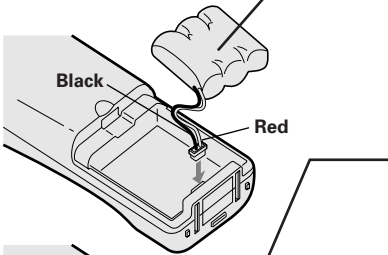

- 2** Connect the battery pack connector with the correct polarity (black and red wires), then insert the battery pack into the battery compartment.

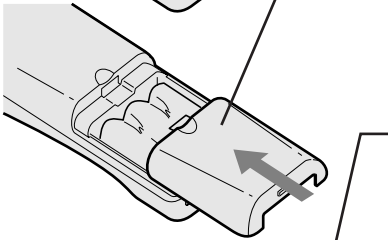

- 3** Securely close the battery compartment cover by sliding it up until it snaps into place.

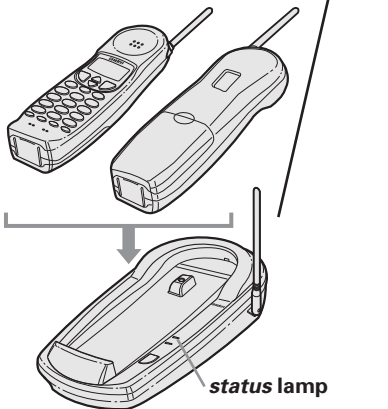

- 4** Place the handset on the base unit with the keys and display facing upward. This position lets you see Caller ID messages on the display.

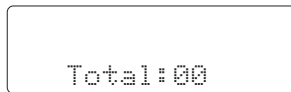

When the handset has been properly placed on the charging terminals of the base unit, the "**status**" lamp of the base unit lights and charging begins. Charge the battery for at least 15 hours.

You can place either side up for charging the battery.

## Step 3 (continued)

### Battery use time (per charge)

From fully charged

- Seven hours continuous use.
- Seven days when the handset is in the standby mode.

### When the battery charge becomes low

When the voltage of battery pack in the handset is very low and needs to be charged, the phone is programmed to eliminate functions in order to save power. If the phone is not in use, "Low Battery" flashes and none of the keys will operate. If the phone is in use, "Low Battery" flashes and the handset beeps. Complete your conversation as quickly as possible and return the handset to the base unit for charging.



Low Battery

---

#### Notes

- Even when the battery pack is not being used, it will gradually discharge over a long period. For optimum performance, be sure to return the handset to the base unit after a telephone call for charging the battery.
- The built-in memory backup can hold numbers and names stored in the memory for up to 2 minutes, while you replace the battery pack.
- If you must replace the battery pack during a telephone call, complete the replacement of the battery pack within 30 seconds, and you may return to the original call.
- Rechargeable batteries have a memory effect that reduces standby and talk time. To avoid this memory effect, on a monthly basis, use the phone until the "Low Battery" indication appears. Then charge the battery for 15 hours.

### Cleaning the battery contacts

To maintain a good charge, it is important to clean all battery contacts on the handset and base unit about once a month. Use a soft cloth or other contact cleaner.

**Do not use any liquids or solvents.**

## Step 4

# Entering your area code

**Note** If your calling area requires 10-digits skip this step.

Enter your area code before you use this phone for the first time, or if move to new area, you must enter your area code. This is necessary because the phone must distinguish local or long distance calls to properly dial calls from the Caller ID message list. (See page 36.)

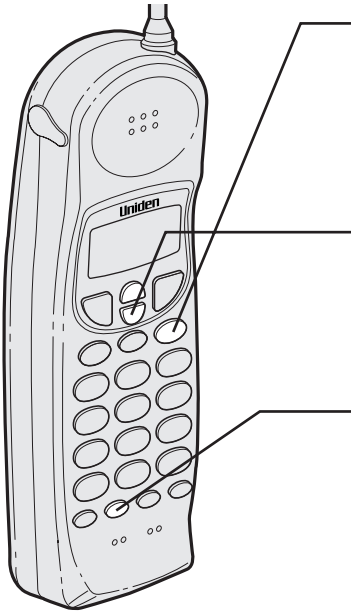

- 1** When the phone is in the standby mode, press and hold **call id** until the Caller ID setting screen appears.

```
1 Auto Talk:Off
2 CIDCW      :On
3 Area Code:
```

- 2** Press **▲** or **▼** to select "Area Code".

```
1 Auto Talk:Off
2 CIDCW      :On
3 Area Code:
```

- 3** Press **select/ch**.

```
1 Auto Talk:Off
2 CIDCW      :On
3 Area Code:█
```

- 4** Use the dial buttons ( **0** to **9** ) to enter the 3-digit area code.

- 5** Press **select/ch**.  
A beep sounds and the displayed area code is entered.

- 6** Press **call id** to complete the setting. Or return the handset to the base unit to complete the setting mode and set the handset to the standby mode.

### Note

When the area code has already been stored in memory, the stored area code will be displayed. To change it, use the dial buttons to enter the new area code.

```
1 Auto Talk:Off
2 CIDCW      :On
3 Area Code:817
```

To complete the setting, press **call id** or return the handset to the base unit.

# Making calls

## On-hook dialing

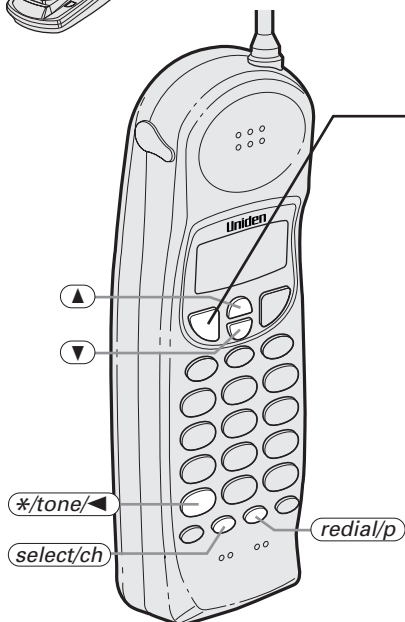

- 1 Dial the phone number. (Phone numbers can be up to 32 digits.)

**Example:** Enter 8178583300

0178583300

- 2 Press **(talk)**. "Talk" flashes on the display.

Talk  
0178583300

**Note** When **(LongDst)** is pressed instead of **(talk)**, LDM (Long Distance Manager) will be activated. (For LDM, refer to page 27.)

- 3 The number is dialed. After about 5 seconds, the call-time display appears.

Talk 0:00  
0178583300

- 4 Press **(talk)** to complete the telephone call. The call-time will be displayed for about 5 seconds.

5:15

### Other Operations

To	Do this
To improve reception	Press <b>(select/ch)</b> .
To adjust the ear speaker volume	Press <b>(▲)</b> or <b>(▼)</b> .
To temporarily switch to tone dial (when base is in pulse mode)	Press <b>(*/tone/◀)</b> . The following numbers dialed will be sent as tone dialing.
To enter a pause within the numbers dialed	Press <b>(redial/p)</b> .

### Notes

- If there is no key entry for in more than 20 seconds, on-hook dialing is cancelled and the telephone returns to the standby mode.
- The phone number can be edited before pressing **(talk)**. (See page 25.)

## Off-hook dialing

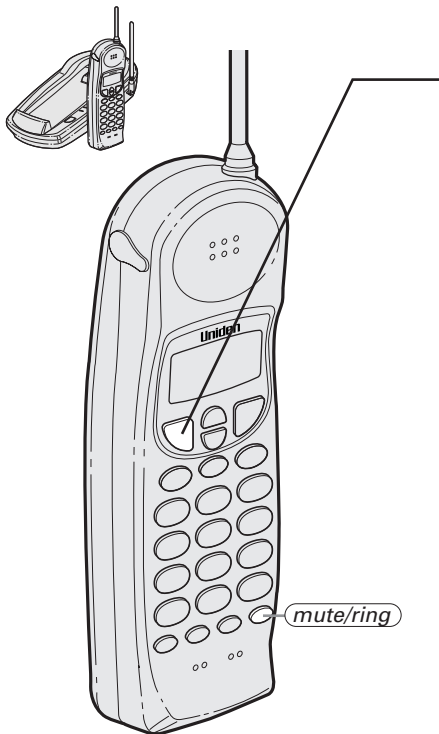

### Mute feature

Pressing **(mute/ring)** during a telephone call will cut off the sound from the microphone and display "mute".

Pressing **(mute/ring)** or **(talk)** will cancel the mute mode and return the handset to the original call.

### Note

- The phone number can be up to 32 digits.

- 1 Pick up the handset.
- 2 Press **(talk)**. "Talk" appears flashing on the display.



Then the volume setting is displayed. For example if the volume is set to high the display shows

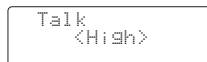

**Note** When **(LongDst)** is pressed instead of **(talk)**, LDM (Long Distance Manager) will be activated. (For LDM, refer to page 27.)

- 3 Dial the phone number.

**Example:** Enter 8178583300

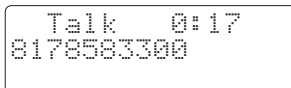

- 4 Press **(talk)** or place the handset in the base to complete the telephone call. The call-time will be displayed for about 5 seconds. The phone returns to standby.

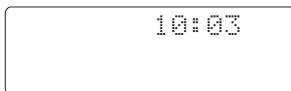

- Returning the handset to the base unit during a call disconnects the phone call and sets the handset to the standby mode (i.e., Auto Standby).

## Redialing

The last three phone numbers dialed can be quickly redialed.

### [On-hook redialing]



- 1 Press **(redial/p)**.  
The phone number that was last dialed appears on the display.
- 2 Press **(redial/p)** again.  
Each press of **(redial/p)** will display one of the last three dialed numbers in order.

Most recent

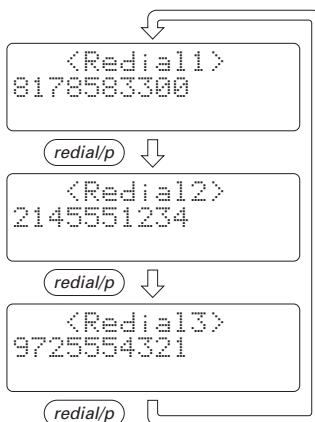

- 3 Press **(talk)**. "Talk" appears flashing on the display, then the volume setting is displayed.

**Note** When **(LongDst)** is pressed instead of **(talk)**, LDM (Long Distance Manager) will be activated. (For LDM, refer to page 27.)

- 4 Then the selected number is dialed. After about 5 seconds, the call-time display appears.
- 5 Press **(talk)** complete the telephone call. The call-time will be displayed for about 5 seconds.

#### Note

If the recently dialed number exceeds 32 digits, only the first 32 digits are retained for redialing.

## [Off-hook redialing]

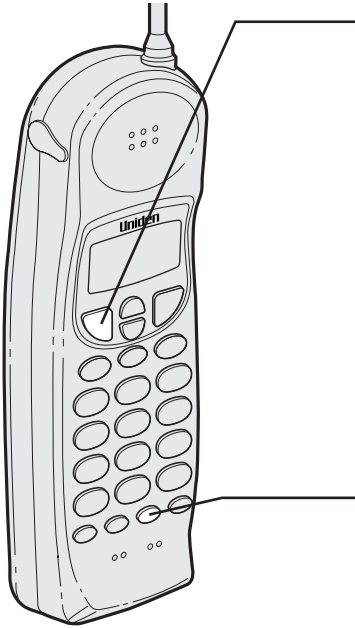

- 1 Press **(talk)** .  
"Talk" appears flashing on the display.

Talk



Talk  
<High>

**Note** When **(LongDst)** is pressed instead of **(talk)** , LDM (Long Distance Manager) will be activated. (For LDM, refer to page 28.)

- 2 Press **(redial/p)** .  
Redial the last number you called.
- 3 Press **(talk)** , or place the handset on the base to complete the telephone call. The call-time will be displayed for about 5 seconds.

# Receiving calls

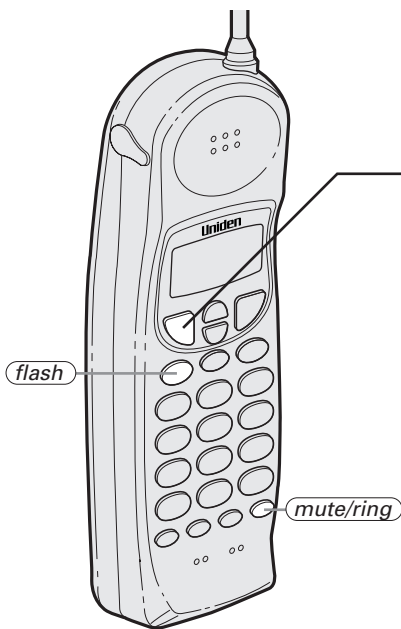

**1** Phone rings.

Calling

**2** Press **(talk)**. "Talk" and volume appears on the display.

Talk

**3** The call-time display starts. Talk with the caller.

Talk 0:02

**4** Press **(talk)** or place the handset on the base when the telephone call is finished. The call time will be displayed for about 5 seconds.

115:35

## Auto Talk when ringing

When the Auto Talk setting is on and there is an incoming call, simply lift the handset from the base unit to answer the phone. (See page 31.)

## Any key when ringing

When the Auto Talk setting is on, and the handset is on the base, press any handset key (except **(mute/ring)**) to answer the incoming call. (See page 31.)

## Mute when ringing

Press **(mute/ring)** when the phone rings to mute the ringing sound. The handset rings normally with receipt of the next call.

## Any key when paging

To cancel paging, press any of the handset keys while the handset is beeping. (See page 30.)

**Caller ID reception — Note: You must subscribe to Call Waiting service from your local phone company to use this feature.**

When a call is received during a telephone call already in progress, the handset enters call waiting mode and Caller ID data displays.

Press **(flash)** to switch to the new call. (See page 38.)



# Receiving calls (continued)

## Ringer tone

In the standby mode, press **(mute/ring)**.

Each time **(mute/ring)** is pressed, the ringer tone setting changes and the selected ringer tone sounds for 2 seconds.

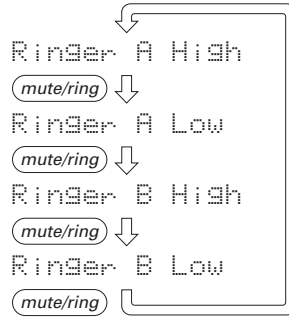

## Ringer switch

The handset ringer is disabled when the ringer switch is set to the **[off]** position.

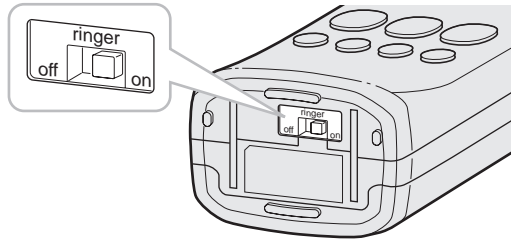

## Ear Speaker volume

Pressing **(▲)** or **(▼)** during a telephone call will change the ear speaker volume of the handset. This setting will remain in effect after the telephone call has ended.

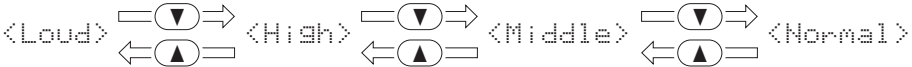

When you press **(▲)** in Loud mode or press **(▼)** in Normal mode, error sound beeps.

# Memory storing

Memory Dialing allows you to dial a number using just a few key strokes. You can store up to 20 phone numbers in the dial memory.

## Storing phone numbers and names

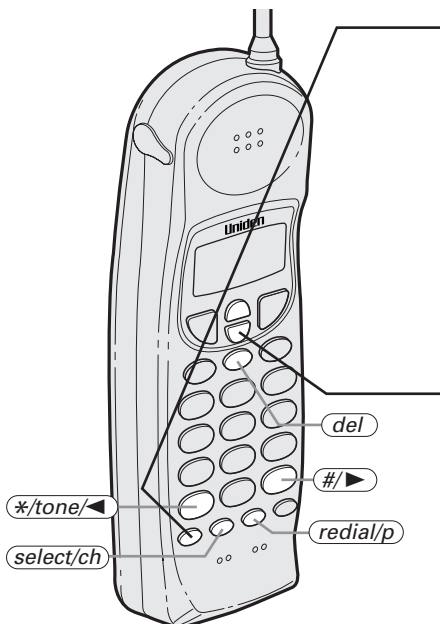

- 1** Press and hold **(mem)** until "Memory Store" is displayed.

```
Memory Store
01 UNIDEN CORP
02 JOHN DOE
```

This is an example of a number stored in the 02. Location out the name has not been entered.

```
Memory Store
01 UNIDEN CORP
02 <Memory>02>
```

- 2** Press **(▲)** or **(▼)** to scroll to the memory number where you would like to store the number.

```
Memory Store
07
08
```

Or press the keypad (**0** to **9**) to select the memory location where you would like to store the number.

**Example:** Enter 1 (10s digit)

```
Location No.1■
```

```
Store Name
■
```

```
► Edit Memory01
Delete Memory01
Go Back
```

- 3** Press **(select/ch)**.











When an empty memory location is selected, "Store Name" is displayed. The cursor flashes indicating that the display is ready for the name to be entered.

If this screen appears, the memory locations is full. You must edit a location. (See page 22.)

### Note

Whenever you are using a menu screen, you must press a key within 20 seconds or the phone will return to standby. If you return the handset in the cradle the phone will return to standby too. You may also press **(mem)** to access a memory menu at any time.



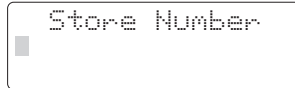

## Memory storing (continued)

- 4** Use the , , , , or  keys to enter the name. The name cannot exceed 12 characters.
- Use the  and  key to scroll the character menu consisting of upper and lower case letters, numbers, punctuation marks and various characters.
  - Use the  and  to move the cursor to the desired location.
  - Use the  key to delete characters as needed.

- 5** Press .  
"Store Number" is displayed. The cursor flashes indicating that the display is ready for the number to be entered.



```
Store Number
█
```

- 6** Use the keypad, , , or  keys to enter the phone number. The phone number cannot exceed 20 digits.
- Use the number keypad for direct entry.
  - Use the  key to enter pause in the dialing sequence. The display shows a "P".
- Note** The pause feature is useful for long distance calling, credit card dialing, or sequences that require a pause between digits.
- Use the  key to delete digits needed.



```
Store Number
817858330█
```

- 7** Press .  
The handset beeps and displays the confirmation screen. Memory storage is complete.

For example if you store a name and number into memory location number 7, the display shows "Memory07 Stored".

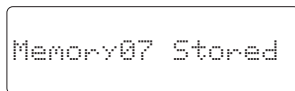

```
Memory07 Stored
```

After about 2 seconds, "Memory Store" is displayed.

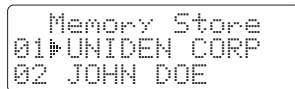

```
Memory Store
01 UNIDEN CORP
02 JOHN DOE
```

# Memory dialing

## Making calls with memory dialing

### [On-hook dialing]

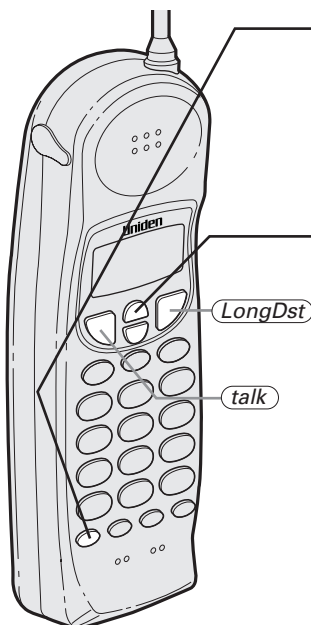

- 1** Press **mem** .  
The handset displays your programmed memory locations.

```
01 UNIDEN CORP
02 JOHN DOE
03 MDM AND DAD
```

- 2** Press the **▲** and **▼** keys to select the memory location you would like to dial.

For example if the **▼** key is pressed once, next the cursor move down to memory location number.

```
02 JOHN DOE
03 MDM AND DAD
04▶
```

Or press the number keypad to select the memory location you would like to dial.

For example if you pressed 1, 5 on the keypad, the display shows memory location number 15 with the cursor in that line.

```
15▶ JOHN SMITH
16 <Memory16>
17
```

- 3** Press **talk** , "Talk" momentarily flashes on the display and the volume setting is appeared, then the displayed number is dialed.

```
Talk
0123456789012
```

**Note** When **LongDst** is pressed instead of **talk** , LDM (Long Distance Manager) will be activated. (For LDM, refer to page 27.)

#### Notes

- To cancel the memory selection, press **mem** during memory dialing. The handset returns to standby.
- Whenever you are using a menu screen, you must press key within 20 seconds or the phone will return to standby. You may also press memory to access a memory menu at any time.

# Memory dialing (continued)

## Display a Programmed Number

Use the **#/▶** and **\*/tone/◀** key to toggle between the names display and the numbers display.

### Program name

```
01 UNIDEN CORP
02 JOHN DOE
03▶ MOM AND DAD
```

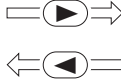

### Program number

```
01 8178583300
02 5452930
03▶ 8175551212
```

**Note** When the stored phone number has 14 or more digits, the first 12 digits of the phone number are displayed and "➔" is displayed at the 13th digit.

```
15 0123456789012
16▶ 011813554329+
17
```

## [Off-hook dialing]

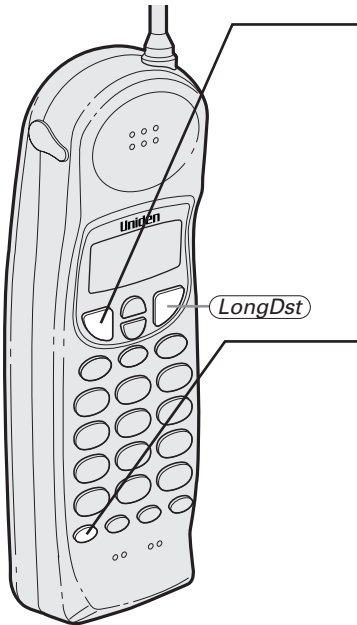

- 1 Press **talk** .  
"Talk" will flash on the display.

```
>Talk<
```

**Note** When **LongDst** is pressed instead of **talk** , LDM (Long Distance Manager) will be activated. (For LDM, refer to page 27 - 29.)

- 2 Press **mem** .  
(For LDM, refer to page 27 - 29.)

```
Talk 0:00
```

- 3 Press the number keypad to select the memory location of the desired phone number. The selected phone number is displayed.

```
Talk 0:35
0123456789012
```

# Memory editing

## Editing a stored name and/or phone number

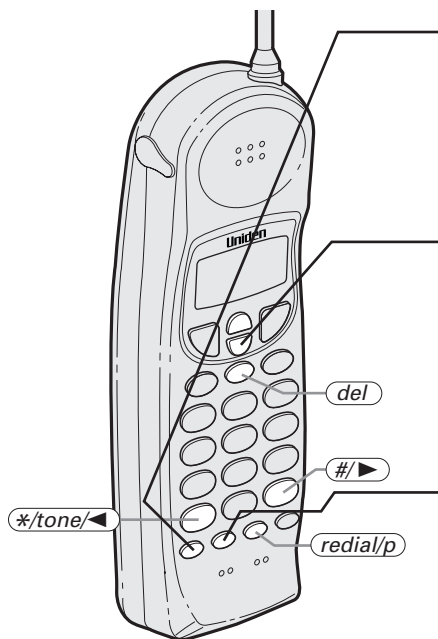

- 1** Press and hold **(mem)** for 2 seconds. The display shows the memory screen and any saved name/number.

```
Memory Store
01▶UNIDEN CORP
02 JOHN DOE
```

- 2** Press the **(▲)** or **(▼)** keys or number keypad to select the memory location you would like to edit.

```
Memory Store
01 UNIDEN CORP
02▶JOHN DOE
```

(See page 20.)

- 3** Press **(select/ch)**. The following screen appears with the memory location number that you have selected in the display.

For example if you selected memory location number the display shows memory 01 as the location in the selected.

```
▶Edit Memory01
Delete Memory01
Go Back
```

- 4** Press the **(▲)** or **(▼)** key to select "Edit Memory", then press **(select/ch)**. The following screen appears. The cursor flashes indicating that the display is ready for the name to be edited. When a name has not been stored, the cursor appears at the beginning of the second line.

```
Store Name
UNIDEN CORP■
```

- 5** Press **(▲)**, **(▼)**, **(# / ▶)**, **(\* / tone / ◀)**, or **(del)** to edit the name. (See page 19.) To edit only the phone number, skip this step.

- 6** Press **(select/ch)**. The following screen appears. The cursor flashes indicating that the display is ready for the number to be edited.

```
Store Number
017858330■
```

# Memory dialing (continued)

**7** Use the number keypad, **(\*/tone/◀)**, **(#/▶)**, **(redial/p)**, or **(del)** key to edit the phone number. The phone number cannot exceed 20 digits. (See page 19.) When the phone number will not be edited, skip this step.

**8** Press **(select/ch)**.  
The handset beeps and displays the confirmation screen. The memory storage is complete.

```
Memory01 Stored
```

For example if you store a name and number into memory location number 01, the display shows "Memory01 stored".

After about 2 seconds, "Memory Store" is displayed.

```
Memory Store
01▶ UNIDEN CORP
02▶ JOHN DOE
```

**9** Press **(mem)** to exit edit mode.

## Display a Programmed Number

Use the **(#/▶)** and **(\*/tone/◀)** key to toggle between the names display and the numbers display.

### Program name

```
Memory Store
01 UNIDEN CORP
02▶ JOHN DOE
```

### Program number

```
Memory Store
01 8178583300
02▶ 5452930
```

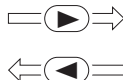

• When the stored phone number has 14 or more digits, the first 12 digits of the phone number are displayed and "▶" is displayed at the 13th digit.

Press **(\*/tone/◀)** to return to the original display.

```
Memory Store
06▶ 011813554329+
07
```

```
Memory Store
+300000
```

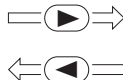

# Memory erasing

## Erasing a stored name and phone number

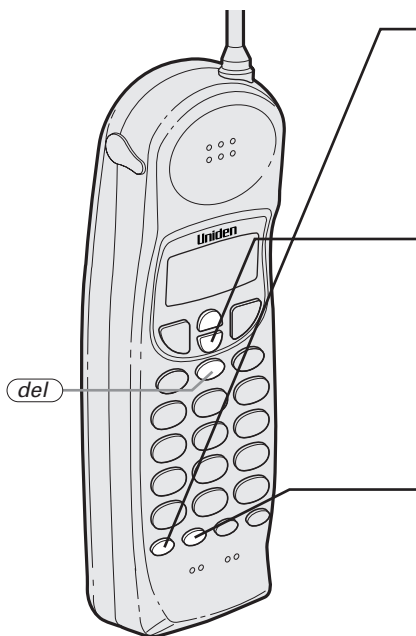

- 1** Press and hold **(mem)** for 2 seconds. The display shows the memory screen and any saved name/number.

```
Memory Store
01 UNIDEN CORP
02 JOHN DOE
```

- 2** Press the **(▲)** or **(▼)** keys or number keypad to select the memory location you would like to edit.

```
Memory Store
01 UNIDEN CORP
02 UNIDEN CORP
```

(See page 20.)

- 3** Press **(select/ch)**. The following screen appears with the memory location number that you have selected in the display.

For example if you selected memory location number the display shows memory 02 as the location in the selected.

```
# Edit Memory02
Delete Memory02
Go Back
```

- 4** Press the **(▼)** key to move the cursor down to "Delete Memory" command line.

```
 Edit Memory02
# Delete Memory02
Go Back
```

- 5** Press **(select/ch)**. The following confirmation screen appears.

```
Delete Memory02?
Yes
# No
```

- 6** Press the **(▲)** or **(▼)** key to move the cursor to "Yes".

- 7** Press **(select/ch)** or **(del)**. There is a confirmation tone and memory is deleted. The following screen appears.

For example if memory location number 02 is selected for deletion, the following display appears as the confirmation screen.

```
Memory02 Deleted
```



## Memory dialing (continued)

- 8 After 2 seconds the display returns to the "Memory Store" screen. You may select another number to delete (return to step 4).

```
Memory Store
02▶
03 MOM AND DAD
```

- 9 Press **mem** to return to standby.

## On-hook dial editing

In the on-hook condition (when the handset is in standby mode), you may edit displays when the cursor is flashing.

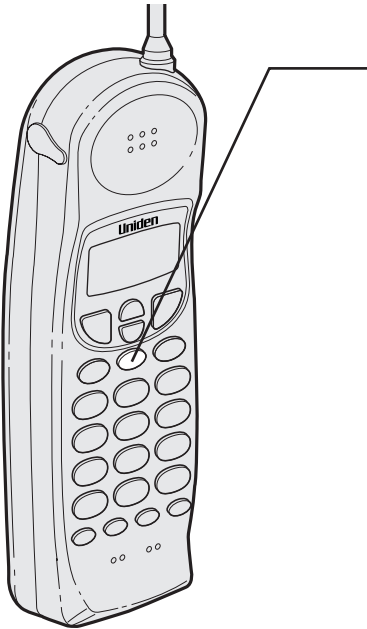

### Deleting a phone number

Press **del** and the cursor will move one space to the left and delete that number.

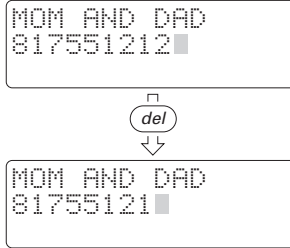

#### Notes

- After deleting the number, holding down **del** will cancel the on-hook dial edit clear the display.
- Whenever you are using a menu screen, you must press a key within 20 seconds or the phone will return to standby, may also press memory to access a memory menu at any time.

# Mute

During a conversation you can cut off the sound from the handset.

## Off-hook mute

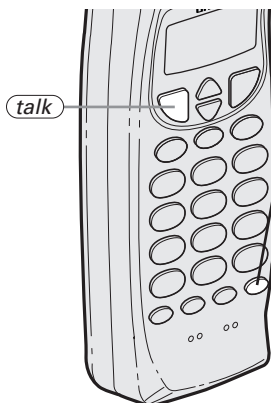

- 1 Press **(mute/ring)** during a telephone call.

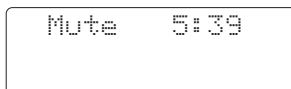

The sound from the microphone is cut off.

- 2 To cancel mute, Press **(mute/ring)** or **(talk)**.

## Bell in mute

Press **(mute/ring)** when the phone rings. The ringer sound is cut off.

### Note

Press **(mute/ring)** when paging, stops the paging.

# LDM (Long Distance Manager)

## Sign-up and Registration

- 1) Before using the LDM feature, you must register your phone by calling 1-800-458-2682.
- 2) You will be asked a few simple questions, such as name, address and phone number.
- 3) Each month you will receive an itemized bill for calls placed through the LDM service.

## Placing a call using LDM

Press the **(LongDst)** key before dialing a long distance (1+) or international (011+) number.

# LDM (Long Distance Manager) (continued)

## [LDM On-hook dialing]

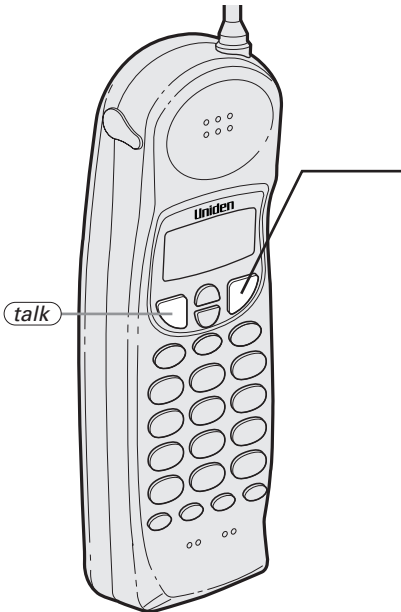

**1** Dial the phone number. Or, when using Redialing, Memory dialing, or Caller ID dialing, select the desired number to be called.

**2** Press **(LongDst)**.  
"LongDst" flashes on the display.

```
LongDst  
1234567890123456  
789
```

Then the volume setting is displayed.  
For example if the volume is set to high, the display shows "<High>".

```
LongDst  
<High>
```

**3** "LongDst" appears and remains on.

```
LongDst 0:02  
1234567890123456  
789
```

**4** To hang up, press **(talk)**.  
The call-time is displayed for 5 seconds.

### Notes

- You must dial a "1" or "011" when using the LDM feature.
- When using the Caller ID list to make a phone call, please make the long distance call settings beforehand. (See page 33.)
- **Do NOT USE (LongDst) BUTTON TO DIAL 911 BECAUSE IT WILL NOT ACCESS EMERGENCY SERVICE.**
- Do not use the **(LongDst)** key for placing local calls, contacting your local phone company for repair or customer service, accessing emergency service or for toll free numbers.
- All calls placed through the LDM feature will be charged at the applicable toll rate for the specific call.
- Failure to register will result in lost savings.

# LDM (Long Distance Manager) (continued)

## [LDM Off-hook dialing]

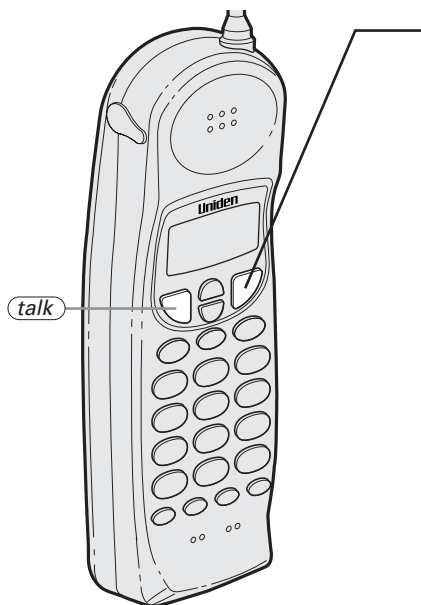

- 1 Press **LongDst** .  
"Longdst" flashes on the display.

```
Longdst
```

- 2 **Off-hook dialing**  
Enter a long distance number.

```
LongDst  
<High>
```

**Note** If dialing a local number, do not use the long distance manager. You must dial a "1" or "011" when using the LDM feature.

- 3 To complete, press **talk** , or return the handset on the base. The display shows the call-time for 5 seconds.

### Off-hook redialing

Press **LongDst** , then press **redial/p** the display shows the last number dialed.

```
Store Number  
1017858330 ■
```

**Note** If the last number dialed is not a Long Distance Number, it will not connect.

### Off-hook memory dialing

Press the number keypad to select the memory location (01 to 20) of the desired phone number. The display shows the number you selected.

# LDM (Long Distance Manager) (continued)

## [LDM Private Branch Exchange (PBX) dialing]

**1** Press **(talk)**.

"Talk" flashes on the display.



Then the volume setting is displayed.

For example if the volume is set to high, the display shows "<High>".



**2** After about 5 seconds, the display indicates the call-time.



**3** Dial out by entering 9 on the keypad, or any sequence of numbers required to access an outside line.



**4** Listen for the dial tone. Then press **(LongDst)** followed by a long distance or international number. The call will be placed using the LDM service.



**5** To complete the call, press **(talk)** or return the handset to the base. The display shows the call-time for 5 seconds.

# Paging

## To locate the handset

When it is not on the base.

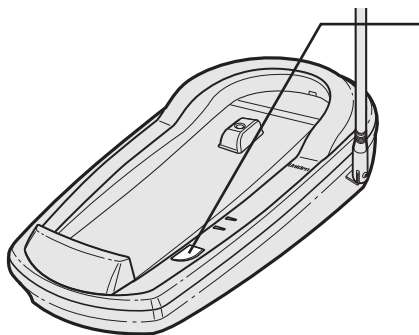

**1** Press and hold **(page/find)** on the base for more than 2 seconds.

**2** The handset beeps for 60 seconds. The following screen appears;

Paging

**3** Press any key on the handset to end.

### Notes

- If you press and hold **(page/find)** for less than a second, the handset only beeps for 5 seconds. If you press and hold **(page/find)** for longer than 60 seconds, the handset beeps for the same of time that you press and hold it for.
- When an incoming call is received during paging, paging is stopped and the telephone is switched to the incoming call.
- If you press the **(talk)** key during a page, the handset will be placed in off-hook (talk) mode.
- Paging cannot be performed while the handset is in use.

## Caller ID service

**You must subscribe to the Caller ID service from your telephone company to use this feature.**

When the telephone rings, the Caller ID feature allows you to view the caller's phone number on the display before you answer the phone.

The handset displays the phone number of the incoming call, the name, time, and the number of calls. Additionally, you can dial the displayed number, and store the information for memory dialing.

## Setting Caller ID options

There are three Caller ID options, Auto Talk, CIDCW (Caller ID with Call Waiting), and Area Code.

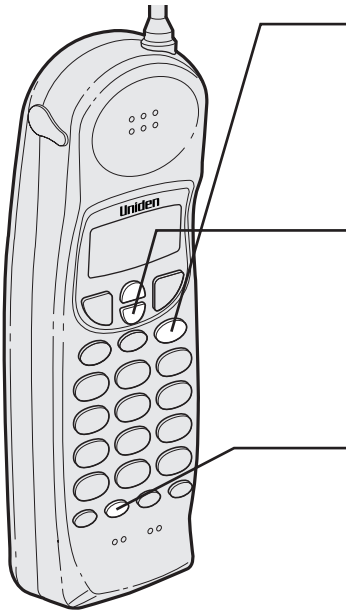

- 1** In the standby mode, hold down **call id** until the Caller ID setting appears.

```
1 Auto Talk: Off
2 CIDCW      : On
3 Area Code:
```

- 2** Press **▲** or **▼** to move the cursor to the item that is to be set.

**Example:** To select CIDCW

```
1 Auto Talk: Off
2 CIDCW      : On
3 Area Code:
```

- 3** For Auto Talk and CIDCW Press **select/ch** toggle between on and off. For the Area Code setting please see page 11.

- 4** To complete the settings, press **call id**.
  - Return the handset to the base unit. The phone returns to standby mode.

## When the telephone rings

- 1** When the Caller ID message is received, **status** lamp blinks. The display shows the caller's phone number in memory, along with the date and time. The incoming call information is stored. If the Caller ID service includes the caller's name, the caller's name appears on the display (up to 15 letters).

<b>The date and time received</b>	5/11 12:30PM 01
<b>Caller's name</b>	UNIDEN CORP
<b>Caller's phone number</b>	813-858-3300

Here are some typical displays;

**When the phone number and name data are received**

```
5/11 12:30PM 01
UNIDEN CORP
817-858-3300
```

**When a private number is received**

```
5/11 12:30PM 01
UNIDEN CORP
Private Number
```

**When a private name is received**

```
5/11 12:30PM 01
Private Name
817-858-3300
```

**When an unknown number is received**

```
5/11 12:30PM 01
UNIDEN CORP
Unknown Number
```

**When an unknown name is received**

```
5/11 12:30PM 01
Unknown Name
817-858-3300
```

**When invalid data is received**

```
Incomplete Data
```

- 2** When the telephone is answered, the display changes to "Talk". (See page 16.)

### Notes

- If you answer a call before the Caller ID message is received (Example: before the second ring), the Caller ID message will not appear.
- When the call is received via a telephone company that does not offer Caller ID service, the caller's phone number and name do not appear. (This includes international calls.)
- When the call is via a private branch exchange (PBX), the caller's phone number and name may not appear.
- Data errors appear as "■".

```
5/11 12:30PM 01
UNI ■ EN CORP
813-8 ■ ■ -3300
```



## Viewing the Caller ID Message list

The Caller ID list stores information for up to 50 incoming calls—even unanswered calls.

**Note** If a call comes in via a telephone system that does not offer Caller ID service, no information is stored.

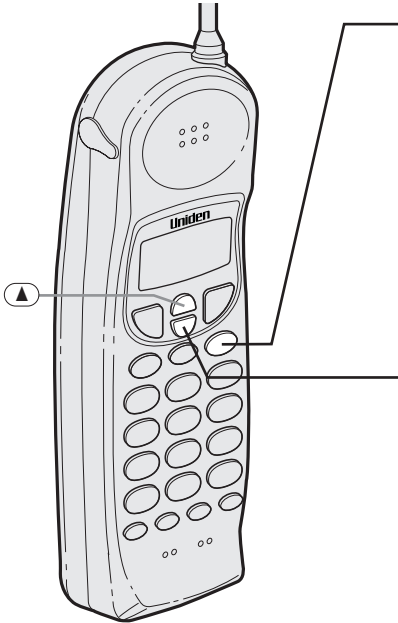

- 1 Press **call id** . The summary screen appears. When there are new messages, "New" and the number of calls are displayed. The summary screen shows how many new calls are stored, along with the total of new calls and old calls stored in the list.

```
New :01
Total:02
```

- 2 Press **▼** to display the latest caller ID message.

```
5/17 12:30PM 03
UNIDEN CORP
817-858-3300
```

- 3 Press **▼** to see the next message. Or press **▲** to see previous message.

- 4 Press **call id** to return to standby.

### Long Distance call settings and cancellation

Pressing **1** while the incoming call information is displayed (in step 2) will set or cancel a long distance call. The prefix "1—" will be displayed at the beginning of the phone number when a long distance call is set. (When the phone number is 15 digits long, only "1" is displayed.) Pressing **1** will cancel the long distance call setting.

```
5/17 12:30PM 03
UNIDEN CORP
1-817-858-3300
```

### Notes

- "End" appears when you have received all messages in the Caller ID list.
- Press **▲** to return to the summary screen.
- Each message can be up to 15 characters for the phone number and the name.

### Deleting information from the Caller ID list

The EXLI 8962 stores up to 50 messages. If more new calls are received, message stored in the list are deleted beginning with the oldest messages in the list.

Old data that was entered 51 or more numbers earlier will be deleted automatically. Unnecessary data can also be deleted manually.

#### [Deleting a Caller ID message]

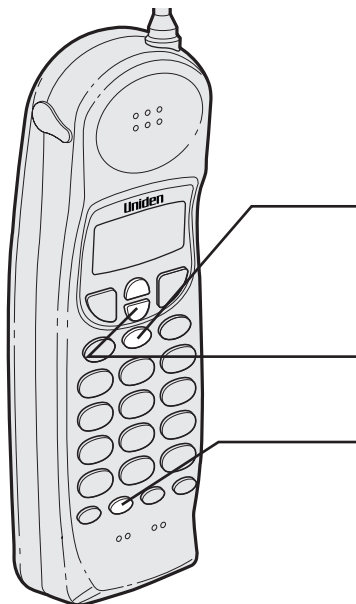

- 1 Display the message to be deleted from the Caller ID list. (See page 33.)

```
5/17 12:30PM 03
UNIDEN CORP
817-858-3300
```

- 2 Press **del**.

```
Delete Message ?
#Yes
No
```

- 3 Press **▲** or **▼** to select "Yes" or "No".

- 4 Press **select/ch** or **del**.

**When the pointer is at "Yes":**

A beep tone sounds and the next Caller ID message displayed.

**When the pointer is at "No":**

The display returns to the Caller ID display.

#### Notes

- While using the "Delete Message ?" screen, if no key is pressed for more than 20 seconds, an error tone sounds and the telephone returns to standby.
- If you get an incoming call, memory storage is cancelled and the telephone returns to standby so you can answer the call.

## [Deleting all Caller ID name/numbers]

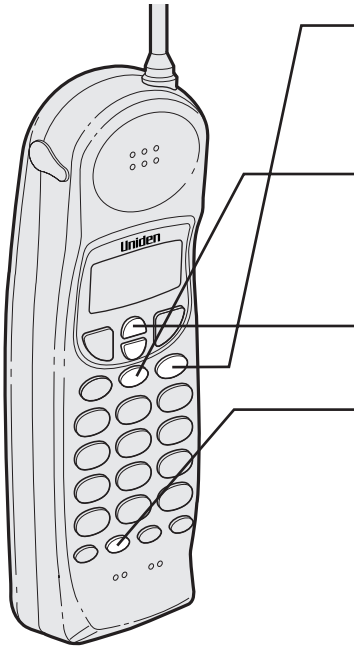

**1** Press **call id** .

```
New :01
Total:02
```

**2** Press **del** .

```
Delete All ?
Yes
No
```

**3** Press **▲** or **▼** to select "Yes" or "No".

**4** Press **select/ch** or **del** .

**When the pointer is at "Yes":**

A beep tone sounds and all stored Caller ID messages are deleted.

```
Total:00
```

**When the pointer is at "No":**

The display returns to the summary screen.

```
New :01
Total:02
```

### Notes

- While using the "Delete Message ?" screen if no key is pressed for more than 20 seconds, an error tone sounds and the telephone returns to standby.
- If you get an incoming call, memory storage is cancelled and the telephone returns to standby so you can answer the call.

# Using the Caller ID list

## Calling a party from the Caller ID list

You can place a call from the Caller ID list.  
The EXLI 8962 stores up to 50 messages.

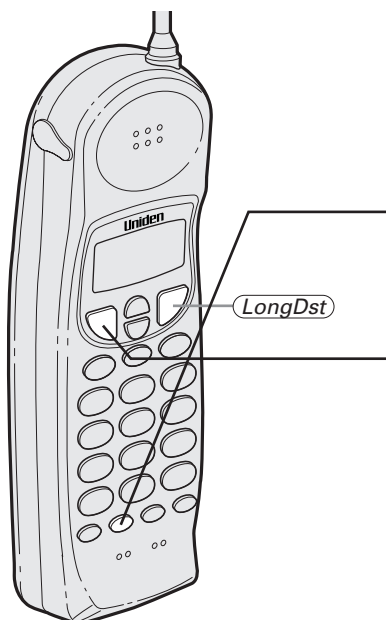

- 1** Select the phone number that you want to dial. (See page 34.)

```
5/17 12:30PM 03
UNIDEN CORP
817-858-3300
```

- 2** Press **(select/ch)**.

```
UNIDEN CORP
8178583300 ■
```

- 3** Press **(talk)**.

```
>Talk<
8178583300
```

The displayed phone number dials automatically.

**Note** When **(LongDst)** is pressed instead of **(talk)**, LDM (Long Distance Manager) will be activated. (For LDM, refer to page 27.)

## Long Distance calls

Pressing **(1)** while the incoming call information is displayed (in step 1) will set or cancel a long distance call.

### Notes

- When a long distance call has been set, "1" appears in the display.
- You cannot make a call from the Caller ID list, if your EXLI 8962 is connected to private branch exchange (PBX).
- When the cursor is displayed at the end of the phone number (as in step 2), editing of the phone number will not be possible. (See page 25.) Caller ID messages can not be changed from the Caller ID list. You must first store messages in memory. (See page 37.)

## Storing Caller ID messages in Memory dialing

Messages shown in the Caller ID list can be stored in memory dialing. Using the incoming call information (i.e., Caller ID list), the phone number of the party on the Caller ID list can be stored in memory dialing.

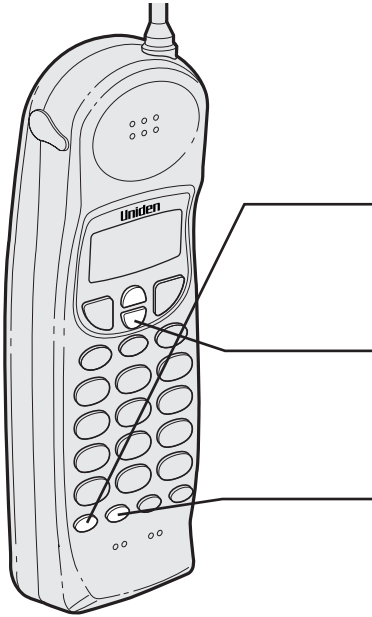

- 1 Select the phone number to be stored from the Caller ID list. (See page 33.)

```
5/17 12:30PM 03
UNIDEN CORP
817-858-3300
```

- 2 Press **mem**.

```
Select Location
01 UNIDEN CORP
02 JONE DOE
```

- 3 Press **▲** or **▼** to select the message you want to store. Press the dial buttons (**0** to **9**) and select the number (01 to 20).

- 4 Press **select/ch**. A beep tone will sound. The number is stored in memory, and the display returns to the Caller ID list.

```
5/17 12:30PM 03
UNIDEN CORP
817-858-3300
```

### Notes

- If a message has already been stored in the selected memory numbers location, a verification screen is displayed.

Press **▲** or **▼** to select "Yes".

Press **select/ch** to overwrite. The display returns to the Caller ID list.

- Caller ID lists for which phone numbers are not displayed cannot be stored in memory dialing. You can not store a Caller ID message if no phone number appears in the message.
- If no key is pressed for more than 20 seconds, an error tone sounds and the telephone returns to the standby mode.
- If there is an incoming call or paging, memory storage is cancelled and the telephone is set to the incoming call or paging. If you get an incoming call, memory storage is cancelled.

```
Replace Memory ?
Yes
No
```

### Using "Caller ID with call waiting" service

"Caller ID" and "Call waiting" are separate services. CIDCW (Caller ID on Call Waiting) performs the same as regular Caller ID on a call waiting number. You must subscribe to the "Caller ID with call waiting (CIDCW)" service from your telephone company before you can use the following features.

The "Call waiting" service can also be used independently. Please contact your telephone company for details.

When a new incoming call arrives during your current telephone call, the phone number appears. (The name of the new caller is displayed, depending upon the telephone service.)

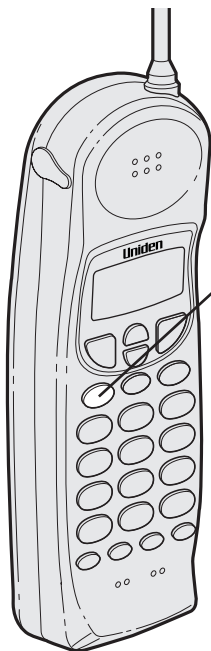

- 1 When a new incoming call arrives during your current telephone call, the phone number and the name of the caller is displayed.

```
Talk 10:30  
UNIDEN CORP  
817-858-3300
```

- 2 Press **(flash)**.  
You will be able to talk with the person that has just called. The person with whom you were talking will be put on hold.

- 3 To return to the first caller, press **(flash)** once again.

### Changing the digital security code

The digital security code is an identification code used to connect the handset and the base unit. Normally, setting the code is not necessary.

The first time you charge your handset, the security code is automatically set. (See page 4.)

In the rare situation that you suspect another cordless telephone is using the same security code, you can change the code.

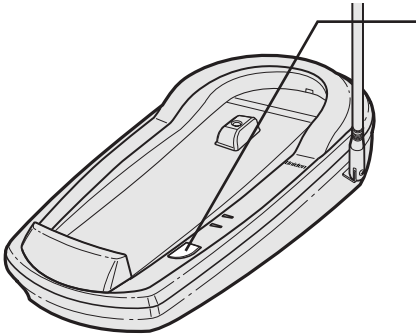

- 1** Remove the handset from the base unit. Press **(page/find)**.
- 2** While the handset is producing the paging sound, hold **(page/find)** while placing the handset in the base unit. The paging tone stops. Leave the handset on the base. A random, new security code is set.

#### Note

If the handset battery pack is completely discharged or the battery pack removed, the digital security code will be lost.

If this happens, a new security code is set automatically the next time the battery pack is charged.

## Additional information

### Mounting the base unit on a wall

#### [Standard wall plate mounting]

This phone can be mounted on any standard AT&T or GTE wall plate.

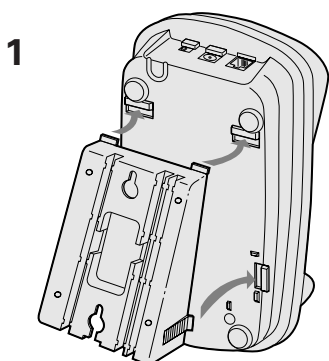

- 1** Snap the wall mount adapter into the notches on the base.

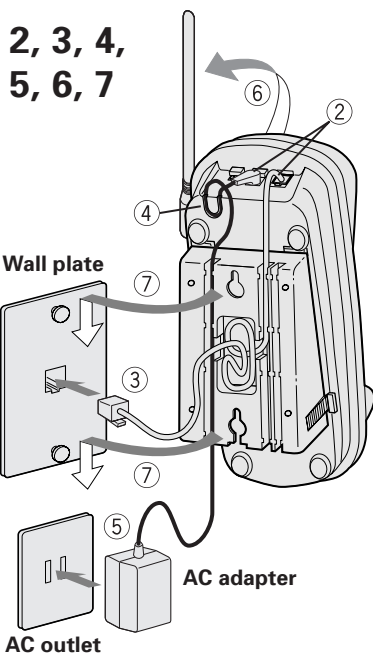

- 2** Plug the telephone line cord to the **TEL LINE** jack and the AC adapter to the **DC IN 9V** jack.
- 3** Plug the telephone line cord into the telephone outlet.
- 4** Wrap the AC adapter cord inside the molded wiring channel. Then wrap the cord around the strain relief notch.
- 5** Plug the AC adapter into a standard 120VAC wall outlet.
- 6** Raise the antenna to a vertical position.
- 7** Align the mounting slots on the base with the mounting posts on the wall. Push in and down until the phone is firmly seated.



## Additional information

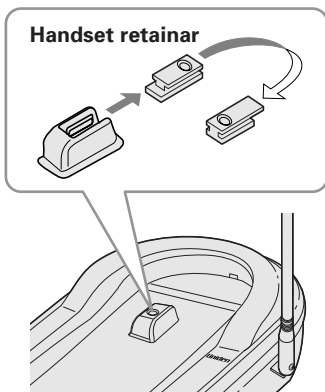

- 7 On the base unit, pull the handset retainer out of the slot. Rotate it clockwise 180 degrees.
- 8 Flip the retainer from front to back. Slide it back into the slot so that the lip of the retainer is up and the oval is down. The retainer holds the handset in place,

### [Direct wall plate mounting]

If you don't have a standard wall plate, you can mount your phone directly to the wall. Before doing this, consider the following:

- Avoid electrical cables, pipes, or other items behind the mounting location. That could cause a hazard when inserting screws into the wall.
- Try to mount your phone within 10 - 15 feet of a working phone jack to avoid excessive cord lengths.
- Make sure the wall material is capable of supporting the weight of the base and handset.

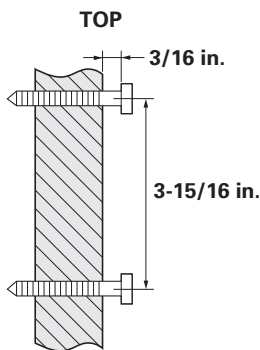

- 1 Insert two mounting screws into the wall, (with their appropriate anchoring device),  $3-15/16$  inches apart. Allow about  $3/16$  of an inch between the wall and screwheads for mounting the phone.
- 2 Refer to steps 1 through 8 on page 39 to mount the telephone.

## Additional information

### Installing the beltclip

#### To attach the beltclip

Inset the beltclip into the holes on each side of the handset. Press down until it clicks.

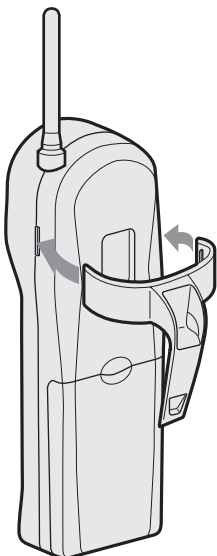

#### To remove the beltclip

Pull both sides of the beltclip to release the tabs from the holes.

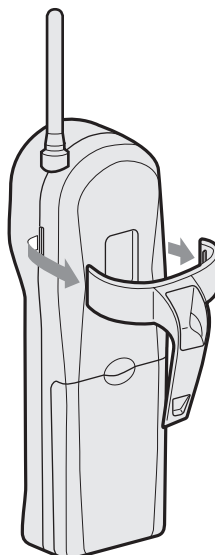

---

### Headset installation

Your phone may be used with an optional headset. To use this feature, simply plug any standard 2.5mm headset plug into the headset jack. Your phone is ready for hands-free conversation.

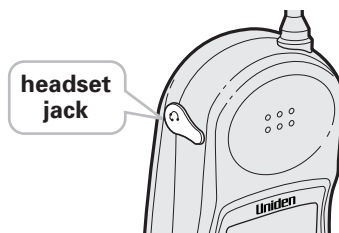

## Additional information

### Note on power sources

#### Battery replacement and handling

When the operating time becomes short, even after a battery is recharged, please replace the battery.

With normal usage, your battery should last about one year.

Please contact your place of purchase for a replacement battery.

#### Power Failure

During the period that the power is off, you will not be able to make or receive calls with the telephone.

#### RECYCLING NICKEL-CADMIUM BATTERIES

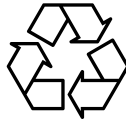

**NICKEL-CADMIUM BATTERIES MUST BE DISPOSED OF PROPERLY.**

**Ni-Cd**

Nickel-cadmium cells are used in the battery pack. Please take your used nickel-cadmium battery packs to a store that recycles nickel-cadmium batteries.

#### Caution

- Use the specified battery pack.
- Do not remove the battery from the handset to charge it.
- Never throw the battery into a fire, disassemble it, or heat it.
- Do not remove or damage the battery casing.

### Maintenance

#### When slightly dirty

Wipe with a soft, dry cloth.

#### When very dirty

Wipe with a soft cloth that has been dampened with diluted, neutral detergent. Dry with a dry cloth.

#### When the charging terminals become dirty

Wipe with a pencil eraser or other contact cleaner.

#### Caution

Do not use paint thinner, benzene, alcohol, or other chemical products. Doing so may discolor the surface of the telephone and damage the finish.

### Troubleshooting

If your phone is not performing to your expectations, please try these simple steps first.

Symptom	Suggestion
The status light won't come on when the handset is placed in the base unit.	<ul style="list-style-type: none"> <li>• Make sure the AC adapter is plugged into the base unit and wall outlet.</li> <li>• Make sure the handset is properly seated in the base unit.</li> <li>• Make sure the charging contacts on the handset and base unit are clean.</li> </ul>
The audio sounds weak and/or scratchy.	<ul style="list-style-type: none"> <li>• Make sure that the base unit antenna is in a vertical position.</li> <li>• Move the handset and or base unit to a different location away from metal objects or appliances and try again.</li> <li>• Press <b>(select/ch)</b> to help eliminate background noise.</li> <li>• Make sure that you are not too far from the base.</li> </ul>
Can't make or receive calls	<ul style="list-style-type: none"> <li>• Check both ends of the base unit telephone line cord.</li> <li>• Make sure the AC adapter is plugged into the base unit and wall outlet.</li> <li>• Disconnect the AC adapter for a few minutes, then reconnect it.</li> <li>• Reset the digital security code (See page 39).</li> <li>• Make sure <b>(talk)</b> is pressed.</li> </ul>
The handset doesn't ring or receive a page.	<ul style="list-style-type: none"> <li>• The battery pack may be weak. Charge the battery on the base unit for 15 hours.</li> <li>• The handset may be too far away from the base unit.</li> <li>• Place the base unit away from appliances or metal objects.</li> <li>• Reset the digital security code (See page 39).</li> </ul>
The Caller ID disappears.	<ul style="list-style-type: none"> <li>• The handset was picked up before the second ring.</li> <li>• The call was placed through a switch board.</li> </ul>
The Caller ID does not display.	<ul style="list-style-type: none"> <li>• Call your local telephone company to verify your Caller ID service is current.</li> </ul>
LDM dose not work.	<ul style="list-style-type: none"> <li>• Review LDM instructions on pages 26 to 29.</li> </ul>

# Additional information

## Specifications

### General

The EXI-8962 complies with FCC Parts 15 and 68.

Frequency control: PLL

Frequency shift keying: FSK

Operating temperature: 0°C to +50°C (+32°F to +122°F)

### Base unit

RX frequency: 902.119 MHz to 905.016 MHz (30 channel)

TX frequency: 924.997 MHz to 927.894 MHz (30 channel)

Power requirements: 9V 210mA (from AC adapter)

Size: 8-41/64 in. (W) x 4-17/32 in. (D) x 2-19/64 in. (H)  
(220 mm (W) x 115 mm (D) x 58.21 mm (H))

Weight: Approx. 10.8 oz. (Approx. 306.4 g)

### Handset

RX frequency: 924.997 MHz to 927.894 MHz (30 channel)

TX frequency: 902.119 MHz to 905.016 MHz (30 channel)

Power requirements: Rechargeable Nickel-Cadmium battery pack

Size (without antenna): 7 in. (W) x 2-17/64 in. (D) x 2 in. (H)  
(178 mm (W) x 57.6 mm (D) x 51 mm (H))

Weight: Approx. 9.3 oz. (264.6 g) (including battery)

Battery: BT905

Capacity 600 mAh, 3.6V

Talk mode 7 hours TYP

Standby mode 7 days TYP

Specifications, features, and availability of optional accessories are all subject to change without prior notice.

## At Uniden, we'll take care of you!

If you need any assistance with this product, please call our Customer Hotline at:

**1-800-297-1023**

**PLEASE DO NOT RETURN THIS PRODUCT TO THE PLACE OF PURCHASE.**

Our Uniden representatives will be happy to help you with any matters regarding the operation of this unit, available accessories, or any other related matters.

Thank you for purchasing a Uniden product.

Hours: M-F 7:00 AM to 7:00 PM CST

# Additional information

## Index

### A

Area code .....11

### B

Battery pack

Preparing and charging .....9

Replacement and handling .....43

### C

Caller ID service

Calling from the Caller ID list .....36

Deleting the Caller ID list .....34

Setting Caller ID options .....31

Storing the data of the

Caller ID list to Memory .....37

Viewing Caller ID message list .....33

Caller ID with Call Waiting .....38

Channel .....12

Connection .....7

### D

Dialing mode .....8

Digital security code .....4,39

### E, F, G

Ear speaker volume .....17

### H

Headset installation .....42

### I, J, K

Installing the beltclip .....42

### L

LDM (Long Distance Manager) .....26

### M, N

Maintenance .....43

Making calls

Off-hook dialing .....13

On-hook dialing .....12

Memory dialing

Editing a stored name and/or  
phone number .....22

Erasing a stored name and/or  
number .....24

Using memory dialing .....20

Storing phone numbers and  
names .....18

Mounting the base unit to a wall .....40

Mute .....26

### O

On-hook dial editing .....25

### P, Q

Package contents .....5

Paging .....30

### R

Receiving calls .....16

Redialing .....14

Ringer tone .....17

Ringer switch .....17

### S

Setup

Base unit .....6

Handset .....9

Specifications .....45

### T

Troubleshooting .....44

### U, V, W, X, Y, Z

Using "Caller ID with Call Waiting"  
service .....38



# **Uniden America Corporation**

4700 Amon Carter Boulevard  
Fort Worth, TX 76155

Printed in Hong Kong  
UCZZ01619ZZ



## Free Manuals Download Website

<http://myh66.com>

<http://usermanuals.us>

<http://www.somanuals.com>

<http://www.4manuals.cc>

<http://www.manual-lib.com>

<http://www.404manual.com>

<http://www.luxmanual.com>

<http://aubethermostatmanual.com>

Golf course search by state

<http://golfingnear.com>

Email search by domain

<http://emailbydomain.com>

Auto manuals search

<http://auto.somanuals.com>

TV manuals search

<http://tv.somanuals.com>