



E X S 2 0 8 0

OWNER'S MANUAL

900 MHz Digital
Spread Spectrum
Technology

Caller ID

Call Waiting
Caller ID

Digital Answering
System

Uniden®

Introduction

Congratulations on your purchase of the EXS 2080 cordless telephone. This phone is designed for reliability, long life, and outstanding performance utilizing the latest in 900 MHz Spread Spectrum technology.

Note: Some illustrations in this manual may differ from the actual unit for explanation purposes.

Features

- 900 MHz Spread Spectrum Technology
- Digital Answering Device
- Caller ID and Call Waiting Caller ID
- 50 Number Caller ID Memory
- 3-Line, 16 Character Backlit Handset Display
- 20 Enhanced Memory Dial Locations
- 32 Digit Redial
- 3 Redial Memories
- Flash and Pause
- Pulse / Tone Dialing
- 3-Way Conference Operation
- Speakerphone
- Page / Find
- 10 Day Standby Battery Life
- 6 Hour Talk Time
- Handset Earpiece and Ringer Volume Control
- Hearing Aid Compatible

Digital Spread Spectrum Technology utilizes a “wider frequency band” vs. a “single narrow band” used in standard digital transmissions. The result is a more secure conversation with the clarity of digital sound, extended range, and minimal interference from other cordless phone.

Random Code™ digital security automatically selects one of over 65,000 codes for the handset and base.

These features enhance your phone’s security and also prevent unauthorized calls as a result of your phone being activated by other equipment.

Controls and functions

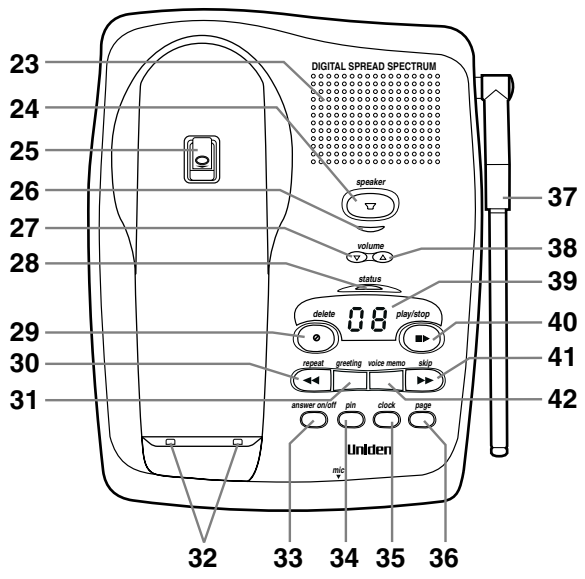
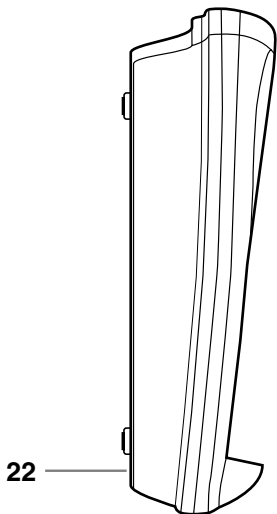
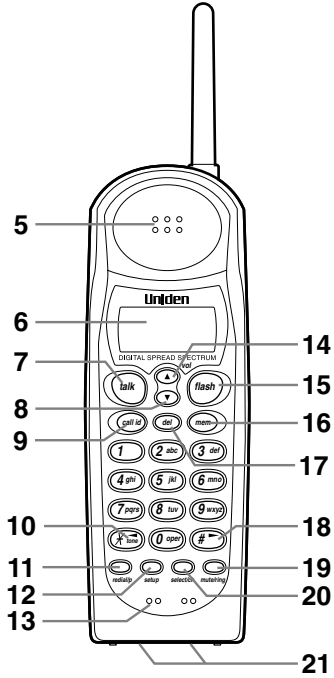
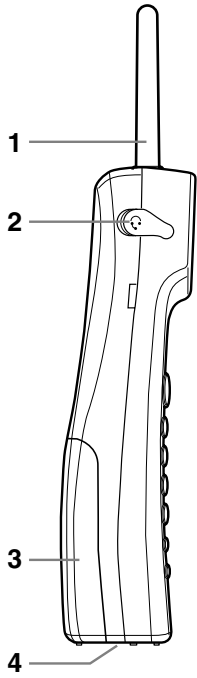

- | | |
|--------------------------------|----------------------------|
| 1. Handset antenna | 22. Base microphone |
| 2. Headset jack cover | 23. Base speaker |
| 3. Handset battery compartment | 24. Speaker key |
| 4. Ringer off-on switch | 25. Handset retainer clip |
| 5. Handset earpiece | 26. Speaker LED |
| 6. LCD display | 27. Volume down key |
| 7. Talk key | 28. Status LED |
| 8. Volume/Cursor down key | 29. Delete key |
| 9. Call ID key | 30. Repeat key |
| 10. Tone/left cursor key | 31. Greeting key |
| 11. Redial/Pause key | 32. Base charging contacts |
| 12. Setup key | 33. Answer on/off key |
| 13. Handset microphone | 34. Pin code key |
| 14. Volume/Cursor up key | 35. Clock key |
| 15. Flash key | 36. Page key |
| 16. Memory key | 37. Base antenna |
| 17. Delete key | 38. Volume up key |
| 18. Right cursor key | 39. LED display |
| 19. Mute/Ring key | 40. Play/Stop key |
| 20. Select/ch key | 41. Skip key |
| 21. Handset charging contacts | 42. Voice memo record key |
| | 43. Record time switch |
| | 44. Ring time switch |
| | 45. Ringer on/off switch |
| | 46. Pulse-Tone switch |
| | 47. DC power input |
| | 48. Phone jack |

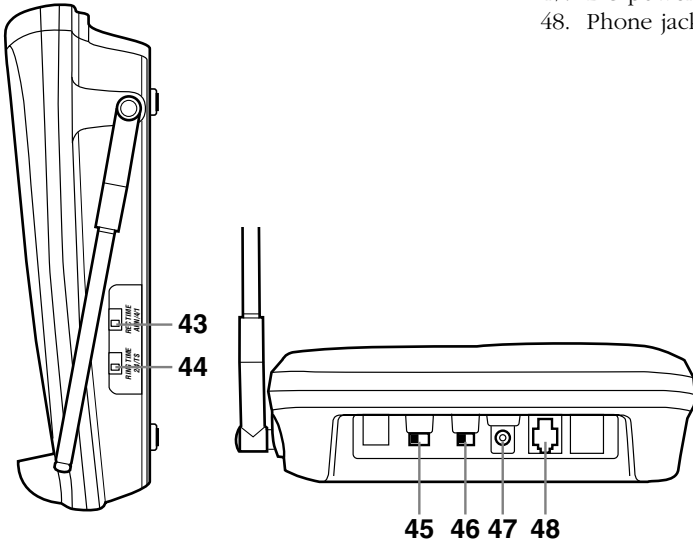

Contents

Introduction / Features.....	inside front cover
Controls and Functions	inside front cover
Getting Started	
Read this first.....	2
Step 1: Checking the package contents	3
Step 2: Setting up the base unit	4
Mounting the base unit on a wall	7
Step 3: Installing the handset battery pack.....	9
Basics	
Making a call	11
Receiving a call	13
Adjusting the volume	15
Redialing a call	16
Traveling out-of-range.....	17
Using the speakerphone.....	17
Page.....	18
Mute	18
Memory Dialing	
Storing phone numbers and names.....	19
Making calls with memory dialing.....	21
Chain dialing.....	22
Editing a stored name and/or phone number	23
Erasing a stored name and phone number.....	25
3-Way Conference Features	
3-way conferencing.....	26
Caller ID Features	
Caller ID.....	27
When the telephone rings	28
Viewing the Caller ID Message list	29
Deleting information from the Caller ID list	30
Using the Caller ID list	32
Using "Caller ID on call waiting" service	34
The Integrated Answering Device	
Features	35
Setting up your answering system.....	36
Using your answering system	41
Additional Information	
Changing the digital security code.....	47
Installing the beltclip.....	48
Headset installation	48
Note on power sources	49
Maintenance.....	49
Troubleshooting	50
Index	53

Getting Started

Basics

Memory
Dialing

3-Way
Conference
Features

Caller ID
Features

The Integrated
Answering
Device

Additional
Information

Read this first

This cordless telephone must be set up before use. Follow these steps;

Step 1 (page 3)

Unpack and check the telephone and accessories.

Step 2 (page 4 to 8)

Next, choose the best location to set up the base unit.



Base unit

Step 3 (page 9 to 10)

Then, insert the battery pack into the handset. You must charge the battery pack for more than 15-20 hours before using the phone.



Handset

About the digital security code

This cordless telephone uses a digital security code to prevent unauthorized access to your base unit. This security code prevents other cordless handsets from making calls through your base unit. A random security code will be assigned automatically between your base unit and handset when you charge the battery pack for the first time.

If you want to reset the security code, see page 47.

Checking the package contents

Make sure you have received the following items in the package. If any of these items are missing or damaged, contact the **Uniden Parts Department** (see below).



• Base unit



• Handset

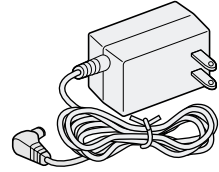

• AC adapter (AD-420)

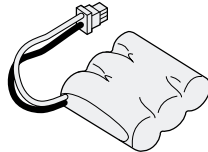

• Rechargeable battery pack (BT-905)

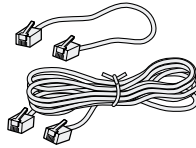

• Telephone line cord (2)

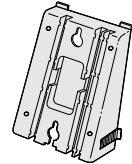

• Wall mount adapter

- This Owner's Manual
- Precautions and Important Safety Instructions
- Registration Card

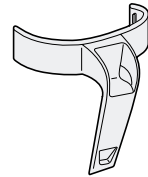

• Beltclip

Uniden Parts Department

(800) 554-3988

Hours: M-F 8:30 AM to 5:00 PM CST.

We can also be reached on the web at www.uniden.com.

Setting up the base unit

Do the following steps.

- Choose the best location
- Connect the base unit
- Choose the dialing mode

Choose the best location

Before choosing a location for your new phone, read the INSTALLATION CONSIDERATIONS included in the PRECAUTIONS AND IMPORTANT SAFETY INSTRUCTIONS brochure. Here are some important guidelines you should consider:

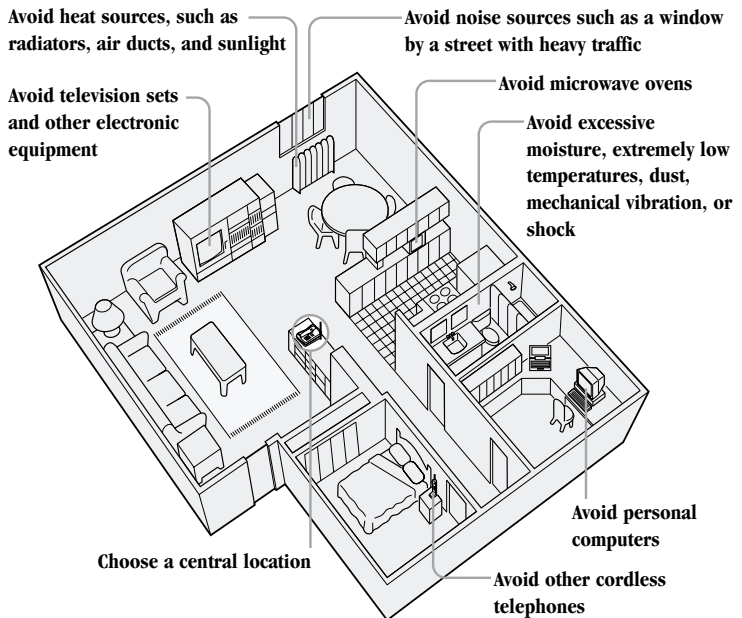

- You should charge your handset for more than 15-20 hours before using the phone.
- The location should be close to both a phone jack and a continuous power outlet which is not switchable.
- Keep the base and handset away from sources of electrical noise such as motors and fluorescent lighting.
- Be sure there is sufficient space to raise the base antenna fully vertical.
- The base can be placed on a desk, tabletop or mounted on a standard wall plate.

Connect the base unit

If you want to install the base unit on the wall, see page 7.

NOTE

Place the power cord so it does not create a trip hazard, or where it could become chafed and create a fire or electrical hazard.

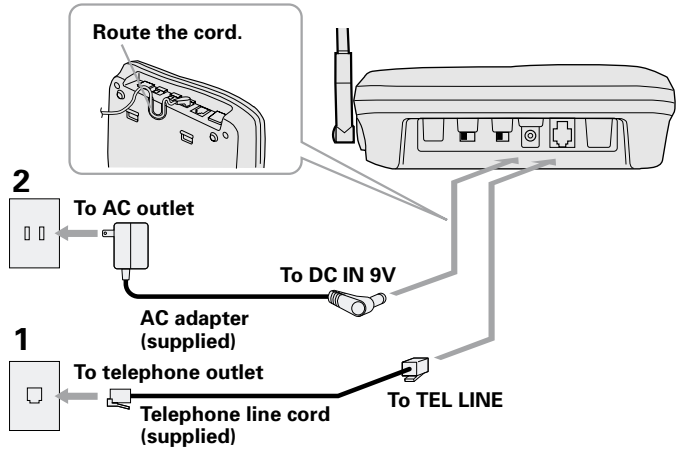

- 1** Connect the telephone line cord to the **TEL LINE** jack and to a telephone outlet.
- 2** Connect the AC adapter to the **DC IN 9V** jack and to a standard 120V AC wall outlet.
- 3** Set the base unit on a desk or tabletop and place the handset on the base unit. Then raise the antenna to a vertical position.

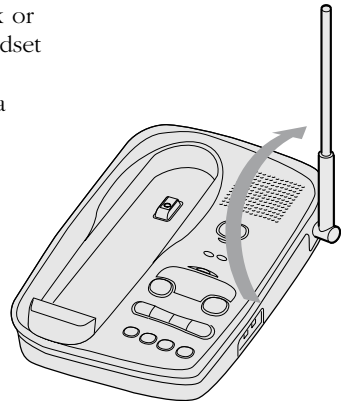



Use only the supplied AD-420 AC adapter. Do not use any other AC adapter.

Polarity of the plug

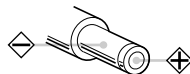

Connect the AC adapter to a continuous power supply.



Place the base unit close to the AC outlet so that you can unplug the AC adapter easily.



If your telephone outlet isn't modular, contact your telephone company for assistance.

Modular



Choose the dialing mode

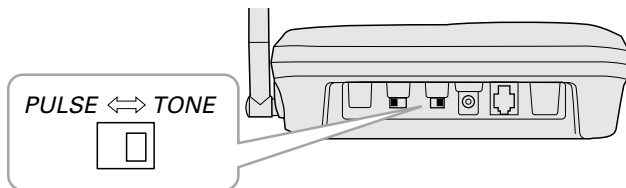

Depending on your dialing system, set the **PULSE-TONE** switch as follows:

If your dialing system is	Set the switch to
Tone	<i>TONE</i>
Pulse	<i>PULSE</i>

If you aren't sure of your dialing system

Make a trial call with the **PULSE-TONE** switch set to ***TONE***. If the call connects, leave the switch as is; otherwise, set to ***PULSE***.

Mounting the base unit on a wall

Standard wall plate mounting

This phone can be mounted on any standard telephone wall plate.

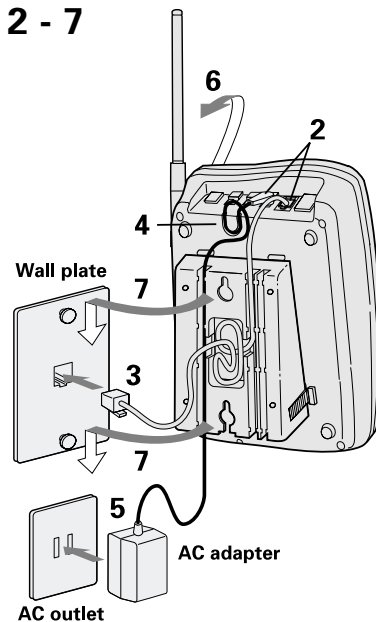
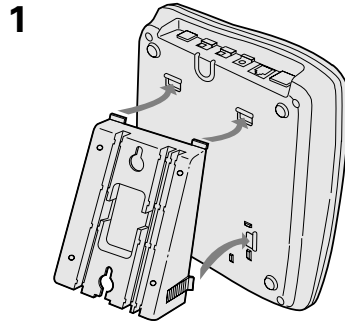

- 1 Snap the wall mount adapter into the notches on the base.
- 2 Plug the telephone line cord to the **TEL LINE** jack and the AC adapter to the **DC IN 9V** jack.
- 3 Plug the telephone line cord into the telephone outlet.
- 4 Wrap the AC adapter cord inside the molded wiring channel. Then wrap the cord around the strain relief notch.
- 5 Plug the AC adapter into a standard 120V AC wall outlet.
- 6 Raise the antenna to a vertical position.
- 7 Align the mounting slots on the base with the mounting posts on the wall. Push in and down until the phone is firmly seated.



If you have wall mounted the base, you must remove the beltclip to charge the handset facing forward.

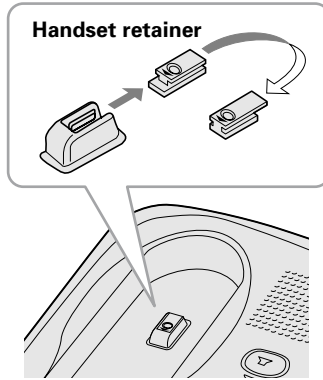

8 On the base unit, pull the handset retainer out of the slot. Rotate it clockwise 180 degrees.

9 Flip the retainer from front to back. Slide it back into the slot so that the lip of the retainer is up and ▼ is down. The retainer holds the handset in place.

Direct wall plate mounting

If you don't have a standard wall plate, you can mount your phone directly to the wall. Before doing this, consider the following:

- Avoid electrical cables, pipes, or other items behind the mounting location, that could cause a hazard when inserting screws into the wall.
- Try to mount your phone within 10 - 15 feet of a working phone jack to avoid excessive cord lengths.
- Make sure the wall material is capable of supporting the weight of the base and handset.
- Use #10 screws with (minimum length of 1-3/8 inches) anchoring devices suitable for the wall material where the base unit will be placed.

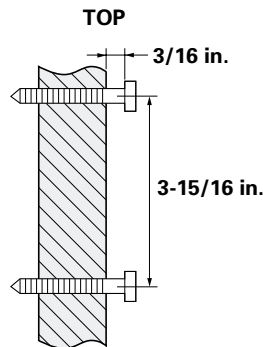

1 Insert two mounting screws into the wall, (with their appropriate anchoring device), 3-15/16 inches apart. Allow about 3/16 of an inch between the wall and screwheads for mounting the phone.

2 Refer to steps 1 through 9 on page 7 and 8 to mount the telephone.

Installing the handset battery pack

Charge the battery pack for more than 15-20 hours before you start using your phone.

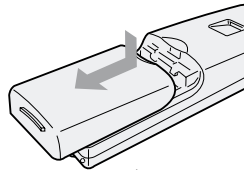

- 1** Press in on the battery cover release and slide the cover down until it comes off.

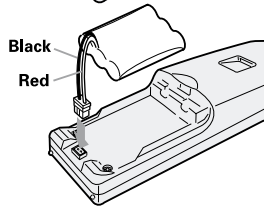

- 2** Connect the battery pack connector with the correct polarity (black and red wires), then insert the battery pack into the battery compartment.

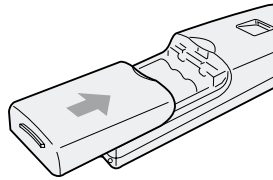

- 3** Slide the battery cover forward until it snaps into place.

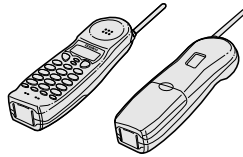

- 4** Place the handset on the base.

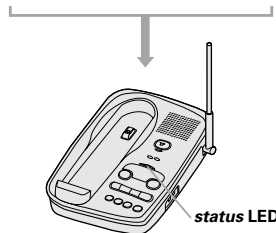

- 5** Make sure that the "status" LED lights. If the LED doesn't light, check to see that the AC adapter is plugged in and that the handset makes good contact with the base charging contacts.



Use only Uniden Battery (BT-905) supplied with your phone.

NOTE

Even when the battery pack is not being used, it will gradually discharge over a long period. For optimum performance, be sure to return the handset to the base unit after a telephone call for charging the battery.

Battery use time (per charge)

From fully charged

- 6 hours continuous use.
- 10 days when the handset is in the standby mode.

When the battery charge becomes low

When the voltage of battery pack in the handset is very low and needs to be charged, the phone is programmed to eliminate functions in order to save power. If the battery charge becomes low, "Low Battery" appears on the LCD. If the phone is in use, the handset beeps. Complete your conversation as quickly as possible and return the handset to the base unit for charging.

Cleaning the charging contacts

To maintain a good charge, it is important to clean the battery contacts on the handset and base unit with a dry cloth about once a month.

Do not use any liquids or solvents.

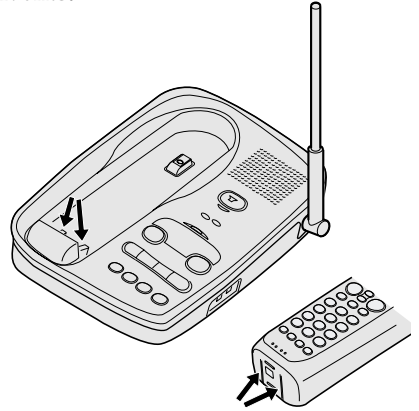

Making a call



Press **(del)** if you enter a wrong number at the step 1.



You must press a key within 20 seconds or the phone will return to standby.

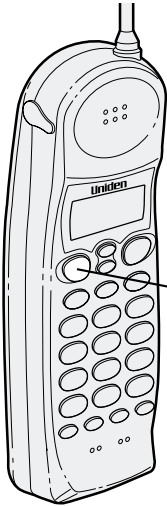

Dialing from Standby Mode

1 Enter the phone number. (Up to 32 digits.)

Example: Enter 8178583300



2 Press **(talk)**. "Talk" flashes on the display.

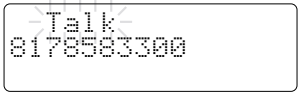

Then the volume setting is displayed. For example, if the volume is set to high, the display shows;



3 The number is dialed. After about 3 seconds, the call-time display appears.



4 To hang up, press **(talk)** or place the handset on the base. The call-time will be displayed for about 5 seconds.

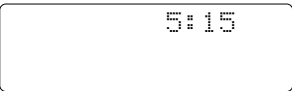

Other Operations

To	Do this
To adjust the earpiece volume	Press (▲) or (▼) .
To temporarily switch to tone dial (When the base is set to pulse mode)	Press (*/tone/◀) . The following numbers will be sent as tone dialing.
To enter a pause within dialing sequence	Press (redial/p) .
To improve reception	Press (select/ch) .



Dialing from Talk Mode

- 1 Press **talk**. "Talk" flashes on the display.



Then the volume setting is displayed. For example, if the volume is set to high, the display shows;



- 2 Dial the phone number.

Example: Enter 8178583300



- 3 To hang up, press **talk** or place the handset on the base. The call-time will be displayed for about 5 seconds.

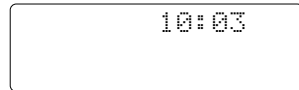

Receiving a call

From the handset

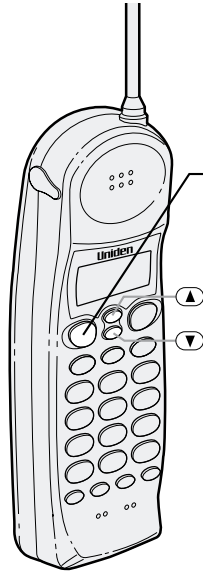

- 1** Phone rings.

Incoming Call

- 2** Press **(talk)**. “Talk” and volume setting appears on the display.

Talk 0:00
<Normal>

- 3** Talk with the caller.

Talk 0:02

- 4** To hang up, press **(talk)** or place the handset on the base. The call time will be displayed for about 5 seconds.

1:15:35

AutoTalk when ringing

When the AutoTalk setting is on and there is an incoming call, simply lift the handset from the base unit to answer the phone. See “Setting Caller ID options” on page 27 for more details.

Any key answer when ringing

When the AutoTalk setting is on, and the handset is off the base, press any handset key (except **(mute/ring)**) to answer the incoming call.

Call Waiting

Note: You must subscribe to Call Waiting service to use this feature.

When a call is received during a telephone call already in progress, press **(flash)** to switch to the new call.

If you also subscribe to Call Waiting on Caller ID, you will see the name and number of the caller in call waiting. (See page 34.)

From the base

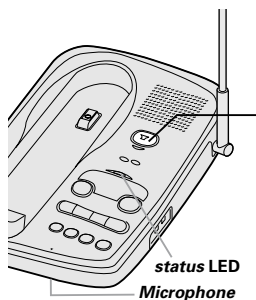

- 1** The phone rings. The **status** LED on the base flashes.
- 2** Press **speaker** and begin speaking.
- 3** To hang up, press **speaker**.

Adjusting the volume

Handset ringer tone and volume

Press **(mute/ring)** repeatedly in Standby Mode to select one of four types ringer tone and volume combinations.

Ringer on/off switch

This switch turns the handset ringer on or off.

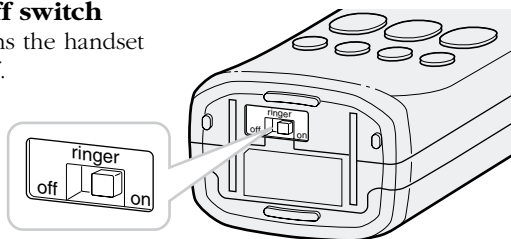

Earpiece volume

Pressing **(▲)** or **(▼)** will change the earpiece volume of the handset. This setting will remain in effect after the telephone call has ended.

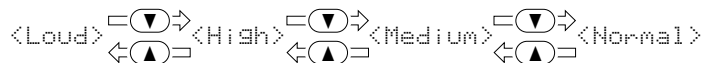

When you press **(▲)** in Loud mode or press **(▼)** in Normal mode, error sound beeps.

Base ringer switch

This switch turns the base ringer on or off.

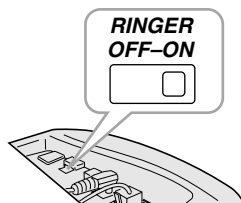

Base speaker volume

To control the speaker volume of the base, adjust the **(volume ▲)** and **(volume ▼)** button as desired.

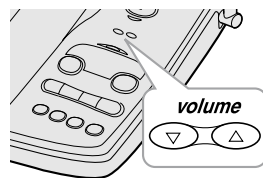

Redialing a call

The last three phone numbers dialed can be quickly redialed.

NOTE

If the number exceeds 32 digits, only the first 32 digits can be redialed.

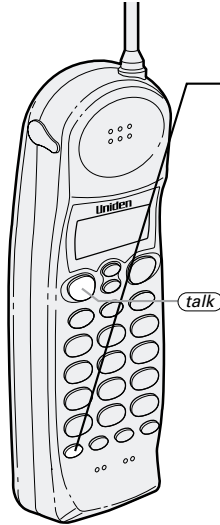

Redialing from Standby Mode

- 1 Press **redial/p**.
The phone number that was last dialed appears on the display.
- 2 Press **redial/p** again.
Each press of **redial/p** will display one of the last three numbers dialed.

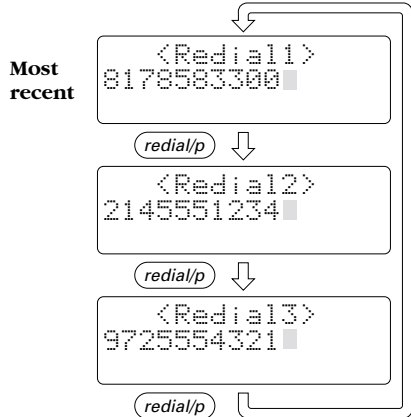

- 3 Press **talk**. "Talk" appears on the display, then the volume setting is displayed.
- 4 Then the selected number is dialed. After about 5 seconds, the call-time display appears.
- 5 To hang up, press **talk** or place the handset on the base. The call-time will be displayed for about 5 seconds.

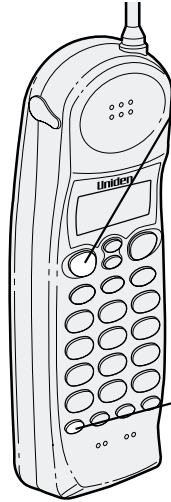

Redialing from Talk Mode

- 1** Press **(talk)**.
“Talk” appears on the display.

Talk



Talk
<High>

- 2** Press **(redial/p)**.
The last number dialed will be displayed.

- 3** To hang up, press **(talk)** or place the handset on the base. The call-time will be displayed for about 5 seconds.



Only the last number dialed can be accessed after **(talk)** has been pressed.

Traveling out-of-range

During a call, as you begin to move your handset too far from your base unit, noise increases. If you pass the range limits of the base unit, your call will terminate within 30 seconds.

Using the speakerphone

You may use the phone as speakerphone to answer calls by pressing the **(speaker)** button on the base. To hang up, press **(speaker)** again.

The base microphone is located under the phone. Position yourself as near to the base as possible and speak clearly.

Page

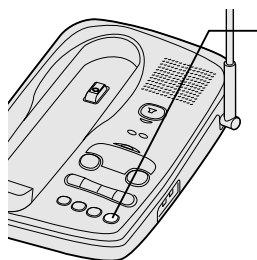

- 1 To locate the handset (while it's off the base), press **(page)** on the base. The handset beeps for 5 seconds.

NOTE

If you cancel the page by pressing **(talk)**, press **(talk)** again to return to standby.

NOTE

Press and hold **(page)** for more than 2 seconds to page the handset for a minute. Press any key or return the handset to the base to cancel the page.

If you hold down **(page)** for more than a minute, the handset beeps until you release **(page)**.

Mute

You can turn off the handset microphone so that the person whom you are talking with cannot hear you.



When speaking on the handset

- 1 Press **(mute/ring)** during a call. The microphone is turned off. "Mute" is displayed.
- 2 To resume a call, press **(mute/ring)** or **(talk)**.

When phone is ringing

Press **(mute/ring)** when the phone rings. The ringer sound is turned off. You may still press **(talk)** to answer the call.

NOTE

In memory dialing operation, you must press a key within 20 seconds or the phone will return to standby. If you return the handset to the base, the phone will return to standby also.

Storing phone numbers and names

Memory Dialing allows you to dial a number using just a few key strokes. You can store up to 20 phone numbers in the memory.

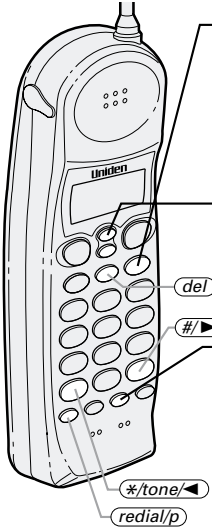

1 Press and hold **mem** until "Memory Store" is displayed.

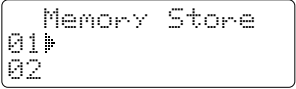

2 Press **▼** and **▲** or enter a two-digit number (01 - 20) to select the memory location where you would like to store the number.

3 Press **select/ch**. The following screen appears and a cursor flashes indicating that the display is ready for the name to be entered.

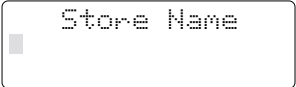

If this screen appears, the selected memory location is already stored. Then you must either change the entry in this location, clear the entry in this location, or select "Go Back" to choose another location.



- 4** Use the **▲**, **▼**, or **del** keys to enter the name. The name cannot exceed 13 characters.
- Use the **▲** and **▼** key to scroll through the character menu. It contains upper and lower case letters and various characters.
 - Use **#/▶** and *** /tone/◀** to move the cursor to the desired location.
 - Use **del** key to delete characters as needed.

MEMORY DIALING

- 5** Press **(select/ch)**.
“Store Number” is displayed. The cursor flashes indicating that the display is ready for the number to be entered.

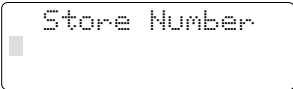

Store Number

- 6** Use the number keypad to enter the phone number. The phone number cannot exceed 20 digits.

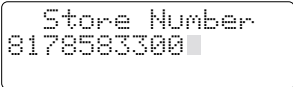

Store Number
0178583300

- Use the **(redial/p)** key to enter pause in the dialing sequence. The display shows a “P”.



The pause feature is useful for long distance calling, credit card dialing, or sequences that require a pause between digits.

- Use the **(del)** key to delete digits as needed.

- 7** Press **(select/ch)**.
The handset beeps and displays the confirmation screen. Memory storage is complete.

For example, if you store a name and number into memory location number 07, the display shows “Memory07 Stored”.

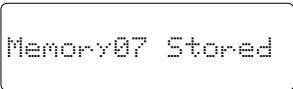

Memory07 Stored

After about 2 seconds, “Memory Store” is displayed.

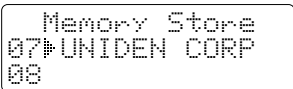

Memory Store
07 UNIDEN CORP
08

- 8** Press **(mem)** to return to standby mode.

Making calls with memory dialing

Memory dialing from Standby Mode



- 1 Press **mem**.
The handset displays your programmed memory locations.
- 2 Press **▼** and **▲** or enter a two-digit number (01 - 20) to select the memory location you would like to dial.
- 3 Press **talk**. "Talk" and the volume setting appears on the display. Then the displayed number is dialed.

```
01 UNIDEN CORP
02 JOHN DOE
03▶MOM AND DAD
```

```
→Talk←
0123456789012
```

NOTE

If you press **select** before **talk**, you can confirm the name and number stored in the selected memory location.

NOTE

To exit the memory function without dialing, press **mem**. The handset returns to standby.

Display a Programmed Number

Use the **#/▶** and ***/tone/◀** keys to toggle between the names display and the numbers display.

Program name		Program number
01 UNIDEN CORP	↔▶↔	01 8178583300
02 JOHN DOE		02 5452930
03▶MOM AND DAD	◀◀↔	03▶8175551212

NOTE

When the stored phone number has 14 or more digits, "▶" is displayed next to the 12th digit. Press **#/▶** to see the extra digits and ***/tone/◀** to return.

```
05 012345678901
06▶011813554329+
07
```

Memory dialing from Talk Mode

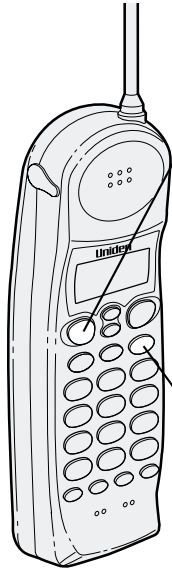

- 1** Press **(talk)**.
“Talk” and the volume setting
appears.

```
Talk
```



```
Talk  
<High>
```

- 2** Press **(mem)**.

```
Talk  0:00
```

- 3** Enter a two-digit number (01 - 20) to
select the memory location of the
desired phone number.
The selected phone number is
displayed. Then the number is dialed.

```
Talk  0:35  
0123456789012
```

Chain dialing

On certain occasions after dialing a number, you may be requested to enter an access code or other information, such as your account number. You can enter this number into a memory location for later use by doing the following.

- 1) Store the access code into one of the memory locations (01-20) following the steps on page 19.
- 2) Dial the party or service main number.
- 3) When you need to enter the special number, press **(mem)** followed by the memory location (01-20).

Editing a stored name and/or phone number

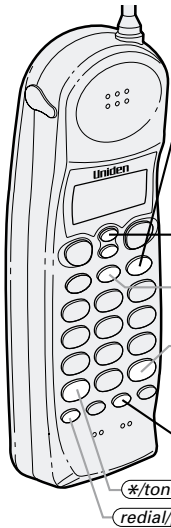

1 Press and hold **mem** until "Memory store" is displayed.

```

Memory Store
01 UNIDEN CORP
02 JOHN DOE
    
```

2 Press **▼** and **▲** or enter a two-digit number (01 - 20) to select the memory location you would like to edit.

```

Memory Store
01 UNIDEN CORP
02 JOHN DOE
    
```

3 Press **select/ch**. The following screen appears with the memory location number that you have selected in the display.

```

▶ Edit Memory01
Delete Memory01
Go Back
    
```

4 Press the **▲** or **▼** key to select "Edit Memory", then press **select/ch**. The following screen appears.

```

Store Name
UNIDEN CORP █
    
```

The cursor flashes indicating that the display is ready for the name to be edited. When a name has not been stored, the cursor appears at the beginning of the second line.

5 Press **▲**, **▼**, **#/▶**, ***/tone/◀**, or **del** to edit the name. (See page 19.) To edit only the phone number, skip this step.

6 Press **select/ch**. The following screen appears. The cursor flashes indicating that the display is ready for the number to be edited.

```

Store Number
817858330 █
    
```

- 7** Use the dial keypad, **(redial/p)** or **(del)** key to edit the phone number.
The phone number cannot exceed 20 digits. (See page 20.)
If you don't want to change the phone number, skip this step.

- 8** Press **(select/ch)**.
The handset beeps and displays the confirmation screen. The memory storage is complete.

```
Memory01 Stored
```

For example, if you store a name and number into memory location number 01, the display shows "Memory01 Stored".

After about 2 seconds, "Memory Store" is displayed.

```
Memory Store
01 UNIDEN CORP
02 JOHN DOE
```

- 9** Press **(mem)** to return to standby mode.

Display a Programmed Number

Use the **(#/▶)** and **(*/tone/◀)** key to toggle between the names display and the numbers display.

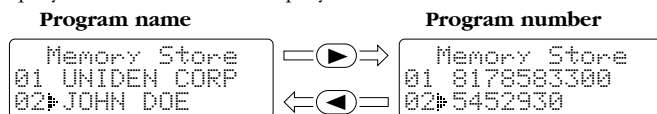

- When the stored phone number has 14 or more digits, "➡" is displayed next to the 12th digit.
Press **(#/▶)** to see the extra digits and **(*/tone/◀)** to return.

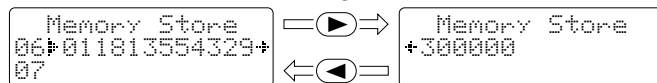

Erasing a stored name and phone number

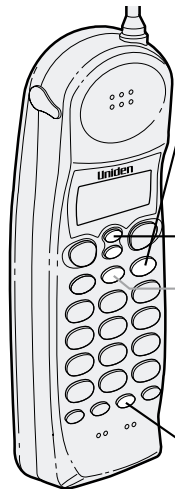

1 Press and hold **(mem)** until "Memory store" is displayed.

```

Memory Store
01▶UNIDEN CORP
02 JOHN DOE
    
```

2 Press **(▼)** and **(▲)** keys or enter a two-digit number (01 - 20) to select the memory location you would like to edit.

```

Memory Store
01 UNIDEN CORP
02▶JOHN DOE
    
```

3 Press **(select/ch)**. The following screen appears with the memory location number that you have selected in the display.

```

▶Edit Memory02
Delete Memory02
Go Back
    
```

4 Press **(▼)** to move the cursor down to "Delete Memory" command line.

```

Edit Memory02
▶Delete Memory02
Go Back
    
```

5 Press **(select/ch)**. The following confirmation screen appears.

```

Delete Memory02?
Yes
▶No
    
```

6 Press **(▲)** to move the cursor to "Yes".

7 Press **(select/ch)** or **(del)**. There is a confirmation tone and the entry is deleted. The following screen appears.

```

Memory02 Deleted
    
```

8 After a few seconds the display returns to the "Memory Store" screen. You may select another number to delete (return to step 2) or press **(mem)** to return to standby.

```

Memory Store
02▶
03 MOM AND DAD
    
```

3-way conferencing

The Uniden EXS 2080 permits 3-way conversations between the handset, base and outside line.

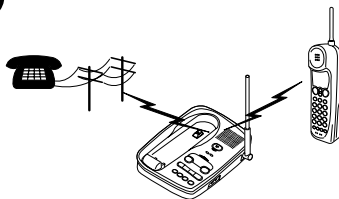

When speaking on the handset

NOTE

If you pick up the handset from the base while speaking on the base, the call will be transferred to the handset.

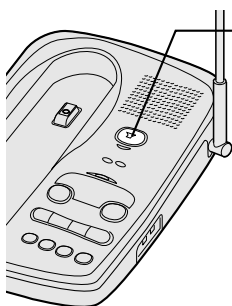

- 1 Press **speaker** on the base to join the 3-way conversation.
- 2 To hang up, press **speaker** on the base. The handset will still be connected to the call.

When speaking on the base

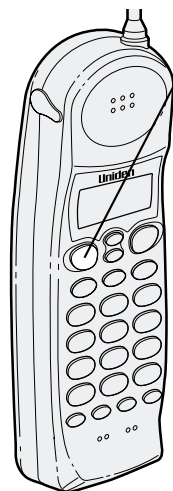

- 1 Press **talk** on the handset to join the 3-way conversation.
- 2 To hang up, return the handset to the base, or press **talk** on the handset. The base will still be connected to the call.



You must subscribe to Caller ID on Call Waiting in order to use this feature.

Caller ID

You must subscribe to the Caller ID service to use this feature.

When the telephone rings, the Caller ID feature allows you to view the caller's name and phone number on the display before you answer the phone.

The handset displays the phone number of the incoming call, the name, time, and the number of calls. Additionally, you can dial the displayed number, and store the information for memory dialing.

Setting Caller ID options

There are three Caller ID setup options available; they are AutoTalk, CIDCW (Caller ID on Call Waiting), and Area Code.

AutoTalk allows you to answer the phone without pressing the **(talk)** button. If the phone rings when AutoTalk is on, simply remove the handset from the base and the phone automatically answers the call. Or if the handset is not on the base press any key (except **(mute/ring)**) to answer the call. If the phone rings when AutoTalk is off, you must press **(talk)** to answer the call.

Caller ID on Call Waiting (CIDCW) performs the same as regular Caller ID on a call waiting number.

You must subscribe to CIDCW from your phone company in order to use this feature.

If you enter 3-digit area code number in the **Area Code** option, your local area code does not appear in Caller ID messages. When reviewing Caller ID messages, you will see only the local seven digit number. For calls received from outside your local area code, you will see a full 10-digit number.



If your calling area requires 10-digit dialing, do not program this option.

To change your Caller ID options:

- 1** Press down **(set up)**.
The following screen appears.
- 2** Use the **(▲)** and **(▼)** keys or a number key(1-3) to move the cursor to the selection that you would like to change. Press the **(select/ch)** key to toggle between On and Off for Auto Talk and CIDCW.
- 3** When you wish to enter Area Code, press **(▼)** or the number key **(3)** to move the cursor to select Area Code. Then press **(select/ch)** and enter the 3 digits area code by using the number keypad **(0)** - **(9)**. After entering Area Code, press **(select/ch)**.
- 4** After you have made your selections, press **(set up)** and return the handset to the base.

```

1▶Auto Talk:Off
2 CIDCW      :On
3 Area Code:
  
```

When the telephone rings

NOTE

If you answer a call before the Caller ID message is received (Example: before the second ring), the Caller ID message will not appear.

NOTE

When the call is received via a telephone company that does not offer Caller ID service, the caller's phone number and name do not appear. (This includes international calls.)

NOTE

When the call is via a private branch exchange (PBX), the caller's phone number and name may not appear.

- When the Caller ID message is received, the display shows the caller's phone number, along with the date and time. The incoming call information is stored in Caller ID record. If the Caller ID service includes the caller's name, the caller's name appears on the display (up to 15 letters).

Number of calls from the same number

The date and time received — 5/11 12:30PM 01
 Caller's name — UNIDEN CORP
 Caller's phone number — 817-858-3300

Here are some typical displays;

When the phone number and name data are received

```
5/11 12:30PM 01
UNIDEN CORP
817-858-3300
```

When invalid data is received

```
Incomplete Data
```

When a private name is received

```
5/11 12:30PM 01
Private Name
817-858-3300
```

When a private number is received

```
5/11 12:30PM 01
UNIDEN CORP
Private Number
```

When an unknown name is received

```
5/11 12:30PM 01
Unknown Name
817-858-3300
```

When an unknown number is received

```
5/11 12:30PM 01
UNIDEN CORP
Unknown Number
```

- When you pick up the phone, the display changes to "Talk". (See page 13.)

NOTE

Data errors appear as "■ ■".

```
5/11 12:30PM 01
UNIDEN CORP
813-8■■-3300
```



NOTE

In Caller ID operation, if no key is pressed for more than 20 seconds, an error tone sounds and the telephone returns to the standby mode.

NOTE

If a call comes in via a telephone system that does not offer Caller ID service, no information is stored.

NOTE

“End” appears when you have reviewed all messages in the Caller ID list. Press  repeatedly to return to the summary screen.

NOTE

Each message can be up to 15 characters for the phone number and the name.

Viewing the Caller ID Message list

The Caller ID list stores information for up to 50 incoming calls even unanswered calls.

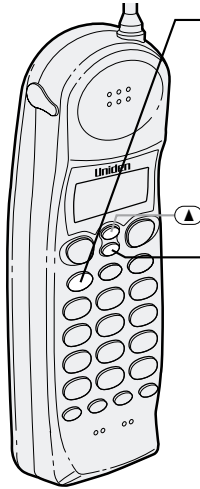



- 1 Press  .
The summary screen appears.
The screen shows the number of new messages and total messages.

```
New :01  
Total:02
```

- 2 Press  to display the latest caller ID message.

```
5/17 12:30PM 03  
UNIDEN CORP  
817-858-3300
```

- 3 Press  to see the next message.
Or press  to see previous message.
- 4 Press  to return to standby.

Deleting information from the Caller ID list

The EXS 2080 stores up to 50 messages. If the phone receives the 51st message, the oldest one in the list is automatically deleted. Caller ID data can also be deleted manually.

Deleting a Caller ID message

NOTE

If you get an incoming call, the deleting operation is cancelled. The telephone returns to standby so you can answer the call.

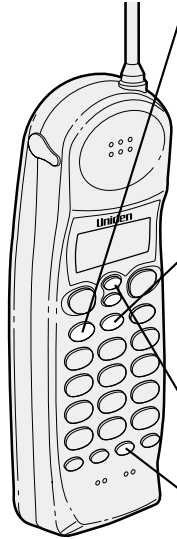

- 1** Press **(call id)**.
Display the message to be deleted from the Caller ID list by pressing **(▼)** or **(▲)**.

```
5/17 12:30PM 03
UNIDEN CORP
817-858-3300
```

- 2** Press **(del)**.

```
Delete Message?
▶Yes
No
```

- 3** Press **(▼)** or **(▲)** to select "Yes" or "No".

- 4** Press **(select/ch)** or **(del)**.

When the pointer is at "Yes":

A tone sounds and the Caller ID message is deleted. The next Caller ID message is displayed.

When the pointer is at "No":

The display returns to the Caller ID message.

Deleting all Caller ID name/numbers

NOTE

If you get an incoming call, the deleting operation is cancelled.

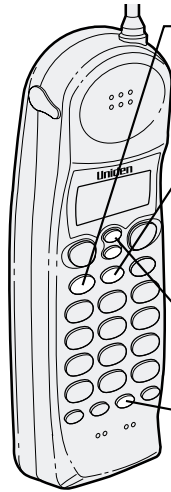

1 Press **(call id)**.

```
New :01
Total:02
```

2 Press **(del)**.

```
Delete All?
Yes
▶No
```

3 Press **(▲)** or **(▼)** to select "Yes" or "No".

4 Press **(select/ch)** or **(del)**.

When the pointer is at "Yes":

A tone sounds and all stored Caller ID messages are deleted.

```
Total:00
```

When the pointer is at "No":

The display returns to the summary screen.

```
New :01
Total:02
```

Using the Caller ID list

Calling a party from the Caller ID list

You can place a call from the Caller ID list.
The EXS 2080 stores up to 50 messages.

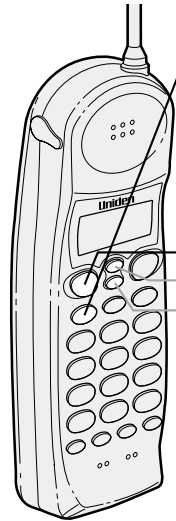

- 1 Press **(call id)**.
Select the phone number that you want to dial by pressing **(▲)** or **(▼)**.

```
5/17 12:30PM 03  
UNIDEN CORP  
817-858-3300
```

- 2 Press **(talk)**.

```
Talk  
8178583300
```

The displayed phone number dials automatically.

NOTE

You cannot make a call from the Caller ID list if your EXS 2080 is connected to private branch exchange (PBX).

NOTE

When a long distance call has been set, "1" appears in the display.

Long Distance calls and Area Code Setting/Cancellation

Pressing **(1)** while the incoming call information is displayed (in step 1) will set or cancel a long distance call. Pressing **(3)** will set or cancel an area code setting.

Dial edit

You can edit the phone number of Caller ID data when you press **(select/ch)** after the step 1.

Storing Caller ID messages in Memory dialing

Messages shown in the Caller ID list can be stored in memory dialing.

Using the incoming call information (i.e., Caller ID list), the phone number of the party on the Caller ID list can be stored in memory dialing.

NOTE

You can not store a Caller ID message, if no phone number appears in the message.

NOTE

If there is an incoming call or page, memory storage is cancelled and the telephone is set to receive the incoming call or page.

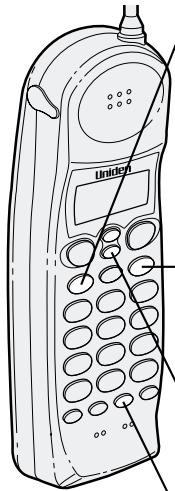

1 Press **(call id)**.

Select the phone number to be stored from the Caller ID list by pressing **(▲)** or **(▼)**.

```
5/17 12:30PM 03
UNIDEN CORP
817-858-3300
```

2 Press **(mem)**.

```
Select Location
01▶UNIDEN CORP
02 JONE DOE
```

3 Press **(▼)** and **(▲)** or enter a two-digit number (01 - 20) to select the memory location to be stored.

4 Press **(select/ch)**.

A tone will sound. The number is stored in memory, and the display returns to the Caller ID list.

```
5/17 12:30PM 03
UNIDEN CORP
817-858-3300
```

NOTE

If a message has already been stored in the selected memory numbers location, a confirmation screen is displayed. Press **(▲)** to select "Yes". Press **(select/ch)** to overwrite. The display returns to the Caller ID list.

```
Replace Memory?
Yes
▶No
```

Using "Caller ID on call waiting" service

"Caller ID" and "Call waiting" are separate services. CIDCW (Caller ID on Call Waiting) performs the same as regular Caller ID on a call waiting number. You must subscribe to the "Caller ID on call waiting (CIDCW) services" before you can use the following features. The "Call waiting" service can also be used independently. Please contact your local telephone company for details.



- 1 When a new incoming call arrives during your current telephone call, the phone number and the name of the caller is displayed.

```
Talk 10:30  
UNIDEN CORP  
817-858-3300
```

- 2 Press **flash**.
You will be able to talk with the second caller. The first caller will be put on hold.
- 3 To return to the first caller, press **flash** again.

The integrated answering device

The EXS 2080 has a built-in answering system that answers and records incoming calls.

You can also use your answering system to record a conversation, leave a voice memo message for others who use the phone, or to announce a special message to callers when you're away from your phone.

Features

- Digital Tapeless Recording
- 15 minutes of Recording Time
- Selective Greetings (Outgoing Messages)
- Time and Day Stamp
- Remote Message Retrieval and Room Monitor
- Toll Saver
- Conversation Recording

Digital Tapeless Recording allows you to quickly review, save or delete the messages. You'll never have to worry about a tape wearing out, jamming, or resetting improperly.

The Integrated Answering System is easy and convenient to use, but please read through all of the instructions carefully.

Setting up your answering system

Turning the answering system on/off

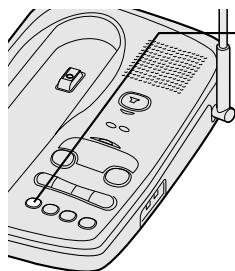

- 1 To turn the answering system on, press **(answer on/off)**. The current greeting message will be played and a tone will sound.
- 2 To turn the answering system off, press **(answer on/off)** again.



When the answering system is full, **FL** displays on the base and the system announces “No remaining time”. You should delete some messages so that the system can record new messages.

Setting the clock

The clock on EXS 2080 Answering System starts when power is applied to the base. Follow these steps to set the clock to the correct time.

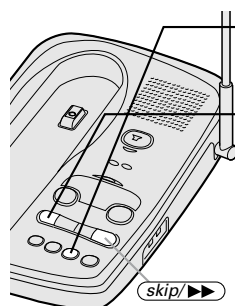

- 1 Press and hold **(clock)** until a tone sounds.
- 2 First, press **(skip ▶▶)** or **(repeat ◀◀)** repeatedly until the correct day of the week is announced. (Number **1** through **5** displays on the base as each day is announced.) Press **(clock)** again to select the day.
- 3 Next, press **(skip ▶▶)** or **(repeat ◀◀)** repeatedly until you hear the correct hour setting. Numbers **1** through **12** display on the base as each hour is announced. Press **(clock)** again to select the correct time.

NOTE

Press **(skip ▶▶)** or **(repeat ◀◀)** multiple times to scroll through days, hours, minutes, etc.

NOTE

If you don't set the clock within two minutes, the system returns to standby.

- 4** Press **skip ►►** or **repeat ◀◀** repeatedly until you hear the correct time setting. Numbers 0 through 59 display on the base as each minute is announced. Press **clock** again to select the correct time.
- 5** The LED displays *A* or *P*. Press **skip ►►** or **repeat ◀◀** until you hear the correct AM/PM setting.
- 6** Press **clock** again to end the time/day setting. The EXS 2080 announces the time that you have set.

Setting your greeting

When you receive a call, the answering system automatically plays either a preset message or your own greeting.

▼ Preset Message

The following message is prerecorded:

“Hello, no one is available to take your call. Please leave a message after the tone.”

▼ Recording a personal outgoing message (Greeting)

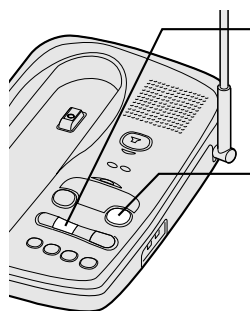

1 Press and hold **greeting** until you hear a tone. Start recording your message immediately after you hear the tone end.

2 When you finish recording your message, press **greeting** or **play/stop**. A tone sounds and your message plays back on the phone.

NOTE

You can record a greeting up to 30 second.

NOTE

Position yourself as near to the base as possible and speak clearly when recording your outgoing message.

▼ Choosing between the two outgoing messages

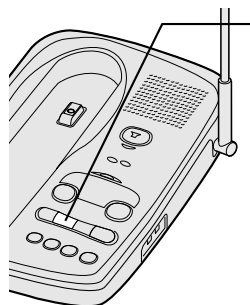

1 Press **greeting** to play the outgoing message.

2 Press **greeting** again while the message is played. This switches between the two options.

Selecting the message record time

You can set your answering system to record messages up to one or four minutes long.

One minute option:
move the **REC TIME** switch to **1**.

Four minutes option:
move the **REC TIME** switch to **4**.

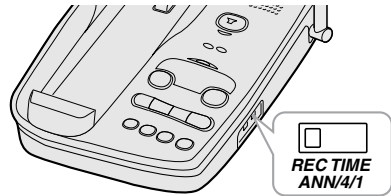

▼ Announce only feature:

The announce only feature plays an outgoing message, but it will not allow the caller to leave a message. Move the **REC TIME** switch to the **ANN** position.

The message counter LED displays “**8**” when system is on standby.

Prerecorded outgoing message for Announce only feature is: “Hello, no one is available to take your call.” (twice)

Selecting a PIN code

To play your messages from a remote location, you will need to enter a two-digit Personal Identification Number (PIN) code (00-99). To select a PIN, perform the following steps.

NOTE

Holding **(skip ►►)** or **(repeat ◀◀)** to scroll through numbers on the display.

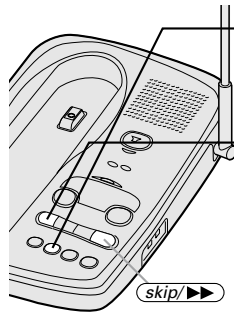

- 1** On the base, press and hold **(pin)** until a beep sounds and the LED displays **00**.
- 2** To set the first number, press **(skip ►►)** or **(repeat ◀◀)** repeatedly to scroll from 0 to 9. When the desired number appears in the display, press **(pin)**.
- 3** To set the second number, press **(skip ►►)** or **(repeat ◀◀)** to scroll from 0 to 9. When the desired number appears in the display, press **(pin)**. Then the entered PIN code is announced.

Setting ring time switch

The ring time/toll saver switch allows you to set the number of rings the caller hears before the answering system plays your outgoing message. You can set the switch to answer after two rings or after four rings.

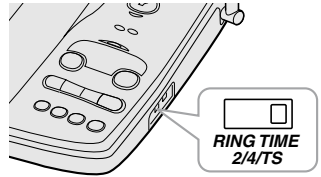

Once the greeting has started, you can stop it when you pick up the call at the handset or base.

In the **TS** (Toll Saver) position, the answering system picks up after two rings if you have new messages, and after four rings if there is none. This way, if you call long distance to check your messages, you can hang up after the third ring to avoid billing charges.



If you answer at another phone extension and the greeting has started, you cannot stop the message. Wait until your greeting is complete before starting your conversation.

Using your answering system

NOTE

To stop playing your messages, press **(play/stop)** again.

Playing your messages

The base LED shows the number of total messages on the display. If the display is blinking, then there are new messages waiting for you. The EXS 2080 is designed to play your new messages first. After you play your new messages you can then play your old messages.

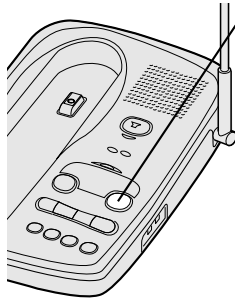

- 1** Press **(play/stop)**. The system announces the number of new and old messages, then the incoming messages are played. The time and day each message was received is announced after the message is played.
- 2** When all new messages have played, a tone is heard. The message counter LED stops flashing to indicate that all of the new messages have been reviewed.
- 3** After you have reviewed all your messages, you can play your old messages again. Press **(play/stop)** and follow the instructions above.

NOTE

Pressing **repeat** (◀◀) before 2 seconds (4 seconds from remote) of the message has played causes the system to scan back one message.

NOTE

If you have several messages, press and hold **repeat** (◀◀) until you return to the message you want to replay.

NOTE

Each time **skip** (▶▶) is pressed, the system scans forward one message.

NOTE

If you have several messages, press and hold **skip** (▶▶) to find the message you want to play.

Repeating a message

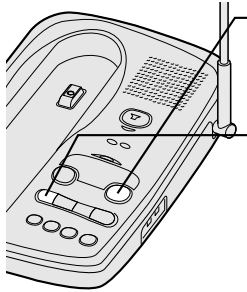

- 1 Press **play/stop** to review your message. The number of stored messages is announced.
- 2 After a message has played for a few seconds, press **repeat** (◀◀) to repeat the message.
- 3 Press **play/stop** at any time to stop reviewing messages and return to standby. The message counter LED shows the total number of messages still on the system.

Skipping a message

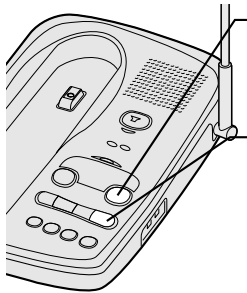

- 1 Press **play/stop** to review your messages. The number of messages is announced.
- 2 Press **skip** (▶▶) at anytime to skip to the next message.
- 3 Press **play/stop** at any time to stop reviewing your messages and return to standby. The message counter LED shows the total number of messages on the system.

NOTE

When you press **(delete)**, you are permanently deleting the message. The message cannot be replayed.

NOTE

The voice memo function is completely independent of the outgoing message. It's handy for leaving others a quick message.

NOTE

A voice memo message will be stored as a typical recorded message.

NOTE

Position yourself as near to the base as possible and speak clearly.

Deleting a message

▼ Deleting individual message

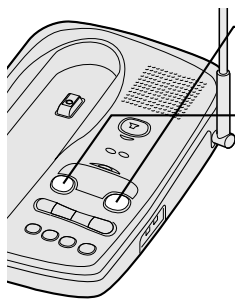

- 1 Press **(play/stop)** to review your message.
- 2 If you decide to delete a message, press **(delete)** anytime during the message. The system beeps and immediately goes to the next message.

▼ Deleting all messages

Press and hold **(delete)** while the system is in standby. A tone sounds when all messages are deleted. If there are any messages you have not reviewed, you can not delete all messages at once.

Voice memo

The voice memo function allows the user to record a message (up to 10 minutes) on the base.

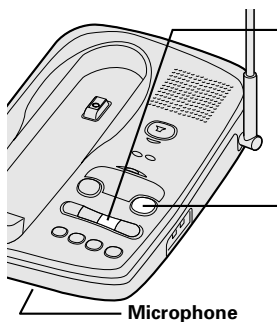

- 1 Press and hold **(voice memo)** until you hear a tone. The message counter LED blinks.
- 2 Speak into the microphone.
- 3 When you have finished, press **(voice memo)** or **(play/stop)** to stop recording. The system returns to standby.
- 4 To play voice memo, press **(play/stop)**.

Recording a conversation

You can record up to 10 minutes of conversation while you are making your call from the handset.

NOTE

A recorded conversation is stored and played back with typical recorded messages.

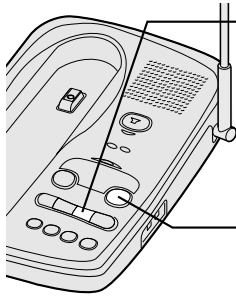

- 1 During the conversation from the handset, press and hold **voice memo** on the base. The unit begins recording and the LED blinks. Both parties can hear tones every 15 seconds.
- 2 To stop the recording, press **voice memo** or **play/stop**.

NOTE

You cannot record a conversation while you are speaking on the base.



NOTE

During the remote operation, *r* displays on the base.



NOTE

You must enter a command within 15 seconds of entering command waiting mode or the answering system automatically hangs up and returns to standby.



NOTE

The system will only playback messages for four minutes and then it returns to command waiting mode. To continue playing your message, press **#** then **2** again within 15 seconds

Remote access away from home

You can operate your answering system from a remote location using any touch-tone telephone. Use this function to check for recorded messages, to play or delete messages, even to record a new outgoing message, and to monitor sounds in the room.

- 1** Call your telephone number.
- 2** While the greeting message is played, press **#** and your PIN code.

If the answering system is off, let it ring 10 times until the greeting message is played. Then, press **#** and your PIN code.

- 3** The answering system announces the time and day stamp and the number of messages stored in memory. Then the message playback automatically begins.
- 4** You may continue to listen to your message, or you may select a command from the following chart.

Command	Function
# then 1	Repeat a message
# then 2	Playing your messages
# then 3	Skipping a message
# then 4	Deleting a message
# then 5	Stop message playback
# then 6	Answering system on
# then 7	Voice memo record/stop (up to 4 minutes recording time)
# then 8	Greeting message record/stop
# then 9	Answer system off
# then *	Room monitor

- 5** After all of your messages have played, or the playback time exceeds 4 minutes, you will hear that the intermittent beeps indicating that the system is in the command waiting mode. You may enter another command at this time from the chart above.
- 6** When you finish, hang up to exit the system. The answering system automatically returns to standby.

Remote room monitor

You can call your answering system from any touch-tone phone and monitor sounds in the room where your base is installed.

- 1** Call your telephone number.
- 2** While the greeting message is played, press **#** and your PIN code.
- 3** The answering system begins announcing the time and day.
- 4** Press **#** then 5 to stop the messages.
- 5** Press **#** then *****. You hear sounds in the room where your phone is installed. After 15 seconds, the answering system returns to the command waiting mode.
- 6** Press **#** then ***** to monitor the room for another 15 seconds. Or select another remote function. Or hang up to exit the system. The answering system automatically returns to standby.

Changing the digital security code

NOTE

If the handset battery pack is completely discharged or the battery pack is removed, the digital security code will be lost. If this happens, a new security code is set automatically next time the battery pack is charged.

The digital security code is an identification code used to connect the handset and the base unit. Normally, setting the code is not necessary.

The first time you charge your handset, the security code is automatically set. (See page 2.)

In the rare situation that you suspect another cordless telephone is using the same security code, you can change the code.

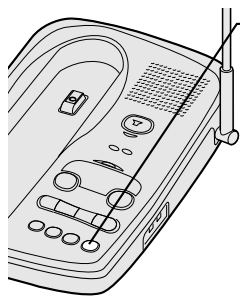

- 1** Remove the handset from the base unit. Press **page** .
- 2** While the handset is emitting the paging sound, press and hold **page** and replace the handset on the base unit. The paging tone stops. Leave the handset on the base longer than 3 seconds. A random, new security code is set.

ADDITIONAL
INFORMATION

NOTE

If you have wall mounted the base, you must remove the beltclip to charge the handset facing forward.

Installing the beltclip

To attach the beltclip

Insert the beltclip into the holes on each side of the handset. Press down until it clicks.

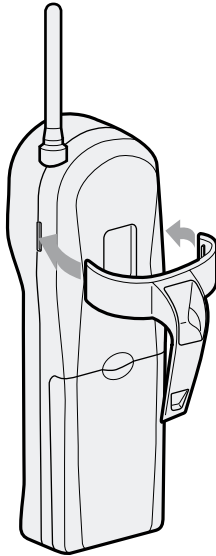

To remove the beltclip

Pull both sides of the beltclip to release the tabs from the holes.

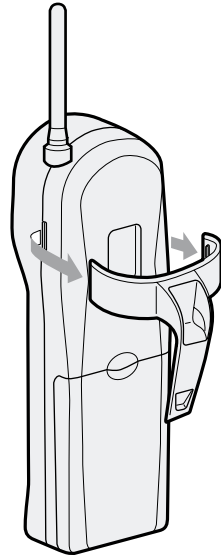

Headset installation

Your phone may be used with an optional headset, the Uniden HS910. To use this feature, insert headset plug into the headset jack. Your phone is ready for hands-free conversations.

headset
jack

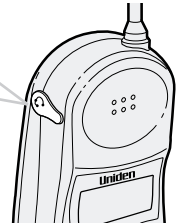

Note on power sources

Battery replacement and handling

When the operating time becomes short, even after a battery is recharged, please replace the battery.

With normal usage, your battery should last about one year.

Please contact your place of purchase for a replacement battery.

Power Failure

During the period that the power is off, you will not be able to make or receive calls with the telephone.

Caution

- Use the specified battery pack.
- Do not remove the battery from the handset to charge it.
- Never throw the battery into a fire, disassemble it, or heat it.
- Do not remove or damage the battery casing.

Maintenance

When slightly dirty

Wipe with a soft, dry cloth.

When very dirty

Wipe with a soft cloth that has been dampened with diluted, neutral detergent. Dry with a dry cloth.

When the charging terminals become dirty

Wipe with a dry cloth.

RECYCLING NICKEL-CADMIUM BATTERIES



Ni-Cd

NICKEL-CADMIUM BATTERIES MUST BE DISPOSED OF PROPERLY.

Nickel-cadmium cells are used in the battery pack. Please take your used nickel-cadmium battery packs to a store that recycles nickel-cadmium batteries.

Caution

Do not use paint thinner, benzene, alcohol, or other chemical products. Doing so may discolor the surface of the telephone and damage the finish.

Troubleshooting

If your phone is not performing to your expectations, please try these simple steps first.

Symptom	Suggestion
The status LED won't come on when the handset is placed in the base unit.	<ul style="list-style-type: none"> • Make sure the AC adapter is plugged into the base unit and wall outlet. • Make sure the handset is properly seated in the base unit. • Make sure the charging contacts on the handset and base unit are clean.
The audio sounds weak and/or scratchy.	<ul style="list-style-type: none"> • Press (select/ch) to help eliminate background noise. • Make sure that the base unit antenna is in a vertical position. • Move the handset and or base unit to a different location away from metal objects or appliances and try again. • Make sure that you are not too far from the base.
Can't make or receive calls.	<ul style="list-style-type: none"> • Check both ends of the base unit telephone line cord. • Make sure the AC adapter is plugged into the base unit and wall outlet. • Disconnect the AC adapter for a few minutes, then reconnect it. • Reset the digital security code (See page 47). • Make sure (talk) is pressed.
The handset doesn't ring or receive a page.	<ul style="list-style-type: none"> • The battery pack may be weak. Charge the battery on the base unit for more than 15-20 hours. • The handset may be too far away from the base unit. • Place the base unit away from appliances or metal objects. • Reset the digital security code (See page 47). • Make sure the ringer switch is on (See page 15).

Symptom	Suggestion
The Caller ID/CIDCW does not display.	<ul style="list-style-type: none"> • The handset was picked up before the second ring. • The call was placed through a switch board. • Call your local telephone company to verify your Caller ID service is current. • Make sure that the CIDCW option is set to ON.
The answering system does not work.	<ul style="list-style-type: none"> • Make sure the base unit is plugged in. • Make sure that the answering system is turned on. • Make sure that the message record time is not set to ANN (See page 39).
Messages are incomplete.	<ul style="list-style-type: none"> • The incoming messages may be too long. Remind callers to leave a brief message. • The memory may be full. Delete some or all of the saved messages.
After a power failure, the outgoing message is deleted.	<ul style="list-style-type: none"> • Record your greeting again. The preset messages should remain.
No sounds on the base unit speaker during call monitoring or message playback.	<ul style="list-style-type: none"> • Adjust the speaker volume on the base unit.
Cannot access remote call-in features from another touch-tone phone.	<ul style="list-style-type: none"> • Make sure you are using the correct PIN number. • Make sure that the touch-tone phone you're using can transmit the tone for at least two seconds. If it cannot, you may have to use another phone to access your message.

At Uniden, we'll take care of you!

If you need any assistance with this product, please call our Customer Hotline at

1-800-297-1023

PLEASE DO NOT RETURN THIS PRODUCT TO THE PLACE OF PURCHASE.

Our Uniden representatives will be happy to help you with any matters regarding the operation of this unit, available accessories, or any other related matters.

Thank you for purchasing a Uniden product.

Hours: M-F 7:00 AM to 7:00 PM CST.

Index

0 - 9

3-way conferencing.....26

A

Adjusting the volume.....15

Answering device

Features.....35

Setting up.....36

Using.....41

B

Base ringer switch.....15

Battery pack

Preparing and charging...9

Replacement and

handling.....49

C

Caller ID

Caller ID service.....27

Call Waiting.....34

Deleting.....30

Using.....32

Viewing.....29

Connection.....5

D

Dialing mode.....6

Digital security code.....2, 47

E, F, G

Earpiece volume.....15

H

Headset installation.....48

I, J, K, L

Installing the beltclip.....48

M, N, O

Maintenance.....49

Making a call.....11

Memory dialing

Erasing a stored name
and phone number.....25

Making calls

with memory dialing.....21

Mounting the base unit

on a wall.....7

Mute.....18

Storing phone

numbers and names.....19

P, Q

Package contents.....3

R

Receiving a call.....13

Redialing a call.....16

Ringer volume.....15

S

Setting up your

answering system

Selecting a PIN code.....39

Selecting the

message record time.....39

Setting ring time

switch.....40

Setting the clock.....36

Setting your greeting.....38

Turning the answering

system on/off.....36

Setting up the Base unit.....4

Setting up the Handset.....9

T

Troubleshooting.....50

U, V, W, X, Y, Z

Using your answering system

Deleting a message.....43

Playing your message...41

Recording a

conversation.....44

Remote access

away from home.....45

Remote room monitor...46

Repeating a message.....42

Skipping a message.....42

Voice memo.....43

THANK YOU

FOR PURCHASING A UNIDEN PHONE!

Uniden®

Covered under one or more of the following U.S. patents:

4,511,761 4,523,058 4,595,795 4,797,916 5,381,460
5,426,690 5,434,905 5,491,745 5,533,010 5,574,727
5,650,790 5,660,269 5,661,780 5,663,981 5,671,248
5,717,321 5,754,407 5,768,345 5,787,356 5,838,721

© 2000 Uniden America Corporation

All rights reserved • Printed in China UCZZ01671BZ

Free Manuals Download Website

<http://myh66.com>

<http://usermanuals.us>

<http://www.somanuals.com>

<http://www.4manuals.cc>

<http://www.manual-lib.com>

<http://www.404manual.com>

<http://www.luxmanual.com>

<http://aubethermostatmanual.com>

Golf course search by state

<http://golfingnear.com>

Email search by domain

<http://emailbydomain.com>

Auto manuals search

<http://auto.somanuals.com>

TV manuals search

<http://tv.somanuals.com>