

# CONTROLS AND FUNCTIONS

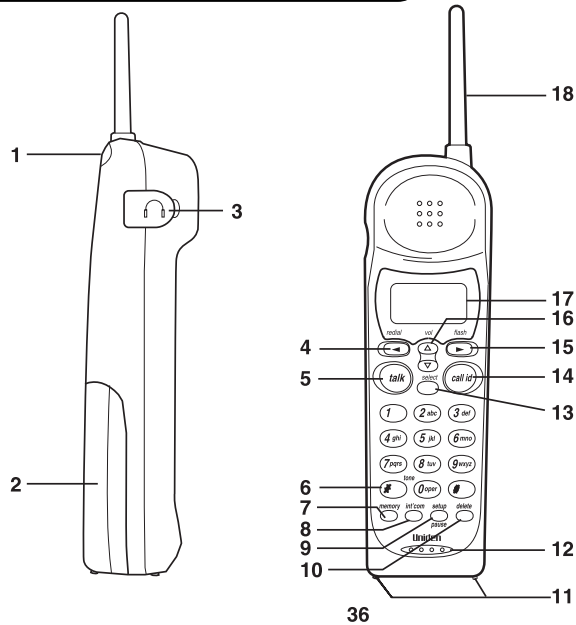

- |                           |                                |
|---------------------------|--------------------------------|
| 17. Handset Display       | 31. Message Counter Display    |
| 18. Handset Antenna       | 32. Status LED                 |
| 19. Handset Retainer Clip | 33. Volume Up and Down Keys    |
| 20. Charging Contacts     | 34. Speaker LED                |
| 21. Answer On/Off Key     | 35. Speaker Button             |
| 22. Set PIN Key           | 36. Speaker                    |
| 23. Set Clock Key         | 37. Ring Time Switch           |
| 24. Page/Int'com Key      | 38. Desktop/Wall Mount Adapter |
| 25. Repeat Key            | 39. Rec Time Switch            |
| 26. Greeting Key          | 40. Base Antenna               |
| 27. Voice Memo            | 41. Beltclip Holder            |
| 28. Skip Key              | 42. Microphone                 |
| 29. Delete Key            | 43. Spare Battery Compartment  |
| 30. Play/Stop Key         | 44. Reset Switch               |
|                           | 45. Base Ringer Off-On Switch  |
|                           | 46. Pulse/Tone Switch          |

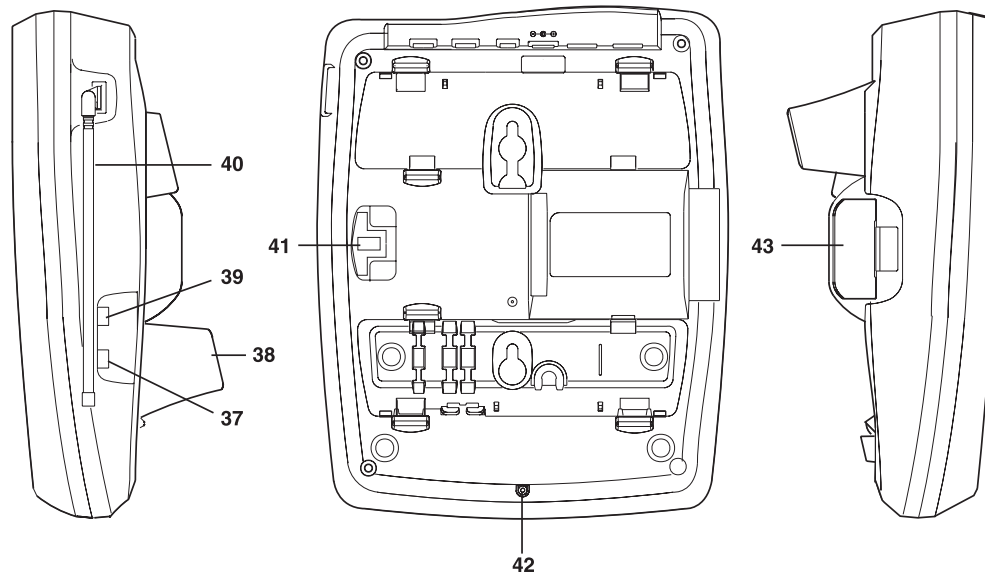
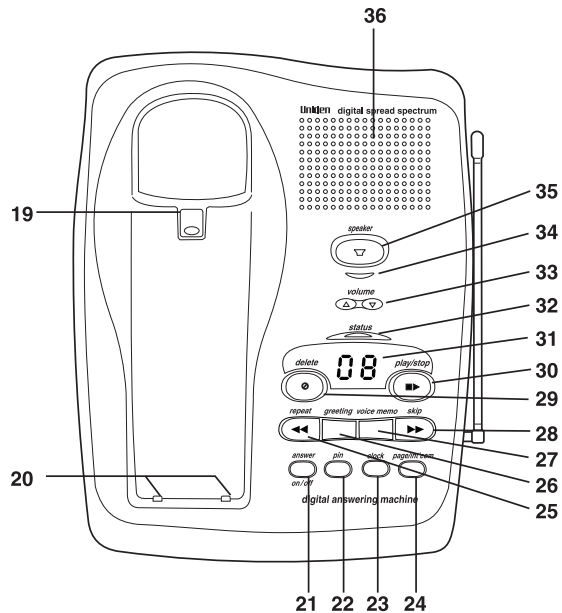
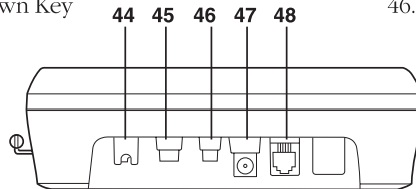

**At Uniden, we'll take care of you!**

If you need any assistance with this product, please call our Customer Hotline at

**1-800-297-1023**

**PLEASE DO NOT RETURN THIS PRODUCT TO THE PLACE OF PURCHASE.**

*Our Uniden representatives will be happy to help you with any matters regarding the operation of this unit, available accessories, or any other related matters.*

## NOTE

Fold out the front cover of this owner's manual to use the handy CONTROLS AND FUNCTIONS page for reference.

OF YOUR OWNERS MANUAL

# CONTENTS

<b>Controls And Functions</b> .....	<b>inside front cover</b>
<b>Introduction</b> .....	<b>2</b>
Features .....	2
Welcome .....	2
Included In Your Package .....	3
<b>Installing</b> .....	<b>4</b>
Selecting a Location .....	4
Desk/Tabletop Installation .....	5
Wall Installation .....	6
Installing the Handset Battery Pack .....	10
Charging the Battery Pack .....	11
Cleaning the Battery Contacts .....	12
Setting the Pulse/Tone Switch .....	12
Adjusting the Volume Controls .....	13
Installing the Beltclip .....	14
Headset Installation .....	15
Automatic Digital Code Security .....	15
<b>Using Your New Phone</b> .....	<b>16</b>
Making and Receiving Calls .....	16
Answering a Call From the Base .....	17
Answering a Call From the Handset .....	17
Making a Call From the Handset .....	17
Using the Tone Feature .....	18
Flash and Call Waiting .....	18
Using Redial .....	18
Using the Page Feature .....	18
Using Your EXS 9800 Intercom .....	19
Traveling Out-Of-Range .....	20
Storing a Phone Number In Memory .....	20
Editing a Phone Number In Memory .....	22
Erasing a Number From Memory .....	24
Using Memory Dialing .....	25
Setting Up Caller ID .....	26
Using the Speaker Phone .....	26
<b>Using Caller ID</b> .....	<b>30</b>
<b>Setting Up the Integrated Answering Device</b> .....	<b>33</b>
Features .....	33
Turning the Answering System On and Off .....	34
Setting the Clock .....	34
Recording Your Outgoing Message .....	35
Selecting the Message Time .....	36
Setting the Ring Time Switch .....	36
Recording a Voice Memo .....	37
Selecting the PIN Code .....	37
<b>Using the Integrated Answering Device</b> .....	<b>38</b>
Playing Your Messages .....	38
Repeating a Message .....	38
Skipping a Message .....	39
Deleting a Message .....	40
Recording a Conversation .....	40
Using the Reset Button .....	40
Remote Access Away from Home .....	41
Remote Room Monitor .....	42
<b>Troubleshooting</b> .....	<b>43</b>
<b>Specifications</b> .....	<b>44</b>

Introduction

Installing and  
Adjusting

Using Your  
New Phone

Using Caller ID

Setting Up  
Answering Device

Using Answering  
Device

Troubleshooting

Specifications

### WELCOME

Congratulations on your purchase of the Uniden EXS 9800 cordless telephone. This phone is designed for reliability, long life, and outstanding performance utilizing the latest in 900 MHz Spread Spectrum Technology.

### FEATURES

- 900 MHz Spread Spectrum Technology
- Integrated Telephone Answering Device (ITAD)
- Call ID and Call Waiting Caller ID (CICW)
- 50 Number Caller ID Memory
- Speakerphone
- Back-up Power Supply with Optional Battery Pack
- 3-Line, 16 Character LCD Handset Display
- Headset Compatible
- Handset Earpiece and Ringer Volume Control
- 20 Channel AutoScan
- 10 Enhanced Memory Dial Locations
- 32 Digit Redial
- 2-way Page/Intercom
- Hearing Aid Compatible
- Redial, Flash, and Pause
- Pulse/Tone Dialing
- 7-Day Standby Battery Time
- 4-Hour Talk Time

**Digital Spread Spectrum Technology** utilizes a “wider frequency band” vs. a “single narrow band” used in standard digital transmissions. The result is a more secure conversation with the clarity of digital sound, extended range, and minimal interference from other cordless phones.

**Random Code™** digital security automatically selects one of over 65,000 codes for the handset and base. This feature prevents unauthorized calls as a result of your phone being activated by other equipment.

## INCLUDED IN YOUR PACKAGE

### TIP

To get the most from your phone, please read this owner's manual thoroughly. Be sure to complete and mail the product registration form.

### NOTE

If any of these items are missing or damaged, contact the Uniden Parts Department at (800) 554-3988. Hours are from 8:00 a.m. to 5:00 p.m. Central Time, Monday through Friday. We can also be reached on the web at [www.uniden.com](http://www.uniden.com).



Handset

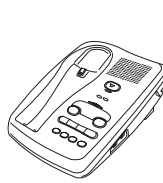

Base



AC Adapter

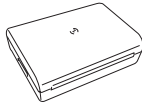

Rechargeable Battery



Short Telephone Cord



Beltclip



Long Telephone Cord

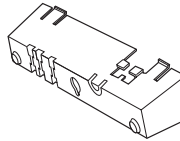

Desktop/Wall Mount Adapter

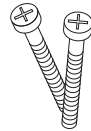

Wall Mounting Screws

- This Owner's Manual
- Precautions and Important Safety Instructions
- Registration Card

### SELECTING A LOCATION

Before choosing a location for your new phone, read the INSTALLATION CONSIDERATIONS included in the PRECAUTIONS AND IMPORTANT SAFETY INSTRUCTIONS brochure. Here are some important guidelines you should consider:

- The location should be close to both a phone jack and a continuous power outlet. (A continuous power outlet is an AC outlet which does not have a switch to interrupt its power.)
- Keep the base and handset away from sources of electrical noise such as motors and fluorescent lighting.
- Be sure there is sufficient space to rotate the base antenna fully vertical.
- The base can be placed on a desk, tabletop or mounted on a standard wall plate.
- You should charge your handset for 15-20 hours before connecting the phone line.
- If your second phone line has a separate jack, locate your phone so you can access both jacks.



## NOTE

Before using your phone, fully charge the Nickel-Cadmium battery pack for 15-20 hours.

## DESK/TABLETOP INSTALLATION

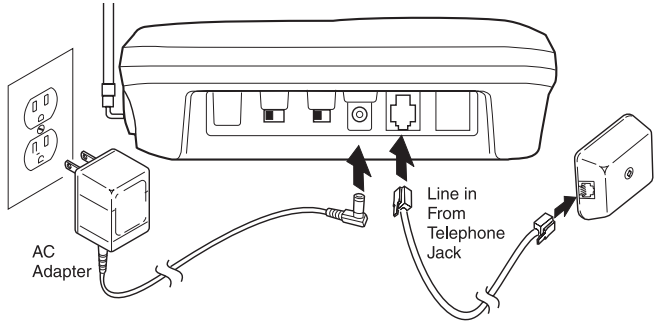

1. Snap the desktop/wall mount adapter into the top of the base as shown.
2. Plug the AC adapter cord into the 10 VDC input jack on the back of the base.
3. Wrap the AC adapter cord around the strain relief notch.
4. Plug the AC adapter into a standard 120V AC wall outlet.
5. Charge the battery (See **CHARGING THE BATTERY PACK**, page 11).
6. Plug one end of the long telephone cord into the **TEL LINE** jack on the back of the base.
7. Plug the other end of the cord into the telephone jack on the wall.
8. Set the base on a desk or tabletop with the keypad facing either facing up or down. Place the handset into the base. Raise the antenna to a vertical position.

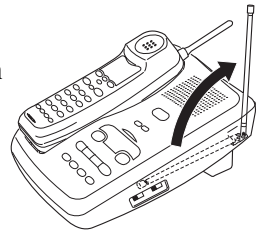
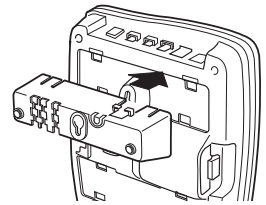

Place the power cord so that it does not create a trip hazard or where it could become chafed and create a fire or electrical hazard.



Use only the Uniden AC adapter supplied with this phone. **DO NOT** use an outlet controlled by a wall switch.

## WALL INSTALLATION

### ▼ *Standard wall plate mounting*

This phone can be mounted on any standard AT&T or GTE wall plate.

1. Snap the desktop/wall mount adapter into the bottom of the base as shown.
2. Plug the AC adapter into the base.
3. Place the AC adapter cord inside the molded wiring channel. Wrap the cord around the strain relief notch.
4. Plug the AC adapter into a standard 120V AC wall outlet.
5. Plug one end of the short telephone cord into the **TEL LINE** jack on the back of the base. Plug the other end into a standard telephone jack.

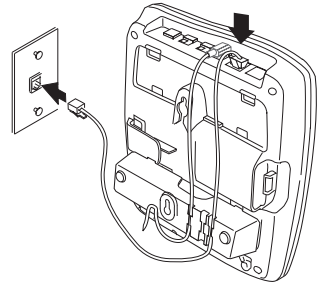
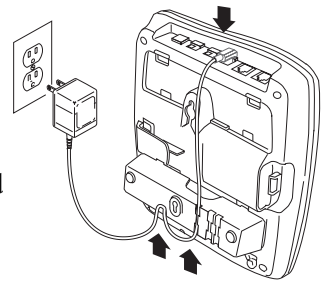
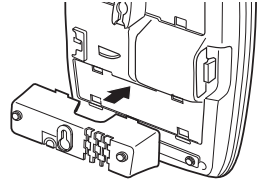

Place the power cord so that it does not create a trip hazard or where it could become chafed and create a fire or electrical hazard.



Use only the Uniden AC adapter supplied with this phone. **DO NOT** use an outlet controlled by a wall switch.





Before you plug the other end of the telephone cord into the modular jack on the wall, charge the battery (See CHARGING THE BATTERY PACK, page 11).

6. Align the mounting slots on the base with the mounting posts on the wall. Push in and down until the phone is firmly seated.

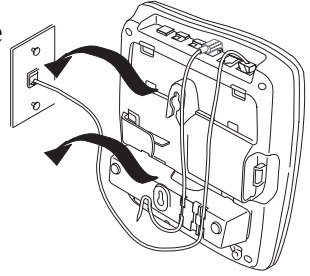

7. On the base, pull the handset retainer out of the slot. Rotate clockwise 180°.

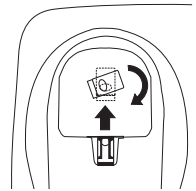

8. Flip the retainer from front to back. Slide it back into the slot so that the lip of the retainer is up and the oval is down. The retainer holds the handset in place.

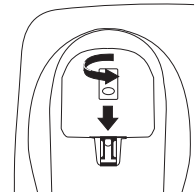

#### ▼ *Direct wall mounting*

If you don't have a standard wall plate, you can mount your phone directly to the wall. Before doing this, consider the following:

- Select a location away from electrical cables, pipes, or other items behind the mounting location that could cause a hazard when inserting the screws into the wall.
- Mount your phone near a working phone jack to avoid excessive cord lengths
- Make sure the wall material is capable of supporting the weight of the base and the handset.



Be careful not to insert the mounting screws into possible electrical hazards such as cables, wiring, or pipes.

1. Insert two mounting screws (with their appropriate anchoring device) into the wall 3-15/16 inches apart. Allow about 3/16 of an inch between the wall and screw heads for mounting the phone.

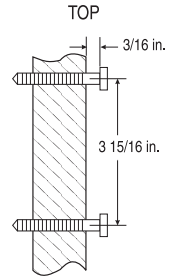

2. Snap the desktop/wall mount adapter into the bottom of the base as shown.

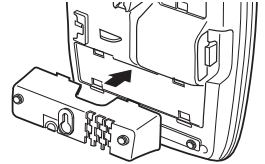

3. Plug the AC adapter cord into the 10V DC input jack on the back of the base.
4. Put the AC adapter cord inside the molded wiring channel. Wrap it around the strain relief notch. Plug the AC adapter into a standard 120V AC wall outlet.
5. Plug one end of the long telephone cord into the **TEL LINE** jack on the back of the base. Plug the other end into a telephone jack.

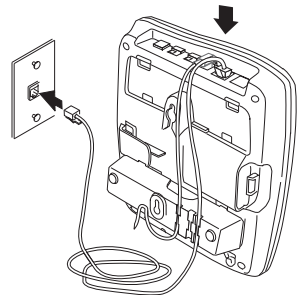
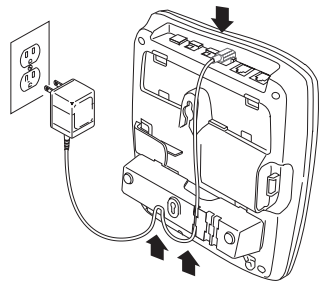

6. Align the mounting slots on the base with the mounting screws on the wall. Push in and down until the phone is firmly seated.

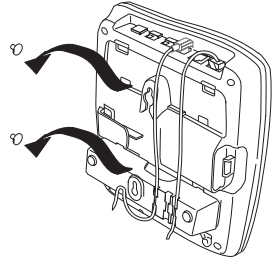

7. On the base, pull the handset retainer out of the slot. Rotate clockwise 180°.

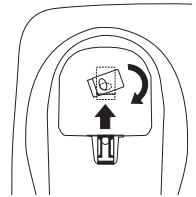

8. Flip the retainer from front to back. Slide it back into the slot so that the lip of the retainer is up and the oval is down. The retainer holds the handset in place.

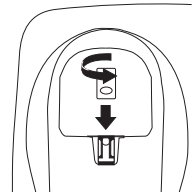

## INSTALLING THE HANDSET BATTERY PACK



Use only Uniden Battery (model BT-990) supplied with your phone.

1. Press battery cover release.  
Slide cover off.

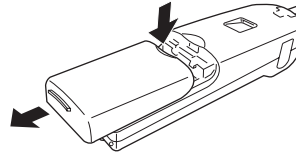

2. Install the nickel-cadmium battery with the label down.

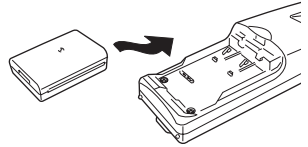

3. Slide the battery cover forward until it snaps into place

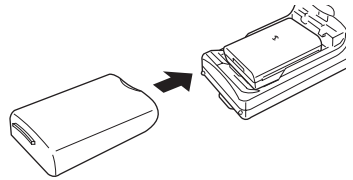

## CHARGING THE BATTERY PACK

### ▼ Initial battery charging

Before connecting your the phone for the first time, fully charge the rechargeable battery pack for 15-20 hours without interruption.

1. Place the handset on the base.
2. Make sure that **status** LED lights. If the LED doesn't light, be sure the AC adapter is plugged in and the handset makes good contact with the base charging contacts.

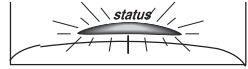

### ▼ Charging optional battery packs

The base of your phone is equipped with a compartment for charging an extra battery pack for use in your handset. **You can obtain an extra battery pack from your authorized Uniden dealer.**

1. Position the battery pack so the contacts are face up.
2. Slide the battery pack into the charging compartment until it locks into place.

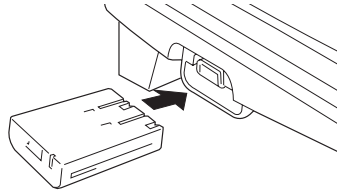

3. Charge the battery for 24 hours. When charging is complete, lift the latch to remove the battery pack. To install the charged battery into the handset, see INSTALLING THE HANDSET BATTERY PACK, page 10.

### NOTE

Please visit your authorized Uniden dealer to obtain an extra battery pack or contact the Uniden Parts Department at (800) 554-3988. Hours are from 8:00 a.m. to 5:00 p.m. Central Standard Time, Monday through Friday.



*In the event of a power failure, your spare battery pack temporarily provides power for the base so you can still use your phone.*

▼ *Low battery indicator*

When the battery pack is very low and needs to be charged, the phone is programmed to eliminate some functions to save power. If the phone is not in use, **Low Battery** flashes.

Low Battery

If the phone is in use, **Low Battery** flashes and the handset beeps.



*All rechargeable nickel-cadmium batteries develop a "memory effect". The memory effect gradually reduces your talk and standby time.*

▼ *To avoid Memory Effect*

On a monthly basis, use the phone until the **Low Battery** indicator flashes on the handset. Then charge the battery for 15-20 hours.

With normal usage, your battery should last about one year.

## CLEANING THE BATTERY CONTACTS

To maintain a good charge, clean all charging contacts on the handset and base about once a month. Use a pencil eraser or other contact cleaner. DO NOT use liquids or solvents; you may damage your phone.

## SETTING THE PULSE/TONE SWITCH

Be sure the **PULSE/TONE** switch is the **TONE** position unless your local phone system uses pulse dialing.

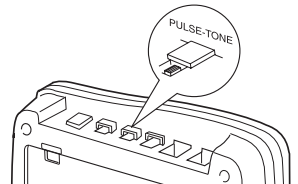

### TIP

Most phone systems use tone dialing. Check with your local phone company if you're not sure whether your system is tone or pulse.

## ADJUSTING THE VOLUME CONTROLS

### ▼ Handset ringer volume

Press the **vol ▲** or **▼** key on the handset to set the handset ringer volume. There are two ringer volume settings; high and low.

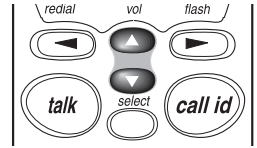

To select the high volume setting, press **vol ▲**. The following screen displays:

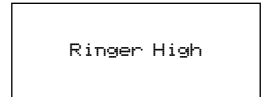

To select the low volume setting, press **vol ▼**. The following screen displays:

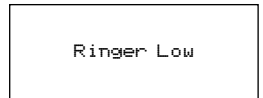

### ▼ Handset earpiece volume

There are three volume settings for the handset earpiece; high, normal and low. The handset earpiece volume can be adjusted only during a call.

To lower the volume, press **vol ▼**. To raise the volume, press **vol ▲**. The handset displays **Volume High**, **Volume Normal** or **Volume Low** indicating the current volume setting.

### ▼ Base ringer volume

The ringer switch at the base of your EXS 9800 allows you to turn the ringer **OFF** or **ON**.

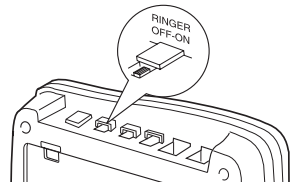

### ▼ Base speaker volume

To control the speaker volume of the base, press the **▲** or **▼** button.

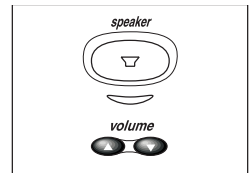

## INSTALLING THE BELTCLIP

### ▼ *To attach the beltclip.*

1. Remove the slot cover
2. Insert the beltclip into the empty slot and press down until it clicks.

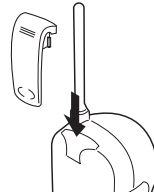
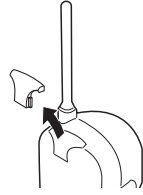

### ▼ *To remove the beltclip*

1. Pull back on the release tab and lift the beltclip up.
2. Replace the slot cover. You can store either the beltclip or slot cover on the bottom of the base.

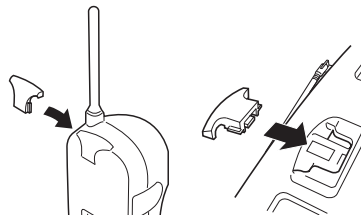
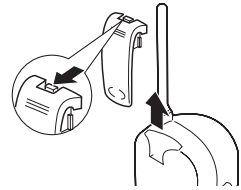



## IMPORTANT

Use only the Uniden HS910 headset specifically designed for Spread Spectrum phones. You may hear a buzz or hum on other headsets.

## NOTE

Keep headset wire away from handset and base antennas.

## HEADSET INSTALLATION

Your phone may be used with an optional headset, the Uniden HS910. To use this feature, simply plug the headset plug into the headset jack. Your phone is ready for hands-free conversations.

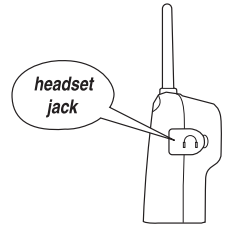

*If you are using an optional headset, you must still use the handset keypad for phone operations.*

## AUTOMATIC DIGITAL CODE SECURITY

To prevent other parties from making unauthorized calls on your phone line, a digital code was added to the EXS 9800. Your phone's handset and base share this code. This code is randomly set each time you place the handset in the base. If the phone experiences a power failure, you must reset the digital security code by placing the handset in the base.

### ▼ To reset the digital security code

1. Restore power to the base
2. Place the handset on the base.  
The **status** LED flashes to indicate that the digital security code is reset.

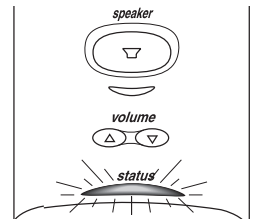

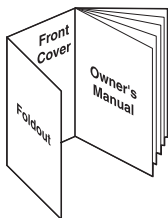



Fold out the front cover of this owner's manual to use the CONTROLS AND FUNCTIONS diagram for reference.

## MAKING AND RECEIVING CALLS

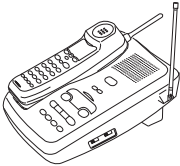
### ▼ Basic 2-line operation

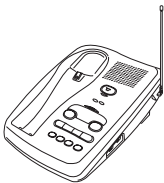
	Handset On Base	Handset Off Base	Base Only
			
<b>To answer a call</b>	<ol style="list-style-type: none"> <li>1. Pick up the handset.</li> <li>2. Press <b>talk</b>.</li> </ol>	Press <b>talk</b> .	Press <b>speaker</b> .
<b>To make a call</b>	<ol style="list-style-type: none"> <li>1. Pick up the handset.</li> <li>2. Press <b>talk</b>.</li> <li>3. Listen for the dial tone</li> <li>4. Dial the number.</li> </ol>	<ol style="list-style-type: none"> <li>1. Press <b>talk</b>.</li> <li>2. Listen for the dial tone.</li> <li>3. Dial the number.</li> </ol>	
<b>To hang up</b>	Press <b>talk</b> , or return the handset to the base (AutoStandby).		Press <b>speaker</b> .
<b>To redial</b>	<ol style="list-style-type: none"> <li>1. Pick up the handset.</li> <li>2. Press <b>talk</b>.</li> <li>3. Listen for the dial tone.</li> <li>4. Press <b>redial</b>.</li> </ol>	<ol style="list-style-type: none"> <li>1. Press <b>talk</b>.</li> <li>2. Listen for the dial tone.</li> <li>3. Press <b>redial</b>.</li> </ol>	

# USING

YOUR NEW PHONE

## ANSWERING A CALL FROM THE BASE

1. The base rings. The LED on the base flashes.
2. Press the **speaker** to answer.
3. When you finish the call, press **speaker** to hang up.



## ANSWERING A CALL FROM THE HANDSET

1. The handset rings and the following screen appears:
2. Press **talk** to answer
3. When you finish the call, press **talk** on the handset, or return the handset to the base.

<Call>

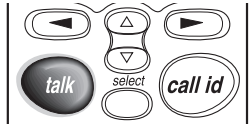

### HINT

AutoStandby automatically hangs up when you place the handset on the base.

## MAKING A CALL FROM THE HANDSET

### ▼ *In Use Dialing (Off-Hook Dialing)*

1. Pick up the handset.
2. Press **talk** to answer.
3. Dial the number on the keypad, or use one of the memory features.  
(See USING MEMORY DIALING, page 25).
4. When you finish the call, press **talk**, or return the handset to the base.

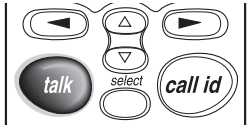

### ▼ *Standby Dialing (On-Hook Dialing)*

To call a number while the handset is on the base, dial the number on the keypad, or use one of the memory features. Press **talk**. (See USING MEMORY DIALING, page 25.)

## NOTE

The tone feature applies only when the base is set to pulse.

## USING THE TONE FEATURE

If you are dialing in the pulse mode and need to enter tone digits, press **tone** then enter the digits. Once the call has ended, tone mode is canceled and pulse dialing resumes.

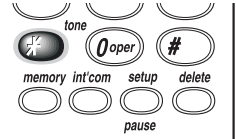

## FLASH AND CALL WAITING

If you have Call Waiting service and a call waiting tone sounds, press **flash** to accept the call. After a short pause you will hear the new caller. To return to the original caller, press **flash** again.

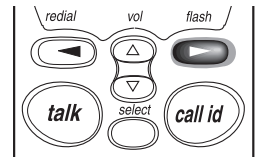

## USING REDIAL

The **redial** key redials the last number dialed. The redialed number can be up to 32 digits long.

To call the last number dialed from the handset, press **redial**.

*If any key is pressed before **redial/p**, the the last number will not redial.*

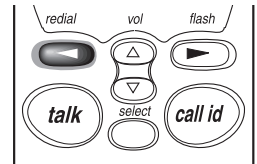

## USING THE PAGE FEATURE

To locate the handset when it is off the base, press **page/int'com** on the base.

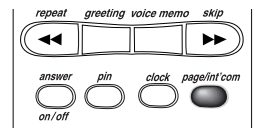

The handset beeps for 60 seconds.  
The following screen appears:

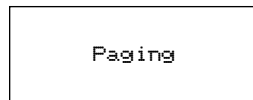

Press **int'com** on the handset to end paging. Press **page/int'com** on the base to return to Standby.

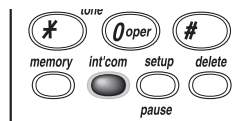

## USING YOUR EXS 9800 INTERCOM

### ▼ *Paging from the Base to the Handset*

1. Press **page/int'com** on the base.  
The handset beeps. (If no answer, press **page/int'com** again to disconnect.)

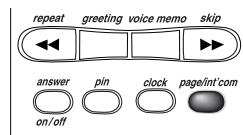

2. To answer a page, press **int'com** on the handset. Speak within 12 inches of the base microphone.

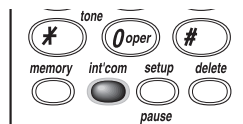

3. To turn off the intercom, press **page/int'com** on the base, or **int'com** on the handset.

### ▼ *Paging from the Handset to the Base*

1. Press **int'com** on the handset.  
(If no answer, press **int'com** to disconnect.)
2. To answer a page at the base, press **page/int'com**. Speak within 12 inches of the base microphone.

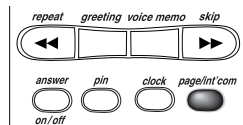
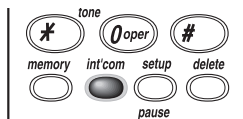

3. To turn off the intercom, press **page/int'com** at the base or **int'com** on the handset.

## TRAVELING OUT-OF-RANGE

As you begin to move too far from the base, you will first hear a clicking sound. As you travel further, the noise increases. If you travel out-of-range, your call terminates.

## STORING A PHONE NUMBER IN MEMORY

Your EXS 9800 stores up to 10 name/numbers in the handset.

1. Remove the handset from the base.
2. Press and hold **memory** for two seconds.

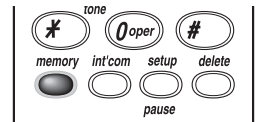

The following screen appears:

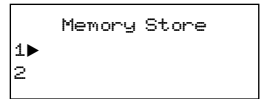

3. Use the ▲ and ▼ keys or number keypad to choose a memory location to store a name/number.
4. Press **select**.

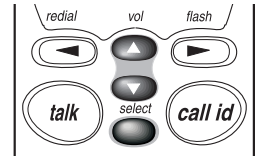

The following screen appears:

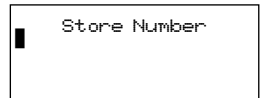

5. Enter a name by using the ▲ and ▼ keys to scroll through the character menu. Stop scrolling and press **select** when you see the desired character. Use the ◀ and ▶ keys right or left, or to create a blank space.

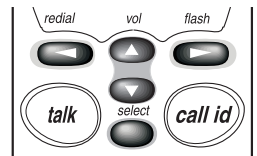

### NOTE

Whenever you are using a menu screen, you must press a key within 20 seconds or the phone will return to Standby. You may also press **memory** to quit a **memory** menu at any time.

6. When you have finished entering a name, press **select**.

The following screen appears.

The cursor flashes indicating that the display is ready for a number to be entered.

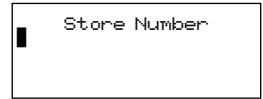

7. Enter the phone number with the number keypad (direct entry) or the ▲ and ▼ keys. Use the ▲ and ▼ keys to enter symbols, such as dashes. Use the ◀ and ▶ keys to position the cursor.



*When entering name/numbers, you may press **pause** to enter a pause in the dialing sequence. The display shows a P. The pause feature is useful for long distance calling, credit card dialing, or any other dialing sequence requiring a pause between digits.*

8. When you have finished entering a number, press **select**.

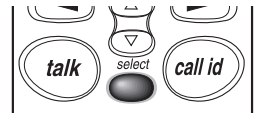

The handset beeps and displays a confirmation screen.

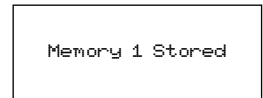

## EDITING A PHONE NUMBER IN MEMORY

To edit a number you have stored in the handset:

1. Remove the handset from the base.
2. Press and hold **memory** for two seconds.

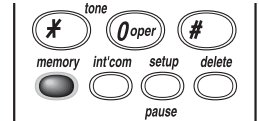

The display shows the Memory Store screen and any saved name/numbers.

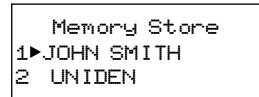

3. Use the ▲ and ▼ keys or number keypad to select the memory location you would like to edit.
4. Press **select**.

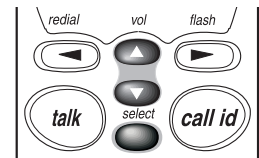

The display shows the memory location you have selected.

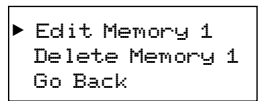

5. Press **select** again to enter the Edit Memory mode.

The following screen appears. A cursor flashes indicating that the display is ready to edit the name/number.

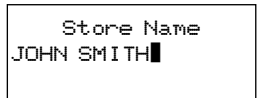

6. Edit the name with the ▲ and ▼ keys. Use the ▲ and ▼ keys to enter symbols. Use the ◀ and ▶ keys to move the cursor left and right.
7. Press **select**.

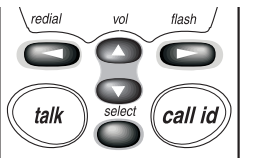

The following screen appears.

A cursor flashes indicating that the display is ready for the number to be edited.

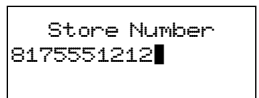

### NOTE

Whenever you are using a menu screen, you must press a key within 20 seconds or the phone will return to Standby. You may also press **memory** to exit a **memory** menu at any time.

### NOTE

If you select **Go Back** at any time, no changes are made and the handset shows the Memory Store screen.



8. Edit the phone number with the number keypad (direct entry) *or* with the ▲ and ▼ keys.

Use the ▲ and ▼ keys to enter symbols.

Use the ◀ and ▶ keys to move the cursor left and right.

9. Press **select**.

The handset beeps and displays the confirmation screen.

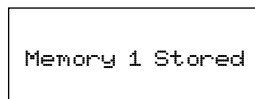

10. The display then returns to the Memory Store screen. You may select another number to edit (return to step 3) or press **memory** to return to Standby.

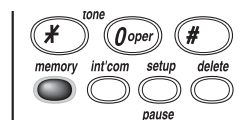

## ERASING A NUMBER FROM MEMORY

After erasing a number, you may add a new address to memory.

1. Remove the handset from the base
2. Press and hold **memory** for two seconds.

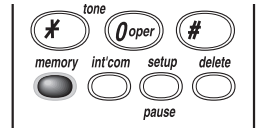

The handset shows the Memory Store screen with saved name/numbers displayed.

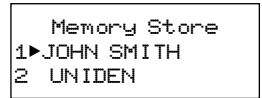

3. Use the ▲ and ▼ keys, or number keypad, to select the memory location you would like to delete. The ◀ and ▶ keys toggle between the name display and the number display.
4. Press **select**.

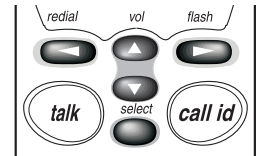

The following screen appears:

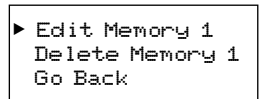

5. Use the ▼ key to move the ▶ cursor to **Delete Memory**.
6. Press **select**.
7. Use the ▼ key to move the ▶ cursor to **Yes**.
8. Press **select**.

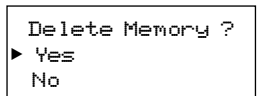
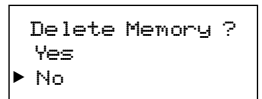

There is confirmation tone.  
The following screen appears:

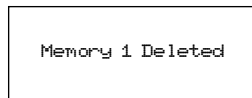

- The display then returns to the Memory Store screen. You may select another number to delete (return to step 3) or you may press **memory** to return to Standby.

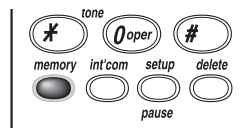

## USING MEMORY DIALING

To dial a number using a programmed memory location:

- Press **memory**.

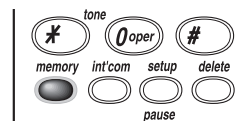

The handset displays your programmed memory locations.

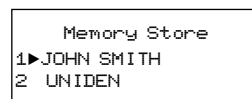

- Use the ▲ and ▼ keys to select the memory location you would like to dial.

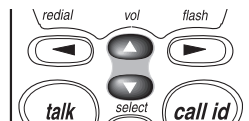

The following screen appears:

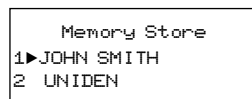

- Press **talk**. The number dials.

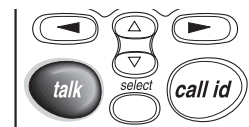

## USING THE SPEAKER PHONE

You may use the phone as a speaker phone to answer calls by pressing the **talk** button on the base. To hang up, press **talk** again.

The base microphone is located under the phone. Position yourself approximately 12 inches away from the base and speak clearly.

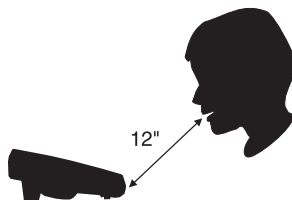

## USING CALLER ID

**You must subscribe to Caller ID from your phone company to use this feature.**

### ▼ *Setting up Caller ID options*

There are three Caller ID options available; they are AutoTalk, CIDCW, and Area Code.

AutoTalk allows you to answer the phone without pressing **talk**. If the phone rings when AutoTalk is on, simply remove the handset from the base and the phone automatically answers the call. If the phone rings when AutoTalk is off, you must press **talk** to answer the call. This option is useful for screening calls.

CIDCW (Caller ID with Call Waiting) performs the same as regular Caller ID on a call waiting number. **You must subscribe to CIDCW from your phone company to use this feature.**

The **Area Code** feature is used when storing or calling numbers from Caller ID memory. All numbers with this area code are dialed directly without the area code.

*If you are programming numbers within your area code that require all ten digits to be dialed, it is recommended that you do not program this feature.*

### HINT

You may use the < and > keys to toggle between numbers when programming the area code.

To change your Caller ID options:

1. Press and hold **setup** for two seconds.

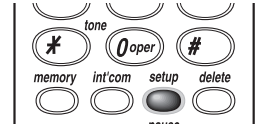

The following screen appears

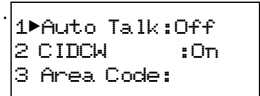

2. Use the ▲ and ▼ keys to move the cursor to the selection that you would like to change.

To turn AutoTalk and CIDCW On or Off, press the **select** key.

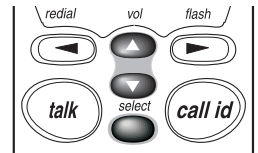

To change the area code, press **select**. Then, use the number keypad to enter the area code. Press **select** again.

3. After you finish your selections, press **setup**. Return the handset to the base. The status LED flashes, indicating that your setup changes are now effective.

#### ▼ *Screening your calls*

Caller ID allows you to review caller information before answering your phone. At the beginning of the second ring, the display shows the date, time, call count, name, and phone number of the caller. If your Caller ID service is number only, the name does not appear on the second line.

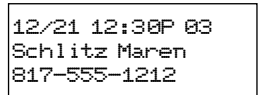

If a name or number is not available, the display shows a message such as Incomplete Data, Private Number, Private Name, etc.

▼ *Reviewing Caller ID name/numbers*

To review your Caller ID name/numbers, follow the steps below:

1. Press **call id**.

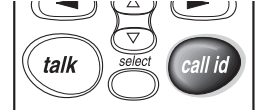

The following screen appears:

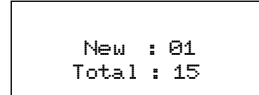

2. Press ▼ to scan through the name/numbers.

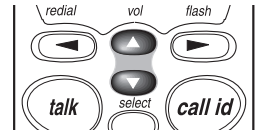

The most recent name/number appears first, with the date, time, call count, name, and phone number. Press ▲ to scan backwards.

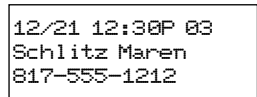

3. Once you have reviewed your oldest name/number, the following screen appears.

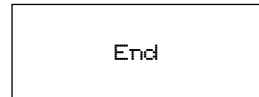

4. Press **memory** to return to Standby.

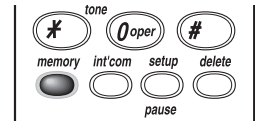

*Once you have viewed all of your Caller ID name/numbers and reach End, the message list does not cycle back to the beginning. You must press ▲ to view your previous name/numbers.*

▼ *Calling a Caller ID name/number*

1. Press **call id**.

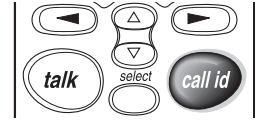

The Caller ID summary screen shows the number of new callers and total number of calls.

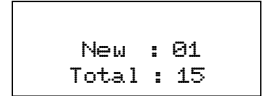

2. Press ▼ to scan forward. Press ▲ to scan backwards through the list.

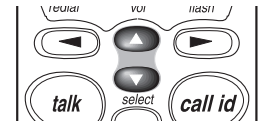

3. Select the name/number that you would like to dial.

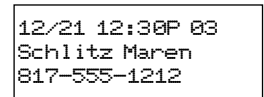

4. Press **talk**. The number automatically dials.

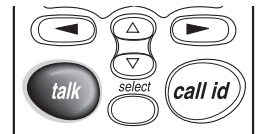

*For long distance calling, insert "1" by pressing **1** on the keypad before pressing **talk***

▼ *Storing a Caller ID name/number in a memory location*

1. Press **call id**.

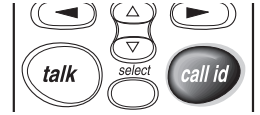

The Caller ID summary screen shows the number of new calls and total number of callers.

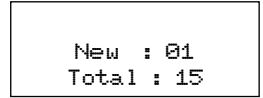

3. Press ▲ or ▼ to find the name/number that you would like to store.

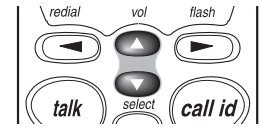

4. Press **memory** to store the selected name/number.

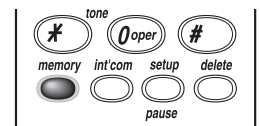

The following screen appears:

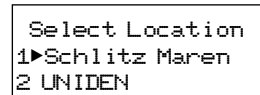

5. The Select Location screen appears. Use the ▲ and ▼ keys to select a blank memory location to store the new name/number. (If you want to replace an existing number with the Caller ID name/number, skip to step 5.)

6. Press **select**. A confirmation tone sounds. The number is programmed. (Do not complete steps 5 and 6.)

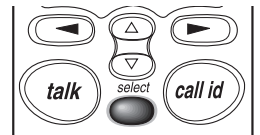

7. If you choose to replace an existing number with the new Caller ID name/number, press **select**. The following screen appears:

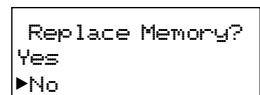



- Use the ▲ key to move the cursor to **Yes**. Press **select**.  
A confirmation tone sounds. The number is programmed.

▼ *Deleting a Caller ID name/number*

To delete a single Caller ID name/number, follow the steps below.

- Press **call id**.

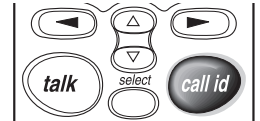

The Caller ID summary screen shows the number of new callers and total number of calls.

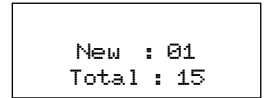

- Select the number that you would like to delete. Press ▼ to scan forward through the name/numbers and ▲ to scan backwards.

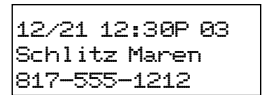

- Press **delete**.

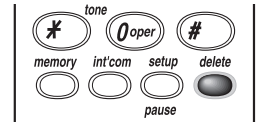

The following screen appears:

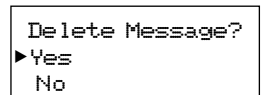

If you select **No**, the Caller ID screen returns.

- Press **select** or **delete**. A confirmation tone sounds. The Caller ID screen returns with the next name/number displayed.
- Press **call id** to return to Standby.

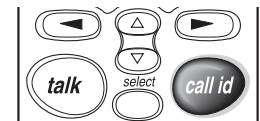

### ▼ *Deleting all Caller ID name/numbers*

To delete all of your Caller ID locations, follow the steps below:

1. Press **call id**.

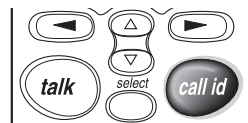

The Caller ID summary screen shows the number of new callers and total number of calls.

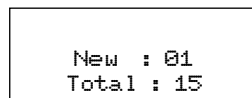

2. Press **delete**.

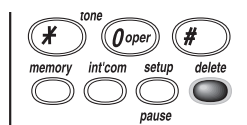

The following screen appears.

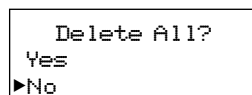

3. Use the ▲ key to move the cursor to **Yes**.

A confirmation tone sounds.

The following screen appears.

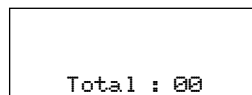

4. All your caller ID locations are deleted.
5. Press **call id** to return to Standby.

### ▼ *Using CIDCW (Caller ID with Call Waiting)*

1. During a call, when you hear the Caller ID tone, check the handset display for the name and number of incoming calls.

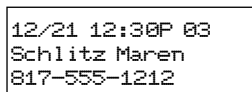

2. Press **flash** to accept the incoming call. See FLASH AND CALL WAITING, page 19, for additional information.

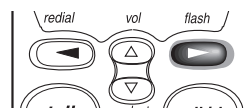

### THE INTEGRATED ANSWERING DEVICE

The EXS9800 has a built-in answering system to answer and record your incoming calls. You can use your answering system to record a conversation, leave a memo message for others who use the phone, or to answer the phone with your personalized message when you are away.

### FEATURES

- Digital Tapeless Recording
- 15 minutes Recording Time
- Call Screening
- Selectable Outgoing Messages
- Time and Day Stamp
- Remote Access
- Toll Saver

Digital Tapeless Recording allows you to quickly review, save, or delete messages. You'll never worry about a tape wearing out, jamming, or resetting improperly.

The Integrated Answering System is easy and convenient to use., However, *please read all* instructions carefully before using your answering system.

## TURNING THE ANSWERING SYSTEM ON/OFF

- To turn the answering system on, press **answer on/off**. A tone sounds. An outgoing message plays on the base speaker. A second tone sounds after the message plays. The message counter LED turns on to indicate the unit is ready to answer calls.
- To turn the answering system off, press **answer on/off** again. A tone sounds followed by the announcement "Answer off". The message counter LED turns off.

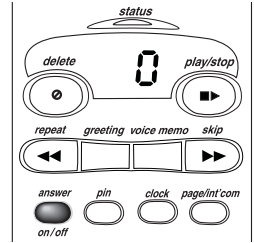

## SETTING THE CLOCK

The clock on the EXS9800 Answering System starts when power is applied to the base.

To set the correct time:

- Press and hold **clock** until a tone sounds.
- Press **skip** or **repeat** until the correct day is announced. Numbers zero through six display as each day is announced.
- Press **clock** again to select the day. The hour setting is announced.
- Press **skip** or **repeat** until you hear the current hour setting. Numbers 1 through 12 display as each hour is announced.

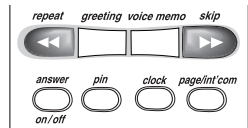
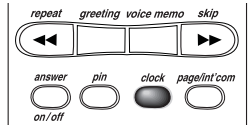

5. Press **clock** again to select the correct hour.
6. Press **skip** or **repeat** until you hear the current minute setting.  
The numbers 0 through 59 display as each minute is announced.
7. Press **clock** again to select the correct minute.  
The AM/PM setting is announced.
8. The LED displays an **A** or **P**. Press **skip** or **repeat** until you hear the correct AM/PM setting.
9. Press **clock** again to complete your settings.  
The EXS9800 announces the correct time.

## RECORDING YOUR OUTGOING MESSAGE

When you receive a call, the answering system automatically plays either a preset greeting, or your own personal greeting.

### ▼ *Preset message*

The following message is prerecorded:

*“Hello, no one is available to take your call.  
Please leave a message after the tone.”*

### ▼ *Recording your personal Greeting*

1. Press and hold **greeting** until you hear a long tone. After the message counter LED blinks, release **greeting**. Record your message by speaking within 12 inches of the base microphone
2. When you finish recording your message, press **greeting** again. A tone sounds. Your message plays back for your review.

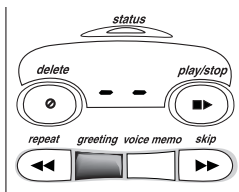

*To choose between the pre-recorded greeting and your personal greeting, press **greeting** during outgoing message playback.*

### ▼ *Announce Only feature*

The Announce Only feature repeats a prerecorded greeting - “No one is available to take your call”, or your own personal greeting. It will not allow the caller to leave a message.

For Announce Only, move the **REC TIME** switch to the **ANN** position.

The message counter LED displays **A** when the system is on Standby

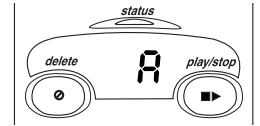
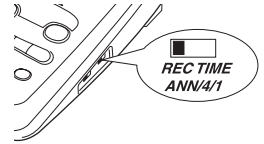

## SELECTING THE MESSAGE TIME

You can set your answering system to record messages up to four minutes long.

To record up to one minute, move the **REC TIME** switch to **1**.

To record up to four minutes, move the **REC TIME** switch to **4**.

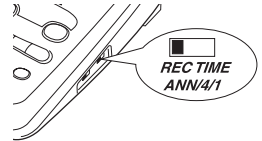

## TIP

The Voice Memo function is completely independent of the outgoing message. It's handy for leaving other family members quick messages when you are unavailable.

## NOTE

A Voice Memo is treated as an incoming recorded message. It will be added to your stored messages.

## RECORDING A VOICE MEMO

The Voice Memo function allows the user to record a message on the base for others who use your phone.

1. Press and hold **voice memo**. A tone sounds and the message counter LED begins to blink.
2. Release **voice memo**. To record your message, speak within 12 inches of the base microphone.
3. When you have finished your message, press **voice memo** to stop recording. The system returns to Standby.

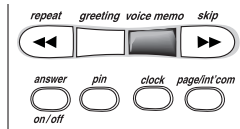

## SELECTING A PIN CODE

To listen to your messages from a remote location, you will need to enter a two-digit Personal Identification Number (PIN) code (00-99). To select a PIN:

1. Press and hold the **pin** button. A tone sounds, and the LED displays **00**.
2. To set the first number, press **skip** or **repeat** to scroll from 0 to 9. When the desired number appears in the display, press **pin** again. This selects the first number.
3. To set the second number, press **skip** or **repeat** to scroll from 0 to 9. When the desired number appears in the display, press **pin**. This selects the second number. Your PIN is announced.

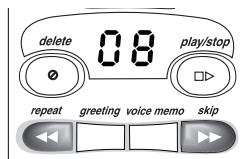
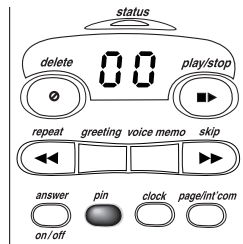

**HINT**

To stop playing your message at any time, press **play/stop** again.

**SETTING THE TOLL SAVER SWITCH**

The ring time/toll saver switch sets your answering system to answer after two or four rings.

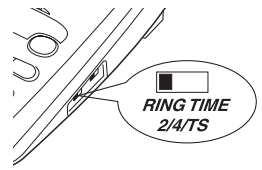

In the **TS** (Toll Saver) position, if you have new messages, the answering system answers after two rings. If there are no new messages, the system answers after four rings. This way, when you call long distance to check your messages, and have no messages, you can hang up after the second ring to save a charge.

**USING THE RESET BUTTON**

The **RESET** button is used to initialize the base computer.

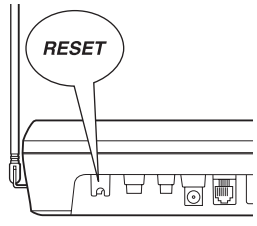

The reset button can be used if an AC power line disturbance causes the answering system to malfunction and become inoperative. Pressing **RESET** does not erase any data stored in your system memory.

**PLAYING YOUR MESSAGES**

The base LED displays the total number of messages. If the display is blinking, you have new messages. When the message center is full, the LED displays **FL**. The EXS9800 plays your new messages first. After listening to your new messages, you may listen to your old messages.

1. Press **play/stop**.

The system announces the number of new and old messages. After each message is played, the time and day the message was received is announced. The message counter LED displays the number of current messages.

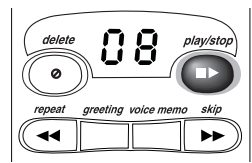



## NOTE

Pressing **repeat** before 1-1/2 seconds of the name/number is displayed, causes the system to scan back one message.

## TIP

If you have several name/numbers, press **repeat** until you return to the name/number you want replayed.

## NOTE

The system automatically returns to Standby when all messages have played.

## HINT

Each time **skip** is pressed, the system scans forward one name/number. If you have several messages, press **skip** to find the name/number you want display.

- When all new messages have played, a long tone is heard. The message counter LED stops flashing. To indicate all new messages have been reviewed.
- After reviewing your new messages, you can review your old messages. Press **play/stop** and follow the instructions above.

## REPEATING A MESSAGE

- Press **play/stop** to review your messages. The number of old messages is announced.

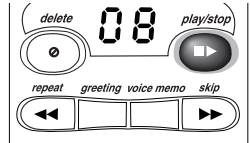

- After a message plays for a few seconds, press **repeat** to replay the message.
- You may press **play/stop** at any time to stop reviewing and return to Standby. The counter LED shows the total number of messages still on the system.

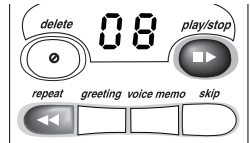

## SKIPPING A MESSAGE

- Press **play/stop** to review your messages. The number of messages is announced.

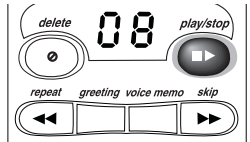

- Press **skip** at anytime to skip to the next message.
- Press **play/stop** at any time to stop reviewing your messages and return to Standby.

The message counter LED shows the total number of messages still on the system.

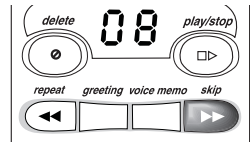

## NOTE

When you press **delete**, you are permanently deleting the message. Once deleted, the message cannot be replayed.

## NOTE

A recorded conversation is handled as an incoming message. It is added to your stored messages.

## DELETING A MESSAGE

1. Press **play/stop** to review your messages

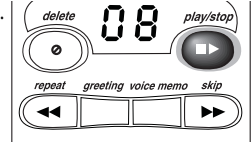

2. If you decide to delete a message, while listening to a message, press **delete** until you hear a tone. The system beeps and goes to the next message.
3. After you have played all of your messages, a long tone sounds.

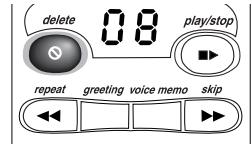

*To delete all your messages, press and hold **delete** after reviewing messages. When all message are deleted, a tone sounds.*

## RECORDING A CONVERSATION

You can record up to a 15 minute conversation while using your phone.

1. During a conversation, press **voice memo**. The unit begins recording. The display shows two dashes. A tone can be heard by both parties every 15 seconds.
2. To stop recording, press **voice memo** again.

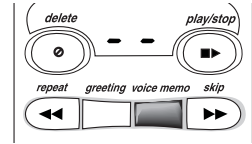

## REMOTE ACCESS AWAY FROM HOME

### NOTE

You must enter a command within 15 seconds of entering Command Waiting mode or the answering system automatically hangs up and returns to Standby.

### NOTE

The system will only playback messages for four minutes and then it returns to Command Waiting mode. To continue playing your messages, press **# 2** again within 15 seconds

You can access your answering system from a remote location with a touch-tone telephone to check recorded messages, play or delete messages, or record a new outgoing message.

1. Call your telephone number.
2. While the outgoing message is playing, press **#** followed by your PIN number. (For instructions to set your PIN code see page 37).
3. The answering system announces the time and day followed by the number of messages in memory. Message playback automatically begins.
4. You may listen to your messages, or you may select a command from the following chart:

FUNCTION	PRESS
Repeat	#, 1
Play	#, 2
Skip	#, 3
Delete	#, 4
Stop	#, 5
Answer On	#, 6
Voice Memo Record/Stop	#, 7
Greeting Record/Stop	#, 8
Answer Off	#, 9
Monitor	#, *

5. After all of your messages have played, intermittent beeps indicate that your system is in Command Waiting mode. At this time, you may enter another command from the chart above.
6. When you are finished, hang up to exit the system. The answering system automatically returns to Standby.

## REMOTE ROOM MONITOR

You may call your answering system from any touch tone phone to monitor sounds in the room where the base is installed.

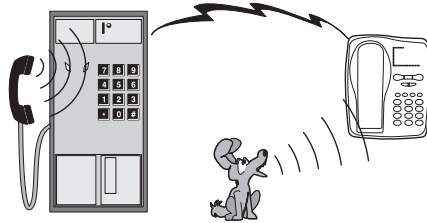

1. Call your telephone number.
2. During the outgoing message playback, press **#** followed by your PIN code. (See SELECTING A PIN CODE, page 37.)
3. Press **#** then **\*** while the system announces the time and date.

You will hear sounds in the room where your base unit is installed. After 15 seconds, the answering system returns to the Command Waiting mode.

4. Press **#** then **\*** to monitor the room for another 15 seconds. Or, select another remote function. Hang up to exit the system. The answering system automatically returns to Standby.

### QUICK REFERENCE CHART

If your phone is not performing to your expectations, please try these simple steps before calling Uniden customer service at **(800) 297-1023**.

PROBLEM	SUGGESTION
<p><b>The charge light won't come on when the handset is placed in the base.</b></p>	<ul style="list-style-type: none"> <li>• Make sure the AC adapter is plugged into the base and wall outlet.</li> <li>• Make sure the handset is properly seated in base.</li> <li>• Make sure the charging contacts on the handset and base are clean.</li> </ul>
<p><b>The audio sounds weak and/or scratchy</b></p>	<ul style="list-style-type: none"> <li>• Make sure that the base antenna is in a vertical position.</li> <li>• Move the handset and/or base to a different location away from metal objects or appliances and try again.</li> </ul>
<p><b>Can't make or receive calls.</b></p>	<ul style="list-style-type: none"> <li>• Check both ends of the base telephone line cord.</li> <li>• Make sure the AC adapter is plugged into the base and wall outlet.</li> <li>• Disconnect the AC adapter for a few minutes, then reconnect it.</li> <li>• Place the handset back on the charging cradle for a few seconds. The <b>status</b> LED blinks indicating that the phone has been reset.</li> </ul>
<p><b>The handset doesn't ring or receive a page.</b></p>	<ul style="list-style-type: none"> <li>• The Nickel-Cadmium battery pack may be weak. Charge the battery on the base for 15-20 hours.</li> <li>• Be sure the antenna is in a vertical position.</li> <li>• The handset may be too far away from the base. Place the base away from appliances or metal objects.</li> <li>• Place the handset back on the charging cradle for a few seconds.</li> <li>• The <b>status</b> LED blinks indicating that the phone has been reset.</li> </ul>

# SPECIFICATIONS

YOUR NEW PHONE

## GENERAL

The EXS 9660 complies with FCC Parts 15 and 68.

Frequency control: PLL

Modulation: Direct Sequence Spread Spectrum; DBPSK

Operating temperature: 0° to +50° C (+32° F to +122° F)

## BASE UNIT

Frequency: 904.2 to 925.8 MHz (20 channels)

Power requirements: 10V 500 mA (from AC adapter)

Size: 7-3/8 in.(W) x 3-1/2 in. (D) x 8-3/4 in. (H)

Weight: Approx. 110.9 oz. (including optional battery)

## HANDSET

Frequency: 904.2 to 925.8 MHz (20 channels)

Power requirements: Rechargeable Nickel-Cadmium battery pack

Size (without antenna): 2-1/4 in. (W) x 1-3/4 in. (D) x 7-1/4 in. (H)

Weight: Approx. 9.3 oz. (including battery)

Battery: BT-990

Capacity 600 mAH, 3.6V

Talk mode 4 hours

Standby mode 7 days

*Specifications, features, and availability of optional accessories are all subject to change without prior notice.*

## Free Manuals Download Website

<http://myh66.com>

<http://usermanuals.us>

<http://www.somanuals.com>

<http://www.4manuals.cc>

<http://www.manual-lib.com>

<http://www.404manual.com>

<http://www.luxmanual.com>

<http://aubethermostatmanual.com>

Golf course search by state

<http://golfingnear.com>

Email search by domain

<http://emailbydomain.com>

Auto manuals search

<http://auto.somanuals.com>

TV manuals search

<http://tv.somanuals.com>