

User's Guide
for
NovaJet® PRO 600e Printers
Americas Edition P/N 210131-2 Rev. C
(text P/N 210636-1)

Copyright ENCAD, Inc. 1998

NOVAJET®, ENCAD® and Quality Imaging Supplies™ are trademarks of ENCAD, Inc.

Macintosh is a trademark of Apple Computer Corp.

Other trademarks are the property of their respective owners.

Except as provided below, no part of this manual may be copied or distributed, transmitted, transcribed, stored in a retrieval system, or translated in any human or computing language, in any form or by any means, electronic, mechanical, magnetic or otherwise, or disclosed to a third party without the express written permission of ENCAD, Inc., 6059 Cornerstone Court West, San Diego, CA 92121, U.S.A.

Certain manuals are distributed by ENCAD in an electronic format on CD-ROM or over the internet. The registered user of an ENCAD product whose manuals is distributed in this fashion may print one copy for their personal use only.

REVISION HISTORY

Rev. A	April 1998
Rev. B	June 1998
Rev. C	July 1998

WARRANTY CLAIMS

United States

ENCAD® , Inc., warrants its printers (“PRODUCT”) to be free from defects in workmanship and materials for a period of one year from the date of purchase. In order to submit a Warranty claim, please contact the ENCAD Help Desk at (619) 452-4350.

ENCAD reserves the right to make changes or improvements to Products, without incurring any obligation to similarly alter Products previously purchased.

Buyer’s sole and exclusive rights pursuant to this Warranty shall be for the repair or replacement of defective Product. ENCAD specifically disclaims any and all other warranties, expressed or implied, including but not limited to, implied warranties of merchantability and fitness for a particular purpose. In no event shall ENCAD be liable for any loss of profit or other commercial damages, special, incidental or consequential damages, or any other damages or claims, whatsoever.

This Warranty gives Buyer specific legal rights, and Buyer may also have other rights that vary from state to state.

This Warranty applies only to printers purchased from ENCAD, or authorized ENCAD distributors or dealers. The intent of this Warranty is to repair or replace defective Products subjected to normal wear and tear, when operated according to ENCAD instructions.

This warranty does not cover damage to the Product resulting from the following:

- **Accident or negligence.**
- **Unauthorized modification of the Product.**
- **Adverse environmental conditions.**
- **Service of the Product by other than an ENCAD authorized service provider.**
- **Unauthorized or improper use, including but not limited to:**
 - **Use in applications for which the Product was not designed.**
 - **Using cartridges, ink, or media other than ENCAD QIS PRO 600e products.**
 - **Lubricating any part of the printer.**

Internationally: Contact your dealer or distributor for warranty information.

Extended Warranty: An extended warranty is available for your ENCAD printer. Contact your dealer/distributor or ENCAD for further details.

FCC Statement (U.S.A.)

The United States Federal Communications Commission has specified that the following notice be brought to the attention of users of the ENCAD printers.

FEDERAL COMMUNICATIONS COMMISSION RADIO AND TELEVISION INTERFERENCE FOR CLASS B DEVICE

Statement

This equipment has been tested and found to comply with the limits for a Class B digital device, pursuant to Part 15 of the FCC Rules. These limits are designed to provide reasonable protection against harmful interference in a residential installation. This equipment generates, uses, and can radiate radio frequency energy, and if not installed and used in accordance with the instructions, may cause harmful interference to radio communications.

User Instructions:

If the equipment does cause harmful interference to radio or television reception, which can be determined by turning the equipment on and off, the user is encouraged to try to correct the interference by one of the following measures:

- Reorient or relocate the receiving antenna.
- Increase the separation between the equipment and receiver.
- Connect the equipment into an outlet on a circuit different from that to which the receiver is connected.
- Consult the dealer or an experienced radio/TV technician for help.

Changes or modifications not expressly approved by ENCAD, Inc. could void the user's authority to operate the equipment.

Note: This product was FCC certified under test conditions that included the use of shielded I/O cables and connectors between system components. To be in compliance with FCC regulations, the user must use shielded cables and connectors and install them properly.

VDE Statement

Hiermit wird bescheinigt, daß der Drucker in Übereinstimmung mit den Bestimmungen der BMPT-AmstbIVfg 234/1991 funktionsstört ist. Der vorschriftsmäßige Betrieb mancher Geräte (z.B. Meßsender) kann allerdings gewissen Einschränkungen unterliegen. Beachten Sie deshalb die Hinweise in der Bedienungsanleitung.

Dem Zentralamt für Zulassungen im Fernmeldewesen würde den Inverkehrbringen dieses Gerätes angezeigt und die Berechtigung zur Überprüfung der Serie auf die Einhaltung der Bestimmungen eingeräumt.

Industry Canada

This Class B digital apparatus meets all requirements of the Canadian Interference-Causing Equipment Regulations.

Cet appareil numérique de la classe B respecte toutes les exigences du Règlement sur le matériel brouilleur du Canada.

Material safety data sheet

To obtain information on the proper use, handling, and disposal of any ENCAD QIS ink, consult the material safety data sheet included in the ink kit or obtain a copy from ENCAD, Inc. at:

6059 Cornerstone Court West
San Diego, California 92121-3734
(619) 452-4350

International users should contact their local dealer or distributors.

General Operating Safety

The use of a <HAR> cord set (rated 10A, 250VAC) with the proper plug configuration for the country where the device will be used, is required for continued safety compliance.

Ein harmonisiertes (<HAR>) Netzkabel (min. 10A, 250V~) mit dem vorgeschriebenen Netzstecker für das entsprechende Land in dem das Gerät installiert wird, ist unbedingt notwendig für die elektrische Sicherheit.

El uso de cable poder <marcado HAR> (capacidad de 10A, 250V~), con el enchufe apropiado para el país donde se use el producto, es requerido para acatamiento de seguridad eléctrica.

L'emploi d'un cordon surmoulé <HAR> (estimé 10A, 250V CA) avec la configuration de la fiche convenable pour le pays où l'appareil sera utilisé, est exigé pour la conformité à la sécurité continuée.



Other reference materials

In addition to this User Guide, the following additional guides are included with your printer:

Quick Start - Tells you how to assemble and install the printer's hardware.

Software Drivers - Readme files on the driver CD-ROM contain information for installing and using the various drivers and utilities on the CD-ROM.

Manual conventions

-  Indicates a procedure for you to follow in order to perform a specific function. Read the accompanying explanatory text before following the step-by-step procedure.
-  Indicates a warning. Ignoring the warning can damage the printer or result in an unsatisfactorily printed image.
-  Indicates a tip or suggestion that can make using the printer easier or improve your printed images.

Manual organization

It is not necessary to read this manual from cover to cover. Reading Chapters 1 through 3 will give you an understanding of printer's basic operation. Your particular needs will determine how you use the rest of the guide.

Chapter 1 Introduction - Introduces the printer and provides basic guidelines for getting the best print quality.

Chapter 2 Getting started - Describes the printer's components and explains the basic steps needed for using the printer after it has been assembled and connected to your computer. Includes procedures for installing and priming ink cartridges and loading media.

Chapter 3 Setting printer options - Explains how to use some of the printer's features.

Chapter 4 Maintenance - Includes instructions for periodic maintenance functions such as refilling ink reservoirs, replacing ink cartridges, and periodic cleaning of the ink cartridges and service station.

Appendix A Calibration - Explains what to look for in the calibration plots and how to make the adjustments.

Appendix B Installing additional memory - Explains how to install additional memory in the printer.

Appendix C Menu tree - Explains the menu structure.

Appendix D Technical information - Lists the technical specifications for printer.

Appendix E Serial Communication and cabling - Provides the printer's serial cable requirements and details on setting serial communication parameters.

Appendix F Error messages

Appendix G Glossary

Appendix H Supplies - Includes a complete list of ENCAD media, ink, cartridges, and spare parts and information for ordering supplies for your printer.

Appendix I Troubleshooting - Provides answers to commonly asked questions and solutions to typical problems.

Contents

Chapter 1 Introduction 1-1

Printing with NovaJet PRO 600e printers	1-1
Obtaining quality results	1-2
Nine Factors that Affect Print Quality	1-5

Chapter 2 Getting started 2-1

Using the control panel	2-1
Choosing menu functions	2-2
Setting the language	2-2
Loading media	2-2
Using the power media feed and take-up system	2-3
Using the take-up roll	2-4
Moving the carriage	2-5
Installing the cutter	2-5
Filling the ink reservoirs	2-6
Priming the ink delivery lines.....	2-8
Printing the color test	2-10
Printing the prime pattern	2-11
Aligning the ink cartridges	2-13
Cartridge recognition	2-15
Pausing the printer	2-16
Canceling a print	2-16
About print drivers.....	2-16

Chapter 3 Printer options 3-1

Returning to the default settings	3-1
Printing the settings	3-1
Choosing print mode options.....	3-1
Important notes about image size vs. dpi	3-3
Print passes	3-4
Choosing paper options	3-5
Save Media	3-9
Choosing ink options	3-11

Chapter 4 Printer maintenance and storage 4-1

Periodic maintenance	4-1
Changing ink types	4-2
Removing and storing ink cartridges	4-2
Replacing the reservoirs	4-4
Installing new cartridges	4-5
Purging ink delivery lines	4-5
Periodic cleaning.....	4-6
Cleaning the service station.....	4-8
Maintaining the NovaPrime	4-9
Preparing your printer for transport or storage	4-9
Returning the printer for service	4-9
Accessing printer information	4-9

Appendices

A Calibration	A-1
B Installing additional memory	B-1
C Menu tree	C-1
D Technical information	D-1
E Serial cable	E-1
F Error messages	F-1
G Glossary	G-1
H Ordering Supplies	H-1
I Troubleshooting	I-1

Index

This user guide covers the NovaJet PRO 600e printers.



NovaJet PRO 600e printers are wide-format color inkjet printers that give you professional-quality output with all the brilliance and gloss of liquid ink. For signmakers, service bureaus, photographic services, creative and business professionals, ENCAD printers let you experience the value of exceptional graphics quality. The NovaJet PRO 600e printers cut hours of production time, while giving you the dramatic impact of high fidelity images.

NovaJet PRO 600e printers are being used for many types of printing needs:

- Posters
- Signs
- Imposition proofing
- Banners
- Packaging prototypes
- Point of purchase
- Exhibits
- Displays
- Fine art

Printing with NovaJet PRO 600e printers

The NovaJet PRO 600e wide format inkjet printers lets you create printed pieces the length of a roll of media (100' or more). Only *Extreme Color Printing* combines the technical sophistication of the NovaJet series with the unique qualities of ENCAD QIS inks and media, which includes coated canvas, vinyl, film, paper, and more.

These printers feature a continuous-feeding ink system which uses 500ml reservoirs for each color, so you never have to worry about running out of ink halfway through a big print job. Before starting a print job, just look at the transparent plastic reservoirs to check the ink supply. When the ink supply is low, just open the cap and refill. In addition, the printer features a dual ink system, which makes fast work of switching from one type of ink to another.

The printers accept raster-oriented data in the form of HP RTL format. In this mode, printing begins immediately after the first complete line of HP RTL data is received. Depending on the software used, millions of colors are possible, yielding superb results for continuous-tone images or 3D renderings.

If your applications do not support HP RTL, there are several software utilities available to convert various raster file formats (TIFF, GIF, BMP, etc.) into HP RTL. There are also more than 50 Raster Image Processors (RIPs) which convert Postscript or CGM to HP RTL. When choosing a RIP or a file format converter for output to the printer, make sure it has the features you need. (Contact your ENCAD distributor or dealer for an up-to-date listing.)

Obtaining quality results

You have probably seen a demonstration of your printer's capabilities or sample output. If so, you are aware of the superb color graphics which can be obtained, and the variety of papers and films you can use. Note, however, that to obtain high-quality results, you must consider several factors. Follow the simple guidelines in the sections that follow to obtain excellent results.

Use the right inks and media

ENCAD's commitment to Extreme Color encompasses media, ink, and cartridges. A team of color scientists and media specialists work with world class ink and media manufacturers to develop supplies that are scientifically matched to the NovaJet PRO 600e printers. Used together, the ENCAD inks and media provide the widest color gamut available, making our Quality Imaging Supplies ideal for applications from proofs to presentations.



ENCAD inks and media give you optimal image quality through:

- Scientifically matched ink and media
- Ultra-wide color gamut or process standard
- Wide range of media: matte paper, photo paper, film, vinyl, canvas, etc.

Three types of inks are offered: Graphic Arts (GA), Graphic Standard (GS), and Graphic Outdoor (GO). Choose the right ink for your application.

GA (Graphic Arts) QIS Inks™ combined with scientifically matched Quality Imaging Supplies™ (QIS) Media, let you create images so vivid, you have to see them to believe them. In fact, the GA QIS Ink color gamut not only encompasses SWOP (Standard Web Offset Printing), for press-quality color graphics, but it goes far beyond. Its ultra-wide color gamut allows you to reach to the limits of your creativity.

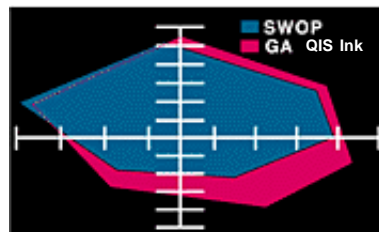



GS (Graphic Standard) QIS Inks™ give you high-quality, photo-realistic images. Your indoor signs, posters, banners, and backlit graphics will leave a lasting impression. You also get superb image quality when you combine these inks with Quality Imaging Supplies™ (QIS) Media, guaranteed. The GS QIS Ink color gamut comes very close to SWOP (Standard Web Offset Printing), for press-quality color graphics, versatility, and easy color calibration.

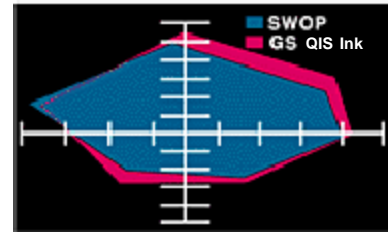

GO (Graphic Outdoor) QIS Inks™ bring an entirely new level of color and image quality to the outdoor graphics industry and offers complete compatibility with industry standards. Getting consistent inkjet quality for outdoor applications requires a carefully coordinated approach - the Graphic Outdoor Matched System. Inks, media, and laminates are all scientifically matched to each other and to your printer.

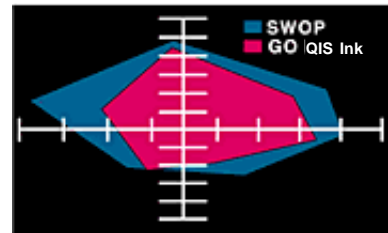

Caring for your ink and cartridges

- ! Handle cartridges only on the plastic areas. Touching the copper electrical interconnect or the inkjets can damage the cartridge.
- Be sure the ink in the cartridges matches the ink in the reservoirs.
- Do not mix inks.
- Do not shake ink refill containers.
- Store ink and cartridges in the same environment as the printer whenever possible.
- Removing cartridges may result in loss of negative pressure and cause the cartridge to leak through the jet plate. If you remove a cartridge from the printer, do not leave it exposed to the air for an extended period because the jets may clog. Replace the original tape on the jet plate. Place the cartridge in a cartridge garage or sealed plastic bag and store it in a closed area at room temperature. Keep it out of direct sunlight.
- Open new cartridges only when you are ready to install them.
- Use only ENCAD-brand ink refills and cartridges.
- Be sure to connect cartridges to reservoirs which contain the same color and type of ink originally in the cartridge. (For example, if the cartridge contained PRO 600e GS cyan ink, use it only with PRO 600e GS cyan ink.)
- Drawings containing both black and color elements require alignment of the cartridges to each other. See Appendix A for details.

Choose the right media

You can rely on ENCAD QIS Media for rich, vivid images across the entire color spectrum. QIS Media is specially formulated to demanding specifications, strict performance criteria, and uncompromising quality controls. This assures superb interaction with QIS Ink and flawless performance with the printer.

ENCAD offers a wide range of sheet and roll media and is always adding new products. Check with your authorized ENCAD supplies dealer for the latest offerings. The chart that follows gives you an idea of the various media types and their potential uses. See the Source Book for current media types.

Job	Media
Indoor signs	Vinyl
Outdoor signs and banners	GO media and overlaminates; be sure to use with GO inks Polyethylene Banner Reinforced Vinyl Tyvek Wet Strength Paper Water Resistant Vinyl
Backlight displays	Backlit Display
Client, courtroom or marketing presentations Photo-realistic images Point-of-purchase signs Posters Trade shows	Photo Gloss and Semi-Gloss Premium Matte Specialty Matte Vinyl Ultra White Film Backlit Display GO media, including Tyvek and Vinyl
Color maps Flip charts Renderings	Premium Matte Specialty Matte
Art specialty	Canvas
Check prints Working drawings	Presentation Bond 24#

Caring for your media

Store media in its original packaging in a cool, dry area until you are ready to use it. The environment should be stable; i.e., no extremes of heat and cold, and non-condensing humidity. If conditions are outside the operating ranges recommended for the printer, allow the media to acclimate in the operating environment for at least 48 hours before using it.

If you remove a roll of media from the printer, be sure to store it in a manner which keeps it clean and dust-free. Ideally, you should return it to its original packaging for storage.

Print on the correct side! Roll media is wound with the coated side out. Cut sheet media has an ink-receptive and a non-ink-receptive side. The sheets are notched to help you orient them correctly. To assure that you print on the correct side, be sure that the notch is in the upper right corner when you feed the sheet into the printer.

Handle with care! Handle your media carefully to avoid creases, scrapes, and tears. Avoid crushing or damaging roll media edges.

Wear cotton gloves! Film-based and photographic paper-based media are susceptible to absorbing skin oils. Fingerprints on the media prior to printing may result in visible fingerprints after ink is applied.

Choose the correct printing mode

There are five printing modes, giving you freedom to tradeoff drawing quality and speed. When printing heavier renderings, maps, or art graphics, choose one of the enhanced printing modes.

Use the right software

The quality of the software driver or the RIP can be very important, especially when printing continuous tone images or 3D renderings. Error diffusion or stochastic screening algorithms can yield photo-like images, even when these images are scaled to full size. Software without advanced imaging features may produce images which are grainy when enlarged.

Nine Factors that Affect Print Quality

Understanding all the factors that contribute to print quality is the only way to ensure perfect printing each and every time. This section details nine important factors; by controlling them, you can achieve the very best print quality possible.

Most important, and often overlooked, is the process of matching output print quality to customer expectations of print quality. Before beginning any inkjet print job, you must have a clear understanding of what the customer expects. Inkjet printing has certain limitations and depending on the print process you employ, inkjet printing can produce a wide variety of print qualities. High quality printing costs more to accomplish. Before embarking on any print task, discuss with the customer what their expectations are and what they are willing to pay for. Then and only then, set upon the task of achieving the pre-determined print quality you both expect.

1. Use the highest quality type of image possible.
2. Check to make sure the image is in focus and exposed properly.
3. Scan it with the best scanner possible.
4. Scan it at the proper resolution.
5. Color correct and sharpen the image with software.
6. Ensure your color profile accurately reflects the exact ink and media you are using.
7. Use the best diffusion pattern available in your RIP.
8. Use only the best possible ink and media combinations.
9. Make sure your cartridges are aligned and firing properly.

1. Original Image Type

The type of original image will determine the quality of your final inkjet print. The best image type is an original transparency (not a duplicate). They are extremely crisp with superb edge definition. Print film photos are not as good as they are already one generation removed from the original film. Also, because of the emulsion process of photo prints, edge definitions tend to be lost. Color prints can be used, but they have to be of very good quality to produce acceptable scaled prints. Digital photo files are newest image type. Many are unacceptable for large-format printing as they contain only a small fraction of the information contained in a film transparency.

For example, most digital cameras can only create a 1 MB file. This is not enough information for large inkjet prints. A file must be at least 10 - 12 MB for a fair print and 30 - 50 MB for a good E-size print (see scanning section). Only the best commercial digital cameras can achieve these files sizes. Digital files from other sources such as CD stock photography are usually created from scanned transparencies, so may be suitable for inkjet printing. Check with the manufacturer to ensure that the images are at least 10 - 12 MB and were created from drum-scanned transparencies.

The better CDs have images of 28MB or more stored in a TIFF format. These are preferable for great quality prints. If you use a file stored in PhotoCD format, make sure you use the highest resolution available. Images stored in compressed files such as JPEG, LZW, GIF, etc. can lose valuable data during the compression process. Avoid images stored this way if possible. If you have to use a compression file format for whatever reason, use JPEG. It is closer to a “lossless” compression.

2. Original Image Clarity and Color

The quality of the original photograph, transparency, or digital file plays a key role in final print quality as this is where the clarity and color of the image is created. If the original photographer took a picture that was not in focus, or was fuzzy for any reason, sharpening or after-effects cannot correct it and a poor inkjet print will result. Differences in film, speed, grain, or developing process can also affect quality of prints. If the image was too dark or too light, color correction cannot correct it and a poor inkjet print will result. The axiom of “garbage in, garbage out” applies to all printing, including inkjet printing. Companies that utilize a lot of photography for large-format inkjet printing should check for focus by using a loupe. If you have a good, in-focus original, you can maintain the image quality throughout the entire process.

3. Scanner Type

How you get the original image into the computer is important to the overall printing process as scanner quality varies greatly. Using a scanner that meets the requirement of the overall print quality is essential to have enough color fidelity and edge clarity. An image scanned with a low end scanner will lose detail, clarity, and color. It is important that you understand what type of image quality is required for your print and use the right scanner to achieve it.

Traditionally, drum scanners are ideal for retaining the best edge definition and color depth. If the original image is poor, an expensive drum scan may be a waste of money. Almost all service bureaus use drum scanners.

Flatbed scanners require an optional transparency adapter to scan transparencies.

4. Scan Resolution

Scanning the original at low resolution will degrade the large-format inkjet print quality. Scanning at resolution which is too high slows down the RIP and adds no quality to the image. Consequently, choosing the right resolution for the output print size (and thus, the amount of scaling needed after scanning) will determine what the optimum resolution is for each image.

The quality of the image you would like to produce is determined by the the final output size and the file size. For example, if you want output a 36" x 36" image, the file size will be approximately 24MB for a fair-good quality image (75dpi), 43MB for a good-very good quality (100 dpi) and 97MB for an excellent quality (150 dpi) print.

Your service bureau can help you determine the optimum resolution to scan your image based on the size and quality of the image you would like to print.

DO NOT USE INTERPOLATED RESOLUTION OF YOUR SCANNER TO COMPUTE IMAGE SIZE

Most 300 dpi scanners can interpolate or “imitate” 600 dpi scanning. This is really not really scanning at 600 dpi and will degrade the image quality. When scanning, ensure that you are using the scanner's true optical resolution, not its interpolated resolution. Scanning at the highest optical resolution (300 dpi) is better than scanning at the scanner's highest interpolated resolution (600 dpi).

5. Post Scanning Color Correction and Sharpening

All scanned images, even those scanned on expensive drum scanners, must be color corrected and sharpened before using them for a large-format inkjet print. If you are using a service bureau for scanning images, their scanner operator will usually do this as part of the scanning fee. However, you should always check the image before using it. Although the process of color correction and sharpening are more detailed than can be explained within this document, the following outline will give you a good grasp of what is required:

Color Correction - all scanners give the image a slight color cast during the scanning process. This happens because all light sensing devices have a slight bias. The easiest way to correct most of this color cast is to use a function such as Auto Levels in PhotoShop. This function finds the whitest pixel and the darkest pixel in an image and distributes all colors in-between. This works well on 75% of all images that are properly exposed. In very dark night scenes or in very white snow background scenes, Auto Levels does not work properly and the correction must be made manually using histogram adjustments.

Sharpening using UnSharp Mask - all scanned images, even images scanned on the most expensive drum scanners, need to be sharpened. The best digital tool to do this with is a function called an unsharp mask (available in programs such as PhotoShop). An unsharp mask basically redefines the edges of images by adding a mask. Most unsharp mask tools allow you to set the pixel width of the mask and the amount of sharpening. A good start is to use a pixel width of

3 - 5, with an amount of 75%. Too much unsharp mask will give the whole image a hard, pixelated look. A little more unsharp mask can be used with inkjet images as they are somewhat diffused in the printing process, hiding any small amounts of oversharping.

6. RIP Color Profile

The engine that converts your image into a series of C, M, Y, K dots is called the Raster Image Processor or RIP. Before it can actually create these dot patterns, it must first adjust for the colors of the inks, color of the media, dot volume of the cartridges on a particular machine, and the humidity/temperature of the environment on the day of printing (as this affects how far the ink will spread or dot gain). Most RIPs include what is commonly referred to as a color profile or color link. Usually, this profile is automatically used when you choose the media and ink within the software. However, color profiles are created in the factory with new cartridges in a clean and average environment. If you have older cartridges, media that was stored in sunlight for 6 months, and the humidity is 88%, the standard color profile may not give the best result. In this case, a new color profile may need to be created. Most professional RIPs today have this as an optional process. If your RIP cannot make a change, you can use an image editing program such as PhotoShop and re-RIP the image. Make sure your color profile delivers the colors and quality you need.

7. RIP Diffusion/Dither Patterns

Images that are going to be printed on an inkjet printer are eventually divided into C, M, Y, K and rasterized into dots using patterns that cause the eye to see a continuous tone image. These patterns are called many things, such as frequency modulated screening, diffusion patterns, dither patterns, screen patterns, etc. There are various types of screening that are better for photographic images. Stochastic screening was developed specifically for the CMYK process to avoid the problem of visually perceptible banding that occurs with other pattern types. It does this by pseudo-random placement of dots. Variations of the stochastic strategy have evolved into even better patterns. Each RIP manufacturer uses different names to describe its particular variation on the stochastic theme. To get the best print quality, make sure you are using the best possible diffusion pattern available from the RIP software you are using. Also remember that a different diffusion pattern should be used for spot color objects (such as filled vector objects). If you are printing an image that contains both photographs and spot color objects, use the diffusion pattern designed for photos.

8. Ink and Media

Using the right ink and media is a much bigger factor in print quality than most inkjet users realize. It takes many months of using a printer before a user begins to understand what an exceptional print looks like. Then and only then can they fully appreciate what quality materials and inks can do. Inks must be developed specifically for a particular head, otherwise, cartridge reliability will be severely reduced. ENCAD inks are specifically developed for ENCAD cartridges, printers, and media. These inks create the perfect ink drop shape, trajectory, and landing shape when used with ENCAD cartridges. The media controls the color, dot gain, and durability of the final print. As the ink must chemically interact with the media, only medias developed specifically for a particular ink can achieve the perfect dot shape that leads to improved image quality. Additionally, the chemical bond created through co-developed inks and medias is much better than independently developed inks and medias. Although many people will not be able to visually perceive differences in quality inks and medias initially (poor inks and medias show more pronounced visual defects), a less-than-optimal image quality, image color, or image durability will likely develop over time. Chemical compatibility between inks (made for a specific head technology) and medias is a key, and often overlooked ingredient to print quality.

9. Cartridge Preparation and Alignment

The single most overlooked factor in image color accuracy and quality is cartridge alignment. Even if you carefully control factors 1 through 8, a printer with poor cartridge alignment or unmaintained heads can severely deteriorate image quality. Cartridge maintenance and alignment are key to producing images that exhibit the best of what a printer is capable of. Printer wiping stations must be kept clean so that heads stay clean. Cartridges need to be aligned and checked to be sure that all nozzles are working properly. Use a loupe to evaluate the registration of test patterns to achieve the best possible accuracy. Whenever you adjust, move, or replace a cartridge, take the time to realign the cartridges. Alignment errors of a single pixel (or single digit in the alignment process) will affect both color and image quality.

This page is intentionally blank.

This chapter gives you details on setting up your printer and using the functions available on its panel.

Before you start, be sure that:

- all packing materials have been removed from the carriage
- the power cord is plugged in
- you have connected your printer to your computer using either a parallel (IEEE 1284) or ImageWriter II serial cable or network controller
- the printer is turned on before attempting to print
- driver software and color links are installed. Refer to the Readme files on the driver CDs provided with your printer. Details on using the drivers are contained in the PC and Mac Connectivity Guide.

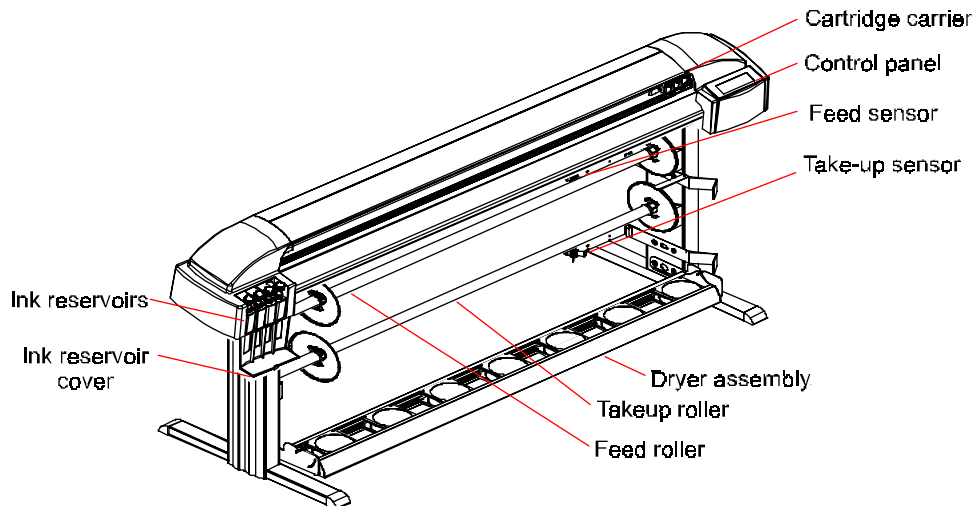

Using the control panel

The control panel at the right side of the printer includes eight buttons and a display which indicates modes and settings. An overview is provided here so that you can load media and cartridges. Details on menu options are included in Chapter 3.

The menu tree in Appendix C summarizes all the printer modes and their functions.

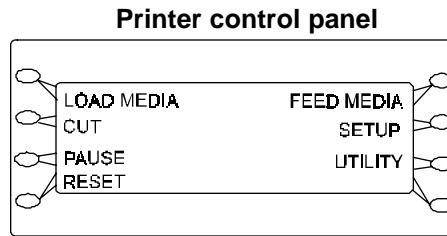

Two types of menus are displayed: action menus provide a list of additional menus or immediate tasks to perform. Selection menus let you view and modify values.

Choosing menu functions

To select a function, press the button adjacent to the function displayed.

The display will list options available for the selected function. Press the Next Option or Prev. Option buttons to view the selections. When the selection you want displays, press the button for the option and press OK.

Depending on the type of menu, you can return to the previous menu level by pressing the OK or Exit button. Press Exit consecutively to return to the main menu.

Press the Cancel button to restore the previous setting and exit the menu.

Setting the language

Your printer can display menu items and messages in English, German, French, Italian, Portuguese, Spanish, Korean, Japanese and simplified and traditional Chinese.



To choose a language

- 1 Press Setup/User Settings/Language and the button for the language you want.
- 2 Press OK.

Loading media

You can use either roll media or cut sheets; the default is roll media. To ensure straight paper loading and to avoid skewing, be sure to hold the media parallel to the platen line. Use the load lines on the platen as a guide to correctly load media. The printer includes sensors which detect the presence of media and activate the feed and take-up mechanisms.

The roll media core must have an inside diameter of 2" and the roll media maximum outside diameter of 6". If your media core has an inside diameter of 3", use the core adapter included. If you plan to store prints on the take-up roll, you may want to have extra cores available. They can be ordered from your ENCAD supplies dealer.

- ! **IMPORTANT!** Depending on the model, the printer can use media up to 60" wide. The rolls can be heavy, so you may want to have someone help you to load them. Before starting, be sure that you have a take-up roll core available which is the same width as the media you are loading.
- ! If your roll media has wrinkled or damaged edges, cut off the damaged part of the roll prior to loading to prevent the media from jamming in the printer.
- ! **IMPORTANT!** Be sure to use only ENCAD QIS media. Tests have shown that the use of non-ENCAD media can generate sufficient electrostatic discharge to cause shorting and damage to the LED display.

Using the power media feed and take-up system

The power media feed and take-up system facilitates long, unattended printing runs by automatically unwinding and rewinding media as prints are generated. It includes a feed roll, a take-up roll, and sensors which prevents media from coming into contact with the floor.

When the unit is first turned on, the feeder may turn for a few seconds. If the take-up turns, the sensor is blocked. Clear anything blocking the take-up sensor before proceeding.



To load roll media

- 1 Slide the rolled media onto the media (upper) roller, orienting it as shown below. Slide the paper guide into the roll core, and tighten the guide to secure the roll by turning the blue knob clockwise. Standing behind the printer, insert the media's leading edge into the back of the printer, aligning the paper edge with the alignment mark on the platen. The printer will sense the presence of the media and after the default 6-second delay, will automatically feed it.

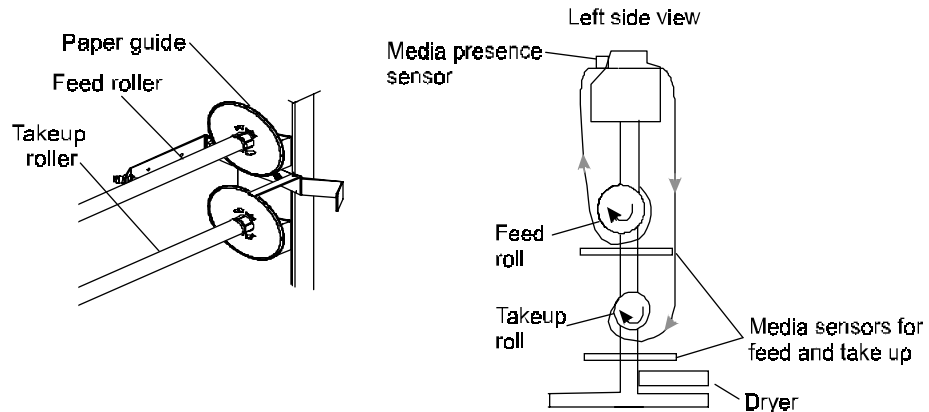

- 2 Press Load Media to move the media into printing position.
- 3 As printing progresses, media is looped down in front of the take-up core until it is detected by the sensor on the printer stand leg. The take-up rolls then activate to roll the media.

Be sure not to block the sensor!

Using the take-up roll

The take-up roll allows unattended printing by automatically winding printed media onto a core. In this mode, the automatic cutter is disabled. When using this option, be sure that the media sensor on the printer's right leg is not blocked.

Depending on the ambient humidity, temperature, and amount of ink coverage, you may want to turn on the dryer and/or set a dry time as described in Chapter 3. If you are using the dryer, position it so that the fans blow on the media.



To use the take-up roll

- 1 Set the printer to Take-up mode by pressing Setup/Paper Options Menu, Supply Type/Take-up, then press OK. This enables the take-up roll and disables the cutter.
- 2 Install an empty core onto the take-up guides. Be sure that the core width matches the width of the media you are using.
- 3 Slide the roll guide into the media core, and secure it by tightening the locking mechanism.

Since media cores can be shorter than the width of the media, position the media guide 1/8" from the end of the core and lock it into place.

- 4 Press Feed Media/Forward to advance enough media to allow its leading edge to come to the center of the take-up roll.

Using at least three pieces of tape, attach the leading edge of the media to the take-up roll at the left, right, and center of the core.

As printing progresses, the media is looped down in front of the take-up core until it is detected by the sensor on the printer leg. The take-up roll is then activated to roll the media.

Be sure not to block the sensor!

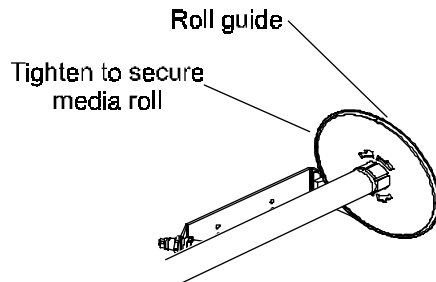

Note: If you are running narrow media, and depending on ambient temperature and humidity, you may want to set a dry time and/or turn on the dryer as described in Chapter 3 if you are running a long plot. Because of the print speed and the narrow media, the ink may otherwise not have sufficient time to dry before the media is rolled onto the take-up core.



To unload the take-up roll

- 1 Press the Cut button to cut the media.
- 2 Release the adjustable roll guide.
- 3 Slide the media and core out of the printer.



To load sheet media

- 1 Press Setup/Paper Options/Supply Type/Sheet. Press OK.
- 2 Load the sheet from the back of the printer, aligning it with the alignment mark on the platen.
- 3 Make sure that the media is flat and under the rollers. The printer will automatically sense the media's presence and load it until it reaches the start position on the platen.

Moving the carriage

When not in use, the cartridges rest in the service station at the right side of the printer. This device seals the inkjets to prevent them from drying out. **If power is turned on, always use the Utility/Access Cartridges button to move the carriage away from the service station so that you can install, change, adjust or clean the ink cartridges or the service station.**

Installing the cutter

You need to install the cutter if you want the printer to automatically cut the media after printing. Replacement cutters are available from your ENCAD supplies dealer.

- ! Be careful when handling the cutter to avoid injury.
- ! Do not use an external knife to cut media as this can damage the platen and prevent the media sensors from operating correctly.



To install the cutter

- 1 Press the Access Cartridges button to move the carriage to the left, out of the service station.

The cutter fits in the slot on the left side of the carriage. Install the cutter by inserting it into the carriage.

- 2 Push the cutter into the slot until it clicks into place.
- 3 Press the Access Cartridges button to move the carriage back into the service station. This ensures that the cutter blade is in the home position.

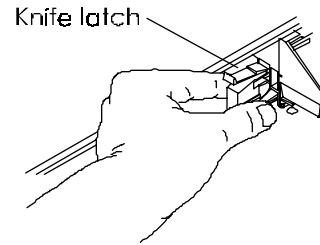

To remove the cutter

- 1 Press the Utility/Access Cartridges button to move the carriage to the center of the platen.
- 2 Press the knife latch down.
- 3 Pull the cutter out of the carriage.

When the cutter becomes worn, it can cause the carriage to jam or can cause a ragged media cut. In extreme cases, you might see an error message stating "Carriage Axis Failure".

You can order replacement cutters from ENCAD by calling 800-45-ENCAD, (619-677-5071) or fax ENCAD at 619-549-7894. Users outside the U.S. can call their local ENCAD dealer or sales center.

Filling the ink reservoirs

- ! Use of inks other than ENCAD NovaJet PRO 600e series ink may not give the desired results on finished prints.

The printer can support long, uninterrupted printing runs because of its extended ink capacity. The ink reservoirs are located at the printer's left side.

Note: When running at carriage speeds faster than the default, it is recommended that ink levels in the reservoirs be no more than 300ml (maximum).

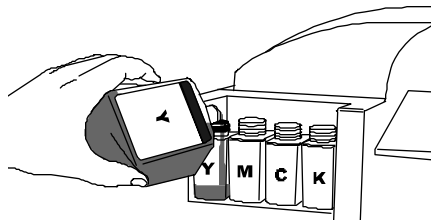



To fill the ink reservoirs

- 1 Open the cover on the left side of the printer to access the ink reservoirs. Unscrew the cap of one reservoir. Open only one reservoir at a time to prevent contamination with other inks.
- 2 Remove cap from the bottle.
- 3 Make sure the ink color and type matches the reservoir and pour in the ink. Do not put more than 375 ml of ink in the reservoirs or fill more than 1/2" from the top of the reservoir. Be sure to use the same type of ink (i.e., GA, GS, or GO) in all the reservoirs and ink cartridges. Be sure there is no excess ink on the reservoir cap. Replace the cap on the reservoir, being careful not to over-tighten it.
- 4 A complete second set of plumbing is provided with color-coded quick connect fittings for changing to another type of ink. **Be sure that each reservoir is connected to the same color fitting.**

The printer is designed to use only ENCAD PRO 600e series 208 jet cartridges. It is not compatible with NovaJet, NovaJet PRO, or NovaJet PROe cartridges. Use of other cartridges may damage the printer and/or prevent it from printing.

Be sure all cartridges and reservoirs use the same ink type; i.e., PRO 600e series GA, GS, or GO.

Note: Visually inspect each cartridge before installing it. Make sure the blue tape is intact on the jet area of the cartridge. **(Do not remove the tape at this time as the cartridge could leak! The tape will be removed later after negative pressure has been established by priming the ink delivery lines.)** Inspect the IC chip on the cartridge. Make sure it is secure and in approximately the location shown on the following figure. If any cartridge is damaged, contact your authorized ENCAD distributor/dealer for return/replacement of the defective cartridge.

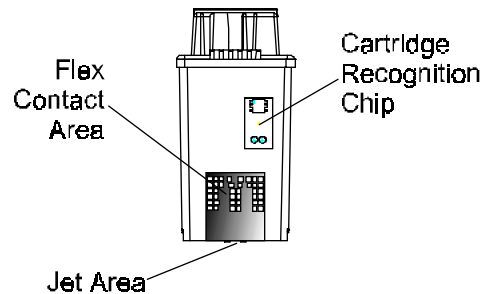

To install the ink cartridges

- ! **Do not touch the jet area or the flex contact area of the ink cartridge.**
 - ! **Work with only one ink color at a time to prevent contamination.**
- 1 With printer power on, press Utility/Access Cartridges to move the carriage to the position which allows replacement of the ink cartridges.

- 2 Cartridges are prefilled and preprimed. Remove the cartridge from the sealed bag and remove the shipping cap.

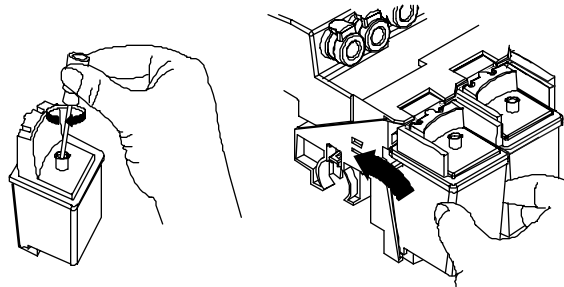

3. Install it bottom first into the correct slot on the carrier. **DO NOT REMOVE THE BLUE TAPE FROM THE JET PLATE.** Tilt the cartridge up until it clicks into place. Make sure the cartridge is firmly seated.

Priming the ink delivery lines

After filling the ink reservoirs, you will need to prime each of the four ink delivery lines to establish ink flow through the lines. The NovaPrime is provided for this purpose.

Be sure it has batteries in it before continuing.



This procedure needs to be done the first time you set up the printer and whenever ink cartridges are replaced. It is not necessary when refilling the reservoirs.

When filling more than one color of ink, be sure to thoroughly rinse and wipe any excess ink from the NovaPrime before working with the next color to avoid the possibility of contamination.



To install tube needle assemblies and prime delivery lines

- 1 Snap the tube needle assembly connector into the fitting on the carrier. Insert the needle into the small hole on the NovaPrime. There are two connectors for each cartridge - one is blue and the other is gray. Be sure that the tube needle assembly is plugged into the same color connector as the ink reservoir.

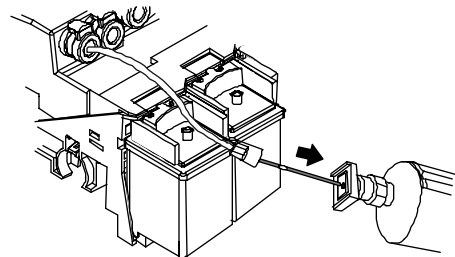

- 2 Press the button on the NovaPrime to activate the vacuum and draw ink from the reservoir into the needle.
- 3 When ink is visible in the NovaPrime sight tube, remove the cartridge needle from the NovaPrime and quickly insert it into the hole in the top of the ink cartridge. Be sure the needle is tightly connected by turning the fitting clockwise until finger-tight.
- 4 Gently tighten the fitting (about 1/4 turn) to prevent air leaks. Do not overtighten. Wait 20 seconds for the pressure to stabilize.
- 5 Remove the cartridge from the carriage and remove the blue tape from the jet area of the cartridge. **CAUTION! Do not tilt the cartridge up higher than a 30 degree angle. This could cause the cartridge to lose pressure.**

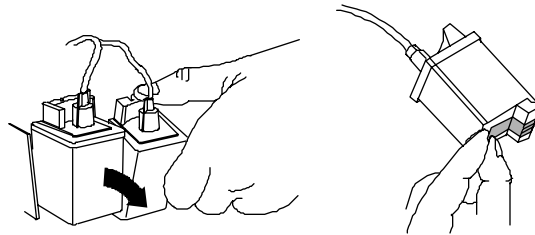
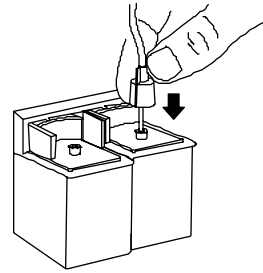

- 6 Rotate the cartridge one complete revolution counterclockwise to ensure that there are no twists in the ink delivery line.

Check for ink on the jet plate. Continuous bleeding of the jet plate indicates a loss of vacuum in the cartridge or an air leak in the lines. A small amount of ink can be cleaned off the jet plate by dabbing with a moist, lint-free cloth.

- 7 Insert the cartridge into the carriage.
- 8 Repeat with each cartridge.
- 9 Press Utility/Access Cartridges to return the carriage to the service station.
- 10 Print the color test, prime test pattern and paper axis test as described in the following sections.
- 11 If all colors look fine, go on to step 15. If any color drops out, prime cartridges as necessary, using the NovaPrime.

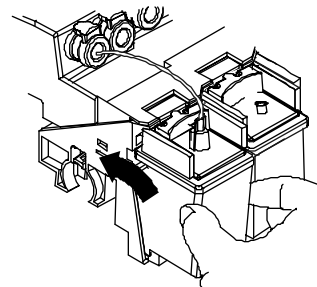

Place the suction end of the NovaPrime over the jet area of the cartridge.

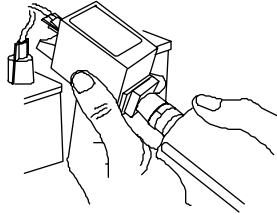

- 12 Make sure the Novaprime is making good contact with the jet area. Pulse the pump 3 - 5 times, until the ink is visible in the Novaprime sight tube. Maintain good contact between the inkjet plate and the pump for an additional 5 seconds.

When removing the NovaPrime, use the silicone tip to wipe and clean the jet plate. Remember to clean ink from the silicone tip before moving to the next cartridge.

- 13 Re-print the color test and prime test pattern. (The paper axis test is only required when changing media). Inspect to ensure proper pressure is maintained for each color.
- 14 Re-prime cartridges as necessary to remove clogs. Manually bypass (compensate) clogged jets as necessary.
- 15 Once all cartridges are working correctly, print the color deadband and color calibration test patterns as described in the section on *Aligning the ink cartridges* which follows.

Printing the color test

Printing the color test verifies a proper manual prime and that pressure is set properly.



To print the color test

- 1 Be sure media is loaded in the printer.
- 2 Select Utility Menu/Service Menu/Diagnostics/Color Test.
- 3 Change the color test percentage to 100% and press OK.
The test prints.
- 4 Verify that all bands print a solid pattern. This indicates that the cartridges were properly primed. If it doesn't print a solid pattern, run the color test again.

Printing the prime pattern

Before printing and at regular intervals during printing, the printer wipes the ink cartridge jets at the service station. This function is user selectable during printing or between prints. Still, ink cartridge jets can become clogged, especially with prolonged exposure to the air or with non-use. Printing the Prime pattern helps to clear the jets and to check that the ink cartridges fire properly. ENCAD recommends that you print the prime pattern daily to ensure the best possible print quality.

The printer includes a feature called Open Jet Detection and Compensation. This feature helps maintain optimal print quality and gives you the confidence to print long, unattended jobs. During multi-pass printing, the printer will automatically compensate for jets found to be electrically damaged. The only intervention needed is to verify that there are no clogged jets and then choose which print mode is most appropriate for your needs. This is done by printing the Prime test pattern and then setting the print mode accordingly.



To print the prime pattern

- 1 With media loaded, press Utility/Prime.
A test pattern prints. It should be smooth with no obvious banding.
- 2 If the printed results are unsatisfactory, run the test several more times to unclog the inkjet nozzles.



To interpret the Prime pattern

The test pattern consists of bands of color for each cartridge and a sloping line. Within the Prime test pattern, each jet is represented with a short horizontal line. Together, these short horizontal lines form a “stair step” pattern. Electrically defective jets appear as solid bars. Clogged jets appear as missing or misdirected lines in the “stair step” pattern. The print modes for which compensation is available are shown clearly above the Prime.

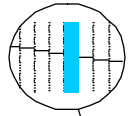
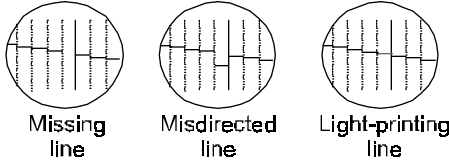

A solid bar indicates an electrically defective jet. Jet Compensation will automatically compensate for that jet.

A missing line or "gap", misdirected line, or a light-printing line indicates a clogged jet.

The CMYK header lets you know the available print modes that will provide compensation.

Y: 3, 4, 6, 8, M: 3, 4, 6, 8, C: -, 4, -, - K: -, 4, 6, 8

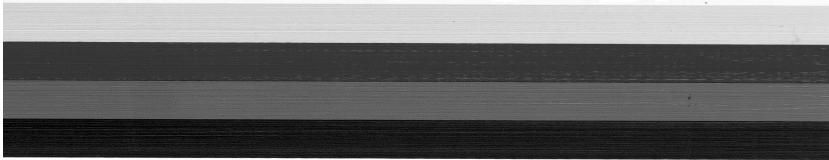
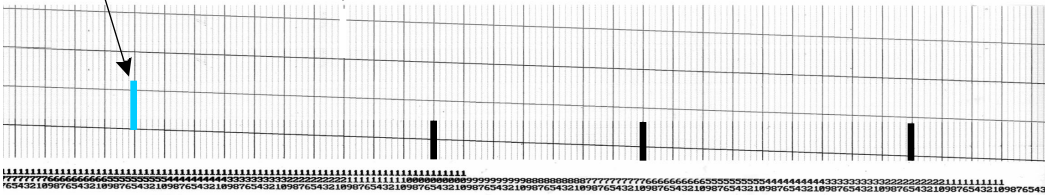

Clogged jets

If a jet is clogged, it will appear in the prime pattern as a gap in the sloping line for each cartridge.

Clogged jets cannot be automatically detected and therefore must be cleared manually. To clear a clogged jet, clean and prime the affected cartridge according to the instructions in Chapter 4. Your goal is to eliminate all gaps in the "stair step" pattern before starting your job.

In addition to the prime pattern, you can also print a jet status plot which lets you identify, by color, and number, individual jets that are clogged. You can then manually enter the jet numbers (by cartridge color) to initiate the compensation of the clogged jets. Jet compensation data is stored on the cartridge chip.



To print the manual jet compensation list:

- 1 From the main menu, select Utility Menu/Calibration Menu/Open Jet Menu/Print Jet List.

The jet status list prints as illustrated below, showing current jet compensation list by number for each cartridge.

Manual Jet Compensation List

```

Y: None
M: 1,3,10
C: None
K: 10, 21, 30, 128

```

- 2 To add a jet to the compensation list, press the button that designates the color of the cartridge where the jet resides.

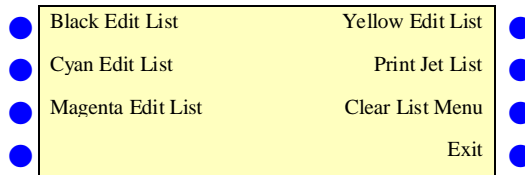

- 3 To compensate for a specific jet, press the button until the number of the jet is displayed. Then press the Toggle button to toggle the jet's status to on or off. Repeat for any other jets for which you need to compensate.
- 4 Press OK to accept the settings.

If you have manually compensated for jets in any cartridge, be sure to clear the compensation when a new cartridge is installed by pressing Clear List Menu.

Aligning the ink cartridges

Two tests are provided to help you align the cartridges: Color Deadband Compensation and Color Calibration.

Color Deadband Compensation provides a method for adjusting dot placement. In bi-directional printing mode, the velocity of the carriage causes dots to miss the target area on the media. The color deadband test pattern lets you check the velocity deadband values and adjust them for the best printing results. A loupe is provided in the accessory box to help you check the prints.

Color calibration aligns the inkjets of the cartridges to each other. Misalignment can result from small tolerance variations in cartridges during manufacturing and from cartridge alignment in the printer. Color test patterns let you check the horizontal and vertical alignment values and adjust them for the best printing results. A loupe is provided in the accessory box to help you check the prints.

You should perform Color Deadband Compensation before performing Color Calibration. Perform Color Deadband Calibration and Color Calibration each time a cartridge is replaced with a different cartridge. If you remove and reinstall the same cartridge, only Color Calibration needs to be performed.



To perform color deadband compensation

- 1 With paper loaded, press Utility/Calibration Menu/Color DB Test.
The test patterns print as shown below.

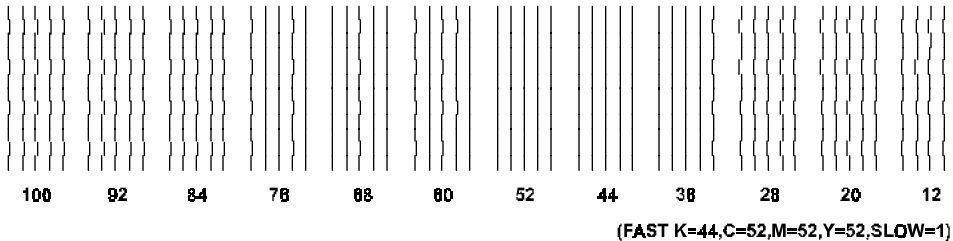

- 2 For each color, examine the vertical lines and select the straightest lines. Note the compensation number at the bottom of the lines you selected.
- 3 Existing compensation values are printed in the lower right corner of the test pattern. If any of these differ from the values you selected, enter new compensation values by pressing the button for the color deadband you want to change. Then use the Next and Previous option buttons to scroll to the desired compensation.



To perform color calibration

- 1 With paper loaded, press Utility/Color Calibration Menu/Calib Print Test.
The test patterns print as shown below.

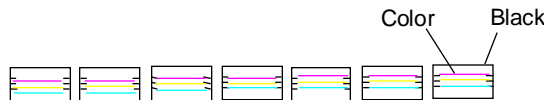

Horizontal head-to-head test pattern

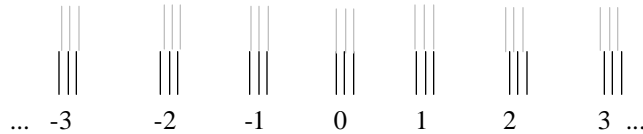

Vertical head-to-head test pattern

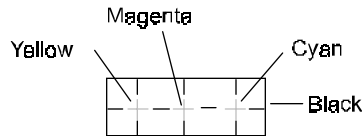

Current heads test pattern

Examine the registration + in the Current Heads Test Pattern. If they are in register, your calibration is correct. If not, perform the following steps to align the printer heads.

- 2 Press Cyan Adjust - Vertical.
- 3 Examine the Vertical Head-to-Head Test Pattern and enter the number that represents the best color alignment for cyan-vertical.
- 4 Repeat for each color and for horizontal alignment as well, using the Horizontal Head-to-Head Test pattern.

Cartridge recognition

The printer is designed to use only ENCAD NovaJet PRO 600e cartridges. To assure the best possible print quality and prevent potential damage to the printer, a Cartridge Recognition feature checks to ensure that four ENCAD NovaJet PRO 600e cartridges are installed, and that they are installed properly. Cartridge recognition is performed when a print request is received (i.e., image data, prime, etc.).

In addition to cartridge recognition, the printer automatically performs tests on the cartridges and uses the information to improve image quality, monitor cartridge life, and update the user with system status. Some tests are performed between prints and require no user input, while others require user input.

Cartridge-related error messages are listed Appendix F of the User Guide.

To clear a cartridge-related error, press Access Cartridges to move the carriage to the position which allows replacement of the ink cartridges. Check to make sure you have ENCAD NovaJet PRO 600e cartridges installed in each position, that they all contain the same type of ink (i.e. GA, GS, or GO) and all cartridges are installed properly. Install new cartridges if necessary.



To clear cartridge recognition error

- 1 Press Access Cartridges to move the carriage to the position which allows replacement of the ink cartridges.
- 2 Verify that four ENCAD NovaJet PRO 600e cartridges are installed. Replace any invalid cartridges.
- 3 Press OK. If the problem has been corrected, the printer will proceed with the print request. If the problem remains, the printer will beep.

Pausing the printer

To pause the printer while printing, press the Pause button. Press it again to resume printing.

Canceling a print

To cancel a print, first send a cancel order from the computer using the appropriate command for your software application. For example, you can delete the file in the Print Manager/Print Options. To clear the buffer after cancelling a print, press Reset on the Main menu.

About print drivers

- ! **Caution: Wider prints (60" vs 42" vs 24") and 600DPI prints require substantial file sizes. You may experience printer slowing or stalling when using the Windows driver to print from an application, or when printing a file using the ENCAD Macintosh EPU. The number of print passes specified will significantly impact the data transfer requirements. Less passes require more data; consequently, there is a higher probability of stalling when using less passes (faster printing modes). To do independent RIPing and printing, or faster simultaneous RIPing and printing, you may want to consider a stand-alone software or hardware RIP product. A list of RIP products that supports the NovaJet PRO 600e can be found at www.encad.com.**

You can define printer options through your application software or by choosing settings from the printer's control panel. The following printer options described in this chapter:

- Initialize (return to printer default settings)
- Print mode
- Paper Options
- User Setup

Returning to the default settings

Pressing the Setup/User Setup/Init Settings buttons returns all printer options to the factory defaults. All saved user settings are lost. The table on the next page shows the printer defaults.

Printing the settings

Pressing the Setup/User Setup/Print Settings buttons causes the printer to print a listing of its current settings. Be sure to have paper loaded before you start.

Choosing print mode options

Your printer offers several print modes which let you make tradeoffs between speed and quality.

The print mode you use depends on various factors, such as your software application, whether you're printing in color or monochrome, and the type of media you're using. Each print mode directly affects the printing speed and quality of the image you print, so you should understand the differences.

Each of the print modes attempts to strike a balance between speed and quality, with the quality mode providing quality images at a reasonable printing speed for most users. Whenever you choose a print mode other than Production, you will choose to emphasize either speed or quality.

Print mode options include the following:

- Color mode
- Print quality
- Print passes
- Carriage speed
- Print direction
- DPI mode

USER SETTINGS	DEFAULT	OTHER OPTIONS
COLOR MODE	COLOR	MONO, GRAY
QUALITY MODE	PHOTO	DRAFT, PRODUCTION, NORMAL, USER
DOTS PER INCH	600	300
PRINT PASSES	6	1, 3, 4, 8, 10
CARRIAGE SPEED	5	1-10
PRINT DIRECTION	BI	UNI
AUTO-LOAD DELAY	6	1-12 SEC.
MEDIA STANDARD	ALL	US ENGR, US ARCH, ISO A, MET ALL, US ALL, GRAPHICS, MET OVER A, ISO B, SPECIAL
MARGINS	NORMAL	EXPANDED
AUTO CUT	OFF	ON
SAVE MEDIA	ON	OFF
AUTO WIPE	ON	OFF
CALIB XY	OFF	ON
SELECT USER	1	1 TO 8
SAVE USER	1	1 TO 8
UNITS SELECT	ENGLISH	METRIC
LANGUAGE	ENGLISH	GERMAN, FRENCH, ITALIAN, SPANISH, PORTUGUESE, JAPANESE. CHINESE, KOREAN
INK PREHEAT	--	OFF, 1-7
DRYER	OFF	ON
DRY TIME	0	0:10, 0:20, ... 60:00
BAUD RATE	9600	19200, 38400
PARITY BIT	NONE	EVEN, ODD
DATA BIT	8	7
SYSTEM SETTINGS	DEFAULT	OTHER OPTIONS
SUPPLY TYPE	TAKE-UP	SHEET, ROLL
LCD CONTRAST	8	1-16
CALIBRATION SETTINGS	DEFAULT	OTHER OPTIONS
DEADBAND	35	0...120
SLOW DEADBAND	0	-2...+2
CYAN VERTICAL	0	-9...+9
MAGENTA VERTICAL	0	-9...+9
YELLOW VERTICAL	0	-9...+9
CYAN HORIZONTAL	0	-9...+9
MAGENTA HORIZONTAL	0	-9...+9
YELLOW HORIZONTAL	0	-9...+9
PAPER AXIS	33.00	32-34

USER SETTINGS	DEFAULT	OTHER OPTIONS
COLOR MODE	COLOR	MONO, GRAY
QUALITY MODE	PHOTO	DRAFT, PRODUCTION, NORMAL, USER
DOTS PER INCH	600	300
PRINT PASSES	6	1, 3, 4, 8
CARRIAGE SPEED	5	1-10
PRINT DIRECTION	BI	UNI
AUTO-LOAD DELAY	6	1-12 SEC.
MEDIA STANDARD	ALL	US ENGR, US ARCH, ISO A, MET ALL, US ALL, GRAPHICS, MET OVER A, ISO B, SPECIAL
MARGINS	NORMAL	EXPANDED
AUTO CUT	OFF	ON
SAVE MEDIA	ON	OFF
AUTO WIPE	ON	OFF
CALIB XY	OFF	ON
SELECT USER	1	1 TO 8
SAVE USER	1	1 TO 8
UNITS SELECT	ENGLISH	METRIC
LANGUAGE	ENGLISH	GERMAN, FRENCH, ITALIAN, SPANISH, PORTUGUESE, JAPANESE. CHINESE, KOREAN
INK PREHEAT	--	OFF, 1-7
DRYER	OFF	ON
DRY TIME	0	0:10, 0:20, ... 60:00
BAUD RATE	9600	19200, 38400
PARITY BIT	NONE	EVEN, ODD
DATA BIT	8	7
SYSTEM SETTINGS	DEFAULT	OTHER OPTIONS
SUPPLY TYPE	TAKE-UP	SHEET, ROLL
LCD CONTRAST	8	1-16
CALIBRATION SETTINGS	DEFAULT	OTHER OPTIONS
DEADBAND	35	0...120
SLOW DEADBAND	0	-2...+2
CYAN VERTICAL	0	-9...+9
MAGENTA VERTICAL	0	-9...+9
YELLOW VERTICAL	0	-9...+9
CYAN HORIZONTAL	0	-9...+9
MAGENTA HORIZONTAL	0	-9...+9
YELLOW HORIZONTAL	0	-9...+9
PAPER AXIS	33.00	32-34

Default print mode settings are summarized in the table which follows. It is not necessary to set all the parameters, unless you want to create a user-defined print mode.

MODE	DPI	PRINT DIRECTION	# OF PASSES	CARRIAGE SPEED
DRAFT	600X600	BI	1	5
PRODUCTION	600X600	BI	3	5
NORMAL	600X600	BI	4	5
PHOTO	600X600	BI	6	5
USER	User-defined through control panel.			

Note: When running at carriage speeds faster than the default, it is recommended that ink levels in the reservoirs be no more than 300 ml maximum.

Important notes about image size vs. dpi

For best results, be sure the printer dpi setting matches the image resolution in the file you are printing.

The printer always prints at 600 dpi, even when the dpi setting in the Print Mode menu is set to 300 dpi. The dpi setting refers to the resolution at which your image is created, not the resolution at which it is printed.



To choose dpi

- 1 Press Setup menu/Print mode menu/Dots per inch and select 300 or 600 as the resolution.

The resolution at which you save your image file affects the size of the printed image as shown in the following table:

Image (file) resolution	Printer dpi setting	Affect on printed output	
300 dpi	300 dpi	1 input pixel prints as 4 output pixels.	The printed image is the same size as the original.
300 dpi	600 dpi	1 input pixel prints as 1 output pixel.	The printed image is 1/4 the size of the original.
600 dpi	300 dpi	1 input pixel prints as 1 output pixel.	The printed image is four times the size of the original.
600 dpi	600 dpi	1 input pixel prints as 1 output pixel.	The printed image is the same size as the original.

Color mode

Color mode refers to whether you are printing in color or monochrome.



To choose the color mode

- 1 Press Setup/Print Mode/Color Mode.
- 2 Choose Color or Mono.
- 3 Press OK.

Quality modes

There are five print quality modes. Draft and Production modes are suited for line drawings and drawings with light solid fills, the types of images created by most CAD users. These modes are not recommended for printing images, because bleeding may occur in areas of heavy fills or dark shading when printed with these modes.

Draft - This mode generally is used when speed is more important than quality. Use it to check position, layout, color, etc. It will rarely be used for finished quality images. This is a single pass mode.

Production - (three passes per line). This mode provides fast, average quality on bond paper. Use for line drawings or images with small areas of fill and large areas of white space.

Normal - This setting is useful for fast, better than average quality printing on paper media.

Photo - For high quality continuous tone images where quality is more important than printing speed.

User defined - When you choose this option, a dialog displays in which you can select the number of print passes, the print direction, and the firing rate (1-10; 5 is the default).



To choose print quality

- 1 Press Setup/Print Mode/Quality Mode.
- 2 Choose the desired quality.
- 3 Press OK.

Print passes

The number of passes indicates how many times the cartridges must fire to lay down the ink for a complete scan line. You may select multiple passes, so that on a single pass, the jets fire only a fraction of the dots. If you're printing an image with heavy fill or shading, setting the print mode to an option that lays down less ink (e.g., six pass) can help prevent running and bleeding.



To change the number of passes

- 1 Choose Setup/Print Mode/Print Passes.
- 2 Choose Single, Three, Four, Six, Eight or Ten Pass.
- 3 Press OK.

Print direction

Print direction specifies whether the inkjets fire on both passes of the carriage over the print area (bidirectional), or just on the return pass (unidirectional). If you're printing an image with heavy fill or shading, unidirectional can reduce running and ink bleeding. If you're more concerned with printer speed, bidirectional firing can decrease your printing time.



To change the print direction

- 1 Press Setup/Print Mode/Print Direction.
- 2 Choose Unidirectional or Bidirectional.
- 3 Press OK.

Choosing paper options

Paper options let you define the following:

- Supply Type*
- Margins
- Auto-Cut
- Auto-Wipe
- Media Standard
- Auto-Load Delay
- Save Media

*Media feeding and loading is covered in Chapter 2.

Media standard

When you create an image, you determine its size at the computer. It's important that you know the size of the image and load the appropriate size media because the printer automatically defines the print area based on the loaded media's width. Be sure that the media you load is wide enough to accommodate the image. If extra length is required, use roll media. If the media is smaller than the image, the image may be truncated. Minimum media width is 11".



To choose the media standard

- 1 Press Setup/Paper Option/Media Standard
- 2 Choose the size of media you are loading.
- 3 Press OK.

The tables which follow provide details on the media sizes and maximum printing areas for rollfeed and sheet media.

Paper Size		Normal Print Area		Expanded Print Area					
Media Sizes and Maximum Printing Areas for Rollfeed Media									
GRAPHICS (U.S. OFFSET)									
19.0"	x	25.0"	17.8"	x	23.8"	18.6"	x	24.6"	
20.0"	x	28.0"	18.8"	x	26.8"	19.6"	x	27.6"	
22.0"	x	26.0"	20.8"	x	24.8"	21.6"	x	25.6"	
23.0"	x	35.0"	21.8"	x	33.8"	22.6"	x	34.6"	
24.0"	x	29.0"	22.8"	x	27.8"	23.6"	x	28.6"	
25.0"	x	38.0"	23.8"	x	36.8"	24.6"	x	37.6"	
26.0"	x	38.0"	24.8"	x	35.8"	25.6"	x	37.6"	
27.0"	x	39.0"	25.8"	x	37.8"	26.6"	x	38.6"	
30.0"	x	42.0"	28.8"	x	40.8"	29.6"	x	41.6"	
32.0"	x	44.0"	30.8"	x	42.8"	31.6"	x	43.6"	
35.0"	x	45.0"	33.8"	x	43.8"	34.6"	x	44.6"	
36.0"	x	45.0"	34.8"	x	43.8"	35.6"	x	44.6"	
40.0"	x	50.0"	38.8"	x	48.8"	39.6"	x	49.6"	
42.0"	x	65.0"	40.8"	x	63.8"	41.6"	x	64.6"	
48.0"	x	65.0"	46.8"	x	63.8"	47.6"	x	64.6"	
50.0"	x	65.0"	48.8"	x	63.8"	49.6"	x	64.6"	
54.0"	x	65.0"	52.8"	x	63.8"	53.6"	x	64.6"	
60.0"	x	65.0"	58.8"	x	63.8"	59.6"	x	64.6"	
U.S. ARCHITECTURAL									
A	9.0"	x	12.0"	7.8"	x	10.8"	8.6"	x	11.6"
B	12.0"	x	18.0"	10.8"	x	16.8"	11.6"	x	17.6"
C	18.0"	x	24.0"	16.8"	x	22.8"	17.6"	x	23.6"
D	24.0"	x	36.0"	22.8"	x	34.8"	23.6"	x	35.6"
E	36.0"	x	48.0"	34.8"	x	46.8"	35.6"	x	47.6"
U.S. ENGINEERING									
B	11.0"	x	17.0"	9.8"	x	15.8"	11.6"	x	16.6"
C	17.0"	x	22.0"	15.8"	x	20.8"	16.6"	x	21.6"
D	22.0"	x	34.0"	20.8"	x	32.8"	21.6"	x	33.6"
E	34.0"	x	44.0"	32.8"	x	42.8"	33.6"	x	43.6"
ISO-A									
A3	297	x	420 mm	267	x	390 mm	287	x	410 mm
A2	420	x	594 mm	390	x	564 mm	410	x	584 mm
A1	594	x	840 mm	564	x	811 mm	584	x	831 mm
	625	x	880 mm	595	x	850 mm	615	x	870 mm
A0	841	x	1189 mm	811	x	1159 mm	831	x	1179 mm
METRIC-DIN									
A3	337	x	460 mm	307	x	430 mm	327	x	450 mm
A2	460	x	634 mm	430	x	604 mm	450	x	624 mm
	610	x	860 mm	580	x	830 mm	600	x	850 mm
A1	634	x	881 mm	604	x	851 mm	624	x	871 mm
	860	x	1220 mm	830	x	1190 mm	850	x	1200 mm
A0	881	x	1129 mm	851	x	1199 mm	871	x	1219 mm
	1000	x	1414 mm	970	x	1384 mm	990	x	1404 mm
	1189	x	1682 mm	1159	x	1652 mm	1179	x	1672 mm
ISO-B									
B4	250	x	353 mm	220	x	323 mm	240	x	343 mm
B3	353	x	500 mm	323	x	470 mm	343	x	490 mm
B2	500	x	707 mm	470	x	677 mm	490	x	697 mm
B1	707	x	1000 mm	677	x	970 mm	697	x	990 mm

Media Sizes and Maximum Printing Areas for Sheet Media
Paper Size Normal Print Area Expanded Print Area
GRAPHICS (U.S. OFFSET)

19.0"	x	25.0"	17.8"	x	23.0"	18.6"	x	23.4"
20.0"	x	28.0"	18.8"	x	26.0"	19.6"	x	26.4"
22.0"	x	26.0"	20.8"	x	24.0"	21.6"	x	24.4"
23.0"	x	35.0"	21.8"	x	33.0"	22.6"	x	33.4"
24.0"	x	29.0"	22.8"	x	27.0"	23.6"	x	27.4"
25.0"	x	38.0"	23.8"	x	36.0"	24.6"	x	36.4"
26.0"	x	38.0"	24.8"	x	36.0"	25.6"	x	36.4"
27.0"	x	39.0"	25.8"	x	37.0"	26.6"	x	37.4"
30.0"	x	42.0"	28.8"	x	40.0"	29.6"	x	40.4"
32.0"	x	44.0"	30.8"	x	42.0"	31.6"	x	42.4"
35.0"	x	45.0"	33.8"	x	43.0"	34.6"	x	43.4"
36.0"	x	45.0"	34.8"	x	43.0"	35.6"	x	43.4"
40.0"	x	50.0"	38.8"	x	48.0"	39.6"	x	48.4"
42.0"	x	65.0"	40.8"	x	63.0"	41.6"	x	63.4"
48.0"	x	65.0"	46.8"	x	63.0"	47.6"	x	63.4"
50.0"	x	65.0"	48.8"	x	63.0"	49.6"	x	63.4"
54.0"	x	65.0"	52.8"	x	63.0"	53.6"	x	63.4"
60.0"	x	65.0"	58.8"	x	63.0"	59.6"	x	63.4"

U.S. ARCHITECTURAL

A	9.0"	x	12.0"	7.8"	x	10.0"	8.6"	x	10.4"
B	12.0"	x	18.0"	10.8"	x	16.0"	11.6"	x	16.4"
C	18.0"	x	24.0"	16.8"	x	22.0"	17.6"	x	22.4"
D	24.0"	x	36.0"	22.8"	x	34.0"	23.6"	x	34.4"
E	36.0"	x	48.0"	34.8"	x	44.6"	35.6"	x	45.0"

U.S. ENGINEERING

A	8.5"	x	11.0"	7.3"	x	9.0"	8.1"	x	9.4"
B	11.0"	x	17.0"	9.8"	x	15.0"	10.6"	x	15.4"
C	17.0"	x	22.0"	15.8"	x	20.0"	16.6"	x	20.4"
D	22.0"	x	34.0"	20.8"	x	32.0"	21.6"	x	32.4"
E	34.0"	x	44.0"	32.8"	x	40.6"	33.6"	x	41.0"

ISO-A

A4	210	x	297 mm	180	x	247 mm	200	x	257 mm
A3	297	x	420 mm	267	x	370 mm	287	x	380 mm
A2	420	x	594 mm	390	x	544 mm	410	x	554 mm
A1	594	x	840 mm	564	x	790 mm	584	x	800 mm
	625	x	880 mm	595	x	830 mm	615	x	840 mm
A0	841	x	1189 mm	811	x	1139 mm	831	x	1149 mm

METRIC-DIN

A4	250	x	337 mm	220	x	287 mm	240	x	297 mm
A3	337	x	460 mm	307	x	410 mm	327	x	420 mm
A2	460	x	634 mm	430	x	584 mm	450	x	594 mm
	610	x	860 mm	580	x	810 mm	600	x	820 mm
A1	634	x	881 mm	804	x	831 mm	624	x	841 mm
	860	x	1220 mm	830	x	1170 mm	850	x	1180 mm
A0	881	x	1229 mm	851	x	1179 mm	871	x	1189 mm
	1000	x	1414 mm	970	x	1364 mm	990	x	1374 mm
	1189	x	1682 mm	1158	x	1632 mm	1179	x	1642 mm

ISO-B

B4	250	x	353 mm	220	x	303 mm	240	x	313 mm
B3	353	x	500 mm	323	x	450 mm	343	x	460 mm
B2	500	x	707 mm	470	x	657 mm	490	x	667 mm
B1	707	x	1000 mm	677	x	950 mm	697	x	960 mm

PRINTER OPTIONS

Margins

Margins can be set to Normal or Expanded. The Expanded setting expands the print area and decreases the margins.

Any part of the image that extends into the margin will be clipped. When the Margins option is set to Expanded, make sure that you align the media accurately using the guide on the right of the platen so that the ink doesn't exceed the edge of the media.

Cut sheet maximum printing area

Normal: 0.59" (15 mm) margin on each of three sides and 1.38" (35 mm) margin on the fourth side.

Expanded: 0.197" (5 mm) margin on each of three sides and a 1.38" (35 mm) margin on the fourth side.

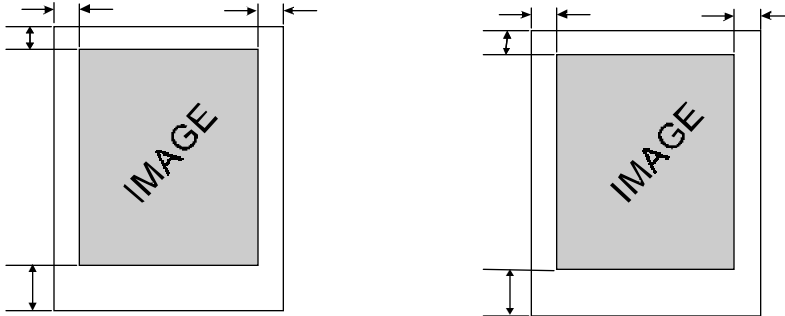

Rollfeed maximum printing area

Normal: 0.59" (15 mm) margin on all sides.

Expanded: 0.197" (5 mm) margin on all sides.

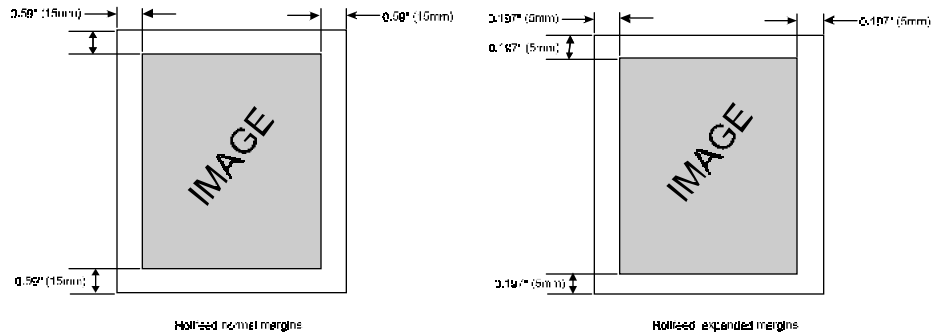



To set margins

- 1 Press Setup/Paper Option/Margins.
- 2 Choose Normal or Expanded.
- 3 Press OK.

Auto-Load Delay

Auto-Load Delay lets you set the time between when the printer senses the media and when printing starts. This lets you manually reposition the media if necessary. The default is 6 seconds, selectable from a range of 1-12 seconds.



To set auto-load delay

- 1 Press Setup/Paper Option/Auto-Load Delay.
- 2 Choose the delay time.
- 3 Press OK.

Auto-Cut

When the Auto-Cut option is set to on, the printer automatically cuts the media when the image is complete. Be sure the image is dry before cutting, turn on the dryer and/or specify a Dry Time. See “Setting a Dry Time” in this chapter for the procedure. You can select Cut from the control panel at any time to cut the media.

Note: Automatic cutting is disabled when the paper feed option is set to TAKEUP.



To set auto-cut

- 1 Press Setup/Paper Option/Auto-Cut.
- 2 Choose On or Off.
- 3 Press OK.

Save Media

When the Save Media is On (the default), the media advances only as far as needed to print the image. With the Save Media option turned off, the printer advances the full print area of the loaded media. For example, if a 36 inch roll is loaded, the printer advances the length of the print area for a standard 36 x 48" sheet even if the printed image is only 30 inches long.



To turn off Save Media

- 1 Press Setup/Paper Option/Save Media.
- 2 Choose Off.
- 3 Press OK.

Auto-Wipe

The cartridge jet plates are periodically wiped during printing. The default for this function is ON. If you are having problems with banding, you can sometimes solve the problem by setting the wiper to OFF; however, this can cause clogging of the inkjets.



To turn off the wiper

- 1 Press Setup/Paper Option/Auto-Wipe.
- 2 Choose Off.
- 3 Press OK.

Defining user setup

You can save the options you use most frequently so you don't have to reconfigure the printer each time you print an image. You can define up to eight different combinations of options and save them with a user number ranging from 1-8. Select the user number you want to use before sending an image to the printer. If your printer driver has host-controlled settings, the user setup may be overridden. If possible, disable the driver control settings.

You can save settings for the following options:

- Cut On or Off
- Media Standard
- Drying Time
- Baud Rate
- Auto-Wipe On or Off
- Monochrome or Color
- Parity
- Quality Mode
- Print Mode
- Normal or Expanded Margins
- Save Media On or Off
- Dryer On/Off



To save user setup

- 1 Press Setup/User Setup/Save User.
- 2 Scroll to the number for the user settings.
- 3 Press OK.



To use a previously saved user setting

- 1 Press Setup/User Setup/Select User.
- 2 Scroll to the number for the user settings (i.e. user 1, user 2, etc.) to use.
- 3 Press OK.

Choosing a language

Printer menus and options can be displayed in the following languages: English, German, French, Italian, Portuguese, Spanish, simplified and traditional Chinese, Japanese, and Korean.



To choose a language

- 1 Press Setup/User Setup/Language.
- 2 Choose the language to display.
- 3 Press OK.

Choosing ink options

Ink reduction

Ink reduction lets you reduce the percentage of ink laid down by the printer. This feature applies only to HPGL/2 format images (vector-based images) and has no effect on continuous tone images. It is especially useful for images with large amounts of printed area and helps to avoid bleeding or over-saturating the media. It does, however, change the appearance of colors, so you may want to run a small test print.



To set ink reduction

- 1 Press Setup/Ink Option/Ink Reduction.
- 2 Choose a reduction percentage - 12.5, 25%, 37.5, or 50%.
- 3 Press OK.

Ink Preheat

Cartridge heat settings are optimized for QIS media being printed in a standard office environment. If you are experiencing banding, poor fills, or over dot gain, and you have tried all other means to correct these conditions, you may want to experiment with the ink preheat settings. These will vary depending on the ambient temperature where the printer is located and the media and ink used.

Defaults for the heater setting are determined by the ink type in use. The printer determines this by reading the chip on the back of each cartridge. When you adjust the ink settings, you are increasing or decreasing the heat from the default temperature. Pressing the + (plus) button increases the temperature, pressing - (minus) decreases it. When you have reached the limits of the temperature range, the panel will display either MAX or OFF. These settings are saved in the printer. If you change to a different type of ink, you may need to change the heater settings to accommodate the new ink type.

If you are working in a cold or dry environment, try turning the heat up for a larger dot size. If the heat is turned up too far, the ink may run or sputter. If you are working in a humid or hot environment, turn the heat down for a smaller dot size.



To set the ink preheat time

- 1 Press Setup/Ink Option/Ink Preheat.
- 2 Choose a preheat value.
- 3 Press OK.

Dry time

Unattended prints might require drying time to prevent the ink from smearing when the image touches the takeup roll or previously printed images. In addition, you may want to change drying time depending on the media you are using, the ambient temperature and the humidity. Dry Time values range from 10 seconds to 60 minutes. When the Dry Time has expired, the printer rolls or cuts the image and begins printing the next image in the buffer.



To set the dry time

- 1 Press Setup/Ink Option/Dry Time.
- 2 Choose a time from 10 seconds to 60 minutes.
- 3 Press OK.

Dryer On/Off

The dryer installed at the base of the printer stand helps to dry ink.



To enable the dryer

- 1 Press Setup/Ink Option/Dryer.
- 2 Choose On.
- 3 Press OK.

LCD Contrast

The LCD Contrast function lets you adjust the brightness of the control panel. The range is 1-16, where 16 is less contrast. The default is 9. Note that if brightness is set too high, you may not be able to see the text displayed on the control panel.



To set LCD contrast

- 1 Press Setup/User Setup/LCD Contrast.
- 2 Choose the contrast value.
- 3 Press OK.

This page intentionally blank.

This chapter provides information on the following:

- Periodic maintenance
- Preparing your printer for storage or transport
- Using the information function.

Periodic maintenance

Periodic maintenance functions which you will want to perform to assure continued quality printing include:

- Refilling the ink reservoirs
- Changing ink type
- Replacing ink cartridges
- Cleaning the ink cartridges
- Cleaning and replacing the service station
- Replacing the cutter (described in Chapter 2).

Refilling ink reservoirs

! Use of inks other than those supplied by ENCAD may cause damage to your printer.

The ink reservoirs are located at the left side of the printer. You can refill any time, even while printing. Be sure the reservoirs always have ink in them - it is a good idea to keep them approximately 3/4 full. Allowing a reservoir to run out of ink causes the ink delivery lines to deprime and may cause ink leakage and damage to the ink cartridges and carriage electronics.



To fill the ink reservoir

Note: Before starting, you may want to do the following:

- *Have paper towels handy.*
- *Wear disposable gloves.*

! Open only one reservoir at a time to prevent ink from accidentally contaminating another color.

- 1 Open the front left cover to gain access to the reservoirs.
- 2 Remove the cap from the reservoir you want to fill.
- 3 Verify that the ink color and type in the bottle match the ink color and type in the reservoir.
- 4 Pour the ink into the reservoir to about 1/2 inch from the top. Do not overfill.
- 5 Replace the cap on the reservoir and close the panel.

Changing ink types

Changing from one ink type to another, for example, from ENCAD GA to ENCAD GO ink requires that you change the reservoirs and cartridges to the new type of ink. If one set of ink lines is being used for a different type of ink, you will need to purge the ink lines with distilled water. If you are only using two types of inks, this is generally not necessary.

Note: For best results, DO NOT USE GA or GS inks with GO media. NEVER MIX INKS! Use only inks designated for NovaJet PRO 600e printers.

To change from one type of ink system to another, you will need to do the following:

- Remove and store ink cartridges in the cartridge garages
- Remove and store ink reservoirs
- Install new ink reservoirs
- Install new ink cartridges

If you are changing to a third ink type, for example, if you previously used GA and GO inks and you now want to use GS and GO inks, you must purge the ink lines and rinse them with distilled water before changing to a new ink type. You will then have to reprime the lines as described in Chapter 2. Additional ink reservoirs can be purchased from ENCAD.

Removing and storing ink cartridges

You typically store cartridges when you want to use to a different ink set (and therefore different cartridges) and need to store the existing cartridges for future reuse. This procedure explains how to remove, store and reuse cartridges. Following this procedure will extend the life of your cartridges and prevent ink from leaking from the cartridges.



To remove and store cartridges

- 1 On the printer display panel, press **Utility Menu** then **Access Cartridge**. This moves the carriage away from the service station and enables you to easily remove the cartridges.

- 2 Disconnect the cartridge tube from the carriage by pushing down on the disconnect button and removing the quick connect fitting.
- 3 Remove the cartridge from its carriage stall by gently pulling the top edge toward you, then lifting it out of the stall. **Do not remove the cartridge tube from the cartridge.** Leaving the tube in the cartridge maintains negative pressure and prevents leakage. Do not touch the flex contact area of the cartridge.

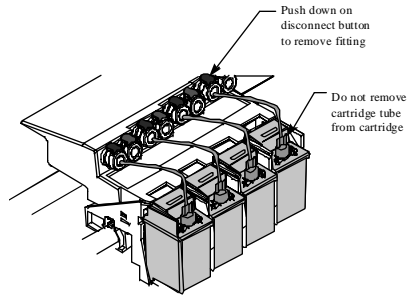

- 4 Wipe any ink from the quick connect fitting at the end of the tube using a lint-free cloth.
- 5 Insert the cartridge into the cartridge garage. Make sure the cartridge cap lip snaps and locks into the cartridge garage locking tab. This will assure a good seal.

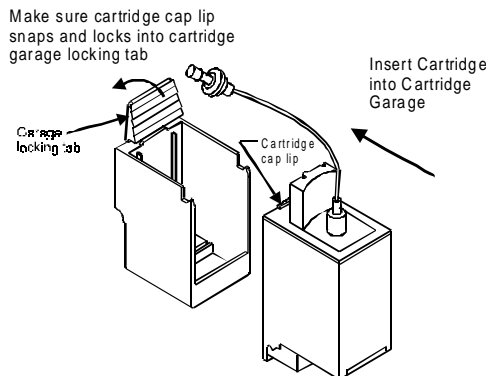

- 6 Store the cartridge garage upright to prevent leaks.



To reuse the cartridge

- 1 Remove the cartridge from its garage by pulling back on the garage locking tab and gently taking out the cartridge.
- 2 On the printer display panel, press **Utility Menu** then **Access Cartridge**.
- 3 Snap the cartridge tube connector quick connect fitting into the fitting on the carriage.
- 4 Insert the cartridge into its carriage stall, making sure that there are no kinks in the ink delivery line. (Refer to Chapter 2.)
- 5 On the printer display panel, press **Utility Menu** then **Access Cartridge** to return the carriage to the service station.
- 6 Run a prime to ensure that all jets are clear and operating correctly.
- 7 If the cartridge leaked during storage or the cartridge lost negative pressure, you will need to reprime the cartridge with the **NovaPrime** to reestablish negative pressure. (Refer to Chapter 2.)

Note: Cartridges stored for extended periods of time will probably need to be cleaned, blotted and primed before use because the garages are designed only for short term cartridge storage.

Replacing the reservoirs

- 1 Remove all the cartridges before replacing the ink reservoirs.
- 2 Open the left front cover to access the reservoirs. Leave the caps on the reservoirs. Disconnect the quick connect fitting for each reservoir, noting the color of the fitting to which it was connected.
- 3 Slide each reservoir forward to remove it from the printer.
Store the reservoirs away from direct sunlight in an environment similar to that of the printer.
- 4 Replace the reservoirs with new reservoirs.
- 5 Fill the reservoirs with ink and attach to the quick connect fittings primed for that type of ink.

Installing new cartridges

Be sure the cartridges you are installing contain the same type of ink as the reservoirs. Snap them into place and attach the quick connect fittings as described in Chapter 2.

- ! The printer will only operate when all four PRO 600e cartridges are installed. Installing non PRO 600e cartridges may damage the printer and will prevent it from operating correctly.
- ! Don't attempt to install or remove an ink cartridge from the carriage at any time without first selecting Utility/Access Cartridges to move the carriage away from the service station. Don't attempt to manually pull the carriage out of the service station while the printer is turned on. This can damage the printer.
- ! Touching the flex contacts (the copper area that houses the electrical contacts) and the inkjet plate can damage the cartridge. Similarly, touching the copper contact area of the carriage can damage the carriage.

Each time you place new ink cartridges in the printer, perform a prime and color calibration to ensure the highest quality printed images. Priming is covered in Chapter 2 and calibration procedures are discussed in Appendix A.

Ink cartridges generally last as long as the ink in a full reservoir. When a cartridge misfires or the quality deteriorates, you will want to replace it.

Purging ink delivery lines

If you are changing to a third ink type, for example, if you previously used GA and GO inks and you now want to use GS and GO inks, you must purge the ink lines and rinse them with distilled water very well before changing to a new ink type. You will then have to reprime the lines as described in Chapter 2.



To purge ink delivery lines

- 1 Remove all four cartridges before purging the ink lines.
- 2 Disconnect the ink delivery lines from the ink reservoirs. Carefully wipe any excess ink from each connector using a paper towel before proceeding.
- 3 Insert the tube that was in the cartridge into a container of distilled water.
- 4 Connect the NovaPrime to a connector at the ink reservoir and turn it on until ink stops flowing into the collection bottle.
- 5 Repeat the same procedure for the rest of the lines.

Periodic cleaning

To assure the best quality printing, you should clean the cartridges and service station daily for heavy use and once a week for moderate use. In addition, you should wipe any areas of the printer exposed to ink and the slide shaft using a lint-free cloth moistened with water.

Note: Do not lubricate the print shaft! Keep it clean using a clean cloth and rubbing alcohol.

The table that follows identifies periodic cleaning which you can perform to keep your printer in top operating condition.

Interval	Component	Cleaning Agent
Immediately	Any - clean up ink spills	Distilled water
Daily, as needed	Service station seals and wipers	Distilled water
Monthly	Slide shaft	Isopropyl alcohol
	Encoder strip top and bottom	Distilled water
	Cartridge jet area	Distilled water
Semiannually	External areas	Distilled water
Twice a month	Pinch rollers and lower drive rollers	Isopropyl alcohol
Annually	Encoder sensor	Canned air or alcohol-moistened cloth.
	Inner platen	Distilled water
	Carriage	Distilled water
As Required	Keypad	Industrial Film Cleaner
Other		
When a cartridge is changed or there is a problem with the prime	Cartridge dimples/flex driver cables	Isopropyl alcohol

Materials to use for cleaning

- Isopropyl alcohol (industrial grade)
- Lint-free soft cloth/paper wipe
- Dry lint-free cloth
- Cotton swabs
- Ultrasonic cleaner (if available)
- Distilled/Reverse osmosis water (purified water)
- Canned/compressed air.

Components to annually inspect

The following components should be cleaned and inspected for damage on an annual basis and replaced if necessary.

- Carriage belt
- Service station seals and wipers
- Trailing cable
- Cutter

Cleaning the ink cartridge jet plate

The ink cartridges may require occasional maintenance when used in low humidity. If repeated priming doesn't unclog the head, follow the cleaning procedure below. In addition, cartridges will wear out after prolonged use. If cleaning the cartridge does not restore print quality, replace it.



To clean the ink cartridge jet plate

- 1 Press the Utility/Access Cartridges buttons to move the carriage away from the service station.
- 2 Disconnect the quick connect fittings, noting the color of the fitting to which the cartridge was connected.
- 3 Remove the ink cartridge from the printer by gently pulling the top of the cartridge toward you, then lifting it up out of the carriage.
- 4 Press lightly against the jets with a water-moistened, lint-free, non-paper cloth (do not use alcohol). Gently blot any excess ink. Blot - do not wipe. Wiping may damage the jets. (Ink will appear on the cloth; this is normal.) Reinstall the cartridge in the carriage and reconnect the ink supply line.

! Never use alcohol to clean the jet area of the cartridge.

- 5 Press the Utility/Access Cartridges buttons to return the carriage to the service station.
- 6 Press the Utility/Prime buttons to check the cartridges. Repeat two more times, if necessary. If the cartridges fire correctly, perform the appropriate calibration procedures from Appendix A.
- 7 If the cartridge continues to misfire, remove the cartridge. Rinse the ink from the bottom of the cartridge using warm distilled water. Note that removing the cartridge too many times may create a large air bubble in the line, which could lead to pen problems. Refill the lines with ink if necessary.

Note: You can manually compensate for clogged jets. Refer to Chapter 2 for instructions.

- 8 Dry all surfaces of the cartridge, except for the bottom, or jet area and the circuit plate. Reinstall the cartridge and reprime. Check the Prime test pattern and set the print mode as indicated on the test pattern print. (See Chapter 2 for instructions on interpreting the Prime test pattern.) You may also want to run the color test described in Chapter 2.

Cleaning the service station

Ink and dust can accumulate in the service station causing poor print quality. Depending on how frequently you print, you may want to clean the service station daily using the following procedure.

To clean the service station

- 1 Select Utility/Access Cartridges to move the carriage away from the service station.
- 2 Raise the printer cover.
- 3 Locate the service station release tab at the right end of the service station base. Move it gently to the left and lift to remove the entire service station assembly.

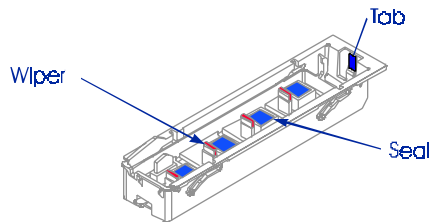

- 4 Rinse the service station and wipers with warm water. Use cotton swabs to clean small spaces.
- 5 Inspect the seals and wipers. Any damage to these parts can cause the cartridge jetplate to clog, resulting in misfires. Compare the wipers to the figure which follows and replace the service station if necessary.

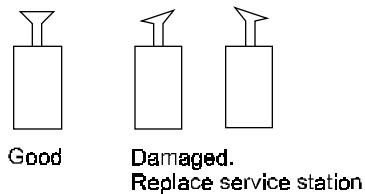

- 6 Dry the service station and replace it, putting the left side in first. Make sure the release tab re-latches.
- 7 Press Utility/Access Cartridge to return the carriage to the service station.

Maintaining the NovaPrime

The NovaPrime is an accessory used to fill ink lines when reservoirs are installed and to clear clogs in cartridges. It is battery operated and uses 4 AA batteries.



To replace the battery

- 1 Remove the screw at the end of the unit and open the NovaPrime.
- 2 Note the orientation of the battery pack. Pull it out and replace the AA batteries.



To clean the NovaPrime

Clean the NovaPrime with distilled water and a lint-free cloth to remove ink. Thoroughly wash the ink bottle and allow to air dry.

Preparing your printer for transport or storage

If you need to take your printer out of service, for example, to ship it to another location or to send it to a repair depot do the following:

- Remove the ink cartridges and store them in a cartridge garage, away from direct light and heat.
- Remove the ink reservoirs.
- Wash out the service station.

Returning the printer for service

If for any reason, you need to return your printer to ENCAD for service, **you must remove the cartridges, ink reservoirs, and purge the ink supply lines.** You should also remove all memory except for the factory-installed 32MB SIMM. Before returning the printer, contact ENCAD Technical Support for a returned material authorization (RMA) number and for complete instructions on preparing your printer for shipment.

Accessing printer information

The printer can provide you with information on the following:

- Plot area
- Memory
- Calibration settings
- On time
- Plot time
- Firmware version



To access printer information

- 1 Select Utility/Print Settings or Utility/Display Settings.
- 2 Press the button for the item for which you want information.
- 3 Press OK.

This page intentionally blank.

Color calibration

For best results, the color calibration must be performed each time you install a new cartridge. The printer draws a series of three patterns. The first pattern, labeled “Current Heads (Y, M, C),” shows yellow, magenta, and cyan + which represent the horizontal and vertical alignment between the cartridges.

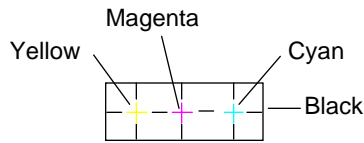

Current Heads (Y, M, C)

When the colored + lines up horizontally and vertically with the black alignment marks, no adjustment is required.

The second pattern, labeled “Color Horizontal Head-to-Head Calibration,” horizontally aligns the cartridges. Three lines similar to the example below are printed with the following color combinations: yellow/magenta, magenta/cyan, and cyan/black.

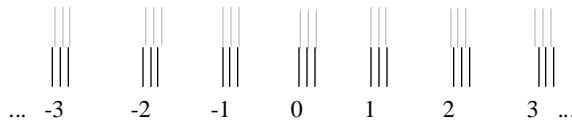

Color Horizontal Head-to-Head Calibration

The third pattern, labeled “Color Vertical Head-to-Head Calibration,” vertically aligns the cartridges.

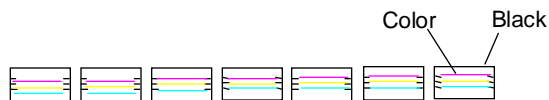

Color Vertical Head-to-Head Calibration

The numbers below each set of lines represent the different horizontal and vertical alignment values. Examine the patterns to determine which value shows the best horizontal and vertical alignment between cartridges. These are the values you will set in the printer menu.



To adjust the color calibration values

- 1 Install ink cartridges in the printer. (See Chapter 2 "Getting started" for cartridge installation instructions.)
- 2 Load media in the printer that is at least 11 inches (28 cm) wide. (See Chapter 2 "Getting started" for media loading instructions.)
- 3 Prime the heads to ensure that all cartridges fire correctly. Make sure Color is the selected print mode.
- 4 Select Utilities/Color Calibration/Calib Print Test.
The test patterns print.
- 5 Examine the Current Heads pattern; the colored +'s should align with the black lines. If any of the +'s don't align, perform the procedure for adjusting the color values.
- 6 Press Cyan - Vertical.
- 7 Examine the printout and enter the number that represents the best color alignment for cyan-vertical.
- 8 Repeat for each color and for horizontal alignment as well.

Defining Calibration Units

You can set the calibration units to English or Metric.



To set calibration units

- 1 Select Setup/User Setup/Units Select.
- 2 Choose English or Metric.

Paper axis calibration

Choosing Utility/Calibration/Paper Axis Test lets the printer draw a set of vertical marks to calibrate the paper axis. To measure the marks laid down by the printer, you will need a ruler or scale at least 33 inches (838.2 mm) long. The vertical marks should be exactly 33.00 inches (838.2 mm) apart. If the distance between the marks is different from that shown on the display, you may adjust the printer by setting its values to match the length or width you measured.



To print the Paper Axis calibration test pattern

- 1 Load the printer with media that is at least 36 (91 cm) inches long (or the media that you are going to run; you cannot load a 36" sheet and then run the calibration from a roll feed because the line lengths will not match).

-
- 2 Press Utility/Calibration/Paper Axis Test.
The printer prints two marks.
 - 3 Remove the media from the printer and measure the distance between the marks. The distance between the marks should be exactly 33.00 inches (838.2 mm).
 - 4 If the measurement is not exactly 33.00 inches, select "Paper Axis" and adjust the value to the measurement read on the scale.

This page intentionally blank.

Your printer is shipped with 32 MB of RAM and is upgradable to a maximum of 128 MB, 64 MB per socket. Additional memory helps to free the host computer more quickly.

Acceptable SIMM sizes

Printer memory may be upgraded by installing 72-pin 70 nanosecond (or faster) SIMMs that are either 32 or 36 bits wide. (The printer does not use parity bits.) The SIMMs must not exceed a height of 2 inches (5 cm) and must conform to JEDEC Std. 21-C, release 4.

The printer will accept 4 MB, 8 MB, 16 MB, 32 MB or 64 MB SIMMs. Recommended SIMMs are ENCAD PN 210610 32MB SIMMS.

SIMM installation

The SIMMs are located on the MPCB inside the right cover. The MPCB comes with one SIMM slot empty and 32 MB RAM SIMM installed on the board. The following procedures describe how to remove the right cover, remove any currently installed SIMM(s), install new SIMM(s) and replace the cover. You will need a #2 Phillips screwdriver to complete the procedures.

! ALWAYS UNPLUG THE POWER CORD BEFORE BEGINNING.

! To avoid static damage to the printer, never touch the circuit board or its components without first touching the bright metal portions of the printer. Static damage is more likely when the relative humidity is low. If possible, wear a grounding strap when touching the circuit board.



To remove the right cover

- 1 Disconnect the power and the interface cables.
- 2 Remove the printer's top cover.
- 3 Remove the three screws under the right side of the printer which attach the right side cover and the two screws which attach the cover to the right plate.
- 4 Slide back the pin that holds the right cover to the rear cover.
- 5 Move the right cover, being careful to clear the parallel port on the back of the unit.
- 6 Carefully disconnect the ribbon cable from the connector on the PC board and the other two cables that go to the cover.

➡ To remove the SIMMs

- 1 Facing the top of the SIMMs, push the side clips gently to the outside (away from the SIMM).
- 2 Push over and pull out, being careful not to damage the fingers on the top.

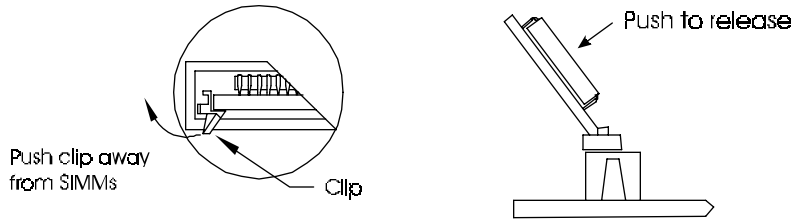
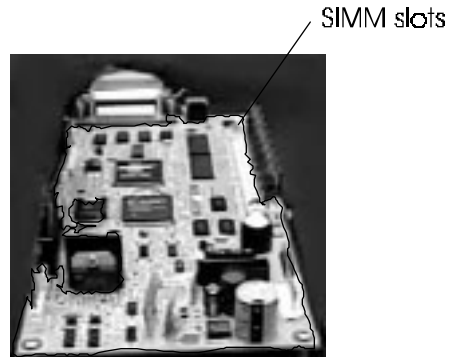

➡ To install the new SIMM

- 1 Insert at a 45 degree angle and slowly push the SIMM to a 90° angle until the two side clips snap into place. Make sure the SIMM is fully seated.

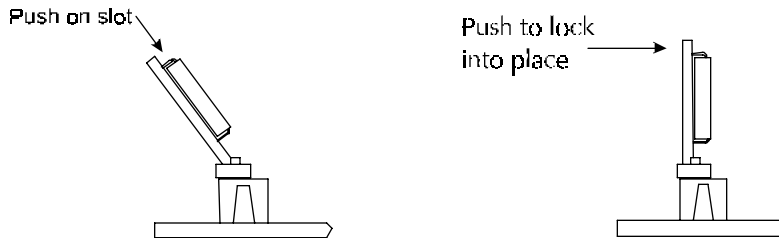

- 2 Carefully reconnect the ribbon cable harness to the connector on the PC board. Reattach the other connectors removed earlier.
- 3 Reinstall the right cover and top cover.

This section contains an overview of the printer's menu tree. The use of the options is explained in Chapters 2 - 3 of this guide. In the figures that follow, items in italics indicate that selecting the option gives access to further options. Items in bold are the default option.

Main menu at a glance

Main Menu	Load Media
	Cut
	Pause
	Reset
	<i>Feed Media Menu</i>
	<i>Forward</i>
	<i>Backward</i>
	<i>Setup Menu</i>
	<i>Print Mode Menu</i>
	<i>Paper Options Menu</i>
	<i>User Setup Menu</i>
	<i>Ink Option Menu</i>
	<i>Serial Comm Menu</i>
	Exit
	<i>Utility Menu</i>
	Prime
	Access Cartridge
	<i>Color Calib Menu</i>
	<i>Calibration Menu</i>
	Display Settings
	Print Settings
<i>Service Menu</i>	
Exit	

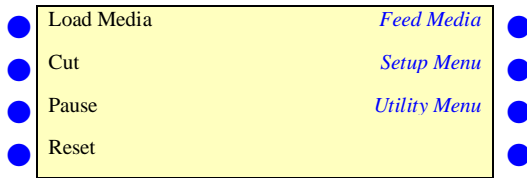

- LOAD MEDIA moves media into or away from the platen.
- CUT - cuts media.
- FEED MEDIA - provides access to further options for moving the media forward or backward.
- PAUSE - provides access to further options for canceling print jobs, reinitializing the printer, or examining the job.
- RESET - clears the print buffer. When cancelling a print, first remove it from the computer's print queue, then press the Reset button on the printer.
- SETUP - provides access to further submenus for setting printing options.
- UTILITY - provides access to further submenus for calibration and other functions.

Feed media menu



- Forward advances media toward the front of the printer.
- Backward moves media toward the back of the printer.
- Exit returns to main menu.

Setup menu at a glance (Bold indicates the default)

Setup	<i>Print Mode Menu</i>	
	<i>Color Mode</i>	Color , mono, gray
	<i>Quality Mode</i>	User, Draft, Normal, Production, Photo
	<i>Dots per Inch</i>	300, 600
	<i>Print Passes</i>	1, 3, 4, 6 , 8, 10
	<i>Carriage Speed</i>	1-10, 5
	<i>Print Direction</i>	Uni, bi
	Exit	
	<i>Paper Option Menu</i>	
	<i>Supply Type</i>	Sheet, roll, take-up
	<i>Media Standard</i>	All , US_Engr, US_Arch, ISO_A, M_DIN, ISO_B, Special, MET OVER A, Graphics, US_All, Metric_All
	<i>Margins</i>	Normal , Expanded
	<i>Auto-Load Delay</i>	1-12, 6
	<i>Auto-Cut</i>	On/ Off
	<i>Save Media</i>	On /Off
	<i>Auto-Wipe</i>	On /Off
	Exit	
	<i>User Setup Menu</i>	
	<i>Select User</i>	1-8, 1
	<i>Save User</i>	1-8, 1
	<i>Units Select</i>	English , Metric
	<i>Language</i>	English , German, French, Italian, Spanish, Portuguese, Japanese, Chinese, Korean
	<i>Init Settings</i>	
	<i>Print Settings</i>	
	<i>LCD Contrast</i>	1-16, 9 (16 is less contrast)
	Exit	
	<i>Ink Option Menu</i>	
	<i>Ink Reduction</i>	0 , 12.5, 25, 37.5, 50
	<i>Ink Preheat Menu</i>	Off, 1-7, Max
	<i>Dryer</i>	On/ Off
	<i>Dry Time</i>	0 , 0:10, 0:20, 0:30...60:00
	Exit	
	<i>Serial Comm Menu</i>	
	<i>Baud Rate</i>	9600 , 19200, 38400
	<i>Data Bits</i>	7, 8
	<i>Parity Bit</i>	Even, Odd, None
	Exit	

Setup menu

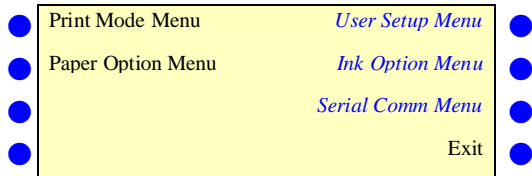

- Print Mode Menu** provides access to options for color, quality, print passes, carriage speed, and print direction.
- Paper Option Menu** provides access to options for loading paper.
- User Setup Menu** provides access to options for defining and saving user settings.
- Ink Option Menu** provides access to options for setting ink reduction, ink preheat, dryer on/off, and dry time.
- Serial Comm Menu** provides access to options for setting communications parameters.
- Exit** returns to the main menu.

Print Mode

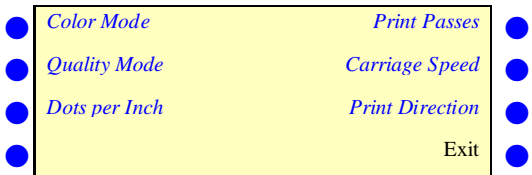

- Color mode** provides access to a further menu to select **color (default)**, monochrome, or grayscale printing.
- Quality mode** provides access to a further menu to select the print mode.
- Dots per inch** provides access to a further menu to select print resolution: **600 (default)** or 300 dots per inch.
- Print passes** provides access to a further menu to select 1, 3, 4, **6 (default) or 8** print passes. More passes = better quality.
- Carriage speed** provides access to a menu for choosing carriage speed in a range 1-10. **Default = 5.**

Print direction	provides access to a further menu to select whether the printer will print in bi (default) or uni-directional printing (one direction).
Exit	returns to the Setup menu.

Paper Option Menu

● <i>Supply Type</i>	<i>Auto-Cut</i>	●
● <i>Media Standard</i>	<i>Save Media</i>	●
● <i>Margins</i>	<i>Auto-Wipe</i>	●
● <i>Auto-Load Delay</i>	Exit	●

Supply type	provides access to a further menu to select the paper feed mode: roll, sheet, or takeup (default) .
Media standard	provides access to a further menu to select the media standard: All (default) , US_Engr, US_Arch, ISO_A, Met over A, ISO_B, Special, Graphics, US_All, Metric_All.
Margins	provides access to a further menu to change the available plot area based on the margin type elected. Select Normal (default) or Expanded margins.
Auto-Load Delay	provides access to a further menu to change the delay between when the media is positioned for loading and when loading occurs. This allows users to adjust the media if necessary. Select 1-12 seconds. Default = 6.
Auto-Cut	provides access to a further menu to turn Auto-Cut Off (default) or On. When On, the printer cuts the media after printing is complete.
Save Media	provides access to a further menu to turn Save media On or Off (default) . When set to On, printing will stop at the end of the image rather than scrolling out the full paper size.
Auto-Wipe	provides access to a further menu to turn the Auto-wipe function On (default) or Off. When on, the cartridges are wiped during printing.
Exit	returns to the Setup menu.

User Setup Menu

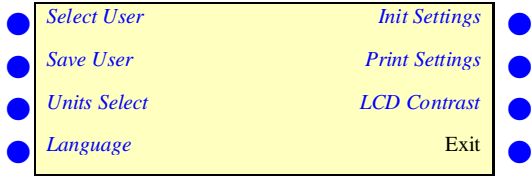

- | | |
|----------------|---|
| Select user | provides access to a further menu to select a previously saved user configuration. Default = User 1. |
| Save user | provides access to a further menu to save the current printer configuration to the selected user number. Default = User 1. |
| Units select | provides access to a further menu to choose the calibration units: English (default) or Metric. |
| Language | provides access to a further menu to select the language used for the display. Choose from English (default) , German, French, Italian, Spanish, Portuguese, Japanese, Chinese (traditional and simplified), Korean. |
| Init settings | returns the printer to its default settings. All previously saved options are erased. |
| Print settings | prints the current printer settings. |
| LCD contrast | lets you select the contrast level of the display. Range is 1-16, 9 (default) (16 is less contrast) |
| Exit | returns to the Setup menu. |

Ink Option Menu

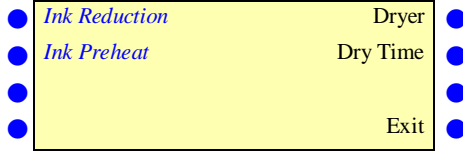

Ink reduction	provides access to a further menu in which to set the percentage by which to decrease the amount of ink emitted to help prevent bleeding or pooling of ink. Options are 0 , 12.5, 25, 37.5, and 50.
Ink preheat	provides access to a further menu to set the ink preheat value for each cartridge. Options are Off, 1-7, Max.
Dryer	provides access to a further menu to turn the dryer Off (default) or On.
Dry time	provides access to a further menu to select the dry time in the range of 0 seconds (default) to 60 minutes. When enabled, the printer waits the selected amount of time after printing before cutting the media or advancing to the next print.
Exit	returns to the Setup menu.

Serial Comm Menu

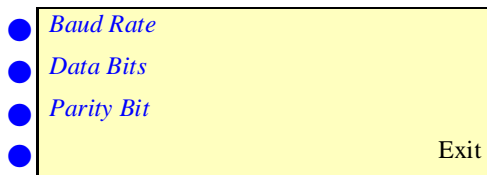

Baud rate	provides access to a further menu to select the baud rate: 9600 (default) , 19200, 38400.
Data bits	provides access to a further menu to select 7 or 8 (default) as the data bit.
Parity bits	provides access to a further menu to select parity: None (default) , Even, Odd.
Exit	returns to the Setup menu.

Utility menu at a glance (Bold indicates the default)

Utility

Prime

Access Cartridge

Color Calib Menu

Calibration Menu

Use Calib XY **ON/off**

Paper Axis Test

Color Db Menu

Paper Axis 32.00 - 34.00

Open Jet Menu

Display settings

Print settings

Service menu

*Servo PWM Test**

*Servo Cycle Test**

*Accessory Menu**

*Carriage Test**

Color Test

*Continuous Test**

Exit

* tech support only

Utility menu (Bold indicates the default)

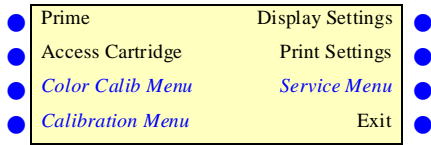

- Prime prints the prime pattern.
- Access Cartridge moves the ink carriage away from the service station for installing and replacing cartridges and the media cutter.
- Color Calib Menu provides access to further menus for printing the color calibration test pattern and for entering values determined by examining the test patterns.
- Calibration Menu provides access to a further menu for calibration options and diagnostics.
- Display Settings displays information such as paper and page width and height, on time, and cumulative plot time.
- Print Settings prints information such as media size, firmware revision, RAM size, and plot hours.
- Service Menu for use by ENCAD technical support only.
- Exit returns to the main menu.

Calibration Menu (Bold indicates the default)



- Use Calib XY provides access to a further menu in which you can set this function on or off.
- Paper Axis Test prints the paper axis test pattern.
- Color Db Menu provides access to a further set of menus in which you can print the color deadband test pattern and set deadband velocity compensation for each cartridge.

- Open Jet Menu provides access to a further set of menus in which you can print the jet status pattern and set the compensation for jets in each cartridge.
- Paper Axis provides access to a further menu in which to enter values determined by examining the paper axis test pattern.

Service Menu (Bold indicates the default)

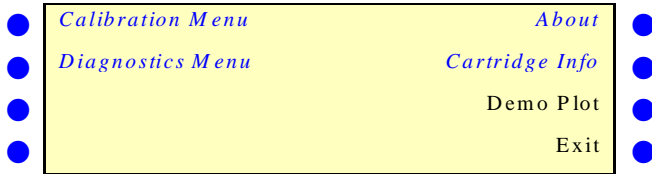

- Calibration Menu provides access to calibration options.
- Diagnostics Menu provides access to a further set of menus for performing diagnostics (tech support only) and for printing the color test.
- About provides information about the printer's firmware version, BROM, RAM, and printer size.
- Cartridge Info provides information about the type and color of ink in each cartridge stall, and the extent to which the cartridge is used; i.e., 1%, 10%, etc. 100% indicates that the cartridge should be replaced. When 256% is displayed, the cartridge will stop functioning.
- Demo Plot automatically prints a test file stored in ROM on the printer. Use only under direction of technical support.

Technical information

D

MEDIA TYPES:

Photo paper, paper matte, drafting films,
and specialty.
See Supplies section for details.

MEDIA ROLL PARAMETERS

Inner roll core: 2" and 3"
Max. outside roll diameter: 4" and 6"
Max. roll width: 60", 42", 54" (photo gloss,
vinyl and matte only), 50", 36", 24"

RESOLUTION:

600 x 600 dpi
300 x 300 dpi addressable

STANDARD FEATURES:

Rollfed with cutter
Power feed and takeup
8 user-savable settings
Power PC 33 MHZ processor
208 jet ink cartridges (4)
500 ml ink reservoirs (4)
Two sets of ink lines (8)
Ink priming system

LINE LENGTH ACCURACY:

+/- 0.2% in paper and carriage axis using
roll feed, 4 mil drafting matte film.

Image frame length (X-axis) variation +/-
0.2% and width (Y-axis) variation +/-0.06%
+/- 0.024" (.6mm).

BUFFER:

Two 72-pin, 32-bit wide DRAM sockets.
32 MB, user upgradeable to 128
MB, 70 ns or faster, ENCAD approved.

INTERFACES:

Bidirectional Parallel (IEEE 1284)
RS-422/232
422 to 9 pin 232 for self-service
Optional 10 Base T, 10 Base 2

BAUDRATES:

9600; 19200; 38400

POWER:

90-246 VAC 47-63 Hz

Consumption:

20 W Idle
140 W Typical
215 W Maximum

OPERATING ENVIRONMENT:

59° - 95°F (15° - 35°C)
10-80% RH, Non-condensing

STORAGE ENVIRONMENT:

-5° - 140°F (-21° - 60°C)
5-80% RH, Non-condensing

CERTIFICATIONS:

Safety
CSA, CSE/NRTL,
(equivalent to UL1950)
TUV GS
EN 50 082-1
EN 60 950
UL1950
NOM-019-SCFI-1993
IEC 950
AS/NZS 3260

EMI

FCC Class A, B
CSA C108.8
EN 55 022 Class A, B
CE Mark
CISPR 22- Class A, B
AS/NZS 3548

Made in the U.S.A.

DIMENSIONS

	60" model	42" model
Height (platen above floor)	44" (1.12m)	44" (1.12m)
Width	95" (2.41m)	77" (1.96m)
Depth	28" (0.71m)	28" (0.71m)
Weight	150 lbs.	136 lbs.
Print width	up to 59.6" printable	up to 41.6" printable

Communications and cabling

E

This appendix defines the serial cable requirements for connecting the printer to your DOS or UNIX based systems. It also includes instructions for setting serial communication parameters.

Parallel cable

You can use any parallel cable which meets IEEE 1284 standards.

RS-232 cable requirements

You may build this cable or purchase it from ENCAD, Inc. For connecting to an Apple Macintosh, use the standard ImageWriter II cable.

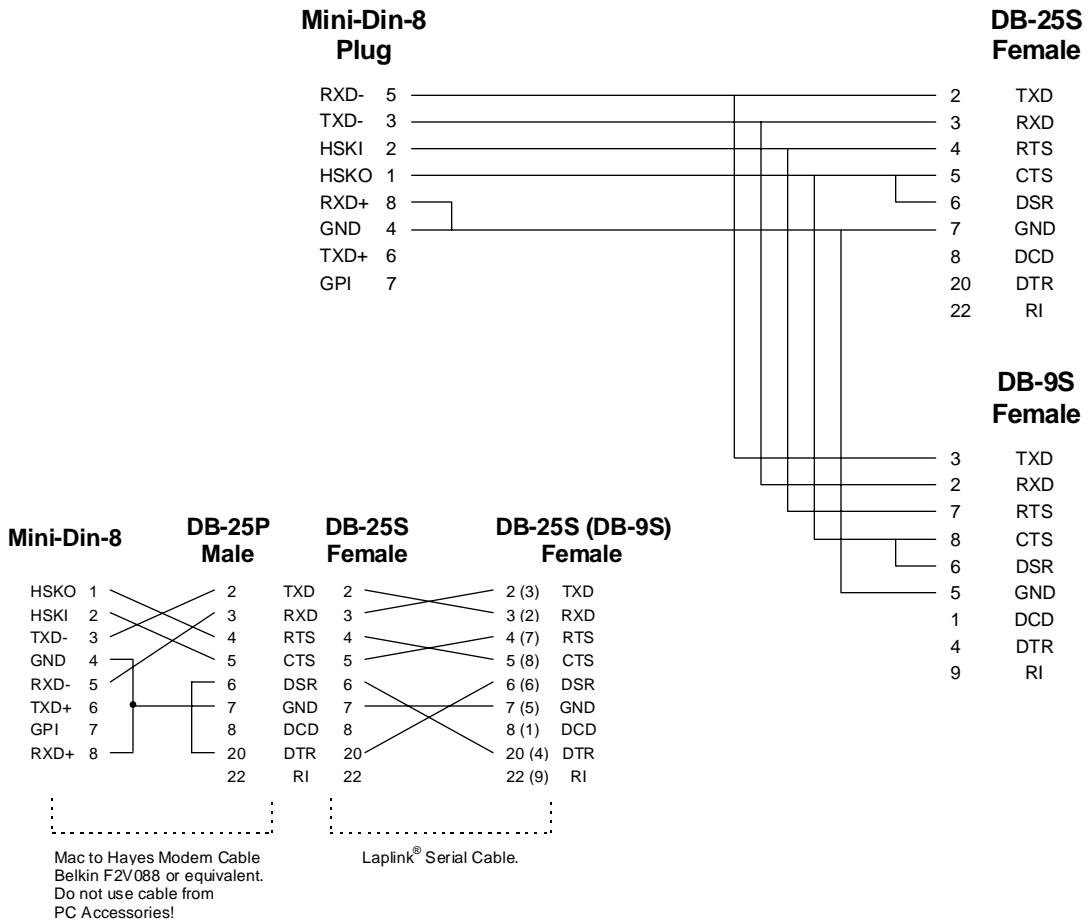

Setting serial communications parameters

If your software or hardware platform only has serial communication capability, check the manuals provided with your system for the required communication parameters prior to setting the RS-422/232 options on the printer.

Setting the baud rate

Baud rate is the data transmission rate (in bits per second) between your computer and the printer. The Serial Communicaitons menu lets you select from the following baud rates: 9600, 19200, 38400



To set the baud rate

- 1 Select Setup/Serial Communications Menu/Baud Rate.
- 2 Choose the desired rate.
- 3 Press OK.

Setting the parity bit

The Serial Communications menu lets you select from the following parity options:

Even, Odd, None



To set the parity bit

- 1 Select Setup/Serial Communications Menu/Parity Bit.
- 2 Choose the desired option.
- 3 Press OK.

Setting the data bit

The Serial Communications menu lets you set the data bit to 7 or 8.



To set the data bit

- 1 Select Setup/Serial Communications Menu/Data Bit.
- 2 Choose the desired option.
- 3 Press OK.

These display messages are helpful in determining the status of the printer and possible corrective action when operation does not appear to be normal.

Error Messages

Error messages consist of the message “Internal ERROR: Shutdown” on line 2 of the display. On line 4, a specific message will appear. If you cannot clear the error, record the message and the sequence of events leading to the message so that you can describe the problem to ENCAD technical support personnel.

If the “Servo shutdown” message displayed, cycle the printer's power to clear the error.

Cartridge Errors

The printer automatically performs tests on the cartridges and uses the information to improve image quality, monitor cartridge life, and update the user with system status. Some tests are performed between prints and require no user input, while others require user input.

The following are cartridge-related error messages.

Error Message	Corrective Action
Unrecognized cartridge	Be sure the cartridge is a NovaJet PRO 600e cartridge. Your printer will not work with NovaJet, NovaJet PRO, or NovaJet PROe cartridges. Remember, the printer is reading the value programmed into the chip on the cartridge, it is not actually detecting the cartridge type. Replace the cartridge if necessary.
Cartridge end of life attained.	Replace cartridge. You can check cartridge status by choosing Cartridge Info from the Service menu. End of cartridge life is indicated as 100%. When 256% is displayed, no further printing occurs until the cartridge is replaced.
Unrecognized ink type.	Be sure the cartridge is a NovaJet PRO 600e cartridge. Your printer will not work with NovaJet, NovaJet PRO, or NovaJet PROe cartridges. Ink type information is stored on the cartridge chip. If you are using a new type of ink which has been introduced since you purchased your printer, you will need to upgrade the printer's firmware to accommodate the new ink type. Check ENCAD's web site at www.encad.com for instructions.

To clear the error, turn the printer off and then on again. Press Utility/Service Menu/Cartridge Info to determine the cartridge for which the error message is displayed. Press Access Cartridges to move the carriage to the position which allows replacement of the ink cartridges. Check to make sure you have ENCAD NovaJet PRO 600e cartridges installed in each position, that they all contain the same type of ink (i.e. GA, GS, or GO) and all cartridges are installed properly. Install new cartridges if necessary.

baud rate	The rate of data transfer (bits per second between the computer and printer).
bit	The smallest unit of digital information used by a computer or printer.
buffer	The part of the printer's memory that is used for receiving and processing plot files.
calibration	The procedures to adjust the ink cartridge alignment and line length accuracy.
carriage axis	The plot area measured parallel to the platen.
Centronics	A standard parallel interface.
configuration	The way that the computer and printer are connected.
dpi	Dots per inch (dpi), the number of dots the printer lays down in an inch.
handshake	A method the computer and printer use to communicate.
inkjet	The nozzle part of the ink cartridge.
ink reduction	A feature set through the control panel or driver software which reduces the amount of ink put down for vector images in HP-RTL format.
interface cable	The cable used to connect the printer to the computer. NovaJet printers use a serial or parallel interface cable.
media	The surface on which the printer prints the image. Media comes in a variety of types, including paper, polyester, canvas, and film.
monochrome	An image that is printed in only one color (usually black).
orientation	The direction of the plotted image on the page.
palette	The available colors for the printer.
paper axis	The long side of the plot area measured at right angles to the platen.
parallel interface	An interface type in which all bytes are transferred simultaneously, making it faster than a serial interface.

parity	A method for checking the transfer of information between the computer and printer.
platen	The surface on which media is placed to print.
plot area	The area in which the printer prints the image, determined by the width of the media.
prime	To clear the ink cartridges by forcing them to fire rapidly. Also, to fill the ink lines with ink.
raster image	A graphic created by dots called bitmaps.
resolution	The sharpness of a printed image as measured by dots per inch.
roll feed	Media that is packaged on a roll and is loaded and fed through the back of the printer.
vector	A graphic created by geometric lines. HP-GL and HP-GL/2 files are vector files.

ENCAD media for NovaJet PRO 600e printers

ENCAD offers a full line of inkjet media which gives you brighter, crisper color from your printer. Choose from a variety of sheet and roll sizes. ENCAD ink and media are optimized to work together and were designed for optimal results on your printer. You can count on:

- Brilliant, saturated colors
- Sharp lines and edges
- No visible bleeding between colors

Note: Media is interchangeable between models unless indicated. Ink and cartridges are specific to the NovaJet PRO 600e printers. Be sure to order supplies specifically for the printer model you are using.

ENCAD supplies ordering information

You can order ENCAD supplies from your Authorized ENCAD Distributor, ENCAD Supplies Dealer or order directly from ENCAD:

For the names of authorized distributors in Europe, Asia, and Latin America, call:

<i>Europe:</i>	Paris, France	Phone: 1-3051-0041	Fax: 1-3051-7080
<i>Latin America:</i>	Austin, TX	Phone: 512-219-8022	Fax: 512-219-7863
<i>Asia:</i>	Hong Kong	Phone: 2-2881-8969	Fax: 2-2881-0912

NovaJet PRO 600e Ink and cartridges

Your printer's extended ink system reduces the interval between cartridge changes. This system is ideal for unattended printing and large batch runs. Each ENCAD NovaJet PRO 600e proprietary cartridge includes the nozzle mechanics, and electrical connections. It draws ink from a reservoir in the printer. The ink reservoirs can be filled at any time for uninterrupted printing. After extensive use, the cartridges do experience some wear and should be replaced.

Ink cartridges use ENCAD's special graphics arts (GA), graphic standard (GS), or graphic outdoor (GO) inks which not only give you vivid color, but actually extend the cartridge's life. The ink system includes:

- ENCAD proprietary NovaJet PRO 600e cartridges
- 500 ml bottles of ink. Available in GA or GS cyan, magenta, yellow, and black. GO ink comes in 250 ml bottles only.

Be sure to order media matched to the type of ink you are using.

Note: Always refill cartridges and reservoirs with the same type and color of ink.

Inkjet media for NovaJet PRO 600e printers

ENCAD Quality Imaging Supplies (QIS) expand the range of projects you can produce with your printer. Put your ENCAD inkjet printer to work creating dazzling presentations, quality fine art, photo-realistic images, impressive signs, eye-catching trade show displays, vivid charts, colorful maps, and more.

Choose from photo and matte media in a variety of thicknesses and coatings, films of various types, and specialty materials including canvas and vinyl.

ENCAD media features proprietary coatings which provide the highest image quality when used with ENCAD inks. Our stringent quality assurance program guarantees consistent coatings, repeatable colors, and outstanding compatibility with ENCAD inks. New types of indoor and outdoor media are being added all the time. To learn more about the latest offerings, check ENCAD's website at www.encad.com or call your supplies dealer.

Photo Paper (Use with Photo Printing mode only)

This photographic-based media is excellent for posters, photo-realistic images, and framed art. Renderings benefit from quality output with this paper. It is also ideal for client, courtroom, or marketing presentations, as well as point-of-purchase signs. Choose the weight and finish appropriate to your project:

QIS Photo Gloss - 7 mil

QIS Photo Semi-Gloss - 7 mil

Gloss and Semi-Gloss Papers (Use with Photo Printing mode only)

When a thinner base is acceptable for your project, you can choose QIS Gloss and Semi-Gloss papers have the same coating as photo papers, but on a thinner base for a more cost-effective solution.

QIS Gloss - 4 mil

QIS Semi-Gloss - 4 mil

Matte Paper

Premium and Specialty matte offer brilliant colors, minimal color bleeding, sharp lines and edges. Both papers are ideal for images with medium to light color fill, such as maps, mechanical or architectural renderings, PC board layouts, and presentation flip charts.

QIS Premium Matte 100 gram (Rolls only)

This paper produces high resolution, no bleed output with no strikethrough for medium color fill and minimal cockle.

QIS Specialty Matte 3 mil (Rolls only)

Excellent for preliminary or working drawings of CAD designs, renderings, maps, or presentation graphics. Images produced on Specialty Matte are far more water-resistant than those produced on other papers.

QIS CAD 24 lb. (Rolls only)

Opaque paper with a coating optimized for inkjet printing. Ideal for preliminary or working drawings of CAD designs, renderings, maps, or presentation graphics

Film

ENCAD polyester-based films are engineered for high-impact and vivid color. Five types of film give you the flexibility to create brilliant overlays, overhead projections, signs, posters, and banners.

QIS Clear Film - 4 mil (Use with Photo Printing mode only)

Optically clear. Its polymer coating gives excellent resolution and color saturation. Use for overlays, such as printed circuit boards, mapping, screen printing, and overhead projection. May be imaged on both sides.

QIS Backlit Display - 5 mil (Use with Photo Printing mode only)

Tough, translucent polyester for high quality, backlight displays. Graphics, scanned images, and photos become even more exciting with illumination. Great for trade shows and point-of-purchase signs.

QIS Ultra White - 4 mil (Use with Photo Printing mode only)

Tough, dimensionally stable, glossy, bright white polyester film. Brilliant for signs, posters, banners, and presentations. Can be imaged on both sides.

Drafting Film - 4 mil

A coated polyester film, matte on both sides. Ideal for final CAD drawings. More dimensionally stable and durable than bonds or vellums.

Specialty**Canvas** (Use with Photo Printing mode only)

Inkjet coated artist canvas for photo-realistic images, art work, portraits, any image which requires an artist canvas look. Quality comparable to photographic glossy media.

Vinyl for GA inks (Use with Photo Printing mode only)

Adhesive backed, matte finish vinyl for large banners, posters, signs, lettering, and point-of-sale.

Vinyl for GO inks (Use with Photo Printing mode only)

A flexible, white, opaque calendered vinyl designed for excellent ink receptivity and durability when used with ENCAD's Graphic Outdoor (GO) inks . Outstanding for outdoor signs.

Overlaminates

Overlaminates are used with ENCAD GO media to seal and protect the graphic. They are available with gloss, matte, or luster surfaces.

Matte Clear Vinyl Cast Overlamine Film

A premium quality, clear, matte, cast vinyl overlamine film for use with ENCAD Graphic Outdoor (GO) media. Recommended for outdoor applications which require glare resistance and durability.

Gloss Clear Vinyl Overlamine Film

A premium quality, clear, high gloss, cast vinyl overlamine film for use with ENCAD Graphic Outdoor (GO) media. Recommended for applications which require extended glossy colors and durability.

Luster Clear Vinyl Overlamine Film

A clear, flexible, semi-gloss calendered vinyl overlamine film for use with ENCAD Graphic Outdoor (GO) media. Recommended for outdoor applications which require vibrant colors and durability.

Media Sizes

Media is typically available in the sizes listed below. Call your authorized ENCAD media dealer for availability.

Cut Sheet Media

Photo gloss (7 mil)	11 x 17"	18x36"	24x36"	A1
Photo semi-gloss (7 mil)	x	x	x	
Gloss (4 mil)	x	x	x	
Semi-gloss (4 mil)	x	x	x	x
Clear film (4 mil)	x	x	x	x
Ultra white film (4 mil)	x	x	x	x
Back lit film (5 mil)	x	x	x	

Roll Media (on 2" diameter core)

	60"	54"	50"	42"	36"	24"
Backlit Film (5 mil.)	X		X	X	X	X
Canvas (20 mil.)			X		X	X
Clear Film (4 mil.)	X		X	X	X	X
Draft Matte (4 mil.)			X		X	X
Gloss Clear Vinyl (Overlam.)	X	X	X		X	
Luster Clear Vinyl (Overlam.)	X	X	X		X	
Matte Clear Film (Overlam.)	X	X	X		X	
Matte Opaque Vinyl (GO)	X	X	X		X	
Opaque Bond (24 lb.)					X	X
Photo Gloss (4 mil.)	X	X	X	X	X	X
Photo Gloss (7 mil.)	X	X	X	X	X	X
Photo Semi-Gloss (4 mil.)	X	X	X	X	X	X
Photo Semi-Gloss (7 mil.)	X	X	X	X	X	X
Polyethylene (Banner)	X	X	X	X	X	X
Premium Matte (100 gr)	X	X	X	X	X	X
Specialty Matte (3 mil.)			X		X	X
Translucent Bond (18 lb.)					X	X
Tyvek	X	X	X	X	X	X
Vellum (20 lb.)					X	X
Vinyl (3 mil.w/adh. back)	X	X	X	X	X	X
Water Resistant Vinyl	X	X	X	X	X	X
Wet Strength	X	X	X	X	X	X
White Film (4 mil.)	X		X	X	X	X

The outside diameter of the roll will vary depending upon the amount of media, media thickness, and media core diameter. The standard is 4 inches outer diameter with a 2 inch core.

Media Cores

Media cores are used with the takeup roll. They are available in the following widths:

60", 54", 50", 42", 36".

Diameters: 2" and 3".

Core adapters are available.

Media Samples

Media samples are available so that you may experiment with a variety of media for your application. Because we are always adding new media, call your authorized ENCAD media dealer for a list of current offerings.

Media Cutter (pkg. of 5)

Replacement blades for your printer. Pre-loaded in a snap-in cartridge for easy changeover.

Troubleshooting

This appendix contains valuable information to help you solve the most common printer problems. The problems addressed are divided into these types:

- Printer health
- Print quality
- Data transfer
- Application software

Troubleshooting quick list

Many common problems can be solved by checking for just three items:

- Is the printer connected to a good power source?
- If using a serial cable, do serial I/O settings match on the printer and computer?
- Does the printer driver software match the emulation selected on the printer?

Isolating problems

You can quickly isolate problems to either the printer, computer/printer interface, or application software using the following procedure:

1. Turn the printer OFF, then ON.
2. Load media, then run a prime to assure that all jets fire. (See "Priming for Cartridge Print Check" in Chapter 2 of the User Guide.)
3. Perform a color calibration. (See Appendix A of the User Guide.)

If your printer fails during any of the above steps, call your ENCAD distributor/dealer or call ENCAD Technical Support. Otherwise, continue with the steps that follow.

4. Send a sample print directly to the printer through the parallel port. For example, on a PC, type:
copy /b <filename>.rtl lpt1.
5. If your computer is running on a network, login and copy the sample file to the printer over the network.
6. If steps 4 or 5 fail, repeat them using another computer.
If any of these steps fail, your printer may not be correctly connected to your computer and/or network. Contact your network administrator or your ENCAD dealer. Otherwise, continue with the steps that follow.
7. Print directly to the printer from several software applications.
8. If you are networked, login and try printing from several software applications.
9. If steps 7 or 8 fail, repeat them using another computer or remove from the network and test standalone.

If one application fails, but others print successfully, that can indicate a problem with a specific software package. Call technical support of the failed product. If all the applications fail, determine what they have in common; for example, a RIP box or Windows driver. Call technical support of the particular vendor.

Printer Health

Printer will not turn on

Make sure the power cord is securely attached to the printer and plugged into an operating outlet.

Make sure the power switch is turned on.

Printer intermittently reboots

Clean and reseal memory SIMMs.

Test and replace memory SIMMs. (See Appendix B of the User Guide.)

Check that power is coming to the printer.

Display does not come on

Check that the power cord is plugged in and the printer switch is turned on.

Push any control panel button. The display should come on.

Printing doesn't start immediately when a file is sent

A short delay between sending the file and starting to print is normal, particularly if you are using a serial port. If you are using the serial port, make sure you're using the correct interface cable and that it is securely connected to the proper ports on both the printer and the computer. (ENCAD serial cable PN 203977)

If you are using a serial interface, make sure that the RS-232/422 settings match the requirements of your hardware and software. (See Appendix E.)

If you are using a Windows application, be sure the Print Manager is OFF. Turn off the Print Manager with the ENCAD Windows driver.

File will not print

If you are using a serial cable, check that it is ENCAD PN 203977 for PC and Unix systems. Be sure that RS232/422 settings in your software match those on your printer. If you are using a parallel cable, be sure it meets the specifications of IEEE 1284.

Check your electrical connections.

From your software application, print to a file and send the file to the printer in DOS using the DOS Copy command. At the DOS prompt, type `COPY /b filename portname` (LPT or COM port). Alternately, use the GO.EXE program. To print the file, type `GO filename`. This program is supplied

on your Utilities disk and can also be downloaded from the ENCAD BBS.

Slow printing under Windows

Windows applications naturally print slower than DOS applications. Be sure the Windows Print Manager is turned OFF.

Takeup roll doesn't turn

Be sure the paper feed option is set to Takeup.

Takeup roll doesn't stop turning

Check that the take-up sensor is not blocked. There should be nothing between the take-up sensor and media.

Automatic cutter doesn't work or tears the paper

Make sure the Auto-Cut option is set to ON.

Make sure Media Supply Type is set to Roll.

Make sure the cutter is properly installed. (See "Installing the Cutter" in Chapter 2 .)

TURN POWER OFF and clean the inside of the black belt using alcohol and a lint-free cloth. Push the carriage back and forth to access all areas of the belt. Manually push the carriage all the way to the left to force the cutter to drop. Turn power on.

If the cutter is worn, replace it. You should replace the cutter after every 200 plots (more or less, depending on the type of media used). (See [Supplies](#) for ordering information.)

Carriage jams

Check for paper jams or blockage.

Be sure the service station is lowering. If it does not lower, push it left and down, or the cutter will not disengage.

Carriage axis failure

This may be caused by using matte paper which may curl and cause carriage axis failure. Be sure to use inkjet quality media. (See [Supplies](#).)

An obstruction in the path of the carriage assembly is hindering carriage movement. The obstruction may or may not be visible. Other common causes include dirty encoder strip, media interference, worn carriage bushings, cutter malfunction, and loose trailing cable connections.

After checking the following items, reboot the printer to ensure proper operation.

Note: If the error re-occurs, observe whether the carriage is in the same or different location.

If the carriage is in the same spot, check the encoder strip for visible damage (clear plastic strip

under the trailing cable tray and above the belt) Refer to the figure which follows.

Printer front view

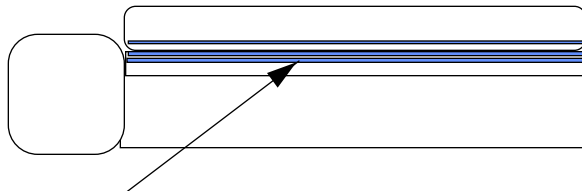

**Encoder strip under second trailing cable cover level,
(clear plastic strip directly behind the shaft)**

Verify that carriage movement is free and smooth by turning the power off and moving the carriage from one end of the shaft to the other (make sure there is no binding and that nothing is blocking the carriage movement). **(MAKE SURE POWER IS OFF BEFORE PERFORMING THIS STEP.)**

Clean the top and bottom of the encoder strip using a cotton swab and distilled water (let it dry completely ~ approximately 30 minutes) before trying to operate the printer).

Remove the cutter from the left side of the carriage and check it for visible damage. Make sure cutter version 3 (or newer) is installed (see the figure below).

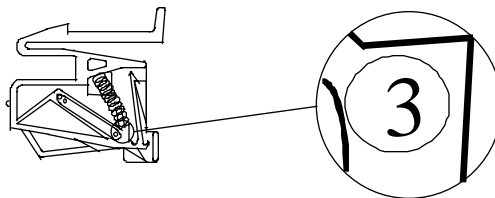

Check the shaft for visible damage (carriage moves back and forth on it during operation).

Clean the shaft with a lint free cloth and isopropyl alcohol (let it dry completely before trying to operate the printer).

Check the belt for visible damage such as fraying and pieces coming off it.

Check the trailing cable (cable that moves during printer operation) for visible damage.

Check whether the idler assembly (located at the left end of the belt) moves freely. Check whether it is cracked or broken.

Cannot draw ink during initial siphon

Check that the quick release fitting connection to the ink reservoir is secure.

Check whether contaminants have blocked the ink delivery lines. If necessary, flush the lines with distilled water, then reprime.

Initial siphon cannot be established

Check that ink reservoirs are full.

Check ink delivery system for leaks in the lines, at the tubing connection, and at the quick connect coupling to the reservoir. If leaks cannot be stopped, call Technical Support.

Ink cartridges do not fire properly

Be sure that cartridges and the service station are cleaned periodically to maintain good print quality. (See "Cleaning Cartridges" in Chapter 4.)

Cartridges may wear out after extended use. Try replacing the cartridge.

Store cartridges in a sealed container at room temperature when not in use for extended periods of time.

Make sure the protective tape is removed from the cartridges.

Remove the cartridge and reinstall it, or clean the electrical contact on the cartridge and carrier. Be sure it is clean and dry. Be sure the cartridge is seated properly. (See "Installing Ink Cartridges" and "Cleaning Cartridges" in Chapter 5.)

Check that ink is being fed through the delivery lines. If necessary, use the NovaPrime to pull ink out of the nozzle plate to remove trapped air bubbles.

Be sure the ink reservoirs are not empty.

Cartridges leaking

Check that reservoirs are not overfilled.

Ensure needle assembly is tightly fastened on top of cartridge.

Various nozzles are clogged or stop firing

Repeat prime several times.

Remove, clean, and reinstall cartridge; repeat prime. Do not use alcohol on the jet area.

Clean service station; clean cartridge again; repeat prime.

Clean cartridge electrical contacts using a cotton swab moistened with water. Dry contact. Repeat prime. Do not use acetone or any other harsh cleaner as this may cause damage to the flex cable.

Nozzle may have failed. Replace cartridge. Check for nozzle clogs by using the NovaPrime on the cartridge nozzle plate.

Check to see whether spray from printing has contaminated the flex contact. Remove the cartridge and wipe the carriage flex and cartridge flex with a cotton swab moistened with water..

Run the jet status plot as described in Chapter 2. If sections of the print are missing, add the affected jets to the compensation list. Replace the cartridge if necessary.

Ink spills on the flex cable

Flex cable refers to the copper contacts on the carriage where the cartridge seats. Clean the flex cable gently with a cotton swab moistened with water. Do not use acetone or any other harsh cleaner as this may cause damage to the flex cable.

Printer settings are lost when printer is turned off or rebooted

Be sure to save your printer settings to a User number. (See "Saving User Settings" in Chapter 3.) When you are ready to print, select the User number that you saved.

What if I need a firmware upgrade?

You can download firmware upgrades from ENCAD's BBS or from the Internet WEB page (www.encad.com).

Firmware Download Procedure (Upgrade/Printer Refresh) You can download the new firmware directly from the diskette, but if you copy the xxxx.ROM and GO.EXE files to a temporary directory on your hard drive, it will load faster.

For Windows:

1. Ensure the printer is turned ON and you have your parallel cable (IEEE 1284) attached between the parallel port on the printer and the parallel port on the host computer.
2. From a DOS prompt type: GO xxxx.ROM and press <ENTER>.

Note: For NT systems, click on Start\Programs\Command Prompt. At the DOS prompt go to the location of the .ROM file. Then type: PRINT /D:LPT1 \XXXX.ROM and press Enter.

Approximately 20 - 40 seconds later a single beep should be heard, indicating the download was successful. After a one second delay, the printer will automatically reboot. The printer should come up normally. Verify the new firmware revision by sequencing through Utility Menu - Service Menu - About menu.

3. If multiple beeps are heard, reboot printer and reseal parallel port connection. Resend the .ROM file to the printer.

For Macintosh:

1. Ensure the printer is turned ON and you have your ImageWriter II cable (RS422-232) attached between the serial port on the printer and the serial port on the host computer.
2. Place the xxxx.ROM file in the Spool folder on the Mac and run the spooler. You don't need the GO.EXE application. Approximately 20 - 40 seconds later a single beep should be heard, indicating the download was successful. After a one second delay, the printer will automatically reboot. The printer should come up normally. Verify the new firmware revision by sequencing through Utility Menu - Service Menu - About menu.
3. If multiple beeps are heard, reboot printer and reseal serial port connection. Resend the .ROM file to the printer.

Print Quality

Many of the print quality concerns can be resolved by priming, cleaning, and calibrating the cartridges. When this is the case, "Prime, clean, calibrate, or replace" is indicated with other solutions. Refer to the following chapters for details:

Prime - see Chapter 2
Clean - see Chapter 4
Calibrate - see Appendix A
Replace - see Chapter 4

No print appears

Check that tape has been removed from the printhead of the cartridge.

White lines or large gaps on print or portions of characters missing

Prime, clean, calibrate, or replace cartridges.

Check if the ink reservoir is empty. Refill if necessary.

Make sure the media feeds freely.

Overall print quality is poor

Prime, clean, calibrate, or replace cartridges.

Make sure the printer is positioned on level ground.

Use a higher quality print mode, such as Photo.

Be sure you are using genuine ENCAD inks and media.

Cartridge spits small amounts of ink on paper

Nozzle plate may be flooded. Try using a lower firing rate or replacing the cartridge. Adjust cartridge preheat as described in Chapter 3.

Streak marks

Clean the service station at least once a week, or more often, depending on the number of prints you are running. (See Chapter 4.)

Prime, clean, calibrate, or replace cartridges.

Line drawings exhibit bleeding

Be sure you are printing on the coated side of the media. Load cut sheet media so that the notch is on the side closest to the carriage. Roll feed media should be loaded so the coated side is on the outside.

If your application software permits, use gamma correction to lighten the color.

Too much air may have been drawn into the cartridge during extended operation. Add 5 ml of ink and reinstall the cartridge.

Colors print as monochrome

Be sure the Color/Mono mode is set correctly. To change a specific drawing from monochrome to color or vice versa, you must switch the Color/Mono setting and re-transmit the file.

Ink smears after removing the print

Be sure the ink is dry before removing the print. If you are printing area fills, you may want to set the Dry Time option. (See "Setting a Dry Time" in Chapter 3.) Turn the dryer on.

Smudged or dark characters

Be sure you are using the correct type of paper for the application. (See [Supplies](#).)

Make sure the paper is straight and unwrinkled when loading it into the printer.

Prime, clean, calibrate, or replace cartridges.

Try a different print mode.

Improperly formed or misaligned characters

Calibrate cartridges.

Color problems or shadowing

Calibrate cartridges.

Excessive graininess

Perform color deadband compensation. Refer to "Aligning the cartridges" in Chapter 2.

Ghosting

The temperature of the print cartridge affects the size of the dots it prints. When the cartridge is warmer it produces slightly larger dots than when it is cool. Several things affect the temperature of the cartridge including the ambient temperature, the number of dots that have recently been printed and the cartridge heater circuit. This change in temperature and subsequent spot size causes what is referred to as “ghosting” or “parasitic suppression”. Ghosting can occur when printing unidirectional if there is an area in the image in which the cartridge is not firing (i.e. a white box within a filled area). Since the cartridge cooled down while it wasn't printing, a light area can appear adjacent to the non-printed area. This light area is “ghosting”. By using the cartridge heaters to warm the cartridge in these non-printed areas, the change in temperature and therefore “ghosting” is minimized. Refer to the figure below which illustrates cartridge heat vs. spot size.

STEPS TO MINIMIZE GHOSTING (PARASITIC SUPPRESSION)

1. Use the preheat function and set the heat to 4 on all the cartridges.
 - On the Main Menu, press Setup Menu/Ink Options Menu/Ink Preheat Menu. In the Ink Preheat menu you will see Cyan - Preheat, Yellow - Preheat, Magenta - Preheat, and Black Preheat.
 - Go into first preheat function and adjust the value to 4 and press OK.
 - Continue this with the three remaining preheat functions.
2. Slow the carriage speed down to 5 or lower.
 - On the Main Menu, press Setup Menu/Print Mode Menu/Carriage Speed. In the Carriage Speed menu, adjust the value to 5 or less and press OK . If you are printing using software to control the printer, you need to make these adjustments in the software.
3. Put the printer in a bi-directional mode.
 - On the Main Menu, press Setup Menu/Print Mode Menu/Print Direction. In the Print Direction menu, adjust the value to BI and press OK . If you are printing using software to control the printer, make these adjustments in the software.

Colors are not correct or sections of print missing

Prime, clean, calibrate, or replace cartridges.

Check ENCAD's WEB site or bulletin board and download the latest Windows drivers. These drivers have calibrated color tables which act as a filter to your file and make the colors come out closer to what is on your computer screen. If you are using a third party RIP, contact the RIP vendor to determine whether they have updated their color tables to work with ENCAD inks. Some RIP vendors that have already updated include EFI, Amiable, Yarc, Vivid Image, Pisa, and Harlequin. If the vendor's files are not yet updated, use the ENCAD Windows drivers.

The Mac print utility provided with the printer already includes calibrated tables which work with NovaJet PRO 600e inks.

Image is the wrong size

Be sure the dpi setting (300 or 600) matches the resolution of your image file. See Chapter 3 for instructions.

Print contains only partial image

Check the settings of the Margins option. When Margins are set to Normal (the default), the print area is smaller than when Margins are set to Expanded. Try setting the Margins option to Expanded to make the print area larger.

The printer may not have correctly sized your media. Use the Manual Load option to load your media. (See "Manual Media Loading" in Chapter 2 in the User Guide.)

The printer automatically prints in portrait orientation (X axis = paper axis). If you rotated the image in your application to save paper, set the paper size to the next larger size (for example, if you are printing a C size image, choose D size paper). Be sure to set Save Media to ON. This stops the printer from scrolling the full paper height.

Jagged vertical lines

Prime, clean, calibrate, or replace cartridges.

If these suggestions fail, call ENCAD Technical Support for instructions on cleaning the encoder strip and performing deadband calibration.

Spotchy area fill

Try using photo mode. If the problem persists, prime, clean, calibrate, or replace cartridges. Adjust cartridge preheat as described in Chapter 3.

Excessive banding in area fills

Consistent banding is generally a hardware problem; inconsistent banding is generally a software problem.

Use specially coated inkjet media. ENCAD provides a full line of high quality inkjet media. (See [Supplies](#).)

Change the Print Mode option to photo . (See "Print Modes" in Chapter 3.)

Prime, clean, calibrate, or replace cartridges.

Set wiper function to off. Adjust cartridge preheat as described in Chapter 3.

Portions of lines are missing

Prime, clean, calibrate, or replace cartridges.

Clean service station; clean cartridge again; repeat prime.

Clean carriage flex cable and cartridge electrical contacts; repeat prime. Do not use alcohol, acetone, or other cleansers. Use a cotton swab moistened in distilled water. Use tap water if distilled water is not available.

Poor vertical or horizontal line quality

Perform color calibration. (See Appendix A.)

Data Transfer**Printer doesn't generate a print**

Be sure your printer is connected to the port to which you are sending the file.

If you are printing over a network, you will need to determine whether the problem is in the network. Try connecting the printer directly to your computer and send the file again.

Parallel printing doesn't work

Some UNIX workstations have difficulty communicating with the printer using a parallel connection. Try connecting the printer to the network using a network interface box.

To ensure the highest quality and reliability of the data that is sent to the printers, the IEEE standard 1284 parallel cable is required to be used when utilizing the parallel port on the printers.

This standard uses shielded twisted pair technology that reduces noise and increases performance at higher transfer speeds.

This cable is recommended on all printers built by ENCAD in 1997 and later.

To order from ENCAD, use part number 208559.

Be sure that your parallel cable does not exceed the maximum of 10 ft.

Try using another parallel cable. Be sure that it is securely connected.

Serial printing does not work

Verify that the serial cable is properly connected.

Be sure that your baud rate, parity, and emulation are set correctly. (See "Setting Serial Communication Parameters" in Appendix E.)

If you are using a serial cable provided by a vendor other than ENCAD, be sure that the pinouts match those in Appendix E. If the non-ENCAD serial cable is not working, order ENCAD cable 203977 (for MAC and Unix systems).

Be sure that your serial cable does not exceed the maximum length of 25 ft.

Problems connecting to a Macintosh workstation

Use the Macintosh chooser level drivers provided by our third-party developers. These drivers generally provide their own cable or parallel cards. One of these drivers is PowerPlot by GDT Softworks (refer to the Software Support Matrix). This is a raster driver similar to MacPlot Raster, but it includes a cable that converts serial to parallel. This cable is connected to the Macintosh's printer port (serial) and to the printer's parallel port.

Serial RS-232/422 Connection

NovaJet PRO 600e models use an ImageWriter II cable with a 8 pin DIN connector on the printer end.

Parallel Connection

Use the Creative Solutions Centronics board which is available from a Macintosh computer store.

Problems printing over a network

Be sure that the printer is configured to run on the network. Pick a driver in your software that is also listed under Emulation on the printer.

No output when printing from Unix

If you encounter “no output” problems when printing from Unix, try the following:

1. Check the printer hardware.
 - Check that the printer is plugged in and turned on.
 - Check that the cable is connected to the port on the printer and the port on the workstation or server.
 - Check that the cable is the correct cable and is not defective.
 - If the printer is connected to a serial port, make sure the cable supports hardware flow control. A NULL modem adapter needs to support this.
 - Check that hardware switches for the port are correctly set.
 - Use the printer's self-test feature or run the demo print to assure that the printer is functioning.
 - Check that the baud settings for the computer and printer are correct. If the settings do not match, the file may be printed incorrectly or not at all.
2. Verify network connections.
 - On a print client or server, type *ping system-name* and press Return. This command checks that the network link between the print server and print client is set up correctly.

If the message says the system is alive, the network is functioning. The message also tells you that either a naming service or the local `/etc/hosts` file has translated the host (system) name entered into an IP address. If it hasn't, you must enter the IP address.

- If you get a “not available” message, check the following:

-
- How is NIS or NIS+ set up at the site?
 - Do you need to take additional steps to allow the print servers and print clients to communicate with each other?
 - If your site is not running NIS or NIS+, have you entered the IP address for the print server in each client's /etc/hosts file and entered all print client IP addresses in the /etc/hosts file of the print server?
 - Check that the port monitor is configured correctly on the print server.
 - Check that the network listen services are registered with the port monitor on the print server.
3. Check the LP print service.
- On both the print server and print client, make sure the LP print service is running.
 - On both the print server and client, make sure the printer is accepting requests.
 - On both the print server and print client, make sure the printer is enabled to print requests.
 - On the print server, make sure the printer is connected to the correct serial port.
 - On both the print server and print client, make sure the printer is configured properly.
 - On the print server, make sure the printer is not waiting because of a fault.
 - Make sure the printer is not set up as a login terminal.

Application Software

Isolating a problem to your software

Sometimes printing problems are application software-specific.

Try printing the “Demo Plot” on the Utilities disk. If the demo prints, the printer's health is probably good.

Try printing a simple file from your application or from another application. If this prints correctly, the problem may be with your software.

If you are using a Windows application and the file does not print from Windows, try printing a file from DOS. If this prints correctly, your problem may be with your Windows driver or Windows setup.

Difficulty generating prints ranging from A to E size

Many software applications limit the maximum print size to “C” or “D” size due to the way that they map their internal coordinate system to memory.

Some applications which limit maximum print size are listed below:

- Microsoft Word: 22 x 22"
- Lotus 123: 17 x 22"
- CorelDRAW: 30 x 30" (TIFF files are limited to 11 x 17")
- Microsoft Project: 36 x 61"
- Micrographx Designer: 68" maximum
- Ashlar Vellum: 101" maximum

Windows GDI Print Length Limitation

The Windows operating system uses a Graphics Device Interface (GDI) which limits printing to 16,000 pixels. The paper length at 600 dots per inch is equal to 16,000 divided by 600.

What all this means is:

There is a limit of 26.66" for vector data in Windows 95. For raster images, the limit is 54.61". It should also be noted that this limitation is only because of the GDI limitations. ENCAD printers do not have this limitation. Length limitations are a function of software or RIP parameters. Any conflicts that do not use the GDI interface should be directed to the software vendors.

These limits are imposed by the Windows 95 Graphics Device Interface. The limitation of 26.66" is based upon a 16,000 pixel limit for a vector. The printer has a resolution of 600 Dots Per Inch (DPI). To find the largest size divide 16,000 by 600 to get the size in inches. (26.66"). The limitation of 54.61" is due to the size of the digital word that is sent between the application and the driver. This word is 16-bits long. The maximum positive value that can be placed in a 16-bit word is 32,767. Therefore, by dividing 32,767 by 600 we get 54.61".

Many Windows applications limit the maximum print size to "C" or "D" size due to the way that they map their internal coordinate system to memory.

Some applications which limit maximum print size are listed below:

Microsoft Word:	22" x 22"
Micrographx Designer:	68" maximum
Lotus 123:	17" x 22"
Ashlar Vellum:	101" maximum
Microsoft Project:	36" x 61"
Adobe PageMaker:	42" x 42"
QuarkXPress:	48" x 48"
CorelDRAW:	30" x 30"*

*(TIFF files are limited to 11" x 17")

*Note: This is a 30" x 30" page size, and is relevant to Corel 5.0 applications only. CorelDRAW 6 is now capable of supporting page sizes beyond 36 x 36 inches to a maximum of 150 feet x 150 feet. Due to a limitation in the HP DesignJet 650C Series printer driver, the

maximum attainable page size is approximately 55 x 55 inches. Larger page sizes may be attainable if the resolution in the driver is lowered. This limitation also applies to the HP 750C plotter, and 16 bit plotter drivers under Win95.

Programs that use their own internal drivers that bypass the Windows operating system are not common but they do exist. Also, other driver programs or RIPs were created specifically to achieve special capabilities including: increased speed, scaling, color correction / calibration, extended print length, etc.

These programs don't use their own operating system. But, they create certain conditions that bypass those particular areas of the Windows O/S limitations.

Some programs with internal drivers to print from include: AutoCAD, MicroStation, FlexiSign Pro, PosterShop, CactusJet, etc. External printer driver RIPs are made by Pisa, Fiery (EFI), ZenoGraphics, Intelligent Systems, Wasatch, etc.

Calling for Help

If you have tried the suggestions in this manual and still need assistance, call the ENCAD dealer where you purchased your printer.

Before you call technical support for help, be sure that you have all of the following information available:

Printer Information

- model
- firmware
- revision (letter)
- memory
- serial number

Computer Information

- model
- operating system
- connection (serial or parallel)

Customer Technical Support

To resolve printer problems, use the suggestions provided in this guide. If you continue to have problems, you can get help from any of the following:

ENCAD Authorized Dealer _____
(write phone number here)

ENCAD BBS 619-452-2653 and 619-452-3768

This bulletin board provides 24-hour access. You can download the latest technical bulletins, driver files and test files.

Internet WEB Page <http://www.encad.com>

ENCAD's web site provides 24-hour access to product news, company information and technical support. You can view and download technical bulletins, driver files, test files, and new firmware.

ENCAD Technical Support Help Desk 619-452-4350

FAX 619-558-4672

Help Desk hours are: 6 a.m. - 5 p.m. Pacific time, Monday through Friday.

When calling, please use the **Technical Support Call Log** at the end of this manual to record the date, problem, case number, and the name of the support representative. This will be helpful if you need to call again on the same or related problems.

When faxing, please use the **Technical Support Fax Report** at the end of this manual.

Troubleshooting Index

A

- application software
 - isolating a problem to I-14
- area fills
 - banding in I-11

B

- banding in area fills I-11
- BBS I-16
- bleeding I-8

C

- carriage
 - axis failure I-3
 - jams I-3
- characters misaligned I-9
- colors
 - incorrect I-10
 - print as monochrome I-8
- colors wrong
 - on intersecting lines I-8
- cutter
 - tears paper I-3

D

- dark characters I-9
- data transfer I-11
- display does not come on I-2

F

- flex cable I-6

I

- ink cartridges
 - do not fire I-5
 - nozzles clogged I-5
- ink smears I-9
- ink spills on flex cable I-6

- ink stops I-11
- intermittent reboot I-2
- Internet I-16

L

- line quality
 - horizontal I-11
 - vertical I-11
- lines
 - jagged I-10
 - missing I-11

M

- Macintosh workstation
 - drivers I-12
 - parallel connection I-12
 - problems connecting to I-12
 - Serial RS-232 connection I-12

N

- network printing problems I-12

P

- parallel
 - Macintosh I-12
- parallel printing
 - doesn't work I-11
- partial image I-10
- partial print I-10
- poor plot quality I-8
- print
 - from Unix I-12
 - not generated I-11
 - partial I-10
- Print Quality I-7
- print quality I-8

- print sections missing I-10
- printer settings lost I-6
- printer will not turn on I-2
- printing
 - slow I-3
 - Windows I-3
- printing doesn't start I-2
- prints
 - difficulty generating D or E size plots I-14

Q

- Quick List I-1
- Plotter Problems I-1

R

- reboot
 - intermittent I-2

S

- Serial Cable I-1
- serial connection
 - Macintosh I-12
- serial printing
 - doesn't work I-11
- shadowing I-9
- smears I-9
- streak marks I-8

T

- takeup roll
 - doesn't stop turning I-3
 - doesn't turn I-3
- Technical Support Help Desk I-16

U

- Unix I-12
 - no output I-12
 - printing to I-12

This page is intentionally blank.

Index

For your convenience, a troubleshooting index is included at the end of Appendix I.

A

- access cartridges, 2-5
- additional memory
 - SIMM installation, B-1
 - SIMM sizes, B-1
- aligning the ink cartridges, 2-13
- alignment values, A-2
- auto-cut, 3-9
- auto-load delay, 3-9
- auto-wipe, 3-10

B

- baud rate, D-1, H-2
 - setting, H-2
- buffer, D-1

C

- cabling, H-1
- calibration menu, C-10
- calibration units
 - defining, A-2
- canceling a print, 2-15
- carriage, 2-5
 - moving, 2-5, 2-6
- cartridge
 - calibration, A-1
- cartridge alignment, 1-10
- cartridge recognition, 2-15
- cartridge recognition error, 2-15
- cartridges
 - aligning color, 2-13
 - caring for, 1-3
 - clear the jets, 2-11
- certifications, D-1
- clogged jets, 2-12
- color correction, 1-8
- color mode, 3-3, 3-4
- color test, 2-10
- communications, H-1

- control panel
 - using, 2-1
- cutter
 - installing, 2-5
 - removing, 2-6

D

- default settings, 3-1
- diagnostics menu, C-10
- diffusion patterns, 1-9
- dither patterns, 1-9
- draft, 3-4
- drivers vs. RIPS, 2-16
- dry time, 3-12
- dryer
 - enabling, 3-12

E

- environment
 - operating, D-1
 - storage, D-1
- error messages, F-1

F

- factors affecting print quality, 1-5
- feed media, C-2

G

- getting started, 2-1

I

- ink
 - caring for, 1-3
 - graphic arts, 1-2
 - graphic outdoor, 1-3
 - graphic standard, 1-3
 - QIS, 1-2
- ink cartridge jet plate
 - cleaning, 4-5

- ink cartridges
 - aligning, 2-13
 - cleaning, 4-4
 - installing, 4-3
 - removing, 4-2
 - storing, 4-2
- ink delivery lines
 - purging, 4-4
- ink options
 - choosing, 3-11
- ink preheat, 3-11
- ink reduction, 3-11
- ink reservoirs
 - filling, 2-6
 - refilling, 4-1
- ink types
 - changing, 4-2
- inkjet media, H-2

J

- jet compensation, 2-13

L

- language
 - choosing, 3-11
 - setting, 2-2
- LCD contrast, 3-13

M

- main menu, C-1
- maintenance, 4-1
- manual jet compensation list, 2-13
- margins
 - setting, 3-9
- media
 - caring for, 1-4
 - choosing the right kind, 1-4
 - loading, 2-2
- media cores, H-6
- media cutter, H-6

- media roll parameters, D-1
- media samples, H-6
- media sizes, H-4
- media standard, 3-5
- menu tree, C-1
- menus
 - using, 2-2

N

- Normal mode, 3-4
- NovaPrime
 - maintaining, 4-7

O

- obtaining quality results, 1-2
- operating environment, D-1
- ordering supplies, H-1

P

- paper axis calibration, A-3
- paper options
 - choosing, 3-5
- parallel cable, H-1
- parity, H-2
 - setting, H-2
- pausing the printer, 2-15
- periodic cleaning, 4-4
- photo CDs, 1-8
- plot area, 3-5
- power, D-1
- power media feed
 - using, 2-3
- prime pattern, 2-10
 - interpreting, 2-11
- print direction, 3-5
- print mode options
 - choosing, 3-1
- print passes, 3-4
- printer information
 - accessing, 4-8
- printer options, 3-1
- printing mode
 - choosing the correct mode, 1-5
- printing the printer settings, 3-1

Q

- quality mode, 3-4
- quality printing factors, 1-5

R

- refilling ink cartridges, 4-2
- reservoirs
 - replacing, 4-3
- resolution, D-1
- returning the printer for service,
 - 4-8
- RIP color profile, 1-9
- roll media
 - loading, 2-3
- RS-232 cable, H-1

S

- save media, 3-9
- scan resolution, 1-7
- scanning, 1-7
- serial communications parameters
 - setting, H-2
- service station
 - cleaning, 4-6
- setup menu, C-3
- sharpening an image, 1-8
- sheet media
 - loading, 2-5
- SIMM installation, B-1
- standard features, D-1
- storage, 4-1
- storage environment, D-1
- storing the printer, 4-8

T

- take-up system
 - using, 2-3
- technical information, D-1
- transporting the printer, 4-8

U

- user settings
 - defining, 3-10
 - use a previously saved, 3-11
- utility menu, C-8

X

- XY calibration, A-2
- XY calibration test pattern, A-3

Free Manuals Download Website

<http://myh66.com>

<http://usermanuals.us>

<http://www.somanuals.com>

<http://www.4manuals.cc>

<http://www.manual-lib.com>

<http://www.404manual.com>

<http://www.luxmanual.com>

<http://aubethermostatmanual.com>

Golf course search by state

<http://golfingnear.com>

Email search by domain

<http://emailbydomain.com>

Auto manuals search

<http://auto.somanuals.com>

TV manuals search

<http://tv.somanuals.com>