

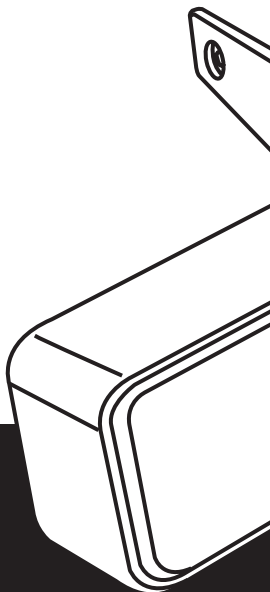

For Customer Service  
Visit Our Website At  
**[www.audiovoxproducts.com](http://www.audiovoxproducts.com)**  
Product Information, Photos,  
FAQ's Owner's Manuals



**AUDIOVOX**  
ELECTRONICS CORP.

**128-9136**

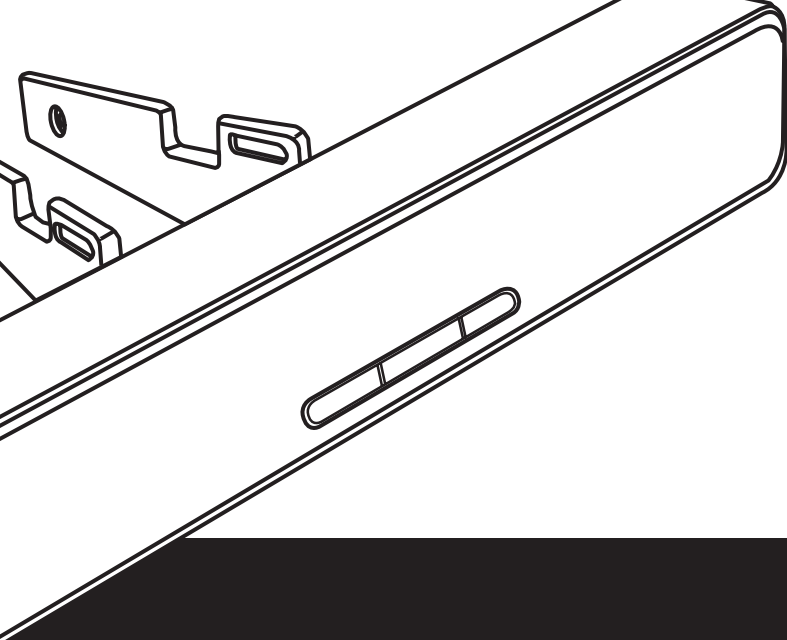

# IPD-SBBT

OWNERS MANUAL

## INTRODUCTION

Congratulations on your purchase of the IPD-SBBT Sound Bar. The IPD-SBBT Sound Bar has Bluetooth® capability.

Please read the instruction manual for this product before using. The documentation provided will allow you to fully enjoy all the features this unit has to offer. Please save this manual for future reference.

Bluetooth® is a trade mark of Bluetooth Special Interest Group (SIG) Inc.

***WARNING! Never install this unit where operation and viewing could interfere with safe driving conditions.***

***WARNING! Never disassemble the unit.***

***WARNING! To prevent injury from shock or fire, never expose this unit to moisture or water.***

## Package Includes:



Sound Bar IPD-SSBT

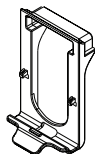

Sound Bar Bracket

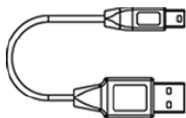

Mini USB charging Cable

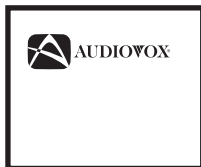

Owner's Manual

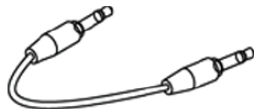

3.5 mm AUX-IN Cable

## IPD-SBBT FRONT VIEW

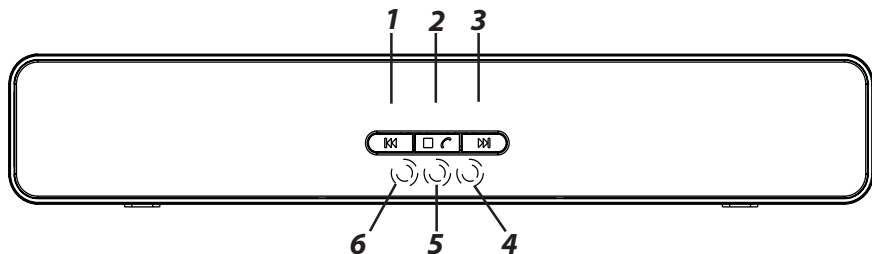

- 1. Previous and Volume Decrease (◀◀) Button:**  
Press the previous button to listen to the previous song on your Bluetooth® device. Press and hold the previous button to decrease the volume.
- 2. Stop (■) and Play (▶) Button:**
  - a) Bluetooth Audio**  
Press the button to stop playback. Press the button again to resume playback.
  - b) Bluetooth Phone**  
Press the stop button to end a call. Press the play button to answer a call.
- 3. Next (▶▶) and Volume Increase (▶▶) Button:**  
Press the next button to listen to the next song. Press and hold the next button to increase the volume.
- 4. Blue LED**  
When the Sound Bar is turned on the LED will blink rapidly. When call is being received the LED will blink rapidly. The LED will blink approximately every five seconds when the Sound Bar is not paired to a Bluetooth® device. When the LED is ON the Sound Bar is connected to a Bluetooth® device.
- 5. Red LED**  
When the LED is ON the battery charge is low.
- 6. Yellow LED**  
When the LED is ON the battery is being charged. When the LED is OFF the battery is fully charged.

## IPD-SBBT REAR VIEW

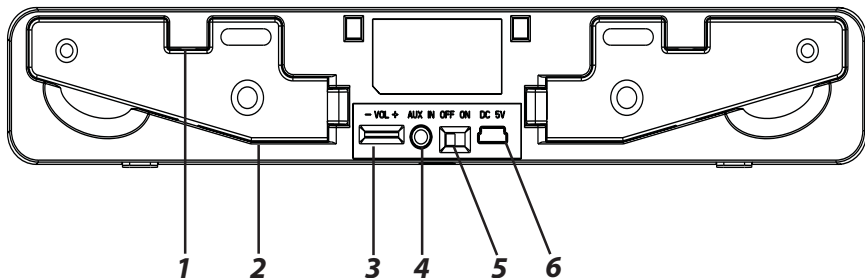

- 1. Device Holder**  
When the stand is in the open position, most tablet devices or cell phones can be placed and held within the stand notches.
- 2. STAND**  
Opens to hold most tablet devices or cell phones placed within the stand notches.
- 3. -VOL+ Adjustment**  
Rotate to increase or decrease the volume.
- 4. AUX IN Jack**  
Accepts a 3.5mm jack which is used to accept audio inputs from an external device. (e.g. - Non Bluetooth players)
- 5. OFF/ON Switch**  
Slide switch used to turn the Sound Bar On and Off.
- 6. DC 5V Mini USB Connector**  
Allows for the connection of a mini USB connector which is used to charge the Sound Bar battery.

## OPERATING INSTRUCTIONS

### Power On/Off

Use the rear panel slide switch to turn the Sound Bar ON and OFF. The LEDs on the front panel light or blink depending on the Sound Bar status.

### Battery Charging

To charge the Sound Bar battery, connect the mini USB connector to the rear panel **DC 5 V** connector. Connect the USB connector to a USB port on a computer. Allow the unit to charge fully before using it. The yellow LED is off when fully charged.

### Volume Adjustment

Rotate the rear panel volume control to increase or decrease the volume. Also a Bluetooth® device can also be used to increase or decrease the volume when the device and the Sound Bar are paired. It is recommended leaving this control at maximum volume and controlling the volume with the connected device.

### AUX-IN Cable for Audio

The Sound Bar has an auxiliary audio input which can accept audio signals from various devices. The AUX-IN jack on the rear panel accepts a 3.5mm jack.

### Bluetooth® Pairing

*NOTE: The following procedure is generic. Procedures for pairing Bluetooth® devices may vary slightly manufacturer to manufacturer.*

1. Turn the the Sound Bar ON. The blue front panel LED will blink rapidly.
2. Select the Bluetooth® setup option on the Bluetooth® device to be paired (please refer to the instruction manual to enter Bluetooth® setup, turn Bluetooth® on/off, and perform pairing). Access the Bluetooth® function and set the Bluetooth® function to ON.
3. A prompt to pair should appear on your Bluetooth® device. Accept the request and initiate the pairing process. A prompt to enter a PIN number or passkey may appear. The default passkey for the Sound Bar is “0000”.
4. At this point a prompt stating pairing complete should appear on your Bluetooth® device.
5. The front panel blue LED will be ON.
6. Once the Sound Bar is paired with the Bluetooth® device **IPD-SBBT** will appear on the Bluetooth® device list screen.

**NOTE:** The Sound Bar memory can store a maximum four paired Bluetooth® devices. If a fifth Bluetooth® device is paired, the first Bluetooth® device will be removed from the memory.

## **Bluetooth® Functions**

### **Music:**

Songs: To change songs press the Previous or Next button.

Volume Control: Press and hold the next button (▶▶) to increase the volume. Press and hold the previous button (◀◀) to decrease the volume.

### **Phone :**

Answer/End a Call: When a cell phone is paired with the Sound Bar press the stop (■)/play (⏪) button to end a call. Press the stop (■)/ play (⏪) button to answer a call.

Redial: Press and hold the stop (■)/ play (⏪) button to redial the last received number.

Voice dial: Press the stop (■)/play (⏪) button twice.

**NOTE:** The cell phone needs to support voice command functions.

During a phone conversation, pressing the next button (▶▶) and the previous button (◀◀) at the same time, will turn OFF the Sound Bar's microphone. Pressing and holding the next button (▶▶) and the previous button (◀◀) again will turn the Sound Bar's microphone OFF.

### **Bluetooth Status Indicator:**

Connecting a previously paired device: The blue LED blinks rapidly.

Pairing: The red and blue LEDs alternately.

Paired: The blue is ON.

Stand-by: The blue LED blinks in 5 seconds interval.

Songs: While playing songs the red and blue LEDs blink at the same time in 5 second intervals.

Receiving a call: When paired and receiving a call the blue LED blinks rapidly.

During Conversation: During a phone conversation the red and blue LEDs blink three times in 1 second intervals.



### Sound Bar Device Stand (may not work with all devices)

1. Place the Sound Bar on a flat surface and open the rear panel stand as shown.

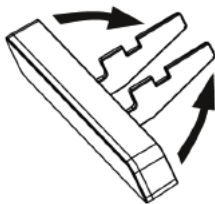

2. Place the device in the Sound Bar holding slot which provide the best fit for your device.

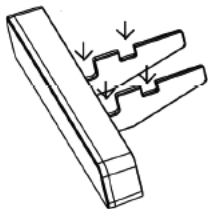

3. The viewing angle of the device in the stand can be adjusted by moving the two stands as shown.

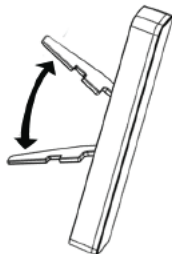
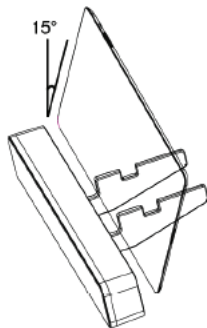

## Sound Bar Vehicle Installation

The Sound Bar can be attached to an optional Audiovox iPad protective case (IPD-1, IPD-2C, IPD-2HP, IPD-2FM, sold separately) for in-vehicle installations. Refer to the figure below.

The included Sound Bar Bracket and optional Audiovox vehicle kit are required for vehicle installations. The headrest post mount and protective case are not included in this package. For further information, refer to the Audiovox website at [www.audiovoxproducts.com](http://www.audiovoxproducts.com).

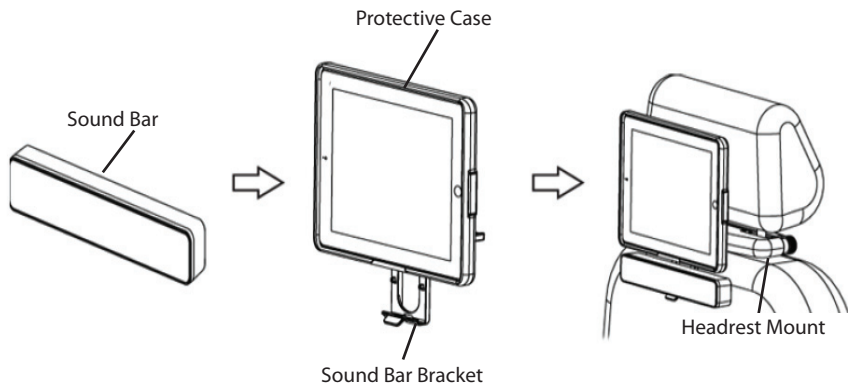

## Sound Bar Bracket Installation

The Sound Bar can be attached to a protective case using the Sound Bar bracket for in vehicle installations. Refer to the figure below.

**NOTE: Before installing the Sound Bar set the Sound Bar volume to the maximum setting. The Sound Bar volume will be controlled through the Bluetooth® device or the volume control of the iPad.**

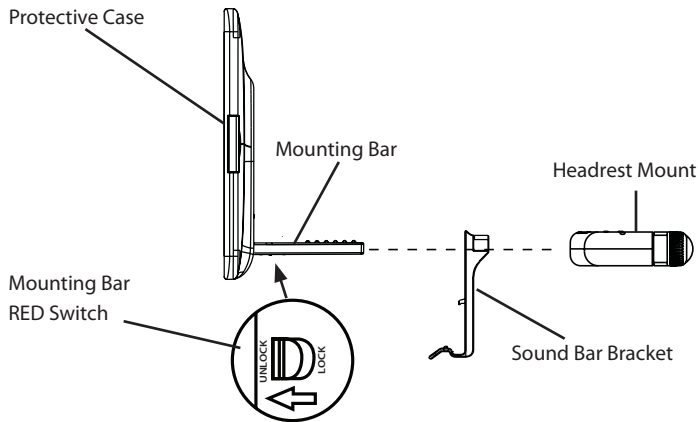

1. Hold the **RED** switch on the Protective Case in the **UNLOCK** position.
2. While holding the **RED** switch on the Protective Case mounting arm in the **UNLOCK** position, insert the Sound Bar Bracket on the Mounting Bar.
3. When the Sound Bar Bracket is fully inserted on the mounting arm, release the RED switch on the Protective Case mounting arm moving the switch to the **LOCK** position.

4. While holding the red switch on the protective case mounting arm in the unlock position, insert the mounting arm with the Sound Bar Bracket into the Headrest Mount and release the red switch to lock the unit into the headrest mount.

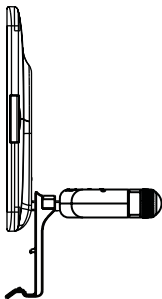

### **Inserting the Sound Bar into the Sound Bar Bracket**

1. Align the two tabs on the Sound Bar Bracket with the two mounting holes on the rear panel of the Sound Bar. Refer to the figure below.

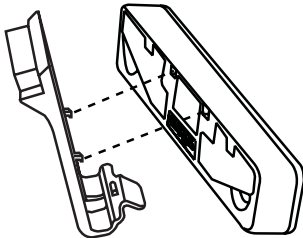

2. Push the Sound Bar down and back into the Sound Bar Bracket.

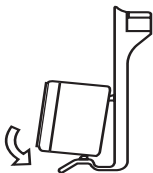

3. The Sound Bar will snap into place on the Sound Bar Bracket.

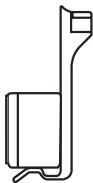

### Removing the Sound Bar from the Sound Bar Bracket

1. To remove the Sound Bar from the Sound Bar Bracket, press downward on the tab located on the bottom of the Sound Bar Bracket. Refer to the figure below.

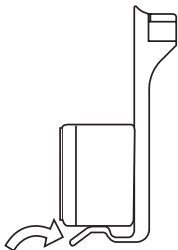

2. The Sound Bar will snap free of the Sound Bar Bracket.

## Product Specifications

Power Input	5V DC 500mA
Battery Life	About 8-10 hrs (Depending on output volume level)
Loudspeaker	2W X 2
Output	85 dB @ 0.5m
Dimensions	1.61 inch (H) X 9.44 inch (W) X 1.10 inch (D) (41mm (H) X 240mm (W) X 28mm (D) )
Weight	8 ounces (218 grams)
Operating Temperature	32°- 113°F (01°- 45°C )
Microphone	-55dB
Bluetooth	3.0 A2DP
Bluetooth Range	40 feet (15 meter)



## 12 MONTH LIMITED WARRANTY

*Applies to Audiovox Mobile Video Products*

AUDIOVOX ELECTRONICS CORP. (the Company) warrants to the original retail purchaser of this product that should this product or any part thereof, under normal use and conditions, be proven defective in material or workmanship within 12 months from the date of original purchase, such defect(s) will be repaired or replaced with reconditioned product (at the Company's option) without charge for parts and repair labor. A game controller, if supplied, is similarly warranted for ninety (90) days.

To obtain repair or replacement within the terms of this Warranty, the product is to be delivered with proof of warranty coverage (e.g. dated bill of sale), specification of defect(s), transportation prepaid, to the Company at the address shown below.

This Warranty does not extend to the elimination of externally generated static or noise, to correction of antenna problems, to costs incurred for installation, removal or reinstallation of the product, or to damage to digital memory/media devices, gaming devices, discs, speakers, accessories, or vehicle electrical systems.

This Warranty does not apply to any product or part thereof which, in the opinion of the Company, has suffered or been damaged through alteration, improper installation, mishandling, misuse, neglect, accident, or by removal or defacement of the factory serial number/bar code label(s). THE EXTENT OF THE COMPANY'S LIABILITY UNDER THIS WARRANTY IS LIMITED TO THE REPAIR OR REPLACEMENT PROVIDED ABOVE AND, IN NO EVENT, SHALL THE COMPANY'S LIABILITY EXCEED THE PURCHASE PRICE PAID BY PURCHASER FOR THE PRODUCT.

This Warranty is in lieu of all other express warranties or liabilities. ANY IMPLIED WARRANTIES, INCLUDING ANY IMPLIED WARRANTY OF MERCHANTABILITY, SHALL BE LIMITED TO THE DURATION OF THIS WRITTEN WARRANTY. ANY ACTION FOR BREACH OF ANY WARRANTY HEREUNDER INCLUDING ANY IMPLIED WARRANTY OF MERCHANTABILITY MUST BE BROUGHT WITHIN A PERIOD OF 24 MONTHS FROM DATE OF ORIGINAL PURCHASE. IN NO CASE SHALL THE COMPANY BE LIABLE FOR ANY CONSEQUENTIAL OR INCIDENTAL DAMAGES FOR BREACH OF THIS OR ANY OTHER WARRANTY. No person or representative is authorized to assume for the Company any liability other than expressed herein in connection with the sale of this product.

Some states do not allow limitations on how long an implied warranty lasts or the exclusion or limitation of incidental or consequential damage so the above limitations or exclusions may not apply to you. This Warranty gives you specific legal rights and you may also have other rights which vary from state to state.



## Free Manuals Download Website

<http://myh66.com>

<http://usermanuals.us>

<http://www.somanuals.com>

<http://www.4manuals.cc>

<http://www.manual-lib.com>

<http://www.404manual.com>

<http://www.luxmanual.com>

<http://aubethermostatmanual.com>

Golf course search by state

<http://golfingnear.com>

Email search by domain

<http://emailbydomain.com>

Auto manuals search

<http://auto.somanuals.com>

TV manuals search

<http://tv.somanuals.com>