



Model AMP-610
500 Watt Stereo Amplifier

**Owner's
Manual**

INDEX

Specifications	1
Precautions	2
Installation Instructions	3
Controls and Indicators.....	4 - 7
Wiring Instructions	7
4-Channel and Mixed-Mono Input Wiring Diagram	8
4-Channel and Mixed-Mono Output Wiring Diagram	9
3-Channel Input Wiring Diagram	10
3-Channel Output Wiring Diagram	11
2-Channel Mono (Bridged) Input Wiring Diagram	12
2-Channel Mono (Bridged) Output Wiring Diagram	13
Warranty	14

HIGH PERFORMANCE STEREO AMPLIFIER

This power amplifier has been designed to provide high quality performance with a minimum of maintenance. However, its performance will only be as good as the care and quality of components with which it is installed. We therefore advise that you read these instructions very carefully to familiarize yourself with the product and its features.

Should you require assistance with the installation or wiring of this unit, please call our toll-free "HELP" line at 1-800-645-4994 during the days/hours shown.

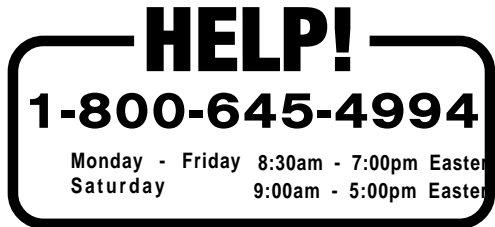

SPECIFICATIONS

Maximum Output Power		Signal / Noise Ratio:	90 dB (A-Weighted)
4-Channel Operation:	125 watts x 4	Input Impedance:	low-level 10K ohms high-level 100 ohms
2-Channel Operation:	500 watts x 2	Input Sensitivity:	low-level 200 mv. - 5 v. high-level 2 - 10 v.
Output Power @ 1% T.H.D.		Supply Voltage:	12 volts, negative ground
4-Channel Operation:	600 watts RMS x 4	Fuse Rating:	20 amps.
2-Channel Operation:	120 watts RMS x 2	Dimensions (W x H x D):	9" x 2-1/4" x 10-5/8" 230 mm x 57 mm x 270 mm
Output Impedance:	2 - 8 ohms (stereo) 4 - 8 ohms (mono)		
Frequency Response:	10 - 50,000 Hz. \pm 1 dB		
Channel Separation:	55 dB		

* Due to continuing improvement, Audiovox reserves the right to change features and design without notice.

PRECAUTIONS

1. Although this unit is designed with built-in self-protection circuits, there may be a possibility of damage if it is not wired correctly. Please follow the wiring instructions carefully for the type of system being used.
2. The last lead to be connected is the wire to the positive (+) terminal of the battery. Connect this wire only after having completed and checked all other connections to the amplifier.
3. By nature of its design, a power amplifier generates heat and requires good air circulation around it to dissipate that heat. Do not install the amplifier in an enclosed area which does not permit adequate air circulation. Should the temperature of the unit rise too high, the internal thermal sensors will shut off operation until it has cooled down sufficiently.
4. If fuse replacement is necessary, use only fuses of the same ampere rating as originally supplied with the unit. The use of fuses with incorrect ratings may cause serious damage to the amplifier. If fuses blow consistently, carefully check all electrical connections to the unit.
5. Supply of adequate battery voltage is critical to the proper operation of the power amplifier. The leads to the battery and chassis ground **must** be of a thick enough gauge to provide this voltage to the amplifier. We recommend #16 gauge wire or thicker (smaller gauge #) for the battery and ground leads.
6. Make certain that the speaker(s) to be used with this amplifier are capable of handling the output power (wattage) of the unit. Use of speaker(s) not rated for the output of this amplifier may cause damage to or failure of the speaker(s) for which Audiovox will not be liable.

INSTALLATION INSTRUCTIONS

1. Select a mounting area where the amplifier will have sufficient air circulation for proper cooling. Inadequate air circulation will cause the temperature of the amplifier to rise and will trigger the thermal protection mode.
2. Place the amplifier on the mounting surface and mark the locations of the four mounting holes as shown in the illustration.
3. Remove the amplifier and drill a 1/8" hole at each of the four locations.

CAUTION: Before drilling the holes, look at the underside of the mounting surface. Always check carefully to avoid drilling into wiring, braces, fuel or brake lines. **CHECK BEFORE YOU DRILL !**

4. Secure the amplifier to the mounting surface using the self-tapping screws provided.

INSTALLATION DIAGRAM

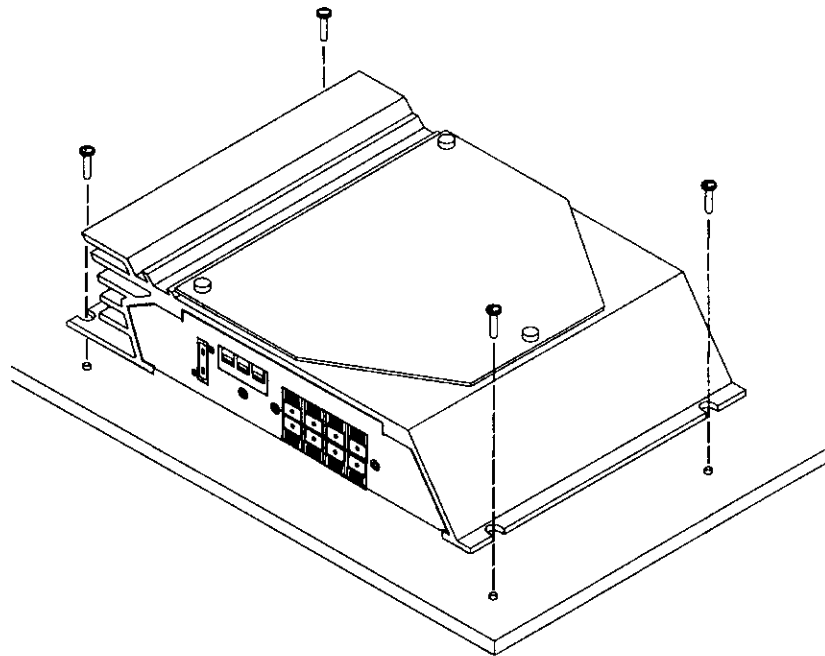

CONTROLS AND INDICATORS

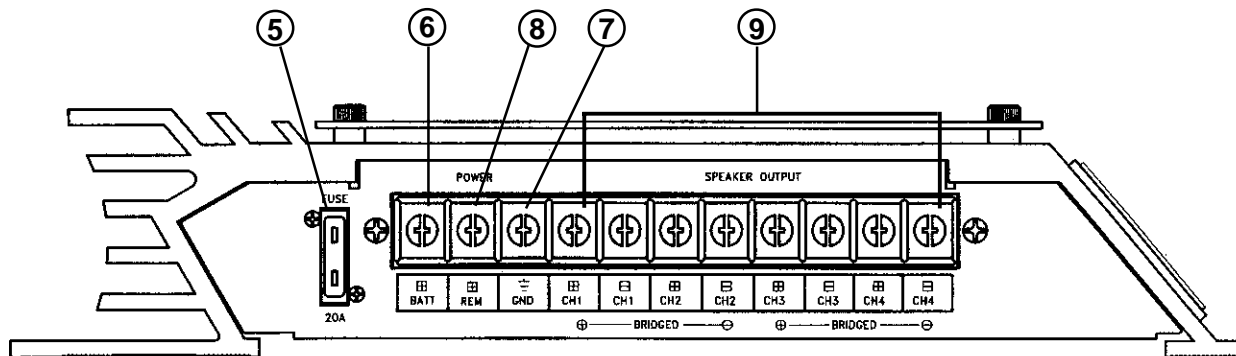
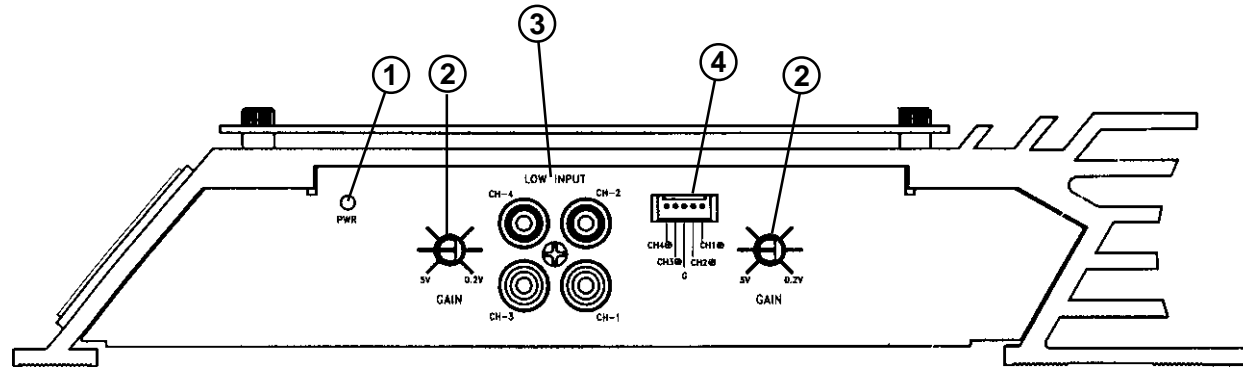

① Power Indicator/Protection Mode LED

The Power Indicator LED will light to indicate that the unit is connected to the battery and that the Remote Turn-On terminal is receiving +12 volts, thus turning on the amplifier.

This LED illuminates red to indicate that the self-protection circuits have been activated and have shut off operation of the amplifier. The protection circuits may be triggered by the temperature of the unit rising above a safe level or by an overload condition. If activated by a rise in temperature, the unit will resume operation after cooling off to a normal operating range. If activated by an overload condition, the source of the overload must be found and corrected to resume operation of the amplifier. Most overload conditions are caused by mis-wiring or operation into incorrect speaker loads. Re-check all wiring and connections if this situation occurs and correct as necessary.

② Level (Gain) Control

The amplifier is capable of operating from sources supplying a wide range of input levels. The Level control should initially be set to the mid-rotation position. If it is found that there is not enough output even when the volume control on the car stereo is at its maximum setting, adjust the Level control to increase the output from the system. If, however, there is still output from the amplifier when the car stereo volume control is at its minimum setting, or the output level increases too fast with a small rotation of the volume control, adjust the Level control to decrease the output from the system. Once the correct setting is found, this control should not require any further adjustment.

③ Low Level Input Connections

If low-level outputs are provided from the car stereo, it is recommended that the low-level inputs be used for lowest distortion and best performance. Use good quality shielded audio cables with RCA plugs at both ends to connect the stereo to the amplifier and keep the cable lengths to a minimum to avoid noise.

CAUTION: Use either the low-level or the high-level inputs on the amplifier.
DO NOT use both input levels at the same time.

④ High Level Input Connection

If the car stereo does not provide low-level outputs, the amplifier may be connected via the speaker (high-level) outputs from the stereo. Wire the speaker leads from the car stereo to the 5-pin adaptor harness as shown in the diagram (shielded cable is not required for this application) and plug the connector into the mating High-Level Input socket on the amplifier. Carefully splice and insulate all wire connections.

⑤ Fuse

The circuitry of the amplifier is protected from damage by an automotive-type fast-blow fuse. If fuse replacement is necessary, use only fuses of the same ampere rating as originally supplied with the unit. The use of fuses with incorrect ratings may cause serious damage to the amplifier. If fuses blow consistently, carefully check all electrical connections to the unit.

⑥ Power Connection

The battery terminal (BATT) must be connected directly to the positive terminal of the vehicle battery to provide an adequate voltage source and minimize noise. Connecting the battery terminal lead to any other point (such as the fuse block) will reduce the power output and may cause noise and distortion. Use only **#16** gauge or thicker (smaller gauge #) wire for this lead and connect it to the terminal of the battery after all other wiring is completed.

⑦ Ground Connection

The ground terminal (GND) connection is also critical to the correct operation of the amplifier. Use a wire of the same gauge as the power connection (**#16** or thicker) and connect it between the ground terminal (GND) of the amplifier and a metal part of the vehicle close to the mounting location. This wire should be as short as possible and any paint or rust at the grounding point should be scraped away to provide a clean metal surface to which the end of the ground wire can be screwed or bolted.

⑧ Remote Turn-On Connection

The amplifier is turned on by applying +12 volts to the remote turn-on terminal (REM). The wire lead to this terminal should be connected to the "Auto-Antenna" lead from the car stereo which will provide the +12 volts only when the car stereo is turned on. If the car stereo does not

provide an Auto-Antenna lead, the remote turn-on lead may be wired to an "Accessory" or "Radio" terminal in the car's fuse block. This will turn the amplifier on and off with the ignition key, regardless of whether the car stereo is on or off. The remote turn-on lead does not carry large currents, so #20 gauge wire may be used for this application.

⑨ **Speaker Connections**

Depending on the type and number of speakers used with the amplifier, wire them to the speaker terminals as per the appropriate wiring diagram. For most applications, #18 gauge wire should be used for the speaker leads but in no case thinner than #20 gauge. For leads in excess of 10 feet, #16 gauge is recommended. When wiring the speakers, pay careful attention to the polarity of the terminals on the speakers and make certain they correspond to the polarity of the corresponding terminals on the amplifier. **DO NOT** ground any speaker leads to the chassis of the vehicle.

WIRING INSTRUCTIONS

The wiring of your amplifier will depend on the system and speakers you are using but will either be a stereo, mono, or mixed-mono application. The following pages illustrate the input and output wiring for both types. Please refer to the appropriate diagrams for the system configuration you are using.

The power and speaker wire connections for this amplifier are made via screw tightened terminal blocks. Loosen the screw for the connection to be made and fully insert the wire (strip 1/2" of insulation from the end) into the respective screw on the side panel (crimp-on "U" terminals are provided to simplify wiring and we recommend their use.) Tighten the screw down to secure the wire. After initial set-up, the amplifier should not require any further adjustment unless there is a change in the car stereo or speaker system with which it is used.

4-CHANNEL AND MIXED-MONO INPUT WIRING DIAGRAM

USE THIS INPUT WIRING WITH OUTPUT WIRING ON PAGE 9

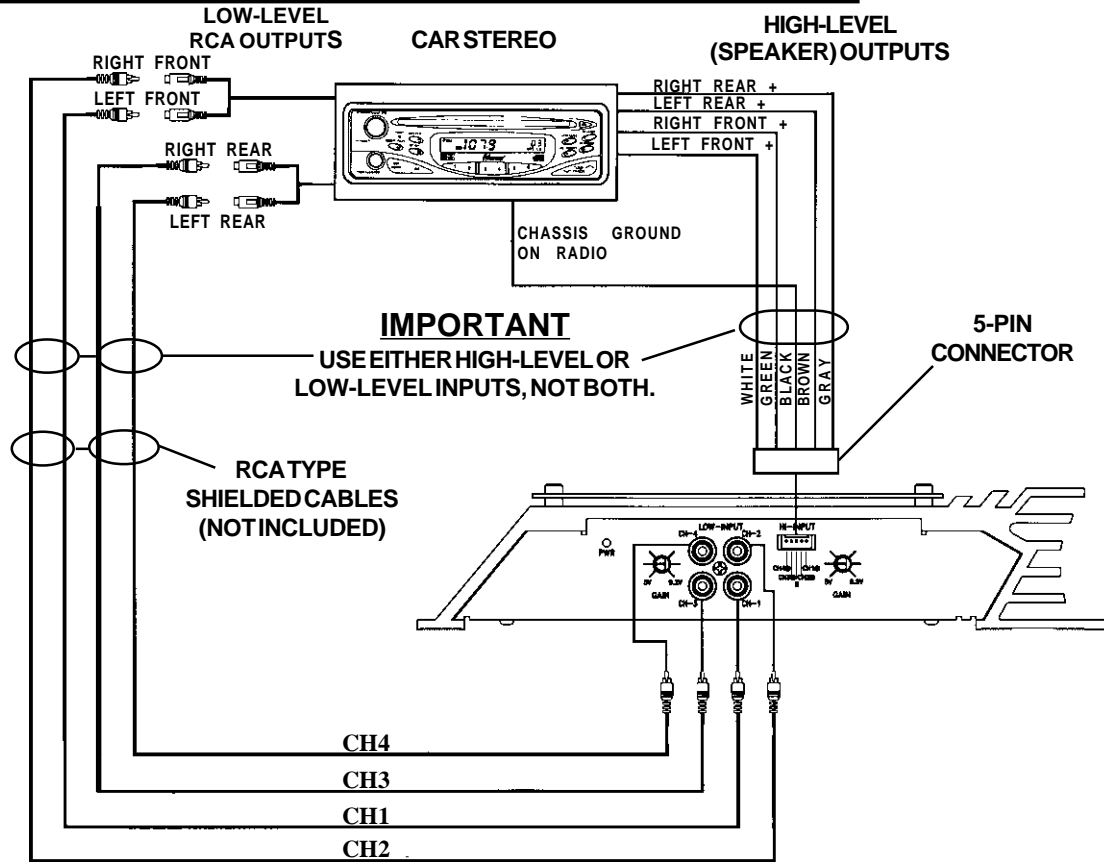



USE THIS OUTPUT WIRING WITH
INPUT WIRING ON PAGE 8

4-CHANNEL AND MIXED-MONO OUTPUT WIRING DIAGRAM

EXISTING SCREW OR BOLT
CLEAN PAINT, RUST, DIRT OR
GREASE FROM AREA FOR GOOD
CONNECTION

SPEAKER IMPEDANCE
4-CHANNEL MODE : 2-8 OHMS
MIXED-MONO MODE : 4-8 OHMS

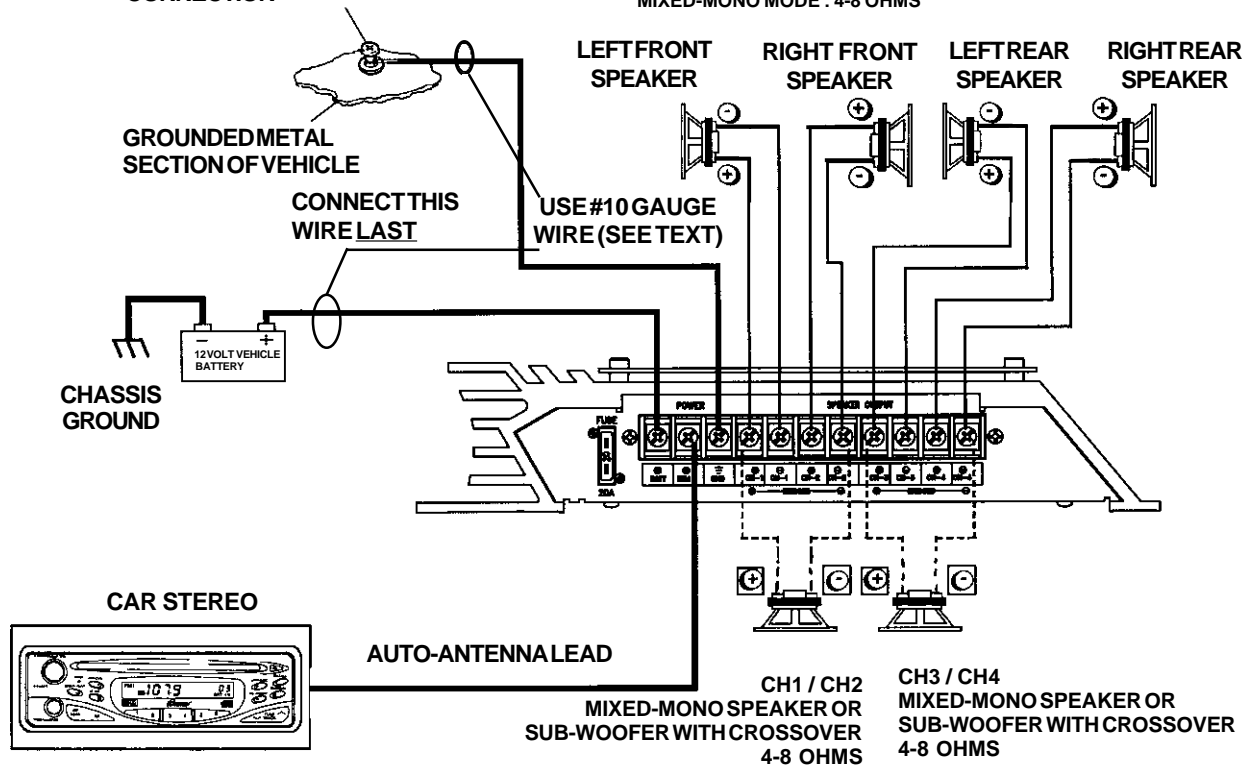

3-CHANNEL INPUT WIRING DIAGRAM

LOW-LEVEL
RCA OUTPUTS

USE THIS INPUT WIRING WITH
OUTPUT WIRING ON PAGE 11

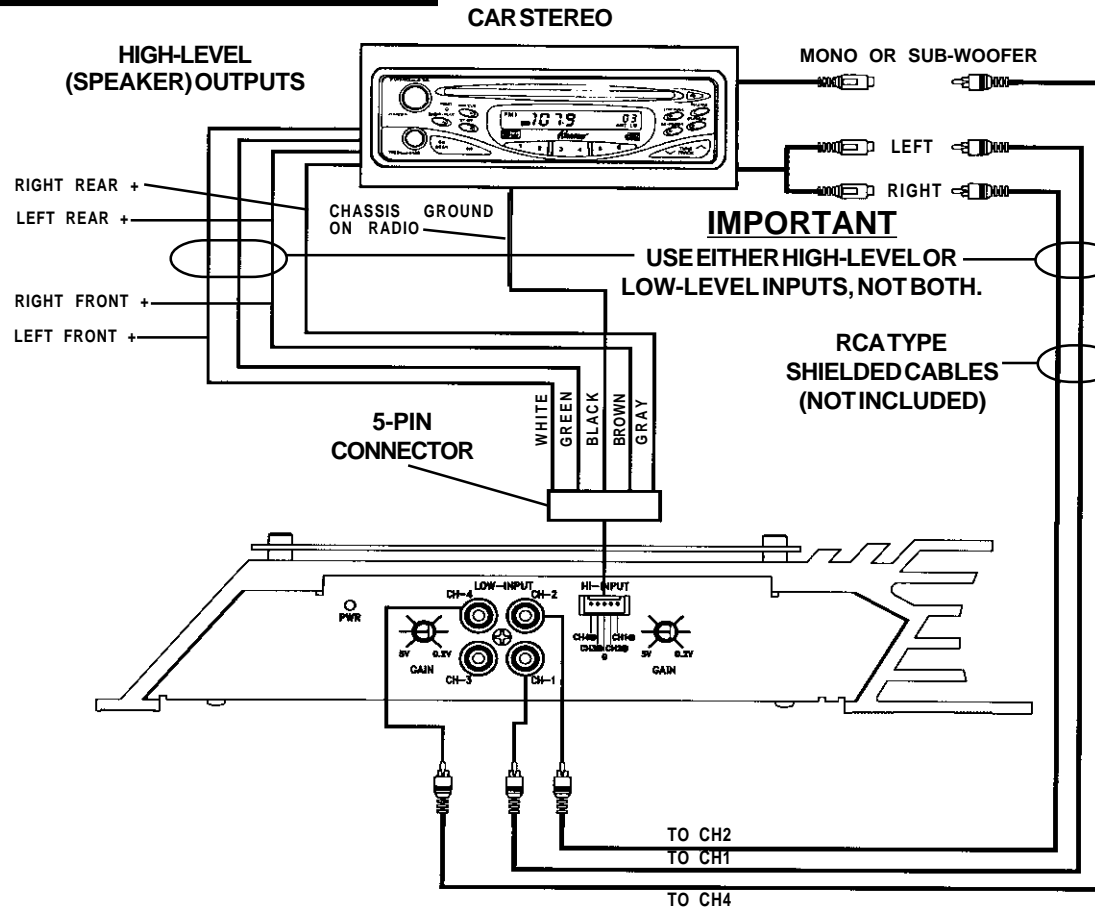

← USE THIS OUTPUT WIRING WITH INPUT WIRING ON PAGE 10
 GROUNDED METAL SECTION OF VEHICLE

3-CHANNEL OUTPUT WIRING DIAGRAM

EXISTING SCREW OR BOLT
 CLEAN PAINT, RUST, DIRT OR GREASE
 FROM AREA FOR GOOD CONNECTION

USE #10 GAUGE WIRE (SEE TEXT)

CONNECT THIS WIRE LAST

SPEAKER IMPEDANCE : 2 - 8 OHMS
 (4 - 8 OHMS IN MIXED-MONO MODE)

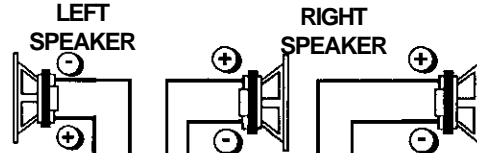

MONOSPEAKER
 OR
 SUB-WOOFER
 4-8 OHMS

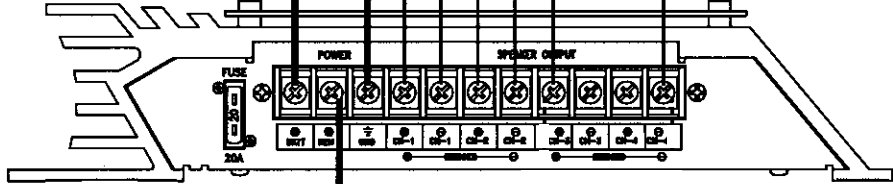
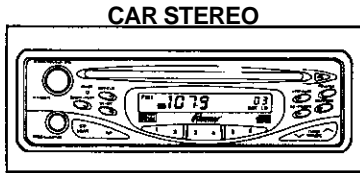
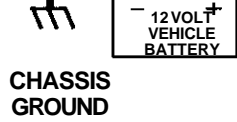

2-CHANNEL MONO (BRIDGED) INPUT WIRING DIAGRAM

USE THIS INPUT WIRING WITH OUTPUT WIRING ON PAGE 13 

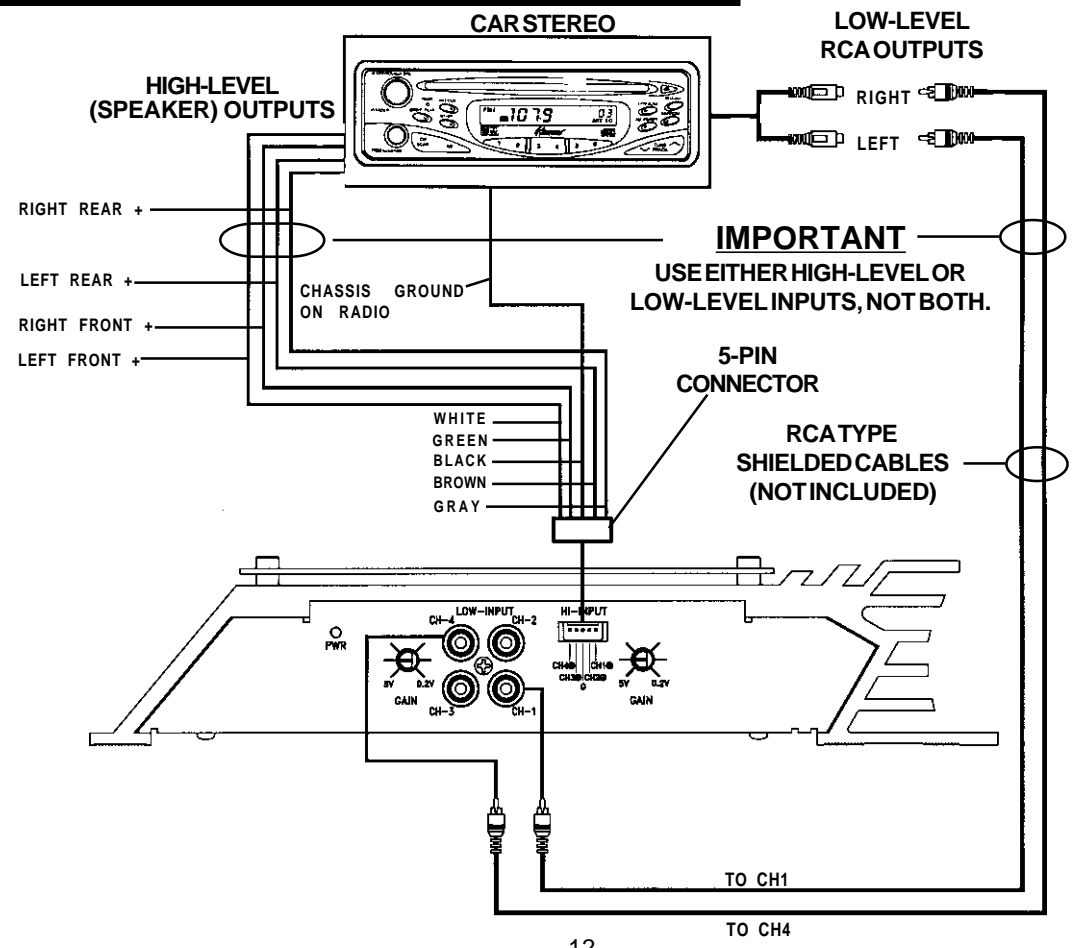



USE THIS OUTPUT WIRING WITH
INPUT WIRING ON PAGE 12

2-CHANNEL MONO (BRIDGED) OUTPUT WIRING DIAGRAM

EXISTING SCREW OR BOLT
CLEAN PAINT, RUST, DIRT OR GREASE FROM AREA FOR GOOD
CONNECTION

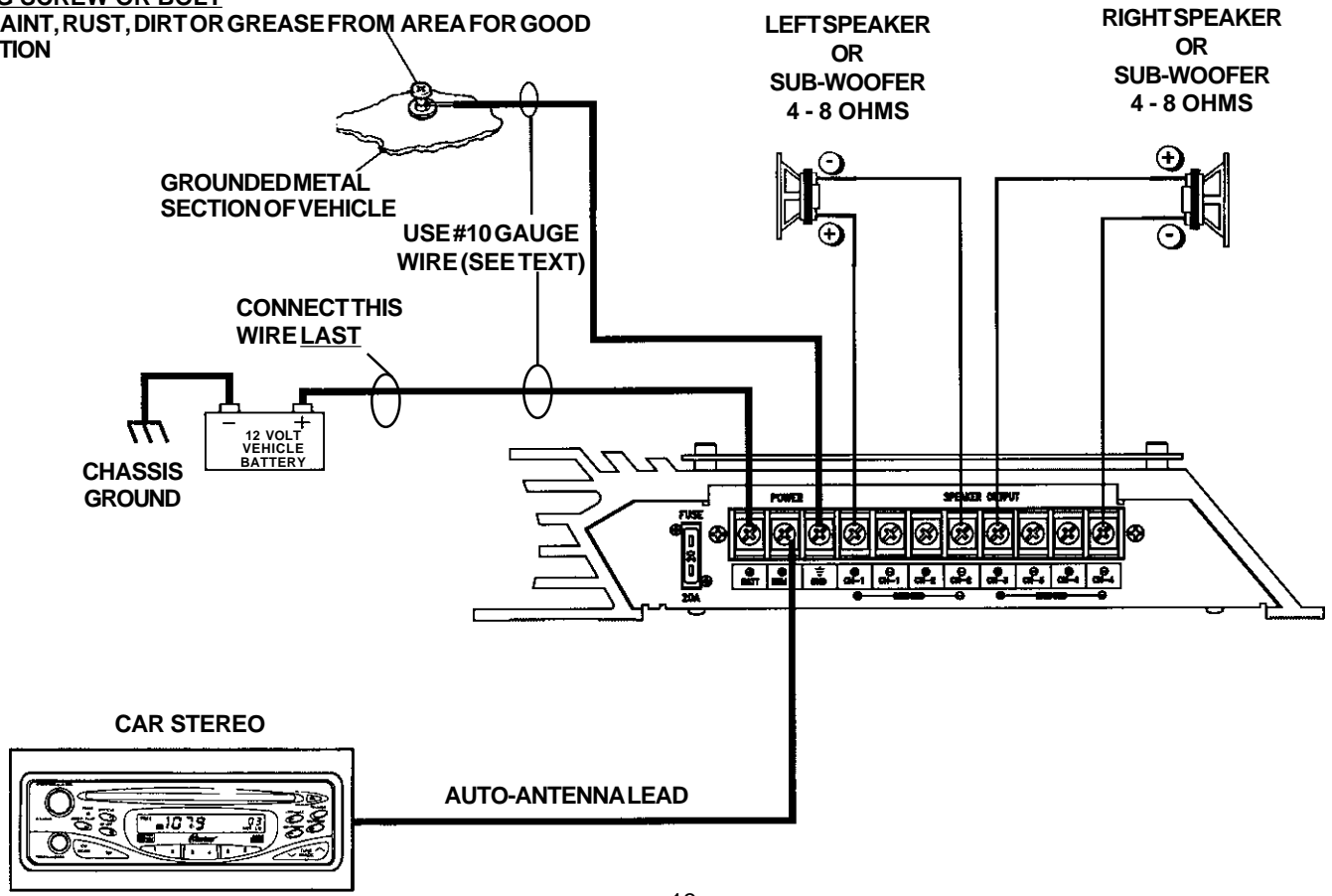



90 DAY/12 MONTH LIMITED WARRANTY

Applies to car stereo power amplifiers, equalizers and accessories.

AUDIOVOX CORPORATION (the Company) warrants to the original retail purchaser of this product that should this product or any part thereof, under normal use and conditions, be proven defective in material or workmanship within 90 days from the date of original purchase, such defect(s) will be repaired or replaced with new or reconditioned product (at the Company's option) without charge for parts and repair labor. After the initial 90 day period and for a period of 12 months from the date of original purchase, the Company will supply at no charge a replacement for any defective part(s) but will charge for the labor to repair the product.

To obtain repair or replacement within the terms of this Warranty, the product is to be delivered with proof of warranty coverage (e.g. dated bill of sale), specification of defect(s), transportation prepaid, to an approved warranty station or the Company at the address shown below.

This Warranty does not extend to the elimination of externally generated static or noise, to correction of antenna problems, to costs incurred for installation, removal or reinstallation of the product, or damage to tapes, compact discs, speakers, accessories, or vehicle electrical systems.

This Warranty does not apply to any product or part thereof which, in the opinion of the Company, has suffered or been damaged through alteration, improper installation, mishandling, misuse, neglect, accident, or by removal or defacement of the factory serial number/bar code label(s). THE EXTENT OF THE COMPANY'S LIABILITY UNDER THIS WARRANTY IS LIMITED TO THE REPAIR OR REPLACEMENT PROVIDED ABOVE AND, IN NO EVENT, SHALL THE COMPANY'S LIABILITY EXCEED THE PURCHASE PRICE PAID BY PURCHASER FOR THE PRODUCT.

This Warranty is in lieu of all other express warranties or liabilities. ANY IMPLIED WARRANTIES, INCLUDING ANY IMPLIED WARRANTY OF MERCHANTABILITY, SHALL BE LIMITED TO THE DURATION OF THIS WRITTEN WARRANTY. ANY ACTION FOR BREACH OF ANY WARRANTY HEREUNDER INCLUDING ANY IMPLIED WARRANTY OF MERCHANTABILITY MUST BE BROUGHT WITHIN A PERIOD OF 30 MONTHS FROM DATE OF ORIGINAL PURCHASE. IN NO CASE SHALL THE COMPANY BE LIABLE FOR ANY CONSEQUENTIAL OR INCIDENTAL DAMAGES FOR BREACH OF THIS OR ANY OTHER WARRANTY, EXPRESS OR IMPLIED, WHATSOEVER. No person or representative is authorized to assume for the Company any liability other than expressed herein in connection with the sale of this product.

Some states do not allow limitations on how long an implied warranty lasts or the exclusion or limitation of incidental or consequential damage so the above limitations or exclusions may not apply to you. This Warranty gives you specific legal rights and you may also have other rights which vary from state to state.

U.S.A. : AUDIOVOX CORPORATION, 150 MARCUS BLVD., HAUPPAUGE, NEW YORK 11788 • 1-800-645-4994

CANADA: CALL 1-800-645-4994 FOR LOCATION OF WARRANTY STATION SERVING YOUR AREA

128-5422A

Free Manuals Download Website

<http://myh66.com>

<http://usermanuals.us>

<http://www.somanuals.com>

<http://www.4manuals.cc>

<http://www.manual-lib.com>

<http://www.404manual.com>

<http://www.luxmanual.com>

<http://aubethermostatmanual.com>

Golf course search by state

<http://golfingnear.com>

Email search by domain

<http://emailbydomain.com>

Auto manuals search

<http://auto.somanuals.com>

TV manuals search

<http://tv.somanuals.com>