

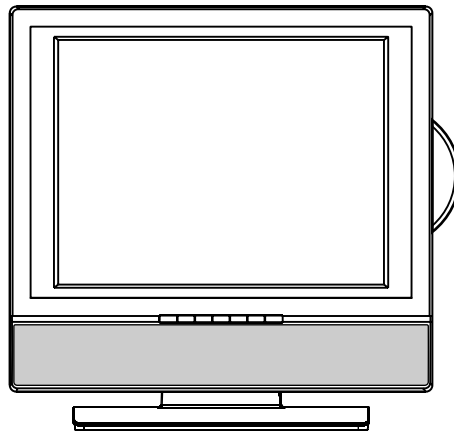

FPE1507DV

**15" FLAT PANEL LCD TV
WITH BUILT-IN DVD PLAYER**



OWNER'S MANUAL



FOR ASSISTANCE CALL CUSTOMER SERVICE AT 1-800-645-4994
OR VISIT US AT WWW.AUDIOVOX.COM

128-8057

PLV21150CS1 - AUDIOVOX ENGLISH IB
I/B [P/N: 811-211591W200]
SIZE : 148 X 210MM
MATERIAL : 80g WOODSFREE PAPER
19-04-2007

Printed in China
811-211591W200

SAFETY PRECAUTIONS



* SEE REAR OF UNIT FOR GRAPHIC SYMBOLS *

WARNING : TO REDUCE THE RISK OF ELECTRIC SHOCK, DO NOT REMOVE COVER (OR BACK). NO USER-SERVICEABLE PARTS INSIDE. REFER SERVICING TO QUALIFIED PERSONNEL.

WARNING : TO PREVENT FIRE OR SHOCK HAZARD, DO NOT EXPOSE THIS UNIT TO RAIN OR MOISTURE. DO NOT PLACE OBJECTS FILLED WITH LIQUIDS ON OR NEAR THIS UNIT.

CAUTION : DANGER OF EXPLOSION IF BATTERY IS INCORRECTLY REPLACED. REPLACE ONLY WITH THE SAME OR EQUIVALENT TYPE.



The lightning flash with an arrowhead within a triangle alerts you to uninsulated dangerous voltage within the product's enclosure that could cause an electric shock.



The exclamation point within a triangle alerts you to the presence of important operating, maintenance and servicing instructions in this user's manual.



CLASS 1 LASER PRODUCT



The symbol for Class II (Double Insulation)



This product contains a low power laser device.

PLACEMENT INFORMATION

- Do not use this unit in places which are extremely hot, cold, dusty, or humid.
- Do not restrict the air flow of this unit by placing it somewhere with poor air flow, by covering it with a cloth, or by placing it on bedding or carpeting.

SAFETY INFORMATION

- When connecting or disconnecting the AC cord, grip the plug and not the cord itself. Pulling the cord may damage it and create a hazard.
- When you are not going to use the unit for a long period of time, disconnect the AC cord.

CONDENSATION INFORMATION

- When left in a heated room where it is warm and damp, water droplets or condensation may form inside the unit. When there is condensation inside the unit, the unit may not function normally. Let the unit stand for 1-2 hours before turning the power on, or gradually heat the room and let the unit dry before use.

FCC INFORMATION

WARNING: Changes or modifications to this unit not expressly approved by the party responsible for compliance could void the user authority to operate the equipment.

NOTE: This equipment has been tested and found to comply with the limits for a Class B digital device, pursuant to part 15 of the FCC Rules. These limits are designed to provide reasonable protection against harmful interference in a residential installation. This equipment generates, used in accordance with the instructions, may cause harmful interference to radio communications. However, there is no guarantee that interference will not occur in a particular installation. If this equipment does cause harmful interference to radio or television reception, which can be determined by turning the equipment does cause harmful interference to radio or television



SAFETY PRECAUTIONS

reception, which can be determined by turning the equipment off and on, the user is encouraged to try to correct the interference by one or more of the following measures:

- Reorient or relocate the receiving antenna.
- Increase the separation between the equipment and receiver.
- Connect the equipment into an outlet on a circuit different from that to which the receiver is connected.
- Consult the dealer or an experienced radio/TV technician for help.

Shielded cables must be used with this unit to ensure compliance with the Class FCC limits.

NOTES ON COPYRIGHT

It is forbidden by law to copy, broadcast, show, broadcast on cable, play in public, or rent copyrighted material without permission.

Apparatus Claims of U.S. Patent Nos. 4,907,093; 5,315,448; and 6,516,132 licensed for limited viewing uses only.

This product incorporates copyright protection technology that is protected by U.S. patents and other intellectual property rights. Use of this copyright protection technology must be authorized by Macrovision, and is intended for home and other limited viewing uses only unless otherwise authorized by Macrovision. Reverse engineering or disassembly is prohibited.



WARNING: Should any problems occur, disconnect the AC cord and refer servicing to a qualified technician.

IMPORTANT SAFETY INSTRUCTIONS

1. Read these instructions.
2. Keep these instructions.
3. Heed all warnings.
4. Follow all instructions.
5. Do not use this apparatus near water.
6. Clean only with a dry cloth.
7. Do not block any ventilation openings. Install in accordance with the manufacturer's instructions.
8. Do not install near any heat sources such as radiators, heat registers, stoves, or other apparatus (including amplifiers) that produce heat.
9. Do not defeat the safety purpose of the polarized or grounding-type plug. A polarized plug has two blades with one wider than the other. A grounding type plug has two blades and a third grounding prong. The wide blade or the third prong are provided for your safety. If the provided plug does not fit into your outlet, consult an electrician for replacement of the obsolete outlet.
10. Protect the power cord from being walked on or pinched particularly at plug, convenience receptacles, and the point where they exit from the apparatus.
11. Only use attachments/accessories specified by the manufacture.
12. Use only with the cart, stand, tripod, bracket, or table specified by the manufacturer, or sold with the apparatus.  When a cart is used, use caution when moving the cart/apparatus combination to avoid injury from tip-over.
13. Unplug this apparatus during lightning storms or when unused for long periods of time.
14. Refer all servicing to qualified service personnel. Servicing is required when the apparatus has been damaged in any way, such as power-supply cord or plug is damaged, liquid has been spilled or objects have fallen into the apparatus, the apparatus has been exposed to rain or moisture, does not operate normally, or has been dropped.

TABLE OF CONTENTS

SAFETY PRECAUTIONS	2 – 3	SPECIAL FUNCTIONS	22
IMPORTANT SAFETY INSTRUCTIONS	4	Display Function (DVD)	22
DISC FORMATS	6	Locating a Specific Title (DVD)	22
REMOTE CONTROL	7	Locating a Specific Chapter/Track	22
ACCESSORIES	7	Locating a Specific Time	22
REMOTE CONTROL REFERENCE GUIDE	8 – 9	CD/DVD PROGRAMMABLE MEMORY	23
UNIT REFERENCE GUIDE	10 – 11	Programmable Memory	23
CONNECTIONS	12 – 16	Title/Chapter Programmed Playback (DVD)	23
Connecting a TV Antenna/Cable/Satellite	12	Track Programmed Playback (CD)	23
Connecting an Audio Amplifier	12	REPEAT PLAYBACK	23 – 24
Connecting an A/V Device (VCR, PVR Camcorder, Game System, etc.) ..	13 – 15	Repeating a Chapter/Title (DVD)	23
Connecting a High-Definition (HD) Source	16	Repeating a Single Track/Whole CD (CD)	23
Connecting a PC	16	Repeating a Specific Section (DVD) (CD)	24
POWER SUPPLY	17	PLAYING A PICTURE FILE DISC	24
Using the Car Power Adapter	17	CUSTOMIZING THE DVD FUNCTION SETTINGS	25
Using the AC Power Adapter	17	Language Setup	25
INSTALLATION	18	Video Setup	25
Removing the Base Stand	18	System Setup	25
Mounting on the Wall	18	<i>TV Type</i>	25
USING HEADPHONES	19	<i>Default</i>	25
UNIT OPERATION	19	TV SETUP	26 – 31
Turning the Unit on	19	Video Menu	26
Turning the Unit on for the First Time	19	<i>VGA Settings in PC Mode</i>	27
SOUND SYSTEM	19	Audio Menu	27
CD/DVD OPERATION	20 – 21	TV Menu	28
Playing a Disc	20	<i>Channel Skip Setting</i>	28
Pausing Playback (Still Mode)	20	Setup Menu	28 – 30
Stopping Playback	20	<i>Time Setup Setting</i>	29
Skip (Forward/Reverse)	20	<i>Caption Setting</i>	30
Fast Forward/Fast Reverse	20	<i>Restore Setting</i>	30
Slow-motion Play (DVD)	20	Parental Menu	30 – 31
Audio Selection (DVD)	21	<i>Password</i>	30
Subtitle Selection (DVD)	21	<i>Parental Control Setting</i>	31
Angle Selection (DVD)	21	LANGUAGE CODE LIST	32
		MAINTENANCE	33
		TROUBLE SHOOTING GUIDE ...	34 – 35

DISC FORMATS

This unit can playback:



DVDS
[8CM/12CM DISC]

JPG-CD
picture viewer



AUDIO CDS
[8CM/12CM DISC]

CD-R/CD-RW
Compatible

REGION MANAGEMENT INFORMATION

Region Management Information: This unit is designed and manufactured to respond to the Region Management Information that is encoded on DVD discs. If the region number printed on the DVD disc does not correspond to the region number of this unit, this unit cannot play that disc.

The region number of this unit is .

DISC FUNCTION OR OPERATION THAT IS NOT AVAILABLE

When the symbol appears on the screen, it indicates that the function or operation attempted is not available at that time. This occurs because the DVD disc manufacturer determines the specific functions. Certain functions may not be available on some discs. Be sure to read the documentation provided with the DVD.

ICONS USED ON DVDS

Sample Icons

	1. English 2. French	Language selections for audio
	1. English 2. French	Language selections for subtitles
		Screen aspect ratio
		Multiple camera angles
		Region code indicator

Notes:

- When playing back a CD-G (Graphics) or CD EXTRA disc, the audio portion will be played, but the graphic images will not be shown.

TITLE, CHAPTER AND TRACKS

- DVDs are divided into "titles" and "chapters". If the disc has more than one movie on it, each movie would be a separate "title". "Chapters" are sections of titles.

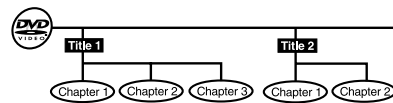

- Audio CDs are divided into "tracks". A "track" is usually one song on an Audio CD.



Note:

- Numbers identify each title, chapter, and track on a disc. Most discs have these numbers recorded on them, but some do not.

Notes on Unauthorized Discs

You may not be able to play some DVD discs on this unit if they were purchased from outside your geographic area or made for business purposes.

REMOTE CONTROL

USING THE REMOTE CONTROL

- Point the remote control at the REMOTE SENSOR located on the unit.
- When using this unit in very bright light, the infrared REMOTE CONTROL SENSOR may not work properly.
- The recommended effective distance for using the remote control is about 16 feet (5 meters).

TO CHANGE THE REMOTE CONTROL BATTERY

1. Open the battery door.
2. Insert two "AA" batteries.

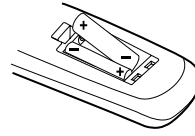
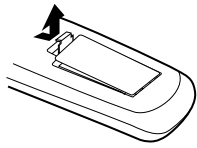

BATTERY REPLACEMENT

When the batteries become weak, the operating distance of the remote control will be greatly reduced and you will need to replace the batteries.

- Note:**
- If the Remote Control is not going to be used for a long time, remove the batteries to avoid damage caused by battery leakage corrosion.
 - Do not mix old and new batteries. Do not mix ALKALINE, standard (CARBON-ZINC) or rechargeable (NICKEL-CADMIUM) batteries.

WARNING: Do not dispose of batteries in a fire or they may leak and/or explode.

Many universal remote controls have a "learning" feature, we recommend you use that feature to program the remote control.

For any questions or problems related to programming a universal remote control, you must contact the customer service department of the universal remote control manufacturer for assistance, or refer to the instructions included with the universal remote control. We cannot offer assistance in programming universal remote controls.

ACCESSORIES

PLEASE LOCATE THE INCLUDED ACCESSORIES.

- Remote control (with battery) x 1
- AC Adapter x 1
- Car Power Adapter x 1

Specifications and appearance are subject to change without notice.

REMOTE CONTROL REFERENCE GUIDE

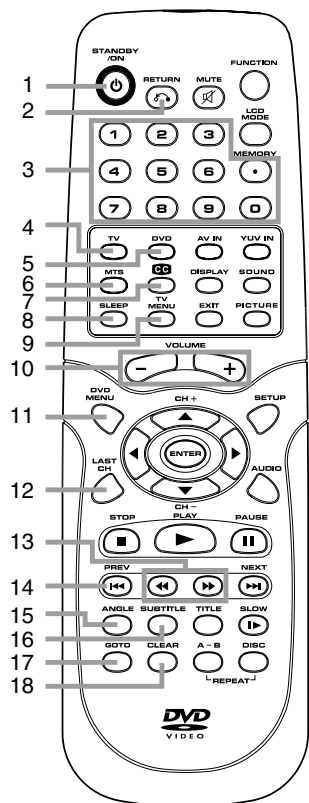

- 1) **STANDBY/ON Button**
Press to turn ON the unit or put it in STANDBY (OFF) mode.
- 2) **RETURN Button**
Press to return to normal operation after using the SETUP menu of a DVD.
- 3) **Number (0 - 9 and dot) Buttons**
In DVD mode, use when creating programs and locating a title/chapter or specific time.
In TV and other modes, use when inputting TV channel number and entering a parental control password.
MEMORY: Set predetermined playback.
DOT: Digital TV channels (ie 11.3 or 12.7)

- 4) **TV Button**
Press to select TV mode.
- 5) **DVD Button**
Press to select DVD mode.
- 6) **MTS Button**
Press to select MONO sound, STEREO sound and Secondary Audio Program (SAP).
- 7) **CC Button**
Press to activate the Closed Captioning feature. This function only works on programs broadcast with captions.
- 8) **SLEEP Button**
Press to set the SLEEP timer. The unit will remain on for the time that is set, and will automatically shut off afterwards.
- 9) **TV MENU Button**
Press to display the on-screen TV menu.
- 10) **VOLUME (-/+) Buttons**
Press to adjust the volume level.
- 11) **DVD MENU Button**
While viewing a DVD, press to enter the main menu.
- 12) **LAST CH Button**
Press to switch repeatedly between the last two channels displayed.
- 13) **◀◀/▶▶ Buttons**
◀◀: Fast reverse playback.
▶▶: Fast forward playback.
- 14) **◀◀ PREVIOUS Button**
Press to select previous chapters or tracks on a disc.
- 15) **ANGLE Button**
Press to switch the camera angle of the video presentation when scenes with multiple camera angles are recorded on a DVD.
- 16) **SUBTITLE Button**
Press to select one of the subtitle languages programmed on a DVD.
- 17) **GOTO Button**
Press to skip directly to a specific location on a DVD/CD.
- 18) **CLEAR Button**
Press to clear input selections.

REMOTE CONTROL REFERENCE GUIDE

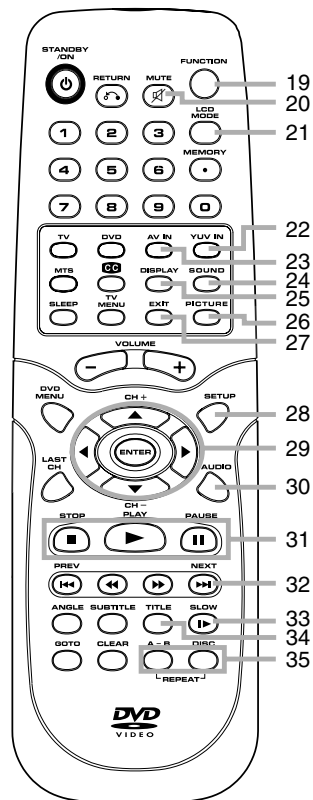

- 19) FUNCTION Button**
Press to switch between TV / AV IN / YUV IN / DVD / PC IN.
- 20) MUTE Button**
Press to mute the sound. Press again to cancel mute.
- 21) LCD MODE Button**
Press to set the size of the LCD display.
- 22) YUV IN Button**
Press to select source connected to YUV IN.
- 23) AV IN Button**
Press to select source connected to AV IN.
- 24) SOUND Button**
Press to select from preset sound settings (Standard, Personal, Theater, Music, Voice) to match the type of show you are watching.

- 25) DISPLAY Button**
Press to change disc status information displayed on the screen.
- 26) PICTURE Button**
Press to select from preset screen display settings to match the type of show you are watching (Standard, Dynamic, Personal, Soft & Movie)
- 27) EXIT Button**
Press to return to previous menu or exit the menu and return directly to normal viewing.
- 28) SETUP Button**
Press to enter and exit the SETUP menu of the DVD player.
- 29) CURSOR (▼, ▲, ◀, ▶) Buttons**
Press to highlight selections on a menu screen and adjust certain settings.
- ENTER Button**
Press to confirm selections on a menu screen.
- CH+/CH- Button**
Press ▲/▼ to change the TV channels.
- 30) AUDIO Button**
Press to select audio soundtracks of a DVD or change the output mode of a CD.
- 31) ■ STOP Button**
Press to stop playing a disc.
- ▶ PLAY Button**
Press to start and resume playback of a disc.
- || PAUSE Button**
Press to pause playback and single frame advance.
- 32) ►► NEXT Button**
Press to select next title, chapter or track on a disc.
- 33) ► SLOW Button**
Press to play a DVD in slow-motion.
- 34) TITLE Button**
Press to select the title menu screen.
- 35) REP A-B Button**
Press to perform point-to-point repeat playback on a DVD or CD.
- REP DISC Button**
Press to repeat chapter of a DVD or repeat single track or whole CD.

UNIT REFERENCE GUIDE

FRONT & SIDE VIEW

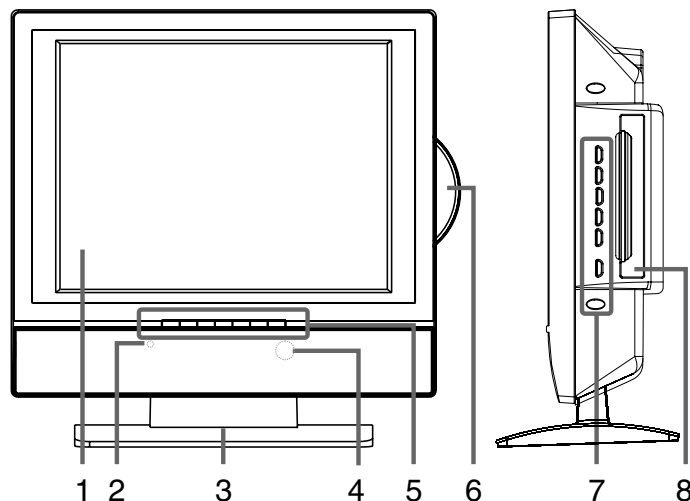

- 1) **Color LCD Screen**
- 2) **REMOTE CONTROL SENSOR**
Do not block this sensor or remote control will not work.
- 3) **Removable Base Stand**
- 4) **STANDBY Indicator**
Indicates whether the unit is ON or in STANDBY (OFF) mode.
Light On: The unit is in STANDBY.
Light Off: The unit is turned ON.
- 5) **STANDBY/ON Button**
Turns the unit on and off.
MENU Button
Enters and exits the TV menu.
FUNCTION Button
Selects TV, AV IN, YUV IN, DVD, or PC IN.
– **VOL + Controls**
Adjusts the volume level and highlight selections (Left & Right) on the menu screen.

- ▼/▲ **Buttons**
Selects a TV channel and highlight selections (Up & Down) on the menu screen.
- 6) **Disc Door**
- 7) **▶ PLAY Button**
Press to start or resume playback of a disc.
■ STOP Button
Stops playing a disc.
⏸ PAUSE button
Pause playback and frame advance.
◀◀ PREV Button
Press PREV button to go back to previous chapters/tracks.
Press and hold to fast reverse playback.
▶▶ NEXT Button
Press NEXT button to advance chapters/tracks.
Press and hold to fast forward playback.
▲ PUSH OPEN Button
Push to open the disc door.
- 8) **Disc Tray**
Push to close the disc door.

UNIT REFERENCE GUIDE

BOTTOM VIEW

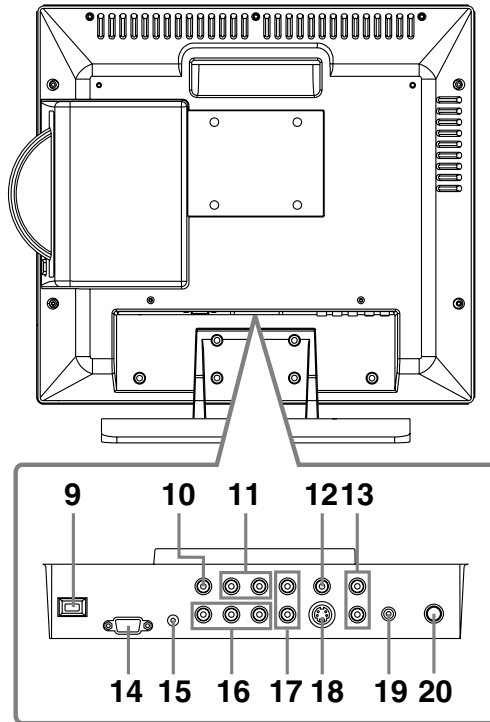

- | | |
|--|--|
| 9) DC 12-24V | 15) PC IN Audio Jack |
| 10) AV OUT Video Output Jack | 16) YUV IN Component Video Input Jacks (Y/PB/PR) |
| 11) AV OUT Audio Output Jacks (Left/Right) | 17) YUV IN Audio Input Jacks (Left/Right) |
| 12) AV IN Video Input Jack | 18) AV IN S-Video Input Jack |
| 13) AV IN Audio Input Jacks (Left/Right) | 19) Headphone Jack |
| 14) PC IN MONITOR/VGA Jack | 20) TV Antenna Cable Terminal - Coaxial TV Antenna Input |

CONNECTIONS

CONNECTING A TV ANTENNA/CABLE/SATELLITE

To view television channels correctly, a signal must be received from one of the following sources:

- An indoor or outdoor aerial antenna
- A cable system
- A satellite system

Connecting a Digital Antenna

The tuner in this TV receives ATSC TV signals from an antenna. This digital TV can receive standard (SDTV) and high definition (HDTV) over the air broadcasts.

Connecting an Analog Antenna or Device

The tuner in this TV can receive NTSC TV signals, analog cable signals or the RF output from a satellite receiver, VCR or cable box.

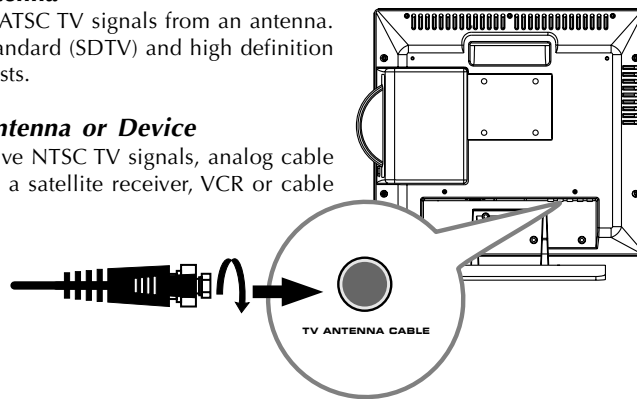

CONNECTING AN AUDIO AMPLIFIER

This connection allows you to use an audio amplifier and external speakers.

Connect the right (red) and left (white) audio OUTPUT from this unit to the right (red) and left (white) audio INPUT on your amplifier. Refer to your amplifier's user manual for more information.

Note:

To control the audio, both the TV and the amplifier must be turned on, and the volume of the amplifier must be set above 0, or you will not hear any sound.

If you want to hear the sound from the amplifier only, press the **VOL -** button on the TV to decrease the volume or press the **MUTE** button on the remote control to turn off the sound.

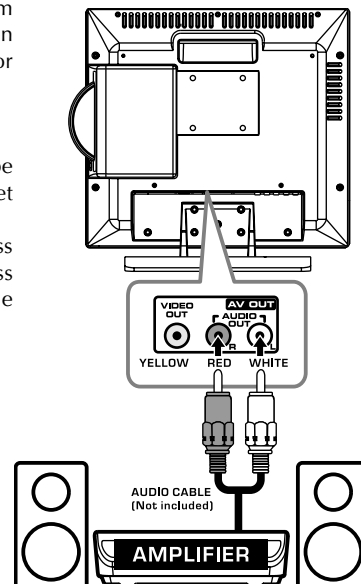

CONNECTIONS

CONNECTING TO A/V DEVICES (VCR, PVR, Camcorder, Game System, etc.)

Connecting to Devices with an S-Video Output

To connect to A/V devices such as a VCR or camcorder:

- Connect to a VCR

Connect the right (red) and left (white) audio output from the VCR to the right (red) and left (white) input on this unit (Audio cable not included).

Connect the S-VIDEO output from the VCR to the S-VIDEO input on this unit (S-VIDEO cable not included). Make sure you connect both audio and video from the same VCR to the same input (AV IN).

Note:

Please refer to the user manual for the VCR for more information.

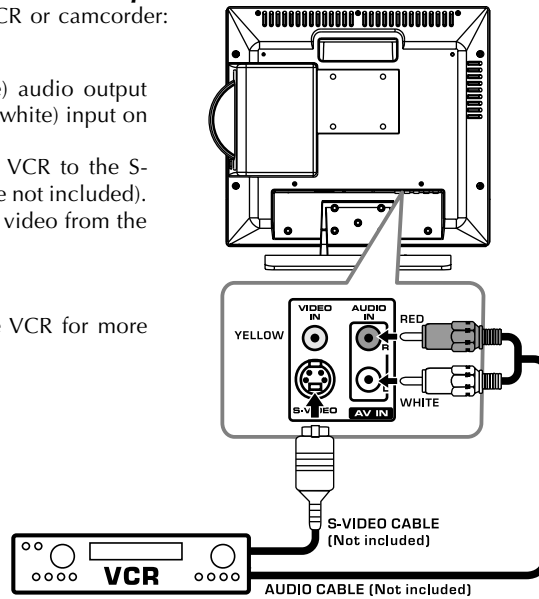

- Connect to a camcorder

Connect the right (red) and left (white) audio output from the camcorder to the right (red) and left (white) input on this unit (Audio cable not included).

Connect the S-VIDEO output from the camcorder to the S-VIDEO input on this unit (S-VIDEO cable not included). Make sure you connect both audio and video from the same camcorder to the same input (AV IN).

Note:

Please refer to the user manual for the camcorder for more information.

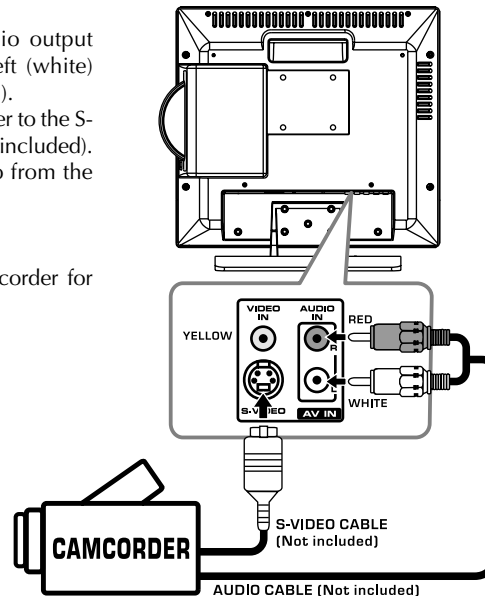

CONNECTIONS

Connecting to Devices with a Composite (yellow RCA-type) Video Output

To connect to A/V devices such as a VCR or camcorder:

- Connect to a VCR

Connect the right (red) and left (white) audio output from the VCR to the right (red) and left (white) input on this unit (Audio cable not included).

Connect the video (yellow) output from the VCR to the video input on this unit (Video cable not included).

Make sure you connect both audio and video from the same VCR to the same input (AV IN).

Note:

Please refer to the user manual for the VCR for more information.

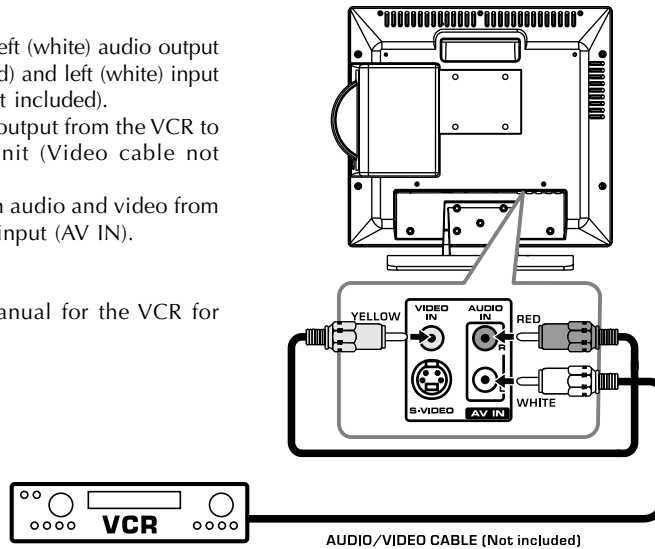

AUDIO/VIDEO CABLE (Not included)

- Connect to a camcorder

Connect the right (red) and left (white) audio output from the camcorder to the right (red) and left (white) input on this unit (Audio cable not included).

Connect the video (yellow) output from the camcorder to the video input on this unit (Video cable not included).

Make sure you connect both audio and video from the same camcorder to the same input (AV IN).

Note:

Please refer to the user manual for the camcorder for more information.

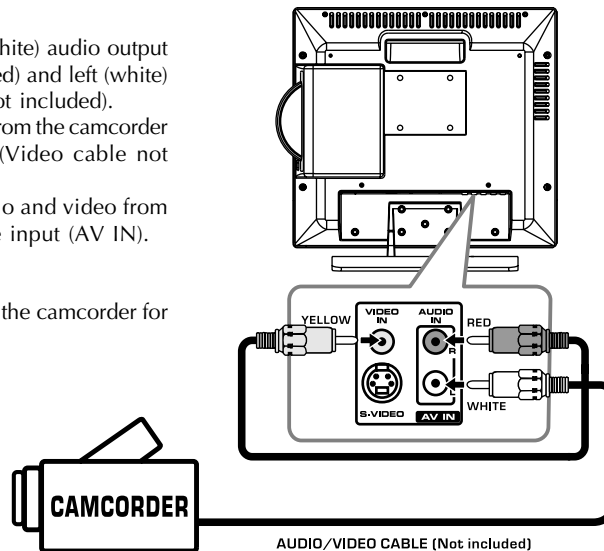

AUDIO/VIDEO CABLE (Not included)

CONNECTIONS

Connecting to Devices with a Composite (yellow RCA-type) Video Input

To connect to A/V devices such as a VCR, PVR or camcorder:

- Connect to a VCR/PVR

Connect the right (red) and left (white) audio input from the VCR/PVR to the right (red) and left (white) output on this unit (Audio cable not included).

Connect the video (yellow) input from the VCR/PVR to the video output on this unit (Video cable not included).

Make sure you connect both audio and video from the same VCR/PVR to the same output (AV OUT).

Note:

Please refer to the user manual for the VCR/PVR for more information.

Note:

- After connection, please operate in TV/AV mode.
- For the reason of copyright protection, the result copy may have bad picture and/or sound.

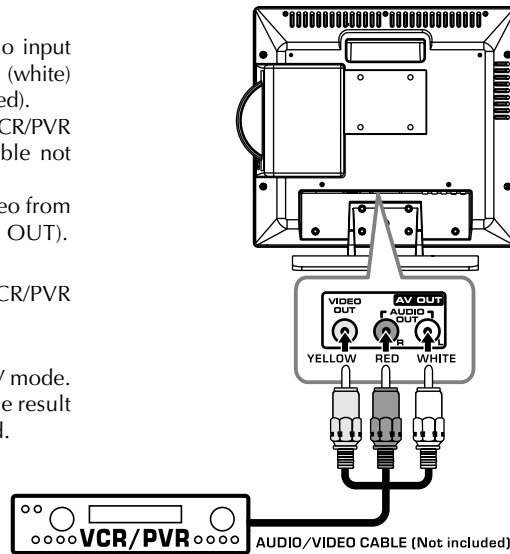

- Connect to a camcorder

Connect the right (red) and left (white) audio input from the camcorder to the right (red) and left (white) output on this unit (Audio cable not included).

Connect the video (yellow) input from the camcorder to the video output on this unit (Video cable not included).

Make sure you connect both audio and video from the same camcorder to the same output (AV OUT).

Note:

Please refer to the user manual for the camcorder for more information.

Note:

- After connection, please operate in TV/AV mode.
- For the reason of copyright protection, the result copy may have bad picture and/or sound.

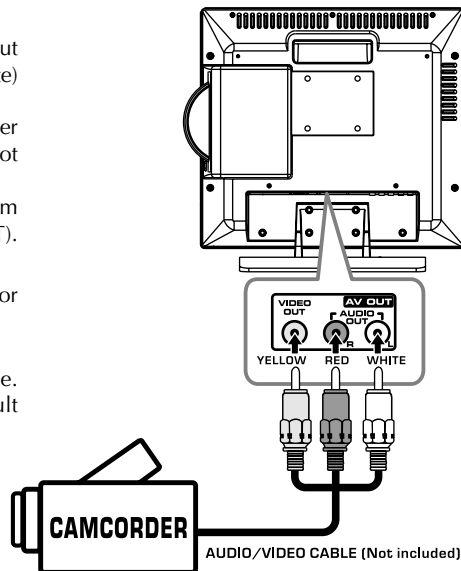

CONNECTIONS

CONNECTING A HIGH-DEFINITION (HD) SOURCE

High-Definition (HD) Devices with component video output must be connected to the YUV input.

Connect the three video outputs (Y, Pb, Pr) from the source to the corresponding video inputs on this unit (Component video cable not included).

Connect the right (red) and left (white) audio output from the source to the right (red) and left (white) input on this unit (Audio cable not included).

Make sure you connect both audio and video from the same source to YUV IN.

Note: When connecting a DVD player to the television, the picture resolution is solely dependent upon the resolution supported by the DVD player attached. DVD Player resolutions vary from 480i to 1080i, and this television can support DVD players up to a maximum resolution of 1080.

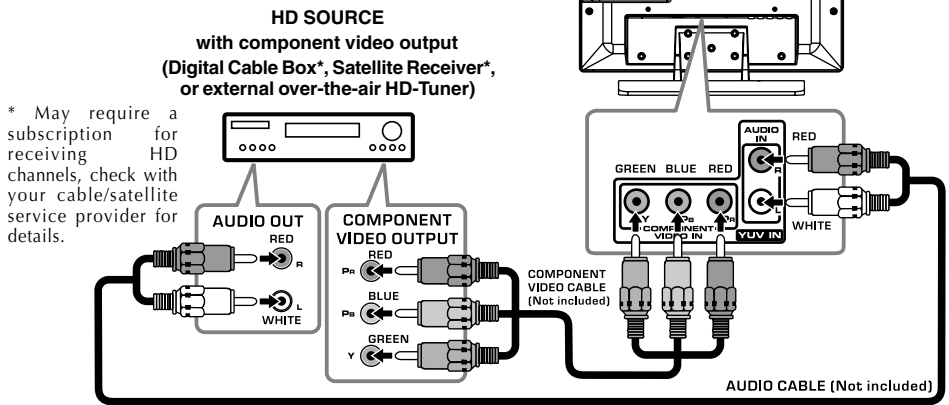

CONNECTING A PC

Connect the 15-pin D-SUB PC/VGA connector from your computer to the 15-pin D-SUB PC/VGA input on this unit using a monitor cable (not included). Connect a stereo audio cable (not included) to the PC AUDIO IN jack on this unit, and the other end to the AUDIO OUT jack on your computer's sound card.

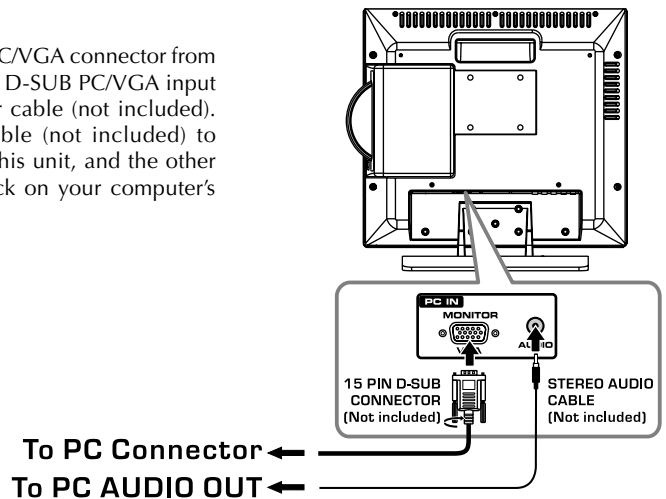

POWER SUPPLY

USING THE CAR POWER ADAPTER

The included car power adapter allows the unit to be used with vehicles that have a 12-24V, negative ground electrical system.

Cautions:

- Use the provided car power adapter only. Use with other car power adapters could damage the unit.
- The car power adapter included with this unit is for its use only. Do not use it with other equipment.
- In the interest of traffic safety, do not operate this unit or view videos while driving a vehicle.
- Make sure the unit is securely fastened to prevent it from falling or flying through the air in the event of an accident.
- When the inside of the cigarette lighter socket is dirty with ashes or dust, the plug section may become hot due to poor contact. Be sure to clean the cigarette lighter socket before use.
- After use, disconnect the car power adapter from both the unit and cigarette lighter socket.

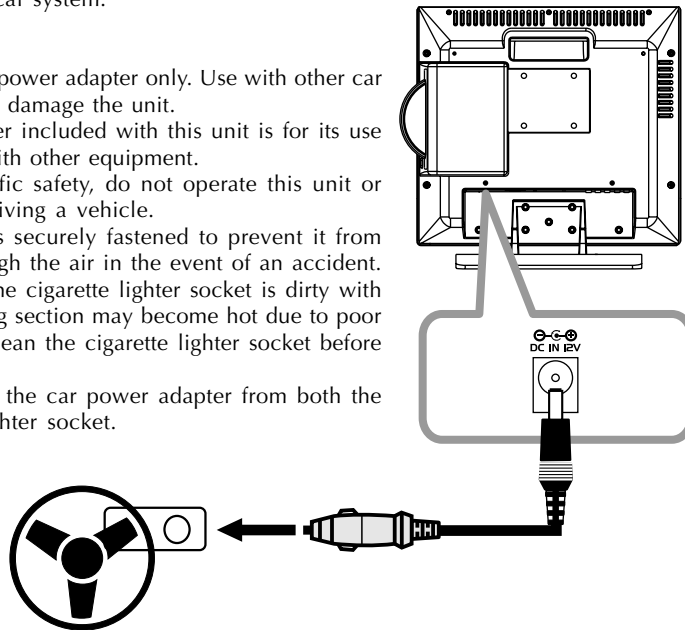

USING THE AC POWER ADAPTER

The supplied AC adapter operates on AC 120V.

- Press the **STANDBY/ON** button on the unit or remote control to turn on the unit.

Note:

- The AC adaptor included with this unit is for its use only. Do not use it with other equipment.
- Be sure the AC power cord is disconnected and all functions are off before making connections.
- Make sure that all the components are connected correctly.
- **To prevent electrical shock, match wide blade of plug to wide slot of wall outlet, then fully insert.**
- When you are not going to use the unit for a long period of time, disconnect the power cord.

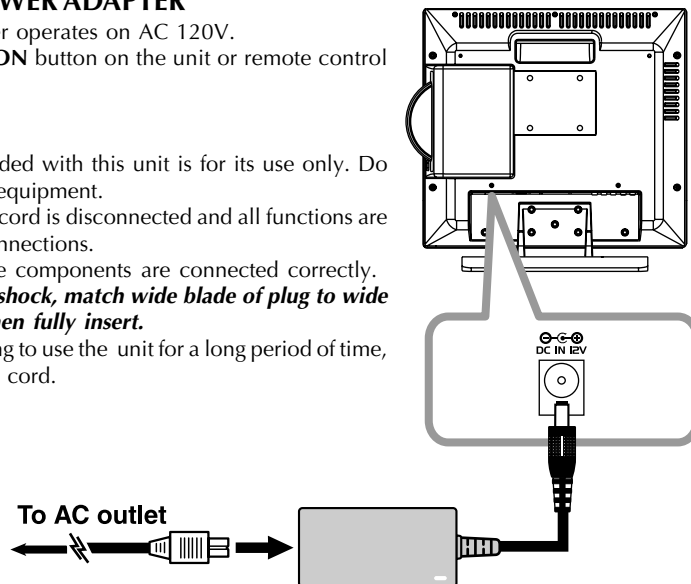

INSTALLATION

REMOVING THE BASE STAND

WARNING: The LCD Display is very fragile, and must be protected at all times when removing the base stand. Be sure that no hard or sharp, or anything that could scratch or damage the LCD display, come in contact with it. Do NOT place pressure on the front of the unit at any time because the screen could crack.

1. Disconnect any cables or cords connected to the unit.
2. Lay the unit down on a flat surface, so the back side is facing up, making sure to place a soft cushioned material (such as a pillow or thick piece of foam) beneath the screen.
3. Remove the four screws and then remove the BASE STAND from the unit.

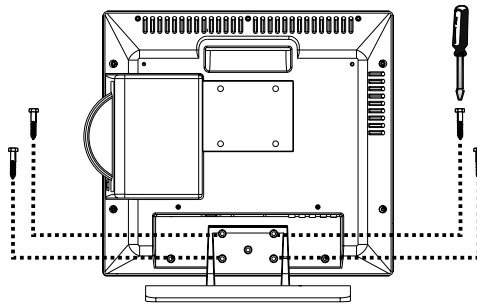

MOUNTING ON THE WALL

This unit is VESA-compliant, and is designed to be wall-mounted with a VESA-compliant 3" x 3" (75mm x 75mm) mounting kit designed for flat-panel TVs (sold separately). Mount this unit according to the directions included with the mounting kit.

Note: You must remove the base stand before mounting the unit on the wall.

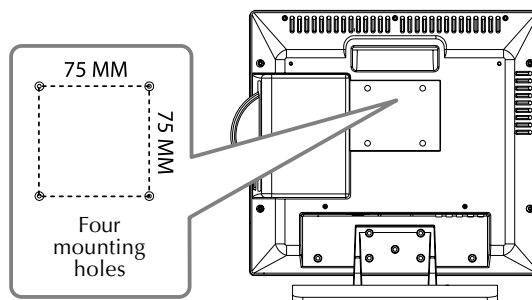

USING HEADPHONES

- Turn down the volume before connecting headphones to the unit, then adjust the volume to your desired level.
- When headphones are connected, no sound will come from the front speakers.

Note:

- Avoid listening to sound at high levels for prolonged periods of time. This may be harmful to you and may cause hearing loss.

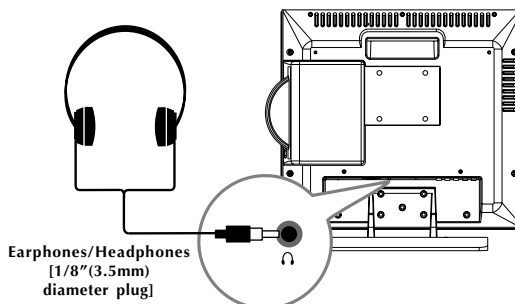

UNIT OPERATION

TURNING THE UNIT ON

When the AC power cord is connected, press the **STANDBY/ON** button on the unit to turn it on. Press the **FUNCTION** button to select the desired mode (TV/AV IN/YUV IN/DVD/PC IN). If you select DVD, the DVD logo will appear on the screen.



Note: When the unit is not going to be used for a long time, disconnect the AC power cord from AC power outlet.

TURNING THE UNIT ON FOR THE FIRST TIME

The first time for you turning on the unit, the unit will enter Virgin mode. You can easily follow up prompt message on screen to finish basic settings of the system.

1. Press the **ENTER** button to proceed the **Initial Setup**.
2. Use the **▲ / ▼** button to select your OSD language, and press the **▶** button to the next step.
3. Use the **▲ / ▼** button to select your TV tuner source (Antenna or Cable), and press the **▶** button to the next step.
4. Make sure RF aerial has been connected properly to **TV ANTENNA** input jack on the bottom of the system, press the **ENTER** or **▶** button. The system will automatically start to scan and preset all available TV channels.
5. After scanning finished, "Initial setup is Complete." will appear on the screen. Press the **ENTER** button to finish **Initial Setup**.

After finishing above settings, the system will return to the first TV channel scanned just now.

SOUND SYSTEM

DOLBY DIGITAL (FOR DVD)

Dolby Digital is a sound system developed by Dolby Laboratories Inc. This unit automatically recognizes DVDs that have been recorded with Dolby Digital.

Not all Dolby Digital sources are recorded with 6 channels.

Some sources marked Dolby Digital may be recorded in Dolby Surround, a 2 channel system. Look for this logo on your unit.

Manufactured under license from Dolby Laboratories.

'Dolby' and the double-D  symbol are trademarks of Dolby Laboratories.



CD/DVD OPERATION

This owner's manual explains the basic instructions of this unit. Some DVDs are produced to limit operation during playback. For example, many DVDs do not allow users to skip government warnings, or in some cases previews or other features. This is not a defect in the unit. Refer to the instruction notes of discs.

"ⓧ" may appear on the screen during operation. A "ⓧ" means that the desired operation is not permitted by the unit or disc.

PLAYING A DISC

1. Press the **STANDBY/ON** button (on unit or remote control) to turn on the unit.
2. Press the **FUNCTION** button to select DVD mode.
See **CUSTOMIZING THE DVD FUNCTION SETTINGS** before proceeding to step 3.
3. Press the **▲ PUSH OPEN** button to open the disc door.
4. Hold the disc by its sides and carefully press onto the central support of compartment with the printed side facing towards you until you hear a "click".
5. Push the Dis Tray to close the disc door.
It takes a short while for your unit to load the disc. After loading, the unit will automatically either bring you to the main menu of the DVD, or start playing the DVD. If the unit does not automatically start playing the DVD, press the **▶ PLAY** button.

PAUSING PLAYBACK (STILL MODE)

Press the **⏸ PAUSE** button. To resume normal playback, press the **▶ PLAY** button. Each time you press the **⏸ PAUSE** button, the picture advances one frame.

STOPPING PLAYBACK

Press the **■ STOP** button at the location where you want to interrupt playback. To resume playback at the position where the disc was stopped, press the **▶ PLAY** button. If you press the **■ STOP** button twice, the unit's memory will be cleared and pressing the **▶ PLAY** button will reset the disc to the beginning.

SKIP (FORWARD / REVERSE)

- Press the **⏮ PREV** button to go back to previous chapters/tracks.
- Press the **⏭ NEXT** button to advance chapters/tracks.
- For an Audio CD, use the number buttons (remote control only) to jump directly to that track number.

FAST FORWARD/FAST REVERSE

1. Press the **⏩ SEARCH** or **⏪ SEARCH** button when a disc is playing.
 - The disc begins fast scan at x2 speed.
 - Four speeds are available. Each time the **⏩ SEARCH** or **⏪ SEARCH** button is pressed, the speed of fast scan changes in the following sequence:
X 2 → **X 4** → **X 8** → **X 20**
2. Press the **▶ PLAY** button when you reach the desired point to resume playback at normal speed.

SLOW-MOTION PLAY (DVD)

1. Press the **⏪ SLOW** button on remote control in the play mode. Two speeds are available. Each time the **⏪ SLOW** button is pressed, the speed of slow-motion playback changes in the following sequence:
SF 1/2 → **SF 1/3** → **SF 1/4** → **SF 1/5** → **SF 1/6** → **SF 1/7**
2. Press the **▶ PLAY** button to return to the normal playback speed.

CD/DVD OPERATION

AUDIO SELECTION (DVD)

On some discs, the sound is recorded in two or more formats. Follow the directions below to select the type of playback.

1. While a disc is playing, press the **AUDIO** button to show the current audio format number.
2. Press the **AUDIO** button repeatedly to select the desired audio format.

 : 1/3ENG  6CH

Note:

- If only one audio format is recorded, the number does not change.
- About two seconds later, playback continues in the new audio format.

SUBTITLE SELECTION (DVD)

1. While a DVD is playing, press the **SUBTITLE** button to display the current language setting, as shown in the example below.
2. Press the **SUBTITLE** button repeatedly to select the desired subtitle language.

 : 2/3 ESP

Note:

- If only one language is recorded, the language does not change.
- About two seconds later, playback continues with the new subtitle selected.
- The number of languages recorded differs depending on the disc.
- If no button is pressed within a few seconds, playback continues without changing the current subtitle.
- This function can only be used for discs on which subtitles have been recorded in multiple languages.
- On some DVDs, subtitles are activated from the main menu of the DVD. Press the **MENU** button to activate the main menu.

ANGLE SELECTION (DVD)

Some DVDs contain scenes which have been shot from a number of different angles. For these discs, the same scene can be viewed from each of these different angles.

1. While you are playing a DVD with different angles recorded, press the **ANGLE** button to view the number of current angles available.
2. Press the **ANGLE** button repeatedly to change the scene to the next angle in those recorded.
 - About two seconds later, playback continues from the new angle selected.
 - If no button is pressed within 10 seconds, playback continues without changing the current angle.

 : [2/3]

Sequence of angle shots
(Example)



Note:

- This function can only be used for discs on which scenes shot from multiple angles have been recorded.
- If only one angle is recorded, " : [1/1]" is displayed.

SPECIAL FUNCTIONS

DISPLAY FUNCTION (DVD)

Using DISPLAY, you can check the current settings of the following items: ANGLE, AUDIO and SUBTITLE.

- While the disc is playing, press the **DISPLAY** button to display the screen shown below.

	Title	Chapter	Elapsed time
DVD	TT 1/21	CH 6/29	⏱ 00:07:18
	Audio	Subtitle	Angle
	Ⓜ 1/3 ENG	Ⓜ 6 CH	Ⓜ 2/3 ESP OFF
	Title	Chapter	Remaining Time
DVD	TT 1/21	CH 11/29	R -00:30:28
	Title	Chapter	Total Time
DVD	TT 1/21	CH 11/29	T -01:00:28

LOCATING A SPECIFIC TITLE (DVD)

If a DVD video disc contains title numbers, you can locate a specific title by directly selecting a title number.

1. In stop mode, press the **GOTO** button.
2. Press the ◀ or ▶ button to highlight a specific field and press the corresponding number button(s) for the title you want.
3. Press the **ENTER** button to confirm. The unit will start playback about 3 seconds later.

DVD TT 00/21 CH 029/029 ⏱ 00:00:00

LOCATING A SPECIFIC CHAPTER / TRACK

If you know the chapter / track number you want to play, you can locate a specific chapter / track by directly selecting a chapter / track number.

1. Press the **GOTO** button to search for your desired chapter / track.
2. Press the ◀ or ▶ button to highlight a chapter / track and press the corresponding number button(s) for the chapter you want.
3. Press the **ENTER** button to confirm. The unit will start playback about 3 seconds later.

DVD TT 00/34 CH 000/029 ⏱ 00:00:00

CD TRK 00 / 12 🔊 🔍 ⏱ 00:00:00

LOCATING A SPECIFIC TIME

You can move to a specific location by entering its corresponding time (hours, minutes, seconds)

1. Press the **GOTO** button.
2. Press the ◀ or ▶ button to highlight time.
3. Press the corresponding number buttons for the setting point you want.
4. Press the **ENTER** button to confirm. The unit will start playback about 3 seconds later.

DVD TT 00/21 CH 029/029 ⏱ 01:00:00

Note:

- Some discs may not respond to this process.
- Some scenes may not be located as precisely as specified.
- This method for accessing specific locations is available only within the current title of the DVD video disc.

CD/DVD PROGRAMMABLE MEMORY

PROGRAMMABLE MEMORY

The two types of programmed playback provided by this Unit are title/chapter programmed playback and track programmed playback.

TITLE/CHAPTER PROGRAMMED PLAYBACK (DVD)

1. Press the **MEMORY** button while the disc is stopped.
2. Enter the title numbers in **---**. Use the **◀** or **▶** button to move the highlight to chapter and enter the chapter numbers in **---**.
3. Use the **◀**, **▶**, **▲** or **▼** button to move to the other fields.
4. Repeat steps 2 to 3.
5. Press the **▶ PLAY** button to start the programmed playback.

TITLE		CHAPTER	
PROG	T C	T C	T C
1	---	---	---
2	---	---	---
3	---	---	---
4	---	---	---
PLAY		CLEAR	

Note: If you press the **■ STOP** button, the programmed selection will be cleared.

TRACK PROGRAMMED PLAYBACK (CD)

1. Press the **MEMORY** button while the disc is stopped.
2. Enter the track numbers in **----**.
3. Use the **◀**, **▶**, **▲** or **▼** button to move to the other fields.
4. Repeat steps 2 to 3.
5. Press the **▶ PLAY** button to start the programmed playback.

TRACK			
PROG	---	---	---
1	----	----	----
2	----	----	----
3	----	----	----
4	----	----	----
PLAY		CLEAR	

REPEAT PLAYBACK

You can play a specific title or chapter repeatedly. (Title repeat, chapter repeat, A-B repeat)

REPEATING A CHAPTER (DVD)

You can play the same chapter repeatedly.

1. While the disc is playing, press the **REPEAT DISC** button until the **REP: CHAPTER** indicator displays on the screen. The current chapter is played repeatedly.

REPEATING A TITLE

You can play the same title repeatedly.

2. While the disc is playing, press the **REPEAT DISC** button until the **REP: TITLE** indicator displays on the screen. The current title is played repeatedly.

TO RESUME NORMAL PLAYBACK

3. While the disc is playing, press the **REPEAT DISC** button until the **REP: OFF** indicator displays on the screen.

You can play a single track or an entire disc repeatedly.

REPEATING A SINGLE TRACK (CD)

You can play the same track repeatedly.

1. While the disc is playing, press the **REPEAT DISC** button until the **REP: REP 1** indicator displays on the screen. The current track is played repeatedly.

REPEATING AN ENTIRE DISC

2. While the disc is playing, press the **REPEAT DISC** button until the **REP: REP ALL** indicator displays on the screen. The entire disc is played repeatedly.

TO RESUME NORMAL PLAYBACK

3. Press the **REPEAT DISC** button until the **REP: OFF** indicator displays on the screen.

REPEAT PLAYBACK

REPEATING A SPECIFIC SECTION (DVD) (CD)

You can play a specific section repeatedly.

1. While the disc is playing, press the **REPEAT A-B** button at the beginning of the section (**REPEAT A-** is displayed) you want to play repeatedly.
2. Press the **REPEAT A-B** button again at the end of the section (**REPEAT A-B** is displayed) you want to play repeatedly.
3. The unit will immediately begin replaying your selection.

TO RESUME NORMAL PLAYBACK

4. While the disc is playing, press the **REPEAT A-B** button until the **A-B CANCEL** indicator displays on the screen.

Note:

- A-B repeat can only be used within the same title. If the start and end of the section to be repeated are in different titles, A-B repeat is cancelled.
- The A-B repeat function does not operate in scenes where different camera angles are recorded.

PLAYING A PICTURE FILE DISC

This unit can play JPG picture files recorded on CD-R and CD-RW discs.

PLAYING A PICTURE FILE DISC

1. Press the **▲ PUSH OPEN** button to open the disc door.
2. Hold a picture file disc by its edge and gently push it onto the spindle with the label side facing up until you hear a "click".
3. Push the Disc Tray to close the disc door.
4. The unit will load the disc and automatically display the contents of the disc on the screen, while also beginning to play the picture file. These files will then be played back one by one.
5. Press the **◀** or **▶** button to select a picture file to play.
6. Press the **▲, ▼, ◀** or **▶ CURSOR** button to view and select the files that you want to view, then press the **ENTER** button to confirm the selected file.

Note:

- This unit only support JPG file format.
- You can press the **⏸ PAUSE** button to interrupt playback, and press the **▶ PLAY** button to resume playback.
- You also can use the **GOTO** function or use the numbered buttons to enter the image number to quickly select any image.
- Press the **ANGLE** button on the remote control to rotate the picture orientation by 90°.

CUSTOMIZING THE DVD FUNCTION SETTINGS

LANGUAGE SETUP

1. Press the **SETUP** button in stop mode.
2. Use the **▶** button to change the highlight cursor. Use the **▲** or **▼** button to select a language, then press the **ENTER** button. The screen will change to your selected language immediately.
3. To exit the SETUP MENU and return to the normal screen, press the **RETURN** or **SETUP** button.



VIDEO SETUP

1. Press the **SETUP** button in stop mode.
2. Use the **▲** button to select **LANGUAGE SETUP**, then press the **◀** or **▶** button repeatedly until **VIDEO SETUP** appears.
3. Use the **▲** or **▼** button to select the option (BRIGHTNESS, CONTRAST or VIDEO), then press the **▶** button. Use the **▲** or **▼** button to make adjustments, then press the **ENTER** button. (The screen will change to your selected setting).
4. Repeat steps 2 and 3 above to adjust other options.
5. To exit the SETUP MENU and return to the normal screen, press the **RETURN** or **SETUP** button.



SYSTEM SETUP

1. Press the **SETUP** button in stop mode.
2. Use the **▲** button to select **LANGUAGE SETUP**, then press the **◀** or **▶** button repeatedly until **SYSTEM SETUP** appears.
3. Use the **▲** or **▼** button to select the option (TV TYPE or DEFAULT), then press the **▶** button. Use the **▲** or **▼** button to make adjustments, then press the **ENTER** button. (The screen will change to your selected setting).
4. Repeat steps 2 and 3 above to adjust other options.
5. To exit the SETUP MENU and return to the normal screen, press the **RETURN** or **SETUP** button.



TV TYPE

Pan Scan

- When wide-screen video is played, this mode clips the right and left sides of the image so that it can be viewed on a conventional screen.
- Some wide-screen DVDs that do not permit Pan Scan mode playback are automatically played in letterbox mode (black bands that appear at the top and bottom of the screen).

Letter Box

- When wide-screen video is played in this mode on a conventional screen, black bands appear at the top and bottom of the screen.

Wide screen

- This is the correct mode for playing wide-screen videos on the unit screen or other external wide-screens.

Note:

- The displayable picture size is preset on the DVD. Therefore the playback picture of some DVDs may not conform to the picture size you select.
- When you play DVDs recorded in the 4:3 aspect ratio, the playback picture will always appear in the 4:3 aspect ratio regardless of the TV TYPE setting.
- If the screen mode is still not correct, press the LCD MODE button repeatedly to adjust it.

DEFAULT

It takes 3-5 seconds to reset the DVD settings to the factory default.

Cut off when a wide-screen video image is played.



PAN SCAN



LETTER BOX



WIDE SCREEN

TV SETUP

VIDEO MENU

1. Press the **TV MENU** button.
2. Press the **ENTER** or **▶** button to select **Video**.
3. Use the **▲** or **▼** button to select the options (**Picture Mode**, **Brightness**, **Contrast**, **Saturation**, **Tint**, **Sharpness** or **Color Temperature**). Adjust them using the **◀** or **▶** button (The screen will change to your desired setting); or press the **ENTER** or **▶** button to go into the detailed settings.
4. Press the **EXIT** button to return to the previous menu.
5. Repeat steps 3 and 4 to adjust other options.
6. To exit the MAIN MENU and return to the normal screen, press the **EXIT** button repeatedly.

TV MODE

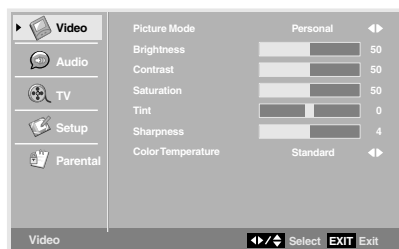

AV / YUV / DVD MODE

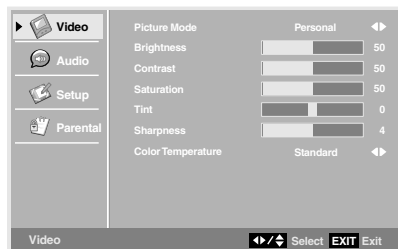

PC MODE

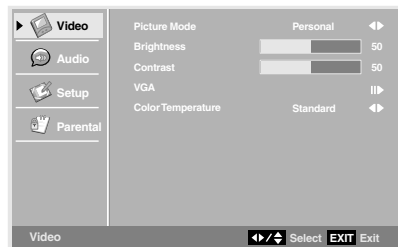

- **Picture Mode** : Select from preset screen display settings to match the type of show you are watching (Standard, Dynamic, Personal, Soft & Movie). (Select Personal mode to recall your customized settings on brightness, contrast, saturation, tint, sharpness and color temperature.)
- **Brightness** : Adjust the brightness of the picture. Brighten or darken the whole picture.
- **Contrast** : Adjust to sharpen the picture quality. The black portions of the picture become richer in darkness and the white become brighter.
- **Saturation** : Adjust the color saturation of the picture.
- **Tint** : Adjust the tint of the picture. (Toward purple / Toward green)
- **Sharpness** : Adjust the sharpness level to improve detail in the picture.
- **Color Temperature** : Adjust the three color temperature of the picture. Choose from Standard (balanced), Warm (red white), or Cool (blue white) modes.

TV SETUP

VGA Settings in PC Mode

Use the ▲ or ▼ button to select the options (**Auto Adjust**, **H. Position**, **V. Position**, **Phase** or **Clock**). Adjust them using the ◀ or ▶ button. The screen will change to your desired setting. (Press the ENTER or ▶ button to confirm Auto Adjust.)

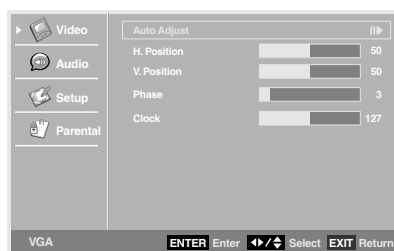

- Resolution : 1,024 x 768 max
- Refresh Frequency : 60Hz max
- **H. Position** : Center the image by moving it left or right.
- **V. Position** : Center the image by moving it up or down.
- **Phase** : Adjusts the image if there is flicker of screen letters, color misalignment, or blurring.
- **Clock** : Adjusts the display clock to change width of the image.

AUDIO MENU

1. Press the TV MENU button.
2. Use the ▲ or ▼ button to select **Audio**, then press the ENTER or ▶ button to go into the Audio settings.
3. Use the ▲ or ▼ button to select the options (**Balance**, **Bass**, **Treble** or **Audio Mode**). Adjust them using the ◀ or ▶ button (The screen will change to your desired setting); or press the ENTER or ▶ button to go into the detailed settings.
4. Press the EXIT button to return to the previous menu.
5. Repeat steps 3 and 4 to adjust other options.
6. To exit the MAIN MENU and return to the normal screen, press the EXIT button repeatedly.

TV MODE



AV / YUV / DVD / PC MODE



Note: Experiment with different sound settings until you find the settings you prefer.

- **Balance** : Adjust the balance level toward the left or right speakers.
- **Bass** : Adjust the bass range.
- **Treble** : Adjust the treble range.
- **Audio Mode** : Select from preset sound settings (Personal, Theater, Music, Voice, Standard) to match the type of show you are watching. (Select Personal mode to recall your customized settings on bass and treble.)

TV SETUP

TV MENU (For TV Mode Only)

1. Press the **TV MENU** button.
2. Use the **▲** or **▼** button to select **TV**. Press the **ENTER** or **▶** button to go into the TV settings.
3. Use the **▲** or **▼** button to select the options (**Tuner Mode**, **Auto Scan**, **Add Channel**, **Channel Skip**, **MTS** or **Audio Language**). Adjust them using the **◀** or **▶** button (The screen will change to your desired setting); or press the **ENTER** or **▶** button to go into the detailed settings.
4. Press the **EXIT** button to return to the previous menu.
5. Repeat steps 3 and 4 to adjust other options.
6. To exit the MAIN MENU and return to the normal screen, press the **EXIT** button repeatedly.

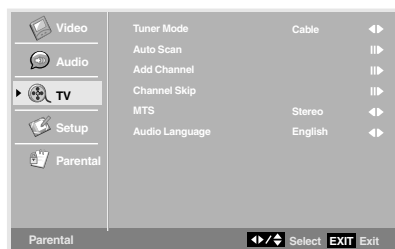

- **Tuner mode :** Antenna (over-the-air broadcasts) or Cable (cable/satellite broadcasts) mode are available.
- **Auto Scan Add CH:** Search for more usable stations and add them in memory. (The stations stored before are still kept.)
- **Add Channel:** Search for more usable stations and add them in memory.
- **Channel Skip:** Skip weak channels and the channels you don't like.
- **MTS:** Select Stereo / SAP (Secondary Audio Program) / Mono.
- **Audio Language:** Select from English / Spanish / French. (Available for digital channels if multiple audio languages are broadcasted.)

Note: The SAP (Secondary Audio Programs) feature allows a TV station to broadcast other information, which could be audio in another language.

Channel Skip Setting:

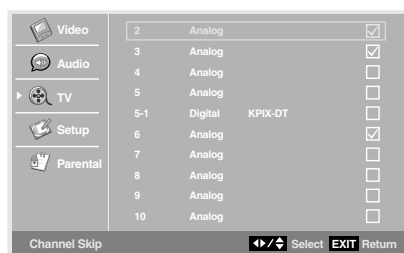

1. Use the **▲** or **▼** button to select a channel. (Press the **▶** button to select the last channel of the page, press again to the next page. Press the **◀** button to select the first channel of the page, press again to the previous page.)
2. Press the **ENTER** button to shift between skip or not skip the channel. ("✓" appears in the square means skip the selected channel. The channel will not appear when you press the **CH+/CH-** Button.)

SETUP MENU

1. Press the **TV MENU** button.
2. Use the **▲** or **▼** button to select **Setup**. Press the **ENTER** or **▶** button to go into the Setup settings.
3. Use the **▲** or **▼** button to select the options (**OSD Language**, **Time Setup**, **Caption** or **Restore setting**). Adjust them using the **◀** or **▶** button (The screen will change to your desired setting); or press the **ENTER** or **▶** button to go into the detailed settings.
4. Press the **EXIT** button to return to the previous menu.
5. Repeat steps 3 and 4 to adjust other options.
6. To exit the MAIN MENU and return to the normal screen, press the **EXIT** button repeatedly.

TV SETUP

TV MODE

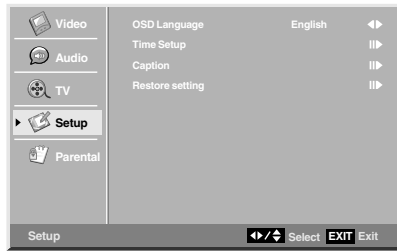

AV / YUV / DVD MODE

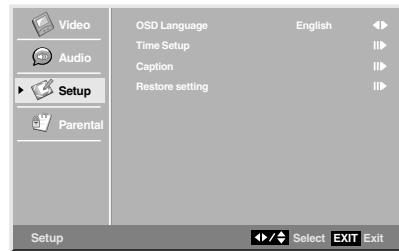

PC MODE

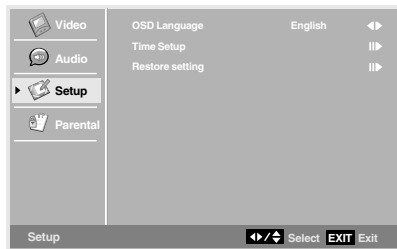

- **OSD Language** : Select from English / Español / Français.

Time Setup Setting:

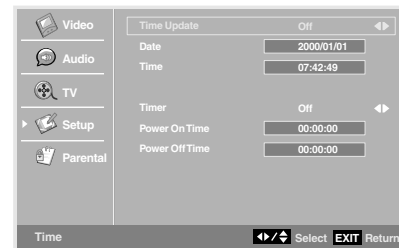
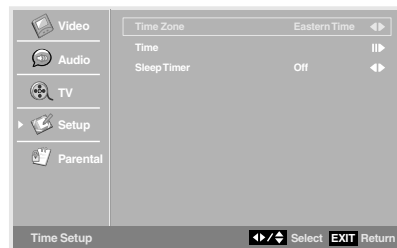

- **Time Zone** : Select the time zone from Eastern Time / Indiana / Central Time / Mountain Time / Arizona / Pacific Time / Aalaska / Hawaii.
- **Sleep Timer** : Select the time to turn the unit to Standby mode automatically: Off -> 5 Minutes -> 10 Minutes -> 15 Minutes -> 30 Minutes -> 60 Minutes -> 90 Minutes -> 120 Minutes -> Off.

When you set the 'Time', the option will be shown:

- **Time Update** : Select On/Off to activate the following manual settings; Select Auto to synchronize time with the digital TV channel signal.
- **Date** : Press the ◀ or ▶ button to locate the position, and press the number buttons to input date.
- **Time** : Press the ◀ or ▶ button to locate the position, and press the number buttons to input time.
- **Timer** : Select On to activate automatically power on/off.
- **Power On Time** : Press the ◀ or ▶ button to locate the position, and press the number buttons to input power on time.
- **Power Off Time** : Press the ◀ or ▶ button to locate the position, and press the number buttons to input power off time.

TV SETUP

Caption Setting:

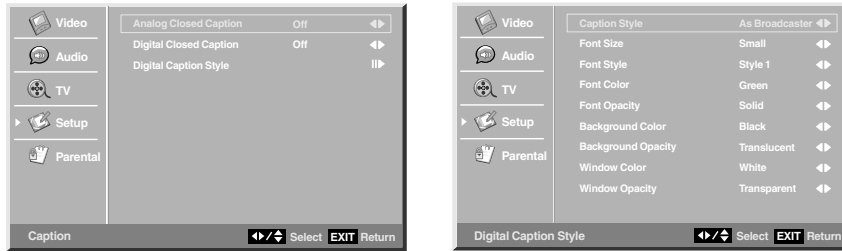

- **Analog Closed Caption** : Select the analog closed caption or turn it off.
- **Digital Closed Caption** : Select the digital closed caption or turn it off.
- **Digital Caption Style** : Select As Broadcaster to use the default digital caption style of the broadcaster. Select Custom to activate the caption style items and set you preferred detailed settings.

Note: This function only works on ATSC programs broadcast with captions.

Restore Setting:

If you reset the TV to the factory settings, all your present settings on Video & Audio will be erased and replaced by the factory's default settings. However, picture settings in PC mode and Parental settings will not be erased.

PARENTAL MENU

Password

1. Press the **TV MENU** button.
2. Use the **▲** or **▼** button to select **Parental**. Press the **ENTER** or **▶** button to confirm. The menu locked screen will be displayed.
3. Enter a 4-digit password. Once entered, the screen will enter the Parental menu. The preset password is 0000.

You can edit the parental control level or change the password. See **Parental Control Settings** on the next page.

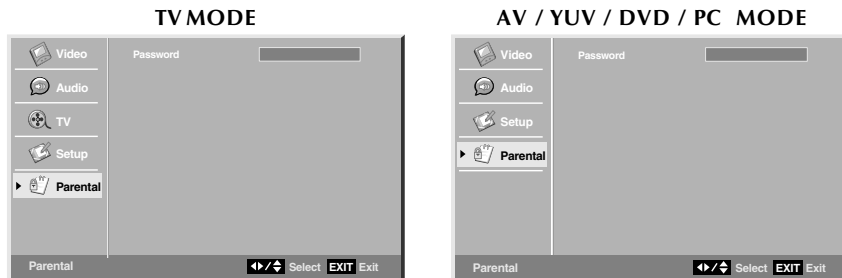

If you forget the password,
enter " 8888 " to unlock parental control.

TV SETUP

Parental Control Setting:

- Use the ▲ or ▼ button to select various Parental settings. Press the **ENTER** or ► button to go into the detailed settings.
- Use the ▲, ▼, ◀ and ▶ buttons to move among the rating levels. Press the **ENTER** button to change the mode between Blocked and Allowed.
- Press the **EXIT** button to return to the previous menu.
- Repeat steps 4 - 6 to adjust other options.
- To exit the MAIN MENU and return to the normal screen, press the **EXIT** button repeatedly.

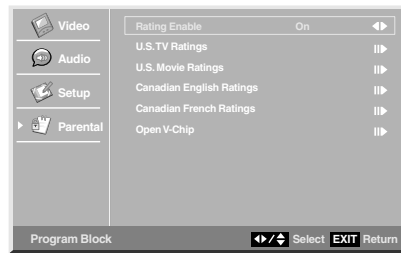
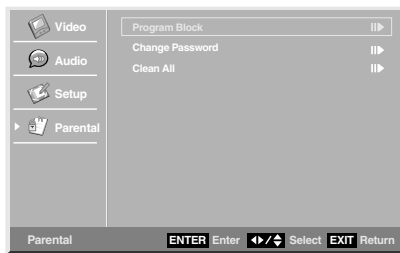

- Rating Enable** : Select On to edit the following parental items. Select Off to disable parental control.
- Open V-Chip** : Read the ratings from ATSC TV programs if there is rating information broadcasted, and denies the channel when its rating is higher than the ratings you pre-set.

U.S. TV Ratings	TV-Y : Recommended for all children. TV-Y7 : Recommended for all children age 7 and above. TV-G : General Audience. TV-PG : Parental Guidance Suggested. TV-14 : Parental Strongly Cautioned. TV-MA : Mature Audience Only.
U.S. Movie Ratings	G : GENERAL AUDIENCES, Suitable for all ages. PG : PARENTAL GUIDANCE SUGGESTED - Some material may not be suitable for children. PG-13 : PARENTS STRONGLY CAUTIONED - Some material may be inappropriate for children under 13. R : RESTRICTED, Under 17 requires accompanying parent or adult guardian for viewing in movie theaters. NC-17 : No one 17 or under admitted in movie theaters, X : Adults Only.
Canadian English Ratings	C : Children. C8+ : Recommended for children age 8 and older. G : GENERAL AUDIENCES, Suitable for all ages. PG : PARENTAL GUIDANCE SUGGESTED - Some material may not be suitable for children. 14+ : Viewers 14 years and older. 18+ : Adult Programming.
Canadian French Ratings	G : GENERAL AUDIENCES, Suitable for all ages. 8 ans+ : Not recommended for young children. 13 ans+ : Not suitable for children under the age of 13. 16 ans+ : Not suitable for children under the age of 16. 18 ans+ : Adult Programming.

LANGUAGE CODE LIST

Code	Language Name	Code	Language Name	Code	Language Name	Code	Language Name
AA	Afar	FY	Frisian	MG	Malagasy	SL	Slovenian
AB	Abkhazian	GA	Irish	MI	Maori	SM	Samoan
AF	Afrikaans	GB	Scots Gaelic	MK	Macedonian	SN	Shona
AM	Ameharic	GL	Galician	ML	Malayalam	SO	Somali
AR	Arabic	GN	Guarani	MN	Mongolian	SQ	Albanian
AS	Assamese	GU	Gujarati	MO	Moldavian	SR	Serbian
AY	Aymara	HA	Hausa	MR	Marathi	SS	Siswat
AZ	Azerbaijani	HI	Hindi	MS	Malay	ST	Sesotho
BA	Bashkir	HR	Croatian	MT	Maltese	SU	Sundanese
BE	Byelorussian	HU	Hungarian	MY	Burmese	SV	Swedish
BG	Bulgarian	HY	Armenian	NA	Nauru	SW	Swahili
BH	Bihari	IA	Interlingua	NE	Nepali	TA	Tamil
BI	Bislama	IE	Interlingue	NL	Dutch	TE	Telugu
BN	Bengali	IK	Inupiak	NO	Norwegian	TG	Tajik
	Bangla	IN	Indonesian	OC	Occitan	TH	Thai
BO	Tibetan	IS	Icelandic	OM	(Afan) Oromo	TI	Tigrinya
BR	Breton	IT	Italian	OR	Oriya	TK	Turkmen
CA	Catalan	IW	Hebrew	PA	Panjabi	TL	Tagalog
CO	Corsican	JA	Japanese	PL	Polish	TN	Setswana
CS	Czech	JI	Yiddish	PS	Pashto, Pushto	TO	Tonga
CY	Welsh	JW	Javanese	PT	Portuguese	TR	Turish
DA	Danish	KA	Georgian	QU	Quechua	TS	Tsonga
DE	German	KK	Kazakh	RM	Rhaeto- Romance	TT	Tatar
DZ	Bhutani	KL	Greenlandic			TW	Twi
EL	Greek	KM	Cambodian	RN	Kirundi	UK	Ukrainian
EN	English	KN	Kannada	RO	Romanian	UR	Urdu
EO	Esperanto	KO	Korean	RU	Russian	UZ	Uzbek
ES	Spanish	KS	Kashmiri	RW	Kinyarwanda	VI	Vietnamese
ET	Estonian	KU	Kurdish	SA	Sanskrit	VO	Volapük
EU	Basque	KY	Kirghiz	SD	Sindhi	WO	Wolof
FA	Persian	LA	Latin	SG	Sangho	XH	Xhosa
FI	Finnish	LN	Lingala	SH	Serbo- Croatian	YO	Yoruba
FJ	Fiji	LO	Laothian			ZH	Chinese
FO	Faroese	LT	Lithuanian	SI	Singhalese	ZU	Zulu
FR	French	LV	Latvian, Lettish	SK	Slovak		

MAINTENANCE

CLEANING THE DISC

A defective or soiled disc inserted into the unit can cause sound to drop out during playback. Handle the disc by holding its inner and outer edges.

- Do NOT touch the surface of the unlabeled side of the disc.
- Do NOT stick paper or tape on the surface.
- Do NOT expose the disc to direct sunlight or excessive heat.
- Clean the disc before playback. Wipe the disc from the center outward with a cleaning cloth.
- NEVER use solvents such as benzine or alcohol to clean the disc.
- Do NOT use irregular shaped discs (example : heart shaped, octagonal, etc.). They may cause malfunctions.



CLEANING THE UNIT

- Be sure to turn the unit off and disconnect the AC power cord before maintaining the unit.
- Wipe the unit with a dry soft cloth. If the surfaces are extremely dirty, wipe clean with a cloth that has been dipped in a weak soap-and-water solution and wrung out thoroughly. Wipe with a dry cloth.
- Never use alcohol, benzine, thinner, cleaning fluid or other chemicals. Do NOT use compressed air to remove dust.

IMPORTANT NOTE

Before transporting the unit, remove the disc from the disc compartment.

TROUBLE SHOOTING GUIDE

SYMPTOM

CAUSE (AND REMEDY)

No power.

- Ensure the AC power cord is connected.
- Turn on the unit.

The remote does not function.

- Remove any obstacles between the remote and the unit.
- Use the remote near the unit.
- Point the remote at the remote sensor on the unit.
- Replace the batteries in the remote with new ones.

DVD

No sound or only a very low-level sound is heard.

- Make sure that you've selected DVD mode.
- The system is in pause mode. Press the ► **PLAY** button to return to normal play mode.
- Fast forward or fast reverse is performed. Press the ► **PLAY** button to return to normal play mode.
- Make sure that AUDIO / VIDEO output and AV IN input connections are correct.
- The DTS DVD cannot be decoded to have speaker output.
- This unit is too hot. Power off the unit for 30 minutes to cool down.

No picture.

- The region number of the disc doesn't match the region number of this unit.



The picture is not clear.

- Clean the disc.
- The disc is scratched.

Severe hum or noise is heard.

- The plugs and jacks are dirty. Wipe them with a cloth slightly moistened with alcohol.
- Clean the disc.

The disc does not play.

- There is no disc inside ("No Disc" appears on the screen).
- Insert the disc correctly with the playback side facing down.
- Clean the disc.
- A non-NTSC disc has been inserted. The unit and disc region number are incompatible.
- Condensation may have formed inside the unit due to a sudden change in temperature. Wait about an hour for it to clear and try again.



TROUBLE SHOOTING GUIDE

SYMPTOM

CAUSE (AND REMEDY)

TV

Bad Picture (snow, multiple images, distortion, blurry)

- Check the location of the antenna and adjust it if necessary.
- Make sure the antenna cable is firmly connected.
- Make sure all input cables are firmly connected.

No sound.

- Increase the volume.
- Check whether the mute function has been activated on the remote control.

Black and white picture.

- Check the Video setting within the TV Menu.
- Check to make sure the program you are watching is broadcast in Color and not Black & White.

No picture or sound.

- Make sure the unit is plugged in and turned on.
- Make sure that TV mode is selected.
- Try a new channel to check for possible station trouble.
- Make sure the antenna is connected properly.
- Increase the volume.
- Make sure the antenna or audio/video source device is working properly.
- Make sure all cables are firmly connected.
- Check for local interference.

Colored patches of picture.

- Make sure there are no unshielded electrical devices nearby that are causing interference.
- Turn the TV off for 30 minutes, then try it again.



Unit : INCH

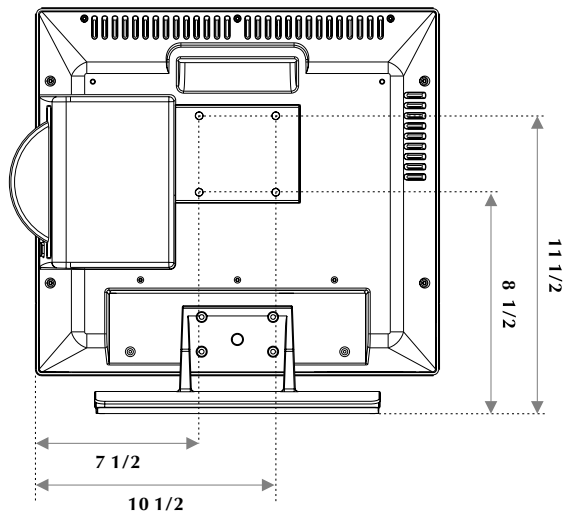
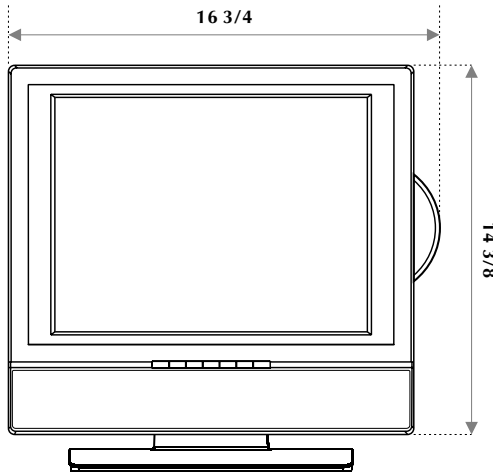
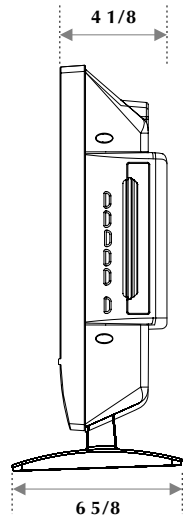

Printed in China
811-211591W220

Free Manuals Download Website

<http://myh66.com>

<http://usermanuals.us>

<http://www.somanuals.com>

<http://www.4manuals.cc>

<http://www.manual-lib.com>

<http://www.404manual.com>

<http://www.luxmanual.com>

<http://aubethermostatmanual.com>

Golf course search by state

<http://golfingnear.com>

Email search by domain

<http://emailbydomain.com>

Auto manuals search

<http://auto.somanuals.com>

TV manuals search

<http://tv.somanuals.com>