

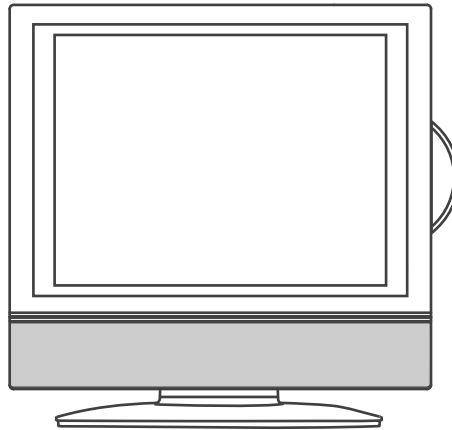

FPE1508DV

**15" FLAT PANEL LCD TV
WITH BUILT-IN DVD PLAYER**



OWNER'S MANUAL



FOR ASSISTANCE CALL CUSTOMER SERVICE AT 1-800-645-4994
OR VISIT US AT WWW.AUDIOVOX.COM

128-8323

PLV21150CS1 - AUDIOVOX ENGLISH IB
I/B [P/N: 811-211591W420]
SIZE : 148 X 210MM
MATERIAL : 80g WOODSFREE PAPER
09-01-2008

Printed in China
811-211591W420

SAFETY PRECAUTIONS



WARNING : TO REDUCE THE RISK OF ELECTRIC SHOCK, DO NOT REMOVE COVER (OR BACK). NO USER SERVICEABLE PARTS INSIDE. REFER SERVICING TO QUALIFIED SERVICE PERSONNEL.



The lightning flash with arrowhead symbol, within an equilateral triangle, is intended to alert the user to the presence of uninsulated "dangerous voltage" within the product's enclosure that may be of sufficient magnitude to constitute a risk of electric shock to persons.



The exclamation point within an equilateral triangle is intended to alert the user to the presence of important operating and maintenance (servicing) instructions in the literature accompanying the appliance.



The symbol for Class II (Double Insulation)



This product contains a low power laser device.

CAUTION
INVISIBLE LASER RADIATION WHEN OPEN AND INTERLOCKS DEFEATED. AVOID EXPOSURE TO BEAM

CLASS 1 LASER PRODUCT

CAUTION

- DANGER OF EXPLOSION IF BATTERY IS INCORRECTLY REPLACED. REPLACE ONLY WITH THE SAME OR EQUIVALENT TYPE.
- **TO PREVENT ELECTRIC SHOCK, MATCH WIDE BLADE OF PLUG TO WIDE SLOT OF WALL OUTLET, THEN FULLY INSERT.**
- USE OF CONTROLS OR ADJUSTMENTS OR PERFORMANCE OF PROCEDURES OTHER THAN THOSE SPECIFIED MAY RESULT IN HAZARDOUS RADIATION EXPOSURE.



WARNING :

- TO PREVENT FIRE OR SHOCK HAZARD, DO NOT EXPOSE THIS UNIT TO RAIN OR MOISTURE. DO NOT PLACE OBJECTS FILLED WITH LIQUIDS ON OR NEAR THIS UNIT.
- SHOULD ANY TROUBLE OCCUR, DISCONNECT THE AC POWER CORD AND REFER SERVICING TO A QUALIFIED TECHNICIAN.

PLACEMENT INFORMATION

- Do not use this unit in places that are extremely hot, cold, dusty or humid.
- Do not restrict the airflow of this unit by placing it somewhere with poor airflow, by covering it with a cloth, by placing it on bedding or carpeting.

SAFETY INFORMATION

- When connecting or disconnecting the AC power cord, grip the plug and not the cord itself. Pulling the cord may damage it and create a hazard.
- When you are not going to use the unit for a long period of time, disconnect the AC power cord.

CONDENSATION INFORMATION

- When left in a heated room where it is warm and damp, water droplets or condensation may form inside the equipment. When there is condensation inside the unit, the unit may not function normally. Let the unit stand for 1-2 hours before turning the power on or gradually heat the room and let the unit dry before use.

RATING PLATE LOCATION

The rating plate is located on the rear of the unit.

FCC STATEMENTS

NOTE: This unit has been tested and found to comply with the limits for a Class B digital device, pursuant to Part 15 of the FCC Rules. These limits are designed to provide reasonable protection against harmful interference in a residential installation. This unit generates, uses and can radiate radio frequency energy and, if not installed and used in accordance with the instructions, may cause harmful interference to radio communication. However, there is no guarantee that interference will not occur in a particular installation. If this unit does cause harmful interference to radio or television reception, which can be determined by turning the unit off and on, the user is encouraged to try to correct the interference by one or more of the following measures:

- Reorient or relocate the receiving antenna.
- Increase the separation between the unit and receiver.
- Connect the unit into an outlet on a circuit different from that to which the receiver is connected.
- Consult the dealer or an experienced radio/TV technician for help.



WARNING: Changes or modifications to this unit not expressly approved by the party responsible for compliance could void the user authority to operate the unit.

IMPORTANT SAFETY INSTRUCTIONS

- 1) Read these instructions.
- 2) Keep these instructions.
- 3) Heed all warnings.
- 4) Follow all instructions.
- 5) Do not use this apparatus near water.
- 6) Clean only with a dry cloth.
- 7) Do not block any ventilation openings. Install in accordance with the manufacturer's instructions.
- 8) Do not install near any heat sources such as radiators, heat registers, stoves, or other apparatus (including amplifiers) that produce heat.
- 9) Do not defeat the safety purpose of the polarized or grounding-type plug. A polarized plug has two blades with one wider than the other. A grounding type plug has two blades and a third grounding prong. The wide blade or the third prong is provided for your safety. If the provided plug does not fit into your wall outlet, consult an electrician for replacement of the obsolete outlet.
- 10) Protect the power cord from being walked on or pinched particularly at plugs, convenience receptacles, and the point where they exit from the apparatus.
- 11) Only use attachments / accessories specified by the manufacturer.
- 12) Use only with the cart, stand, tripod, bracket, or table specified by the manufacturer, or sold with the apparatus.  When a cart is used, use caution when moving the cart / apparatus combination to avoid injury from tip-over.
- 13) Unplug this apparatus during lightning storms or when unused for long periods of time.
- 14) Refer all servicing to qualified service personnel. Servicing is required when the apparatus has been damaged in any way, such as the power cord or plug is damaged, liquid has been spilled or objects have fallen into the apparatus, the apparatus has been exposed to rain or moisture, does not operate normally, or has been dropped.

MAINTENANCE

CLEANING THE DISC

A defective or soiled disc inserted into the unit can cause sound to drop out during playback.

Handle the disc by holding its inner and outer edges.

- Do NOT touch the surface of the unlabeled side of the disc.
- Do NOT stick paper or tape on the surface.
- Do NOT expose the disc to direct sunlight or excessive heat.
- NEVER use solvents such as benzine or alcohol to clean the disc.
- Clean the disc before playback. Wipe the disc from the center outward with a cleaning cloth.
- Do NOT use irregular shaped discs (example : heart shaped, octagonal, etc.). They may cause malfunctions.

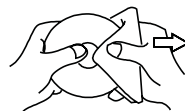

CLEANING THE UNIT

- Be sure to turn the unit off and disconnect the AC power cord before maintaining the unit.
- Wipe the unit with a dry soft cloth. If the surfaces are extremely dirty, wipe clean with a cloth that has been dipped in a weak soap-and-water solution and wrung out thoroughly. Wipe with a dry cloth.
- Never use alcohol, benzine, thinner, cleaning fluid or other chemicals. Do NOT use compressed air to remove dust.

IMPORTANT NOTE

Before transporting the unit, remove the disc from the disc compartment.

CONTENTS

SAFETY PRECAUTIONS	1	CD/DVD OPERATION	21 – 22
IMPORTANT SAFETY INSTRUCTIONS	2	Playing a disc	21
.....	2	Playing a picture file disc	21
MAINTENANCE	2	Pausing playback (still mode)	21
CONTENTS	3	Stopping playback	21
QUICK INSTALLATION	4	Skipping to a different track	21
DISC FORMATS	5	Fast forward / fast reverse	22
ACCESSORIES	6	Slow-motion play (DVD)	22
GETTING STARTED	6	Audio selection (DVD)	22
CONTROL REFERENCE GUIDE	7 – 9	Subtitle selection (DVD)	22
CONNECTIONS	10 – 17	Angle Selection (DVD)	22
Connecting a TV Antenna / Cable / Satellite	10	SPECIAL FUNCTIONS	23
.....	10	Display function (DVD)	23
Connecting an A / V Device	10	Locating a specific title (DVD)	23
Connecting Devices with a Composite (Yellow RCA-Type) Video Output	11	Locating a specific chapter/track	23
Connecting Devices with a Composite (Yellow RCA-Type) Video Input	11	Locating a specific time	23
Connecting a High-Definition (HD) Source	12	REPEAT PLAYBACK	23 – 24
.....	12	Repeating a chapter (DVD)	23
Connecting a PC	12	Repeating a single track (CD)	24
Connecting an Audio Amplifier	13	Repeating a specific section (DVD) (CD)	24
POWER SUPPLY	13	DVD PROGRAMMABLE MEMORY	24
Using the Car Power Adapter	13	Programmable memory	24
Using the AC Power Adapter	13	Title/chapter programmed playback (DVD) . ..	24
INSTALLATION	14	CUSTOMIZING THE DVD FUNCTION SETTINGS	25
Removing the base stand	14	Language setup	25
Mounting on the wall	14	Video setup	25
USING HEADPHONES	15	System setup	25
UNIT OPERATION	15	TV display	25
SOUND SYSTEM	15	Default	25
TV SETUP	16 – 20	TROUBLE SHOOTING GUIDE	26
Picture menu	16		
Audio menu	16		
Time menu	17		
Setup menu	17 – 18		
Parental menu	18 – 19		
TV menu	20		

QUICK INSTALLATION

When you turn on your television set for the first time, be sure to place it on a solid stable surface. To avoid danger, do not expose the TV to water, or a heat source (e.g. lamp, candle, radiator). Do not obstruct the ventilation grid at the rear and be sure to leave sufficient gaps around the unit as shown.

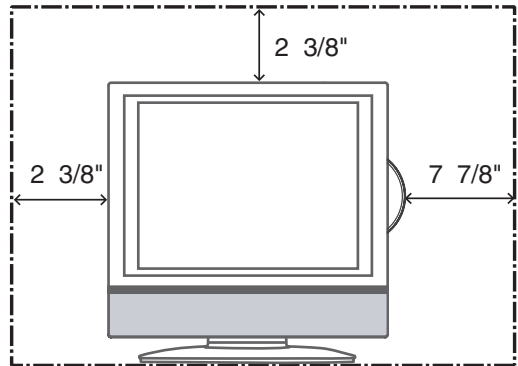

TURNING ON THE UNIT FOR THE FIRST TIME

The first time you turn on the unit, the unit will enter the setup mode. You can easily follow the prompt message on the screen to complete basic TV settings.

Make sure the RF aerial has been connected properly to the **TV ANTENNA** input jack on the rear of the system.

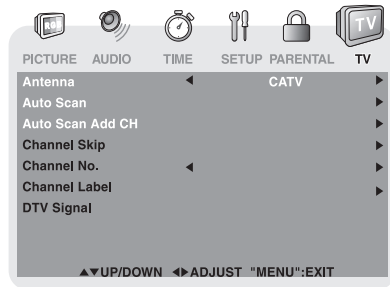
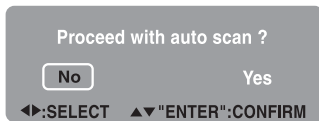

1. Press the <=> button to select Yes. Press the **ENTER** button to proceed with the initial setup.
2. Use the <▲> / <▼> button to select Antenna, then press the <=> button to select Air or CATV.

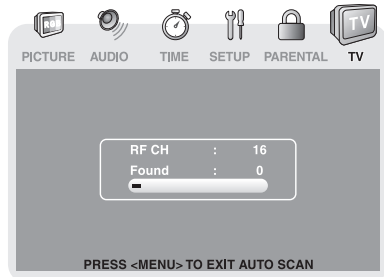
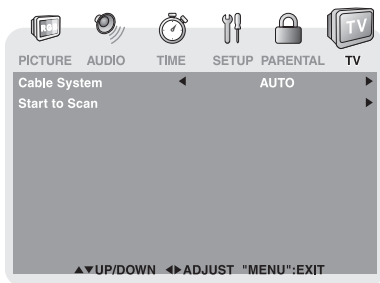

3. Use the <▲> / <▼> button to select Auto Scan, then press the <▶> button to enter auto scan menu. Use the <▲> / <▼> button to select Start to Scan, press the <▶> button to begin scanning. (If you selected CATV on Step 2, you need to select Cable System before Start to Scan). The system will automatically start to scan and preset all available TV channels.
4. After scanning has finished the system will return to the first TV channel scanned.

DISC FORMATS

NOTES ON COPYRIGHT

It is forbidden by law to copy, broadcast, show, broadcast on cable, play in public or rent copyrighted material without permission.

Apparatus Claims of U.S. Patent Nos. 4,907,093; 5,315,448 and 6,516,132 licensed for limited viewing uses only.

DVDs are copy protected, and any recordings made from these discs will be distorted. This product incorporates copyright protection technology that is protected by method claims of certain U.S. patents and other intellectual property rights owned by Macrovision Corporation and other rights owners. Use of this copyright protection technology must be authorized by Macrovision Corporation, and is intended for home and other limited viewing uses only, unless otherwise authorized by Macrovision Corporation. Reverse engineering or disassembly is prohibited.

The unit can play:

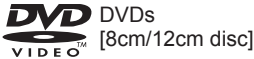

REGION MANAGEMENT INFORMATION

Region Management Information: This unit is designed and manufactured to respond to the Region Management Information that is encoded on DVDs. If the region number printed on the DVD does not correspond to the region number of this unit, this unit cannot play that disc.

The region number of this equipment is .

DISC FUNCTION OR OPERATION THAT IS NOT AVAILABLE

When the symbol appears on the screen, it indicates that the function or operation attempted is not available at that time. This occurs because the DVD manufacturer determines the specific functions. Certain functions may not be available on some discs. Be sure to read the documentation provided with the DVD.

ICONS USED ON DVDs

Sample Icons:

	Language selections for audio
	Language selections for subtitles
	Screen aspect ratio
	Multiple camera angles
	Region code indicator

NOTE

When playing back a CD-G (Graphics) or CD EXTRA disc, the audio portion will be played, but the graphic images will not be shown.

TITLES, CHAPTERS AND TRACKS

- DVDs are divided into "TITLES" and "CHAPTERS". If the disc has more than one movie on it, each movie would be a separate "TITLE". "CHAPTERS" are sections of titles.

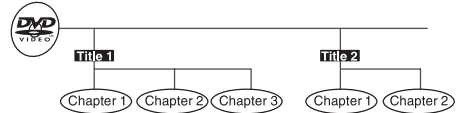

- Audio CDs are divided into "TRACKS". A "TRACK" is usually one song on an Audio CD.



NOTE

Numbers identify each title, chapter and track on a disc. Most discs have these numbers record on them, but some do not.

NOTES ON UNAUTHORIZED DISCS

You may not be able to playback some DVDs on this equipment if they were purchased from outside your geographic area or made for business purposes.

ACCESSORIES

Please check and identify the supplied accessories.

- Remote control (with batteries) x 1
- AC adapter x 1
- Car power adapter x 1

GETTING STARTED

USING THE REMOTE CONTROL

- Point the remote control at the remote sensor located on the unit.
- When there is a strong ambient light source, the performance of the infrared remote sensor may be degraded, causing unreliable operation.
- The recommended effective distance for remote operation is about 16 feet (5 meters).

TO INSTALL THE BATTERIES

1. Open the battery door.

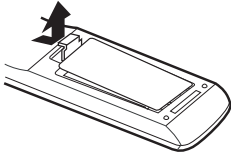

2. Insert 2 "AAA" batteries.

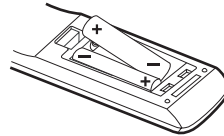

BATTERY REPLACEMENT

When the batteries become weak, the operating distance of the remote control is greatly reduced and you will need to replace the batteries.



CAUTION: Danger of explosion if battery is incorrectly replaced.

NOTES

- If the remote control is not going to be used for a long time, remove the batteries to avoid damage caused by battery leakage corrosion.
- Do not mix old and new batteries. Do not mix ALKALINE, standard (CARBON-ZINC) or rechargeable (NICKEL-CADMIUM) batteries.
- Always remove batteries as soon as they become weak.
- Weak batteries can leak and severely damage the remote control.



WARNING : Do not dispose of batteries in a fire. Batteries may explode or leak.

Many universal remote controls have a "learning" feature. We recommend you use that feature to program the remote control.

For any questions or problems related to programming a universal remote control, you must contact the customer service department of the universal remote control manufacturer for assistance, or refer to the instructions included with the universal remote control. We cannot offer assistance in programming universal remote controls.

CONTROL REFERENCE GUIDE

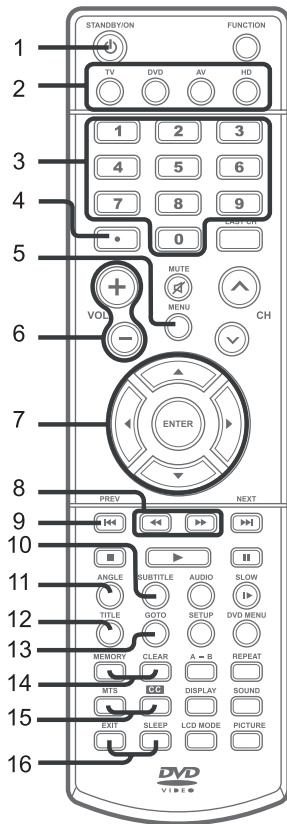

1. **⏻ STANDBY / ON button**
Press to turn ON the unit or put it in STANDBY (OFF) mode.
2. **TV button**
Press to switch to TV mode.
DVD button
Press to switch to DVD mode.
AV button
Press to switch to source connected to AV IN.
HD button
Press to switch to source connected to YUV IN (component).
3. **Number (0 - 9) buttons**
4. **• [dot] button**
Use to enter digital sub-channels. (i.e. 11.3 or 12.7)
5. **MENU button**
Press to display the on-screen TV menu.
6. **VOLUME (- / +) buttons**
Press to adjust the volume level.
7. **CURSOR (▲, ▼, ◀, ▶) buttons**
Press to highlight selections on a menu screen and adjust certain settings.
ENTER button
Press to confirm selections on a menu screen.
8. **◀◀ / ▶▶ buttons**
◀◀ : Fast reverse playback.
▶▶ : Fast forward playback.
9. **PREV ◀◀ button**
Press to select previous chapters or tracks on a disc.
10. **SUBTITLE button**
Press to select one of the subtitle languages programmed on a DVD.
11. **ANGLE button**
Press to switch the camera angle of the video presentation when scenes with multiple camera angles are recorded on a DVD.
12. **TITLE button**
Press to show the Title menu.
13. **GOTO button**
Press to skip directly to a specific location on a DVD/CD.
14. **MEMORY button**
Press to set predetermined playback.
CLEAR button
Press to clear input selections.
15. **MTS button**
Press to switch between MONO sound, STEREO sound and Secondary Audio Program (SAP).
CC button
Press to activate the Closed Captioning feature. This function only works on programs broadcasted with captions.
16. **EXIT button**
Press to exit the TV SETUP menu and return directly to normal viewing.
SLEEP button
Press to set the SLEEP timer. The unit will remain on for the time that is set, and will automatically shut off afterwards.

CONTROL REFERENCE GUIDE

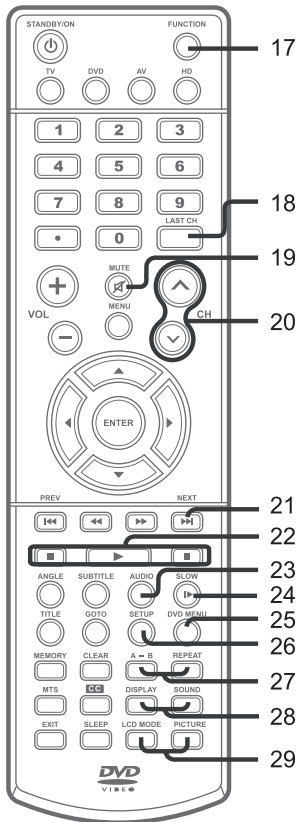

17. FUNCTION button

Press to switch between TV / DVD / AV IN / YUV IN / PC IN.

18. LAST CH button

Press to switch repeatedly between the last two channels displayed.

19. MUTE button

Press to turn off the sound.

20. CH ^ / v CH buttons

Press ^ / v to change the channels.

21. NEXT button

Press to select the next title, chapter or track on a disc.

22. STOP button

Press to stop playing a disc.

Press to go to a folder list of picture file list.

▶ PLAY button

Press to start and resume playback of a disc.

|| PAUSE button

Press to pause playback and single frame advance.

23. AUDIO button

Press to select audio soundtracks on a DVD or change the output mode of a CD.

24. SLOW button

Press to perform slow forward playback of a DVD.

25. DVD MENU button

Press to enter the main menu of the DVD.

26. SETUP button

Press to enter and exit the SETUP menu of the DVD.

27. A-B button

Press to perform point-to-point repeat playback on a DVD or CD.

REPEAT button

Press to repeat a chapter or title of a DVD.

Press to repeat a single track or whole CD.

28. DISPLAY button

Press to change disc status information displayed on the screen.

SOUND button

Press to select from preset sound settings to match the type of show you are watching. (Standard / Personal / Theater / Voice / Music)

29. LCD MODE button

Press to set size of LCD display.

PICTURE button

Select from preset screen display settings to match the type of show you are watching. (Personal / Soft / Movie / Standard / Dynamic)

CONTROL REFERENCE GUIDE

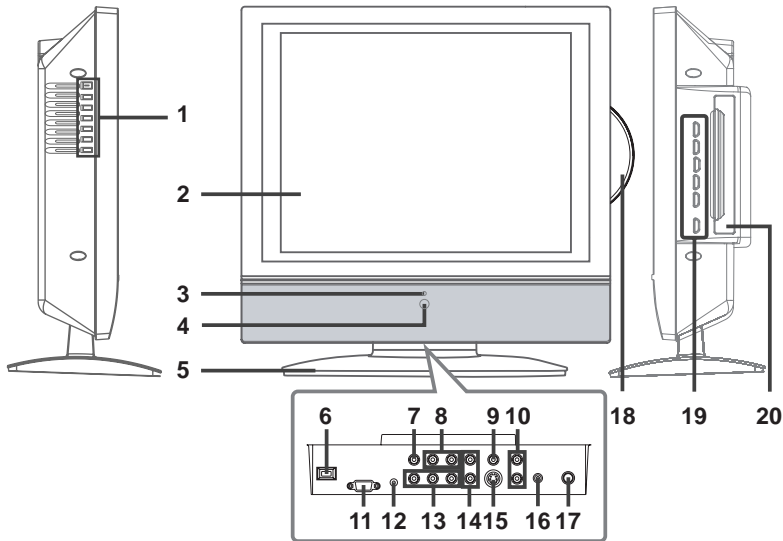

1. STANDBY/ON Button

Turns the unit on and off.

MENU Button

Enters and exits the TV menu.

FUNCTION Button

Selects TV / DVD / AV IN / YUV IN / PC IN.

– VOL + Controls

Adjusts the volume level and highlight selections (Left & Right) on the menu screen.

▲ / ▼ Buttons

Selects a TV channel and highlight selections (Up & Down) on the menu screen.

2. Color LCD Screen

3. STANDBY Indicator

Indicates whether the unit is ON or in STANDBY (OFF) mode.

Light On: The unit is in STANDBY.

Light Off: The unit is turned ON.

4. REMOTE CONTROL SENSOR

Do not block this sensor or remote control will not work.

5. Removable Base Stand

6. DC IN 12V

7. AV OUT Video Output Jack

8. AV OUT Audio Output Jacks (Left/Right)

9. AV IN Video Input Jack

10. AV IN Audio Input Jacks (Left/Right)

11. PC IN MONITOR/VGA Jack

12. PC IN Audio Jack

13. YUV IN Component Video Input Jacks (Y/PB/PR)

14. YUV IN Audio Input Jacks (Left/Right)

15. AV IN S-Video Input Jack

16. Headphone Jack

17. TV Antenna Cable Terminal - Coaxial TV Antenna Input

18. Disc Door

19. ► PLAY Button

Press to start or resume playback of a disc.

■ STOP Button

Stops playing a disc.

|| PAUSE button

Pause playback and frame advance.

◀◀ PREV Button

Press PREV button to go back to previous chapters/tracks.

Press and hold to fast reverse playback.

▶▶ NEXT Button

Press NEXT button to advance chapters/ tracks.

Press and hold to fast forward playback.

▲ PUSH OPEN Button

Push to open the disc door.

20. Disc Tray

Push to close the disc door.

CONNECTIONS

CONNECTING A TV ANTENNA / CABLE / SATELLITE

To view television channels correctly, a signal must be received from one of the following sources:

- An indoor or outdoor aerial antenna
- A cable system
- A satellite system

Connecting a Digital Antenna

The tuner in this TV receives ATSC TV signals from an antenna. This digital TV can receive standard (SDTV) and high definition (HDTV) over the air broadcasts.

Connecting an Analog Antenna or Device

The tuner in this TV receives NTSC TV signals, analog cable signals or the RF output from a satellite receiver, VCR or cable box.

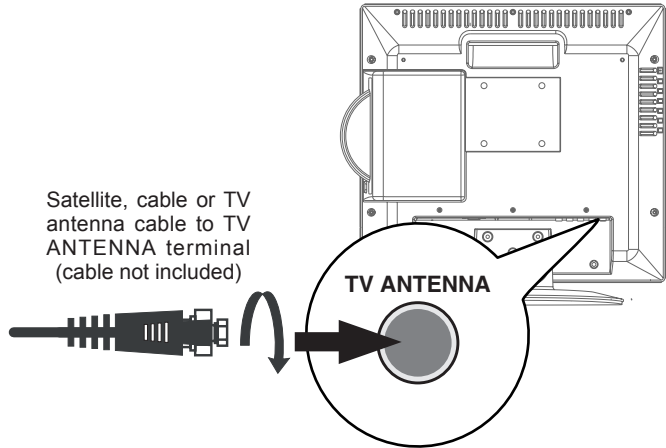

CONNECTING AN A/V DEVICE

To connect to other equipment such as a VCR, camcorder, satellite system or cable, etc.

Connecting to a VCR / Camcorder / Satellite System / Cable

Connect the AUDIO and S-VIDEO cable (not included) as shown.

Make sure you connect the cable from the other equipment (**AUDIO OUT** and **S-VIDEO OUT**) to this unit (**AUDIO IN** and **S-VIDEO IN**).

NOTE

Please refer to the user manual for the other equipment for more information.

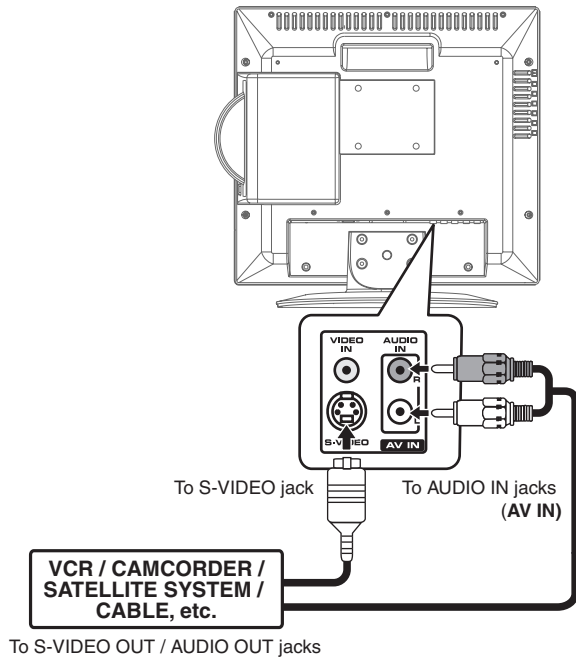

CONNECTIONS

CONNECTING DEVICES WITH A COMPOSITE (YELLOW RCA-TYPE) VIDEO OUTPUT

To connect A/V devices such as a VCR, video game system or camcorder.

Connecting to a VCR / Video Game System / Camcorder

Connect the AUDIO / VIDEO cable (not included) as shown.

Make sure you connect the cable from the other equipment (**AUDIO** and **VIDEO OUT**) to this unit (**AUDIO** and **VIDEO IN**).

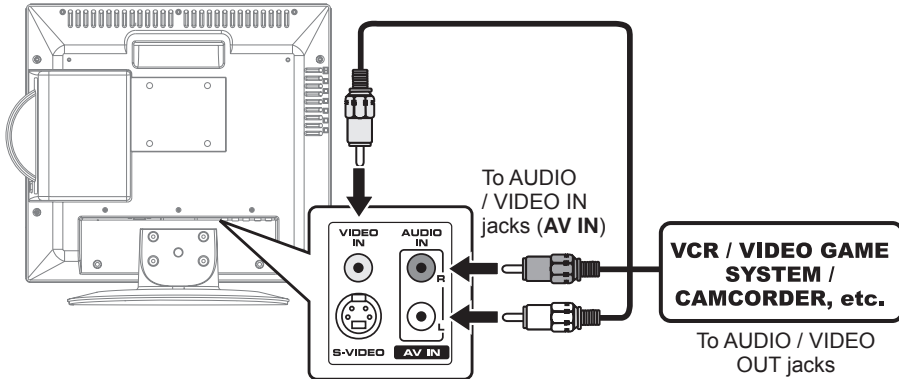

NOTE

Please refer to the user manual for the other equipment for more information.

CONNECTING DEVICES WITH A COMPOSITE (YELLOW RCA-TYPE) VIDEO INPUT

To connect A/V devices such as a VCR, PVR or camcorder.

Connecting to a VCR / PVR / Camcorder

Connect the AUDIO / VIDEO cable (not included) as shown.

Make sure you connect the cable from the other equipment (**AUDIO** and **VIDEO IN**) to this unit (**AUDIO** and **VIDEO OUT**).

NOTE

Please refer to the user manual for the other equipment for more information.

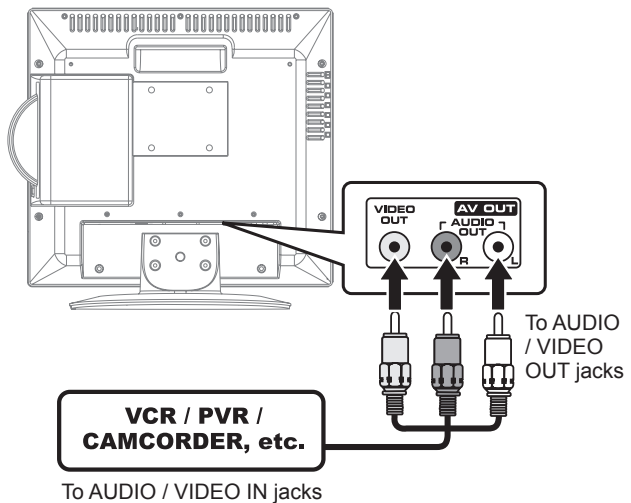

CONNECTIONS

CONNECTING A HIGH-DEFINITION (HD) SOURCE

High-Definition (HD) Devices with component video output must be connected to the YUV input. Connect the component video cable and audio cable (not included) as shown.

Make sure you connect the component video cable and audio cable from the other equipment (**COMPONENT VIDEO OUT** and **AUDIO OUT**) to this unit (**COMPONENT VIDEO IN** and **AUDIO IN - YUV IN**).

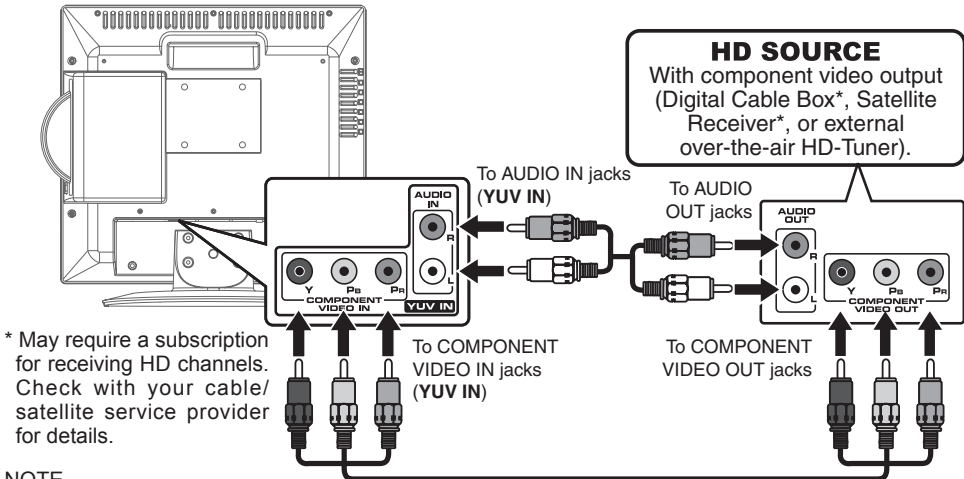

NOTE

When connecting a DVD player to the television, the picture resolution is solely dependent upon the resolution supported by the DVD player attached. DVD player resolutions vary from 480i to 1080i, and this unit can support DVD players up to a maximum resolution of 1080i.

CONNECTING A PC

Connect the 15-pin D-SUB PC/VGA connector from your computer to the 15-pin D-SUB PC/VGA input on this unit using a monitor cable and an audio cable (not included) as shown.

Make sure you connect the cable from the computer (**PC Connector** and **AUDIO - PC OUT**) to this unit (**MONITOR / VGA** and **AUDIO - PC IN**).

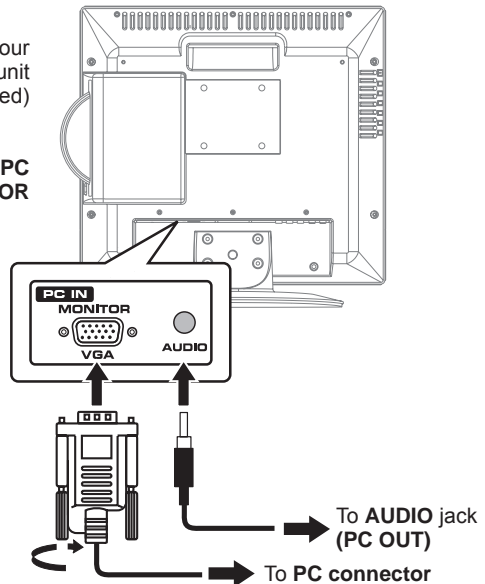

CONNECTIONS

CONNECTING AN AUDIO AMPLIFIER

This connection allows you to use an audio amplifier and external speakers.

Connect the AUDIO cable (not included) as shown.

Make sure you connect the cable from the other equipment (**AUDIO IN**) to this unit (**AUDIO OUT**).

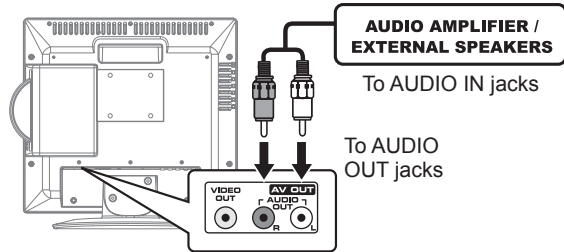

POWER SUPPLY

USING THE CAR POWER ADAPTER

The car power adapter allows the unit to be used with vehicles that have a 12V, negative ground electrical system.

CAUTIONS

- Use the provided car power adapter only. Use with other car power adapters could damage the unit.
- The car power adapter included with this unit is for its use only. Do not use it with other equipment.
- In the interest of traffic safety, do not operate this unit or view videos while driving a vehicle.
- Make sure the unit is securely fastened to prevent it from falling or flying through the air in the event of an accident.
- When the inside of the cigarette lighter socket is dirty with ashes or dust, the plug section may become hot due to poor contact. Be sure to clean the cigarette lighter socket before use.
- After use, disconnect the car power adapter from both the unit and cigarette lighter socket.

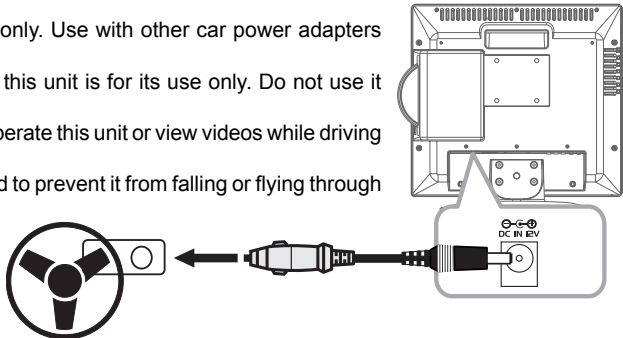

USING THE AC POWER ADAPTER

- The supplied AC power adapter operates on AC 120V.
- Press the **STANDBY/ON** button on the top of the unit or remote control to turn on the unit.

NOTE

- The AC power adapter included with this unit is for its use only. Do not use it with other equipment.
- Be sure the AC power adapter is disconnected and all functions are off before making connections.
- Make sure that all the components are connected correctly.
- **To prevent electrical shock, match wide blade of plug to wide slot of wall outlet, then fully insert.**
- When you are not going to use the unit for a long period of time, disconnect the AC power adapter.

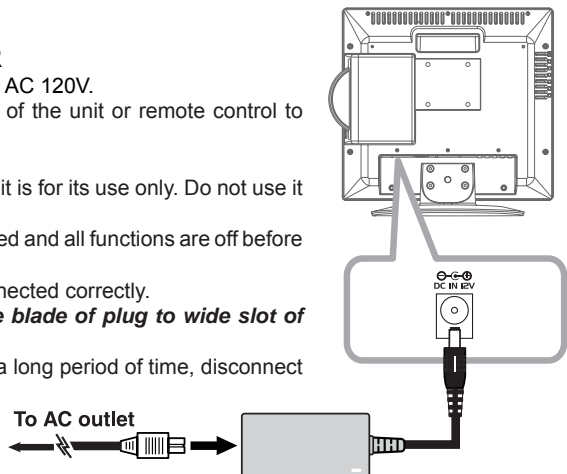

INSTALLATION

REMOVING THE BASE STAND

WARNING: The LCD Display is very fragile, and must be protected at all times when removing the base stand. Be sure that no hard or sharp object, or anything that could scratch or damage the LCD display, comes into contact with it. Do NOT place pressure on the front of the unit at any time because the screen could crack.

1. Disconnect any cables or cords connected to the unit.
2. Lay the unit down on a flat surface, so the backside is facing up, making sure to place a soft cushioned material (such as a pillow or thick piece of foam) beneath the screen.
3. Remove the four screws and then remove the BASE STAND from the TV.

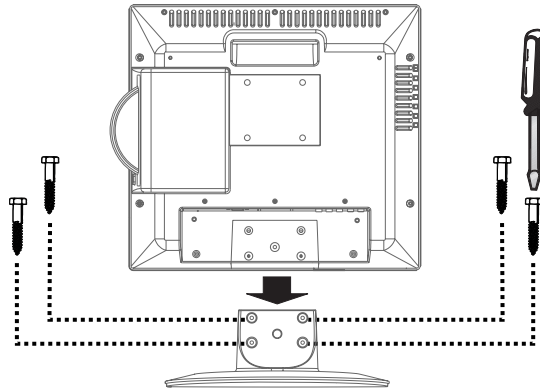

MOUNTING ON THE WALL

This unit is VESA-compliant, and is designed to be wall-mounted with a VESA-compliant 3" x 3" (75mm x 75mm) mounting kit designed for flat-panel TVs (sold separately). Mount this unit according to the directions included with the mounting kit.

NOTE

Remove the base stand before mounting the unit on the wall.

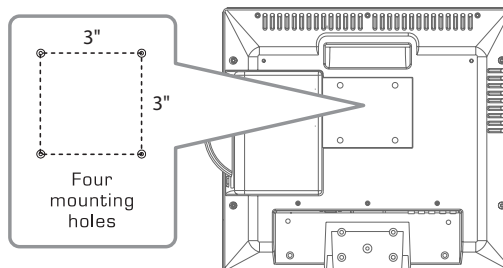

USING HEADPHONES

- Turn down the volume before connecting headphones to the unit, then adjust the volume to your desired level.
- When headphones are connected, no sound will come from the front speakers.

NOTE

Avoid listening to sound at high levels for prolonged periods of time. This may be harmful to you and may cause hearing loss.

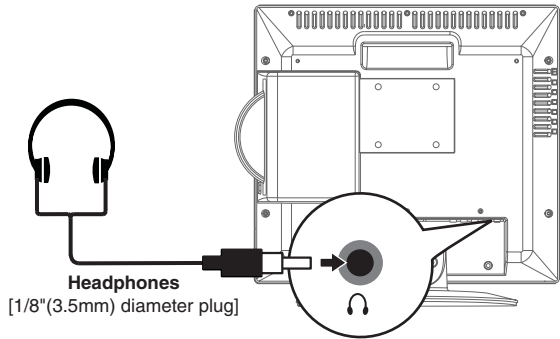

UNIT OPERATION

TURNING THE UNIT ON

When the AC power adapter is connected, press the **STANDBY/ON** button on the top of the unit to turn it on. Press the **FUNCTION** button to select the desired mode (TV / DVD / AV IN / YUV IN / PC IN). If you select DVD, the DVD logo will appear on the screen.



NOTE

When the unit is not going to be used for a long time, disconnect the AC power adapter from AC power outlet.

SOUND SYSTEM

DOLBY DIGITAL (FOR DVD)

Dolby Digital is a sound system developed by Dolby Laboratories Inc. This unit automatically recognizes DVDs that have been recorded with Dolby Digital.

Not all Dolby Digital sources are recorded with 6 channels.

Some sources marked Dolby Digital may be recorded in Dolby Surround, a 2 channel system. Look for this logo on your unit.



Manufactured under license from Dolby Laboratories.

'Dolby' and the double-D **DD** symbol are trademarks of Dolby Laboratories.

TV SETUP

Note: Some setting items on the menu screen may not activate depending on what mode the unit is currently in (TV/AV in/YUV in/PC in).

PICTURE MENU

1. Press the **MENU** button.
2. Press the **▼** button to enter **PICTURE** settings.
3. Use the **▲** or **▼** button to select the options (**Picture Mode, Contrast, Brightness, Sharpness, Tint** or **Color**). Adjust them using the **◀** or **▶** button (Screen will change to your desired setting).
4. Repeat step 3 to adjust other options.
5. To exit the MAIN MENU and return to the normal screen, press the **EXIT** or **MENU** button repeatedly.

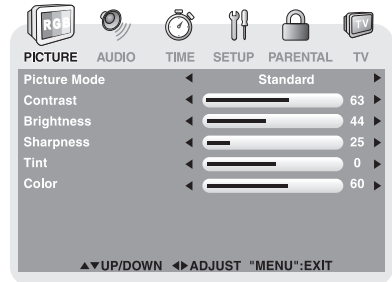

- Picture Mode** : Select from preset screen display settings to match the type of show you are watching (Standard, Soft, Movie and Personal). Select Personal mode to recall your custom settings on contrast, brightness, sharpness, tint and color.
- Contrast** : Adjust to sharpen the picture quality. The black portions of the picture become richer in darkness and the white become brighter.
- Brightness** : Adjust the brightness of the picture. Brighten or darken the whole picture.
- Sharpness** : Adjust the sharpness level to improve detail in the picture.
- Tint** : Adjust the tint of the picture. (toward purple / toward green)
- Color** : Adjust the color of the picture.

AUDIO MENU

1. Press the **MENU** button.
2. Use the **◀** or **▶** button to select **AUDIO**, then press the **▼** button to enter the AUDIO settings.
3. Use the **▲** or **▼** button to select the options (**Sound Mode, Bass, Treble, Balance, Audio Language** or **MTS**). Adjust them using the **◀** or **▶** button.
4. Repeat step 3 to adjust other options.
5. To exit the MAIN MENU and return to the normal screen, press the **EXIT** or **MENU** button repeatedly.

NOTE

Experiment with different sound settings until you find the settings you prefer.

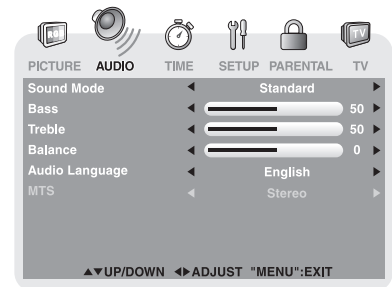

- Sound Mode** : Select from preset sound settings (Standard, Music, Movie or Personal) to match the type of show you are watching. Select Personal mode to recall your custom settings on bass, treble and balance.
- Bass** : Adjust the bass range.
- Treble** : Adjust the treble range.
- Balance** : Adjust the balance level toward the left or right speakers.
- Audio Language** : Select from English / Spanish / French. (Available for digital channels if multiple audio languages are broadcasted.)
- MTS (Multi Channel Television Sound)** : Select Stereo / SAP (Secondary Audio Program) / Mono.

NOTE

The SAP (Secondary Audio Programs) feature allows a TV station to broadcast other information, which could be audio in another language.

TV SETUP

TIME MENU

1. Press the **MENU** button.
2. Use the ◀ or ▶ button to select **TIME**, then press the ▼ button to enter the TIME settings.
3. Use the ▲ or ▼ button to select the options (**OSD Duration**, **Sleep Timer**, **Time Zone** or **Day Saving Time**). Adjust them using the ◀ or ▶ button.
4. Repeat step 3 to adjust other options.
5. To exit the MAIN MENU and return to the normal screen, press the **EXIT** or **MENU** button repeatedly.

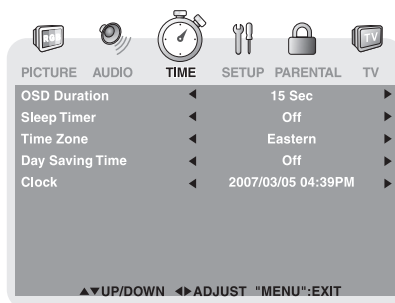

OSD (On Screen Display) Duration : Select the length of time for the On screen menu is displayed : 15 Sec / 30 Sec / 45 Sec / 60 Sec.

Sleep Timer : Select the length of time before the unit automatically changes to Standby mode : Off -> 5 Minutes -> 10 Minutes -> 15 Minutes -> 30 Minutes -> 60 Minutes -> 90 Minutes -> 120 Minutes -> Off.

Time Zone : Select the time zone from Eastern / Central / Mountain / Pacific / Alaska / Hawaii.

Day Saving Time : Select On to activate daylight savings time.

Clock : Display the current time.

SETUP MENU

1. Press the **MENU** button.
2. Use the ◀ or ▶ button to select **SETUP**, then press the ▼ button to enter the SET UP settings.
3. Use the ▲ or ▼ button to select the options (**OSD Language**, **Color Mode**, **PC Set Up**, **Closed Caption** or **Restore Setting**). Adjust them using the ◀ or ▶ button (Screen will change to your desired setting); or press the ▶ button to go into the detailed settings.
4. Press the **MENU** button to return to the previous menu.
5. Repeat steps 3 and 4 to adjust other options.
6. To exit the MAIN MENU and return to the normal screen, press the **EXIT** or **MENU** button repeatedly.

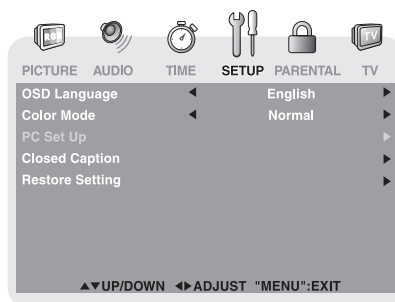

OSD (On Screen Display) Language : Select On-screen menu language from English / French / Spanish.

Color Mode : Adjust the three color temperature of the picture. Choose from Normal (balanced), Warm (red white), or Cool (blue white) modes.

Restore Setting : If you reset the TV to the factory settings, all your present settings on PICTURE and AUDIO will be erased and replaced by the factory's default settings.

TV SETUP

PC Set Up (in PC mode only)

- Resolution : 1,024 x 768 max
- Refresh Frequency : 60Hz max

H - Pos : Center the image by moving it left or right.

V - Pos : Center the image by moving it up or down.

Clock : Adjusts the display clock to change width of the image.

Phase : Adjusts the image if there is flicker of screen letters, color misalignment, or blurring.

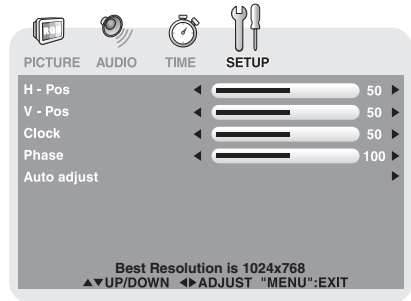

Closed Caption

NOTE

This function only works on ATSC programs broadcast with captions.

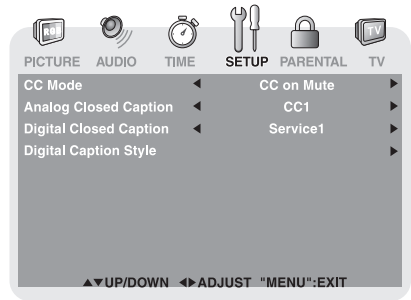

CC Mode : Select closed caption On, Off or CC on Mute.

Analog Closed Caption : Select the analog closed caption or turn it off.

Digital Closed Caption : Select the digital closed caption or turn it off.

Digital Caption Style : Select as Broadcaster to use the default digital caption style of the broadcaster. Select Custom to activate the caption style items and set your desired detailed settings.

PARENTAL MENU

Password

1. Press the **MENU** button.
2. Use the ◀ or ▶ button to select **PARENTAL**, then press the ▼ button to enter the PARENTAL settings. The menu locked screen will be displayed.
3. Enter a 4-digit password. Once entered, the screen will enter the Parental menu. The preset password is 0000.

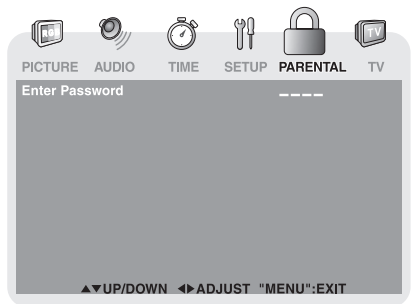

If you forget the password,
enter " 8888 " to unlock parental
control.

TV SETUP

Parental

1. Use the ▲ or ▼ button to select various Parental settings. Adjust them using the ◀ or ▶ button, or press the ► button to go into the detailed settings.
2. Press the **MENU** button to return to the previous menu.
3. Repeat steps 1 - 2 to adjust other options.
4. To exit the MAIN MENU and return to the normal screen, press the **EXIT** or **MENU** button repeatedly.

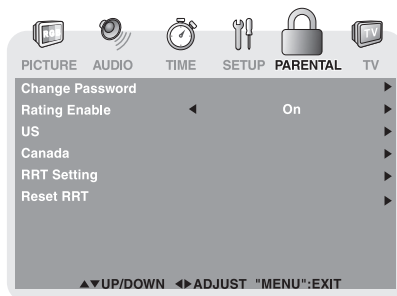

- Rating Enable** : Select On to edit the following parental items. Select Off to disable parental control.
- US** : Set TV and MPAA ratings.
- Canada** : Set Canada English and Canada French ratings.
- RRT Setting** : Set Rating Region Table.
- Reset RRT** : Reset Rating Region Table to the default settings.

U.S. TV Ratings	<p>TV-Y : Recommended for all children.</p> <p>TV-Y7 : Recommended for all children age 7 and above.</p> <p>TV-G : General Audience.</p> <p>TV-PG : Parental Guidance Suggested.</p> <p>TV-14 : Parental Strongly Cautioned.</p> <p>TV-MA : Mature Audience Only.</p>
U.S. MPAA Ratings	<p>N/A : Not rated.</p> <p>G : GENERAL AUDIENCES, Suitable for all ages.</p> <p>PG : PARENTAL GUIDANCE SUGGESTED - Some material may not be suitable for children.</p> <p>PG-13 : PARENTS STRONGLY CAUTIONED - Some material may be inappropriate for children under 13.</p> <p>R : RESTRICTED, Under 17 requires accompanying parent or adult guardian for viewing in movie theaters.</p> <p>NC-17 : No one 17 or under admitted in movie theaters.</p> <p>X : Adults Only.</p>
Canadian English Ratings	<p>E : Exempt.</p> <p>C : Children.</p> <p>C8+ : Recommended for children age 8 and older.</p> <p>G : GENERAL AUDIENCES, Suitable for all ages.</p> <p>PG : PARENTAL GUIDANCE SUGGESTED - Some material may not be suitable for children.</p> <p>14+ : Viewers 14 years and older.</p> <p>18+ : Adult Programming.</p>
Canadian French Ratings	<p>E : Exempt.</p> <p>G : GENERAL AUDIENCES, Suitable for all ages.</p> <p>8 ans+ : Not recommended for young children.</p> <p>13 ans+ : Not suitable for children under the age of 13.</p> <p>16 ans+ : Not suitable for children under the age of 16.</p> <p>18 ans+ : Adult Programming.</p>

TV SETUP

TV MENU (For TV Mode Only)

1. Press the **MENU** button.
2. Use the ◀ or ▶ button to select **TV**, then press the ▼ button to enter the TV settings.
3. Use the ▲ or ▼ button to select the options (**Antenna**, **Auto Scan**, **Auto Scan Add CH**, **Channel Skip**, **Channel No.**, **Channel Label** or **DTV Signal**). Adjust them using the ◀ or ▶ button, or press the ▶ button to go into the detailed settings.
4. Press the **MENU** button to return to the previous menu.
5. Repeat steps 3 and 4 to adjust other options.
6. To exit the MAIN MENU and return to the normal screen, press the **EXIT** or **MENU** button repeatedly.

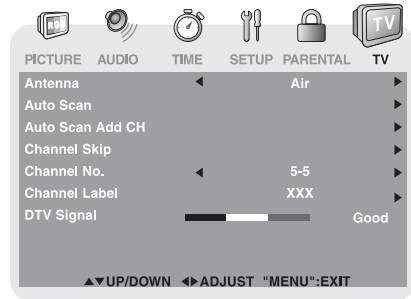

- Antenna** : Air (over-the-air broadcasts, Ch 2-69) or CATV (cable/satellite broadcasts, CH 1-135) mode are available.
- Auto Scan** : Search for usable stations and store them in memory.
- Auto Scan Add CH** : Search for more usable stations and add them in memory. The stations stored before are still kept.
- Channel Skip** : Skip weak channels and the channels you don't like.
- Channel No.** : Select a different TV channel.
- Channel Label** : Display and edit the channel label.
- DTV Signal** : Display the signal strength (for digital TV channels only).

Channel Skip

1. Use the ▲ or ▼ button to select a channel. (Press the ▶ button to select the last channel of the page; press again to go to the next page. Press the ◀ button to select the first channel of the page; press again to return to the previous page.)
2. Press the **ENTER** button to shift between On / Off. (Select On to skip the selected channel. The channel will not appear when you press the **CH ▲** / **CH ▼** button.)

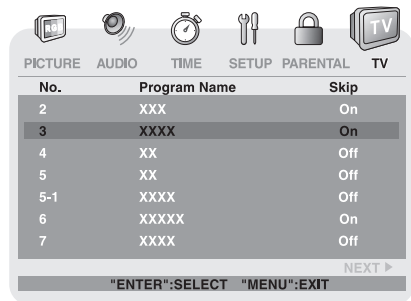

Channel Label

You can edit a label for each channel.

1. Use the ▲ or ▼ button to select the number or letter. Use the ◀ or ▶ button to move and edit the next character.
2. After editing, the Channel and Channel Label will be shown on the screen when you press the **DISPLAY** button.

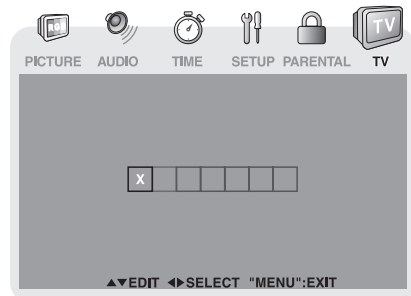



CD/DVD OPERATION

This owner's manual explains the basic instructions of this unit. Some DVDs are produced with limited operation during playback. For example, many DVDs do not allow users to skip government warnings, or in some cases previews or other features. This is not a defect in the unit. Refer to the instruction notes of discs.





“” may appear on the screen during operation. A “” means that the desired operation is not permitted by the unit or disc.

PLAYING A DISC



1. Press the **STANDBY/ON** button to turn on the unit.
2. Press the **FUNCTION** button repeatedly to select DVD mode or directly to press **DVD** button on the remote, then press the **ENTER** button.
See CUSTOMIZING THE DVD FUNCTION SETTINGS before proceeding to step 3.
3. Press the  **PUSH OPEN** button to open the disc door.
4. Hold the disc by its edge and gently push it onto the spindle with label side facing towards until hear a “click”.
5. Push the disc tray to close the disc door.
It takes a short while for your unit to load the disc. After loading, the unit will automatically either bring you to the main menu of DVD, or start playing the DVD. If the unit does not automatically start playing the DVD, press the  **PLAY** button.

PLAYING A PICTURE FILE DISC



This unit can play JPG files recorded on CD-R and CD-RW discs.

1. Press the  **PUSH OPEN** button to open the disc door.
2. Hold the disc by its edge and gently push it onto the spindle with label side facing towards until hear a “click”.
3. Push the disc tray to close the disc door.
4. The unit will load the disc and automatically display the contents of the disc on the screen, while also beginning to play the picture file. These files will then be played back one by one.
5. Press the  **STOP** button to go to the folder list.
6. Press the  or  button to highlight a file to play. Press the  **PLAY** button to start playback.



NOTE



- You can press the  **PAUSE** button to interrupt playback, and press the  **PLAY** button to resume playback.
- You also can use the **GOTO** function or use the numbered buttons to enter the image number to quickly select any image.
- Press the **ANGLE** button on the remote control to rotate the picture orientation by 90°.

PAUSING PLAYBACK (STILL MODE)



Press the  **PAUSE** button. To resume normal playback, press the  **PLAY** button. Each time you press the  **PAUSE** button, the picture advances one frame.

STOPPING PLAYBACK

Press the  **STOP** button at the location where you want to interrupt playback. To resume playback at the position where the disc was stopped, press the  **PLAY** button.

If you press the  **STOP** button twice, the unit's memory will be cleared and pressing the  **PLAY** button will reset the disc to the beginning.

SKIPPING TO A DIFFERENT TRACK

- Press the  **PREV** button to go back to previous chapters/tracks.
- Press the  **NEXT** button to advance chapters/tracks.
- For an Audio CD, use the number buttons (remote control only) to jump directly to that track number.

CD/DVD OPERATION

FAST FORWARD / FAST REVERSE

1. Press the **SEARCH** ►► or ◄◄ **SEARCH** button when a disc is playing.
 - Each time the **SEARCH** ►► or ◄◄ **SEARCH** button is pressed, the speed of fast scan changes in the following sequence:

►► 2x → ►► 4x → ►► 8x → ►► 16x ◄◄ 2x → ◄◄ 4x → ◄◄ 8x → ◄◄ 16x

2. Press the ► **PLAY** button when you reach the desired point to resume playback at normal speed.

SLOW-MOTION PLAY (DVD)

1. Press the ► **SLOW** button on remote control in the play mode. Each time the ► **SLOW** button is pressed, the speed of slow-motion playback changes in the following sequence:

► 1/2 → ► 1/4 → ► 1/8 → ► 1/16

2. Press the ► **PLAY** button to return to the normal playback speed.

AUDIO SELECTION (DVD)

On some discs, the sound is recorded in two or more formats. Follow the directions below to select the preferred language and sound system.

1. While a disc is playing, press the **AUDIO** button to show the current audio format number. **Audio 1/3: Dolby D 2ch English**
2. Press the **AUDIO** button repeatedly to select the desired audio format.

NOTE

- If only one audio format is recorded, the number does not change.
- About two seconds later, playback continues in the new audio format.

SUBTITLE SELECTION (DVD)

1. While a DVD is playing, press the **SUBTITLE** button to display the current language setting, as shown in the example. **Subtitle 02/03: Spanish**
2. Press the **SUBTITLE** button repeatedly to select the desired subtitle language.

NOTE

- If only one language is recorded, the language does not change.
- About two seconds later, playback continues with the new subtitle you selected.
- The number of languages recorded differs depending on the disc.
- This function can only be used for discs on which subtitles have been recorded in multiple languages.
- On some DVDs, subtitles are activated from the main menu of the DVD. Press the **DVD MENU** button to activate the main menu.

ANGLE SELECTION (DVD)

Some DVDs contain scenes which have been shot from a number of different angles. For these discs, the same scene can be viewed from each of these different angles.

1. While you are playing a DVD with different angles recorded, press the **ANGLE** button to view the number of the current angle available.
2. Press the **ANGLE** button repeatedly to change the scene to the next angle in those recorded.
 - About two seconds later, playback continues from the new angle you selected.
 - If no button is pressed within 10 seconds, playback continues without changing the current angle.

 1/3

Sequence of angle shots
(Example)

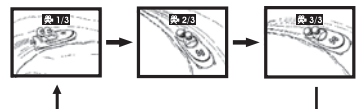

NOTE

- This function can only be used for discs on which scenes shot from multiple angles have been recorded.
- If only one angle is recorded, "◻ 1/1" is displayed.

SPECIAL FUNCTIONS

DISPLAY FUNCTION (DVD)

While the disc is playing, press the **DISPLAY** button repeatedly to display information on operation status.

Chapter Elapsed	Chapter Remain	Title Remain	Display Off
Tt 01/03 Ch 03/12 0:13:26	Tt 01/03 Ch 03/12 0:05:42	Tt 01/03 Ch 03/12 0:36:08	
Audio 1/1:Dolby D 5.1ch English	Audio 1/1:Dolby D 5.1ch English	Audio 1/1:Dolby D 5.1ch English	



LOCATING A SPECIFIC TITLE (DVD)

If a DVD disc contains title numbers, you can locate a specific title by directly selecting a title number.

1. In **STOP** mode, press the **GOTO** button.
2. Press the ◀ or ▶ button to highlight a specific field and press the corresponding number button(s) for the title you want.
3. Press the **ENTER** button to confirm. Playback starts from the selected title.

Title 01/03 Chapter 00/00

LOCATING A SPECIFIC CHAPTER / TRACK

If you know the chapter / track number you want to play, you can locate a specific chapter / track by directly selecting a chapter / track number.

1. Press the **GOTO** button to search for your desired chapter / track.
2. Press the ◀ or ▶ button to highlight a chapter / track and press the corresponding number button(s) for the chapter / track you want.
3. Press the **ENTER** button to confirm. Playback starts from the selected chapter / track.

Title 01/03 Chapter 01/12

LOCATING A SPECIFIC TIME

You can move to a specific location by entering its corresponding time (hours, minutes, seconds)

1. Press the **GOTO** button.
2. Press the corresponding number button(s) for the setting point you want.
3. Press the **ENTER** button to confirm. Playback starts from the selected section.

Title 01/03 Time 00:00

NOTE

- Some discs may not respond to this process.
- Some scenes may not be located as precisely as you specified.
- This method for accessing specific locations is available only within the current title of the DVD disc.

REPEAT PLAYBACK

You can play a specific title or chapter repeatedly. (Title repeat, chapter repeat, entire DVD repeat, A-B repeat)

Repeating a chapter (DVD)

You can play the same chapter repeatedly.

1. While the disc is playing, press the **REPEAT** button until the “↺ Chapter” indicator displays on the screen. The current chapter is played repeatedly.

Repeating a title

You can play the same title repeatedly.

2. While the disc is playing, press the **REPEAT** button until the “↺ Title” indicator displays on the screen. The current title is played repeatedly.

To resume normal playback

3. While the disc is playing, press the **REPEAT** button until the “Repeat Off” indicator displays on the screen.

REPEAT PLAYBACK

You can play a single track or an entire disc repeatedly.

Repeating a single track (CD)

You can play the same track repeatedly.

1. While the disc is playing, press the **REPEAT** button until the "Repeat One" indicator displays on the screen.
The current track is played repeatedly.

Repeating an entire disc

2. While the disc is playing, press the **REPEAT** button until the "Repeat All" indicator displays on the screen.
The entire disc is played repeatedly.

To resume normal playback

3. Press the **REPEAT** button until the "off" indicator displays on the screen.

Repeating a specific section (DVD) (CD)

You can play a specific section repeatedly.

1. While the disc is playing, press the **A-B** button at the beginning of the section (↶ A is displayed) you want to play repeatedly.
2. Press the **A-B** button again at the end of the section (↶ AB is displayed) you want to play repeatedly.
3. The unit will immediately begin replaying your selection.

To resume normal playback

4. While the disc is playing, press the **A-B** button until the "↶ AB OFF" indicator displays on the screen.

NOTE

- A-B repeat can only be used within the same title. If the start and end of the section to be repeated are in different titles, A-B repeat is cancelled.
- The A-B repeat function does not operate in scenes where different camera angles are recorded.

DVD PROGRAMMABLE PLAYBACK

PROGRAMMABLE MEMORY

The two types of programmed playback provided by this unit is title/chapter programmed playback.

TITLE/CHAPTER PROGRAMMED PLAYBACK (DVD)

1. Press the **MEMORY** button in PLAY mode.
2. Input the title (2 digits) and chapter (2 digits) by pressing the number buttons. (For example : 01 02, 02 05, 02 11.) It will move to the next item automatically.
3. Repeat steps 2 to add additional titles and chapters.
4. Press the ► **PLAY** button to start the programmed playback.

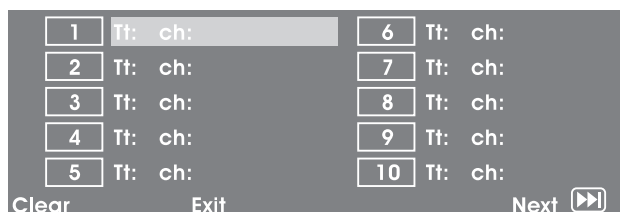

CUSTOMIZING THE DVD FUNCTION SETTINGS

LANGUAGE SETUP

1. Press the **SETUP** button in stop mode.
2. Use the **▲** or **▼** button to select the option (**OSD Language, Audio, Subtitle** or **Disc Menu**), press the **▶** button.
3. Use the **▲** or **▼** button to select your preferred language, then press the **ENTER** button to confirm.
4. Press the **◀** button to go back to previous menu. Repeat steps 2 and 3 to adjust other options.
5. To exit the SETUP MENU and return to the normal screen, press the **SETUP** button.

Language	Video	System
-- Language Setup Page --		
OSD Language	Eng	
Audio	Eng	
Subtitle	Off	
Disc Menu	Eng	
Go To Language Setup Page		

NOTE

- Some DVDs may not play in the audio language you selected. A prior language may be programmed on the disc.
- Some DVDs may be set to display subtitles in a language other than the one you selected. A prior subtitle language may be programmed on the disc.
- Some DVDs allow to change subtitle selections only via the disc menu. If this is the case, press the **DVD MENU** button and choose the appropriate subtitle from the selection on the disc menu.
- Some DVDs may not included your pre-selected language. In this case, the DVD player automatically displays disc menus consistent with the disc's initial language setting.

VIDEO SETUP

1. Press the **SETUP** button in stop mode.
2. Use the **◀** or **▶** button repeatedly until **VIDEO SETUP** appears.
3. Use the **▲** or **▼** button to select the option (**Tv Mode, Brightness** or **Contrast**), then press the **▶** button. Use the **◀** or **▶** button to make adjustments, then press the **ENTER** button. (The screen will change to your selected setting).
4. Repeat steps 2 and 3 above to adjust other options.
5. To exit the SETUP MENU and return to the normal screen, press the **SETUP** button.

Language	Video	System
-- Video Setup Page --		
Tv Mode		
Brightness	00	
Contrast	00	
Go To Video Setup Page		

SYSTEM SETUP

1. Press the **SETUP** button in stop mode.
2. Use the **◀** or **▶** button repeatedly until **SYSTEM SETUP** appears.
3. Use the **▲** or **▼** button to select the option (**Tv Display** or **Default**), then press the **▶** button. Use the **▲** or **▼** button to make adjustments, then press the **ENTER** button. (The screen will change to your selected setting).
4. Repeat steps 2 and 3 above to adjust other options.
5. To exit the SETUP MENU and return to the normal screen, press the **SETUP** button.

Language	Video	System
-- System Page --		
Tv Display	Wide	
Default	No	
Go To System Page		

TV Display

Pan Scan

- When wide-screen video is played, this mode clips the right and left sides of the image so that it can be viewed on a conventional screen.
- Some wide-screen DVDs that do not permit Pan Scan playback are automatically played in Letter Box mode (black bands at top and bottom of screen).

Letter Box

- When wide-screen video is played in this mode on a conventional screen, black bands appear at the top and bottom of the screen.

Wide-screen

- This is the correct mode for playing wide-screen videos on the unit screen or other external wide-screens.

NOTE

- The displayable picture size is preset on the DVD discs. Therefore the playback picture of some DVDs may not conform to the picture size you select.
- When you play DVDs recorded in the 4:3 aspect ratio, the playback picture will always appear in the 4:3 aspect ratio regardless of the TV Display setting.

Default

It takes 3-5 seconds to reset the unit to the factory default.

Cut off when a wide-screen video image is played.



Pan Scan



Letter Box



Wide-screen

TROUBLESHOOTING GUIDE

SYMPTOM

CAUSE (AND REMEDY)

No power.

- Check that the AC power adapter is connected.
- The unit is not turned on.

The remote does not function.

- Remove any obstacles between the remote and the unit.
- Use the remote near the unit.
- Point the remote at the remote sensor on the unit.
- Replace the batteries in the remote with new ones.

DVD

No sound or only a very low-level sound is heard.

- Make sure that you select DVD mode.
- The system is in pause mode. Press the ► **PLAY** button to return to normal PLAY mode.
- Fast-forward or fast-reverse is performed. Press the ► **PLAY** button to return to normal play mode.
- Make sure the AUDIO / VIDEO output and AV IN input connections are correct.
- The DTS DVD disc cannot be decoded to have speaker output.
- The unit is too hot. Shut off the unit for 30 minutes to cool it down.

No picture.

- The region number of the disc does not match the region number of this unit.



The picture is not clear.

- Clean the disc.
- The disc is scratched.

Severe hum or noise is heard.

- The plugs and jacks are dirty. Wipe them with a cloth slightly moistened with alcohol.
- Clean the disc.

The disc does not play.

- There is no disc inside ("No Disc" appears on the screen).
- Insert the disc correctly with the playback side facing down.
- Clean the disc.
- A non-valid disc has been inserted. The unit and disc region number are incompatible.
- Condensation may have formed inside the unit due to a sudden change in temperature. Wait about an hour for it to clear and try again.

TV

Bad Picture (snow, multiple images, distortion, blurry)

- Check the location of the antenna and adjust it if necessary.
- Make sure the antenna cable is firmly connected.
- Make sure all input cables are firmly connected.

Black and white picture.

- Check the PICTURE MENU within the TV SETUP MENU.
- Check to make sure the program you are watching is broadcast in color and not black & white.

No picture or sound.

- Make sure the unit is plugged in and turned on.
- Make sure that TV mode is selected.
- Try a new channel to check for possible station trouble.
- Make sure the antenna is connected properly.
- Increase the volume.
- Make sure the antenna or audio video source device is working properly.
- Make sure all cables are firmly connected.
- Check for local interference.

Colored patches of picture.

- Make sure there are no unshielded electrical devices nearby that are causing interference.
- Turn the unit off for 30 minutes, then try it again.

Unit : INCH

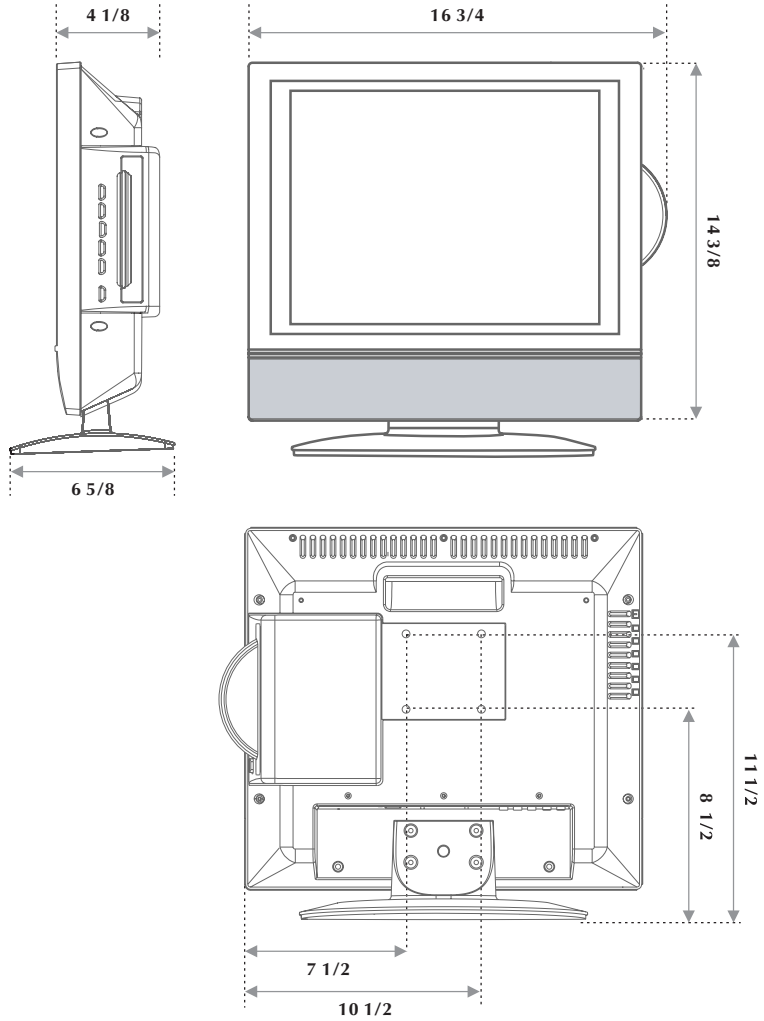

Printed in China
811-211591W420

Free Manuals Download Website

<http://myh66.com>

<http://usermanuals.us>

<http://www.somanuals.com>

<http://www.4manuals.cc>

<http://www.manual-lib.com>

<http://www.404manual.com>

<http://www.luxmanual.com>

<http://aubethermostatmanual.com>

Golf course search by state

<http://golfingnear.com>

Email search by domain

<http://emailbydomain.com>

Auto manuals search

<http://auto.somanuals.com>

TV manuals search

<http://tv.somanuals.com>