



27" LCD TV with DVD Player

Operating Instructions

Model No. FPE2706DV



For assistance, please call: **1-800-645-4994**
Or visit us at www.audiovox.com

Before connecting, operating or adjusting this product, please read these instructions completely.
Please keep this manual for future reference



For Customer Service
Visit Our Website At
www.audiovox.com
Product Information, Photos,
FAQ's, Owner's Manuals

128-7726

Table Of Contents

Important Safety Instruction	1
Product Features	3
Disc Information	4
Front Panel	5
Rear Panel	7
Remote Control	8
Special features of the DVD Module	11
System Connections	12
Connecting to External AV Signal Source (AV1)	12
Connecting to External AV Signal Source (AV2)	13
Connecting to External AV Signal Source (Video3 /Video4)	14
Connecting to HDMI Output Device	15
Connecting to External AV Device (AV OUT)	16
Connecting to Digital Amplifier	17
Connecting to PC	18
Connecting to TV Signal Input	19
Connecting to Power Supply	19
Connecting to Earphone	20
Input Source Selecting	21
System Setup	22
Preparations	22
Setup Setting	22
Video Setting	23
Audio Setting	25
Feature Setting	26
DVD Player Operation	29
USB and SD/MS/MMC Card Function	33
DVD System Setup	34
Troubleshooting	41
Specifications	42

Important Safety Instructions

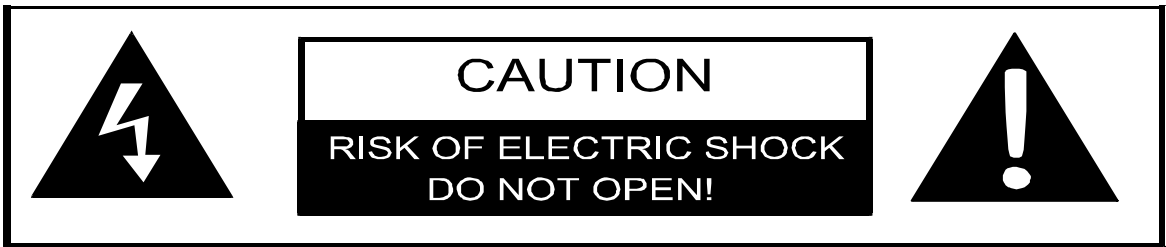

The lightning flash with arrowhead symbol, within an equilateral triangle, is intended to alert the user to the presence of un-insulated “dangerous voltage” within the product’s enclosure that may be of sufficient magnitude to constitute a risk of electric shock to persons.



The exclamation point within an equilateral triangle is intended to alert the user to the presence of important operating and maintenance (servicing) instructions in the literature accompanying the appliance.



CAUTION: Laser radiation when open. Do not stare into beam.

CAUTION: USE OF ANY CONTROLS, ADJUSTMENTS, OR PROCEDURES OTHER THAN THOSE SPECIFIED HEREIN MAY RESULT IN HAZARDOUS RADIATION EXPOSURE.

POWER SUPPLY:

Connect the supplied AC Power Cord to the side of the FPE2706DV in the connector marked 110-220V-50/60Hz. Plug the three prong end of the power cord to an AC110-220V outlet. If the unit will not be used for a long time, disconnect the plug from the outlet.

NOTE:

Before plugging the power cord into an AC outlet, make sure that all the connections have been made.

CAUTION: These servicing instructions are for use by qualified service personnel only. To reduce the risk of electric shock, do not perform any servicing other than that contained in the operating instructions unless you are qualified to do so.

Refer to service manual for servicing instructions.

Important Safety Instructions

Note:

1. Read these instructions.
2. Keep these instructions.
3. Heed all warnings.
4. Follow all instructions.
5. Do not use near water.
6. Clean only with dry cloth.
7. Do not block any ventilation openings. Maintain well ventilated conditions around the product. Do not put product on bed, sofa or anything that blocks ventilation. Install in accordance with the manufacturer's instructions.
8. Do not install near any heat sources such as radiators, heat registers, stoves, or other apparatus (including amplifiers) that produce heat.
9. Do not defeat the safety purpose of the polarized or grounding-type plug. A polarized plug has two blades with one wider than the other. If the provided plug does not fit into your outlet, consult an electrician for replacement of the obsolete outlet.
10. Protect the power cord from being walked on or pinched particularly at plugs, convenience receptacles, and the point where they exit from the apparatus.
11. Only use attachments/accessories specified by the manufacturer.
12. Use only with the cart, stand, tripod, bracket, or table specified by the manufacturer, or sold with the apparatus. When a cart is used, use caution when moving the cart/apparatus combination to avoid injury from tip-over.
13. Unplug this apparatus during lightning storms or when unused for long periods of time.
14. Refer all servicing to qualified service personnel. Servicing is required when the apparatus has been damaged in any way, such as power-supply cord or plug is damaged, liquid has been spilled or objects have fallen into the apparatus, the apparatus has been exposed to rain or moisture, does not operate normally, or has been dropped.
15. Apparatus shall not be exposed to dripping or splashing and no objects filled with liquids, such as vases, shall be placed on the apparatus.

IMPORTANT FOR LASER PRODUCTS

1. CLASS 1 LASER PRODUCT

2. DANGER: Visible laser radiation when open and interlock failed or defeated. Avoid direct exposure to beam.

3. CAUTION: Do not open the top cover. There are no user serviceable parts inside the unit. Leave all servicing to qualified service personnel.



Note: Never touch the color TFT LCD screen with your hand.

Copyright Protection

This product incorporates copyright protection technology that is protected by U.S. patents and other intellectual property rights. Use of this copyright protection technology must be authorized by Macrovision, and is intended for home and other limited viewing uses only unless otherwise authorized by Macrovision. Reverse engineering or disassembly is prohibited.

Product Features

This product is designed with movable Disc Tray. The Disc Tray can be installed in two different positions. The movable Disc Tray offers you the flexibility to choose which direction to insert your DVD in order to maximize your space. The unit incorporates high-resolution LCD display, DVD player and TV receiver in one system.

Multiple Mode

TV mode

AV1 (Composite 1)

AV2 (Composite 2)

AV3 (Component 1)

AV4 (Component 2)

VGA

HDMI

DVD

High Quality Features

Movable Disc Tray

The unit is designed with a movable Disc Tray. The tray can be installed in two different positions; on top or on bottom of the LCD. The movable Disc Tray offers you the flexibility to choose which direction to insert your DVD in order to maximize your space.

TV Signal Input

Supports ATSC and NTSC signals so you can receive more TV programs.

TV Function

Auto program scan and manual program searching, provide you more convenience.

Channel Edit Function

Supports channel edit function, you can edit the channel for your preference.

Special Function

Supports V-CHIP, CCD and sleep timer setting functions.

USB and CARD PORTS

Designed with USB and SD/MS/MMC card port, can be connected to USB device or SD/MS/MMC Card.

High Resolution

Adopt an MPEG2 decoding format to achieve horizontal resolution more than 500 lines.

Superior sound

Supports SRS and SAP function, reproduce high quality sound.

LCD (Liquid Crystal Display)

Designed with 27" plasma display that clearly shows your picture.

Stereo amplifier

Built-in 2x10w speakers provide high quality sound.

AV And VGA Input

Can be connected to external audio and video signal source and PC.

Color Separation Function

Built-in 3D Y/C chroma chip to separates luma and chroma effectively.

Multi-audio and Multi-video modes

Supports Multi-audio and multi-video modes, provide more selections.

Advanced Playing Features

Compatibility

DVD, CD, CD-R, CD-RW and JPEG discs compatible.

All Playback Functions



Fast forward and reverse, slow playback and repeat playback.

Special playback.

Support multi-angle, multi-language and multi-subtitle playback.

Disc Information

Discs Formats Supported By This Player

	DISC LOGO	CONTENTS	SIZE	MAXIMUM TIME
DVD		Audio+Video (active picture)	12cm	133min(SS-SL)
				242min(SS-DL)
				266min(DS-SL)
				484min(DS-DL)
CD		Audio	12cm	74min
JPEG		Still high resolution	12cm	

- The operating method of some DVD discs is specified by the software maker. Please refer to the instruction manual of the disc.
- The DVD Player will play most recordable (CD-R) or erasable (CD-RW) CDs, but playback of CD-R or CD-RW discs created on a computer requires proper formatting and finalization of the disc for audio playback. Some computers and/or software programs may not be capable of creating compatible discs.

About Disc Terms

Title

Generally, pictures or music compressed on a DVD are divided into several sections, "title".

Chapter

The smaller section unit of picture or music in a DVD under the title, usually one title is comprised of one or more chapters and each of them is numbered for easy searching. But some discs may not have a recording chapter.

Track

A segment of picture or music on a CD. Each track is numbered for searching.

Front Panel

Front and Right View



1. Disc Tray Slot

Insert disc into this slot.

2. SD/MS/MMC card port

Insert SD/MS/MMC card into this slot.

3. USB Port

Connecting to the USB device.

4. 27" Color TFT screen

27" color TFT screen clearly shows your picture.

5. SOURCE button

Press to enter the Input menu and then use the ▲ ▼ buttons to select mode: TV, AV1 (Composite1), AV2 (Composite2), AV3 (Component1), AV4 (Component2), VGA, HDMI, then press the Enter button to enter the selected mode.

6. MENU button

Press to enter or exit system setup menu.

Front Panel (Continued)

7. CH ▲/▼ button

In TV mode, press to select channels.

In setup menu, the same function as ▲/▼ direction buttons.

8. VOL ▲/▼ button

Press to decrease or increase the volume, the same function as ◀/▶ direction buttons in setup menu.

9. ■ STOP button

Press to stop playback in DVD mode.

10. ▶ PLAY button

Press to start playback in DVD mode.

11. EJECT button

Press to eject the disc out from the disc tray.

12. POWER button

Press to enter or exit the standby mode.

13. Remote Sensor

Remote sensor window for the remote control.

14. Power Indicator

In standby mode, it turns red; when operation it is blue;

15. Speakers

Provides high quality sound.

Rear Panel

Rear View

Open the back cover on the right side of the unit's rear panel, all the jacks will appear, as shown on the figure below:

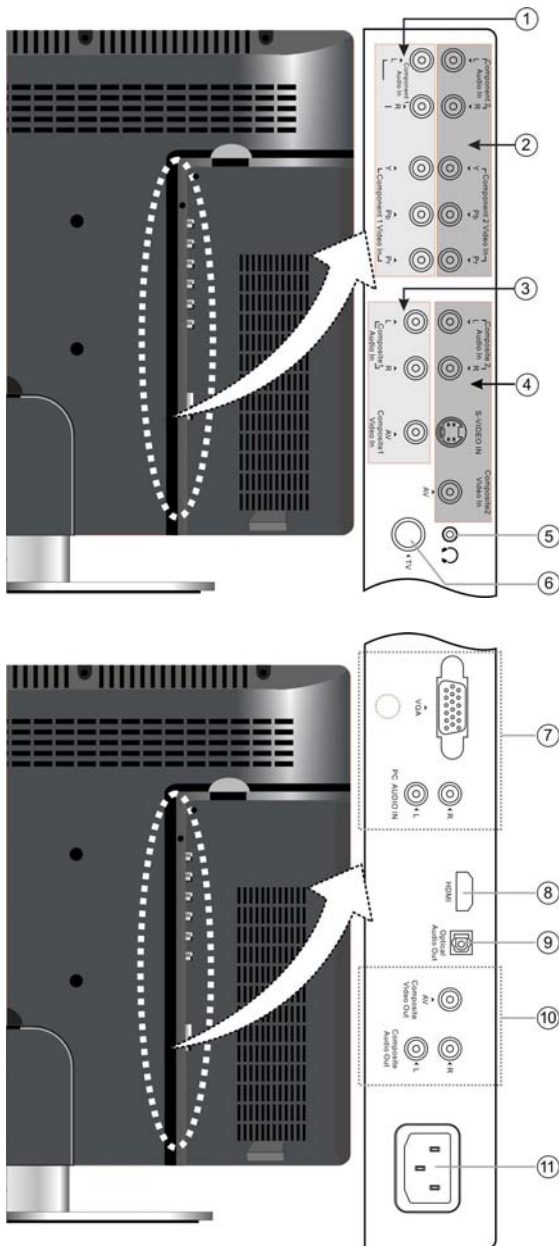

1. Y/Pr(Cr)/Pb(Cb) and L/R audio Input Jacks

Connections for the Y/Pr(Cr)/Pb(Cb) inputs in AV3 (Component) mode.

2. Y/Pr(Cr)/Pb(Cb) and L/R audio Input Jacks

Connections for the Y/Pr(Cr)/Pb(Cb) inputs in AV4 (Component) mode.

3. Video and L/R audio Input Jacks

Connections for the audio and video signal input in AV1 (Composite) mode.

4. Video/S-VIDEO and L/R audio Input Jacks

Connections for the audio and video/S-Video signal inputs in AV2 (Composite) mode. Video and S-Video use the same L/R audio jacks, with S-Video input given priority.

5. Headphone Jack

Used for connecting to a headphone.

6. TV Signal Input Jack

Connected to TV antenna in TV mode.

7. VGA Input Jack

Connect to the VGA output jack of a PC in VGA mode.

8. HDMI Jack

Connect to the HDMI.

9. OPTICAL audio output Jack

Connection for optical digital audio (SPDIF) output.

10. AV Output Jack

Connection for audio and video signal output.

11. Power In Jack

Connection for AC power.

Remote Control

Remote Control Buttons Functions

For TV Operation



1. POWER button

Press to enter or exit the standby mode.

2. 0~9 Number buttons

Press to select numbers.

3. MTS button

In TV mode, press to shift among SAP, Mono or Stereo mode.

4. VOL +/- button

Press to increase or decrease the volume.

5. MUTE button

Press to turn on or off the speaker output.

6. Input button

Press to enter the input menu, then use the ▲▼ button to select mode: TV, AV1 (Composite1), AV2 (Composite2), AV3 (Component1), AV4 (Component2), VGA,

HDMI, DVD, press the Enter button to enter the selected mode.

7. Direction buttons □▲▼◀▶□

In the setup menu, press the ▲▼ button to select the desired items, press the ◀▶ button to adjust or set.

8. Enter button

Press to confirm selection or exit the setup in the setup menu.

9. Sleep button

Press to set the sleep time.

10. TV button

Press to shift to TV mode.

11. Signal button

Press to display the ATSC signal status.

12. ◀ button

Press number buttons to select channel and then press the button to confirm and go the selected channel.

13. +10/- button

In TV mode, press the number buttons to select channel first, then press this button and add number button "0" or one number from "1~5" to select analog or digital TV program. Add "0" for analog TV program, add one number from "1~5" for digital TV program.

14. Last button

In TV mode, press to return to the channel last viewed.

15. CH ▲/▼ button

In TV mode, press to select channel.

16. Freeze button

Press to freeze the current picture.

17. Menu button

Press to enter or exit the system setup menu.

18. Exit button

Press to exit system setup menu.

19. CC button

Press to display among CC1, CC2, CC3, CC4 or CC function OFF.

20. Info. button

Press to display the current mode information on the screen.

Remote Control (Continued)

Remote Control Drawing For DVD Operation



1. ▶ Play button

Press to play the disc under DVD mode.

2. ⏸ Pause button

In DVD mode, Press to pause the playback or start step frame by frame playback.

Press the ▶ PLAY button to resume normal playback.

3. ⏮ Fast Reverse button

In DVD mode, Press to search backward.

4. ⏭ Fast Forward button

In DVD mode, Press to search forward.

5. 0~9 Number buttons

Press to select numbers.

6. Direction buttons ◻▲▼◀▶◻

In the setup menu, press the ▲▼button to select the desired items, press the ◀▶

button to adjust or set.

7. Enter button

Press to confirm selection or exit the setup in the setup menu.

8. Audio button

In DVD mode, press to select audio language when the DVD disc with multiple audio languages is played.

9. Angle button

In DVD mode, Press to select various camera angles (if the DVD disc contains multiple camera angles).

10. Dvdmenu button

Press to access the disc menu in DVD mode.

11. Setup button

Press to access the DVD setup menu under DVD mode.

12. ▲ Eject button

Press to eject the disc out.

13. ■ Stop button

In DVD mode, press to stop playback, then press the PLAY button to resume normal playback. Press the STOP button twice repeatedly to stop completely.

14. ⏭ Next Skip button

Press to skip to the next chapter/track for some discs under DVD mode.

15. ⏮ Previous Skip button

Press once to skip to the beginning of the current chapter/track.

Press twice repeatedly to skip to the previous chapter/track for some discs under DVD mode.

16. +10/- button

Press the button and 0~9 number buttons to select number greater than 9.

17. Card button

In DVD mode, press to shift to USB or CARD mode when there is the input source..

18. Title button

In DVD mode, during a DVD disc playback, press to go to title menu if the disc contains.

19. Subtitle button

In DVD mode, press to select different subtitle languages during a multiple language DVD disc playback.

20. Repeat button

In DVD mode, press to repeat a chapter, track, title, or all content.

Remote Control(Continued)

Preparation of Remote Control

Softly push the back cover plastic latch to open the battery compartment.

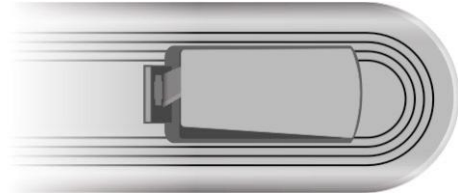

Insert two batteries (1.5V, size AAA), please make sure the polarity matches the marks inside the compartment.



Softly press the back cover to close it.

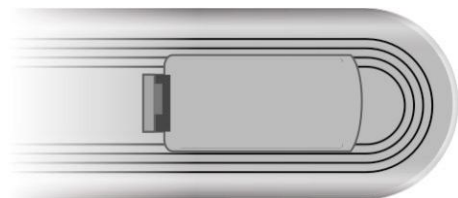

- Under normal use the battery will last for six months.
- Remove batteries when the remote is not going to be used for a long time.

Using Remote control

Point the remote control from no more than about 20 feet (7m) from the remote control sensor and at an angle of 60 degrees from the front of the unit.



The operating distance may vary depending on the brightness of the location.

Notes:

- Do not point bright lights directly at the remote control sensor.
- Do not place objects between the remote control unit and the remote control sensor.
- Do not use this remote control unit while simultaneously operating the remote control unit of any other equipment.

Special Features of the DVD Module

Note: before removing or installing the DVD module, unplug the unit from the AC power source.

The supports to install the extended functional modules are located in two different positions (above and to the side) and supports the installation of two functional modules at the same time. Please follow the below steps to remove or install a function module.

Remove the DVD module:

Refer to the below figure and follow the steps to remove the DVD module from the unit:

Step 1: Open the back cover on the left rear panel of the unit.

Step 2: Remove the DVD module.

1. Loosen the screws on the DVD module.
2. Unplug the MGI connecting cord from the LCD TV.
3. Remove the DVD module.

Step 3: Close the back cover.



Installing the DVD module:

There are two different positions for installing the functional module, and two MGI jacks for connecting the MGI connecting cord. Select the preferred position for installation:

1. Plug one end of the MGI connecting cord into the DVD module.
2. Open the back cover on the left rear panel of the unit.
3. Insert the functioning module and secure with one screw.
4. Plug the other end of the MGI connecting cord into the MGI jack on the unit.
5. Close the back cover.

System Connections

Do not connect the power cord until all other connections have been made.

Ensure that you observe the color cables when connecting audio and video cables.

Before connecting, open the cover on the right side of the unit's rear panel.

Connecting To External AV Signal Source (AV1)

Use the audio and video cable to connect the input jacks on the right side of the unit's rear panel to the external AV signal source.

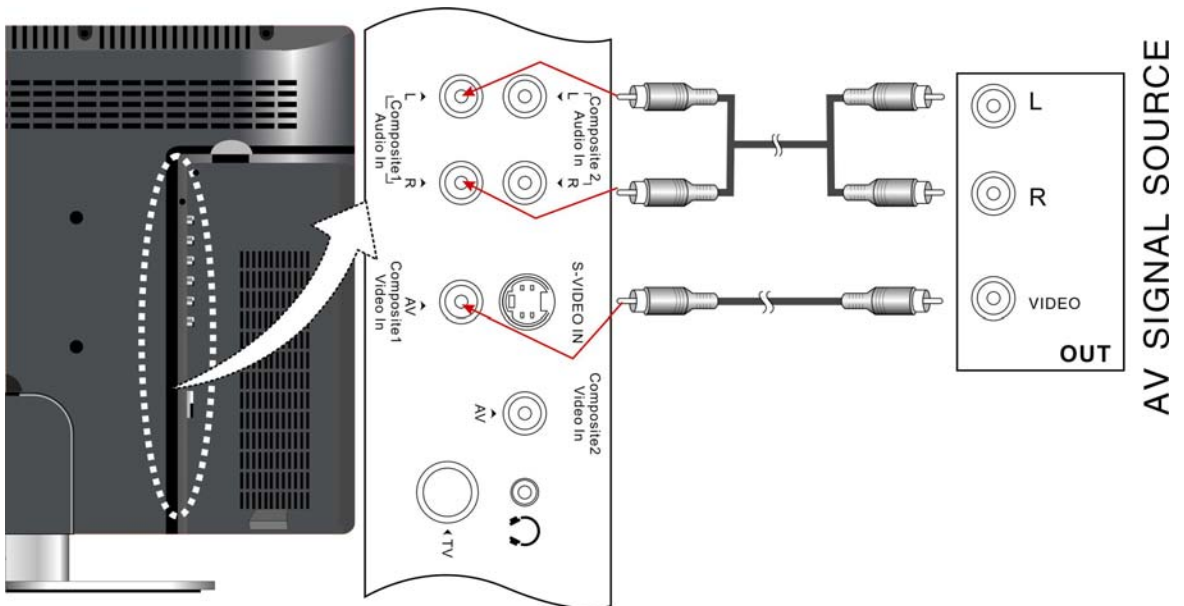

After connecting, turn on the power of the unit and the external AV signal source, press the **Input** button to invoke the Input menu, then select AV1 (Composite) and press the **Enter** button to activate the selected mode.

System Connections

Connecting To External AV Signal Source (AV2)

Use the audio and video cable to connect the input jacks on the right side of the unit's rear panel to the external AV signal source.

Also use the S-Video cable to connect the S-Video input jack on the right side of the unit's rear panel to the external AV signal source.

Note: S-VIDEO cable will produces higher quality images.

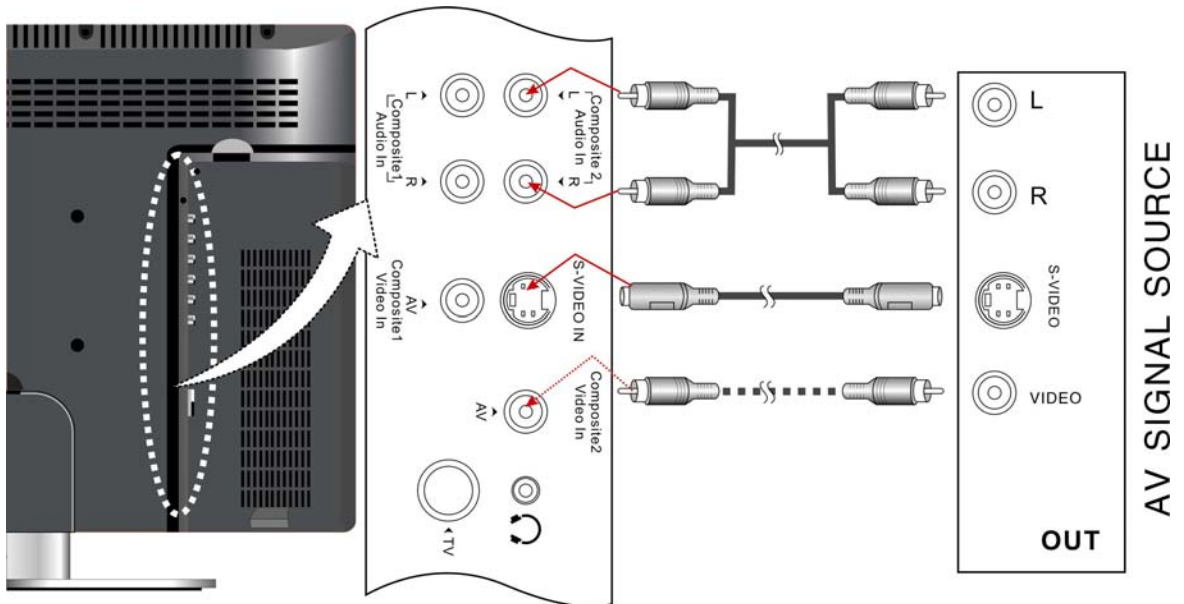

After connecting, turn on the power of the unit and the external AV signal source, press the **Input** button to invoke the Input menu, then select AV2 (Composite) and press the **Enter** button to activate the selected mode.

If connected to the two group AV and S-Video signal sources at the same time, the S-Video is the priority. If the other two AV inputs have a video signal applied at the same time a signal is present at the S-Video connector, the S-Video signal will take priority over the other two.

System Connections

Connecting to External AV Signal Source (AV3/AV4)

Use the audio and video cables to connect the Y/Pb (C b) /Pr (Cr) input Jacks on the right side of the unit's rear panel to the external AV signal source.

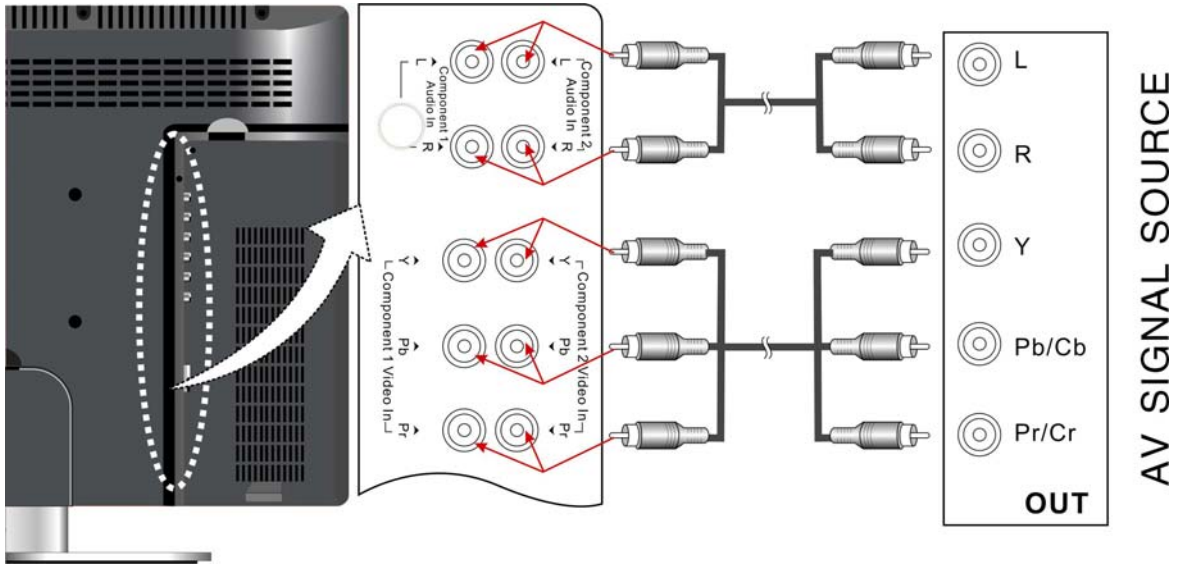

After connecting, turn on the power of the unit and the external AV signal source, press the **Input** button to activate the Input menu, then select AV3 (Component) or AV4 (Component) and press the **Enter** button to enter the selected mode.

Note: The Component cable will produce a better image quality.

System Connections

Connecting to HDMI Output Device

This unit can be connected to an AV device with HDMI output. See the below figure for details:

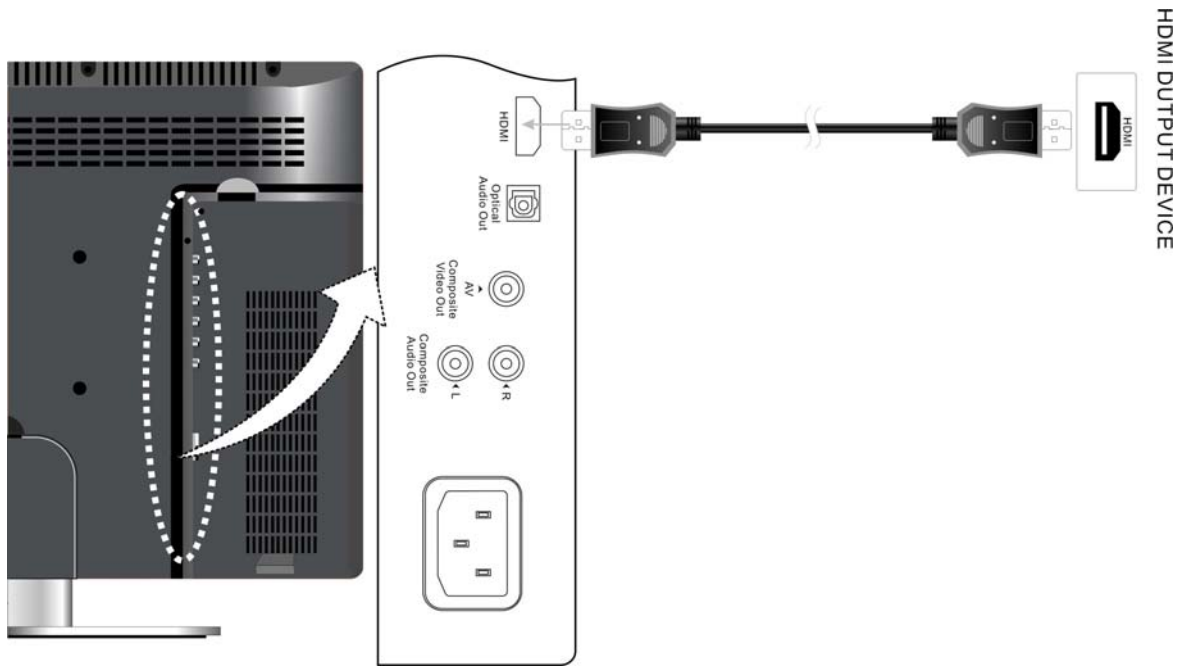

After connecting, turn on the power to the unit and the external HDMI output device, press the **Input** button to activate the Input menu, then select HDMI and press the **Enter** button to enter the HDMI mode.

System Connections

Connecting to External AV Device (AV Out)

Use the audio/video cables to connect the audio and video output Jacks on the right side of the rear panel to the external AV device.

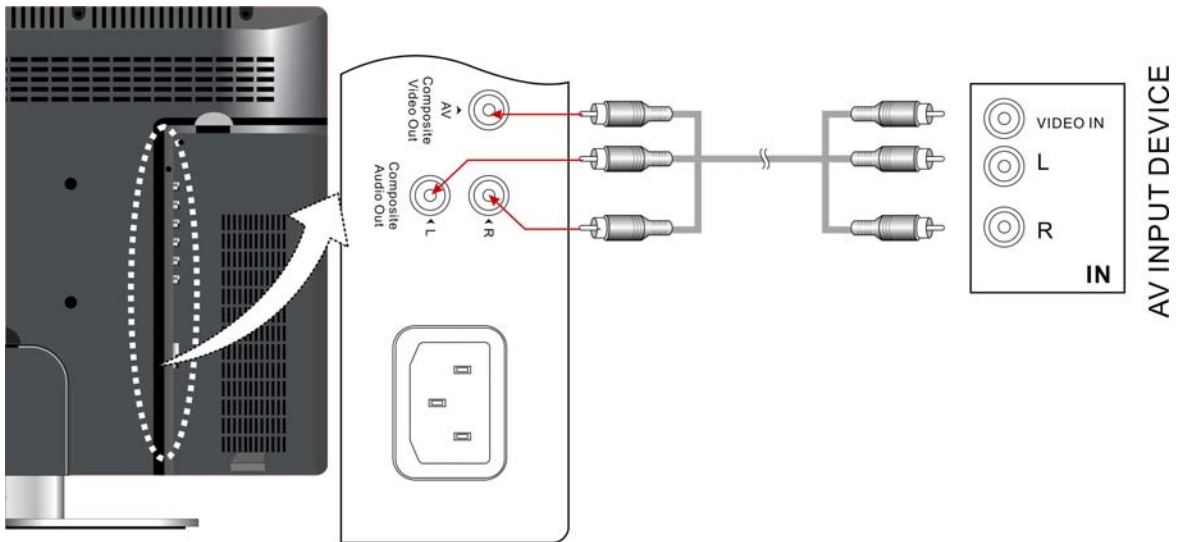

Special Notes:

The features of this A/V equipment allows you to connect to other A/V equipment. Care should be taken when connecting the A/V outputs of this device to the A/V inputs of the other device. For example, composite output of this device needs to be connected to composite inputs of the other device.

System Connections

Connecting to Digital Amplifier

The unit is equipped with an optical digital audio jack that can be connected to a digital amplifier, (see the figure below)

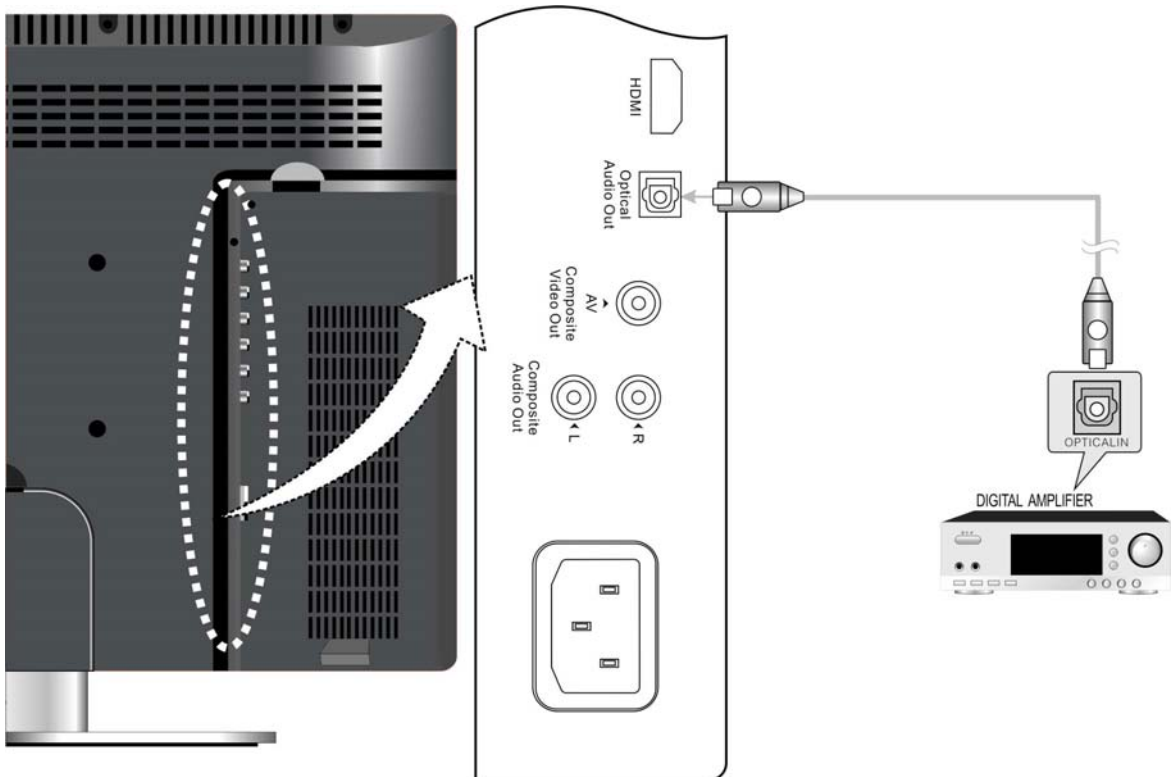

System Connections

Connecting to PC

The unit can be connected to a PC (personal computer) via a VGA cable. Follow the instructions and figure below to connect to a PC:

1. Connect one end of the VGA cable to the VGA input connector on the right side of the unit's rear panel.
2. Connect the other end to the PC VGA output connector.
3. Connect one end of the audio cable to the PC audio input jacks on the right side of the unit's rear panel.
4. Connect the other end to the PC audio output jack.
5. Set the PC's resolution at 1024×768; and the refresh frequency must be set at 60Hz.

After connecting, press the **Input** button and select VGA mode.

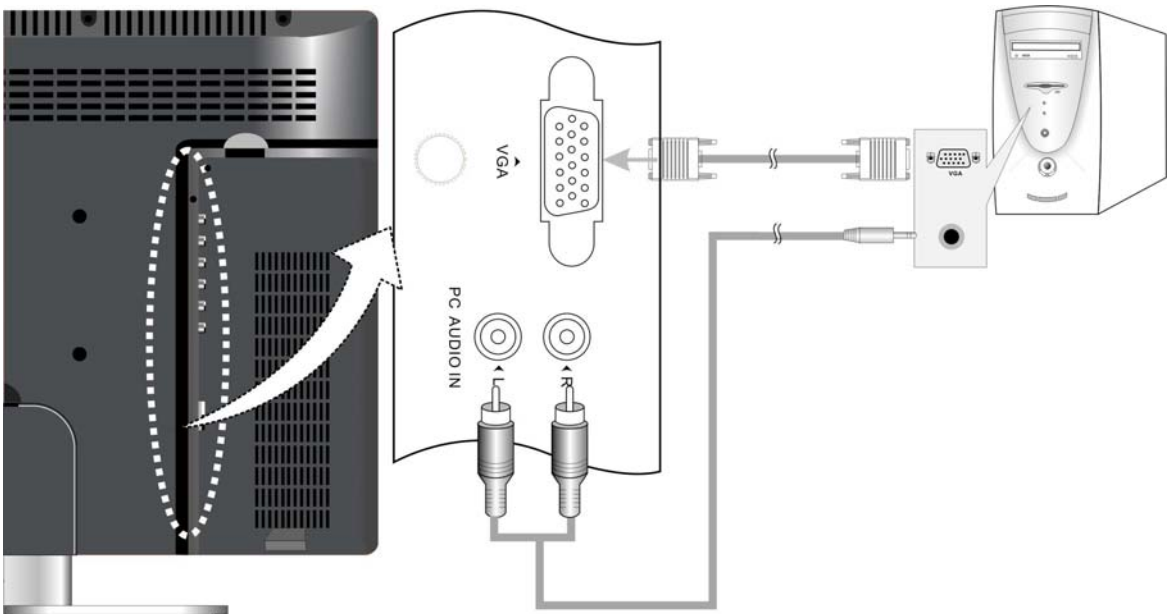

System Connections (Continued)

Connecting to TV Signal Input

This unit can be connected to a TV signal output source via the 75Ω antenna jack on the rear panel. After connecting, turn on the power to the unit, press the **Input** button and select TV mode.

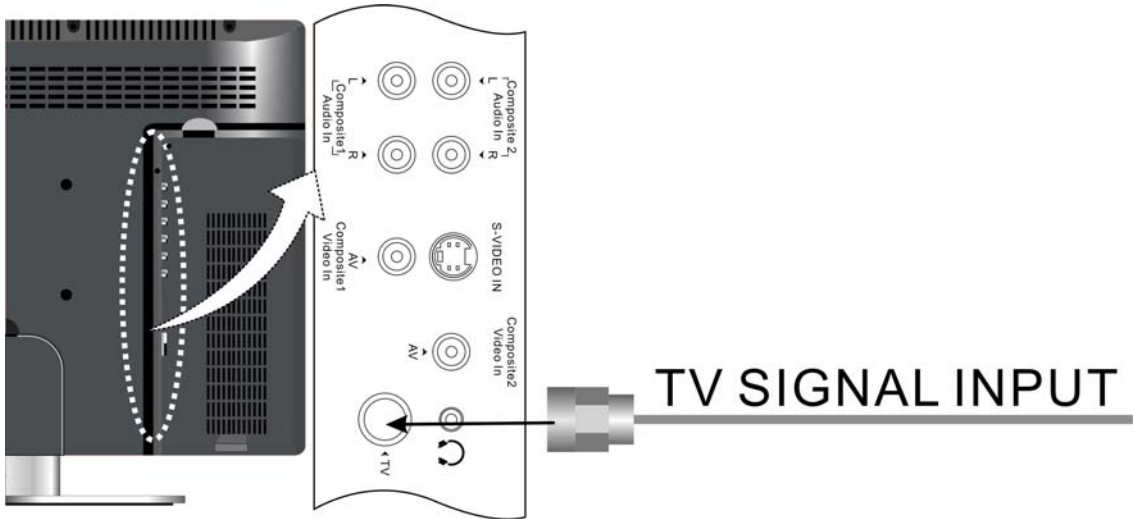

Connecting to AC Power

One end of the AC power cord gets connected to the AC power connector on the rear panel of the unit. The other end of the AC power cord gets connected to a 110 ~220V AC outlet.

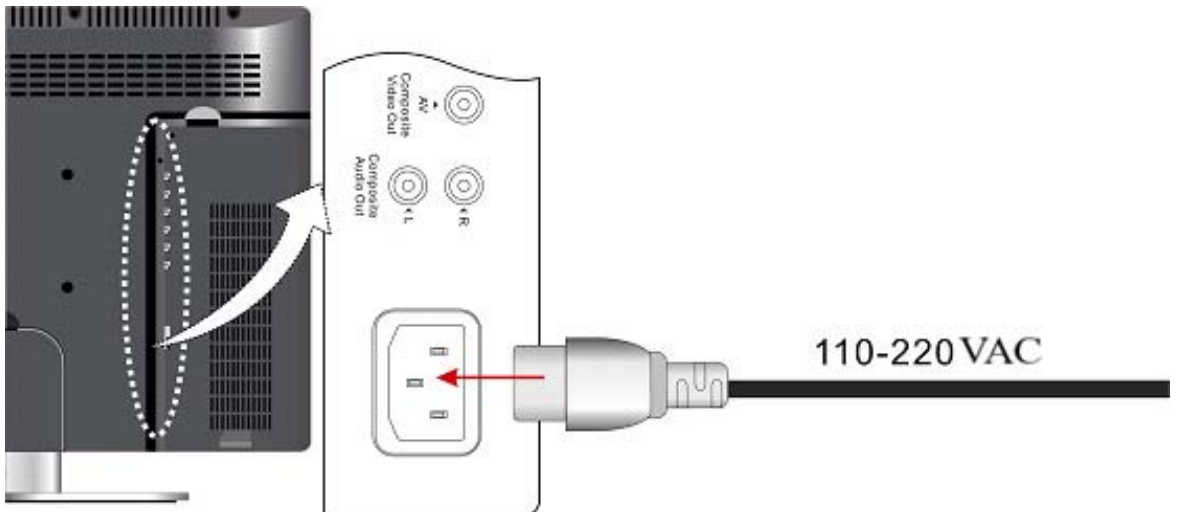

System Connections (Continued)

Connecting to Headphone

This unit can be connected to a headphone for private listening. See the below figure for details:

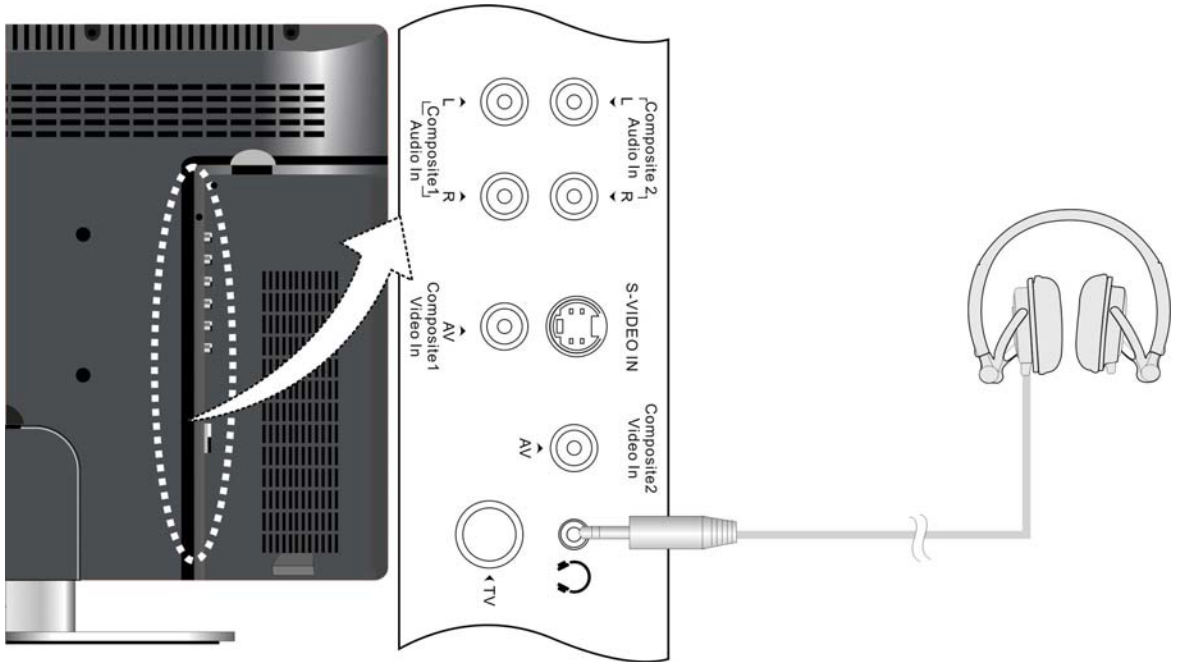

Note: Turn down the volume before connecting the headphone.

Input Source Selecting

The unit supports multiple video modes, which the user selects via the input menu. Press the **Input** button to activate the Input menu, the screen will display the following:

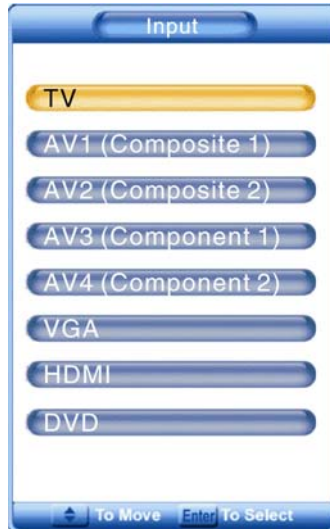

Press the ▲ ▼ direction button to select the desired video mode, followed by pressing the **Enter** button to activate the selected mode.

NOTE:

If external video signals are simultaneously connected to AV2 (composite) are S-Video, the unit will default to S- Video when the operator selects AV2 as the video input source. If the unit is equipped with DVD or PVR module, DVD or RECORDER will be displayed on the input screen for selecting.

System Setup and Operation

Preparations

1. Connect the unit to the required power, antenna and video sources then press the POWER button to turn on the unit.
2. Press the **Input** button to display the Input menu, then press the ▲ or ▼ button to select TV. Follow by pressing the **Enter** button to activate the TV mode.

Selecting a Function for Set Up

Press the **Menu** button to activate the main setup menu, as shown on the right:

Use the ▲ or ▼ button to select **Setup** then press ◀ or ▶ button to enter the setup menu. Use ▲ or ▼ button to highlight the function which will be setup. Press the ◀ or ▶ button to return to the previous menu. Press the **Exit** button to exit the setup menu.



Tuning Band

Press the ▲ or ▼ button to select the **Tuning Band** then press the **Enter** button to cycle through the available option: Air, Cable, Cable HRC, Cable IRC, Cable Auto.

DTV Signal

Press the ▲ or ▼ button to select **DTV Signal** then press the **Enter** button, the screen will display the DTV Signal status, press the **Enter** button again to return to the previous menu.

Auto Ch Search

Press the ▲ or ▼ button to select the **Auto Ch Search** then press the **Enter** button to begin the auto searching/programming, see the figure to the right :

After auto-searching/programming, the unit will exit and automatically memorizing the channels found. Upon exiting it will go to the first found channel.

During searching, press the **Exit** button to terminate the search process and exit Setup.

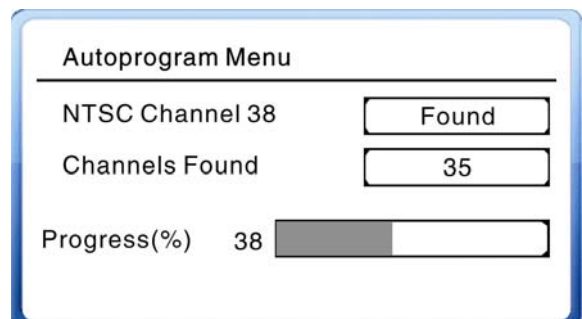

System Setup and Operation (Continued)

Manual Ch Search

Press the ▲ or ▼ button to select the **Manual Ch Search**, then press the **Enter** button to activate the Manual Channel Set Menu, refer to the figure to the right :

In the menu, press the ◀ ▶ ▲ ▼ direction buttons to select items, press the **Enter** button to confirm or set, press the **Exit** button to exit.



Channel Labels

Press the ▲ or ▼ button to select the **Channel Labels**, press the **Enter** button to enter the Channel Labels Menu, refer to the figure to the right: Press the ◀ or ▶ direction buttons to select the item you want to set. Press the ▲ or ▼ button to set the item then press the **Exit** button to exit.



Menu Language

Press the ▲ or ▼ button to select the **Menu Language** then press the **Enter** button to cycle through the available languages: English Spanish, French. Press the exit button once desired language has been selected.

Selecting a Video Parameter for Setup

Press the **Menu** button to activate the main setup menu, as shown on the right:

Press the ▲ or ▼ button to select the **Video**, then press the ◀ or ▶ button to enter the setup menu. Press the ▲ or ▼ button to select the video parameter for setting. Press the ◀ or ▶ button again to return to the previous menu. Press the **Exit** button to exit the setup menu.

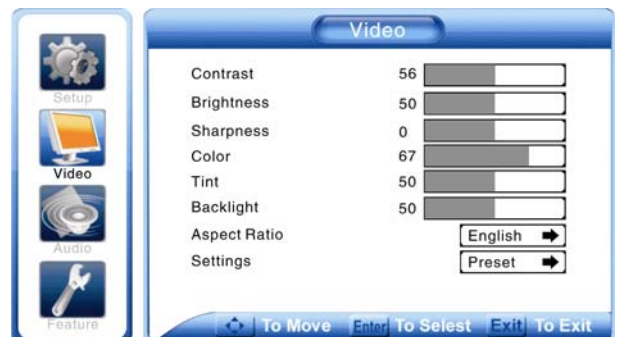

Contrast

Press the ▲ or ▼ button to select the **Contrast** then press the **Enter** button to activate the adjustment mode. Press the ◀ or ▶ button to adjust the contrast to the desired setting. Press the **Enter** button to confirm and return.



System Setup and Operation (Continued)

Brightness

Press the ▲ or ▼ button to select the **Brightness** then press the **Enter** button to activate the adjustment mode. Press the ◀ or ▶ button to adjust the brightness. Press the **Enter** button to confirm and return.



Sharpness

Press the ▲ or ▼ button to select the **Sharpness** then press the **Enter** button to activate the adjustment mode. Press the ◀ or ▶ button to adjust the sharpness. Press the **Enter** button to confirm and return.

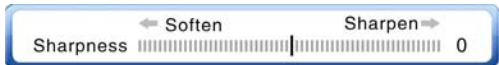

Color

Press the ▲ or ▼ button to select the **Color** then press the **Enter** button to activate the adjustment mode. Press the ◀ or ▶ button to adjust the color. Press the **Enter** button to confirm and return.



Tint

Press the ▲ or ▼ button to select the **Tint** then press the **Enter** button to activate the adjustment mode. Press the ◀ or ▶ button to adjust the tint. Press the **Enter** button to confirm and return.



Backlight

Press the ▲ or ▼ button to select the **Backlight** then press the **Enter** button to activate the adjustment mode. Press the ◀ or ▶ button to adjust the backlight. Press the **Enter** button to confirm and return.



Aspect Ratio

Press the ▲ or ▼ button to select **Aspect Ratio** then press the **Enter** button to cycle through the available options: Normal, Zoom, Wide and Cinema. Once the desired setting is selected press the ◀ or ▶ to return to the setup menu.

Settings

Press the ▲ or ▼ button to select **Settings**, press the **Enter** button to set all the settings on the setup page to their factory default settings.

System Setup and Operation (Continued)

Selecting an Audio Parameter for Setup

Press the **Menu** button to activate the main setup menu, as shown on the right:

Press the **▲** or **▼** button to select the **Audio** then press the **◀** or **▶** button to enter the setup menu. Press the **▲** or **▼** button to select one of the Audio parameters for setting. Press the **◀** or **▶** button again to return to the previous menu. Press the **Exit** button to exit the setup menu.



Audio Language

Press the **▲** or **▼** button to select **Audio Language** then press the **Enter** button to select the desired audio language.

TRUBASS

Press the **▲** or **▼** button to select **TRUBASS** then press the **Enter** button to activate the adjusting mode. Press the **◀** or **▶** button to adjust the value. Press the **Enter** button again to confirm and return.



Digital Audio Output

Press the **▲** or **▼** button to select the **Digital Audio Output** then press the **Enter** button to select RAW or PCM. Once the desired setting is selected press **◀** or **▶** to exit.

TV Speaker

Press the **▲** or **▼** button to select **TV Speaker** then press the **Enter** button to select On or Off. Once the desired setting is selected press **◀** or **▶** to exit.

Mode

Press the **▲** or **▼** button to select **Mode**, press the **Enter** button to cycle through the available options: TRUBASS , BYPASS, WOW, TSXT. Once the desired setting is selected press **◀** or **▶** to exit.

Settings

Press the **▲** or **▼** button to select **Settings** then press the **Enter** button to have the unit restore all the factory settings for the current parameters shown on the screen.

System Setup and Operation (Continued)

Selecting a Feature for Setup

Press the **Menu** button to activate the main setup menu, as shown on the right:

Press the **▲** or **▼** button to select the **Feature** then press the **◀** or **▶** button to enter the setup menu. Press the **▲** or **▼** button to select one of the features for setting. Press the **◀** or **▶** button again to return to the previous menu. Press the **Exit** button to exit the setup menu.



Time Set

Press the **▲** or **▼** button to select **Time Set** then press the **Enter** button to activate the Time Set Menu, as shown on the right: In the menu, press the **▲** or **▼** direction buttons to select items, press the **Exit** button to exit.

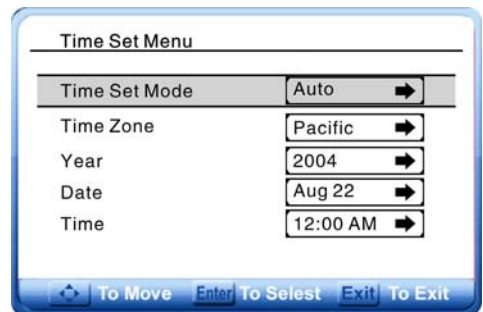

Time Set Mode

Press the **▲** or **▼** button to select the **Time Set Mode** then press the **Enter** button to cycle between Auto or Manual. Select Manual if you intend to manually set the other parameters. Once the desired mode is selected press exit to exit.

Time Zone

Press **▲** or **▼** button to select the **Time Zone** then, press the **Enter** button to cycle through the available options: EASTERN CENTRAL MOUNTAIN, PACIFIC, ALASKA, HAWAII. Once the desired zone is selected press exit to exit.

Year

Press **▲** or **▼** button to select the **Year** then press **◀** or **▶** button to set the year. Once the desired year is set press exit to exit.

Date

Press **▲** or **▼** button to select the **Date** then press **◀** or **▶** button to set the date. Once the desired date is set press exit to exit.

Time

Press **▲** or **▼** button to select the **Time** then press the **◀** or **▶** button to set the time. Once the desired time is set press exit to exit.

Sleep Timer

Press **▲** or **▼** button to select the **Sleep Timer** then press the **Enter** to cycle through the available sleep time settings. Once the desired time is selected press **◀** or **▶** button to exit.

System Setup and Operation (Continued)

Selecting an Advanced Video Menu Item for Setup

Press the ▲ or ▼ button to select **Advanced Video Menu** then, press the **Enter** button to activate the Advanced Video Menu Setup Screen. See the figure to the right. Press the ▲ or ▼ direction buttons to select items then press the **Enter** button to cycle through the available settings. Once the desired setting is selected, press the **Exit** button to exit.

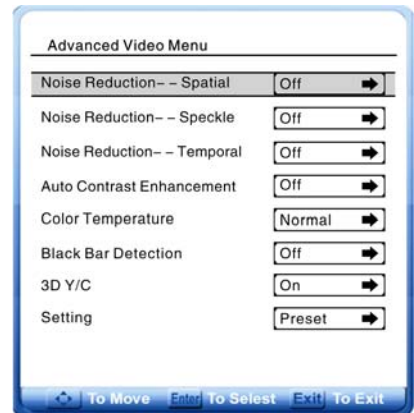

Password Set

Press the ▲ or ▼ button to select **Password Set** then press the **Enter** button. See the figure to the right:

Use the number buttons to input the password. the original password is 0000. Follow the system prompts and enter the information requested. Upon successful completion the system will display **PASSWORD CHANGED**.

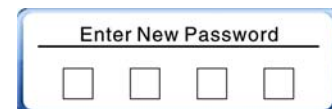
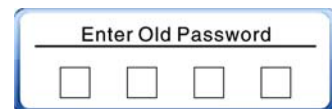

Parental Control

The Parental Control setting is a feature that provides parents with the capability of selecting what the acceptable program content will be. Depending on the setting, you can edit violence, language and explicit content.

Press the ▲ or ▼ button to select **Parental Control** then press the **Enter** button.

Use the number buttons on the remote control to input the password, the default password is 0000.

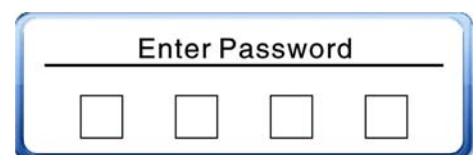

System Setup and Operation (Continued)

Parental Control Menu

When the correct password is inputted, the parental control menu will be displayed on the screen, see the below figure:

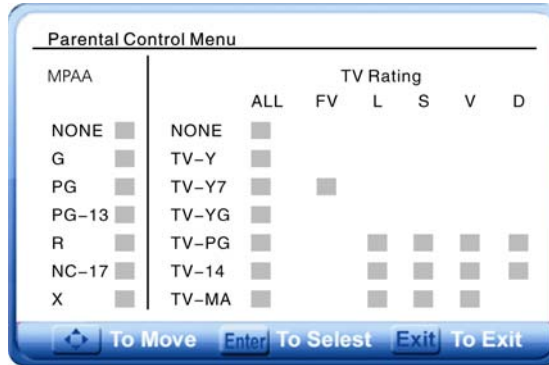

Fantasy violence [FV], adult languages [L], sexual situations [S], violent scenes [V] and suggestive dialogues [D]

In the parental control menu, press the ◀ ▶ ▲ ▼ direction buttons to position the blue box at the desired MPAA or TV rating then press the **Enter** button to set the rating. Press the **Exit** button to exit the setup menu.

Closed Caption Options

Press the ▲ or ▼ button to select the **Closed Caption Options** then press the **Enter** button, see the figure to the right. Press the ▲ or ▼ direction buttons to select an items then press the **Enter** button to cycle through the allowable settings. Once the desired setting is visible, press the **Exit** button to exit. You can see a sample of the change at the bottom of the menu.

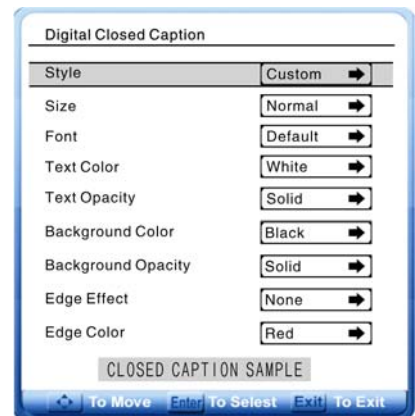

In the AV1, AV2, AV3, AV4, VGA, HDMI mode, you can refer to the setups in the TV mode to set the items.

DVD Player Operation

Disc Loading Steps:

1. Press the POWER button to turn on the power. Press the **Input** button and select DVD mode, press the **Enter** button to select DVD mode.
2. Insert the disc with its printed side facing you into the disc tray. (Refer to the figure below.)
3. Disc will automatically be pulled into the disc player. While the disc is loading, "Loading" will appear on the liquid crystal display and playback will begin.



Warning: Do not play poor quality discs that may damage the player.

DVD Playback

Region Code

DVD players and discs are coded by region. These regional codes must match the played discs. If the codes don't match, the disc cannot be played. This player's default code is region 1.

Play

Press the **▶ Play** button to start playback. Press the STOP button once on the remote control to stop playback, and press the **▶ Play** button again to resume playback.

Stop

Press the **■ Stop** button once to stop playback and then press **▶ Play** button to resume. Press this button twice to stop playback completely.

DVD Player Operation (Continued)

Pause ⏸

Press the ⏸ **Pause** button once to pause the playback, press it repeatedly to start step-by-step playback, press the ▶ **Play** button to resume normal playback.

Previous ⏮ **and Next** ⏭

Press the ⏭ button to go to the next chapter. Press the ⏮ button once to return to the beginning of the current chapter, press it twice to go to the previous chapter.

Fast Playback

Press the ⏩ or ⏪ button on the remote control to activate fast forward or backward playback.

Repeat

Press the REPEAT button repeatedly to cycle through the various repeat modes (Chapter, Title or All).

DVD Menu

DVD disc contain a selection menu, to access this menu, press the red **MENU** button. Use the direction buttons to highlight an item, then press the ENTER button to confirm.

Title & Chapter

DVD discs normally contain multiple titles and multiple chapters (sections) in a title. You can select any title or chapter quickly by entering the relevant number.

Language (Audio)

There can be up to 8 audio languages on a DVD disc. When you play a multi-language DVD disc you can press the **Audio** button to select different audio languages.

Subtitle

The DVD player can support multiple kinds of subtitles. When you play a multi-subtitle disc you can press the **Subtitle** button to select different subtitle languages.

Various Camera Angles

The movies on some DVDs have been recorded from various camera positions. This lets you enjoy the same scene from different perspectives. In this case you'll usually find a marking on the DVD sleeve.

When playing a DVD containing various camera angles the camera symbol appears on the screen. Press the **Angle** button repeatedly until the desired perspective is shown. The picture will adjust in 1 or 2 seconds.

DVD Player Operation (Continued)

CD Playback

The player will play all tracks on a CD disc by default. You can use the ⏮ and ⏭ (PREV/NEXT skip) buttons, or number buttons to select a specific track.

Stop ■

Press the ■ **Stop** button once to stop playback and then press ▶ **Play** button to resume. Press this button twice to stop playback completely.

Pause ⏸

Press the ⏸ **Pause** button to pause the playback and then press the ▶ **Play** button to resume normal playback.

Previous and Next

Press the ⏮ button once to go the beginning of the track. Press twice to go the previous track.

Press the ⏭ button to play from the beginning of the next track.

Fast Playback

Press the ⏩ or ⏪ button on the remote control to activate fast forward or fast backward playback.

Repeat

Press the **Repeat** button repeatedly to select between Single, All or cancel repeat.

NOTE: Some discs do not support the repeat function.

Audio

During CD playback, press the **Audio** button on the remote control to select the audio output mode: Mono Left, Mono Right, Mix-Mono and Stereo.

DVD Player Operation (Continued)

JPEG Playback

JPEG is a common picture format that requires small amounts of storage per image and has low loss in resolution. Hundreds of pictures can be stored on a disc in this format. In order to view JPEG photo albums, you can ask your film development company to make a "PICTURE CD" when they develop your film.

Normal Playback

Insert a JPEG disc into the player and allow it to load. Upon completion of the load process the root menu will be displayed on the screen. Use the **Enter** button and the direction button to select a submenu, and then use the ▲▼ direction button to select the contents. Many discs have other contents besides pictures.

For Picture CD disc, it will display the pictures automatically.

During playback, press the ◀◀ or ▶▶ button to select picture.

NOTE: Many discs have other content besides pictures.

Stop

Press the ■ **Stop** button once to stop playback and return to the preview menu. Press the ▶ **Play** button to resume normal playback.

Pause

Press the ▶◀ **Pause** button to pause playback, press the ▶ **Play** button to resume playback.

Repeat

During playback, pressing the **Repeat** button repeatedly will result in the cycling through the repeat modes Shuffle, Random, Single, Repeat One, Repeat All and Repeat Off.

Previous and Next

During playback, press the ◀◀ or ▶▶ button to select a previous or next picture.

Menu

Press the **Dvdmenu** button once to stop playback and return to the root menu.

Picture Rotation

Use the ◀ or ▶ buttons to rotate the currently displayed picture. The rotation will remain in effect as long as the current picture is displayed.

Once another picture is selected, rotation will automatically be cancelled.

NOTE: Some JPEG disc may not support rotating function.

USB and SD/MS/MMC Card Function

USB and SD/MS/MMC Card Function

Preparation:

1. Press POWER to turn on the unit.
2. Press the **Input** button and select DVD, press the **Enter** button to shift to DVD mode.
3. Insert the USB memory stick into the unit's USB slot, or insert the SD/MS/MMC card into the SD/MS/MMC card slot on the right side of the unit. Please see the below figure:



- Make sure that files are stored on the USB and the SD/MS/MMC card before the installation.
4. Press the **Card** button to cycle among disc playback, USB playback or SD/MMC, MS playback. The default state is disk playback. Please see the below figure:

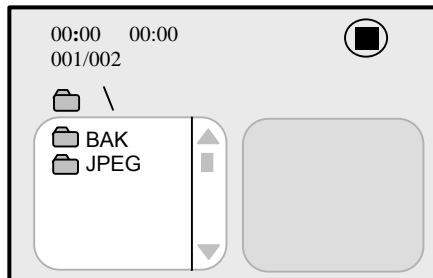

5. Press the ◀ or ▶ button to select the folder, and press **Enter** button to enter.
6. Press the ◀ or ▶ buttons to select the desired track. Then press **Play ▶** button to start playback.
7. Press the **Stop ■** button to stop playback: if the **Stop ■** button is pressed, the playback will start from the beginning of the current track. Press the ◀ button to return to the folder menu.

Note:

1. The screen display will vary from disc to disc.
2. Pull out the USB or SD/MS/MMC card directly after the files are played. Then the unit will be in the state of disc playback again.

DVD System Setup

Preparations

1. Press the **Input** button and select DVD, press the **Enter** button to activate DVD mode.
2. Press the **Setup** button on the remote control to display the settings menu. The menu includes General setup, Audio setup, Video setup, Preference.
3. Press the ◀ ▶ direction buttons on the remote control to select a category. All the items in the category will appear on the screen.
4. Press the **Setup** button again to exit the setup.

General Setup Page

Press the **Setup** button to enter the General setup menu. The screen will display as the following:

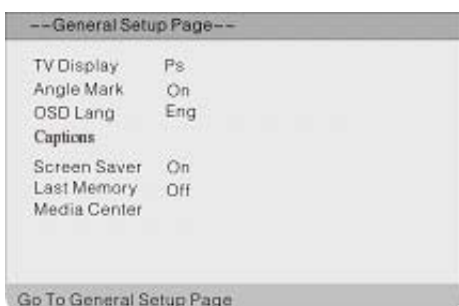

In the menu, Use the ▲ ▼ direction buttons to select the desired item. Press the **Enter** button to enter the item. Press the ◀ button to return.

TV Display



1. Press the ▲ or ▼ direction buttons to select **TV Display**.
2. Press the **Enter** button to enter the setup.
3. Use the ▲ or ▼ direction buttons to select a item.
4. Press the **Enter** button to confirm selection and return.

Angle Mark



1. Press the ▲ or ▼ direction buttons to select **Angle Mark**.
2. Press the **Enter** button to enter the setup.
3. Use the ▲ or ▼ direction buttons to select On or Off.
4. Press the **Enter** button to confirm selection and return.

DVD System Setup (Continued)

OSD Lang



1. Press the ▲ or ▼ direction buttons to select **OSD Lang**.
2. Press the **Enter** button to enter the setup.
3. Use the ▲ or ▼ direction buttons to select a language.
4. Press the **Enter** button again to confirm selection and return.

Captions



1. Press the ▲ or ▼ direction buttons to select **Caption**.
2. Press the **Enter** button to enter the setup.
3. Use the ▲ or ▼ direction buttons to select on or off.
4. Press the **Enter** button again to confirm selection and return.

Screen Saver



1. Press the ▲ or ▼ direction buttons to select **Screen Saver**.
2. Press the **Enter** button to enter the setup.
3. Use the ▲ or ▼ direction buttons to select On or Off.
4. Press the **Enter** button again to confirm selection and to return.

Last Memory



1. Press the ▲ or ▼ direction buttons to select **Last Memory**.
2. Press the **Enter** button to enter the setup.
3. Use the ▲ or ▼ direction buttons to select On or Off.
4. Press the **Enter** button again to confirm selection and return.

DVD System Setup (Continued)

Media Center



1. Press the ▲ or ▼ direction buttons to select **Media Center**.
2. Press the **Enter** button to enter the setup.
3. Use the ▲ or ▼ direction buttons to select DVD, USB, SD/MMC or MS.
4. Press the **Enter** button again to confirm selection and return.

Audio Setup Page

Press the **Setup** button to enter the General setup menu, then use the ◀ or ▶ direction buttons to select Audio Setup Page, the screen will display as the following:

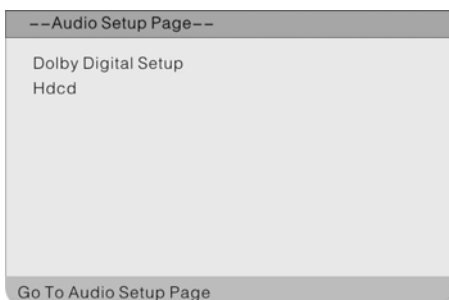

Use the ▼ direction button to select the desired item for setup. Press the ENTER button to enter the setup mode for the selected item. Press the ◀ button to return.

Dolby Digital Setup

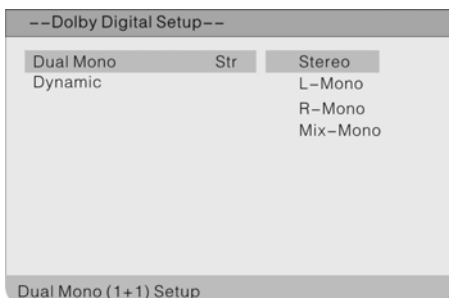

1. Press the ▲ or ▼ direction buttons to select **Dolby Digital Setup**.
2. Press the **Enter** button twice to enter setup, the screen will display as shown in the figure to the left:
3. Use the ▲ or ▼ direction buttons to select items.
4. Press the **Enter** button to enter the setup. Press the ◀ button to return.

Dual Mono

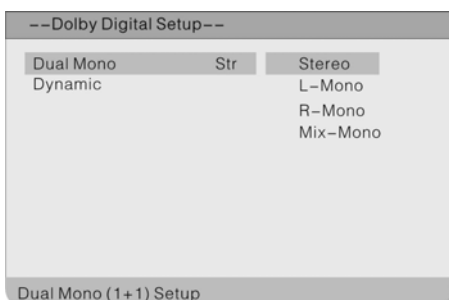

1. Press the ▲ or ▼ direction buttons to select **Dual Mono**.
2. Press the **Enter** button to enter the setup.
3. Use the ▲ or ▼ direction buttons to select an item.
4. Press the **Enter** button to confirm selection and return.

DVD System Setup (Continued)

Dynamic

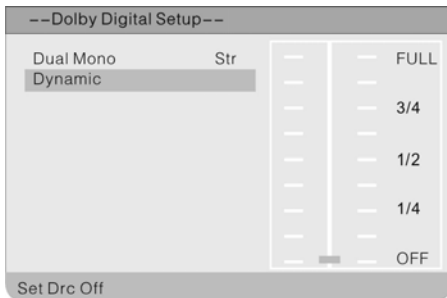

1. Press the ▲ or ▼ direction buttons to select **Dynamic**.
2. Press the **Enter** button to enter the setup, the screen will display as shown on the left:
3. Use the ▲ or ▼ direction buttons to adjust.
4. Press the **Enter** button again to confirm setting and return.
5. Press the ◀ button to return.

Hdcd Setup

In the Audio Setup Page, use the ▲ or ▼ direction buttons to select **Hdcd Setup**, press the **Enter** button to enter the setup mode, the screen shown will be displayed;

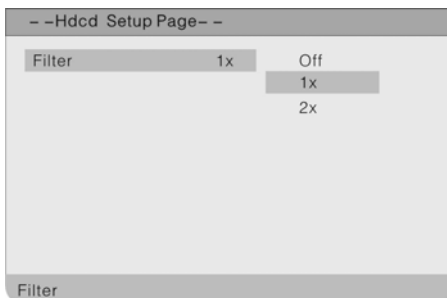

1. Press the **Enter** button to enter the setup.
2. Use the ▲ or ▼ direction buttons to select an item.
3. Press the **Enter** button again to confirm selection and return.
4. Press the ◀ button to exit

Video Setup

Press the **Setup** button to enter the General setup menu, then use the ◀ or ▶ direction buttons to select Video Setup Page, the screen will display as shown below:

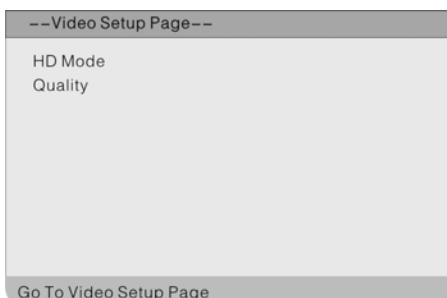

Use the ▲ or ▼ direction buttons to select the desired item. Press the **Enter** button to enter the setup mode for the desired item. Press the ◀ button to return.

DVD System Setup (Continued)

HD Mode

Use the ▲ or ▼ direction buttons to select **HD Mode**, press the **Enter** button to enter the menu. The following screen will be displayed:

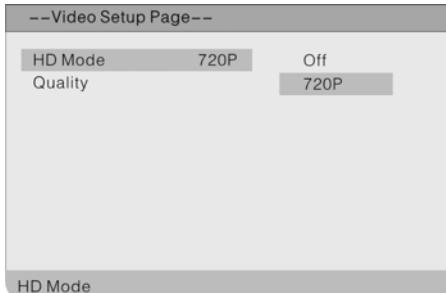

1. Press the **Enter** button to enter the setup.
2. Use the ▲ or ▼ direction buttons to select items.
3. Press the **Enter** button again to confirm selection and return.
4. Press the ◀ button to exit.

Video Quality Setup

Select **Quality** then press the **Enter** button to enter the setup mode. The screen shown below will be displayed:

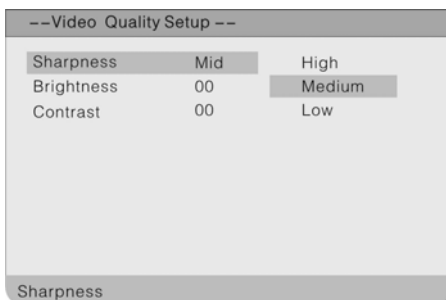

1. Use the ▲ or ▼ direction button to select the desired item.
2. Press the **Enter** button to select the item for setup.
3. Press the ◀ button to return.

Sharpness

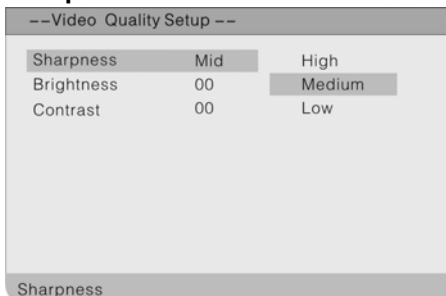

1. Press the ▲ or ▼ direction buttons to select **Sharpness**.
2. Press the **Enter** button to enter the setup mode.
3. Use the ▲ or ▼ direction buttons to select High, Medium or Low.
4. Press the **Enter** button to confirm selection and return.

Brightness



1. Press the ▲ or ▼ direction buttons to select **Brightness**.
2. Press the **Enter** button to enter the setup mode, the screen will display as shown on the left:
3. Use the ◀ or ▶ direction buttons to adjust the level.
4. Press the **Enter** button to confirm setting and return.

DVD System Setup (Continued)

Contrast



1. Press the ▲ or ▼ direction buttons to select **Contrast**.
2. Press the **Enter** button to enter the setup mode, the screen will display as shown on the left:
3. Use the ◀ or ▶ direction buttons to adjust the level.
4. Press the **Enter** button to confirm setting and return.

Preference Setup

Press the **Setup** button to enter the General setup menu, then use the ◀ or ▶ direction buttons to select Preference Page, the screen will display as shown below:



Use the ▲ or ▼ direction buttons to select the desired item for setup. Press the **Enter** button to enter the item setup mode. Press the ◀ button to return.

TV Type



1. Press the ▲ or ▼ direction buttons to select **Tv Type**.
2. Press the **Enter** button to enter the setup mode, see the figure to the left:
3. Press the ▲ or ▼ direction buttons to select TV type.
4. Press the **Enter** button again to confirm setting and return.

Audio



1. Press the ▲ or ▼ direction buttons to select **Audio**.
2. Press the **Enter** button to enter the setup mode, see the figure to the left:
3. Press the ▲ or ▼ direction buttons to select audio language.
4. Press the **Enter** button again to confirm setting and return.

DVD System Setup (Continued)

Subtitle



1. Press the ▲ or ▼ direction buttons to select **Subtitle**.
2. Press the **Enter** button to enter the setup mode, see the left figure:
3. Press the ▲ or ▼ direction buttons to select Subtitle language.
4. Press the **Enter** button again to confirm setting and return.

Disc Menu



1. Press the ▲ or ▼ direction buttons to select **Disc Menu**.
2. Press the **Enter** button to enter the setup mode, see the figure to the left:
3. Press the ▲ or ▼ direction buttons to select Menu language.
4. Press the **Enter** button again to confirm setting and return.

Parental

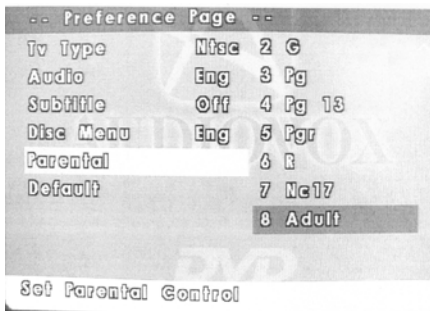

1. Press the ▲ or ▼ direction buttons to select **Parental**
2. Press the **Enter** button to enter the setup mode, see the figure to the left:
3. Press the ▲ or ▼ direction buttons to select the rating level.
4. Press the **Enter** button again to confirm setting and return.

Default



1. Press the ▲ or ▼ direction buttons to select **Default**.
2. Press the **Enter** button twice, all the settings will return to the factory default status.

Troubleshooting

SYMPTOM	CHECK ITEM
The player does not play.	Make sure disc is loaded in. Make sure disc is loaded with label facing you. Make sure disc is not dirty or warped. Make sure the player's region code is the same as region code of DVD disc. Make sure water condensation has not occurred. If it occurs, take out disc and leave the player on for at least one hour.
There is no sound.	Make sure system connection is correct. Make sure the sound setup of DVD disc is correct. Make sure disc is not dirty or warped. Clean or replace the disc. Make sure the speakers are not muted. In the TV mode, set the correct sound mode.
LCD is no display	Make sure the unit is turned on and the connections are correct. Make sure the power adapter is correctly connected.
DVD does not continue to play or plays the same section repeatedly.	Make sure disc is not dirty or damaged.
There is no picture or picture moves up and down.	Check if the connections with the external AV signal source are correct. Correctly set the items in the picture menu. Check if the video type input signal is not corresponding to the unit. Make sure the unit is turned on and in correct video type.
The remote control does not work.	Make sure there are no obstructions between the remote control and the player. Make sure the remote control is pointing at the player. Make sure batteries are inserted and the polarity is correct. Make sure batteries are not weak.

Other Notes:

Static or other external interference may cause the player to behave abnormally. In this occurrence, unplug the power-supply cord from the outlet and plug it in again to reset the player. If the problem persists, then please disconnect the power and consult a qualified technician.

Specifications

TFT-LCD Resolution	1366x768	
TFT-LCD Screen Size	27 inches	
Laser Wavelength	780/650 nm	
Video System	NTSC	
Frequency Response	20Hz□20kHz ±2.5dB	
Audio Signal-to-noise Rate	≥85dB	
Audio distortion+noise	≤□70dB (1kHz)	
Channel Separation	≥70dB (1kHz)	
Dynamic Range	≥80dB (1kHz)	
Audio Out	Analog Audio Out	Out Level: 1.5V _{±0.2} ^{0.2} , Load: 10KΩ
Video Out	Video Out	Out Level: 1V _{P-P} ±0.1, Load: 75Ω Unbalanced Negative
Power	AC110□220V□50/60Hz	
Power Consumption	<230W	
Dimension	690mm × 555mm × 280mm□LXWXD□	
Ambient Temperature	10~45°C	
Weight	About 20 Kg	

DESIGN AND SPECIFICATIONS ARE SUBJECT TO CHANGE WITHOUT NOTICE

Manufactured under license from Dolby Laboratories.

“Dolby” and the double-D symbol are trademarks of Dolby Laboratories.

Confidential unpublished works. ©1992 -1997 Dolby Laboratories, Inc.

All rights reserved.



TruSurround XT is a trademark of SRS Labs, Inc.

TruSurroundXT technology is incorporated under license from SRS Labs, Inc.

Free Manuals Download Website

<http://myh66.com>

<http://usermanuals.us>

<http://www.somanuals.com>

<http://www.4manuals.cc>

<http://www.manual-lib.com>

<http://www.404manual.com>

<http://www.luxmanual.com>

<http://aubethermostatmanual.com>

Golf course search by state

<http://golfingnear.com>

Email search by domain

<http://emailbydomain.com>

Auto manuals search

<http://auto.somanuals.com>

TV manuals search

<http://tv.somanuals.com>