



AUDIOVOX[®]
ELECTRONICS CORP.

USER'S MANUAL

Multimedia DVD System
VE1510DV



128-8421



MP3



Safety Instructions

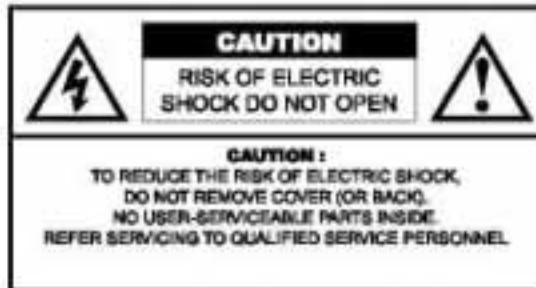

The Lightning flash with the arrowhead symbol within an equilateral triangle is intended to alert the user to the presence of uninsulated "DANGEROUS VOLTAGE" within the product's enclosure that may be of sufficient magnitude to constitute a risk or electric shock to persons.



The Exclamation point within an equilateral triangle is intended to alert the user to the presence of important operating and maintenance (servicing instructions in the literature accompanying the product).

CAUTION:

This unit employs a laser system. To ensure the proper use of the unit, read this manual carefully and keep it for future reference. To prevent direct exposure to the laser radiation, do not open the cabinet. Invisible laser radiation when the cabinet is opened or the interlocks are defeated.

DO NOT stare into the laser beams. Use of any controls, adjustments, or procedures other than those specified herein may result in hazardous radiation exposure!

**CLASS 1 LASER PRODUCT
CAUTION**

Federal Communication Commission Information

The equipment has been tested and found to comply with the limits for a TV Broadcast Receiver, pursuant to Part 15 of the FCC Rules. These limits are designed to provide reasonable protection against harmful interference in a residential installation. This equipment generates, may cause harmful interference to radio communications. If not installed equipment does cause or receive interference, which can be determined by turning equipment off and on, the user is encouraged to try to correct the interference by the following measures:

- Reorient or relocate the TV antenna.
- Increase the separation between TV and other equipment.
- Connect TV into separate outlet from other equipment.
- Consult the dealer or an experienced radio/TV technician for help.

FCC Caution: Any changes or modifications not expressly approved by the party responsible, for compliance could void the user's authority to operate this equipment.

Important Safety Instructions

- **Read Instructions** -- All the safety and operating instructions should be read before the product is operated.
- **Retain Instructions** - The safety and operating instructions should be retained for future references.
- **Heed Warnings** - All Warnings on the product and in the operation instructions should be adhered to.
- **Follow Instructions** - All Operating and user instructions should be followed.
- **Cleaning** - Unplug this product from the wall outlet before cleaning. **DO NOT** use liquid cleaners or aerosol cleaners. Use damp Cloth for cleaning.
- **Attachments** - **DO NOT** use attachments not recommended by the product manufacturer they may cause hazards.
- **Mounting** - **DO NOT** place this product on an unstable cart, stand, tripod, bracket, or table. The product may fall, causing serious injury to a child or adult, and serious damage to the product. Use only with a cart, stand, tripod, bracket, or table recommended by the manufacturer or sold with the product. Any mounting of this product should follow the manufacture's instructions, and should use a mounting accessory recommended by the manufacturer.
- **Heat** - The Product should be situated away from heat source such as radiators, heat registers, stoves or other products (including amplifiers) that produce heat.
- **Water** - **DO NOT** use this product near water. For example: Avoid placing it near bathtub, washbowl, kitchen sink, or laundry tub, in a wet basement, or near a swimming pool, etc.
- **Cabinet Slots** - **NEVER** push objects or any kind into the unit through the cabinet slots as they may touch dangerous voltage points or short out parts that could result in a fire or electric shock. **NEVER** spill liquid of any kind on the product.
- **Ventilation** - **DO NOT** block any ventilation openings. Install in accordance with manufacture's instructions. Slots and openings in the cabinet and the back and bottom are provided for ventilation, and to ensure reliable operation of the product and to protect it from Overheating. These openings must **NOT** be blocked or covered. There should be at least 10cm of space from these openings. The openings should never be blocked by placing the unit on a bed, rug or other similar surface. This product should **NOT** be placed in a built-in installation such as a bookcase unless proper ventilation is provided.
- **Grounding or Polarization** - This product may be equipped with a polarized alternating current line plug (a plug having one blade wider than the other). This plug will fit the power outlet only one way. This is a safety feature. If you are unable to insert the plug fully into the outlet, try reversing the plug. If the plug should still fail to fit, contact your electrician to replace your obsolete outlet. **DO NOT** defeat the safety purpose of the polarized plug.

Important Safety Instructions (continued)

- **Power Cord Protection** - Power supply cords should be routed so that they are not likely to be walked on or pinched by items placed upon or against them. Pay particular attention to cords at plugs, convenience receptacles, and the point where they exit from the product.
- **Power Sources** - This product should be operated only from the type of power source indicated on the rear panel. If you are not sure of the type of power supply to your home consult your product dealer or local power company.
- **Lightning** - For added protection for this product during a lightning storm, or when it is left unattended and unused for a long period of time, unplug it from the outlet and disconnect the antenna or cable system. This will prevent damage to the product due to lightning and power-line surges.
- **Power Lines** - An outside antenna system should not be located in the vicinity of overhead power lines or other electric light or power circuits, or where it can fall into such power lines or circuits. When installing an outside antenna system, extreme care should be taken to keep from touching such power lines or circuits as contact with them might be fatal.
- **Overload** - DO NOT overload wall outlets, extension cords or integral convenience receptacles as this can result in a risk of fire or electric shock.

Damages Requiring Service - Unplug this product from the wall outlet and refer servicing to qualified service personnel under the following conditions :

- When the power-supply cord or plug is damaged.
- If liquid has been spilled, or objects have fallen into the product.
- If the product has been exposed to rain or water.
- If the product does not operate normally after following the operating instructions.
Adjust only those controls that are covered by the operating instructions as an improper adjustment of other controls may result in damage and will often require extensive work by a qualified technician to restore the product to its normal operation.
- If the product has been dropped or damaged in any way.
- When the product exhibits a distinct change in performance - this indicates a need for service.
- **Replacement parts** - When replacement parts are required, be sure the service technician has used replacement parts specified by the manufacturer or have the same characteristics as the original part. UNAUTHORIZED substitution may result in fire, electric shock or other hazards.
- **Safety Check** - Upon completion of any service or repair to this product, ask the service technician to perform safety checks to determine that the product is in proper operating condition.
- **CAUTION** - Danger of explosion if battery is incorrectly replaced. Replace only with the same or equivalent type.

IMPORTANT Information Regarding Use of Video Games, Computer, Captions or other Fixed Image Displays.

- The Extended use of a fixed image program material can cause permanent "Shadow Image" on the LCD Panel. The Background image is viewable on normal programs in the form of stationary fixed image. This type of irreversible LCD panel deterioration can be limited by observing the following steps:
 - Reduce the brightness/contrast setting to a minimum viewing level.
 - DO NOT display the fixed image for extended periods of time.
 - Turn the power off when not in actual use.
- **Recycling** - This product utilizes tin-lead solder, and has a fluorescent lamp containing a small amount of mercury. Disposal of these materials may be regulated in your community due to environmental considerations. For disposal or recycling information please contact you local authorities, or the Electronics Industries Alliance: <http://www.eiae.org>

Table of Contents

1.INTRODUCTION

Safety Instructions	1~3
Preparation	5~7
How to Operate the Remote Control	8
Interconnect Diagram	9~12
Controls and Indicators	13~17

2.System Operating

Function Description	18
TV Tuner Setting/Auto Scan	19
Disc Playing (Using the Remote Control)	20
How to use SETUP KEY	21
GENERAL SETUP	22~23
SPEAKER SETUP	24
AUDIO SETUP	25~28
PREFERENCES	27~30
EXIT SETUP	31
How to Play MP3 and PICTURE CD'S	32

3.System Operating (TV)

TV AND AUDIO VIDEO INPUT OPERATING INSTRUCTIONS	33
MAIN DISP	34
SUB DISP	35
VOV ADJUST	36
VOV ADJUST(Continued)	37
AUDIO	38
CLOSE CAPTION	39
PARENT CONTROL	40~42
OSD SETUP	43
TV SETUP	44
PICTURE ADJUST(BRIGHTNESS/CONTRAST/SATURATION/HUE/SHARPNESS)	45
RECALL and EXIT	46
VGA INPUT SIGNAL AUTO TUNE and SAVE EXIT	47
VGA INPUT SIGNAL COLOR SETUP	48
VGA INPUT SIGNAL QUALITY ADJUST	49
VGA INPUT SIGNAL PICTURE POSITION SETUP	50

4.System Operating(FM)

OPERATION	51~52
-----------	-------

5.System Operating(Other)

ADJUSTMENTS(Sound/Audio Frequency/Time)	53~54
---	-------

6.TROUBLESHOOTING

	55~57
--	-------

7.Function List

	58
--	----

8.Accessories



	59
--	----

9.(FDA)CERTIFICATION

	60
--	----

Preparation

This device supports the following disc formats:

Suitable discs & their marks	Diameter /side/ layer	Maximum playing time
	DVD 12cm/Single/Single 12cm/Single/Double 12cm/Double/Single 12cm/Double/Double	MPEG II TYPE 133Min. (4.7GB) Max 242Min. (8.5GB) Max 266Min. (9.4GB) Max 484Min. (17GB) Max
	CD-DA 12cm/Single/Single	74 Min. Max.
	CD-DA 8cm/Single/Single	20 Min. Max.
	MP3 12cm/Single/Single	MPEG I layer-III 640 Min. Max.

Region Management Information

This player is designed to respond to the Region Management information recorded on DVDs. The region number of this player is "1". If the region number on the DVD does not correspond to the number of this player, this player cannot play disc.

This player will also play DVDs made for "ALL" regions. This player will play DVDs with labels containing the region number "1" or "ALL":

Example:



INSTALLATION

- **Receiver Location** - Locate for comfortable viewing.
Avoid placing where sunlight or other bright light will fall on the screen.
Use of some types of florescent lighting can reduce remote control transmitter range.
Adequate ventilation is essential to prevent internal component failure.
Keep away from areas of excessive heat.
To ensure optimum picture quality do not position magnetic equipment nearby.
- **Cable Equipment** - The Video/Audio connection between components can be made with shielded video and audio cable. For best performance, Antenna cables should utilize 75 Ohm coaxial shielded wire. Cables are available from your dealer or electronic supply store.
Before you purchase any cables, be sure you know what type of output and input connectors your various components require. Also determine the length of cable you'll need.

LICENSE CLAIMS

Dolby

Manufactured under license from Dolby Laboratories. "Dolby", "Pro Logic" and the double-D symbol are trademarks of Dolby Laboratories. Confidential Unpublished Works ©1992-1997 Dolby Laboratories, Inc. All rights reserved.

DTS

Manufactured under license from Digital Theater System, Inc. "DTS" and "DTS Digital Surround" are trademarks of Digital Theater System, Inc. ©1996 Digital Theater Systems, Inc. All rights reserved.

Macrovision

This product incorporates copyright protection technology that is protected by method claims of certain U.S. patents and other intellectual property rights owned by Macrovision Corporation and other rights owners. Use of this copyright protection technology must be authorized by Macrovision Corporation. And is intended for home and other limited viewing use only unless otherwise authorized by Macrovision Corporation. Reverse engineering or disassembly is prohibited.

Note - Some DTS decoders which do not support DVD-DTS interface may not work properly with the DVD/CD Player.

Reference

- **Dolby Digital** is a digital sound compression technique developed by Dolby Laboratories, Inc. Supporting 5.1-channel surround sound, as well as stereo (2 Channel) sound, this technique enables a large quantity of sound data to be efficiently recorded on a disc.
- **The Digital Theater System (DTS)** is a 5.1-channel surround sound system, which is widely used in movie theaters around the world. It allows the bit rate to be increased in order to provide good sound quality without excessively compressing the data.
- **Linear PCM (LPCM)** is a signal recording format used in a CD. While a CD is recorded in 44.1 kHz/16 bit, a DVD is recorded at 48kHz/16 bit up to 96kHz/24 bit.
- If you have a Dolby Pro Logic Surround decoder, you will obtain the full benefit of Pro Logic from the same DVD movies that provide full 5.1-channel Dolby Digital soundtracks, as well as from titles with the Dolby Digital mark.
- The digital audio output connector (optical) converts electrical signals into optical signals (light) and transfers them to an amplifier. These optical signals are immune from electrical interference, and they also have minimal effect on other equipment.

Handling Discs



Never touch the playback side.

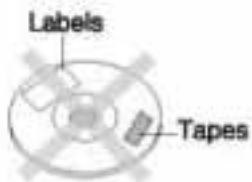

Never add labels or adhesive tapes on the discs and do not scratch or damage the discs.

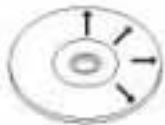

Cleaning of Discs :
Use a soft cloth and wipe off fingerprints and stains, in a radiating manner from the center to the outer rims when cleaning the disc.

Storage of Disc :
To prevent discs from getting bent or deformed they should be kept vertically in a disc storage case.

Discs

CD, DVD, CD-RW, and MP3

Please use discs which are stamped with  or IEC symbols.

Never use cracked or deformed discs

The Player operates at high speed.

Never use non-circular discs or failure may occur.

How to Operate the Remote Control

Load Batteries

Remove the battery cover by pushing in and lifting up the tab.



Load batteries while observing polarity.



Place the battery alignment tabs into the remote control and press the cover down into position.

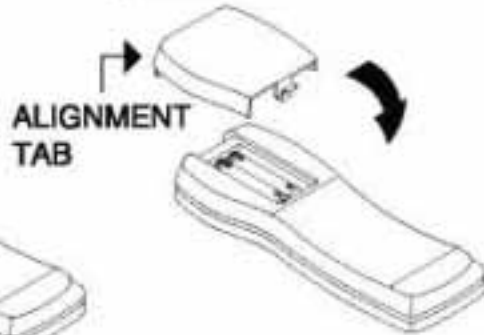

NOTE :

Replace both batteries simultaneously.

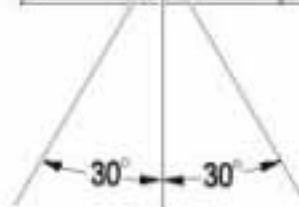
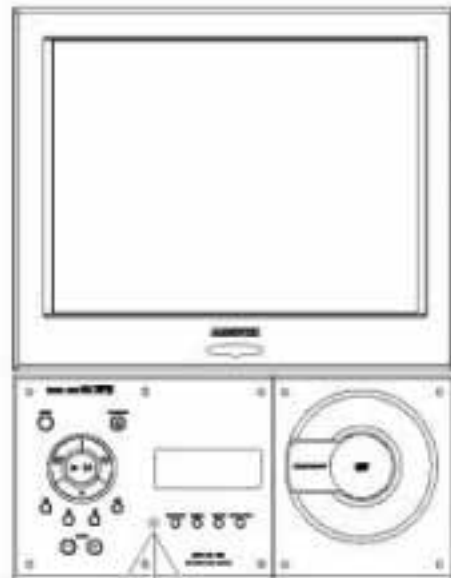

Interconnect Diagram

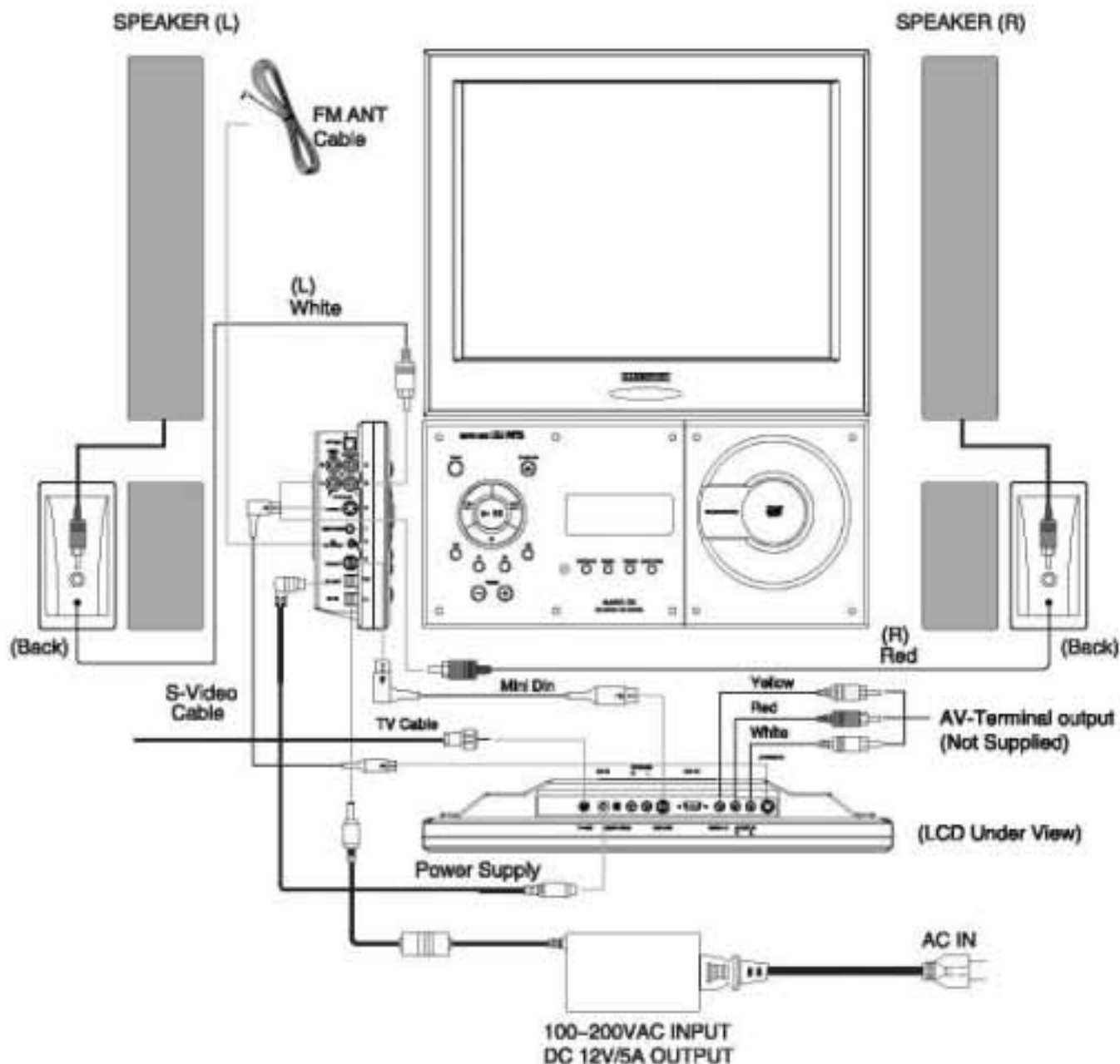

- Reversing the connection of the left and right speakers will result in the speaker balance being reversed.
- Prior to making connections on the unit remove the AC power cord from the power source.

Interconnect Diagram (Continued)

Connection Instructions:

1. Remove the contents from the box.
2. Locate the unit's base assembly.
3. Locate the video monitor. Place the video monitor mounting post into the mounting post of the base assembly.

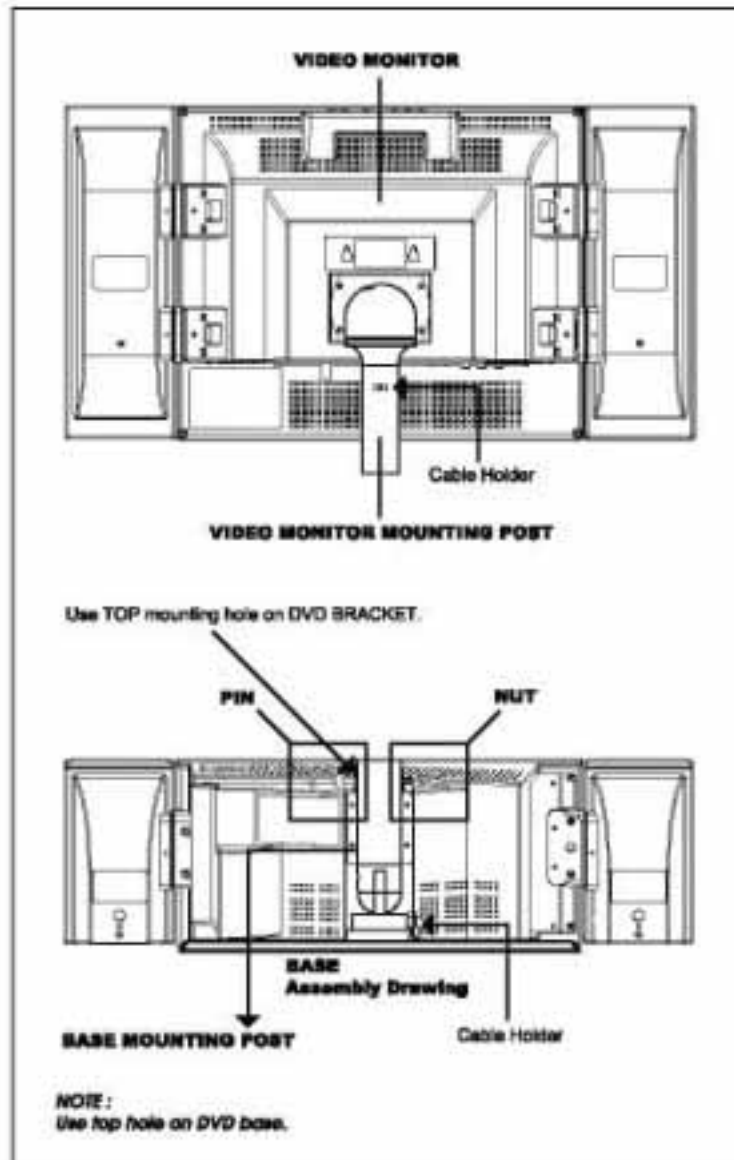

4. Locate the DVD assembly.
5. Tilt the video monitor assembly upward.
6. Align the top hole of the DVD player bracket with the hole on the base mounting post. Insert the pin through DVD player bracket and the mounting post. Refer to the assembly drawing.
7. Connect the various cables in the following manner:
 - a. Connect the Mini Din cable with the 90 connector head to base connector labeled **MINI DIN**.
NOTE: The Mini Din cable and the S-Video cable appear to be identical. However the Mini Dun cable contains 8 pins while the S-Video cable contains 4 pins. Do not force the connector as this may result in cable connector pins being bent. Route the cable through the cable holder on the mounting post. Connect the other end of the cable to the connector labeled **MINI DIN** on the video monitor.

Interconnect Diagram (Continued)

- b. Connect the S-Video cable with the 90° connector head to base connector labeled **S-VIDEO**.
NOTE: The Mini Din cable and the S-Video cable appear to be identical. However the Mini Din cable contains 8 pins while the S-Video cable contains 4 pins. Do not force the connector as this may result in cable connector pins being bent. Route the cable through the cable holder on the mounting post. Connect the other end of the cable to the connector labeled **S-VIDEO** on the video monitor.
- c. Connect the DC OUT cable with the 90° connector head to base connector labeled **DC OUT**. Route the cable through the cable holder on the mounting post. Connect the other end of the cable to the connector labeled **DC IN** on the video monitor.
- d. Connect the FM antenna cable with 90° connector head to the connector labeled **FM ANTENNA**. Position the wire to obtain the best FM signal reception.
8. Attach the upper right speaker by aligning and inserting the two speaker mounts from the video monitor into the speaker assembly receptacles.
9. Repeat Step 8 for the lower right speaker.
10. Secure the upper and lower right speakers with the Philips screws supplied. The upper right speaker requires two screws and the lower right requires one screw.
11. Repeat steps 8, 9, and 10 for the left speakers.
12. Route the upper left and right speaker cable through the cable holder on the mounting post and the cable holder on the base.
13. Connect upper right speaker cable to the lower right speaker cable input.
14. Repeat Step 13 for the left side speakers.
15. Route the speaker cable from the lower left speakers and connect to the **L Speaker Connector**.
16. Route the speaker cable from the lower right speaker through the base cable holder. Connect to the **R Speaker Connector**.
17. Connect the AC power cord to the AC Adapter. Connect the DC power connector to the **DC IN** connector on the DVD player assembly.
18. Insert the AC power cord into an appropriate AC power source.

Interconnect Diagram (continued)

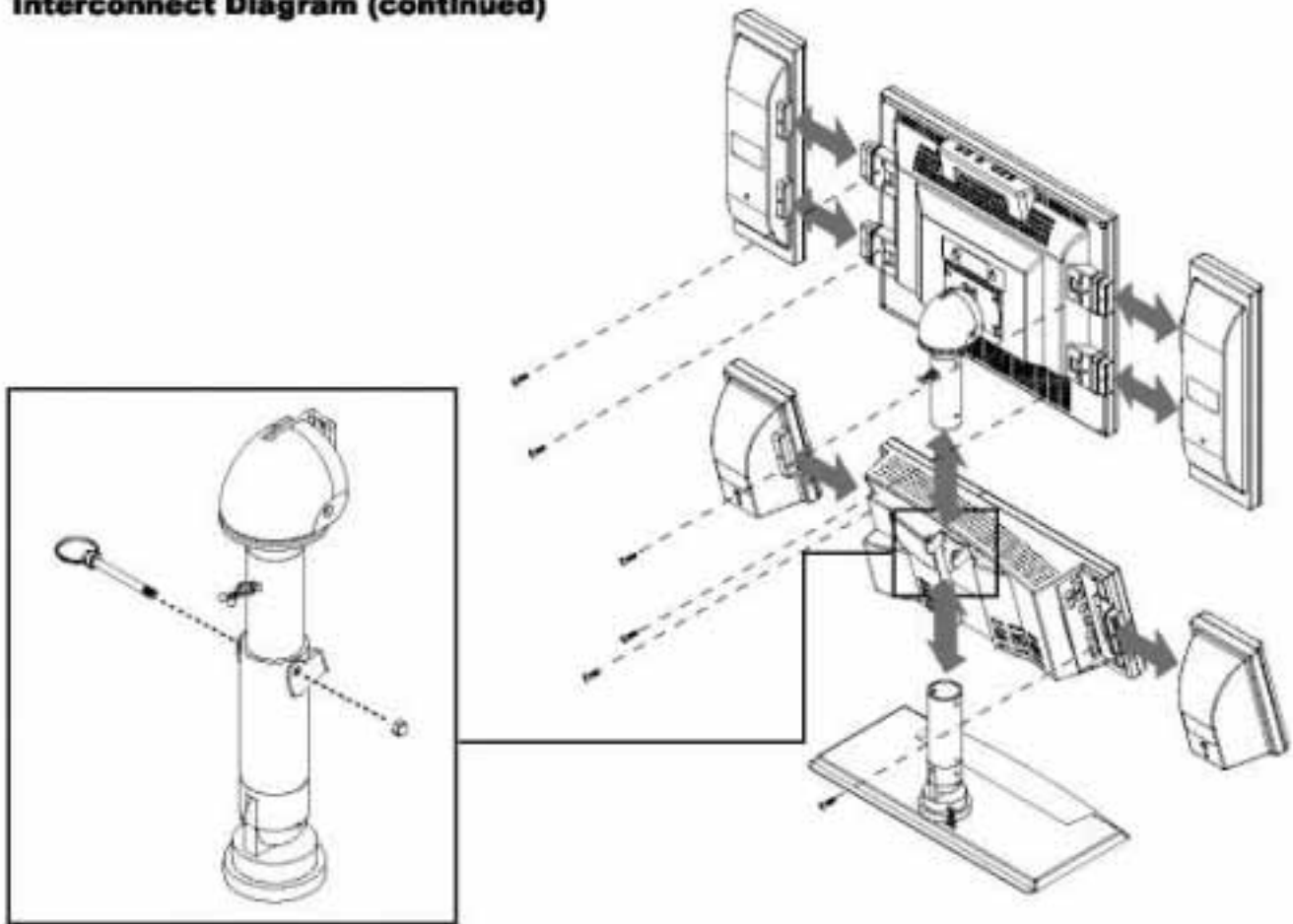

CONNECTING TO AN EXTERNAL AMPLIFIER :

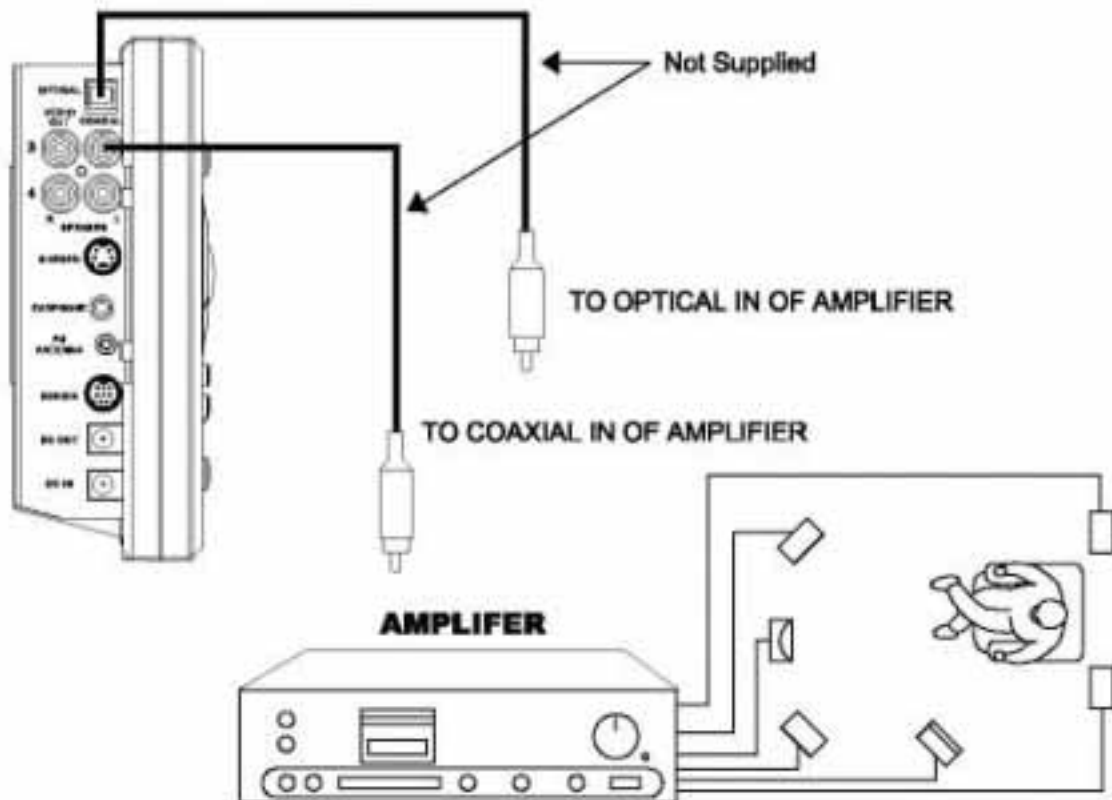

Controls and Indicators

LCD Monitor

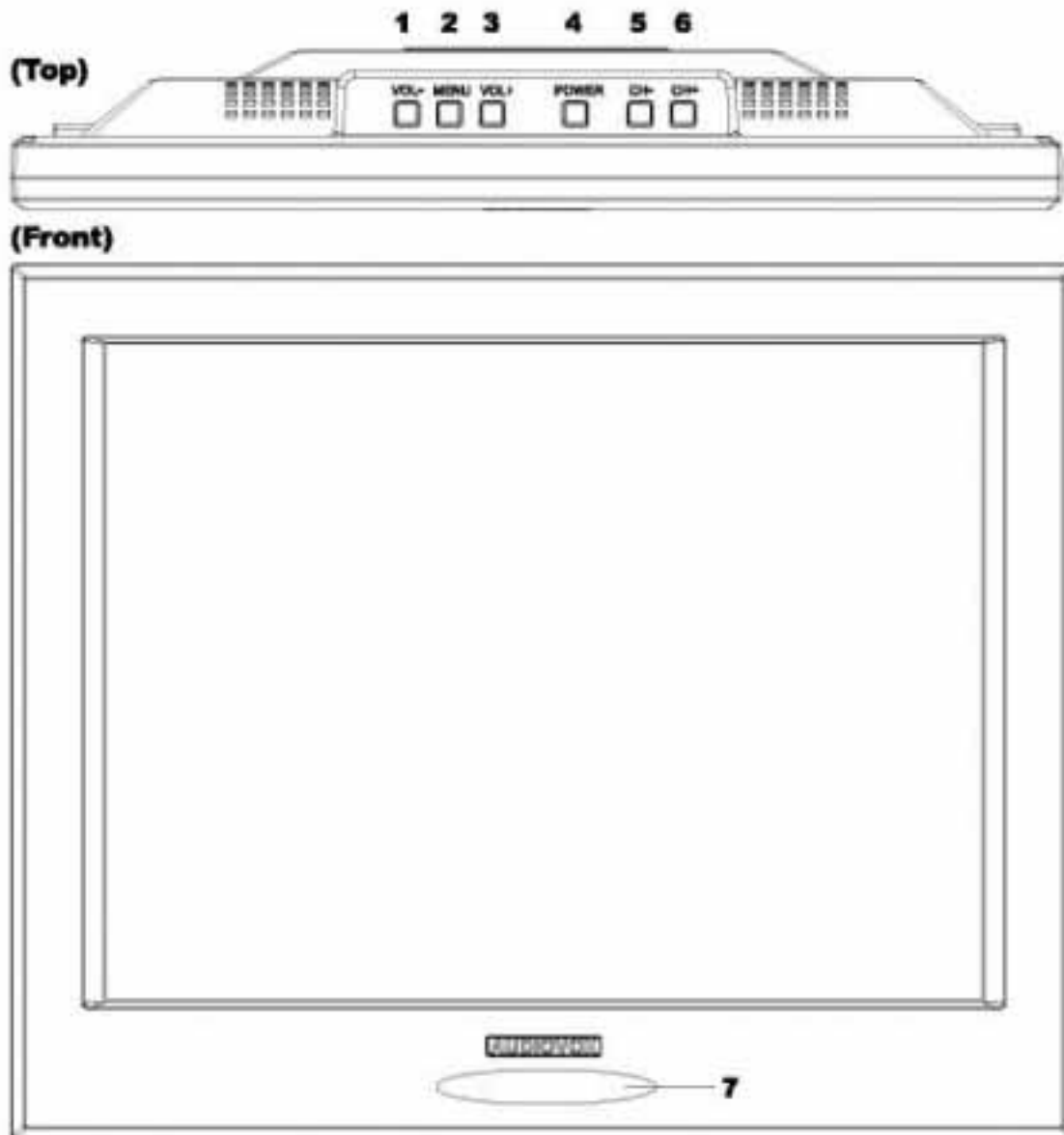

For TV USE :

1. **VOL -** : Decreases the volume of broadcast TV and external audio signals.
2. **MENU** : Enter main menu of LCD panel. Also used to select menu functions.
3. **VOL +** : Increases the volume of broadcast TV and external audio signals.
4. **POWER** : Turns the TV monitor On and Off.
5. **CH -** : Decreases channel numbers.
6. **CH +** : Increases channel numbers.
7. **Remote Control sensor**

Control and Indicators (Continued)

Remote Control

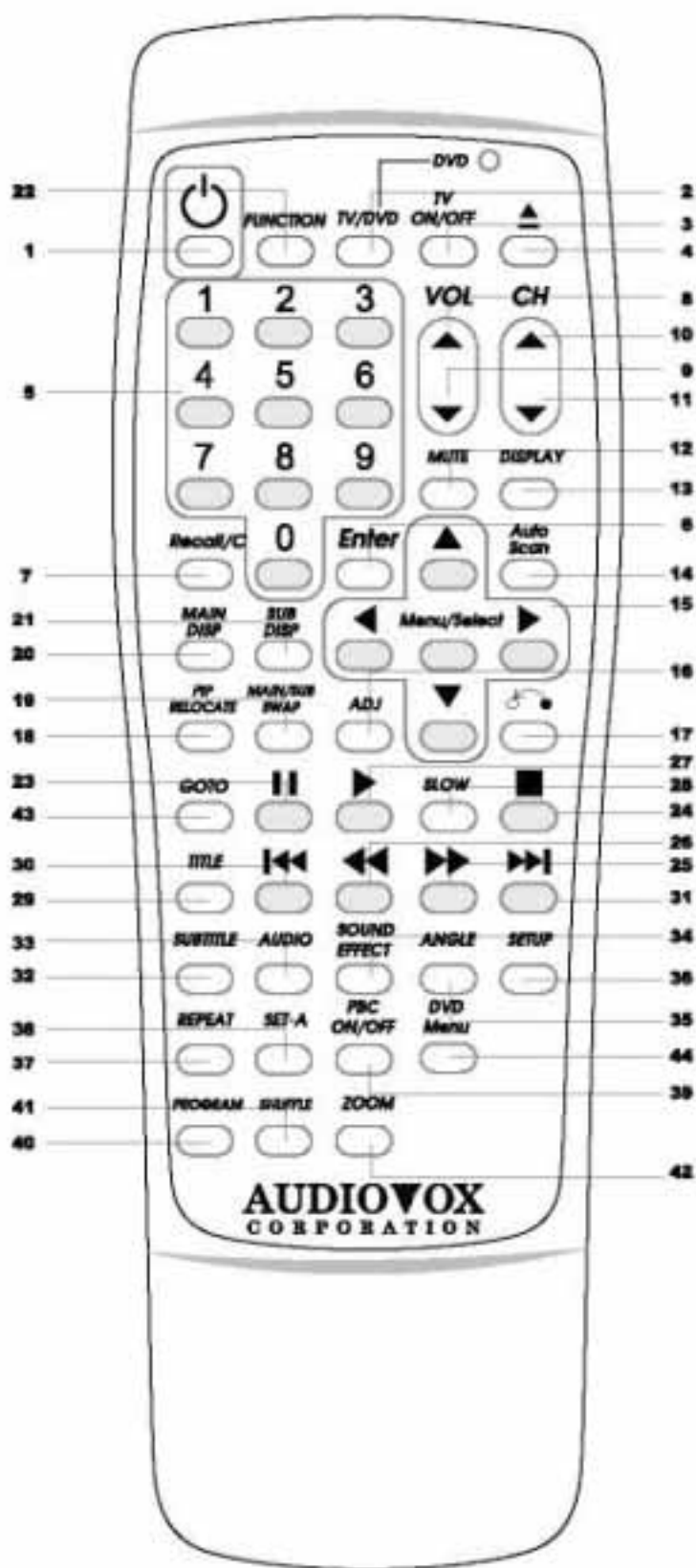

Control and Indicators(Continued)

Display

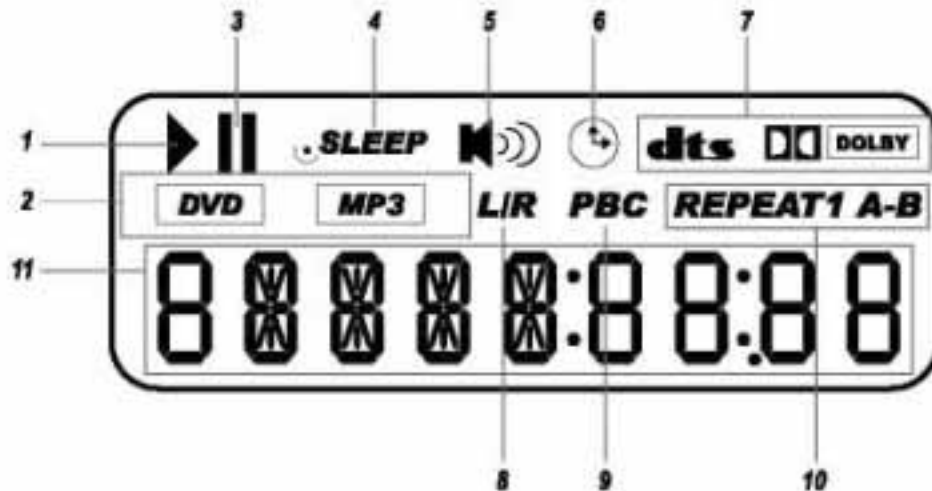

- ▶ Displays the direction of playback.
- DVD MP3 Displays the type of disc inserted.
- || Displays pause mode.
- .SLEEP Indicates the sleep.
- M🔔 Indicates the alarm mode.
- 🕒 Displays time.
- dts DOLBY Displays audio settings.
- L/R Displays Left/Right audio channel.
- PBC Displays playback control.
- REPEAT 1 A-B Enables the repeat function.
- 88888:8888 Character displays including frequency, time, number etc.

Function Description

Power On/Off

NOTE : The power key of the video monitor is located on the top of panel.

Place the power plug into the wall outlet and wait 7 seconds while the system initializes.
Press the POWER button on the remote control or the front of unit.

- Wait one second before pressing the next key

There are two methods to turn the power on and off of the unit :

Remote Control :

Press power button of the remote control to turn the power On or Off.

Front Panel :

Press power button of front panel to turn the power On or Off.

Display Mode Switching

Remote Control :

Press function key to switch the display mode in order as following :

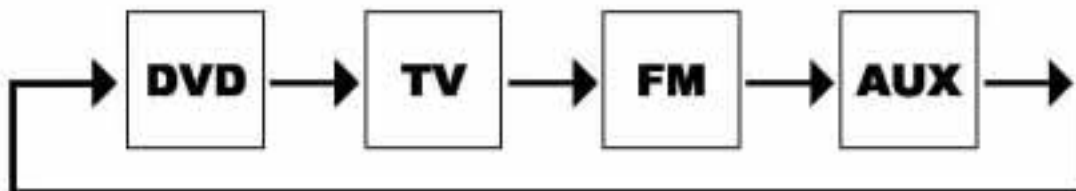

- NOTE :**
1. When you use the DVD function, press the TV/DVD button until the LED light red.
 2. If you choose FM display mode, the video monitor display will shut down and the back-lighted panel will display the FM frequency.

Front Panel : Press  button to select the DVD player function.

Press  button to select the TV function.

Press  button to select the FM function.

Press  button to select the AUX function.

NOTE : The AUX function defaults to VGA for computer support.

TV Tuner Setting / Auto Scan

NOTE :Verify the DVD Indicator located on the top right of the remote control does not flash or stay red. If it does, press the TV/DVD button.

TV Tuner Setup

Press the TV function button on the front of the DVD unit.

TV Selection

If you need to switch between CATV or TV(AIR), press the **Menu/Select** button.

Enter the MAIN DISP and select either CATV or TV(AIR). Press the **Menu/Select** button to confirm.

Auto Scan

Once the CATV or TV(AIR) is displayed press the Auto Scan button to begin scanning for valid TV channels and place them into the unit's memory.

NOTE:

The TV Function button on the front of the unit needs to be pressed in order for the speakers to switch to the tuner.

Disc Playing (Using the Remote Control)

- This player can play DVD, CD, CD-R/W, MP3.

NOTE :

The DVD indicator on the Remote Control (upper right corner) should light steady to access the DVD/CD Menu Options.

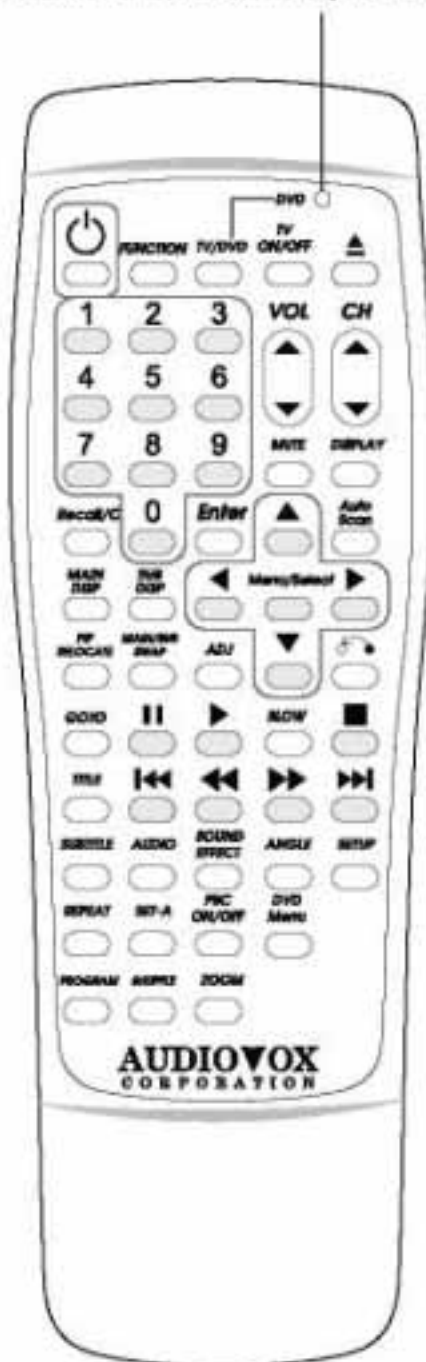

1. Turn POWER on
 - a. Press the POWER button to turn On the unit.
 - b. The display indicates LOAD and the Screen displays LOADING. (Verify DVD function is selected)
2. Insert the disc
 - a. Press OPEN/CLOSE "▲" button to open the DVD player door and the screen will display "OPEN"
 - b. Insert the disc in the center and smarm into place.
 - c. Press POEN/CLOSE "▲" button again to close the door and the back-lighted panel will display "CLOSE." If the DVD disc has an auto-play the player will automatically play the program after the door is closed.
3. Press the "PLAY" button to view the program
 - a. If the disc inserted is a DVD disc, the movie menu can be selected.
4. STOP playing
 - a. Press the STOP "■" button and the program will stop playing immediately.
 - Press the PLAY "▶" button again to start playing.
 - Press the STOP "■" button twice while viewing a DVD to stop playing and return to the beginning of the program, when the PLAY "▶" button is pressed the program will start from the beginning.
5. Remove the disc
 - a. Press OPEN/CLOSE "▲" button and the video monitor and the back-lighted panel will display OPEN. Remove the disc. Press OPEN/CLOSE "▲" button again and the video monitor and back-lighted panel will display NO DISC.
6. Power Off
 - a. Press the POWER button to turn power Off.

How to use SETUP KEY

When you press the SETUP button on the remote control, the setup menu (main page)will be displayed.

- 1. Press SETUP button.**
The setting menu appears.

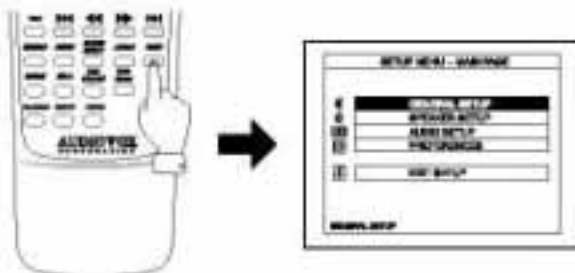

- 2. Press Enter or Menu/select**
All the items under the category will appear on the video monitor.

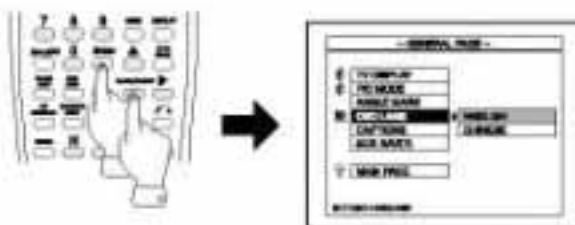

- 3. Press the direction buttons (UP, DOWN, RIGHT and LEFT) to select the desired category.**

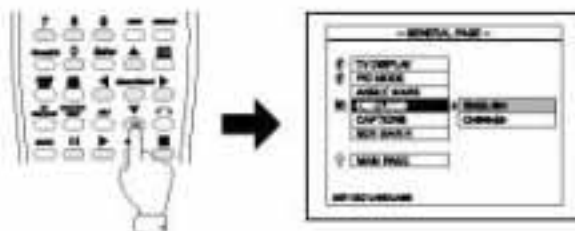

GENERAL SETUP

TV DISPLAY :

4 : 3/PS (4:3 Pan Scan) :

Select 4:3 Pan Scan displays pictures to fill your TV screen. (Either or both sides (left and right) of the picture are cut off).

4 : 3/LB (4 : 3 Letter Box) :

Select 4:3 Letter Box displays pictures to fill your TV screen. (Either or both sides (up and down) of the picture are cut off).

16 : 9/WIDE (16:9 Wide Screen) :

Select 16:9 wide screen.(Black bands may appear on the top and bottom of the picture.)



PIC MODE (PICTURE MODE) :

There are three modes for adjusting picture quality.

AUTO :

Automatically adjust display mode.

HI-RES (High-Resolution) :

Press this button for high resolution.

N-FLICKER (No-Flicker) :

Press this button to stabilize display.



ANGLE MARK :

If the DVD supports angle views, you can select different angles to view the program by turning on the ANGLE MARK function. If you turn off the ANGLE MARK, the ANGLE mark function is unavailable.

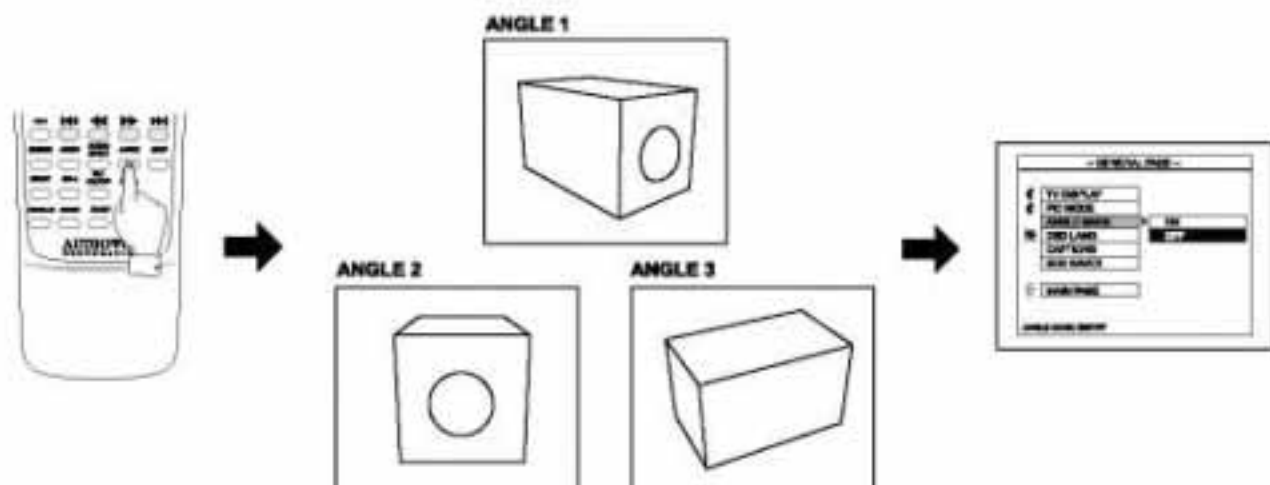

GENERAL SETUP

OSD LANG (OSD LANGUAGE) :

Languages available for the on screen display (OSD) in this unit.



CAPTIONS :

If the DVD supports captions, you can display the caption by enabling the caption function.

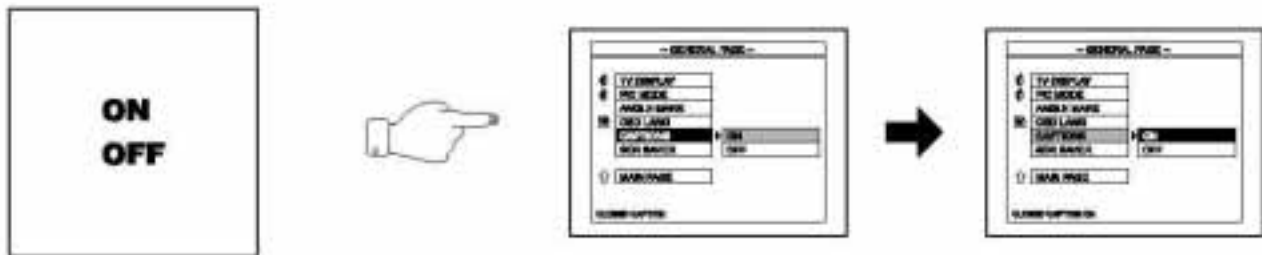

SCR SAVER (SCREEN SAVER) :

Enables the screen saver mode when no functions are accessed for a prolonged period of time.

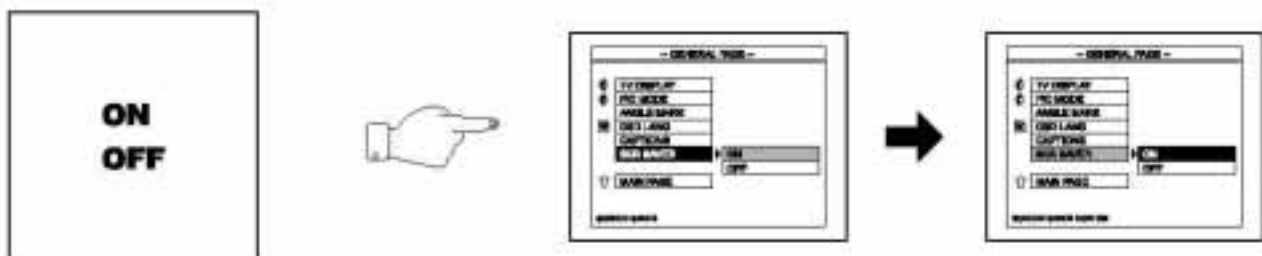

MAIN PAGE :

Back to Setup Menu.



SPEAKER SETUP

You can choose various sound effects. Access the **SPEAKER SETUP** and then the following choices will appear in order.

DOWNMIX :

You can use the **DOWNMIX** function to simulate 5.1 sound effects from a 2 channel output.

1. **LTRT:** Mono.
2. **STEREO:** Stereo.



AUDIO SETUP

Allows you to select your listening preferences.

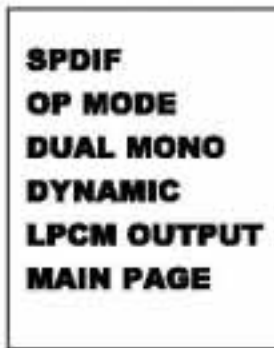

SPDIF :

SPDIF : (Digital 5.1 Channels Output)

Used to connect this unit with a built-in Dolby digital, DTS, MPEG 1 or MPEG 2 decoder.

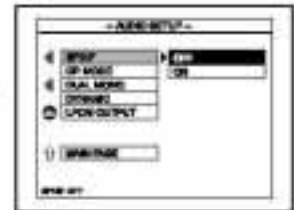

OP MODE (Operational Mode) :

Linear Power Amplifier Output.

Used to apply the audio signal to an external audio device.



DUAL MONO :

The audio signal is applied equally to the left and right speakers.



AUDIO SETUP

DYNAMIC :

Allows the user to select the dynamic range of the audio signal.

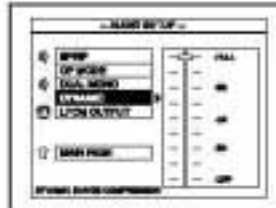

LPCM OUTPUT : (Linear PCM)

Signal recording format used in a CD or DVD.

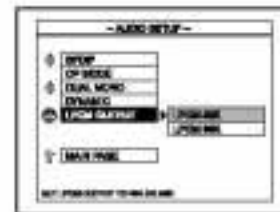

MAIN PAGE :

Back to Setup Menu.



PREFERENCES

When you enter the PREFERENCES, the user can select DVD viewing properties.

- TV TYPE**
- AUDIO**
- SUBTITLE**
- DISC MENU**
- LOCALE**
- PARENTAL**
- PASSWORD**
- DEFAULTS**
- SMART NAV**
- MAIN PAGE**



TV TYPE :

MULTI : NTSC and PAL system are automatically selected by the unit based on DVD format.

NTSC : NTSC United States and Canada.

PAL : PAL Europe.

- MULTI**
- NTSC**
- PAL**



AUDIO :

Choose the audio languages supported by the DVD such as English, French, Spanish, Chinese and Japanese.

- ENGLISH**
- FRENCH**
- SPANISH**
- CHINESE**
- JAPANESE**

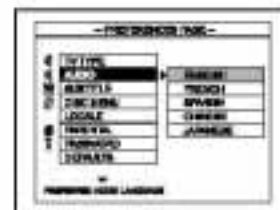

PREFERENCES (Continued)

SUBTITLE :

Choose the DVD subtitle language such as English, French, Spanish, Chinese and Japanese. Or you can choose the OFF to disable the subtitle function.



DISC MENU :

Choose the languages of DVD OSD menu by disc supports such as English, French, Spanish, Chinese and Japanese.

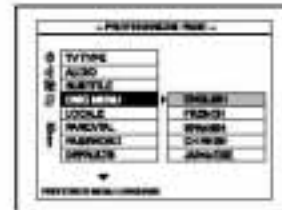

LOCALE :

Different countries have different parental control standards. (Not Used)

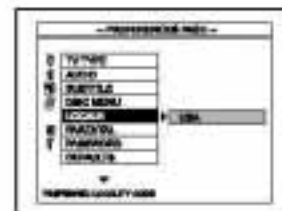

PREFERENCES (Continued) :

PARENTAL (Parental Level Control) :

The parental level control allows users to set the level necessary to prohibit children from viewing movies such as those with violence or adult subject matter.

DVDs equipped with a parental rating function allows viewing to be controlled.

The different level are as follows :

G : General Audience (Appropriate for all ages).

PG : Parental Guidance Suggested (Some material may not be suitable for children).

PG-13 : Parents Strongly Cautioned (Some material may be inappropriate for children under 13).

R : Restricted (Under 17 requires accompanying parent or adult guardian).

NC-17 : Not intended for anyone 17 and under.

ADULT (X) : X-rated (For adults only).

No-PARENTAL : No viewing restriction.

If you want to change the available level, use the up, down, left, right buttons to highlight

the desired level. Then press **ENTER** provided password and confirm by pressing **ENTER**.

NOTE : This option only works for DVD viewing. The TV has it's own Parental Control, please see page 40.

NOTE : Default Password is "3308".

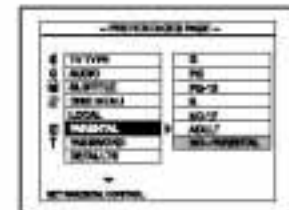

PREFERENCES (Continued)

PASSWORD :

CHANGE

You can change the password of parental lock by the following procedure :

1. Choose CHANGE Function and hit **ENTER** to enter the Password Change Page.
2. Fill in the blanks with the default Password.
The default password is 3308, enter "3308".
3. Then fill in the blanks with the New Password.
4. Fill in the blanks with the New Password again and confirm the password.

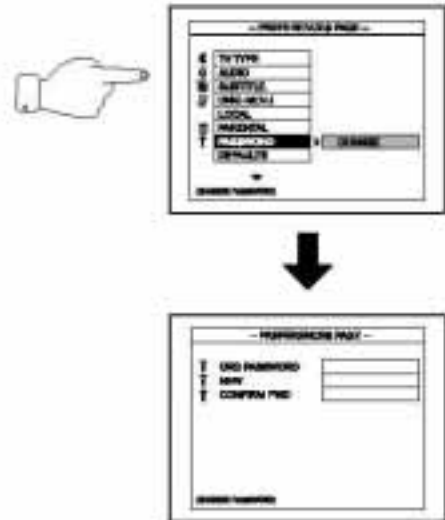

DEFAULTS

Use the default function to reset all preferences back to factory original settings.

NOTE : Reset will not interfere with the Parental Control.



SMART NAV :

You can choose to display the MP3 Smart Navigation menu. Press **SMART NAV** option, and press "No Menu" button to disable the menu display.



MAIN PAGE :

Back to Setup Menu.



EXIT SETUP

Exit Setup Menu

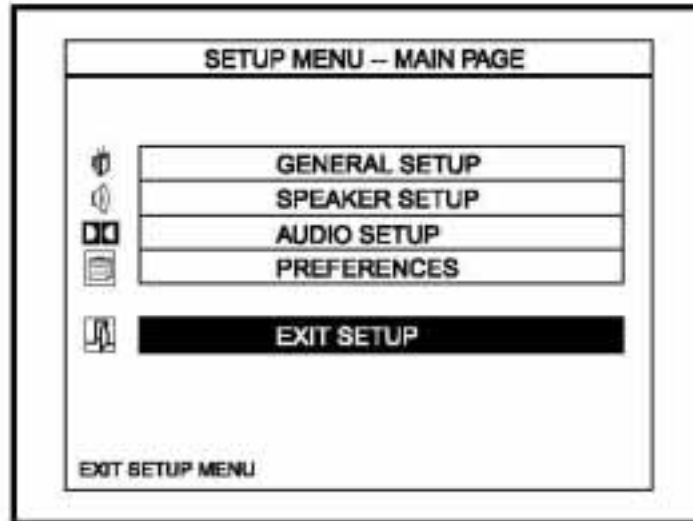

How to Play MP3 and PICTURE CD'S

The SMART NAV page will appear on the screen.

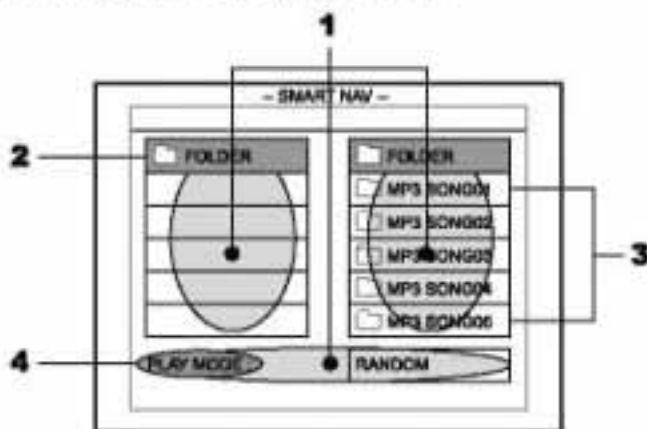

Operational methods of SMART NAV MODE :

1. There are three frames, including root directory, subdirectory and the play mode. Using the right/left button to switch to a different frame, or the up/down button to select the item within each subdirectory. Press Play to carry out the command.
2. Root directory : Shows all folders.
3. Subdirectory : Shows all files within each folder. (e.g. MP3, JPEG)
4. PLAY MODE : Allows users to select various play modes. Press the Right Button to enter the PLAY MODE. Use the up and down buttons to choose the play mode :

Users have the following selections :

- (1) Single : Play one song on the disc.
- (2) Repeat One : Repeat one song disc.
- (3) Folder : Play all songs in the folder once.
- (4) Folder Repeat : Play all songs in the folder repeatedly.
- (5) Disc Scan : Plays first 10 seconds of every song in the selected folder.
- (6) Disc : Play all songs of disc.
- (7) Disc Repeat : Repeat all songs of the disc.
- (8) Random : Songs played in a random order.
- (9) Shuffle On : Songs played in a random order.
- (10) Programming : Allows programming of song play order.

Program Setup :

1. (A) Using the left and right button to access the PLAY MODE.
Then using up (▲) and down (▼) buttons, change the function and choose **PROG-END** function. Press **Menu/Select** button to switch on **PROG-PO** function. The user can program songs in desired order.
 2. (A) Using the up (▲) and down (▼) buttons to move the pointer, choosing the song you want, and then press **Menu/Select** button to choose the song. Repeat for second, third.....song.
(B) On upper left side of the screen appears the code number you programmed and the number of this song in the MP3 song list.
For example: If you choose the songs from the file as follow No.5, No.6, No.7, it will appear as P01:05, P02:06, P03:07.
- NOTE : The songs in different MP3 folders cannot be programmed. You must choose the songs in the same folder.
4. After programming, press STOP button to end the programming process. The PLAY MODE will return to the PROG-END display. The programming process is complete.
 5. Press PLAY (▶) button to play the songs in the programmed order.

3.TV AND AUDIO VIDEO INPUT OPERATING INSTRUCTIONS

TV and AV Inputs

MAIN DISPLAY (MAIN DISP)

Press and release the *Menu/Select* button to display the following main menu for TV and AV functions :

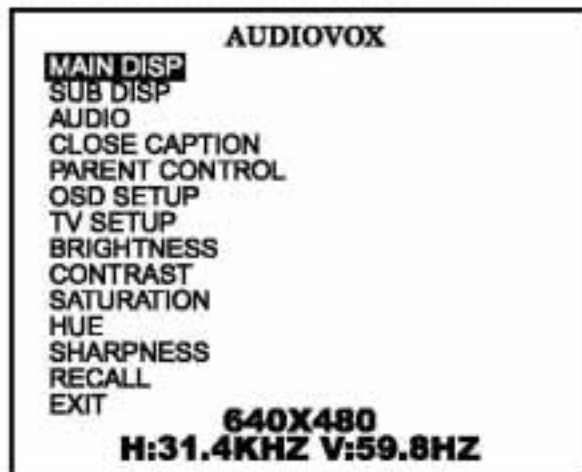

MAIN DISPLAY OPTIONS :

Can select a total of 14 input functions :

1. Main Display
2. Sub Display
3. Audio Option
4. Subtitle Display Controls
5. Parental Control (Viewing Levels)
6. On-Screen-Display(OSD) Option
7. TV tuner setup
8. Brightness
9. Contrast
10. Saturation
11. Hue
12. Sharpness
13. Recall (Factory Default)
14. Exit

NOTE:

The DVD light indicator on the remote control (upper right hand corner) should not light to access the TV/AV Menu options.

Press and release the *Menu/Select* button again to access the MAIN DISP menu :

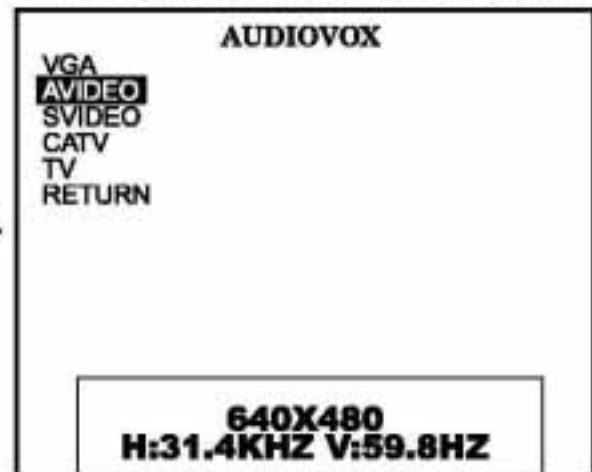

NOTE :

Screen Resolution
(Will vary)

INPUT SIGNAL SELECTIONS :

1. VGA-Computer Input Signal
 2. AVIDEO: AV Input Signal
 3. SVIDEO: S-Video Input Signal
 4. CATV: Cable TV Input Signal
 5. TV: Broadcast TV Input Signal
- RETURN to Previous Menu

MAIN DISP

MAIN DISPLAY (MAIN DISP)

We suggest you familiarize yourself with the remote control and OSD (On-Screen-Display) options before using the "MAIN DISP" menu option.

The Main display menu option allows selections of the five sources of signal inputs.

1. VGA (Computer input signal) : Connect the video Monitor with a personal computer.
2. AVIDEO (AV input signal) : Accepts all of AV output signals from various devices.
3. SVIDEO (S-Video input signal) : Accepts all of S-Video signals.
4. CATV (Cable TV input signal) : Cable TV channels including channel 1 to channel 125.
5. TV (TV input signal) : TV channels including channel 2 to channel 13 of VHF band and channel 14 to channel 69 of UHF band.
6. RETURN : Back to last menu (OSD picture).

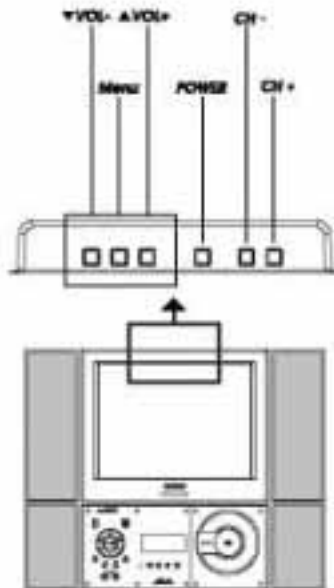

The TV function button located on the base unit must be pressed to hear the audio while viewing broadcast and cable TV. When an external auxiliary device (Camcorder, VCR, etc.) The AUX button located on the DVD player base unit must be pressed to hear the audio of the auxiliary input signals.

Operating : Press Up button (▲) or Down button (▼) to select options and press Menu/Select button to confirm.

OSD Option Display

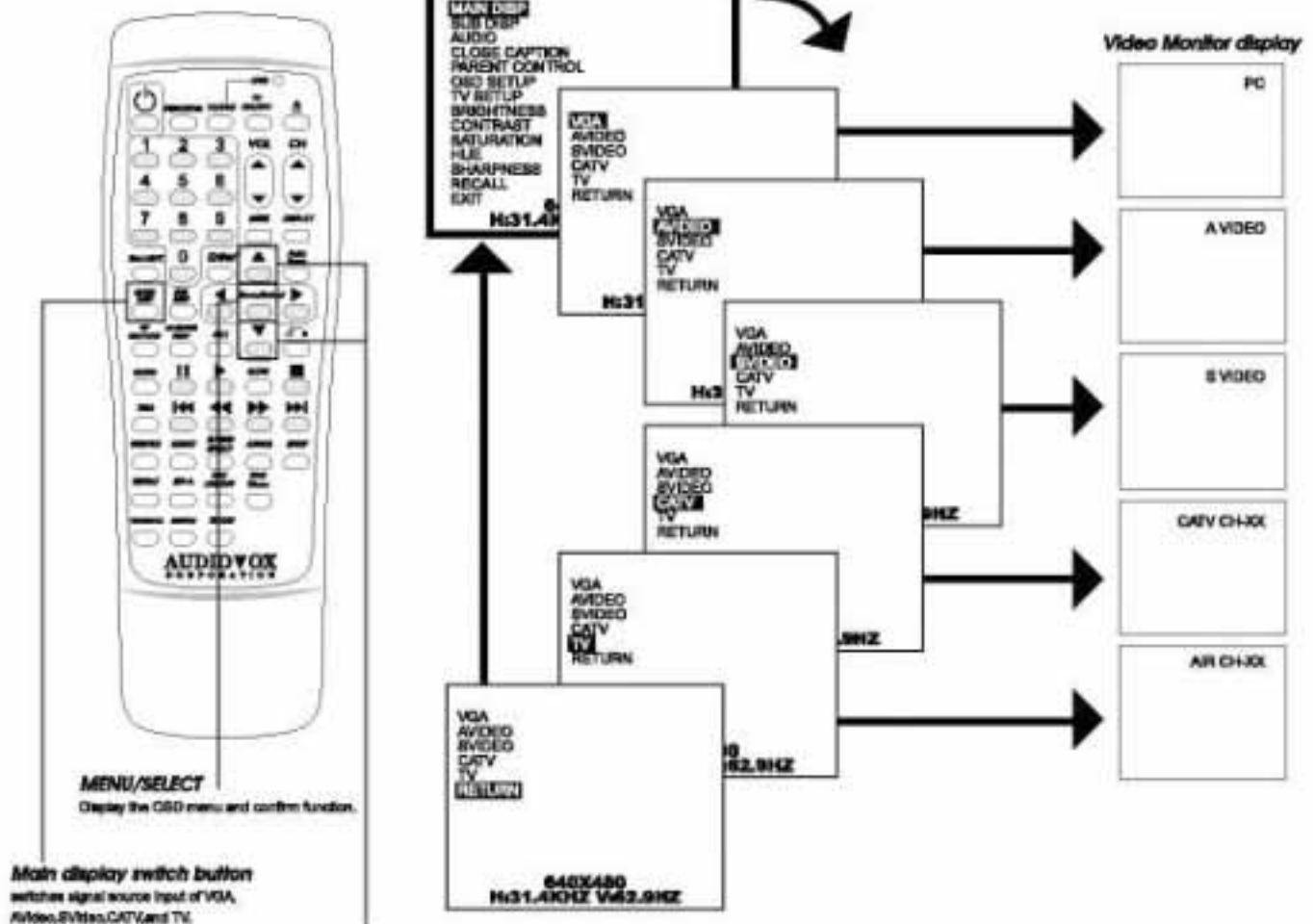

FORWARD
Press to go Up in menu selections.

BACKWARD
Press to go Down in menu selections.

SUB DISP

Sub DISP (sub display)

The sub display selects the signal source input : (AVideo, S-Video, CATV or TV.)
 Video-on-video (VOV) OFF : To turn off the VOV.

Operations: Press the Up button (▲) or the Down button (▼) to select options and press the Menu/select button to confirm.

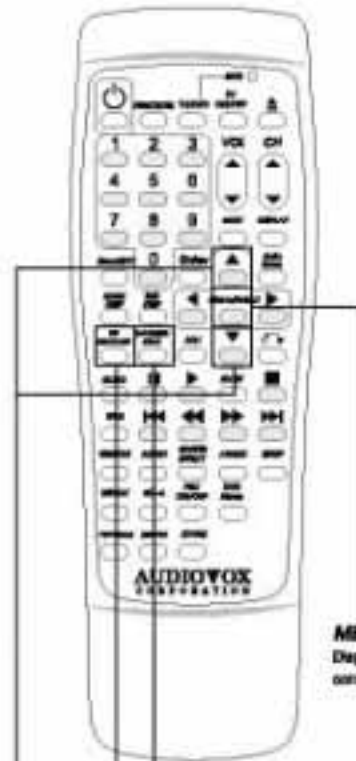
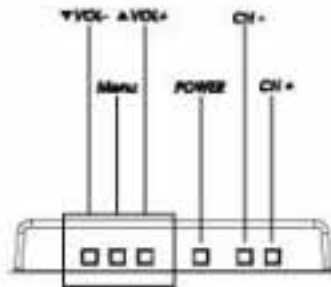

MENU/SELECT
 Display the OSD menu and confirm function.

OSD Option Display

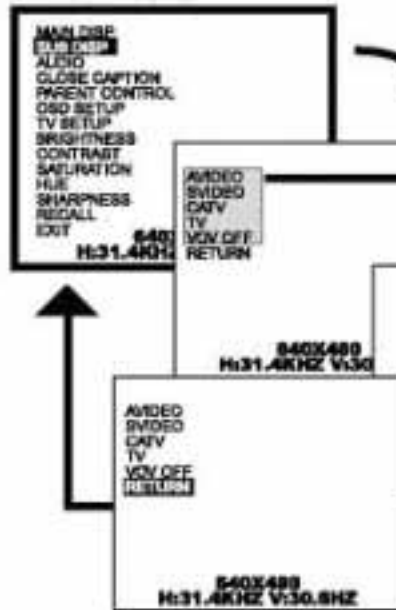

NOTE :
 VGA signal can not be displayed on SUB DISPLAY.

NOTE :
 Video-On-Video and Picture-In-Picture are the same function.

Swap Video-On-Video : Press the button once to switch the main display and sub display.

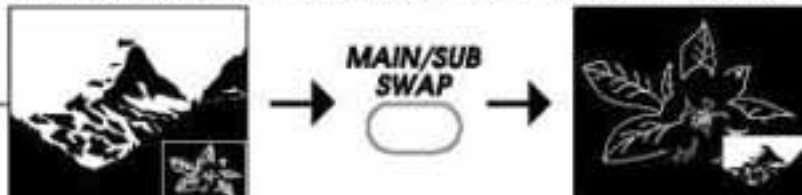

FORWARD
 Press to go Up in menu selections.
BACKWARD
 Press to go Down in menu selections.

To change the position of the sub display : Press the (PIP) RELOCATE button. Display position will change in order as following :

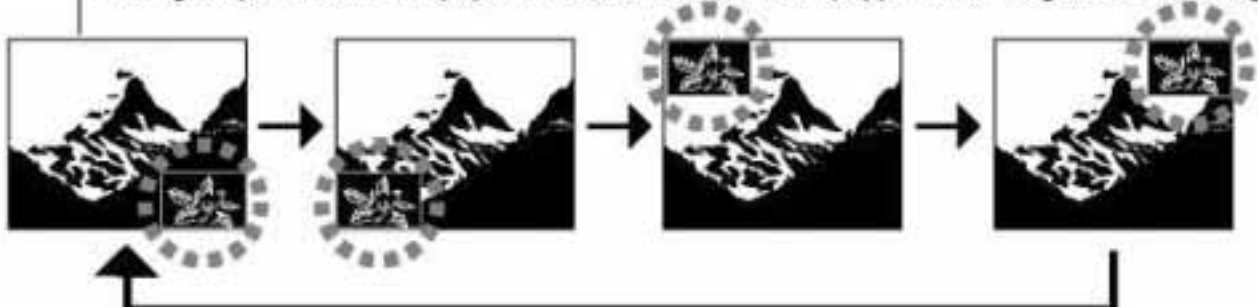

VOV ADJUST

VOV ADJUST

In addition to the main picture, another TV program or video source being received through the VIDEO input jacks can be displayed simultaneously as a small picture. This is called Video-On-Video (VOV) or Picture in Picture (PIP).

Operations: Press the Up button (▲) or the Down button (▼) to select options and press the Menu/select button to confirm.

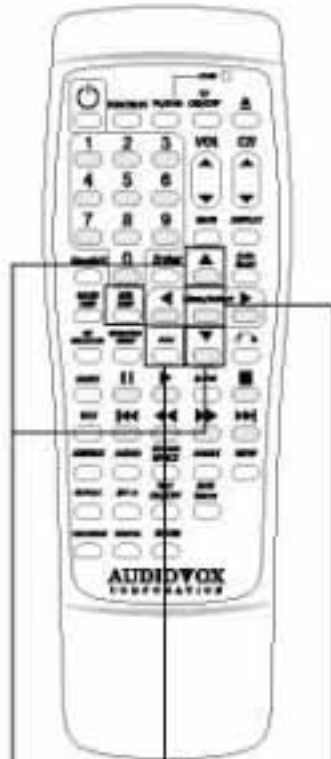
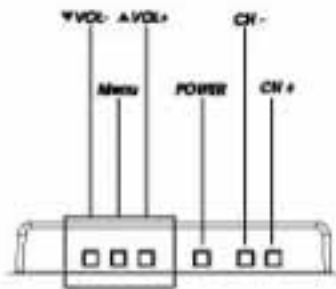

ADJ
Adjust the picture extension, hue, brightness and contrast.

MENU/SELECT
Display the OSD menu and confirm function.

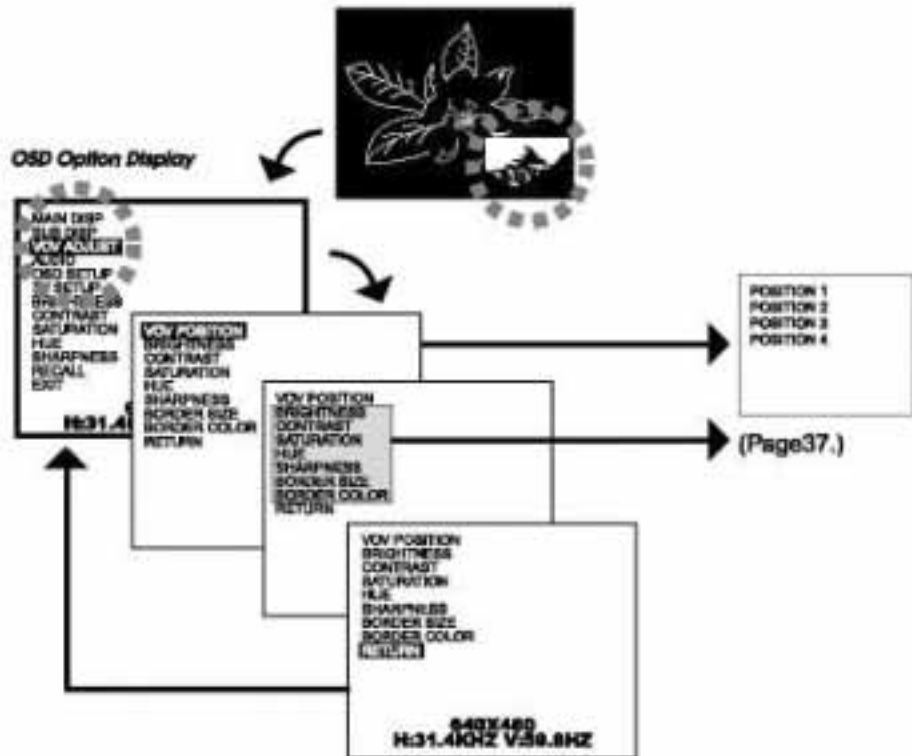

NOTE : VOV ADJUST only effects the Sub Display not the Main Display

FORWARD
Press to go Up in menu selections.
BACKWARD
Press to go Down in menu selections.

Each time you press the Sub Display button , the signal input source will be selected and displayed in the following order :

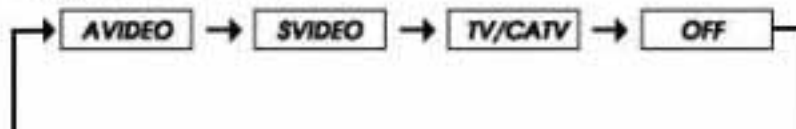

VOV ADJUST (Continued)

VOV ADJUST

Operations: Press the Up button (▲) or the Down button (▼) to select options and press the *Menu/select* button to confirm. Use the Up button (▲) or the Down button (▼) to adjust the various picture control bars.

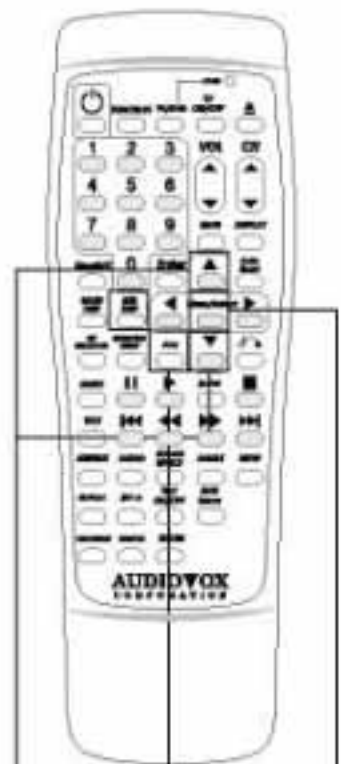
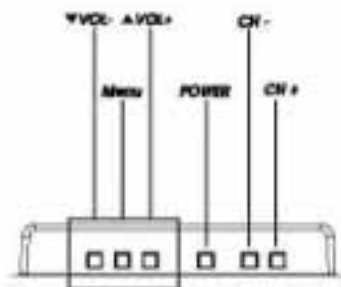

ADJ
Adjust the picture saturation, hue, brightness and control.

MENU/SELECT
Display the OSD menu and confirm function.

FORWARD
Press to go Up in menu selections.

BACKWARD
Press to go Down in menu selections.

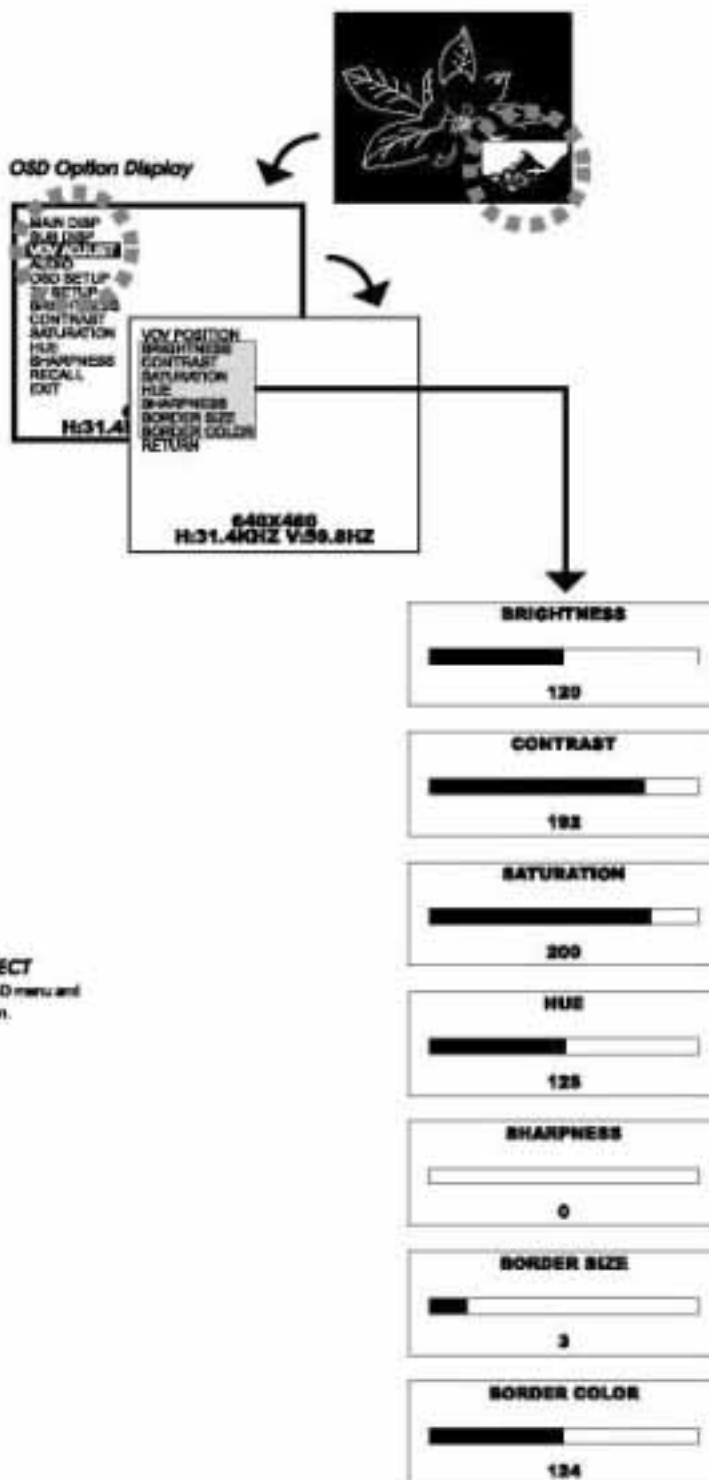

AUDIO

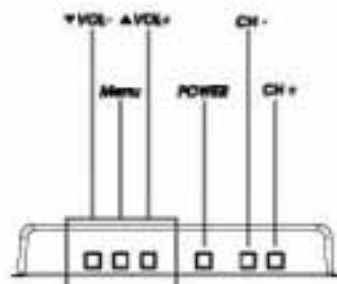

AUDIO

You can adjust the sound quality (BASS, TREBLE, LOUDNESS and GAIN) to suit your taste.

Operations: Press the Up button (▲) or the Down button (▼) to select options and press the Menu/select button to confirm. Use the Up button (▲) or the Down button (▼) to adjust the various picture control bars.

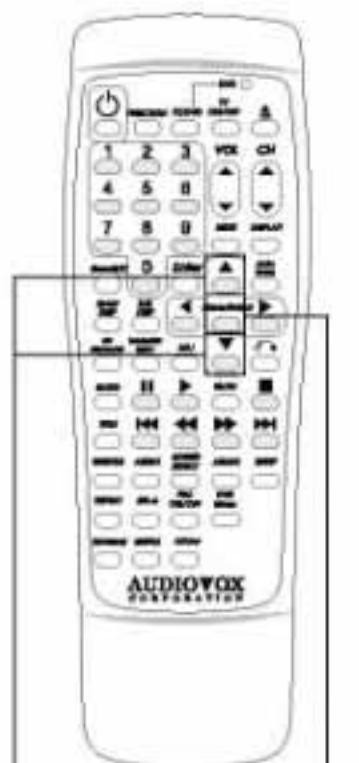

MENU/SELECT
Display the OSD menu and confirm function.

FORWARD

Press to go Up in menu selections.

BACKWARD

Press to go Down in menu selections.

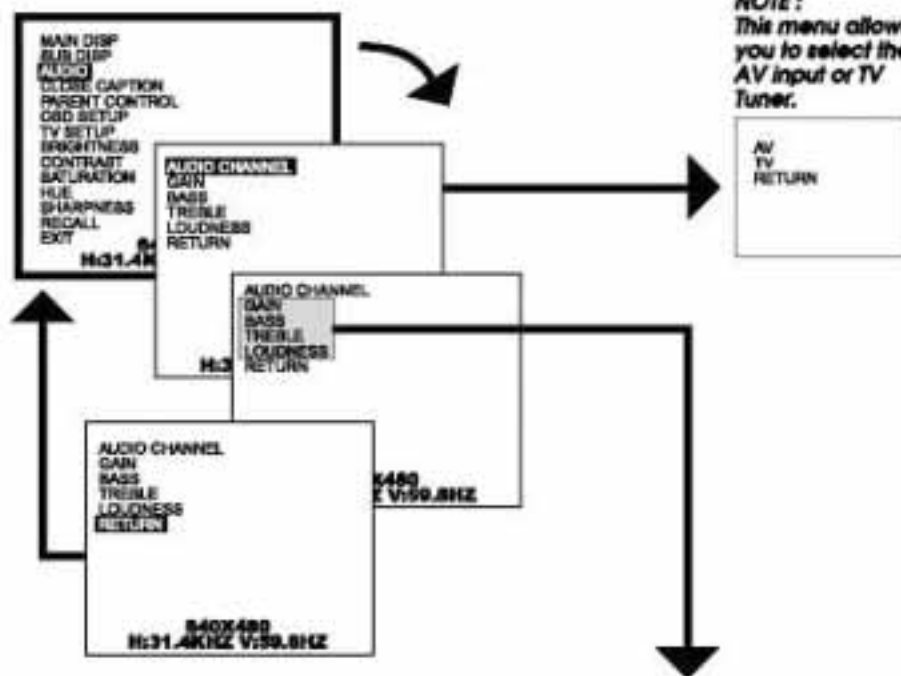

NOTE:
This menu allows you to select the AV input or TV Tuner.

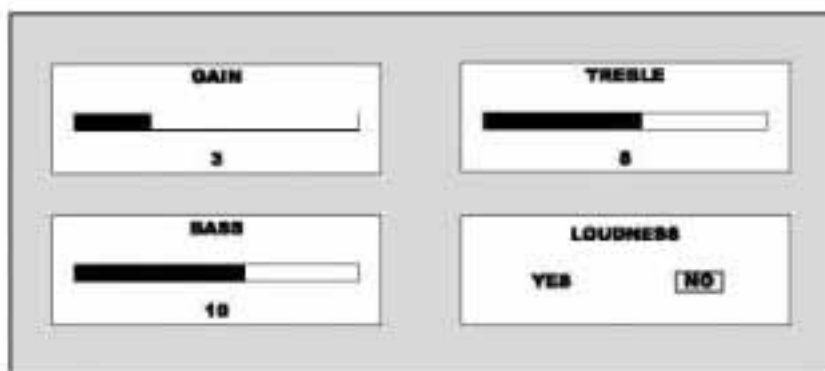

NOTE:

These adjustments in the Bass, Treble, Gain, and Loudness are for the TV only. They will not affect the DVD, CD or FM signal.

CLOSE CAPTION

Close Caption displays the audio content of a program on the video monitor.

1. CAPTION - Show or hide the caption.
2. DISPLAY :
 - a. BOX - You can choose to box the caption.
 - b. SHADOW - You can choose to show the caption in shadow (not boxed) format.
3. RETURN - Back to main menu display

NOTE :

Not all channels will provide CLOSE CAPTION.

In the TV Main Display, press and release the Down button (▼) to highlight CLOSE CAPTION

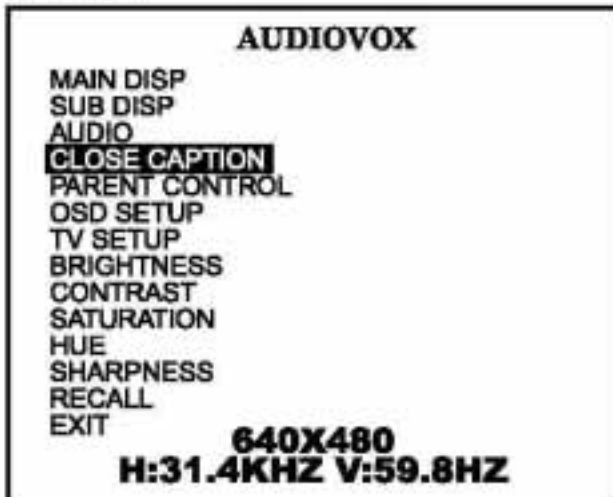

Press and release the *Menu/Select* button to display the CAPTION Menu.

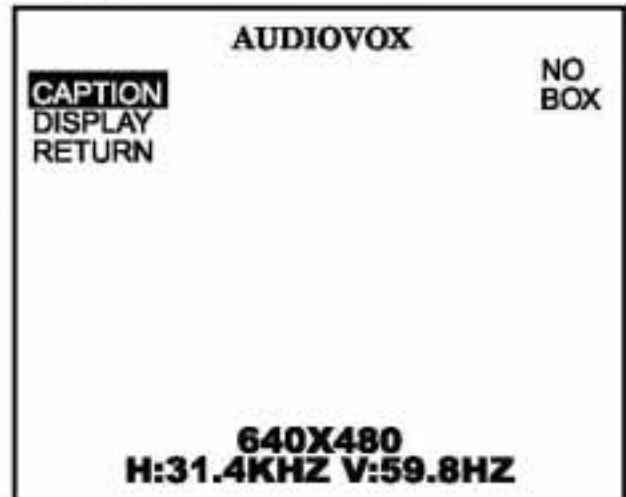

Press and release the *Menu/Select* button to select CAPTION(1-4) and text (1-4) options.

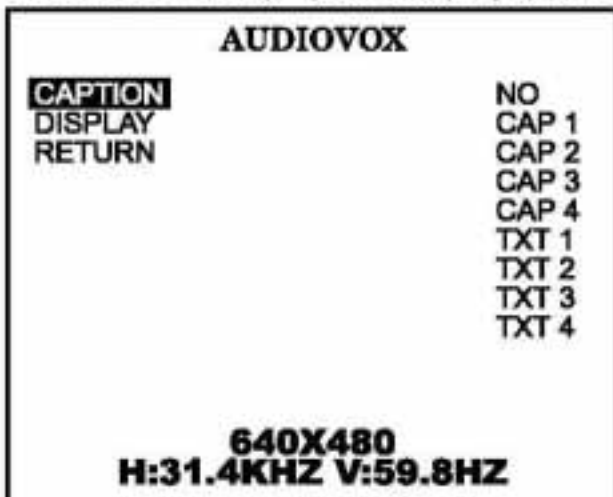

Press and release the *Menu/Select* button to select DISPLAY.

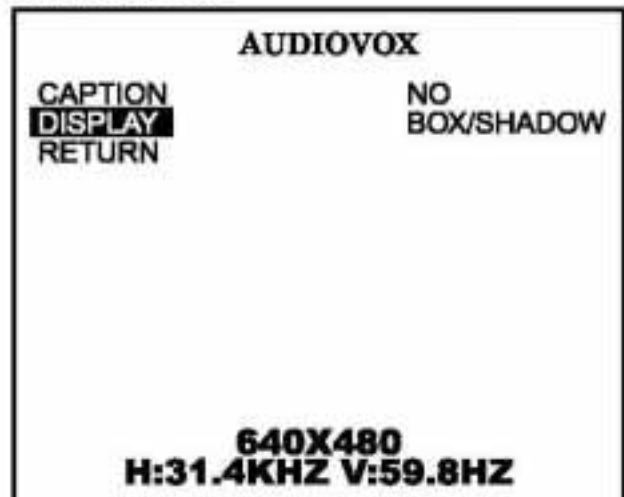

PARENT CONTROL

In the Main Menu, press and release the Down button(▼)to highlight PARENT CONTROL :



Using the number buttons to input the four-digit Parent Control Password and confirm using the *Menu/select* button (Default Code is 3308)

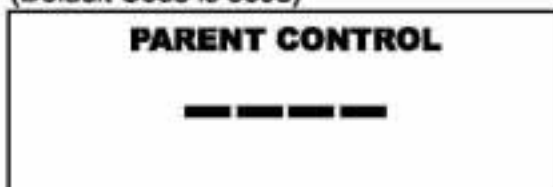

After entering the password the following menu will appear :

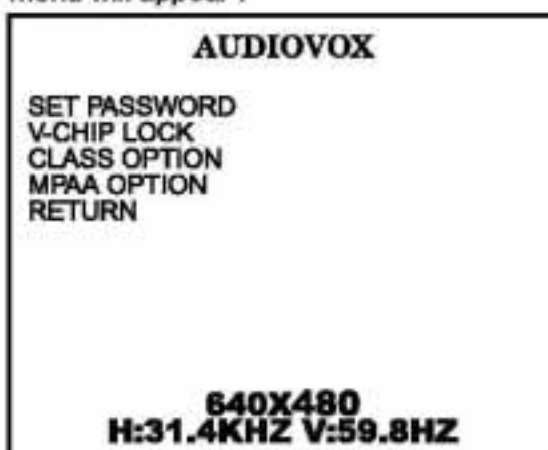

After accessing the Parent Control Menu, highlight SET PASSWORD and press and release the *Menu/Select* button. Then enter a 4-digit Password to change the Parental Control Menu Password if desired

PARENT CONTROL (Continued)

From the Parental Control Main Menu.

Press and release the Down button (▼) to highlight V-CHIP lock. Press and release the *Menu/Select* button :

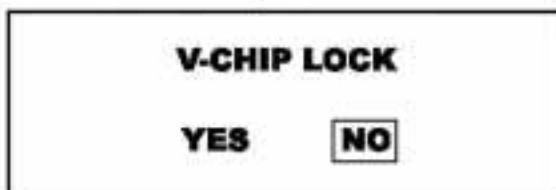

Enable the V-CHIP lock function by selecting YES and disable by selecting NO.

From the Parental Control Menu.

Press and release the Down button to (▼) highlight CLASS OPTION. Press and release the *Menu/select* button :

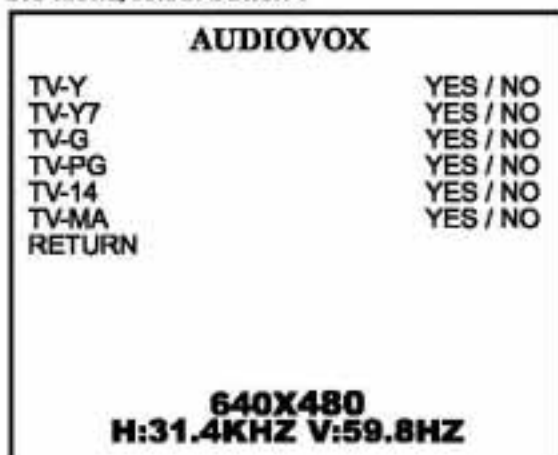

Select the desired age class and press and release the *Menu/Select* button.
Select RETURN to go back to the Parental Control Menu.

PARENT CONTROL (Continued)

PARENTAL CONTROL RATINGS

From the Parental Control Menu, press and release the Down button (▼) to highlight MPAA OPTION and press *Menu/Select* button.

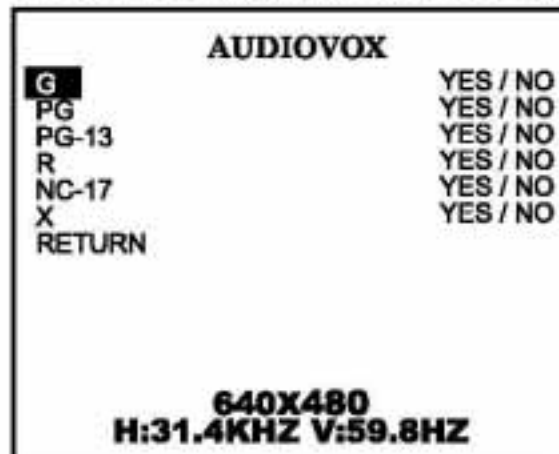

Select the desired rating level and press *Menu/Select* button. Select RETURN to return to the main Parental Control Menu.

CLASS OPTION

TV-Y	TV-14
TV-Y7	TV-MA
TV-G	Return
TV-PG	

MPAA OPTION

G	NC-17
PG	X
PG-13	RETURN
R	

OSD SETUP

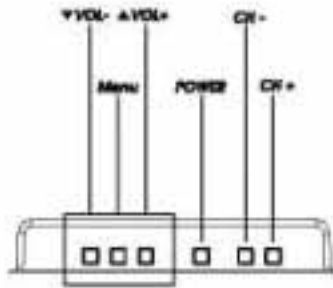

OSD SETUP

- 1.OSD Display Language - Select the language of the OSD
- 2.OSD Display Color- Select the color of text of the OSD
- 3.OSD Display Time-The user selected time period that the OSD displays (5,10,15 seconds)

Operations: Press the Up button (▲) or the Down button (▼) to select options and press the *Menu/Select* button to confirm.

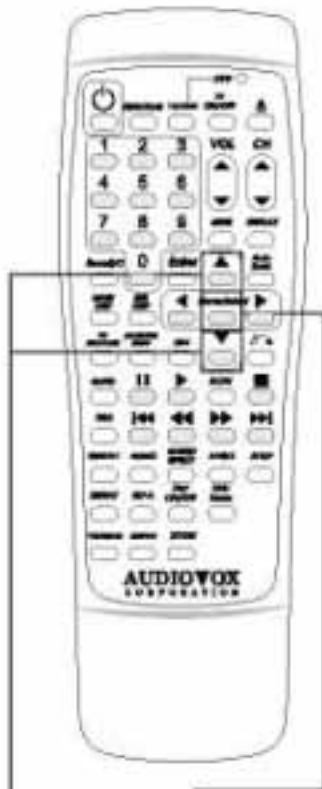

MENU/SELECT
Display the OSD menu and confirm function.

- FORWARD**
Press to go Up in menu selections.
- BACKWARD**
Press to go Down in menu selections.

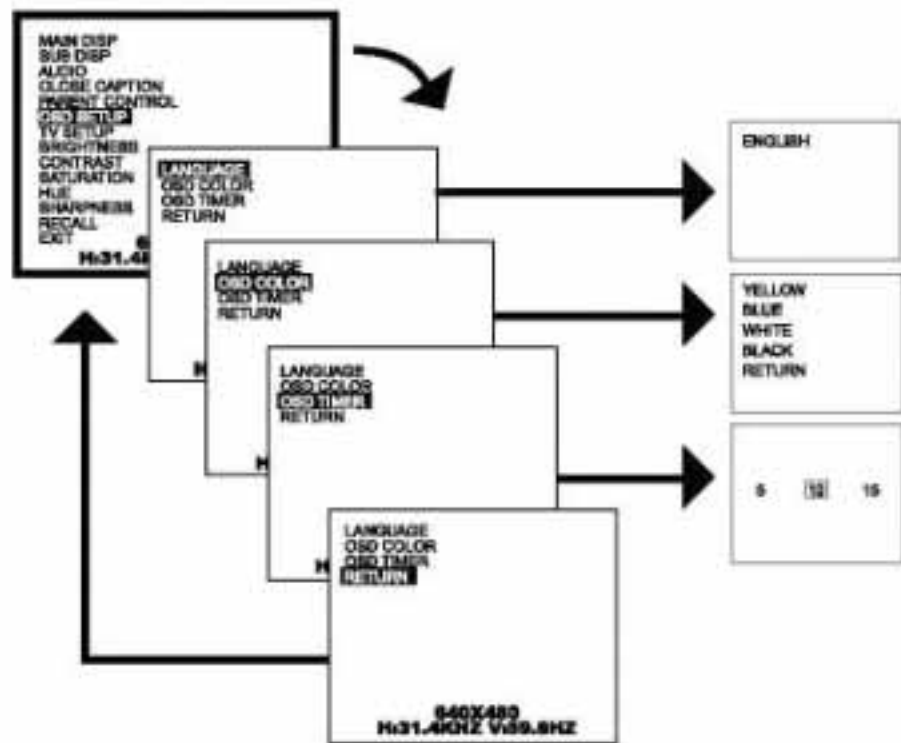

TV SETUP

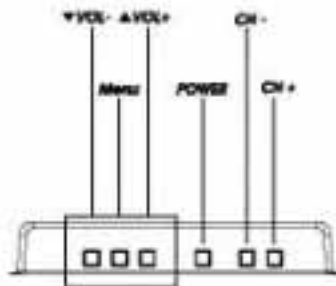

TV SETUP

You can choose cable standards.

ADD/ERASE : Add or Erase a TV or cable TV channel.

AUTO PROGRAM : Used to scan TV or CATV for valid channels and place it into memory

Operations: Press the Up button (▲) or the Down button (▼) to select options and press the Menu/select button to confirm.

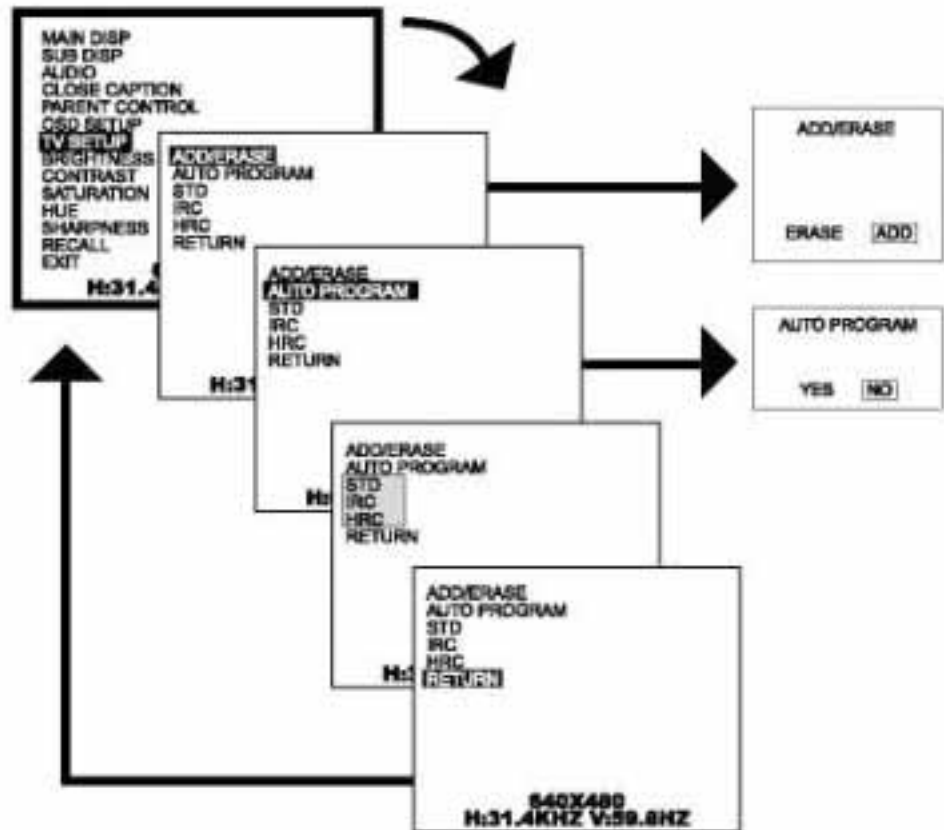
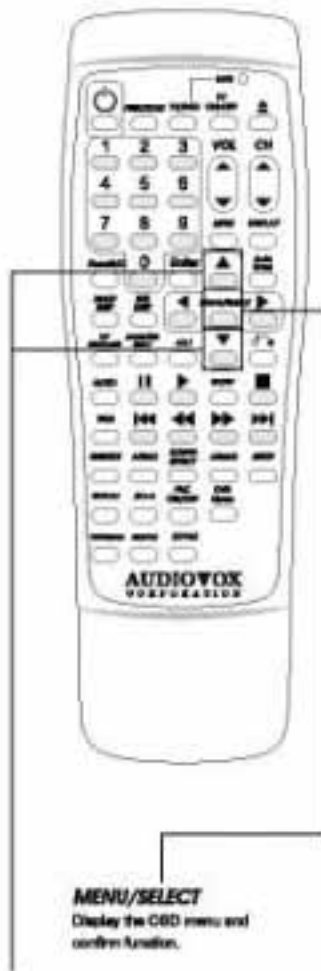

FORWARD

Press to go Up in menu selections.

BACKWARD

Press to go Down in menu selections.

NOTE:

The STD, HRC, IRC are local cable standards that is provided to you by your local cable company. If the Cable image or sound is very poor try changing to any one of the three cable systems and run AutoScan again. If the cable problem still persists please refer to the troubleshooting section.

PICTURE ADJUST (BRIGHTNESS/CONTRAST/SATURATION/HUE/SHARPNESS)

PICTURE ADJUST

You can adjust picture function.

Operations: Press the Up button (▲) or the Down button (▼) to select options and press the *Menu/select* button to confirm. Use the Up button (▲) or the Down button (▼) to adjust the various picture control bars.

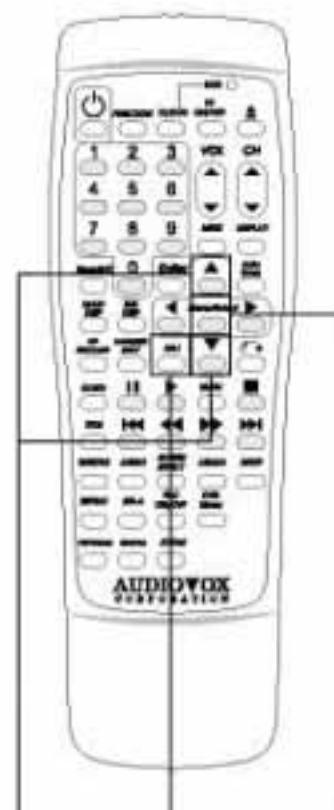
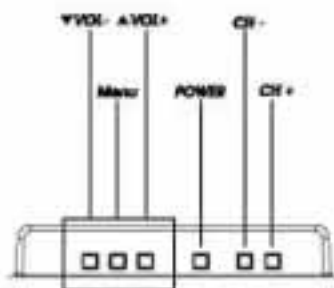

ADJ
Adjust the picture saturation, hue, brightness and contrast.

MENU/SELECT
Display the OSD menu and confirm function.

FORWARD
Press to go Up in menu selections.

BACKWARD
Press to go Down in menu selections.

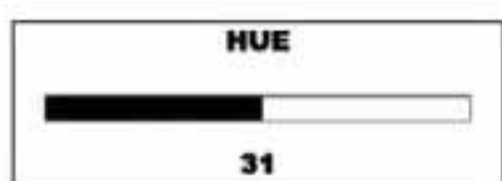
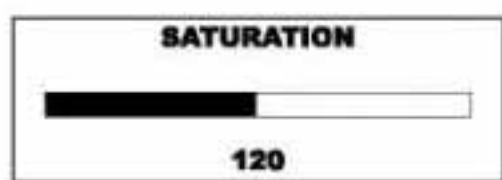
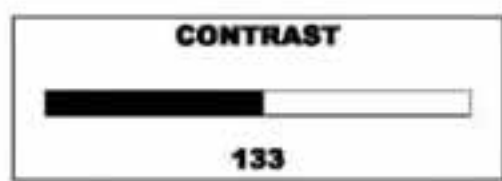
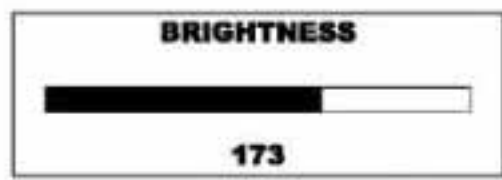

RECALL and EXIT

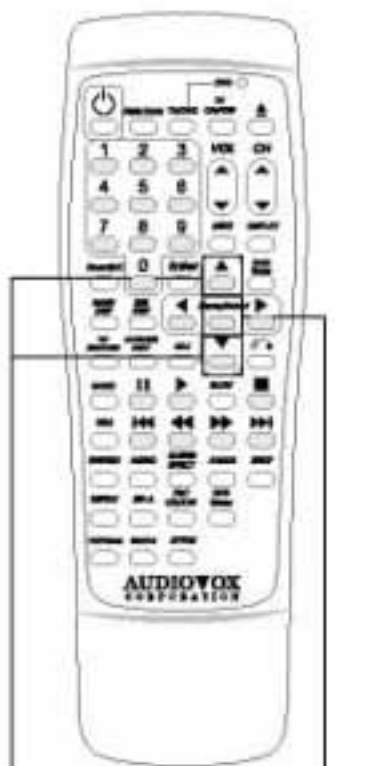
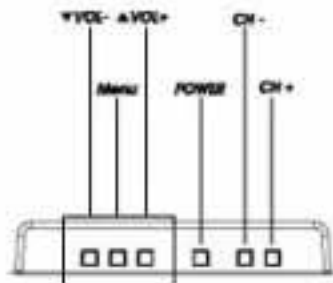

MENU/SELECT
Display the OSD menu and confirm function.

FORWARD
Press to go Up in menu selection.

BACKWARD
Press to go Down in menu selection.

RECALL

Automatically resets all settings back to factory default.

Operations: Press the Up button (▲) or the Down button (▼) to select options and press the Menu/select button to confirm.

OSD Option Display

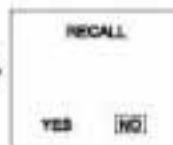

NOTE : Recall will not affect Parental Control settings.

EXIT

Exits the on-screen-menu.

Operations: Press the Up button (▲) or the Down button (▼) to select options and press the Menu/select button to confirm.



VGA INPUT SIGNAL AUTO TUNE AND SAVE EXIT

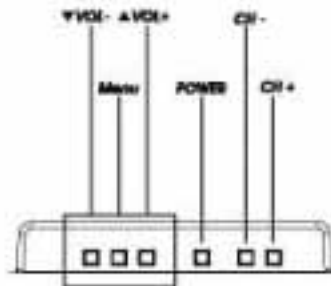

NOTE:

Refer to page 34 of this manual for instructions to switch to VGA MODE.

AUTO TUNE

Automatically adjusts picture quality of the VGA signal input.

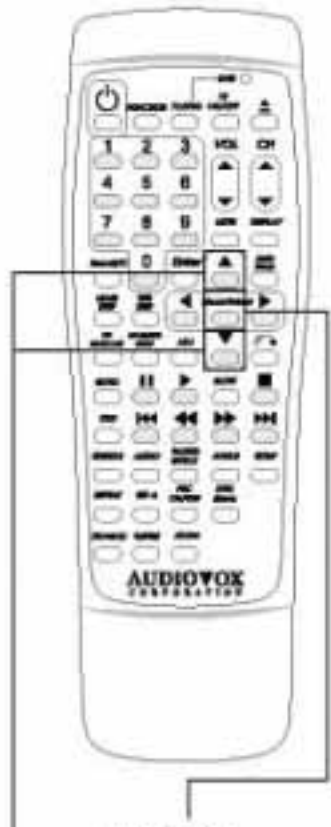

MENU/SELECT

Display the OSD menu and confirm function.

FORWARD

Press to go Up in menu selections.

BACKWARD

Press to go Down in menu selections.



Operations: Press the Up button (▲) or the Down button (▼) to select options and press the Menu/Select button to confirm.

SAVE EXIT

Save your settings then exit menu.



VGA INPUT SIGNAL COLOR SETUP

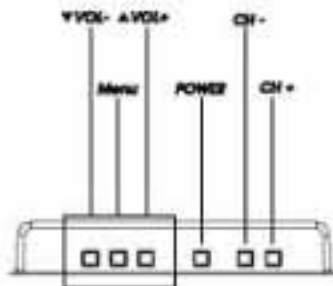

COLOR (Color temperature)

You can choose four color settings.

1. 9300 - The 9300 setting is more blue than 6550.
2. 7500 - The 7500 setting is less blue than 9300.
3. 6550 - The color temperature setting is standard.
4. USER - Increases or decreases Red, Green or Blue color depending upon which is selected.

Operations: Press the Up button (▲) or the Down button (▼) to select options and press the Menu/select button to confirm. Use the Up button (▲) or the Down button (▼) to adjust the various picture control bars.

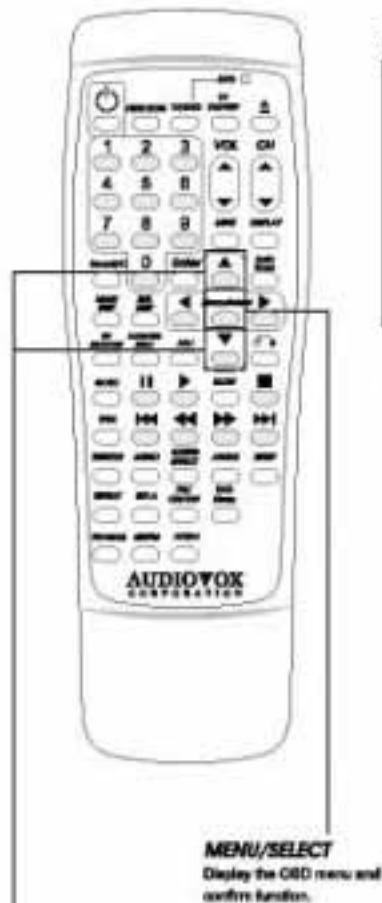

FORWARD
Press to go Up in menu selections.

BACKWARD
Press to go Down in menu selections.

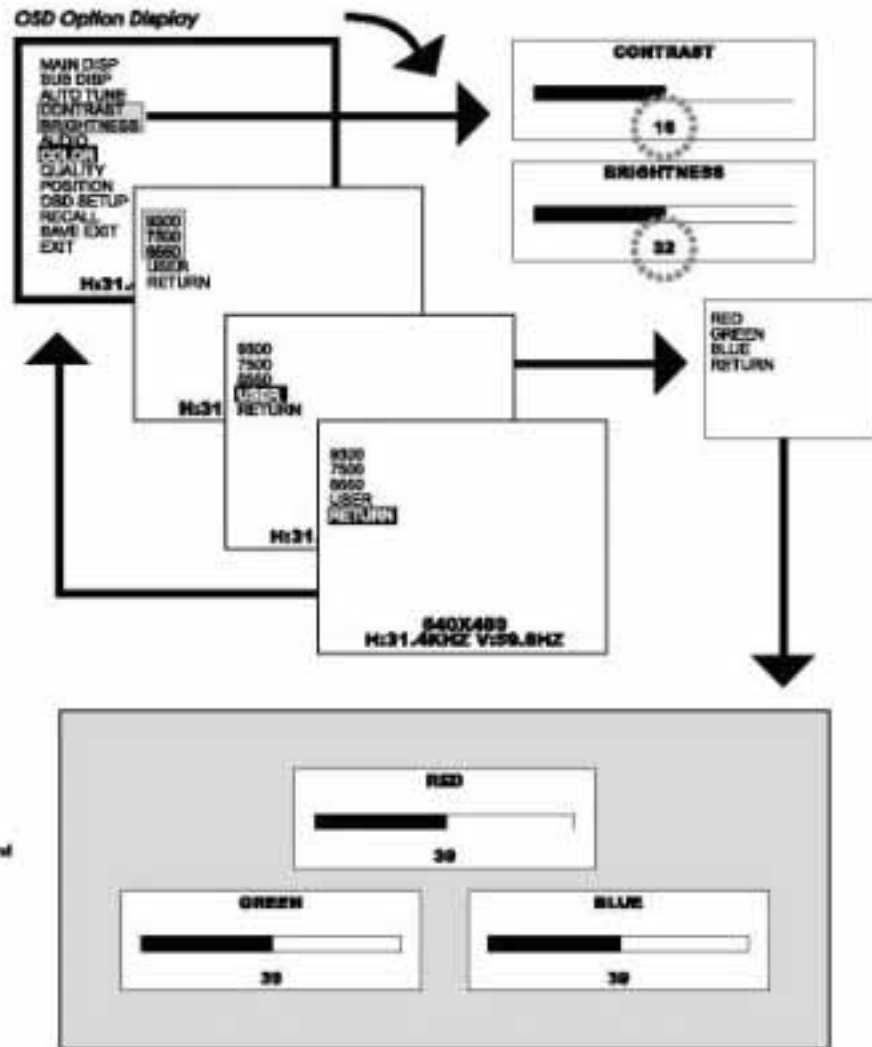

NOTE :

9300, 7500 and 6550 standards for this are preset at the factory.

VGA INPUT SIGNAL QUALITY ADJUST

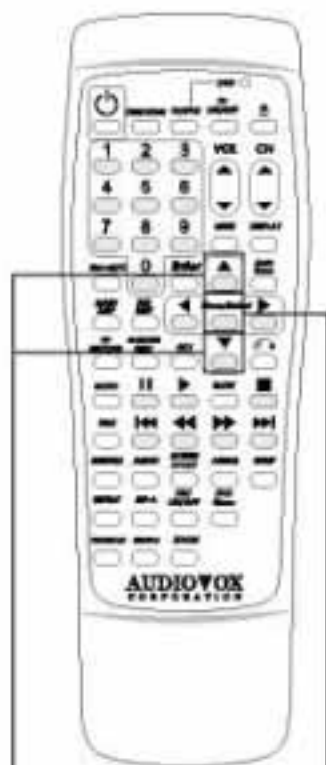
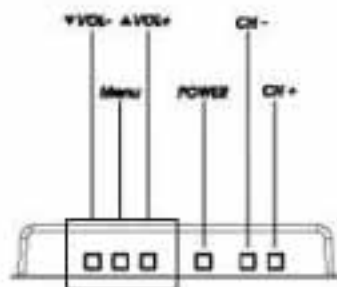

MENU/SELECT
Display the OSD menu and confirm function.

FORWARD

Press to go Up in menu selections.

BACKWARD

Press to go Down in menu selections.

QUALITY

You can adjust VGA input signal picture quality.

Operations: Press the Up button (▲) or the Down button (▼) to select options and press the Menu/Select button to confirm. Use the Up button (▲) or the Down button (▼) to adjust the various picture control bars.

OSD Option Display

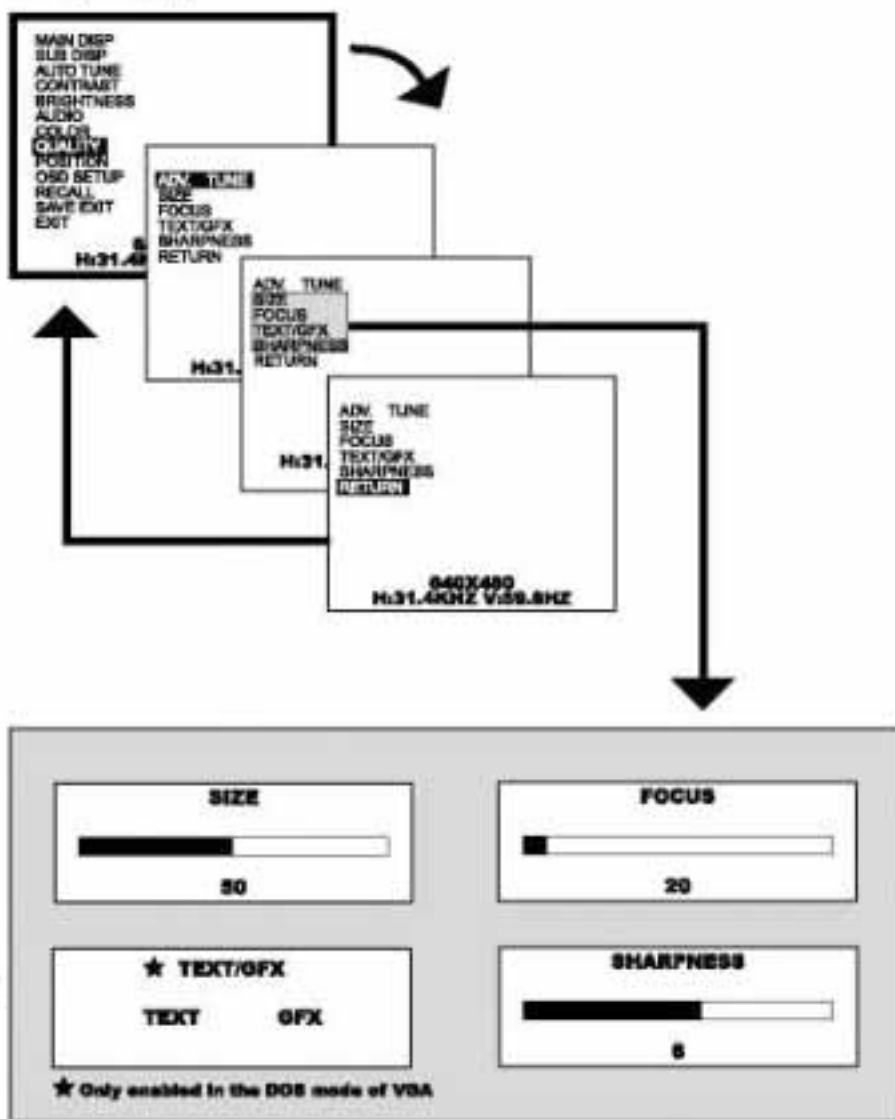

QUALITY

1. Advanced Tuning ADV. TUNE - Automatically adjusts image clarity and stability.
2. SIZE - Adjusts image size relative to the screen.
3. FOCUS - Controls image clarity.
4. TEXT/GFX - Adjusts text sharpness when PC is in DOS mode.
5. SHARPNESS - Adjusts image sharpness relative to the background.

VGA INPUT SIGNAL PICTURE POSITION SETUP

POSITION

You can choose where you would like the image/OSD position to appear on your screen.
You can also choose the osd display mode and speed.

Operations: Press the Up button (▲) or the Down button (▼) to select options and press the Menu/select button to confirm. Use the Up button (▲) or the Down button (▼) to adjust the various picture control bars.

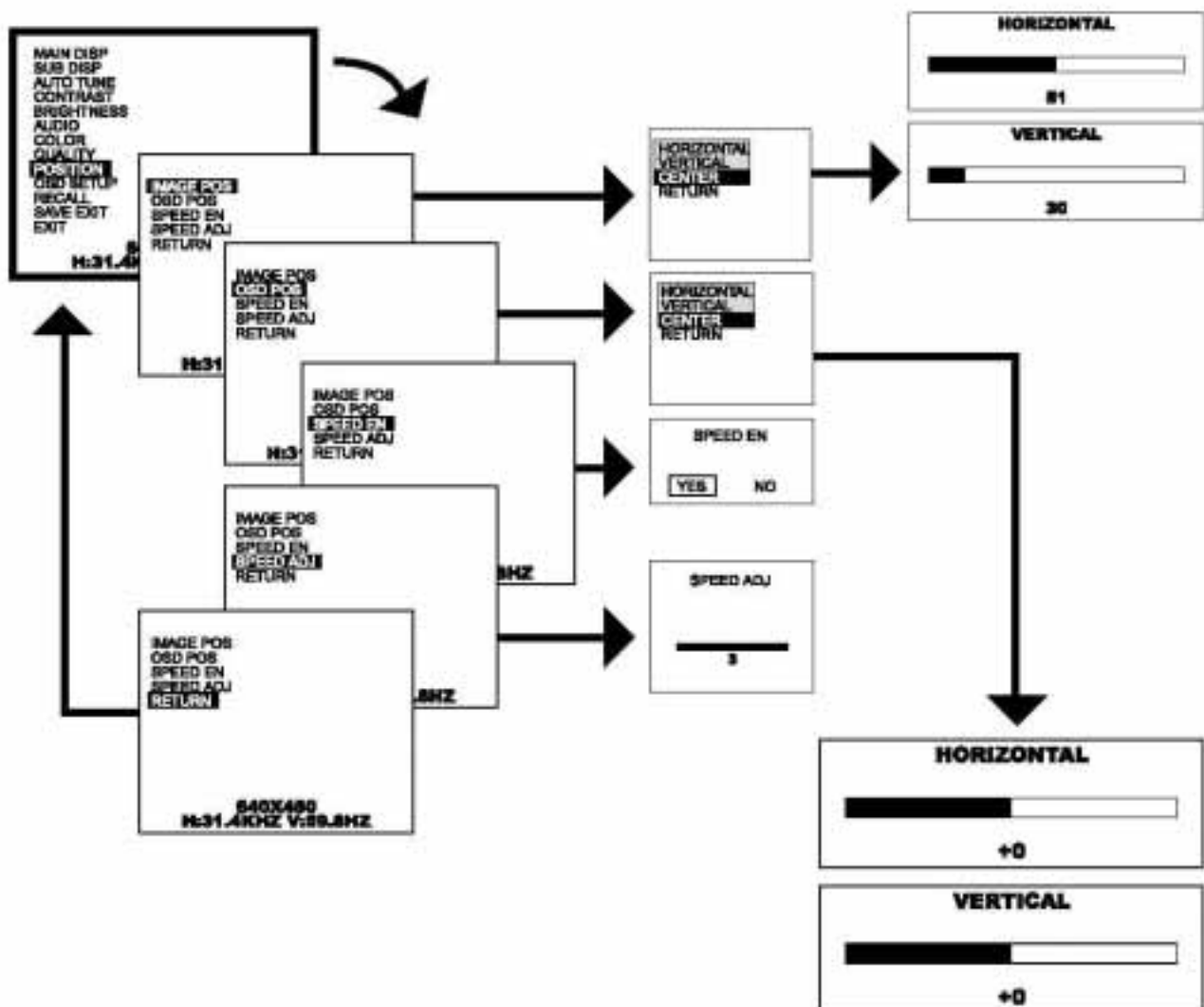

NOTE :

SPEED EN : Used to animate the OSD.

SPEED ADJ : Used to adjust the speed of the animation.

OPERATION

1. To enter FM MODE :

- (A) **Remote Control** : Press the **FUNCTION** button. The DVD player front panel function buttons will light
DVD → TV → FM.
- (B) **DVD Player Front Panel** : Press the **FM** button.

2. Change Channel

- (A) **Remote Control** : Press(**▶▶**)button to increase FM station. Press(**◀◀**)button to decrease FM station.
For example: When you listen to the radio FM 107.7 then press(**▶▶**)to go to FM 107.8.
- (B) **Front Panel** : Rapidly press(**▶▶** / **▶▶**)button to increase the FM station.
Rapidly press(**◀◀** / **◀◀**)button to backward decrease the FM station.

3. Auto-Scanning FM Channel

- (A) **Remote Control** : Press(**▶▶**)to scan stations in an upward direction.
Press(**◀◀**)button to scan stations in a downward direction.
- (B) **Front Panel** : Press and hold(**▶▶** / **▶▶**)button for about 3 seconds to scan in an upward direction.
Press and hold(**◀◀** / **◀◀**)button to scan in a downward direction.

4. Stop Auto-Scanning

- (A) **Remote Control** : Press(**■**)button to stop auto-scanning.
- (B) **Front Panel**: Press(**■**)button to stop auto-scanning.

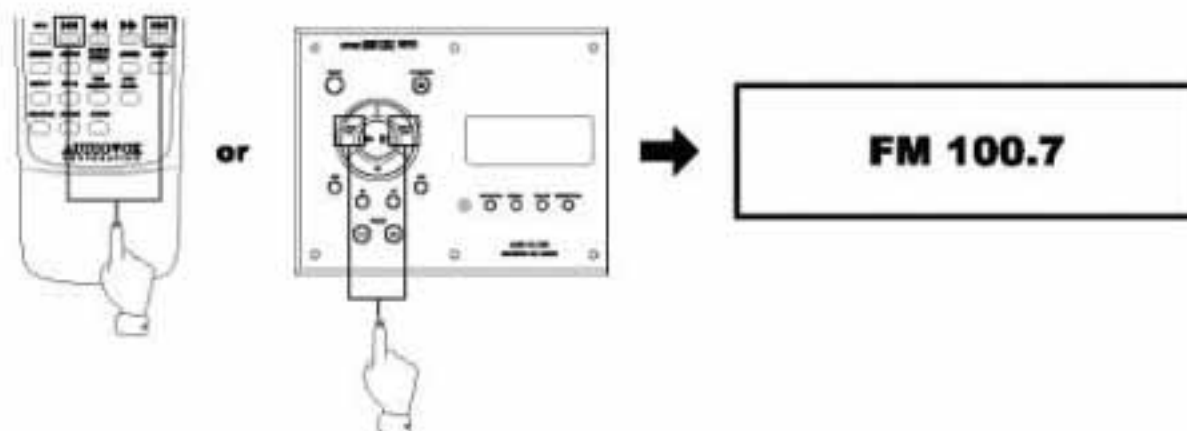
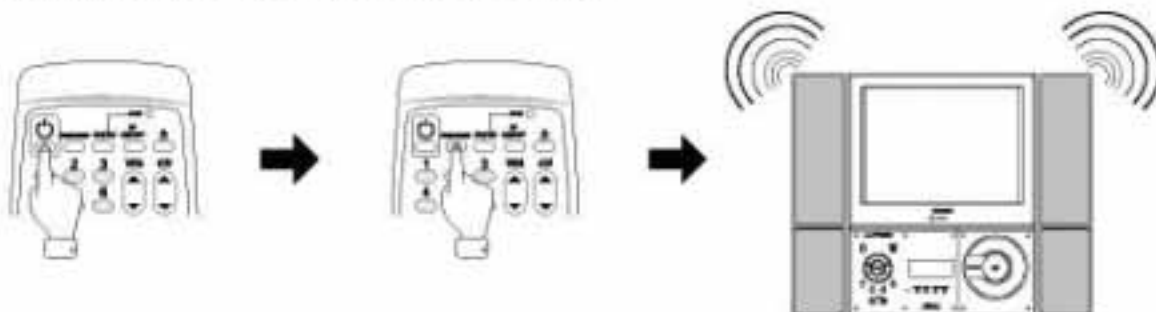

OPERATION (Continued)

Programming Preset Channels

This function can only be performed using the remote control :

1. Select an FM channel

Pressing by(▶▶) or(◀◀) to tune to your station.

For example: FM107.7

2. Program

(A) Press the **PROGRAM** button, the back-lighted panel will display the image below.

(B) Press(▶▶) or(◀◀) button to change the preset number.

For example: If you want to make FM 107.7 as the first Preset Channel, press(▶▶) or(◀◀) button, increasing or decreasing the preset number.

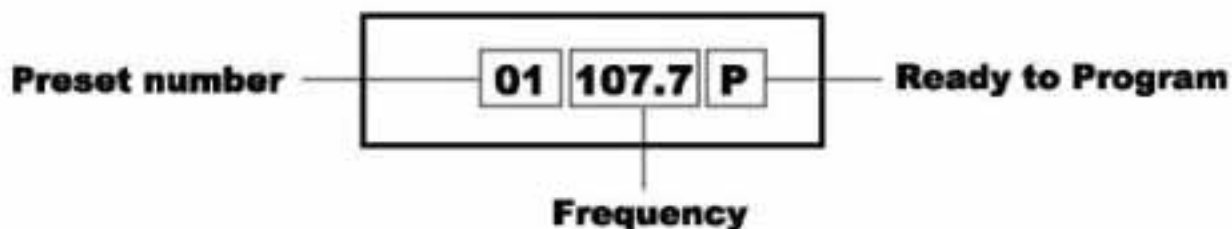

(C) Press **PLAY**(▶) button to complete the programming process.

3. Playing a Channel

Press the **PLAY**(▶) button one time, and the radio will tune to the first preset station.

Press the **PLAY**(▶) button two times, and the radio will tune to the second preset station.

NOTE:

If you programmed 2 different channels by the same code number, the original channel will be overwritten. The system can only memorize the latest programmed channel.

NOTE:

This unit has a total of 19 presets.

ADJUSTMENTS (Sound/Audio Frequency/Time)

DVD Player Front Panel Operation

Volume Adjustment

A. Press VOLUME \uparrow or VOLUME \downarrow to increase or decrease the volume.

GRAPHIC EQ (front panel) / **SOUND EFFECT** (Remote Control)

Press the appropriate button to change the effect.

(NORMAL → ROCK → CLASSIC → JAZZ → POP)

Setting the Clock

Press **CLOCK/TIMER** button on the DVD Player Front Panel

CLOCK → ALARM → SLEEP.

A. Press **CLOCK/TIMER** button until the back-lighted display appears in 12 hours format.

B. Press **TIME SET** button. Now the "Hour" display begins to flicker.

Press($\leftarrow\leftarrow\leftarrow\leftarrow$ / $\rightarrow\rightarrow\rightarrow\rightarrow$)to adjust "Hour" display.

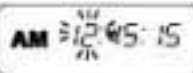

C. Press **TIME SET** button time. Now the "Minute" display begins to flicker.

Press($\leftarrow\leftarrow\leftarrow\leftarrow$ / $\rightarrow\rightarrow\rightarrow\rightarrow$)to adjust "Minute" display.

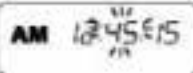

D. Press **TIME SET** button. Now the "Second" display begins to flicker.

Press($\leftarrow\leftarrow\leftarrow\leftarrow$ / $\rightarrow\rightarrow\rightarrow\rightarrow$)to adjust "Second" display.



E. Press **TIME SET** button to complete the Clock /Timer Adjustment process.



Setting the Alarm

NOTE : ALARM is used to turn on the unit at a specific time.

1 Alarm Setting

A. Press **CLOCK/TIMER** button until the Front Panel Display **ALARM**.

B. Press **TIME SET** button. Now the "Hour" display begins to flicker.

Press($\leftarrow\leftarrow\leftarrow\leftarrow$ / $\rightarrow\rightarrow\rightarrow\rightarrow$)to set "Hour" display.



C. Press **TIME SET** button the second time. Now the "Minute" display begins to flicker.

Press($\leftarrow\leftarrow\leftarrow\leftarrow$ / $\rightarrow\rightarrow\rightarrow\rightarrow$)to set "Minute" display.

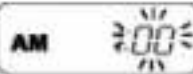

D. Press **TIME SET** button, the back-lighted display will appear **ALARM**.

Then press and hold the **PLAY**(\blacktriangleright)button for 3 seconds, the Front Panel Display will appear  (Alarm Symbol) .

E. The **ALARM** Setting process is completed.

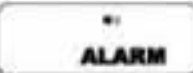

2 Cancel Alarm Setting:

A. Press **CLOCK/TIMER** button until the back-lighted displays **ALARM**.

B. Press **TIME SET** button until **ALARM** appears. Pressing the **STOP**(\blacksquare)button for 3 seconds.

The alarm  symbol will disappear. The **ALARM** Setting is canceled.

Adjustment (Continued)

SLEEP

The System will shut Off at the preset Shut Off Time.

1 Sleep Setting:

- A. Press CLOCK/TIMER button until the Front Panel Display appears SLEEP.
- B. Press TIME SET button to choose the time period that the unit will shut off.

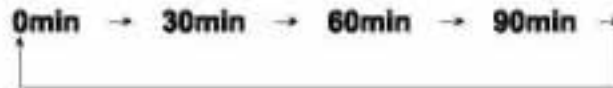

- C. Press and hold the PLAY(▶) button for few seconds. The back-lighted panel will display the SLEEP symbol.
The Sleep Setting process is completed.

2 Cancel Sleep Setting:

- A. Press CLOCK/TIMER button until the back-lighted display shows SLEEP.
- B. Press TIME SET button and then press STOP(■) button for few seconds.
The SLEEP symbol will disappear. The SLEEP Setting is canceled.

TROUBLESHOOTING

Before requesting service for this unit, check the chart below for a possible cause of the problem you are experiencing. Some simple checks or a minor adjustment on your part may eliminate the problem and restore proper operation. If you are in doubt about some of the check points, or if the remedies indicated in the chart do not solve the problem, consult your dealer.

DVD OPERATION

Symptom	Diagnosis/Solution
When the playback button is pressed, playback does not begin	<ul style="list-style-type: none">*Is there condensation? (let sit for 4 - 5 hours)*Have you inserted a disk other than a DVD or Music CD? (If you have please remove it)*Is the disc dirty? (Wipe it clean)*Is the CD inserted correctly (Please verify the label is facing outward)
No sound, or sound is disabled	<ul style="list-style-type: none">* Is mute activated? (Press the mute button on the remote)* Are all cables connected correctly? (verify all Audio/ Video cables are firmly connected)*When connected to an external AMP, set the SPDIF output to *ON* (see AUDIO SETUP)
Buttons cannot be operated	<ul style="list-style-type: none">* If buttons do not operate at all, try turning the power supply button of the main unit "off" and "On"* Is operation forbidden? (Command may not be allowed on that disc)* If the button is suppose to work but does not, try and turn OFF and ON the main power.
Playback does not start even when a title is selected	<ul style="list-style-type: none">* Some titles cannot be played back viewing restrictions have been set. (See Parent Control section).
The disc is hot when it is removed	<ul style="list-style-type: none">* This is not a problem.
Subtitles do not appear	<ul style="list-style-type: none">* Subtitles are not recorded on the DVD.
The angle view cannot be changed	<ul style="list-style-type: none">* Even with a DVD, switching cannot be done at points where multi-angle is not stored.
DVD setup screen freezes up	<ul style="list-style-type: none">* Hit the SETUP button to try and cancel the screen* If no button is functioning unplug the unit and wait 10 seconds before plugging it back in.*Try and reset the firmware. Turn off the power and on the top of the unit press and hold the VOL+ and hit the Power button. Once you see the Volume increasing on the video monitor release the VOL+ button.*If this occurs frequently, please contact your dealer

Troubleshooting (Continued)

For TV broadcasts

Symptom	Diagnosis / Solution
Power does not go on	<ul style="list-style-type: none"> *Is the power supply unplugged from the wall outlet? (Make sure it is firmly inserted into the wall outlet) *Is the DC IN on the base unit firmly connected? *Is the DC OUT on the base unit firmly connected? *Is the DC IN on the TV section firmly connected?
Image shakes, or image is unclear	<ul style="list-style-type: none"> *Is there degeneration, breakage or disconnection of the antenna or antenna wire? *Is the antenna wire connected correctly?
There are spots on the picture, or the screen shakes	<ul style="list-style-type: none"> *Is the system affected (by radio wave interference or induced electromagnetic waves) by external sources (automobile or trains, high-voltage wires, neon, motors, magnetized steel frame, etc.)? <p>Turn off the power supply and try changing the equipment setup location.</p>
The image appears distorted	<ul style="list-style-type: none"> *The antenna direction shifted? *Are reflective electromagnetic waves being received from mountains or buildings?
A color pattern appears, or colors disappear	<ul style="list-style-type: none"> *Is the equipment being affected by another TV (electromagnetic interference)? <p>Changing the TV location may cause improvement.</p>
When the image is not stable, the screen turns completely BLACK for a period of time	<ul style="list-style-type: none"> *This occurs when the signal for driving the video monitor is lost, and is not a malfunction.
The screen goes dark momentarily when the channel is changed.	<ul style="list-style-type: none"> *The screen is dark for a moment to conceal noise generated when changing channels.
Unable to Receive broadcasting	<ul style="list-style-type: none"> * Change cable system standard(SRD, IRC, HRC) (Image not clean change Cable Standard) * To change the cable standard select MENU/SELECT button to enter the TV OSD. select TV SETUP and select the CABLE standard that your cable provider is providing to you. * If you do not know the cable standard please contact your cable provider.

Troubleshooting (Continued)

Miscellaneous

Remote control cannot be operated	<ul style="list-style-type: none"> * Is battery exhausted, or is battery polarity wrong? * Are you using a universal remote? (The unit will not operate with another remote other than the one supplied from the manufacturer).
Image on Screen is Distorted	<ul style="list-style-type: none"> * The cause might be from a poor power connection to the unit. (Verify when you put the unit together that the DC power connector was connected to the unit first before plugging the AC adapter into the outlet). * Unplug the AC adapter from the wall and reinsert after 10 seconds to resolve.
Unit does not Function as Per User Manual	<ul style="list-style-type: none"> * Reset The Unit: <ol style="list-style-type: none"> (1) Turn OFF the unit (Verify that the top and button light are red, indicating they are OFF). (2) ONLY from the top of the unit, (Do Not Use Remote) press and hold the VOL + button. (3) Quickly press and release the power button. (Green light will lite) (4) Continue to press and hold the VOL + button until the volume numbers start to increase on the TV. (5) Power OFF the TV with the TV POWER button on the top of the unit. (6) Wait 5 seconds and hit the main POWER button to turn on the DVD and TV together. <p>(NOTE: The first time you power up the unit, it needs 10 seconds to fully initialize. Do not touch any buttons).</p> * If unit does not respond Pull power and wait 10 seconds before inserting power.
TV is OFF and there is still sound	This is a known issue and is part of the design. (The DVD base unit needs to be powered OFF).
TV unit is turned on and there is NO picture image stays black	Once power is not going to the TV section, it acts as an independent unit. The TV section needs a response from the base unit to initialize. (Press the function button (DVD, TV, FM, AUX) on the base to initialize).

Frequently asked questions (Q&A)

Question	Answer
Can I do video recording?	*Almost all DVD discs have copy protection so recording is not possible.
Can I playback discs with no region number?	*The region number indicates that the disc confirms to the DVD standard. *Discs which do not comply with the standard cannot be played.
Sound volume seems lower than TV or radio, etc	*Dolby digital audio signals have a wide dynamic range (i.e., the range between high and low volume) so in general volume seems to sound low.
Can I playback DVDs purchased abroad?	*If the region number contains "ALL" or "1" and the format is NTSC, it can be played back.
Can I playback videos or CDs purchased overseas?	*They can be played back if they are in NTSC format.

Function List :

TELEVISION	Support TV System NTSC
	Support CATV 125 Channels STD/IRC/HRC (for North America)
	Support AIR TV VHF/UHF
	Automatically scan TV channels
	Use High-brightness TFT-LCD monitor 350 cd/m ² .
	OSD (On-Screen-Display) setting
	VOV (Video-On-Video) display function
	Support caption function
LCD Monitor	OSD adjustment function
	Multi-input signals
	Maximum high-resolution XGA 1024*768
	DB-15 RGB input(VGA)
	Auto-tune input signal function
	Definition 9300 ⁷ temperature
DVD Player	DVD/JEPG/Picture - CD/MP3/Compact Disc
	Composite A-Video, S-Video function
	Digital Output System for Dolby 5.1 channel and DTS 5.1 output
	OSD (On-Screen-Display) and program function
	Analog Dolby Pro Logic /DTS 2 channel output
	Built-in NTSC/PAL system decode function
FM Tuner	Auto-Scanning
	19 Presets
AUX	Choose external multi-device input(S -Video, A-Video or VGA)
Clock Setting	Clock display function
Timer Setting	12 hours mode setting, Alarm mode, Sleep mode
Input Connection	TV antenna input
	FM antenna input
	DC connector input (12V 5.0A max. (60w max)
	S-Video signal input
	DB-15 VGA signal input
	A-Video signal input
	MINI DIN output (By manufacturer define)

Accessories

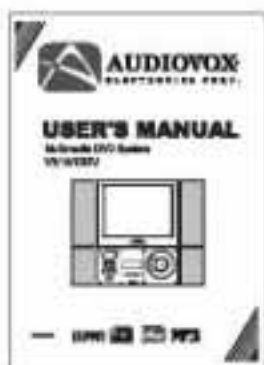

User Manual



Remote Control

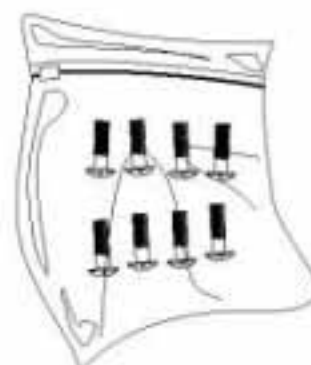

Hardware Kit

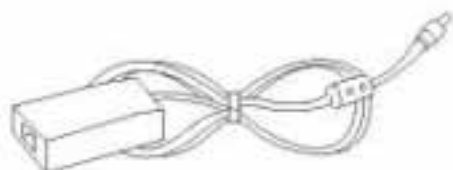

Power Transformer Cord



Power Cord



S-Video Cable
(4 PIN) 



MINI DIN Cable
(8 PIN) 



DC to DC Cable



VGA Cable



FM ANT Cable



BATTERY

(FDA)CERTIFICATION

POWER CONSUMPTION	60W(POWER ON), 10W(STAND BY)
WEIGHT	10Kg
DIMENSION	
OPERATION ENVIRONMENT	576mm(W)x487mm(H)x192mm(D)
TEMPERATURE	5-50°C
HUMIDITY	5-90%(NO CONDENSATION)
STORAGE ENVIRONMENT	
TEMPERATURE	5-50°C
HUMIDITY	5-90%(NO CONDENSATION)

Radiant Power from DVD Laser Diode	0.688 uW
Radiant Power from CD Laser Diode	1.24 uW
Radiant Power on surface	Meet FDA Class I
Operation and Storage Environment	
Temperature	5-50°C
Humidity	5-90%(No condensation)



90 DAY LIMITED WARRANTY

Applies to Audiovox Video Products

AUDIOVOX ELECTRONICS CORP. (the Company) warrants to the original retail purchaser of this product that should this product or any part thereof, under normal use and conditions, be proven defective in material or workmanship within 90 days from the date of original purchase, such defect(s) will be repaired or replaced with reconditioned product (at the Company's option) without charge for parts and repair labor.

To obtain repair or replacement within the terms of this Warranty, the product is to be delivered with proof of warranty coverage (e.g. dated bill of sale), specification of defect(s), transportation prepaid, to the Company at the address shown below.

This Warranty does not extend to the elimination of externally generated static or noise, to correction of antenna problems, to costs incurred for installation, removal or reinstallation of the product, or to damage to tapes, discs, speakers, accessories, or electrical systems.

This Warranty does not apply to any product or part thereof which, in the opinion of the Company, has suffered or been damaged through alteration, improper installation, mishandling, misuse, neglect, accident, or by removal or defacement of the factory serial number/bar code label(s). THE EXTENT OF THE COMPANY'S LIABILITY UNDER THIS WARRANTY IS LIMITED TO THE REPAIR OR REPLACEMENT PROVIDED ABOVE AND, IN NO EVENT, SHALL THE COMPANY'S LIABILITY EXCEED THE PURCHASE PRICE PAID BY PURCHASER FOR THE PRODUCT.

This Warranty is in lieu of all other express warranties or liabilities. ANY IMPLIED WARRANTIES, INCLUDING ANY IMPLIED WARRANTY OF MERCHANTABILITY, SHALL BE LIMITED TO THE DURATION OF THIS WRITTEN WARRANTY. ANY ACTION FOR BREACH OF ANY WARRANTY HEREUNDER INCLUDING ANY IMPLIED WARRANTY OF MERCHANTABILITY MUST BE BROUGHT WITHIN A PERIOD OF 30 MONTHS FROM DATE OF ORIGINAL PURCHASE. IN NO CASE SHALL THE COMPANY BE LIABLE FOR ANY CONSEQUENTIAL OR INCIDENTAL DAMAGES FOR BREACH OF THIS OR ANY OTHER WARRANTY, EXPRESS OR IMPLIED, WHATSOEVER. No person or representative is authorized to assume for the Company any liability other than expressed herein in connection with the sale of this product.

Some states do not allow limitations on how long an implied warranty lasts or the exclusion or limitation of incidental or consequential damage so the above limitations or exclusions may not apply to you. This Warranty gives you specific legal rights and you may also have other rights which vary from state to state.

U.S.A.: AUDIOVOX ELECTRONICS CORPORATION, 150 MARCUS BLVD., HAUPPAUGE, NEW YORK 11788 / 1-800-645-4994

CANADA: CALL 1-800-645-4994 FOR LOCATION OF WARRANTY STATION SERVING YOUR AREA

Free Manuals Download Website

<http://myh66.com>

<http://usermanuals.us>

<http://www.somanuals.com>

<http://www.4manuals.cc>

<http://www.manual-lib.com>

<http://www.404manual.com>

<http://www.luxmanual.com>

<http://aubethermostatmanual.com>

Golf course search by state

<http://golfingnear.com>

Email search by domain

<http://emailbydomain.com>

Auto manuals search

<http://auto.somanuals.com>

TV manuals search

<http://tv.somanuals.com>