

EXS9005

SPREAD SPECTRUM



uniden
Operating Guide

UDZZ01838ZZ

900 MHz Cordless Extend-A-Phone®

Precautions

Before you read anything else, please observe the following:

Warning!

Uniden America Corporation **DOES NOT** represent this unit to be waterproof. To reduce the risk of fire, electrical shock, or damage to the unit, **DO NOT** expose this unit to rain or moisture.

Rechargeable Nickel-Cadmium Battery Warning

- This equipment contains a Rechargeable Nickel-Cadmium Battery.
- Cadmium is a chemical known to the State of California to cause cancer.
- The Rechargeable Nickel-Cadmium Battery contained in this equipment may explode if disposed of in a fire.
- **Do not** short-circuit the battery.
- **Do not** charge the Rechargeable Nickel-Cadmium Battery used in this equipment in any charger other than the one designed to charge this battery as specified in this Guide. Using another charger may damage the battery or cause the battery to explode.

Rechargeable Nickel-Cadmium Batteries Must Be Recycled or Disposed of Properly

- Residents of Minnesota should contact 1-800-225-PRBA for information concerning reclamation and disposal of Rechargeable Nickel-Cadmium Batteries.
- Residents outside of Minnesota should contact their local authorities for information concerning reclamation and disposal of Rechargeable Nickel-Cadmium Batteries.



The exclamation point within an equilateral triangle is intended to alert the user to the presence of important operating and maintenance (servicing) instructions in the literature accompanying the appliance.

Controls and Keys

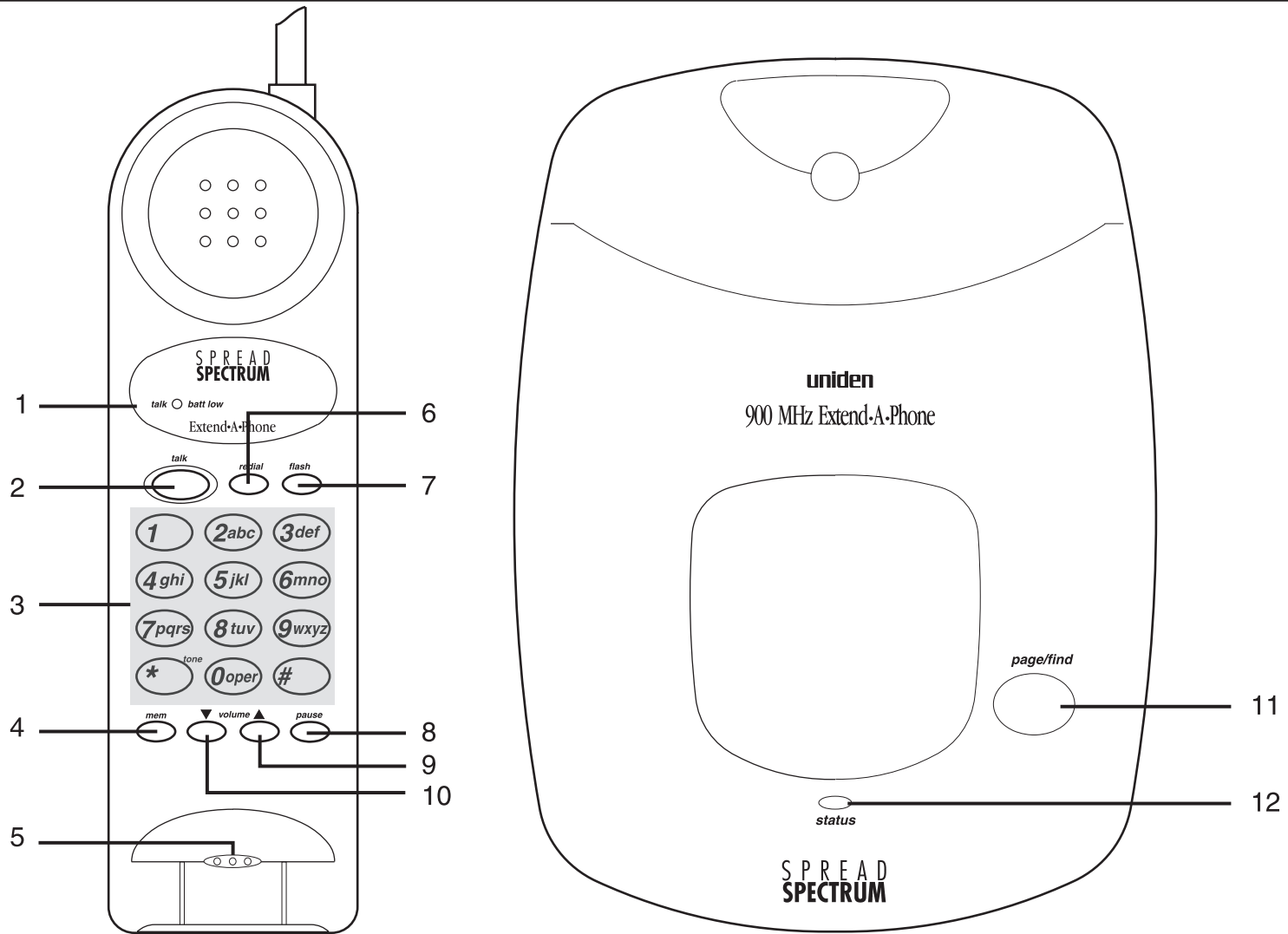

1. Talk/Batt Low Indicator – **talk • batt low**
2. Talk Key – **talk**
3. Numeric Keypad
4. Memory Key – **mem**
5. Microphone
6. Redial Key – **redial**

7. Flash Key – **flash**
8. Pause Key – **pause**
9. Volume Up (**volume ▲**)
10. Volume Down (**volume ▼**)
11. Page/Find Key – **page/find**
12. Charge LED Indicator – **status**

Contents

Important Safety Instructions	2
Introduction	4
Features	4
Included with the EXS9005	5
Important Electrical Considerations	6
Range	6
Telephone Line Problems	6
Radio Interference	7
More Than One Cordless Telephone	7
Installation	8
Selecting a Location	8
Telephone Line Outlets	8
Connecting the Telephone Cords	8
Applying Power to the Base Unit	9
Adapter Safety Feature	9
Desk or Tabletop Installation	10
Wall Installation	12
Direct Wall Mounting	14
Setting Up Your Phone	17
Raising the Antenna	17
Installing the Handset Battery Pack	17
Charging the Battery Pack	18
Low Battery Indicator	19
Cleaning the Battery Contacts	20
Setting the Pulse/Tone Switch	20
Adjusting Ringer Controls	21
Changing the Beltclip	22
Using Your Phone	23
Making and Receiving Calls	23
Flash and Page/Find	23
Programming Your Phone	24
Storing a Number in Memory	24
Storing a Mixed Number	25
Dialing a Stored Number	27
Chain Dialing	28
Erasing a Stored Number	28
Troubleshooting	29
Specifications	30
One Year Limited Warranty	31

Important Safety Instructions

When using your telephone equipment, these basic safety precautions should always be followed to reduce the risk of fire, electrical shock, and injury to persons:

1. Read and understand all instructions.
2. Follow all warnings and instructions marked on the product.
3. Unplug this product from the wall outlet before cleaning. Use a dry cloth for cleaning without liquid or aerosol cleaners.
4. Do not use this product near water; for example, near a bath tub, wash bowl, kitchen sink or laundry tub, in a wet basement, or near a swimming pool.
5. Do not place this product on an unstable cart, stand, or table. The telephone may fall, causing serious damage to the unit.
6. Slots and openings in the cabinet and the back or bottom are provided for ventilation. To protect the product from overheating, these openings must not be blocked or covered. This product should never be placed near or over a radiator or heat register. This product should not be placed in a built-in installation unless proper ventilation is provided.
7. This product should be operated only from the type of power source indicated on the marking label. If you are not sure of the type of power supply to your home, consult your dealer or local power company.
8. Do not allow anything to rest on the power cord. Do not locate this product where the cord will be damaged by persons walking on it.
9. Do not overload wall outlets and extension cords, as this can result in the risk of fire or electrical shock.
10. Never push objects of any kind into this product through cabinet slots, as they may touch dangerous voltage points or short out parts that could result in a risk of fire or electric shock. Never spill liquid of any kind on the product.
11. To reduce the risk of electric shock, do not disassemble this product. Take it to qualified service personnel when service or repair work is required. Opening or removing covers may expose you to dangerous voltages or other risks. Incorrect reassembly can cause electric shock when the appliance is subsequently used.

12. Unplug this product from the wall outlet and refer servicing to qualified service personnel under the following conditions:
 - A. When the power supply cord is damaged or frayed.
 - B. If liquid has been spilled into the product.
 - C. If the product has been exposed to rain or water.
 - D. If the product does not operate normally when following the operating instructions. (Adjust only those controls that are covered by the operating instructions. Improper adjustment of other controls may result in damage and will often require extensive repair work by a qualified technician.)
 - E. If the product has been dropped or the cabinet has been damaged.
 - F. If the product exhibits a distinct change in performance.
13. Do not use the telephone to report a gas leak in the vicinity of the leak.

Battery Safety Precautions

Caution: To reduce the risk of fire or injury to persons by the battery, read and follow these instructions:

1. Use only the appropriate type and size Battery Pack specified in this Operating Guide.
2. Do not dispose of the Battery Pack in a fire. The cell may explode. Check the Nickel-Cadmium Battery Disposal package insert for disposal instructions.
3. Do not open or mutilate the Battery Pack. Released electrolyte is corrosive and may cause damage to the eyes or skin. It may be toxic if swallowed.
4. Exercise care in handling the battery in order not to short the battery with conducting materials such as rings, bracelets, and keys. The battery or conductor may overheat and cause burns.
5. Charge the Battery Pack provided with or identified for use with this product only in accordance with the instructions and limitations specified in the instruction manual provided for this product.
6. Observe proper polarity orientation between the Battery Pack and battery charger.

SAVE THESE INSTRUCTIONS!

Introduction

Congratulations on your purchase of the Uniden EXS9005 Cordless Telephone. This phone is designed to exacting standards that provide reliability, long life, and outstanding performance.

Features

- 900 MHz Long-range
- Digital Spread Spectrum Technology
- 20 Channel Autoscan
- UltraClear Plus
- AutoTalk™
- 20-Number Memory
- Redial, Flash and Pause
- AutoSecure™
- Pulse/Tone Dialing
- AutoStandby™
- 1-way Page/Find Button
- 7 Day Battery Life

AutoTalk™ allows you to answer a call by just removing the Handset from the Base Unit so you don't have to waste time pushing buttons or flipping switches. *AutoStandby™* allows you to hang up by simply returning the Handset to the Base Unit.

The *UltraClear Plus* compander circuitry virtually eliminates background noise and provides you with the best possible reception during all of your conversations.

Auto Channel Scan - During a call, your EXS9005 constantly monitors the noise levels of the channel. If the channel becomes too noisy, the unit automatically switches to a clearer channel to maintain the best transmission quality.

Spread Spectrum Technology provides a digital link between the Base Unit and Handset. This results in better security, virtually eliminating any chance of outside monitoring, and improves noise reduction for top-quality sound.

The *AutoSecure™* feature electronically locks your phone when the Handset is in the Base Unit.

To get the most from your phone, please read this Operating Guide thoroughly. Also, be sure to complete the Product Registration Form and mail it in.

Visit our internet site at: <http://www.uniden.com>

Included with the EXS9005

If any of these items are missing or damaged, contact Uniden Parts Department at (800) 554-3988, 8:00 a.m. to 5:00 p.m. Central, Monday through Friday.

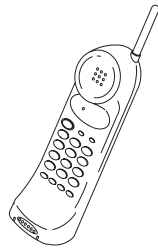

Handset

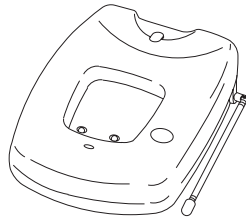

Base Unit

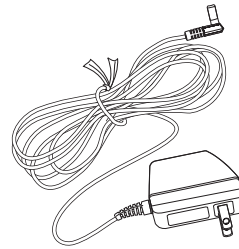

AC Adapter

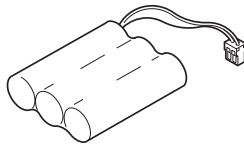

Rechargeable Battery

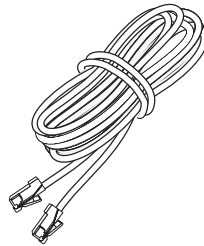

Long Telephone Cord

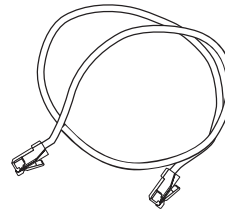

Short Telephone Cord

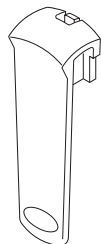

Beltclip

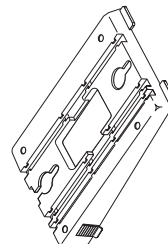

Wall Mount Adapter



Operating Guide
UDZZ01838ZZ



Other Printed Material

Included with the EXS9005

Important Electrical Considerations

Unplug all electrical appliances when you know an electrical storm is approaching. Lightning can pass through your household wiring and damage any device connected to it. This phone is no exception.

Warning!

Please do not attempt to unplug any appliance during an electrical storm.

Caution: Changes or modifications to this product not expressly approved by Uniden, or operation of this product in any way other than as detailed by this Operating Guide, could void your authority to operate this product.

Range

Your new phone is designed to achieve the maximum possible range by transmitting and receiving according to the highest specifications set forth by the FCC. We have rated this phone to operate at a maximum distance with the qualification that the range depends upon the environment in which the telephone is used. Many factors limit range, and it would be impossible to include all the variables in our rating. The Maximum Range rating of this phone is meant to be used as a means of comparison against other range claims.

Telephone Line Problems

The FCC has granted the telephone company the right to disconnect service in the event that your phone causes problems on the telephone line. Also, the telephone company may make changes in facilities and services which may affect the operation of your unit. However, your telephone company must give adequate notice in writing prior to such actions to allow you time for making necessary arrangements to continue uninterrupted service.

If you are having trouble with your telephone service, you must first disconnect your phone to determine if it is the cause of your problem. If you determine that it is the cause, you must leave it disconnected until the trouble has been corrected.

Radio Interference

Radio interference may occasionally cause buzzing and humming in your cordless Handset, or clicking noises in the Base Unit. This interference is caused by external sources such as TV, refrigerator, vacuum cleaner, fluorescent lighting, or electrical storm. Your unit is NOT DEFECTIVE. If these noises continue and are too distracting, please check around your home to see what appliances may be causing the problem. In addition, we recommend that the Base Unit not be plugged into a circuit that also powers a major appliance because of the potential for interference. Be certain that the antenna on the unit is fully extended when needed.

In the unlikely event that you consistently hear other voices or distracting transmissions on your phone, you may be receiving radio signals from another cordless telephone or other source of interference.

Finally, it should be noted that some cordless telephones operate at frequencies that may cause interference to nearby TVs and VCRs. To minimize or prevent such interference, the base of the cordless telephone should not be placed near or on top of a TV or VCR. If interference is experienced, moving the cordless telephone farther away from the TV or VCR will often reduce or eliminate the interference.

More Than One Cordless Telephone

Don't operate two cordless phones too close to each other because of the interference. This interference can be reduced by lowering your base unit antenna (reducing its range).

Privacy

Note: Cordless telephones are radio devices. Communications between the handset and the base of your cordless telephone are accomplished by means of radio waves which are broadcast over the open airways. Because of the inherent physical properties of radio waves, your communications can be received by radio receiving devices other than your own cordless telephone unit. Consequently, any communications using your cordless telephone may not be private.

Installation

Selecting a Location

Before choosing a location for your new phone, there are some important guidelines you should consider:

- ☞ The location should be close to both a phone jack and continuous power outlet. (*A continuous power outlet is an AC outlet which does not have a switch to interrupt its power.*)
- ☞ Keep the Base Unit and Handset away from sources of electrical noise such as motors or fluorescent lighting.
- ☞ Be sure there is sufficient space to fully extend the Base Unit antenna.
- ☞ The Base Unit can be placed on a desk or tabletop or mounted on a standard AT&T or GTE wall plate.
- ☞ You should charge your new phone for 15-20 hours before completing the installation or using the Handset.

Telephone Line Outlets

There are two types of phone outlets:

Modular Jack

Most phone equipment available now uses modular jacks. Phone cords are fitted with a molded plastic connector which plugs into this type of jack. If you do not have modular phone jacks, contact your local telephone company for information about their installation.

Hard-wired Jack

Some equipment is wired directly to a phone jack, and these types of installations require a modular jack converter. This type of installation is not difficult; however, you should contact your Uniden telephone dealer or a telephone supply store for advice about the proper adapter or converter for your particular situation.

Connecting the Telephone Cords

Consider these safety guidelines before connecting the telephone cords:

Caution!

- ☞ Never install telephone wiring during a lightning storm.
- ☞ Never touch uninsulated telephone wires or terminals unless the telephone line has been disconnected.
- ☞ Use caution when installing or modifying telephone lines.

Applying Power to the Base Unit

This phone requires an AC outlet, without a switch to interrupt power, and the included AC adapter. To relieve strain on the DC plug when the phone is placed on a desk or table, connect the adapter as shown below.

Wrap the power cord around the strain relief notch on the bottom of the Base Unit.

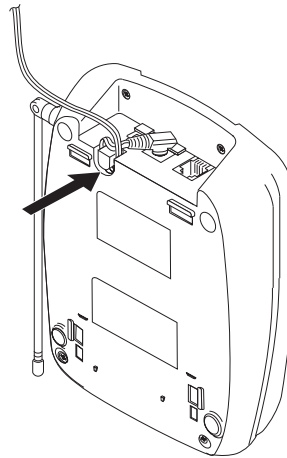

* Place the power cord so that it does not create a trip hazard, or where it could become chafed and create a fire or other electrical hazards.

Adapter Safety Feature

The AC adapter furnished with this phone may be equipped with a polarized line plug — a plug having one blade wider than the other. This plug will fit into the power outlet only one way. If you are unable to insert the plug fully into the outlet, try reversing the plug.

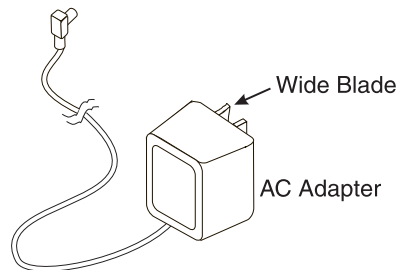

Do Not alter the shape of the blades of the polarized plug!

* If you cannot plug the AC adapter into the outlet, contact someone about replacing the outlet.

Desk or Tabletop Installation

1. Plug the AC Adapter cord into the 9 VDC input jack on the Base Unit.

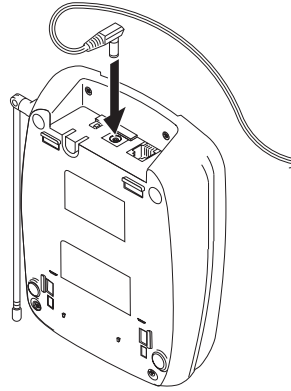

2. Place the AC Adapter cord around the strain relief notch.

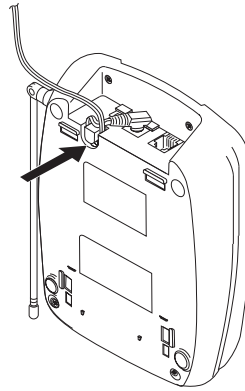

3. Plug one end of the long telephone cord into the **TEL LINE** jack on the Base Unit.

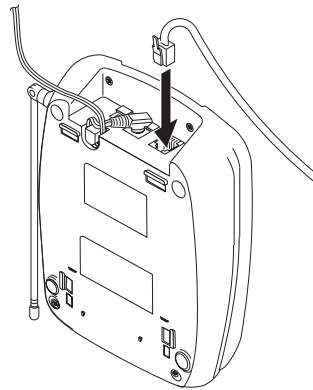

4. Plug the other end of the cord into the telephone jack on the wall.

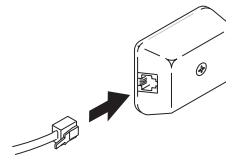

5. Plug the AC Adapter into a standard 120 VAC wall outlet.

Do not use an outlet controlled by a wall switch.

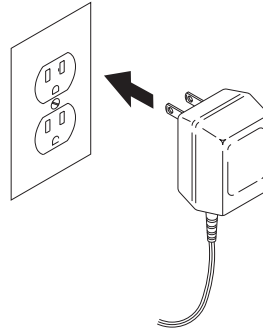

Use only the Uniden AC Adapter supplied with this phone.

6. Place the Base Unit on a desk or tabletop.

In desk or table top installation, the Handset is designed to stand only vertically in the Base Unit.

DO NOT lay the Handset down on the Base Unit.

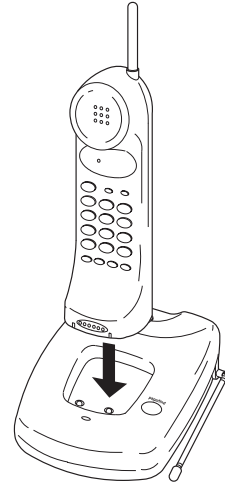

Wall Installation

Standard Wall Plate Mounting

These phones are designed to be mounted on a standard AT&T or GTE wall plate. To attach the wall mount to the Base Unit:

1. Slide the wall mount into the notches at the top of the Base Unit.

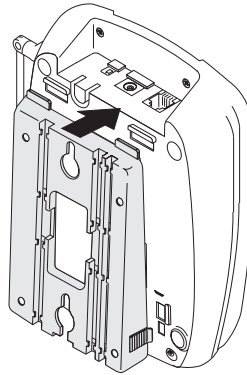

2. Rotate the wall mount stand down and snap into place.

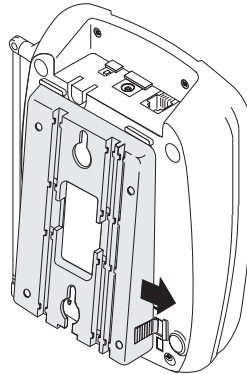

3. Plug the AC Adapter into the Base Unit.

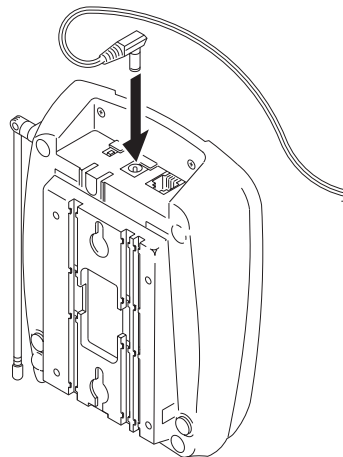

4. Wrap the AC Adapter cord around the strain relief notch.

Then put the AC Adapter cord inside the molded channel.

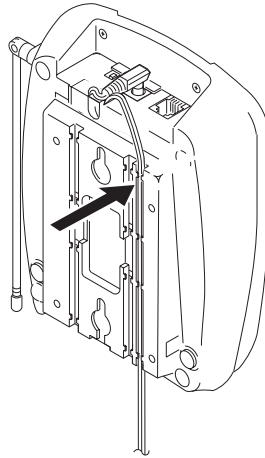

5. Plug one end of the short telephone cord into the **TEL LINE** jack on the Base Unit.

Place the telephone cord inside the molded channel on the bottom of the Base Unit.

Then plug the other end of the telephone cord into the modular jack on the wall.

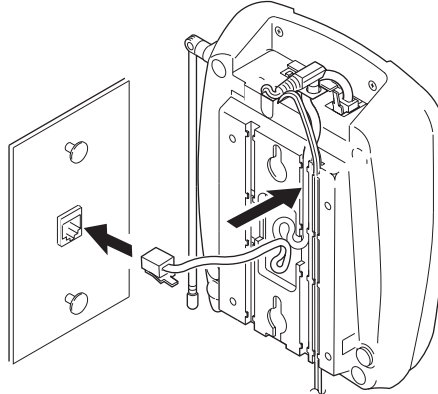

6. Place the Base Unit on the posts of the wall plate and push down until it's firmly seated.

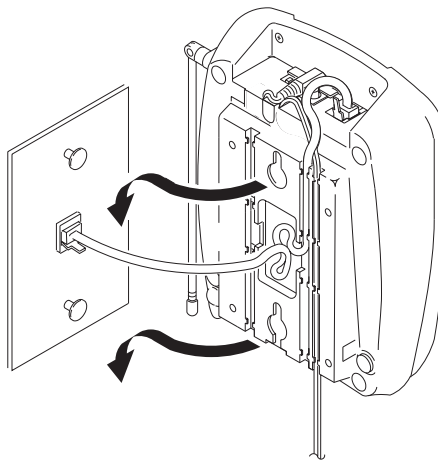

7. Plug the AC Adapter into a standard 120 VAC wall outlet.

* *Do not use an outlet controlled by a wall switch.*

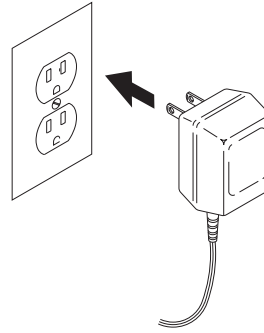

Direct Wall Mounting

If you do not have a standard wall plate, you can mount your phone directly on a wall. Before mounting your phone, consider the following:

- Select a location away from electrical cables, pipes, or other items behind the mounting location that could cause a hazard when inserting screws into the wall.
- Make sure the wall material is capable of supporting the weight of the Base Unit and Handset.
- Use #10 screws with anchoring devices suitable for the wall material where the Base Unit will be placed.

1. Insert two mounting screws 3-15/16 inches apart.

Allow about 3/16 of an inch between the wall and screw heads for mounting the phone.

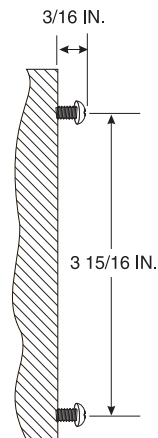

2. Slide the wall mount into the notches at the top of the Base Unit.

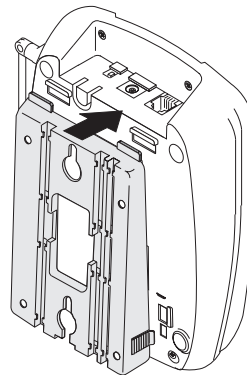

3. Rotate the wall mount stand down and snap into place.

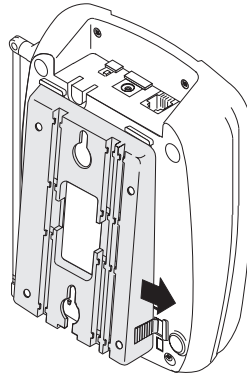

4. Plug the AC Adapter into the Base Unit.

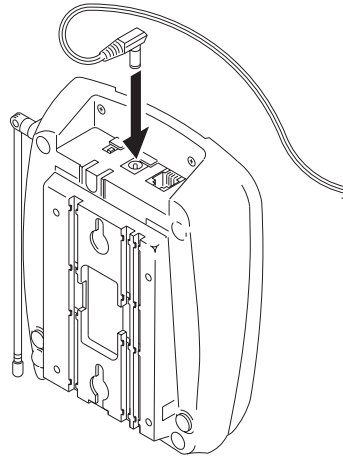

5. Wrap the AC Adapter cord around the strain relief notch.

Then put the AC Adapter cord inside the molded channel.

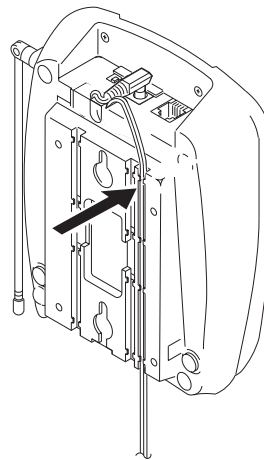

6. Plug one end of the short telephone cord into the **TEL LINE** jack on the Base Unit.

Put the cord inside the molded channel on the bottom of the Base Unit.

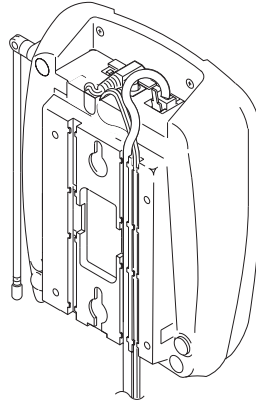

7. Place the Base Unit on the screws and push down until it's firmly seated.

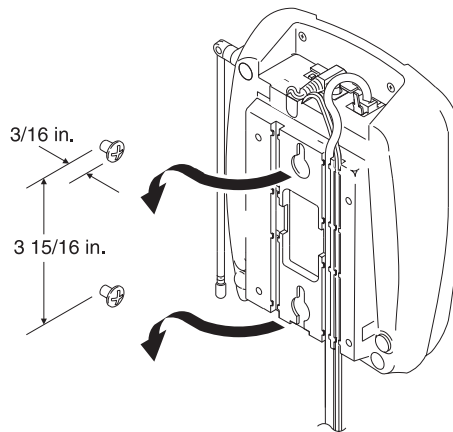

8. Plug the other end of the telephone line cord into the wall jack.

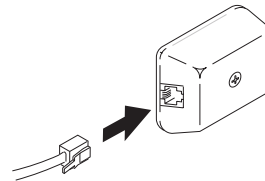

9. Plug the AC Adapter into a standard 120 VAC wall outlet.

* *Do not use an outlet controlled by a wall switch.*

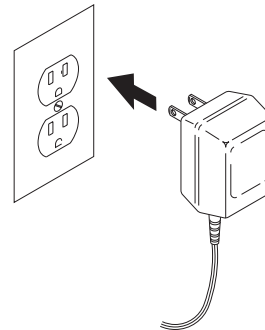

Setting Up Your Phone

Raising the Antenna

Before using your phone, be sure to raise its antenna to the vertical position.

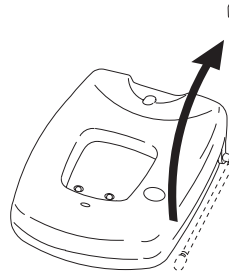

Installing the Handset Battery Pack

1. Press in on the Battery Cover Release and slide the battery compartment cover down.

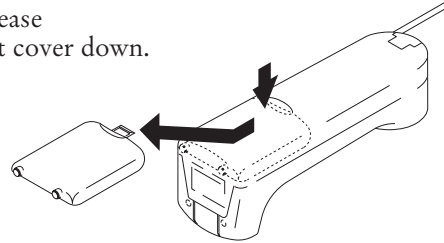

2. Align the plastic connector of the Nickel-Cadmium battery pack with its socket and plug it in.

* *The black lead will be on the left when the plug is properly aligned.*

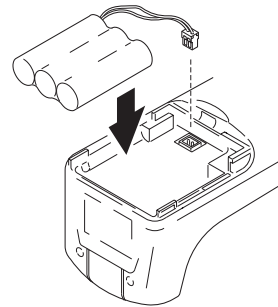

3. Place the battery pack inside the battery compartment and slide the battery cover back on.

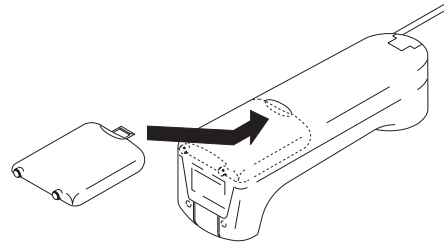

Charging the Battery Pack

Initial Battery Charging

The rechargeable Nickel-Cadmium battery pack must be fully charged before using your phone for the first time. We recommend that the battery pack charge for approximately 15-20 hours, without interruption, before plugging the phone line into your new phone.

1. Place the Handset on the Base Unit.

* *In desk or table top use, the Battery charges only in the vertical position.*

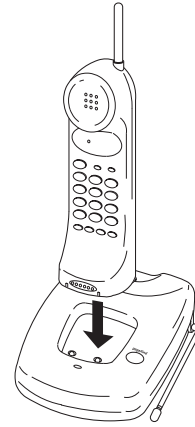

—or—

Hang the Handset on the cradle when the phone is mounted on a wall.



2. Make sure the **status** LED lights. If the LED doesn't light, check to see that the LED doesn't light, check to see that the AC adapter is plugged in and that the Handset is making good contact with the Base Unit charging contacts.

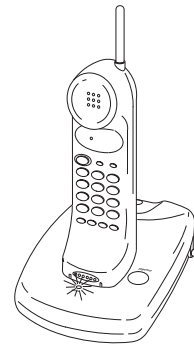

Battery Memory Effect

Rechargeable batteries can develop a reduced charge capacity caused by repeated charge and discharge cycles. Rechargeable batteries that have developed this effect will not operate to their fullest capacity.

To avoid memory effect, operate the unit until the rechargeable battery is completely discharged before recharging. Do not “top off” the charge after using for a short time. Also, do not charge the rechargeable battery for extended periods of time.

To erase memory effect, operate the unit until the rechargeable battery is completely discharged, then fully recharge. Repeat this process at least three (3) times.

Low Battery Indicator

When the Battery Pack in the Handset is very low and needs to be charged, the **talk • batt low** LED flashes.

Complete your call as quickly as possible. Return the Handset to the Base Unit for charging.

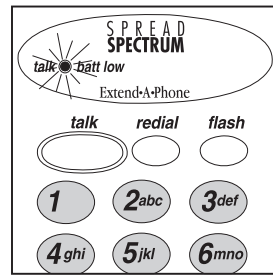

✱ *Allow 15 to 20 hours without any interruption for the Handset to fully recharge.*

Cleaning the Battery Contacts

To maintain a good charge, it is important to clean all charging contacts on the Handset and Base Unit about once a month. Use a pencil eraser or other contact cleaner. **Do not** use any liquids or solvents.

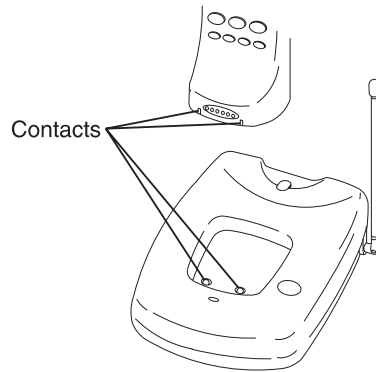

Setting the Pulse/Tone Switch

Be sure the **PULSE/TONE** switch is in the **TONE** position.

* *Most phone systems are Tone dialing. Check with your local phone company if you are not sure whether your system is Tone or Pulse dialing*

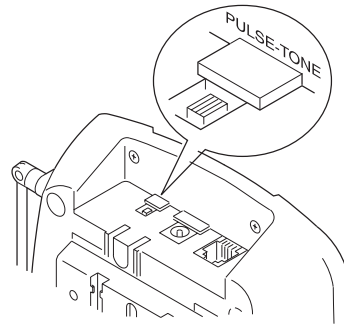

Adjusting Ringer Controls

Ringer Tone and Volume

The phone has 4 ringer tones with two volume levels each - one soft and one loud.

To change the ringer tone:

While the phone is not in use, press **flash** and then either 1, 2, 3, or 4 on the keypad. The ringer tone sounds.

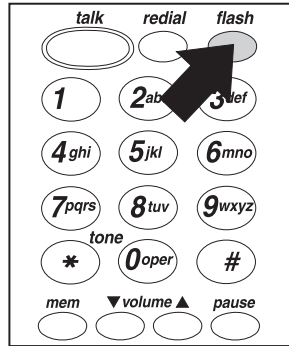

To change the ringer tone volume:

While the phone is not in use, press either **volume** ▲ (up) or ▼ (down).

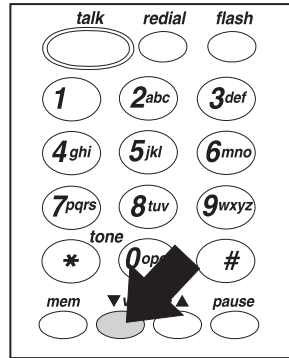

Receiver volume

While you are on a call, press either **volume** ▲ (up) or ▼ (down).

The phone has 8 receiver volume levels.

Each time you press **volume** ▲ or ▼, the receiver volume changes.

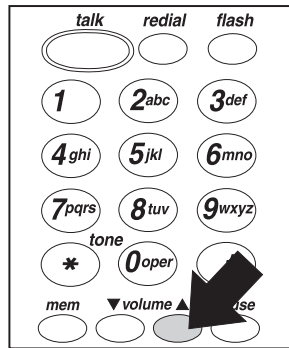

Changing the Beltclip

Attach the beltclip

1. Remove the slot cover.

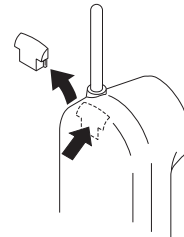

2. Put the beltclip in the slot and press down until it clicks.

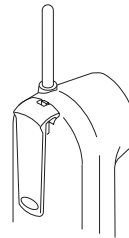
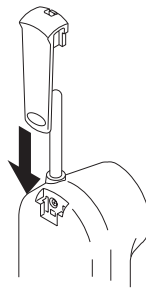

Remove the Beltclip

1. Pull back on the release tab and pull up.

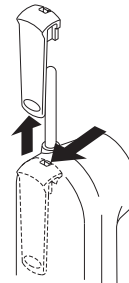

2. Replace the slot cover.



Using Your Phone

Making and Receiving Calls

The following features of the EXS9005 phones are different depending on the Handset's location when you make or receive a call.

	Handset On Base Unit	Handset Off Base Unit
ANSWER CALL	Pick up Handset (<i>AutoTalk</i>).	Press talk .
MAKE CALL	<ol style="list-style-type: none"> 1) Pick up Handset. 2) Press talk. 3) Listen for dial tone. 4) Dial the number. 	<ol style="list-style-type: none"> 1) Press talk. 2) Listen for dial tone. 3) Dial the number.
HANG UP	Press talk . — OR — Return Handset to Base Unit. (<i>AutoStandby</i>)	
REDIAL	<ol style="list-style-type: none"> 1) Pick up Handset. 2) Press talk. 3) Listen for dial tone. 4) Press redial. 	<ol style="list-style-type: none"> 1) Press talk. 2) Listen for dial tone. 3) Press redial.

* Sometimes when you press **talk** to hang up the phone, you may get an error tone and the phone will not disconnect. If this happens, place the Handset on the Base Unit or press **talk** again while holding the Handset close to the Base Unit.

Flash and Page/Find

To access call waiting while the phone is in use or to use the one-way page to locate the Handset, follow these steps:

	Press These Keys	You Will Hear
FLASH	If the <i>call waiting</i> tone sounds, press flash to accept the waiting call and put the first call on hold. — OR — If you have finished a call and want to make another call, press flash to hang up and get a dial tone.	A click, a short pause, then the caller (if you were on a call). — OR — A click, and then a dial tone so you can make a different call.
PAGE/FIND	Press page/find on the Base Unit to locate the Handset.	The Handset will beep about 14 times.

Programming Your Phone

All programming functions must be completed when your phone is in the standby mode because programming keys do not function while you are on the phone.

Storing a Number in Memory

Use these keys to store a number in memory.

* An error tone will sound and the programming procedure will be canceled if more than 30 seconds elapse between each keystroke entry or step.

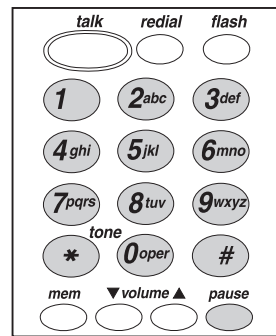

1. Remove the Handset from the Base Unit.
2. Press **mem**.

The **talk • batt low** LED blinks.

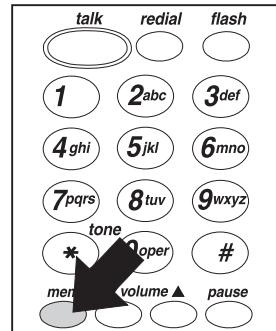

3. Enter the number you want to store (up to 16 digits).



4. If a pause is needed during dialing to access a long distance service, press **pause**.



* The **pause** button counts as one digit. Pressing **pause** more than once increases the length of the pause between numbers.

5. Press **mem** again.

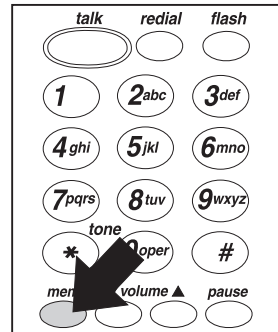

6. Enter the two-digit memory location (01-20).
Example: for memory location 05, you would press 0, then 5.

* A confirmation tone (double beep) indicates that the number is stored.
 If you enter a invalid two-digit memory location, a loud single beep sounds.

Storing a Mixed Number

If your phone is set up for Pulse dialing, you can store a mixed mode number so that you can easily access long distance services.

Use these keys to store a mixed mode number in memory.

* An error tone will sound and the programming procedure will be canceled if more than 30 seconds elapse between each keystroke entry or step.

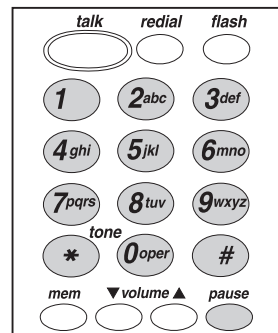

1. Remove Handset from the Base Unit.
2. Press **mem**.

The **talk • batt low** LED blinks.

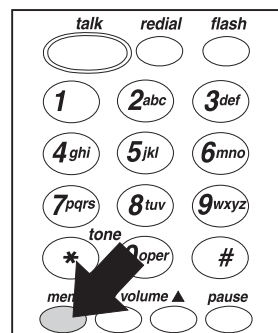

Programming Your Phone

3. Enter the number to be dialed in pulse mode.



4. Press **tone** on the Handset.

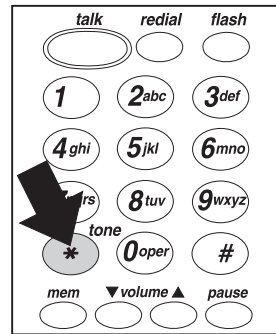

5. Enter the number to be dialed in tone mode.



6. If a pause is needed during dialing to access a long distance service, press **pause**.



* The **pause** button counts as one digit. Pressing **pause** more than once increases the length of the pause between numbers.

7. Press **mem** again.

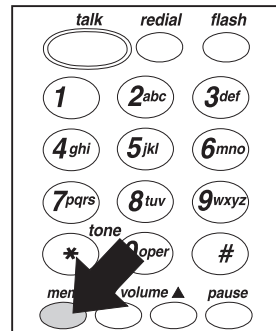

8. Enter the two-digit memory location (01-20).

Example: for memory location 07, you would press 0, then 7.

* A confirmation tone (double beep) indicates that the number is stored. If you enter a invalid two-digit memory location, a loud single beep sounds.

Dialing a Stored Number

To dial a number previously stored in memory, follow these steps:

1. Remove the Handset from the Base Unit.
2. Press **talk**.

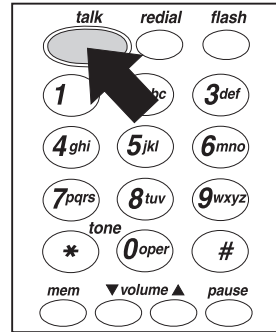

3. Press **mem**.

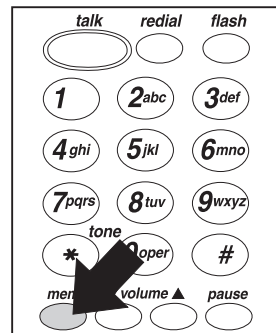

4. Press the two-digit memory location number (01-20).

Example:
for memory location 02,
you would press 0, then 2.

If you enter a invalid two-digit memory location, a loud single beep sounds.

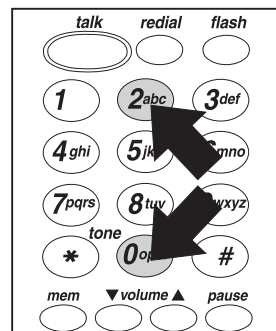

Chain Dialing

On certain occasions, after dialing a number, you may be requested by the party or service you are calling to enter a special access code, such as when performing a banking transaction. To do this, simply:

1. Store the access code into one of the memory numbers.
2. Dial the main number.
3. At the appropriate time, press **mem** followed by the memory location number where the access code is saved.

Erasing a Stored Number

To erase a number previously stored in a memory location (01-20), follow these steps:

1. Remove the Handset from the Base Unit.
2. Press **mem** twice.

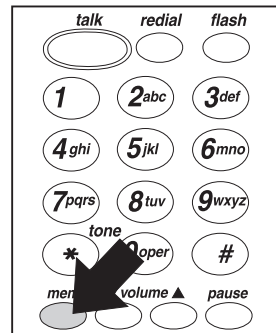

3. Press the two-digit memory location number (01-20).

Example:

for memory location 02,
you would press 0, then 2.

A confirmation tone (double beep) indicates that the number is erased.

If you enter a invalid two-digit memory location, a loud single beep sounds.

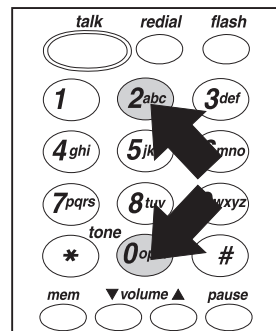

* *If more than 30 seconds elapse between each keystroke entry or step, an error tone will sound and the erase procedure will be canceled.*

Troubleshooting

If your Cordless Telephone is not performing to your expectations, please try these simple steps. If you are still unable to resolve the problems, contact Uniden Customer Service at (800) 297-1023, 8:00 a.m. to 5:00 p.m. Central, Monday through Friday.

Problem	Suggestion
Charge light won't come on when Handset is placed in Base Unit.	<ul style="list-style-type: none"> • Make sure AC Adapter is plugged into the Base Unit and wall outlet. • Make sure Handset is properly seated in Base Unit. • Make sure that the charging contacts on the Handset and Base Unit are clean. • If the phone is desk/table top installed, make sure the Handset is in the vertical position.
Audio sounds weak and/or scratchy.	<ul style="list-style-type: none"> • Make sure that the Base Unit antenna is vertical. • Move the Handset and/or Base Unit to different locations and try again.
Can't make or receive calls.	<ul style="list-style-type: none"> • Check both ends of the Base Unit telephone line cord. • Make sure the AC Adapter is plugged into the Base Unit and wall outlet. • Disconnect the AC Adapter for a few minutes, and then reconnect it. • Check TONE/PULSE switch position.
Handset doesn't ring or receive a page.	<ul style="list-style-type: none"> • Nickel-Cadmium battery pack may be weak. Charge the battery on the Base Unit for 15 to 20 hours. • Raise the Base Unit antenna vertically. • The Handset may be too far away from the Base Unit. • Place the Base Unit away from noise sources.
Handset does not fully charge.	<ul style="list-style-type: none"> • If the phone is desk/table top installed, make sure the Handset is in the vertical position and the contacts are touching.

Specifications

General – The EXS9005 complies with FCC Parts 15 and 68.

Frequency Control	PLL
Modulation	DBPSK
Frequency	903.6 to 926.4 MHz (20 Channels)

Base Unit

Power Requirements	9 V 250 mA (from AC Adapter)
Size	5-1/2 in. (W) x 2-1/2 in. (D) x 7-3/4 in. (H)
Weight	Approx. 12 oz.

Handset

Power Requirements	Rechargeable Ni-Cd Battery Pack
Size (without antenna)	2 in. (W) x 2-1/4 in. (D) x 7-1/2 in. (H)
Weight	Approx. 9 oz. (including battery)
Battery	BT-905
	Capacity 600 mAH, 3.6V
	Talk Mode 4 hours
	Standby Mode 7 days

Specifications, Features, and availability of Optional Accessories are all subject to change without prior notice.

One Year Limited Warranty

Important: Evidence of original purchase is required for warranty service.

WARRANTOR: UNIDEN AMERICA CORPORATION (“Uniden”)

ELEMENTS OF WARRANTY: Uniden warrants, for one year, to the original retail owner, this Uniden Product to be free from defects in materials and craftsmanship with only the limitations or exclusions set out below.

WARRANTY DURATION: This warranty to the original user shall terminate and be of no further effect 12 months after the date of original retail sale. The warranty is invalid if the Product is (A) damaged or not maintained as reasonable or necessary, (B) modified, altered, or used as part of any conversion kits, subassemblies, or any configurations not sold by Uniden, (C) improperly installed, (D) serviced or repaired by someone other than an authorized Uniden service center for a defect or malfunction covered by this warranty, (E) used in any conjunction with equipment or parts or as part of any system not manufactured by Uniden, or (F) installed or programmed by anyone other than as detailed by the Operating Guide for this product.

STATEMENT OF REMEDY: In the event that the product does not conform to this warranty at any time while this warranty is in effect, warrantor will repair the defect and return it to you without charge for parts, service, or any other cost (except shipping and handling) incurred by warrantor or its representatives in connection with the performance of this warranty. THE LIMITED WARRANTY SET FORTH ABOVE IS THE SOLE AND ENTIRE WARRANTY PERTAINING TO THE PRODUCT AND IS IN LIEU OF AND EXCLUDES ALL OTHER WARRANTIES OF ANY NATURE WHATSOEVER, WHETHER EXPRESS, IMPLIED OR ARISING BY OPERATION OF LAW, INCLUDING, BUT NOT LIMITED TO ANY IMPLIED WARRANTIES OF MERCHANTABILITY OR FITNESS FOR A PARTICULAR PURPOSE. THIS WARRANTY DOES NOT COVER OR PROVIDE FOR THE REIMBURSEMENT OR PAYMENT OF INCIDENTAL OR CONSEQUENTIAL DAMAGES. Some states do not allow this exclusion or limitation of incidental or consequential damages so the above limitation or exclusion may not apply to you.

LEGAL REMEDIES: This warranty gives you specific legal rights, and you may also have other rights which vary from state to state. This warranty is void outside the United States of America.

PROCEDURE FOR OBTAINING PERFORMANCE OF WARRANTY: If, after following the instructions in this Operating Guide you are certain that the Product is defective, pack the Product carefully (preferably in its original packaging). Include evidence of original purchase and a note describing the defect that has caused you to return it. The Product should be shipped freight prepaid, by traceable means, or delivered, to warrantor at:

Uniden America Corporation
4700 Amon Carter Blvd
Fort Worth, TX 76155
(800) 297-1023, 8 a.m. to 5 p.m. Central, Monday through Friday

Covered under one or more of the following U.S. patents:

4,511,761 4,523,058 4,595,795 4,797,916 5,426,690

Free Manuals Download Website

<http://myh66.com>

<http://usermanuals.us>

<http://www.somanuals.com>

<http://www.4manuals.cc>

<http://www.manual-lib.com>

<http://www.404manual.com>

<http://www.luxmanual.com>

<http://aubethermostatmanual.com>

Golf course search by state

<http://golfingnear.com>

Email search by domain

<http://emailbydomain.com>

Auto manuals search

<http://auto.somanuals.com>

TV manuals search

<http://tv.somanuals.com>