



EXT 1865

# OWNER'S MANUAL

900 MHz Digital  
Cordless Phone

Caller ID

Advanced Calling  
Features

Message Waiting  
Indicator

**Uniden®**

# Controls and functions

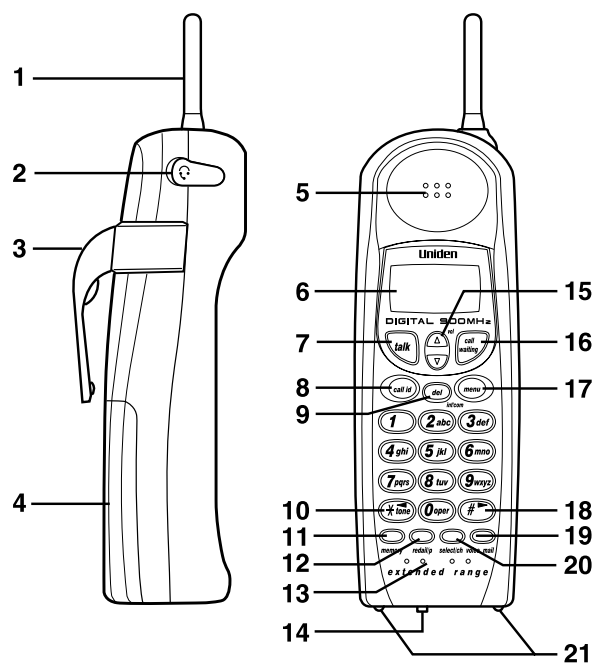

1. Handset Antenna
2. Headset Connection
3. Belt Clip
4. Handset Battery Compartment
5. Handset Speaker
6. LCD Display
7. Talk Key
8. Caller ID Key
9. Delete/Intercom Key
10. Tone Key/Left Cursor
11. Memory Key
12. Redial/Pause Key
13. Handset Microphone
14. Handset Ringer Switch
15. Volume/ Cursor Up and Down/ Character Select Key
16. Call Waiting Key
17. Menu Key
18. Right Cursor
19. Voice Mail Key
20. Select/Channel Key
21. Handset Contacts
22. Handset Retainer
23. Voice Mail Key
24. Call Return Key
25. Busy Redial Key
26. 3-Way Call Key
27. Base Contacts
28. Tone Key
29. Base Speaker
30. Message LED
31. Speaker LED
32. Status LED
33. Mute Key
34. Call Waiting Key
35. Speaker Key
36. Base Antenna
37. Memory Key
38. Redial Key
39. Pause Key
40. Page/Intercom Key
41. Wall Mount Adapter
42. Base Speaker Volume Adjust
43. Base Microphone
44. Ring Volume Switch
45. Pulse-Tone Switch
46. DC Power Input
47. Phone Jack

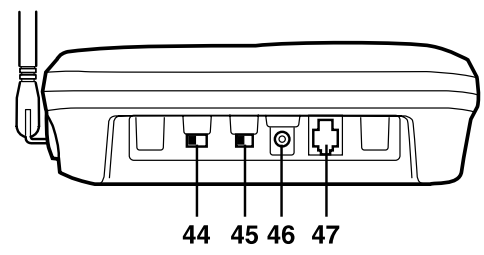
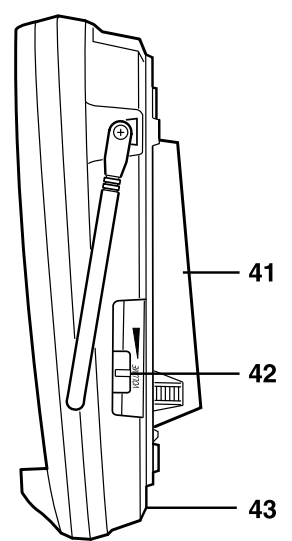
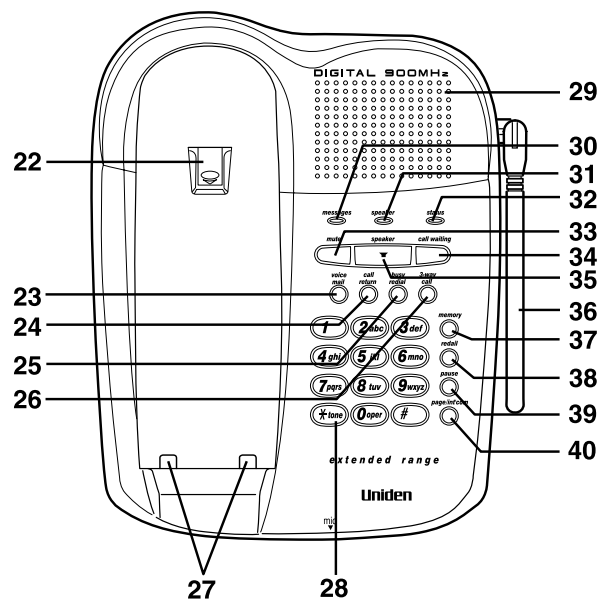

## Introduction

Congratulations on your purchase of the EXT 1865 cordless telephone. This phone is designed for reliability, long life, and outstanding performance.

**Note: Some illustrations in this manual may differ from the actual unit for explanation purposes.**

## Features

- 900 MHz Digital Transmission with Extended Range
- Secure Digital Transmission
- Caller ID and Call Waiting Caller ID
- Advanced Caller ID with Call Waiting Option
- 50 Number Caller ID Memory
- Advanced Calling Features
- Message Waiting Indicator
- 3-Line, 16 Character Backlit Handset Display
- Dual Keypad
- Speakerphone
- Conference Call
- 30 Memory Dial Locations
- 3-Number Redial Memory
- Pause
- Pulse / Tone Dialing
- Page / Intercom
- 10 Day Standby Battery Life
- 7 Hour Talk Time
- Handset Earpiece and Ringer Volume Control
- Hearing Aid Compatible

**Random Code™** digital security automatically selects one of approx. 65,000 codes for the handset and base. These features enhance your phone's security and also prevent unauthorized calls as a result of your phone being activated by other equipment.

## Contents

Introduction / Features .....inside front cover  
 Controls and Functions .....inside front cover

**Getting Started**  
 Read this first.....2  
 Step 1: Checking the package contents.....3  
 Step 2: Setting up the base unit .....4  
     Mounting the base unit on a wall .....7  
 Step 3: Preparing the battery pack.....9

**Basics**  
 Making a call .....11  
 Receiving a call .....13  
 Adjusting the ringer and earpiece volume .....15  
 Redialing a call .....16  
 Call Waiting.....17

**Telephone Features**  
 Memory dialing  
     Storing phone numbers and names .....18  
     Making calls with memory dialing .....21  
     Editing a stored name and/or  
     phone number .....23  
     Erasing a stored name and phone number ....25  
 Mute .....26  
 3-way conference features .....27  
 Intercom feature.....28  
 Call transfer feature .....29  
 Advanced calling features .....30

**Caller ID Features**  
 Caller ID.....31  
 When the telephone rings.....32  
 Viewing the Caller ID Message list .....33  
 Deleting information from the Caller ID list .....34  
 Using the Caller ID list .....36  
 Using Caller ID on Call Waiting service .....38

**Additional Information**  
 Changing the digital security code .....39  
 Installing the beltclip .....40  
 Headset installation.....40  
 Note on power sources .....41  
 Maintenance.....41

**Troubleshooting**.....42

**Index**.....44

Getting Started

Basics

Telephone Features

Caller ID Features

Additional Information

## Read this first

This cordless telephone must be set up before use. Follow these steps;

### Step 1 (page 3)

Unpack and check the telephone and accessories.

### Step 2 (page 4 to 8)

Next, choose the best location to set up the base unit.



**Base unit**

### Step 3 (page 9 to 10)

Then, insert the battery pack into the handset. You must charge the battery pack for more than 17 hours before using the phone.



**Handset**

### About the digital security code

This cordless telephone uses a digital security code to prevent unauthorized access to your base unit. This security code prevents other cordless handsets from making calls through your base unit. A random security code will be assigned automatically between your base unit and handset when you charge the battery pack for the first time.

If you want to reset the security code, see page 39.

## Checking the package contents

Make sure you have received the following items in the package.

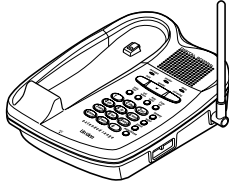

• Base unit



• Handset

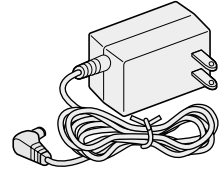

• AC adapter (AD-420)

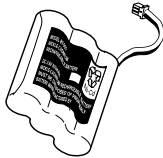

• Rechargeable battery pack (BT-905)

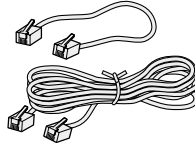

• Telephone line cord (2)

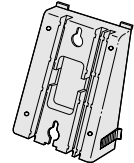

• Wall mount adapter

- This Owner's Manual
- Precautions and Important Safety Instructions
- Guide to Using Advanced Calling Features

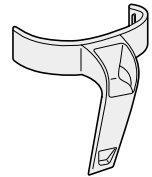

• Beltclip

### Uniden Parts Department

(800) 554-3988

Hours: M-F 7:00 AM to 5:00 PM CST.

We can also be reached on the web at [www.uniden.com](http://www.uniden.com).

## Setting up the base unit

Do the following steps.

- Choose the best location
- Connect the base unit
- Choose the dialing mode

### Choose the best location

Before choosing a location for your new phone, read the **INSTALLATION CONSIDERATIONS** included in the **PRECAUTIONS AND IMPORTANT SAFETY INSTRUCTIONS** brochure. Here are some important guidelines you should consider:

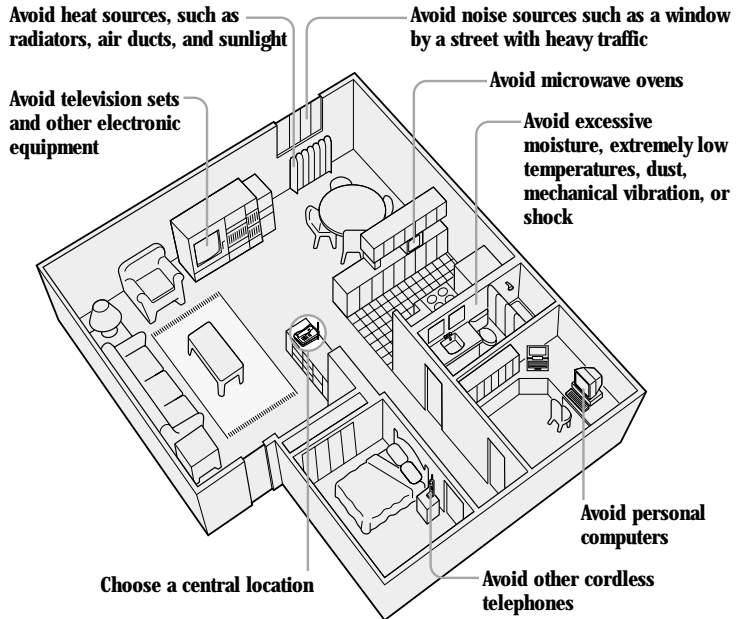

- You should charge your handset for more than 17 hours before attaching to a phone line and using the phone.
- The location should be close to both a phone jack and continuous power outlet which is not switchable.
- Keep the base and handset away from sources of electrical noise such as motors and fluorescent lighting.
- Be sure there is sufficient space to raise the base antenna fully vertical.
- The base can be placed on a desk, tabletop or mounted on a standard wall plate.

## Connect the base unit

If you want to install the base unit on the wall, see page 7.

### NOTE

Place the power cord so it does not create a trip hazard, or where it could become chafed and create a fire or electrical hazard.

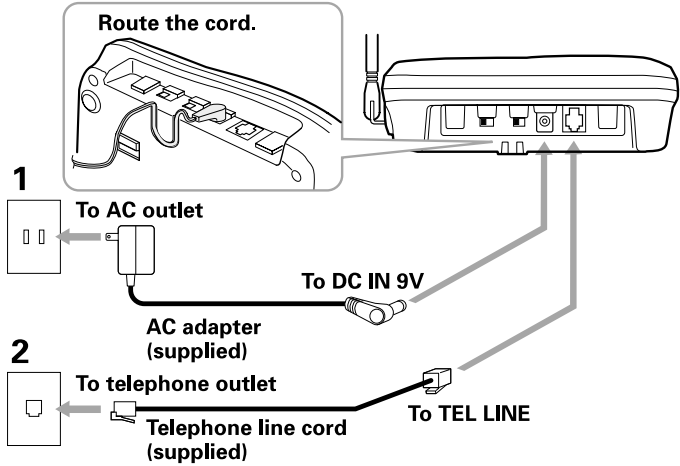

- 1** Connect the AC adapter to the **DC IN 9V** jack and to a standard 120V AC wall outlet.
- 2** Connect the telephone line cord to the **TEL LINE** jack and to a telephone outlet.
- 3** Set the base unit on a desk or tabletop and place the handset on the base unit. Then raise the antenna to a vertical position.

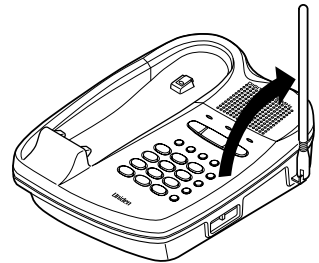





Use only the supplied AD-420 AC adapter. Do not use any other AC adapter.



Connect the AC adapter to a continuous power supply.



Place the base unit close to the AC outlet so that you can unplug the AC adapter easily.



If your telephone outlet isn't modular, contact your telephone company for assistance.

**Polarity of the plug**

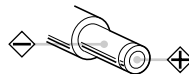

**Modular**



**Choose the dialing mode**

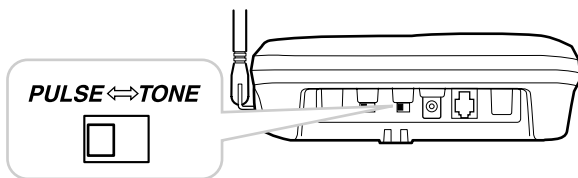

Depending on your dialing system, set the **PULSE-TONE** switch as follows:

<b>If your dialing system is</b>	<b>Set the switch to</b>
Tone	<i><b>TONE</b></i>
Pulse	<i><b>PULSE</b></i>

**If you aren't sure of your dialing system**

Make a trial call with the **PULSE-TONE** switch set to **TONE**. If the call connects, leave the switch as is; otherwise, set to **PULSE**.

# Mounting the base unit on a wall

## Standard wall plate mounting

This phone can be mounted on any standard telephone wall plate.

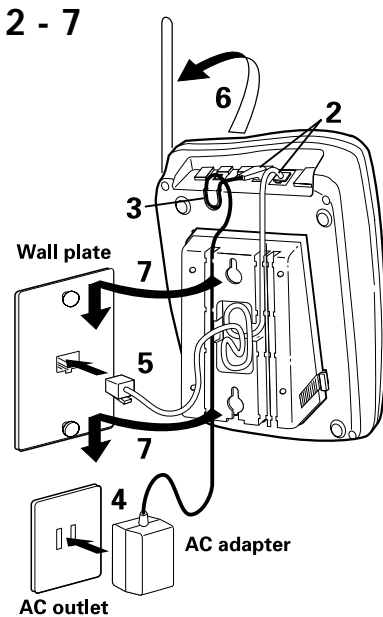
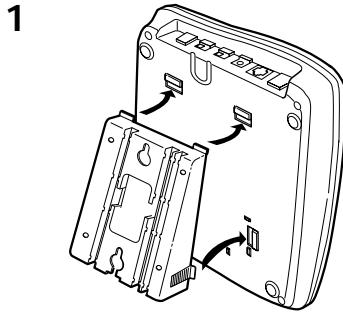

- 1 Snap the wall mount adapter into the notches on the base.
- 2 Plug the telephone line cord to the **TEL LINE** jack and the AC adapter to the **DC IN 9V** jack.
- 3 Wrap the AC adapter cord inside the molded wiring channel. Then wrap the cord around the strain relief notch.
- 4 Plug the AC adapter into a standard 120V AC wall outlet.
- 5 Plug the telephone line cord into the telephone outlet.
- 6 Raise the antenna to a vertical position.
- 7 Align the mounting slots on the base with the mounting posts on the wall. Push in and down until the phone is firmly seated.

## NOTE

If the handset beltclip is attached, you cannot charge the handset with the display showing when the phone is mounted on the wall (See page 40).

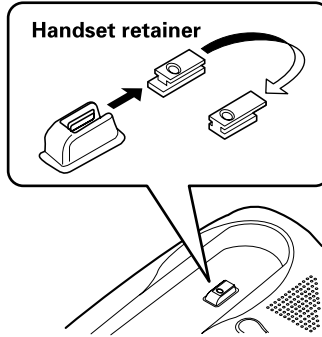

- 8 On the base unit, pull the handset retainer out of the slot. Rotate it clockwise 180 degrees.
- 9 Flip the retainer from front to back. Slide it back into the slot so that the lip of the retainer is up and the oval point is down. The retainer holds the handset in place.

## Direct wall plate mounting

If you don't have a standard wall plate, you can mount your phone directly to the wall. Before doing this, consider the following:

- Avoid electrical cables, pipes, or other items behind the mounting location that could cause a hazard when inserting screws into the wall.
- Try to mount your phone within 10 - 15 feet of a working phone jack to avoid excessive cord lengths.
- Make sure the wall material is capable of supporting the weight of the base and handset.
- Use #10 screws (minimum length of 1-3/8 inches) with anchoring devices suitable for the wall material where the base unit will be placed.

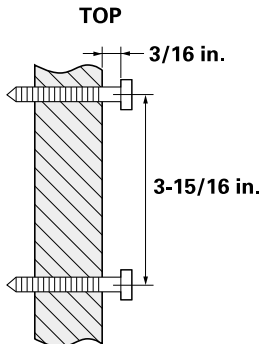

- 1 Insert two mounting screws into the wall, with their appropriate anchoring device, 3-15/16 inches apart. Allow about 3/16 of an inch between the wall and screwheads for mounting the phone.
- 2 Refer to steps 1 through 9 on page 7 and 8 to mount the telephone.

## Preparing the battery pack

Charge the battery pack for more than 17 hours before you start using your phone.

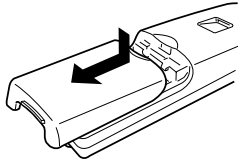

- 1** Press in on the battery cover release and slide the cover down until it comes off.

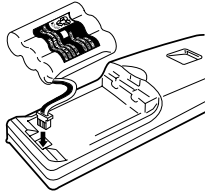

- 2** Connect the battery pack connector with the correct polarity (black and red wires), then insert the battery pack into the battery compartment.

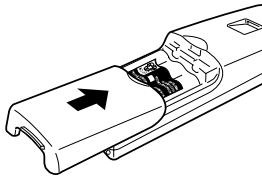

- 3** Slide the battery cover on until it snaps into place.

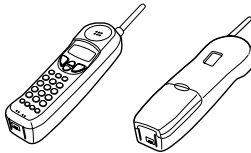

- 4** Place the handset on the base.

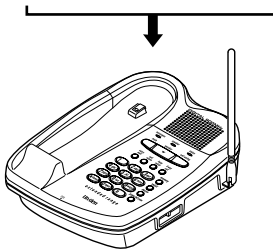

- 5** Make sure that the **status** LED lights. If the LED doesn't light, check to see that the AC adapter is plugged in and that the handset makes good contact with the base charging contacts.



Use only Uniden Battery (BT-905) supplied with your phone.

## NOTE

Even when the battery pack is not being used, it will gradually discharge over a long period. For optimum performance, be sure to return the handset to the base unit after a telephone call for charging the battery.

## Battery use time (per charge)

From fully charged

- Seven hours continuous use
- Ten days when the handset is in the standby mode

## When the battery charge becomes low

When the voltage of battery pack in the handset is very low and needs to be charged, the phone is programmed to eliminate

Low Battery

functions in order to save power. If the phone is not in use, "Low Battery" flashes and none of the keys will operate. If the phone is in use, "Low Battery" flashes and the handset beeps. Complete your conversation as quickly as possible and return the handset to the base unit for charging.

## Cleaning the battery contacts

To maintain a good charge, it is important to clean the battery contacts on the handset and base unit with a dry cloth about once a month.

**Do not use any liquids or solvents.**

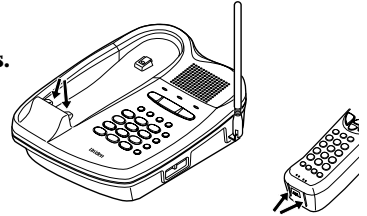

## Making a call

### With the handset

#### NOTE

During the operation you must press a key within 20 seconds or the phone will return to standby.

#### NOTE

Press **(del/int'com)** if you enter a wrong number at step 1.

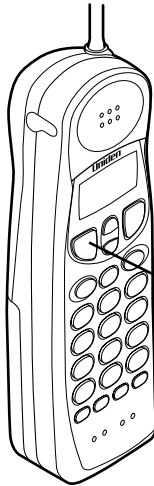

### Dialing from standby

- 1 Enter the phone number. (Up to 32 digits.)

**Example:** Enter 8178583300

8178583300

- 2 Press **(talk)**. "Talk" flashes on the display. Then the volume setting appears for a few seconds. For example, if the volume is set to high, the display shows:

Talk  
<High>

- 3 The number is dialed. After about 5 seconds, the call-time display appears.

Talk 0:00  
8178583300

- 4 To hang up, press **(talk)** or place the handset on the base. The call-time will be displayed for about 5 seconds.

5:15

### Other Operations

To	Do this
To adjust the earpiece volume	Press <b>(▲)</b> or <b>(▼)</b> during the call.
To temporarily switch to tone dial (When the base is set to pulse mode)	Press <b>(* / tone / ◀)</b> . The following numbers dialed will be sent as tone dialing.
To enter a pause in the dialing sequence	Press <b>(redial/p)</b> .
To improve reception	Press <b>(select/ch)</b> . "Scanning" appears on the display while changing a channel.

## Dialing from talk mode

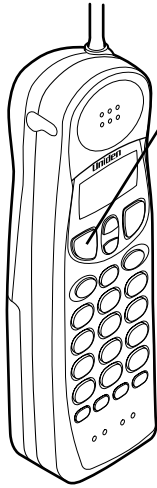

- 1 Press **(talk)**. "Talk" flashes on the display.  
Then the volume setting appears for a few seconds.  
For example, if the volume is set to high, the display shows:



The call-time display appears.

- 2 Dial the phone number.  
**Example:** Enter 8178583300



- 3 To hang up, press **(talk)** or place the handset on the base. The call-time will be displayed for about 5 seconds.

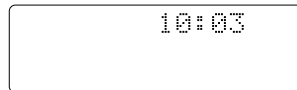

## With the base

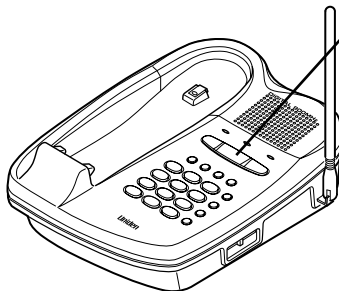

- 1 Press **(speaker)**.
- 2 Dial the number on the keypad.
- 3 When you finish the call, press **(speaker)** to hang up.

# Receiving a call

## With the handset

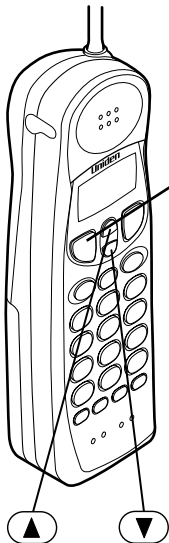

1 Phone rings.

Incoming Call

2 Press **talk**. "Talk" and volume setting appear on the display.

Talk 0:00  
<Normal>

3 Talk with the caller.

Talk 0:02

4 To hang up, press **talk** or place the handset on the base. The call time will be displayed for about 5 seconds.

115:35



### AutoTalk when ringing

When the AutoTalk setting is on and there is an incoming call, simply lift the handset from the base unit to answer the phone. See "Setting Caller ID options" on page 31 for more details.

### Any key answer when ringing

When the AutoTalk setting is on and the handset is off the base, press any handset key to answer the incoming call.

### Call Waiting

**Note:** You must subscribe to Call Waiting service to use this feature.

When a call is received during a telephone call already in progress, press **call waiting** to switch to the new call.

If you also subscribe to Call Waiting on Caller ID, you will see the name and number of the caller in Call Waiting. (See page 38.)

For more information on handling a call waiting call, refer to the "Guide to Using Advanced Calling Features" included in this package.



## With the base

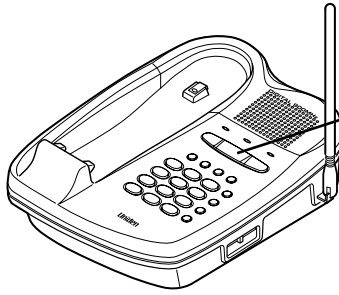

- 1** The base rings. The *status* lamp on the base flashes.
- 2** Press *speaker*.
- 3** When you finish the call, press *speaker* to hang up.

# Adjusting the ringer and earpiece volume

## Handset ringer volume

In the standby mode, press ▲ or ▼ on the handset to select one of four ringer tone and volume combinations.

## Handset ringer on/off switch

This switch turns the handset ringer on or off.

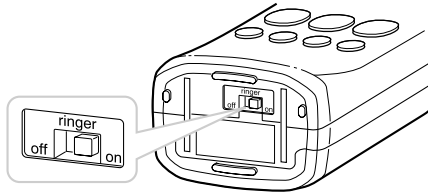

## Earpiece volume

Pressing ▲ or ▼ during a telephone call will change the earpiece volume of the handset. This setting will remain in effect after the telephone call has ended.

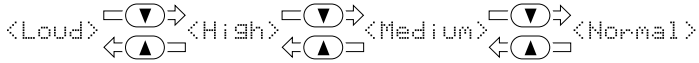

When you press ▲ in Loud mode or press ▼ in Normal mode, error sound beeps.

## Base ringer switch

This switch turns the base ringer on or off.

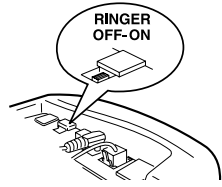

## Base speaker volume

To control the speaker volume of the base, adjust the **VOLUME** slide switch as desired.

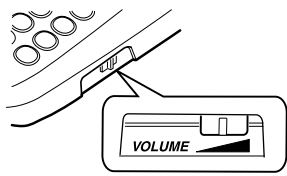

## Redialing a call

### With the handset

The last three phone numbers dialed can be quickly redialed.

#### NOTE

If the recently dialed number exceeds 32 digits, only the first 32 digits are retained for redialing.

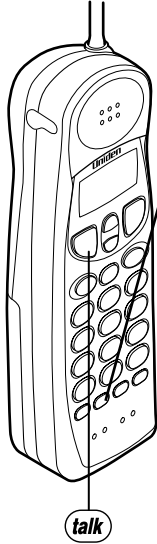

### Redialing from standby

- 1 Press **(redial/p)**.  
The phone number that was last dialed appears on the display.
- 2 Press **(redial/p)** again.  
Each press of **(redial/p)** will display one of the last three numbers dialed.

**Most recent**

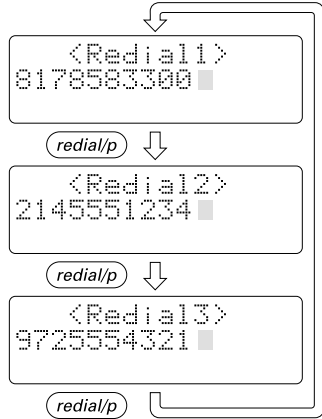

- 3 Press **(talk)**.  
The number will be dialed.

## Redialing from the talk mode

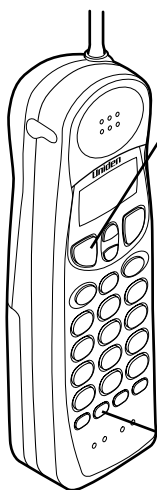

- 1 Press **talk**.  
"Talk" flashes and the volume setting appears.

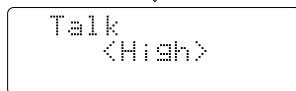
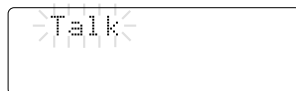

- 2 Press **redial/p**.  
The last number dialed from the handset will be displayed. Only the last number dialed can be accessed while off-hook.

## With the base

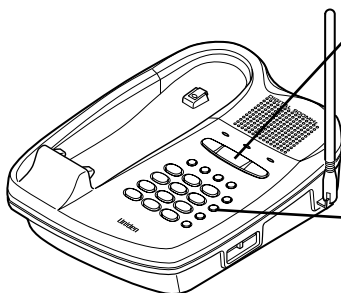

- 1 To call the last number dialed from the base, press **speaker**.

- 2 Press **redial**.  
The number will be dialed.

## Call waiting

If you have call waiting service and a call waiting tone sounds, press **call waiting** to accept the call. After a short pause you will hear the new caller. To return to the original caller, press **call waiting** again. The call waiting feature on the base and handset are independent of each other.

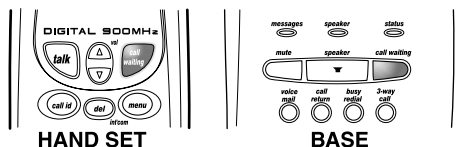

## NOTE

In memory dialing operation, you must press a key within 20 seconds or the phone will return to standby.

## FEATURES

# TELEPHONE

## Storing phone numbers and names

Memory Dialing allows you to dial a number using just a few key strokes. You can store up to 20 phone numbers in the handset and up to 10 phone numbers in the base.

### With the handset

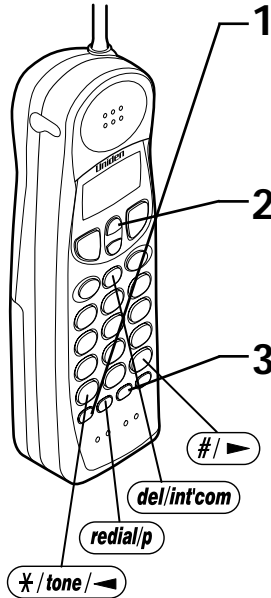

1 Press and hold **memory** until "Memory Store" is displayed.



2 Use **▼** and **▲** or enter a two-digit number (01 - 20) to select the memory location where you would like to store the number.

3 Press **select/ch**. The following screen appears and a cursor flashes indicating that the display is ready for the name to be entered.



If this screen appears, the selected memory location already has an entry stored in it. You must either change the entry in this location, clear the location, or select "Go Back" to choose another location.

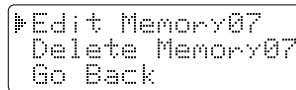

4 Use **▲**, **▼**, or **del/int/com** to enter the name. The name cannot exceed 13 characters.

- Use **▲** and **▼** to scroll through the character menu. It contains upper and lower case letters and various characters.
- Use **# / >** and **\* / tone / <** to move the cursor to the desired location.
- Use **del/int/com** to delete characters as needed.

- 5 Press **(select/ch)**.  
“Store Number” is displayed. The cursor flashes indicating that the display is ready for the number to be entered.

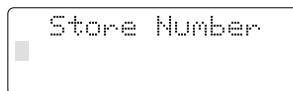

Store Number

- 6 Use the number keypad or **(redial/p)** to enter the phone number.  
The phone number cannot exceed 20 digits.

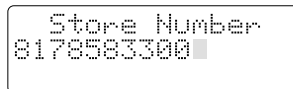

Store Number  
0178583300

- Use **(redial/p)** to enter pause in the dialing sequence.  
The display shows a “F”.



The pause feature is useful for long distance calling, credit card dialing, or sequences that require a pause between digits.

- Use **(del/int'com)** to delete digits as needed.

- 7 Press **(select/ch)**.  
The handset beeps and displays the confirmation screen.  
Memory storage is complete.

For example, if you store a name and number into memory location number 07, the display shows “Memory07 Stored”.

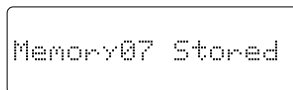

Memory07 Stored

After about 2 seconds, “Memory Store 07 UNIDEN CORP 08” is displayed.

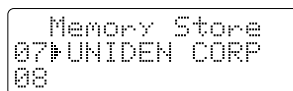

Memory Store  
07 UNIDEN CORP  
08

- 8 Press **(memory)** or place the handset on the base to return to standby mode.

## NOTE

If you select the memory location which already has a stored number, it replaces the previous number.

## With the base

You can only store numbers in the base's memory.

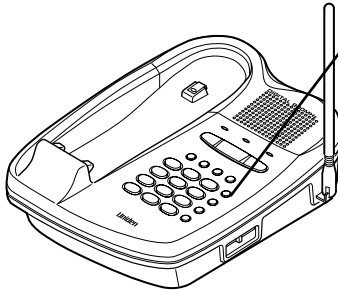

- 1** Press **memory**.  
The **status** LED blinks.
- 2** Dial the number you want to store (up to 20 digits).
- 3** Press **memory** and enter the memory location number (0-9) on the keypad. A confirmation tone sounds, and the number is stored.

# Making calls with memory dialing

## With the handset

### Memory dialing from standby

#### NOTE

If you press **select/ch** before **talk** you can confirm the name and number stored in the selected memory location.

#### NOTE

To exit the memory function without dialing, press **memory**. The handset returns to standby.

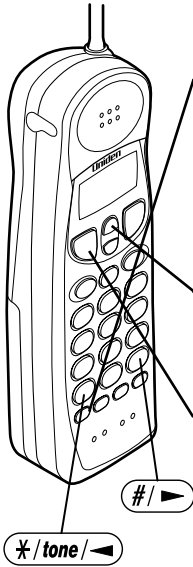

- 1 Press **memory**. The handset displays your programmed memory locations.

```
01 UNIDEN CORP
02 JOHN DOE
03 MOM AND DAD
```

- 2 Press **down** and **up** or enter a two-digit number (01 - 20) to select the memory location you would like to dial.

- 3 Press **talk**. "Talk" flashes and the volume setting appears on the display. Then the displayed number is dialed.

```
Talk
0123456789012
```

### Display a Programmed Number

Use **#** and **\*/tone** to toggle between the names and the numbers display.

#### Program name

```
01 UNIDEN CORP
02 JOHN DOE
03 MOM AND DAD
```

#### Program number

```
01 8178583300
02 5452930
03 8175551212
```



When the stored phone number has 14 or more digits, "➔" is displayed next to the 12th digit. Press **#** to see the extra digits and **\*/tone** to return.

```
05
06 011813554329➔
07
```

```
+3000000
```



## Memory dialing from talk mode

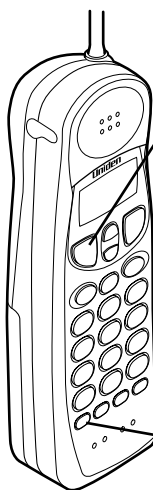

- 1** Press **talk**.  
“Talk” flashes and the volume setting appears.

```
Talk
```



```
Talk  
<High>
```

- 2** Press **memory**.

```
Talk 0:00
```

- 3** Enter a two-digit number (01 - 20) to select the memory location of the desired phone number. The selected phone number is displayed. Then the number is dialed.

```
Talk 0:35  
0123456789012
```

## With the base

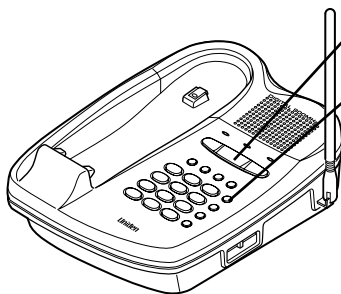

- 1** Press **speaker**.

- 2** Press **memory** and enter the memory location number (0-9).  
Then the stored number will be dialed.

## Editing a stored name and/or phone number

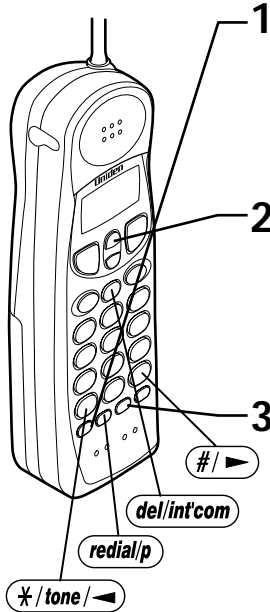

1 Press and hold **(memory)** until the display shows the memory screen and any saved name/number.

```
Memory Store
01 UNIDEN CORP
02 JOHN DOE
```

2 Press **(▼)** and **(▲)** or enter a two-digit number (01 - 20) to select the memory location you would like to edit.

```
Memory Store
01 UNIDEN CORP
02 JOHN DOE
```

3 Press **(select/ch)**.  
The following screen appears with the memory location number that you have selected in the display.

```
► Edit Memory01
Delete Memory01
Go Back
```

4 Press the **(▲)** or **(▼)** to select "Edit Memory", then press **(select/ch)**.  
The following screen appears.

```
Store Name
UNIDEN CORP
```

The cursor flashes indicating that the display is ready for the name to be edited. When a name has not been stored, the cursor appears at the beginning of the second line.

5 Press **(▲)**, **(▼)**, **(#/▶)**, **(\*/tone/◀)**, or **(del/int'com)** to edit the name (See page 18).  
To edit only the phone number, skip this step.

6 Press **(select/ch)**.  
The following screen appears.  
The cursor flashes indicating that the display is ready for the number to be edited.

```
Store Number
017856330
```

- 7** Use the dial keypad, **(redial/p)** or **(del/int'com)** to edit the phone number.  
The phone number cannot exceed 20 digits.  
When the phone number will not be edited, skip this step.

- 8** Press **(select/ch)**.  
The handset beeps and displays the confirmation screen. The memory storage is complete.

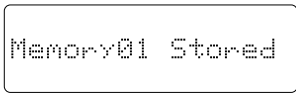

Memory01 Stored

For example, if you store a name and number into memory location number 01, the display shows "Memory01 stored".

After about 2 seconds, "Memory Store" is displayed.

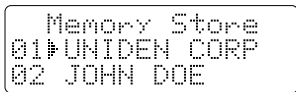

Memory Store  
01 UNIDEN CORP  
02 JOHN DOE

- 9** Press **(memory)** or place the handset on the base to return to standby mode.

# Erasing a stored name and phone number

## With the handset

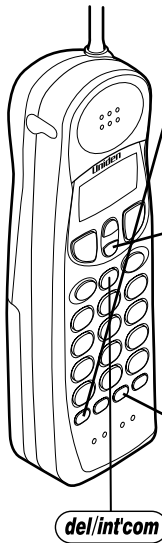

1 Press and hold **memory** until the display shows the memory screen and any saved name/number.

```
Memory Store
01 UNIDEN CORP
02 JOHN DOE
```

2 Press **▼** and **▲** or enter a two-digit number (01 - 20) to select the memory location you would like to erase.

```
Memory Store
01 UNIDEN CORP
02 JOHN DOE
```

3 Press **select/ch**. The following screen appears with the memory location number that you have selected in the display.

```
▶ Edit Memory02
Delete Memory02
Go Back
```

4 Press **▼** to move the cursor down to "Delete Memory" command line.

```
Edit Memory02
▶ Delete Memory02
Go Back
```

5 Press **select/ch**. The following confirmation screen appears.

```
Delete Memory02?
Yes
▶ No
```

6 Press **▲** to move the cursor to "Yes".

7 Press **select/ch** or **del/int'com**. There is a confirmation tone and the entry is deleted. The following screen appears.

```
Memory02 Deleted
```

8 After a few seconds the display returns to the "Memory Store" screen. You may select another number to delete (return to step 2) or press **memory** to return to standby.

```
Memory Store
01 UNIDEN CORP
02▶
```



If you select NO, the display return to Memory Store screen.

## With the base

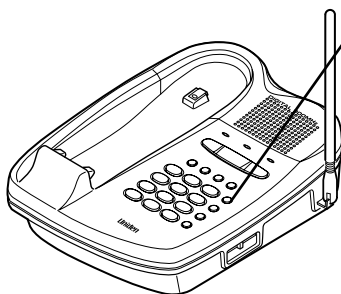

- 1 Press **memory** .  
The **status** LED blinks.
- 2 Press **memory** again.
- 3 Enter the memory location number (0-9) you want to delete. A confirmation tone sounds and the number is erased.

## Mute

You can turn off the base microphone so that the person with whom you are talking cannot hear you.

## When speaking with the base

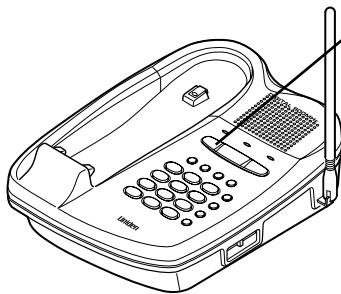

- 1 Press **mute** during a telephone call.  
The **speaker** LED blinks and the microphone is turned off.
- 2 To cancel mute, press **mute** or **speaker** .

## 3-way conference features

### 3-way conference

The Uniden EXT 1865 permits 3-way conversations between the handset, base and an outside line.

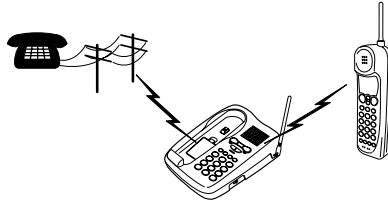

#### NOTE

Pressing the **speaker** key on the base while dialing with the handset will set the 3-way conversation mode, and dialing is not affected.

#### NOTE

Dialing during the 3-way conversation mode is possible only from the handset.

### When speaking on the base

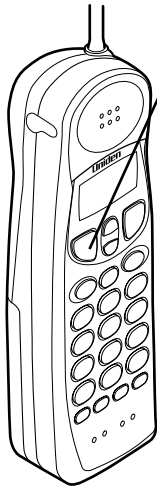

- 1 Press **talk** on the handset. This will set the 3-way conversation mode.
- 2 Press **talk** on the handset to cancel the 3-way conference. The base remains connected to the outside line.

### When speaking on the handset

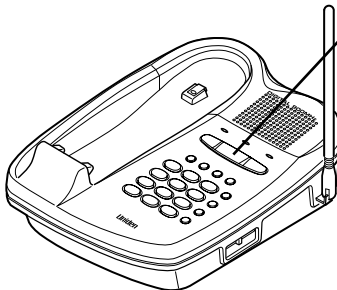

- 1 Press **speaker** on the base. This will set the 3-way conversation mode.
- 2 Press **speaker** on the base to cancel the 3-way conference. The handset remains connected to the outside line.

## Intercom feature

### Using your EXT 1865 intercom

#### Paging from the handset to base

#### NOTE

If the page is not answered within one minute, the paging sound stops automatically.

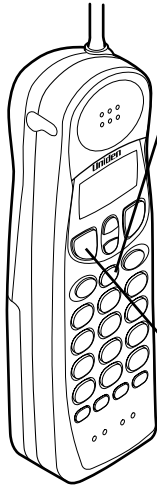

- 1 Press **(del/int'com)** on the handset. (If no answer, press **(del/int'com)** again to disconnect.)

Paging Base

- 2 At the base, press **(page/int'com)** or **(speaker)** to answer. Speak into the base microphone.
- 3 To turn off the intercom, press **(talk)** on the handset or **(speaker)** on the base.

#### Paging from the base to handset

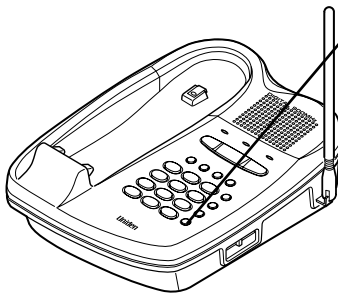

- 1 Press and release **(page/int'com)** on the base. The handset beeps. (If no answer, press **(page/int'com)** again to disconnect.)

Paging

- 2 Press **(del/int'com)** or **(talk)** on the handset to answer. "Intercom" appears on the display.
- 3 To turn off the intercom, press **(talk)** on the handset or **(speaker)** on the base.

## Call transfer feature

### Transferring a call

#### To transfer from the handset to the base

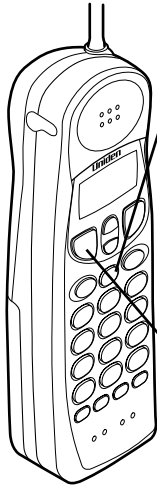

- 1 Press **del/int'com** on the handset. The caller is put on hold and the intercom tone sounds on the base.

Hold  
Paging Base

- 2 Press **page/int'com** or **speaker** on the base. The intercom mode is activated but the caller is still on hold.

- 3 To transfer the call to the base, press **talk** on the handset. To cancel the transfer, press **speaker** on the base.

#### To transfer from the base to the handset

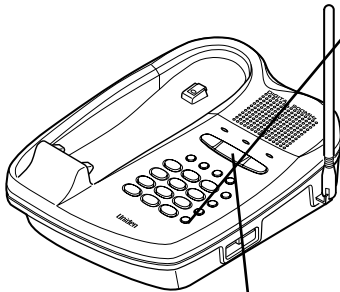

- 1 Press **page/int'com** on the base. The caller is put on hold and the intercom tone sounds on the handset.

Hold  
Paging

- 2 Press **del/int'com** or **talk** on the handset. The intercom mode is activated but the caller is still on hold.

- 3 To transfer the call to the handset, press **speaker** on the base. To cancel the transfer, press **talk** on the handset.





## NOTE

Use of services may result in a fee, please contact your local telephone company for more information.

## Advanced calling features

You can access a list of calling services provided by your local telephone company by pressing the **(menu)** key on the handset or three menu keys (**(call return)**, **(busy redial)** and **(3-way call)**) on the base. You may be required to subscribe to these services before they can be used. Please contact your local telephone company for more or to subscribe.

When you receive a call waiting call, you can also press the **(menu)** key on the handset or one of three menu keys on the base for the list of options to handle the incoming call.

For more information, please refer to the “**Guide to Using Advanced Calling Features**” included in this package.

## Message Waiting Indicator

The **messages** LED indicator on the base is designed to work with voice mail service provided by your local telephone company. The LED will flash to indicate when you have received new voice messages and you can access your mailbox with the **(voice mail)** key. You must subscribe to voice mail service before this feature will operate. Please contact your local telephone company for more details.

Reset the indicator if it remains on after you have retrieved your messages. To reset the indicator, press and hold the **(page/int'com)** key for five seconds or until the LED stops flashing.

For more information, please refer to the “**Guide to Using Advanced Calling Features**” included in this package.



You must subscribe to Caller ID on Call Waiting in order to use this feature.

## Caller ID

**You must subscribe to the Caller ID service to use this feature.**

When the telephone rings, the Caller ID feature allows you to view the caller's name and phone number on the display before you answer the phone.

The handset displays the phone number of the incoming call, the name, time, and the number of calls. Additionally, you can dial the displayed number, and store the information for memory dialing.

### Setting Caller ID options

There are three Caller ID setup options available; they are AutoTalk, CIDCW (Caller ID on Call Waiting), and Area Code.

**AutoTalk** allows you to answer the phone without pressing the **(talk)** button. If the phone rings when AutoTalk is on, simply remove the handset from the cradle and the phone automatically answers the call. If the phone rings when AutoTalk is off, you must press **(talk)** to answer the call.

**Caller ID on Call Waiting (CIDCW)** performs the same as regular Caller ID on a call waiting number. Call Waiting options allow you to handle call waiting calls in seven different ways.

**You must subscribe to CIDCW and CIDCW options from your phone company in order to use this feature.**

If you enter 3-digit area code number in the Area Code option, your local area code does not appear in Caller ID messages. When reviewing Caller ID messages, you will see only the local seven digit number. For calls received from outside your local area code, you will see a full 10-digit number.



If your calling area requires 10-digit dialing, do not program this option.

To change your Caller ID options:

- 1 Press and hold **(call id)**.  
The following screen appears.
- 2 Use **(▲)** and **(▼)** to move the cursor to the selection that you would like to change. Press **(select/ch)** to toggle between "On" and "Off" for "Auto Talk". For CIDCW, choose "On, Off" or "Off" depending on the type of service to which you subscribe.
- 3 When you wish to enter Area Code, press **(▼)** or **(3)** to move the cursor to select "Area Code". Then press **(select/ch)** and enter the 3 digits area code by using the number keypad **(0) - (9)**. After entering Area Code, press **(select/ch)**.
- 4 After you have made your selections, press **(call id)** and return the handset to the charging cradle.



## When the telephone rings

### NOTE

If you answer a call before the Caller ID message is received (Example: before the second ring), the Caller ID message will not appear.

### NOTE

When the call is received via a telephone company that does not offer Caller ID service, the caller's phone number and name do not appear. (This includes international calls.)

### NOTE

When the call is via a private branch exchange (PBX), the caller's phone number and name may not appear.

- 1 When the Caller ID message is received, the display shows the caller's phone number along with the date and time. The incoming call information is stored in Caller ID record. If the Caller ID service includes the caller's name, the caller's name appears on the display (up to 15 letters).

Number of calls from same phone numbers

The date and time received

Caller's name

Caller's phone number

```
5/11 12:30PM 01
UNIDEN CORP
817-858-3300
```

Here are some typical displays;

**When the phone number and name data are received**

```
5/11 12:30PM 01
UNIDEN CORP
817-858-3300
```

**When invalid data is received**

```
Incomplete Data
```

**When a private name is received**

```
5/11 12:30PM 01
Private Name
817-858-3300
```

**When a private number is received**

```
5/11 12:30PM 01
UNIDEN CORP
Private Number
```

**When an unknown name is received**

```
5/11 12:30PM 01
Unknown Name
817-858-3300
```

**When an unknown number is received**

```
5/11 12:30PM 01
UNIDEN CORP
Unknown Number
```

- 2 When you pick up the phone, the display changes to "Talk".

### NOTE

Data errors appear as "■".

```
5/11 12:30PM 01
UNI■EN CORP
813-8■■-3300
```

## NOTE

In Caller ID operation, if no key is pressed for more than 20 seconds, an error tone sounds and the telephone returns to the standby mode.

## NOTE

If a call comes in via a telephone system that does not offer Caller ID service, no information is stored.

## NOTE

"End" appears when you have reviewed all messages in the Caller ID list. Press **(▲)** repeatedly to return to the summary screen.

## NOTE

Each message can be up to 15 characters for the phone number and the name.

## Viewing the Caller ID Message list

The Caller ID list stores information for up to 50 incoming calls - even unanswered calls.

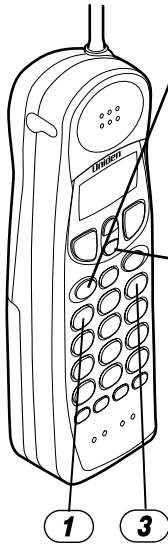

- 1 Press **(call id)**.  
The summary screen appears.  
The screen shows the number of new messages and total messages.

```
New :01
Total:02
```

- 2 Press **(▼)** to display the latest caller ID message.

```
5/17 12:30PM 03
UNIDEN CORP
858-3300
```

- 3 Press **(▼)** to see the next message.  
Or press **(▲)** to see previous message.

- 4 Press **(call id)** to return to standby.

## Long Distance call and area code settings

While the incoming call information is displayed (in step 2), press **(1)** to return a long distance call. The prefix

```
5/17 12:30PM 03
UNIDEN CORP
1-817-858-3300
```

"1-" will be displayed at the beginning of the phone number. Press **(3)** to include the area code. Pressing **(1)** and **(3)** repeatedly sets and cancels these settings. (When the phone number is 15 digits long "..." is not displayed.)

## Deleting information from the Caller ID list

The EXT 1865 stores up to 50 messages. When the phone receives the 51st message, the oldest one in the list is automatically deleted. Caller ID data can also be deleted manually.

### NOTE

If you get an incoming call, the deleting operation is canceled.

### Deleting a Caller ID message

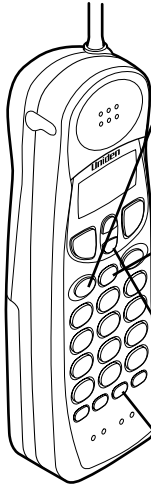

- 1 Press **call id**.  
Display the message to be deleted from the Caller ID list by pressing **▼** or **▲**.

```
5/17 12:30PM 03
UNIDEN CORP
817-858-3300
```

- 2 Press **del/int'com**.

```
Delete Message?
▶ Yes
  No
```

- 3 Press **▼** or **▲** to select "Yes" or "No".

- 4 Press **select/ch** or **del/int'com**.

#### When the pointer is at "Yes":

A tone sounds and the Caller ID message is deleted. Then the next Caller ID message is displayed.

#### When the pointer is at "No":

The display returns to the Caller ID display.

## NOTE

If you get an incoming call, the deleting operation is canceled.

## Deleting all Caller ID name/numbers

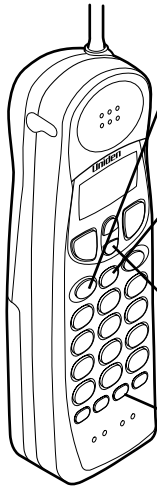

1 Press **call id**.

```
New :01  
Total:02
```

2 Press **del/int'com**.

```
Delete All?  
Yes  
▶No
```

3 Press **▲** or **▼** to select "Yes" or "No".

4 Press **select/ch** or **del/int'com**.

**When the pointer is at "Yes":**

A tone sounds and all stored Caller ID messages are deleted.

```
Total:00
```

**When the pointer is at "No":**

The display returns to the summary screen.

```
New :01  
Total:02
```

## Using the Caller ID list

### Calling a party from the Caller ID list

You can place a call from the Caller ID list.  
The EXT 1865 stores up to 50 messages.

#### NOTE

When a long distance call has been set, "1" appears in the display.

#### NOTE

You cannot make a call from the Caller ID list if your EXT 1865 is connected to private branch exchange (PBX).

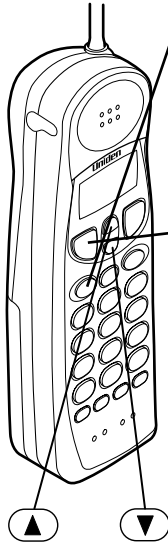

1 Press **call id**.  
Select the phone number that you want to dial by pressing **▼** or **▲**.

```
5/17 12:30PM 03
UNIDEN CORP
817-858-3300
```

2 Press **talk**.  
The displayed phone number dials automatically.

```
Talk
8178583300
```

### Long Distance calls and Area code

Set or cancel a long distance call by pressing **7** then the area code by pressing **3** while the incoming call information is displayed (in step 1).

### Dial edit

You can edit the phone number of Caller ID data when you press **select/ch** after the step 1.

## NOTE

You can not store a Caller ID message, if no phone number appears in the message.

## NOTE

If there is an incoming call or page, memory storage is canceled and the telephone is set to receive the incoming call or page.

## NOTE

If you select No, the display returns to Caller ID message screen.

## Storing Caller ID messages in Memory dialing

Messages shown in the Caller ID list can be stored in memory dialing.

Using the incoming call information (i.e., Caller ID list), the phone number of the party on the Caller ID list can be stored in memory dialing.

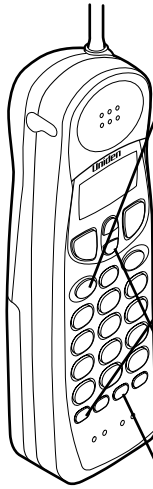

1 Press **(call id)**.

Select the phone number to be stored from the Caller ID list by pressing **(▲)** or **(▼)**.

```
5/17 12:30PM 03
UNIDEN CORP
817-858-3300
```

2 Press **(memory)**.

```
Select Location
1 UNIDEN CORP
2 JONE DOE
```

3 Press **(▼)** and **(▲)** or enter a two-digit number (01-20) to select the memory location you would like to store.

4 Press **(select/ch)**.

A tone will sound. The number is stored in memory and the display returns to the Caller ID list.

```
5/17 12:30PM 03
UNIDEN CORP
817-858-3300
```

If a message has already been stored in the selected memory number's location, a confirmation screen is displayed.

```
Replace Memory?
Yes
No
```

Press **(▲)** to select "Yes". Press **(select/ch)** to overwrite. The display returns to the Caller ID list.

## NOTE



## Using Caller ID on Call Waiting service

“Caller ID” and “Call Waiting” are separate services. CIDCW (Caller ID on Call Waiting) performs the same as regular Caller ID on a call waiting number. You must subscribe to the “Caller ID on Call Waiting (CIDCW) services” before you can use the following features. The call waiting service can be used independently. Please contact your telephone company for details.

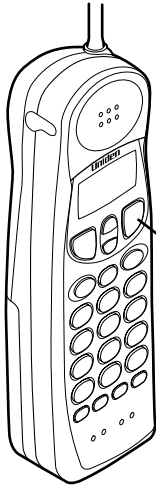

- 1 When a new incoming call is received during your current telephone call, the phone number and the name of the new caller is displayed.

```
Talk 10:30  
UNIDEN CORP  
817-858-3300
```

- 2 Press **call waiting**.  
You will be able to talk with the second caller. The first caller will be put on hold.
- 3 To return to the first caller, press **call waiting** again.

### NOTE

When CIDCW is set to Opt in the Caller ID setup menu (see page 31), you can press the **menu** key after receiving a call waiting call and view a list of ways to handle the new call. Choose an option using the **▲** and **▼** keys and press **select/ch** to activate.

**NOTE**

If the handset battery pack is completely discharged or the battery pack is removed, the digital security code will be lost. If this happens, a new security code is set automatically the next time the battery pack is charged.

**Changing the digital security code**

The digital security code is an identification code used to connect the handset and the base unit. Normally, setting the code is not necessary.

The first time you charge your handset, the security code is automatically set. (See page 2.)

If you suspect that another cordless telephone is using the same security code, you can change the code.

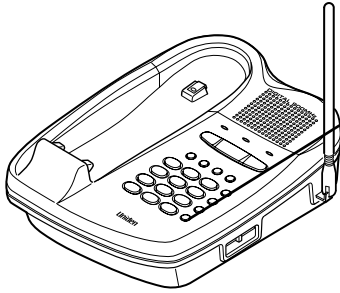

- 1** Remove the handset from the base unit.
- 2** Press and hold *page/int'com*. Return the handset to the base within 4 seconds while holding the key.
- 3** Leave the handset on the base for more than 3 seconds. A random, new security code is set.

**NOTE**

Holding *page/int'com* for more than 5 seconds resets the message indicator (Refer to page 30).



If you have wall mounted the base, you must remove the beltclip to charge the handset with display showing.

## Installing the beltclip

### To attach the beltclip

Insert the beltclip into the holes on each side of the handset. Press down until it clicks.

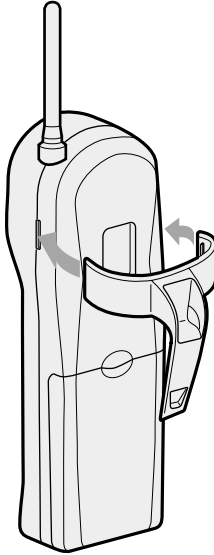

### To remove the beltclip

Pull both sides of the beltclip to release the tabs from the holes.

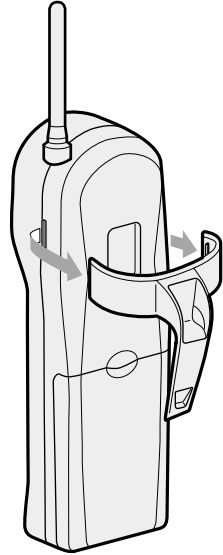

## Headset installation

Your phone may be used with an optional headset, the Uniden HS910. To Use this feature, simply plug the headset plug into the headset jack. Your phone is ready for hands-free conversation.

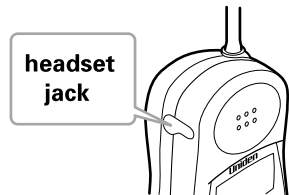

## Note on power sources

### Battery replacement and handling

When the operating time becomes short, even after a battery is recharged, please replace the battery.

With normal usage, your battery should last about one year. Please contact your place of purchase for a replacement battery.

#### Power Failure

During the period that the power is off, you will not be able to make or receive calls with the telephone.

### RECYCLING NICKEL-CADMIUM BATTERIES



Nickel-cadmium cells are used in the battery pack. Please take your used nickel-cadmium battery packs to a store that recycles nickel-cadmium batteries.

#### Caution

- Use the specified battery pack.
- Do not remove the battery from the handset to charge it.
- Never throw the battery into a fire, disassemble it, or heat it.
- Do not remove or damage the battery casing.

## Maintenance

#### When slightly dirty

Wipe with a soft, dry cloth.

#### When very dirty

Wipe with a soft cloth that has been dampened with diluted, neutral detergent. Dry with a dry cloth.

#### When the charging terminals become dirty

Wipe with a dry cloth.

#### Caution

Do not use paint thinner, benzene, alcohol, or other chemical products. Doing so may discolor the surface of the telephone and damage the finish.

## Troubleshooting

If your phone is not performing to your expectations, please try these simple steps first.

Symptom	Suggestion
The <b>status</b> LED won't come on when the handset is placed in the base unit.	<ul style="list-style-type: none"> <li>• Make sure the AC adapter is plugged into the base unit and wall outlet.</li> <li>• Make sure the handset is properly seated in the base unit.</li> <li>• Make sure the charging contacts on the handset and base unit are clean.</li> </ul>
The audio sounds weak and/or scratchy.	<ul style="list-style-type: none"> <li>• Press (<u>select/ch</u>) to select a clearer channel.</li> <li>• Make sure that the base unit antenna is in a vertical position.</li> <li>• Move the handset and or base unit to a different location away from metal objects or appliances and try again.</li> <li>• Make sure that you are not too far from the base.</li> </ul>
Can't make or receive calls.	<ul style="list-style-type: none"> <li>• Check both ends of the base unit telephone line cord.</li> <li>• Make sure the AC adapter is plugged into the base unit and wall outlet.</li> <li>• Disconnect the AC adapter for a few minutes, then reconnect it.</li> <li>• Reset the digital security code (See page 39).</li> <li>• Make sure (<u>talk</u>) is pressed.</li> </ul>
The handset doesn't ring or receive a page.	<ul style="list-style-type: none"> <li>• The battery pack may be weak. Charge the battery on the base unit for more than 17 hours.</li> <li>• The handset may be too far away from the base unit.</li> <li>• Place the base unit away from appliances or metal objects.</li> <li>• Reset the digital security code (See page 39).</li> <li>• Turn on the ringer switch (See page 15).</li> </ul>
The Caller ID/Caller ID on Call Waiting does not display.	<ul style="list-style-type: none"> <li>• The handset was picked up before the second ring.</li> <li>• The call was placed through a switch board.</li> <li>• Call your local telephone company to verify your Caller ID service is current.</li> <li>• Make sure that the CIDCW option is set to On or Opt (See page 31).</li> </ul>

**At Uniden, we'll take care of you!**

If you need any assistance with this product, please call our Customer Hotline at

**1-800-297-1023**

**PLEASE DO NOT RETURN THIS PRODUCT TO THE PLACE OF PURCHASE.**

Our Uniden representatives will be happy to help you with any matters regarding the operation of this unit, available accessories, or any other related matters.

Thank you for purchasing a Uniden product.

Hours: M-F 7:00 AM to 7:00 PM CST.

## Index

### 0-9

3-way Conference .....27

### A

Adjusting ringer and  
earpiece/speaker volume.....15

Advanced Calling Features ..30

### B

Battery pack

    Preparing and charging ...9

    Replacement and  
    handling .....10

### C

Call Waiting.....17

Caller ID

    Caller ID service .....31

    Call Waiting.....38

    Deleting.....34

    Using .....36

    Viewing.....33

Connection.....5

### D

Dialing mode.....6

Digital security code .....2, 39

### E, F, G

Earpiece volume.....15

### H

Headset installation.....40

### I, J, K, L

Installing the beltclip.....40

Intercom feature .....28

### M, N, O

Maintenance.....41

Making a call .....11

Memory dialing

    Making calls

        with memory dialing.....21

        Editing a stored name

        and/or phone number ...23

        Erasing a stored name

        and phone number .....25

        Storing phone

        numbers and names.....18

Mounting the base unit

    on a wall.....7

Mute .....26

### P, Q

Package contents.....3

### R

Receiving a call .....13

Redialing a call .....16

Ringer volume .....15

### S

Setting up the base unit.....4

Speaker volume.....15

### T, U, V, W, X, Y, Z

Transferring a call.....29

Troubleshooting.....42

# THANK YOU

FOR PURCHASING A UNIDEN PHONE!

**Uniden®**

Covered under one or more of the following U.S. patents:

4,511,761 4,523,058 4,595,795 4,797,916 5,381,460  
5,426,690 5,434,905 5,491,745 5,533,010 5,574,727  
5,650,790 5,660,269 5,661,780 5,663,981 5,671,248  
5,717,312 5,754,407 5,768,345 5,787,356 5,838,721

© 2000 Uniden America Corporation

All rights reserved • Printed in China

UCZZ01692BZ



## Free Manuals Download Website

<http://myh66.com>

<http://usermanuals.us>

<http://www.somanuals.com>

<http://www.4manuals.cc>

<http://www.manual-lib.com>

<http://www.404manual.com>

<http://www.luxmanual.com>

<http://aubethermostatmanual.com>

Golf course search by state

<http://golfingnear.com>

Email search by domain

<http://emailbydomain.com>

Auto manuals search

<http://auto.somanuals.com>

TV manuals search

<http://tv.somanuals.com>