

EZAI2997 Series User's Guide

What's in the box?

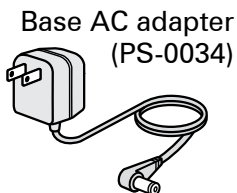

EZAI2997 base with answering system and cordless handset



Base AC adapter (PS-0034)

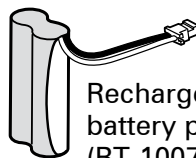

Rechargeable battery pack (BT-1007)

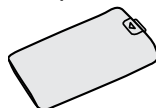

Battery cover

Telephone cord

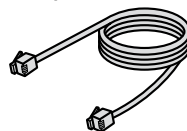

You might also find:



EZX290 accessory handset and charger

Charger AC adapter (PS-0035)

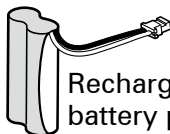

Rechargeable battery pack (BT-1007)



Battery cover

If you purchased model number:	You should have:
EZAI2997	None
EZAI2997-2	1 of each
EZAI2997-3	2 of each
EZAI2997-4	3 of each
EZAI2997-5	4 of each
EZAI2997-6	5 of each

If any items are missing or damaged, contact our Customer Care Line immediately. Never use damaged products!

Need Help? Get answers 24/7 at our website: www.uniden.com.

If You...	Contact Uniden's...	Phone Number
have a question or problem	Customer Care Line*	817-858-2929 or 800-297-1023
need a replacement part or accessory (such as a belt clip, headset, or wall mount bracket)	Parts Department*	800-554-3988
need special assistance due to a disability	Accessibility Help Line	800-874-9314 (voice or TTY)

* During regular business hours, Central Standard Time. Visit our website for detailed business hours.

What's in the manual?

Installing Your Phone	1	Using the Intercom.....	15
Charge the Battery	1	Using Special Features	16
Connect the Telephone Cord.....	2	Using Do Not Disturb	16
Getting to Know Your Phone	3	Adjusting the Base Visual Ringer	16
Base Keys and How They Work	3	Using the Audio Boost	16
Parts of the Handset.....	4	Using Text-To-Speech	16
Using the Menus	7	Using Voice Message Notification.....	17
The <i>Handset Setup</i> Menu	7	Using the Answering System	18
The <i>Ans. Setup</i> Menu	8	Setting Up Your Answering System ...	18
<i>Day & Time</i> Setting	8	Getting Your Messages.....	19
The <i>Global Setup</i> Menu	8	Screening Your Calls.....	20
Entering Text on Your Phone	8	Using the System While You're Away	
Using Your Phone	9	from Home	21
Changing the Volume	10	Solving Problems	22
Using the Redial List.....	10	Weak or Hard To Hear Audio	23
Using Caller ID and Call Waiting.....	11	Noise or Static On The Line	24
Using Seven-Digit Dialing	12	Changing from Tone to Pulse Dialing ..	25
Using the Phonebook.....	12	Resetting and Registering Handsets ...	25
Chain Dialing	13	Handling Liquid Damage	26
Finding a Lost Handset	13	Important Information	27
Using an Optional Headset	13	Terms Used In This Guide	27
Using Multi-Handset Features	14	Specifications	27
Expanding Your Phone	14	Battery Information	27
Using Conference Calling	14	Compliance information	28
Using Privacy Mode	14	One-year Limited Warranty	30
Using Call Transfer	15		

Important Safety Precautions!

When using your telephone equipment, basic safety precautions should always be followed to reduce the risk of fire, electric shock and injury to persons, including the following:

- ◆ **This unit is NOT waterproof.** Do not expose it to rain or moisture.
- ◆ Do not use this product near water, for example, near a bath tub, wash bowl, kitchen sink or laundry tub, in a wet basement or near a swimming pool.
- ◆ Avoid using a telephone (other than a cordless type) during an electrical storm. There may be a remote risk of electric shock from lightning.
- ◆ Do not use the telephone to report a gas leak in the vicinity of the leak.
- ◆ Use only the power cord and batteries indicated in this manual. Do not dispose of batteries in a fire. They may explode. Check with local codes for possible special disposal instructions.
- ◆ Do not place the handset in any charging cradle without the battery installed and the battery cover securely in place.

SAVE THESE INSTRUCTIONS!

Installing Your Phone

Charge the Battery

- 1) Unpack all handsets, battery packs, and battery covers. If any battery cover is already on the handset, press in on the notch and slide the cover down and off.

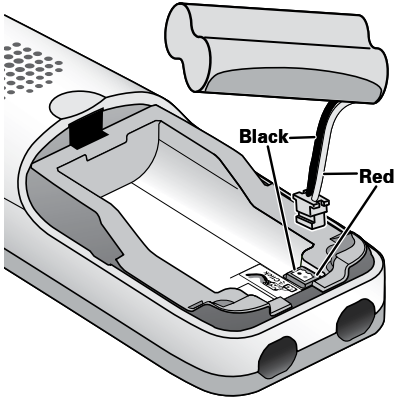
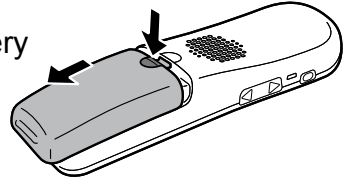

- 2) Line up the red and black wires on the battery pack with the label inside the handset.
- 3) Push the battery pack connector in until it clicks into place. Tug gently on the wires to make sure the battery pack is securely connected.
- 4) Place the cover over the battery compartment and slide it up into place.

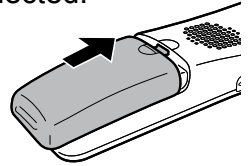

- 5) Connect the base AC adapter to the **AC IN 7.8V** jack on the back of the base. Route the cord through the molded wiring channel as shown.

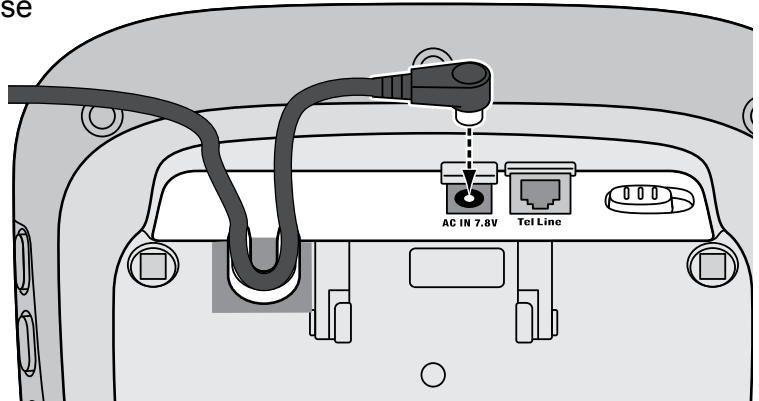

- 6) If you have accessory handsets, connect a charger AC adapter to each charger's **AC IN 8V** jack and set the plug into the notch as shown. (These adapters might already be connected.)
- 7) Plug the other end of each adapter into a standard 120V AC power outlet.

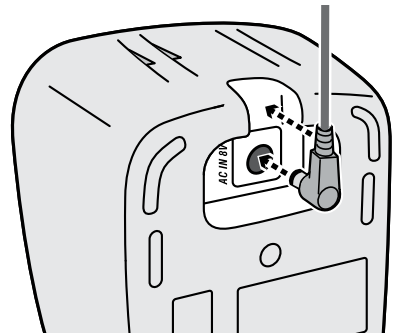

- 8) Place a handset in the base and any accessory handset(s) in the charger(s) with the display(s) facing forward. The **CHARGE** light on the base and each charger should all turn on.

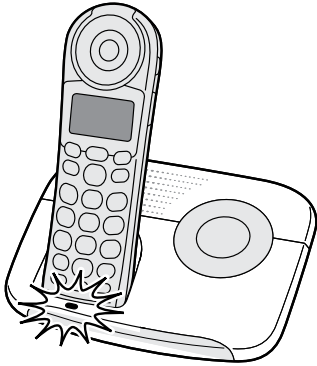

If...	Try...
the CHARGE light does not turn on	- reseating the handset. - checking the AC adapter connection. - seeing if the outlet is controlled by a wall switch.

Charge all handsets completely (about 15 hours) before using them.

Connect the Telephone Cord

Use the telephone cord to connect the **TEL LINE** jack to a standard telephone wall jack.

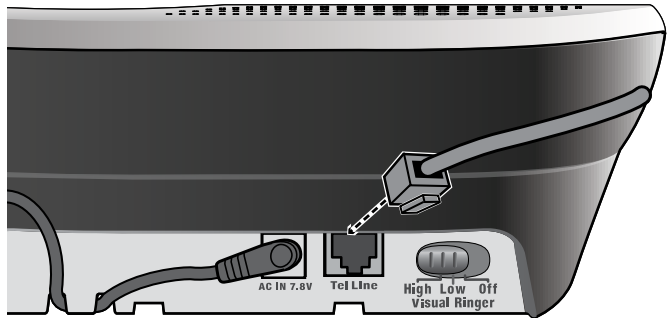

Test the connection

- 1) Pick up the handset from the cradle and press **TALK**. You should hear a dial tone, and the display should say *Talk*.

If...	Try...
you don't hear a dial tone or the display says <i>Check Tel Line</i>	checking the connection between the base and the phone jack.

- 2) Make a quick test call. (Press **TALK** again to hang up.)

If...	Try...
you keep hearing a dial tone	changing to pulse dialing mode (see page 25).
there's a lot of noise or static	see page 24 for tips on avoiding interference.

- 3) Test any accessory handsets the same way. If you can't get a dial tone or the handset display says *Unavailable*, try moving the handset closer to the base or resetting it (see page 25).

Getting to Know Your Phone

Base Keys and How They Work

Front view

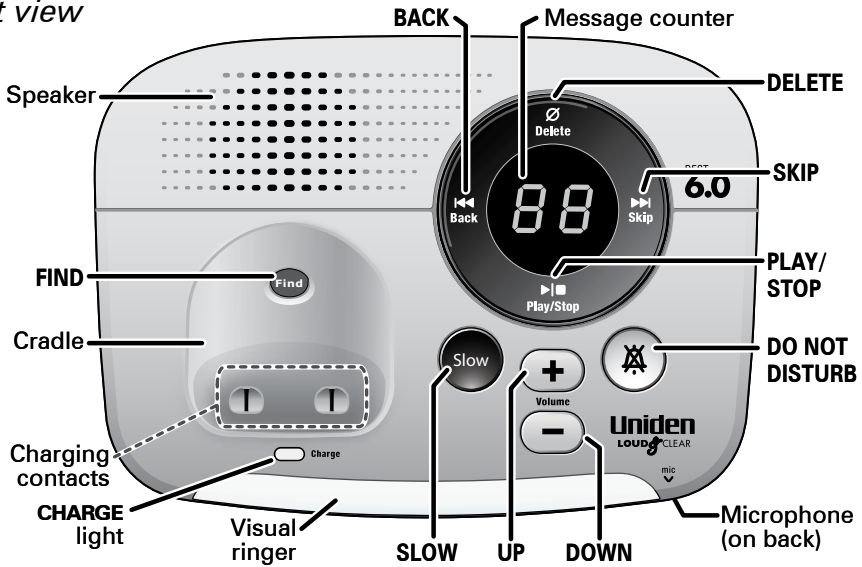

Key name (and icon)	What it does
BACK (⏮)	- In the first 2 seconds of a message: go to the previous message. - Anytime after that: go back to the beginning of this message.
DELETE	- While a message is playing: delete this message. - In standby: delete all messages.
SKIP (⏭)	- While a message is playing: skip to the next message.
PLAY/STOP	- In standby: start playing new messages. - While a message is playing: stop playing messages. - While the phone is ringing: mute the ringer for this call only.
DO NOT DISTURB (🚫)	- In standby: turn the Do Not Disturb feature on or off (see page 16).
DOWN (⏮)	- In standby or while the phone is ringing: decrease the ringer volume. - While a message is playing: decrease the speaker volume.
UP (+)	- In standby or while the phone is ringing: increase the ringer volume. - While a message is playing: increase the speaker volume.
SLOW	- Reduce the speed of the answering system playback by 30%.
FIND	- In standby: page all handsets so you can find a lost one.

Side View

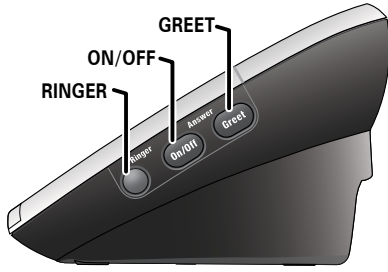

Back View

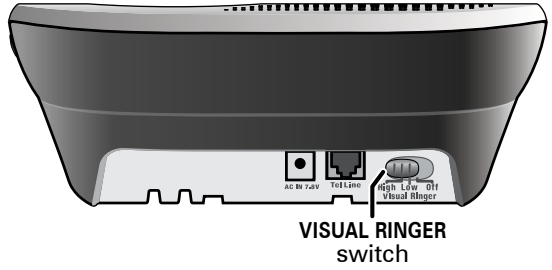

Key name	What it does
RINGER	- In standby: cycle through the 4 different ringer tones.
ON/OFF	- In standby: turn the answering system on or off.
GREET	- In standby: record a new greeting or switch greetings.
VISUAL RINGER switch	- In standby: adjust the brightness of the base visual ringer (see page 16).

Parts of the Handset

If the key name is spelled out on the key itself, it's not labeled in the drawing below.

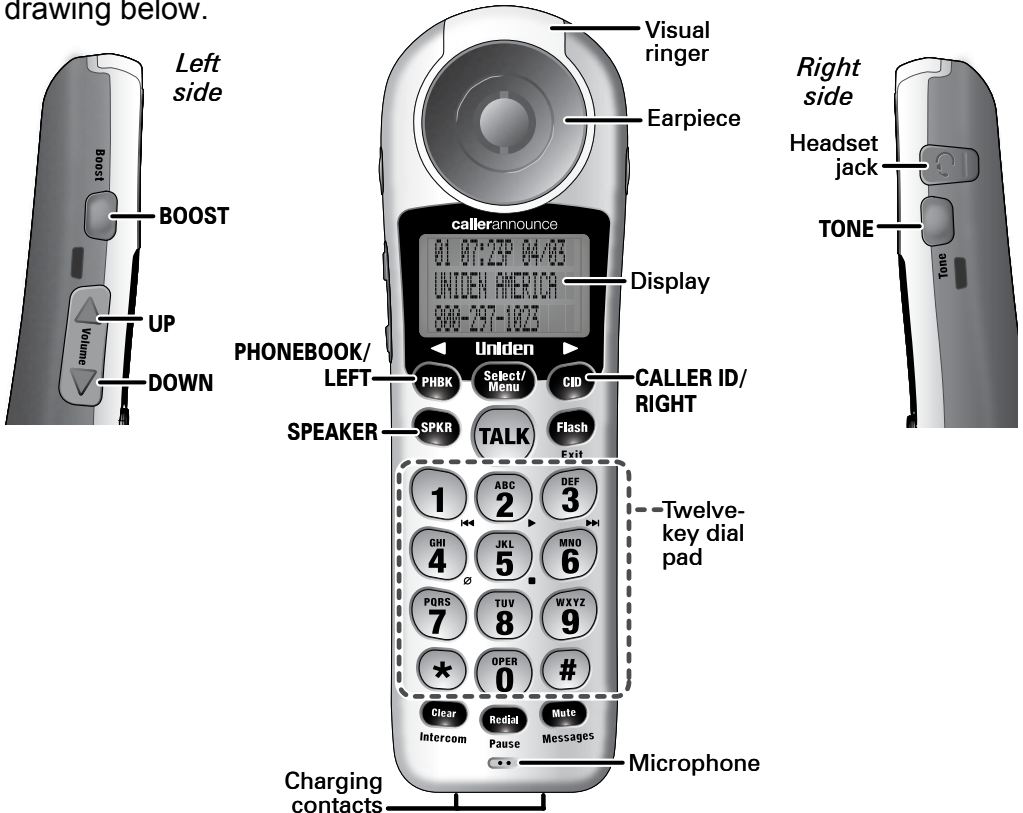







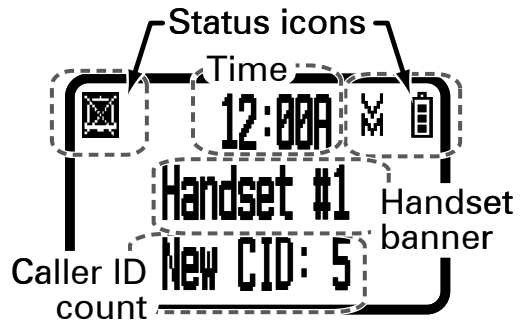

Handset keys and how they work

Key name (and icon)	What it does
PHONEBOOK/ LEFT (PHBK)	<ul style="list-style-type: none"> - In standby or during a call: open the phonebook. - In the menu: go back to the previous screen. - During text entry: move the cursor to the left.
SPEAKER (SPKR)	<ul style="list-style-type: none"> - Switch a normal call to the speakerphone (and back).
SELECT/ MENU	<ul style="list-style-type: none"> - In standby: open the menu. - In the menu or any list: select the highlighted item.
CALLER ID/ RIGHT (CID)	<ul style="list-style-type: none"> - In standby or during a call: open the Caller ID list. - During text entry: move the cursor to the right.
TALK	<ul style="list-style-type: none"> - In standby: start a telephone call (get a dial tone). - During a call: hang up.
FLASH/EXIT	<ul style="list-style-type: none"> - During a call: switch to a waiting call. - While the phone is ringing: mute the ringer for this call only. - In the menu or any list: exit the menu and go back to the previous operation.
CLEAR/ INTERCOM	<ul style="list-style-type: none"> - In standby: page another handset using the intercom. - During a call: put the call on hold and start a call transfer. - While entering text: delete the last character, or press and hold to delete all the characters.
REDIAL/ PAUSE	<ul style="list-style-type: none"> - In standby: open the redial list. - During a phone number entry: insert a two-second pause.
MUTE/ MESSAGES	<ul style="list-style-type: none"> - In standby: access your answering system. - During a call: mute the microphone. - While the phone is ringing: mute the ringer for this call only.
BOOST	<ul style="list-style-type: none"> - During a call: boost the volume of the earpiece (see page 16).
UP (▲)	<ul style="list-style-type: none"> - In standby: increase the ringer volume. - During a call: increase the call volume. - In the menu or any list: move the cursor up one line.
DOWN (▼)	<ul style="list-style-type: none"> - In standby: decrease the ringer volume. - During a call: decrease the call volume. - In the menu or any list: move the cursor down one line.
TONE	<ul style="list-style-type: none"> - During a call: adjust the audio tone (see page 23).

Reading the handset display

The table below shows the possible icons and what they mean. Since the icons appear based on what you're doing with the phone, you won't ever see all of these icons at the same time.



Icon	What it means
	The volume of the earpiece is boosted (see page 16).
	The ringer is turned off: this handset will not ring when a call comes in.
	You have a voice message waiting (see the section titled "Using Voice Message Notification" on page 17).
	Privacy Mode is on: no other handset can use the line or join your call.
	The speakerphone is on.
	The microphone is muted, and the caller can't hear you.
	T-coil mode is on. (See "Do you have a T-coil hearing aid?" on page 24.)
	The battery is 1) fully charged, 2) half charged, 3) getting low, or 4) empty.

Using the Menus

The menus are designed to be as easy as possible. Some users don't even need the manual once they know how to perform these basic actions:

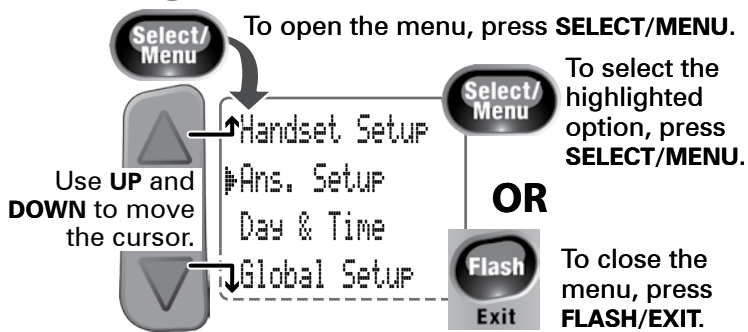

Open the menu	Press SELECT/MENU .
Move the cursor	The arrow cursor on the left side of the line shows which menu item is currently highlighted. Use UP to move the cursor up and DOWN to move it down.
Select an option	Move the cursor to highlight the option, then press SELECT/MENU .
Go back to the previous screen	Press PHONEBOOK/LEFT .
Close the menu	Press FLASH/EXIT .

If you don't press any keys for thirty seconds, the phone times out and exits the menu. (When setting the day and time, the time-out period is extended to two minutes.)

The Handset Setup Menu

You have to change these settings separately for each handset.

<i>T-coil</i>	Turn on T-coil mode to reduce noise on certain hearing aids (see "Do you have a T-coil hearing aid?" on page 24).
<i>Ringer Tones</i>	Choose one of two melodies or five tones for the handset's main ring tone. As you highlight each ring tone, the phone plays a sample of the tone. When you hear the tone you want, press SELECT/MENU .
<i>Personal Ring</i>	Turn on the personal ring feature. If you have Caller ID, this feature lets you assign special ring tones to anyone in your phonebook, and your phone uses the special ring tone when that person calls.
<i>Autotalk</i>	Turn on Auto Talk so you can answer the phone just by picking up the handset from the cradle (without to pressing any buttons).

<i>Any Key Answer</i>	Turn on Any Key Answer so you can answer the phone by pressing any key on the twelve-key dial pad.
<i>Banner</i>	Change the name used on the handset's display.
<i>Handset Language</i>	Change the display language to <i>Spanish</i> or <i>French</i> .
<i>Key Touch Tone</i>	Have your keypad sound a tone when you press a key.
<i>LCD Contrast</i>	Change the contract of the display to make it easier to read. Choose one of ten different levels of contrast.
<i>TTS On/Off</i>	Turn on the Text-To-Speech (TTS) feature (see page 16).

The Ans. Setup Menu

This menu controls the options and settings for your answering system (see "Ans. Setup menu options" on page 19).

Day & Time Setting

You need to set the day and time so messages get the correct time stamp.

- 1) Use **UP** and **DOWN** to choose the day of the week; press **SELECT/MENU**.
- 2) Use the number keypad to enter the hour and minutes.
- 3) Use **UP** and **DOWN** to select *AM* or *PM*; press **SELECT/MENU**.

The Global Setup Menu

The settings on this menu apply to all the handsets and the base. Before changing these settings, make sure the phone is in standby and all handsets are within range of the base. (Only one handset at a time can change these settings.)

<i>Area Code</i>	Enter your area code so the phone hides the area code on incoming local calls (see "Using Seven-digit Dialing" on page 12).
<i>Dial Mode</i>	Change the way your phone communicates with the telephone network (see "Changing from Tone to Pulse Dialing" on page 25).
<i>Set Line Mode</i>	Do not change this setting unless instructed to by customer service.

Entering Text on Your Phone

When you want to enter text into your phone (for example, a name in the phonebook), use the twelve-key dial pad to enter the letters printed on the number keys. Here's how it works:

- ◆ The phone enters the letters in the order they appear on the key. For example, if you press the number key **2** once, the phone enters the letter **A**. Press **2** twice for **B**, and three times for **C**.
- ◆ If you press the key again after the last letter, the phone starts the same letter sequence with small letters. If you press **2** four times in a row, the phone enters **a** (small letter). Press **2** five times for **b**, and six times for **c**.
- ◆ If you see the icon **[Aa]** in the display, the phone enters capital letters first (**A B C**), then small letters (**a b c**), then the number on the key (**2**). The icon **[aA]** means the phone starts at the small letters, so it enters small letters first, then the number on the key, then capital letters.
- ◆ The phone automatically uses a capital letter for the first letter and any letter directly after a space; all other times, it uses small letters.
- ◆ If two letters in a row use the same number key, enter the first letter, then use **CALLER ID/RIGHT** to move the cursor to the next position to enter the second letter.

Switch between capital letters and small letters	Press * .
Move the cursor	Press PHONEBOOK/LEFT to move the cursor to the left. Press CALLER ID/RIGHT to move the cursor to the right.
Leave a blank space	Press POUND (#) .
Erase one letter	Move the cursor to the letter you want to erase and press CLEAR/INTERCOM .
Erase the entire entry	Press and hold CLEAR/INTERCOM .
Enter punctuation or a symbol	Press 0 to rotate through the available symbols.

Using Your Phone

To...	With the earpiece	With the handset speaker
make a call: Dial the number, then...	press TALK . (To switch the call to the speaker, press SPEAKER .)	press SPEAKER . (To switch the call to the earpiece, press SPEAKER .)
answer a call	Press TALK .	Press SPEAKER .
hang up	Press TALK or return the handset to the cradle.	
put a call on hold	Press CLEAR/INTERCOM .	
return to a call on hold	Press TALK .	Press SPEAKER .
mute the microphone during a call	Press MUTE/MESSAGES . Press again to turn the microphone back on.	

Changing the Volume

You can set the ringer and speaker volume separately for the base and each handset. You can change the earpiece volume separately for each handset, also.

The available volume levels and when you can change them are listed below. For each item, press **UP** to make it louder or **DOWN** to make it softer.

Change the	When	On the base	On a handset
ringer volume	the phone is in standby	choose one of 3 volume levels or off	select <i>Off, Low, Medium, or High</i>
speaker volume	the speaker is playing (e.g., when you're listening to messages)	choose one of 10 volume levels	choose one of 6 volume levels
earpiece volume	during a call	NA	choose one of 6 volume levels

To change the volume of Caller ID announcements, change the ringer volume.

Muting the ringer

If you want the base or a handset to stop ringing just for "right now", you can *mute* the ringer instead of turning it off. Muting the ringer basically turns it off for the current call only: the ringer automatically turns back on when the next call comes in.

While the phone is ringing, press **PLAY/STOP** on the base or press **MUTE/MESSAGES** or **FLASH/EXIT** on a handset.

Using the Redial List

Each handset saves the last 5 numbers you dial on it.

Open the redial list	Press REDIAL/PAUSE .
Scroll through the list	Press DOWN to scroll through the list from newest to oldest. Press UP to scroll from oldest to newest.
Close the redial list	Press FLASH/EXIT or PHONEBOOK/LEFT .

With the phone in standby, open the list. Find the number you want, then:

to redial the selected number	Press TALK or SPEAKER .
to delete the number	Press SELECT/MENU and select <i>Delete Entry</i> .
to save it to the phonebook	Press SELECT/MENU and select <i>Store Into Pb</i> .

Using Caller ID and Call Waiting

You have to subscribe to **Caller ID**, **Call Waiting**, and **Caller ID on Call Waiting** services to use the features described in this section: **contact your telephone provider for more information.**

When a call comes in, the phone displays the caller's number and name (if available); if you turned on Text-To-Speech, it also announces the name. The phone saves the information for the last 30 received calls to the *CID list*. When it's in standby, the phone displays how many new calls you've received since the last time you checked the CID list.

Open the CID list	Press CALLER ID/RIGHT .
Scroll through the CID list	Press DOWN to scroll through the list from newest to oldest. Press UP to scroll from oldest to newest.
Close the CID list	Press PHONEBOOK/LEFT .

Dialing from the Caller ID list

- 1) Find the entry you want to dial.
- 2) If the phone number is a long distance or toll call, but the CID record doesn't have a **1** in front of it, press ***** to add the **1**.
- 3) Press **TALK** to dial the number (press **SPEAKER** to use the speakerphone for this call).

You can also press **TALK** or **SPEAKER** before you open the CID list. Find the number you want to dial, then press **SELECT/MENU**.

Caller ID menu options

Open the CID list with the phone in standby. Find the number you want and press **SELECT/MENU** to open the CID menu. You have these options:

<i>Delete Entry</i>	Erase this Caller ID number.
<i>Store Into Pb</i>	Add this number to this handset's phonebook. The handset will prompt you to enter the name, edit the phone number, and choose a personal ring.
<i>Delete All</i>	Erase this handset's CID list. (This does not affect the CID lists saved on any other handsets.)

Using Call Waiting

If you get a Call Waiting call, the phone can sound a tone and display any CID information received for the waiting call. Press **FLASH/EXIT** to switch between your current call and the waiting call; remember, each time you switch, there is a short pause before you're connected to the other caller.

Using Seven-Digit Dialing

If you can make a local call by dialing only seven digits instead of ten, you can tell the phone to hide your local area code in the Caller ID list.

- 1) Open the menu and select *Global Setup*, then select *Area Code*.
- 2) Use the number keypad (0 - 9) to enter your three-digit area code.
- 3) Press **SELECT/MENU** when you're finished.

- ◆ The phone uses the programmed code as a filter. When calls come in, the phone compares the received area code to the programmed one. If they match, the phone hides the area code in the Caller ID list.
- ◆ When you are reviewing the Caller ID list, press **POUND (#)** to toggle the hidden area code.
- ◆ Remember, when you dial a Caller ID record or store it in the phonebook, the phone dials or stores the digits exactly as they appear on the display. If you need to use ten digits, press **POUND (#)** to show the area code before you dial or store the number.

Using the Phonebook

Each handset can store up to 70 entries in its phonebook.

Open or close the phonebook	Press PHONEBOOK/LEFT .
Scroll through the entries	Press DOWN to scroll through the phonebook from A to Z or UP to scroll from Z to A.
Jump to entries that start with a certain letter	Press the number key corresponding to the letter you want to jump to.
Dial an entry	Find the entry you want to dial and press TALK (or SPEAKER).

Phonebook menu options

Open the phonebook with the phone in standby, then press **SELECT/MENU** to open the phonebook menu. Choose one of these options:

<i>Create New</i>	Add an entry to your phonebook. The handset will prompt you to enter the name, edit the phone number, and choose a personal ring.
<i>Copy All</i>	Copy the whole phonebook to another handset. (You must have at least two handsets to use this feature.)
<i>Delete All</i>	Erase all the entries in this handset's phonebook. (This does not affect the entries saved on any other handsets.)

Phonebook entry options

With the phone in standby, open the phonebook and find the entry you want. Press **SELECT/MENU** to open the individual phonebook entry menu. Choose one of these options:

<i>Edit</i>	Edit this entry. The handset will prompt you to edit the name and number, and choose a personal ring.
<i>Copy</i>	Copy this entry to another handset. (You must have at least two handsets to use this feature.)
<i>Delete</i>	Erase this entry.

Chain Dialing

- ◆ If you often have to enter a series of digits or a code number during a call, you can save that code number to a phonebook entry and use the phonebook to send the code number.
- ◆ Enter the code number (up to 20 digits) into the phonebook just like a regular phonebook entry. Be sure to enter the code number into the phonebook exactly as you would enter it during a call.
- ◆ When you hear the prompt that tells you to enter the number, open the phonebook and find the entry that contains your code number. Press **SELECT/MENU** to transmit the code. The phone transmits the code number exactly as you entered it in the phonebook.

Finding a Lost Handset

With the phone in standby, press **FIND** on the base. All handsets will beep for one minute, or until you press **FIND** again or press any key on the found handset.

Using an Optional Headset

You can use a standard 2.5 mm telephone headset with your handsets. To purchase headsets, contact the Parts Department (see the front cover).

- ◆ To install a headset, remove the headset jack cover and insert the headset plug into the jack.
- ◆ Just make and receive calls as usual, and use your headset to talk to the caller after the call connects.
- ◆ When you connect a headset, the handset automatically mutes the earpiece and speaker. To re-activate the earpiece or speaker, just unplug the headset.

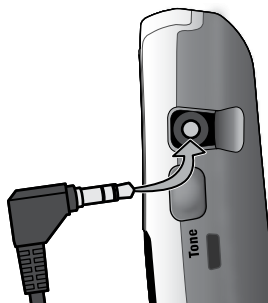

Using Multi-Handset Features

The expandable base works together with the accessory handsets to give you some useful multi-handset features. You must have at least two handsets to use the features in this section.

Expanding Your Phone

- ◆ Your base supports a total of six EZX290 accessory handsets, including any that were supplied with your phone. (The cordless handset that comes with your base counts as one of the six.)
- ◆ Your phone may be compatible with other Uniden accessory handsets. Please visit our website for a list of compatible handsets for your base.
- ◆ Accessory handsets must be registered to the base before you can use them. Handsets that have not been registered display a *Handset not registered* message. See page 25 for instructions on registering handsets to this base, or see the manual for the accessory handset.
- ◆ Any accessory handsets that came packaged with the base are already registered to that base for you.
- ◆ If a handset was previously registered to a base, you have to reset it so you can register it to a new base (see page 25 for EZX290 handsets).

Using Conference Calling

When an outside call comes in, two handsets can join in a conference call with the outside caller. To join the call, just press **TALK**. To leave the conference call, hang up normally; the other handset remains connected to the call. (You can also use the speakerphone for a conference call, just like you can with a normal call.)

Using Privacy Mode

You can prevent other handsets from joining a call. Start your call as usual, then press **SELECT/MENU**: the display shows *Call Privacy*. Press **SELECT/MENU** again to turn privacy mode on (you'll see a  in the display). When you hang up this call, privacy mode turns off automatically.

As long you have privacy mode on, no other handsets can interrupt your call. If you want to allow another handset to join the call, you have to turn privacy mode off. To turn it off, just repeat the process above (press **SELECT/MENU** twice).

Using Call Transfer

You can transfer an outside call to any other handset.

To...	Follow these steps
transfer a call	<ol style="list-style-type: none">1. Press CLEAR/INTERCOM to put the call on hold.2. Select the handset you want to transfer the call to (select <i>A//</i> to page all the handsets). <p>When the other handset accepts the call, you'll be disconnected, but you can join the call again.</p>
cancel a transfer and return to the call	Press TALK .
accept a transferred call	<ol style="list-style-type: none">1. Press CLEAR/INTERCOM to answer the page and speak to the transferring handset.2. To accept the call, press TALK.

Using the Intercom

Here are some general things you need to know about using the intercom:

- ◆ Whenever the phone is in standby, you can make an intercom call between handsets without using the phone line.
- ◆ You can make an intercom call from any handset, but only two handsets can be in an intercom call at any time.
- ◆ If an outside call comes in during an intercom call, the phone displays the Caller ID information. If the other handset hasn't answered the page, the phone cancels the page so you can answer the incoming call.

To...	Follow these steps
make an intercom page	<ol style="list-style-type: none">1. Press CLEAR/INTERCOM.2. Select the handset you want to talk with (select <i>A//</i> to page all handsets).
cancel a page	Press FLASH/EXIT .
answer an intercom page	Press CLEAR/INTERCOM or TALK .
leave an intercom call	Press FLASH/EXIT .
answer an outside call during an intercom call	Press TALK .

Using Special Features

Using Do Not Disturb

- ◆ The *Do Not Disturb* or *DND* feature turns off the audio ringers of the base and all handsets at the same time. It does not affect any of the visual ringers.
- ◆ With the phone in standby, press and hold **DO NOT DISTURB** on the base. The phone automatically turns on the answering system and shows *Do Not Disturb* in the display on all handsets.
- ◆ To cancel, press **DO NOT DISTURB**.

If you turn the answering system off while DND is on, the phone turns off DND along with the answering system.

Adjusting the Base Visual Ringer

The **VISUAL RINGER** switch is at the back of the base; use this switch to change the brightness of the base visual ringer. (It doesn't affect the audio ringers.)

Slide the switch so that its center (marked with the arrow in the picture) lines up with the brightness you want to use: **HIGH**, **LOW**, or **OFF**.

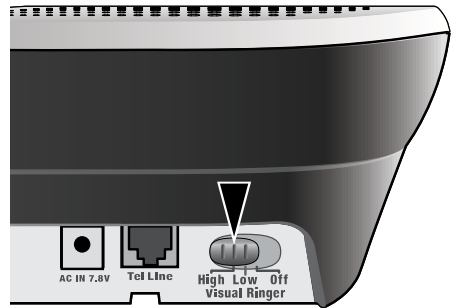

Using the Audio Boost

You can increase the earpiece volume for normal calls and intercom calls. During a call, press **BOOST** to increase the volume of the audio. While audio boost is on,  appears in the display. Press **BOOST** again to turn off.

Using Text-To-Speech

With the Text To Speech (TTS) feature, your phone can announce phone numbers or names in several different situations.

When you... (from standby)	The phone announces...
Receive a call	The caller's name (if sent by a Caller ID service)
Dial a number	The phone number you dialed
Open the phonebook	The name of the entry you are looking at

Things to know about TTS:

- ◆ You have to turn on TTS separately for each handset. Open the menu and select *Handset Setup*. Then, select *TTS On/off*, and select *On* or *Off* for each handset.
- ◆ To make sure it doesn't interrupt a call or an intercom page, the phone only uses TTS when it starts out in standby. For example, if you open the phonebook during a call, the phone won't announce the names in your phonebook.
- ◆ It takes at least 2 rings for the phone to receive Caller ID information and announce it. If the phone is answered before the end of the second ring, the phone won't have time to announce the name of the caller.
- ◆ To change the volume used for Caller ID announcements, change the ringer volume. To change the volume for all other TTS features, change the speaker volume.
- ◆ The TTS feature only uses English to announce the name and numbers, regardless of what language is used for the display or the answering system prompts.

Using Voice Message Notification

This feature supports Frequency-Shift Keying (FSK) message notification. Contact your voice mail provider for more details.

If you subscribe to a voice mail service, your phone can notify you when you have a new message waiting. When you have new messages, the voice message icon () appears in the display.

Resetting the voice message indicator

If the voice message icon won't go away after you check your messages, you can reset it. Press and hold **FIND** until the light turns off (about five seconds).

Your handsets will beep during this process: just ignore them.

Using the Answering System

Setting Up Your Answering System

Recording your outgoing message

Your personal outgoing message or greeting can be between 2 seconds and 30 seconds long. If you don't want to record an outgoing message, the system will use its pre-recorded greeting:

Hello, no one is available to take your call. Please leave a message after the tone.

To record your greeting:

From the base	From a handset
<ol style="list-style-type: none">1. Press and hold GREET until you hear the system say "Record greeting" (about two seconds).2. Wait until the system beeps, then begin speaking. (The message counter light starts counting down from 30 so you know how many seconds are left.)3. When you're finished, press GREET again. The system plays back your new greeting.4. To keep this greeting, do nothing. To re-record it, go back to step 1.	<ol style="list-style-type: none">1. Press MUTE/MESSAGES to access the answering system. Wait until the system finishes its announcements, or press 5 (STOP) to skip them.2. Press 8.3. Wait for the system to say "Record greeting," then begin speaking.4. When you're finished, press 8 to stop recording. The system plays back your new greeting.5. To keep this greeting, press FLASH/EXIT. To re-record it, go back to step 2.

Switch between the pre-recorded greeting and your own greeting

From the base	From a handset
<ol style="list-style-type: none">1. Press GREET. The system plays back the greeting it is currently using.2. Press GREET again to switch greetings.	<ol style="list-style-type: none">1. Press MUTE/MESSAGES to access the answering system. Wait until the system finishes its announcements, or press 5 (STOP) to skip them.2. Press 6. The system plays back the greeting it is currently using.3. Press 6 again to switch greetings.

Delete your greeting

From the base	From a handset
<ol style="list-style-type: none">1. Switch to your personal greeting following the steps above.2. While the system is playing back your greeting, press DELETE.	<ol style="list-style-type: none">1. Switch to your personal greeting following the steps above.2. While the system is playing back your greeting, press 4.

Ans. Setup menu options

You can change the answering system options from any handset. Just open the menu and select *Ans. Setup*.

<i>Security Code</i>	Enter a 2-digit PIN so you can access your answering system from any touch-tone phone (see page 21).
<i>Ring Time</i>	Set the number of rings (2, 4, or 6) before the answering system answers the phone. Choose <i>Toll Saver (TS)</i> to have the system pick up after 2 rings if you have new messages or after 4 rings if you don't.
<i>Record Time</i>	Set the amount of time callers have to leave a message, either 1 minute or 4 minutes. Choose <i>Announce Only</i> if you don't want the system to let callers to leave a message.
<i>Message Alert</i>	Have the system beep every 15 seconds when you have a new message; the beeping stops when you listen to all your new messages. (To mute the alert without listening to your messages, press any key on the base.)
<i>Ans. Language</i>	Change the language of the system's voice prompts.
<i>Call Screen</i>	Turn on the call screen feature so you can hear callers as they leave messages on the base speaker (see page 20).
<i>Ans. On/off</i>	Turn your answering system on or off. (To turn your system on or off from the base, just press ON/OFF .)

Getting Your Messages

Accessing your answering system from a handset

You can access your system from a handset whenever the phone is in standby.



Press **MUTE/MESSAGES** to start remote operation mode.



- ◆ During remote

Use **PHONEBOOK/LEFT** to go to the previous option.



Press **SELECT/MENU** to choose the current option.

Use **CALLER ID/RIGHT** to go to the next option.

Press **FLASH/EXIT** to stop remote operation mode.

waiting for your next command.

- ◆ You can press the number key next to the commands instead of scrolling through them.

- ◆ If you don't press any keys for 30 seconds, the phone returns to standby.

How to operate your answering system

To...	From the base	From a handset (start remote operation first)
play new messages	Press PLAY/STOP The system announces the number of new and old messages, then plays the first new message followed by the day and time it was received. Then the system plays the new messages in the order they were received.	Press MUTE/MESSAGES .
restart the current message	Press BACK .	Press 1 or select <i>1:Repeat</i> .
replay previous messages	Press BACK repeatedly until you hear the message you want to replay.	Press 1 or select <i>1:Repeat</i> repeatedly until you hear the message you want to replay.
skip a message	Press SKIP .	Press 3 or select <i>3:Skip</i> .
slow down message playback	Press SLOW . Press again to return to normal playback speed.	Not available.
delete a message	While the message is playing, press DELETE .	While the message is playing, press 4 or select <i>4>Delete</i>
delete all of your messages	With the phone in standby, press DELETE . When the system asks you to confirm, press DELETE again.	Not available.
play old messages	After the system plays the new messages, press PLAY/STOP again.	press 2 or select <i>2:Play</i> .
end the operation	Press PLAY/STOP .	Press FLASH/EXIT .

Screening Your Calls

Another feature your answering system gives you is *call screening*. While the system is taking the message, you can listen to the caller from a handset or over the base speaker (if you turn on *Call Screen*).

To...	From the base	From a handset
hear the caller leaving a message	Listen to the caller over the speaker.	Press MUTE/MESSAGES .

To...	From the base	From a handset
answer the call	Not available	Press TALK .
mute the call screen without answering	Press PLAY/STOP .	Press FLASH/EXIT or return the handset to the cradle.

- ◆ If you mute the call screen, the system continues taking the message: it just stops playing through the speaker.
- ◆ Only one handset at a time can screen calls. If another handset is screening the call, the handset beeps and returns to standby.

Using the System While You're Away from Home

You can also operate your answering system from any touch-tone phone. Before you can use this feature, you have to program a security code.

Programming a security code

- 1) With the phone in standby, open the menu from any handset.
- 2) Select *Ans. Setup*, then select *Security Code*.
- 3) Use the number keypad to enter a two-digit security code (01 to 99). Press **SELECT/MENU** when you're finished.

Remember to make a note of your new security code!

Dialing in to your system

- 1) Call your telephone number and wait for the system to answer. (If your answering system is off, it will answer after about ten rings and sound a series of beeps instead of your greeting.)
- 2) During the greeting (or beeps), press **0** and **immediately** enter your security code. (You have 3 tries to enter you security code: if you enter it wrong 3 times, the system hangs up and returns to standby.)
- 3) The system announces the current time, the number of messages stored in memory, and a help prompt. Then it starts beeping intermittently to let you know it's waiting for your command.
- 4) When you hear the intermittent beeping, enter a command from the chart to the right.

If you don't press any keys for 15 seconds, the phone will hang up and return to standby.

0-1	Repeat message
0-2	Play message
0-3	Skip message
0-4	Delete message

0-5	Stop playback
0-6	Turn the system on
0-9	Turn the system off
1-0	Hear help prompts

Solving Problems

If you have any trouble with your phone, try these simple steps first. If you still have a question, call our Customer Care Line listed on the front cover.

If...	Try...
No handsets can make or receive calls.	<ul style="list-style-type: none"> - Checking the telephone cord connection. - Disconnecting the base AC adapter. Wait a few minutes, then reconnect it.
One handset can't make or receive calls.	<ul style="list-style-type: none"> - Moving the handset closer to the base. - Resetting the handset.
A handset can make calls, but it won't ring.	<ul style="list-style-type: none"> - Making sure the ringer is turned on. - Making sure Do Not Disturb is turned off.
A handset's display won't turn on.	<ul style="list-style-type: none"> - Charging the battery for 15-20 hours. - Checking the battery pack connection.
A handset is not working.	<ul style="list-style-type: none"> - Checking the battery pack connection. - Charging the battery for 15-20 hours. - Resetting the handset.
A handset says <i>Unavailable</i> .	<ul style="list-style-type: none"> - Moving the handset closer to the base. - Seeing if another handset has Privacy Mode on. - Making sure the base is plugged in.
No handsets will display any Caller ID information.	<ul style="list-style-type: none"> - Letting incoming calls ring at least twice before answering. - Seeing if the call was placed through a switchboard. - Checking with your telephone service provider to make sure your Caller ID service is active.
Caller ID displays briefly and then clears.	<ul style="list-style-type: none"> - You may have to change the line mode. Contact customer service for more information.
Caller ID displays, but I can't hear the CID announcements.	<ul style="list-style-type: none"> - Making sure TTS (Text-To-Speech) is turned on. - Increasing the ringer volume so the CID announcements are louder.
I can't transfer calls.	<ul style="list-style-type: none"> - Resetting all the handsets.
I can't get two handsets to talk to the caller.	<ul style="list-style-type: none"> - Making sure both handsets are registered to this base. - Making sure a handset is not in Privacy Mode.
The phone keeps ringing when I answer on an extension.	<ul style="list-style-type: none"> - You may have to change the line mode. Contact customer service for more information.

If...	Try...
The answering system does not work.	<ul style="list-style-type: none"> - Making sure the answering system is turned on. - Making sure the base AC adapter is plugged into a continuous wall outlet (i.e., not controlled by a wall switch).
The answering system won't record messages.	<ul style="list-style-type: none"> - Making sure the <i>Record Time</i> is not set to <i>Announce Only</i>. - Deleting saved messages (the memory may be full).
My outgoing message is gone.	<ul style="list-style-type: none"> - Seeing if there was a power failure. You may have to re-record your personal outgoing message.
I can't hear the base speaker.	<ul style="list-style-type: none"> - Making sure call screening is turned on. - Changing the base speaker volume.
Messages are incomplete.	<ul style="list-style-type: none"> - The incoming messages may be too long. Remind callers to leave a brief message. - Deleting saved messages (the memory may be full).
The answering system keeps recording when I answer on an extension.	<ul style="list-style-type: none"> - You may have to change the line mode. Contact customer service for more information.
I can't register a handset.	<ul style="list-style-type: none"> - Seeing if you already have 6 handsets registered to this base. - Resetting the handset.

Weak or Hard To Hear Audio

If a caller's voice sounds weak or soft, the signal might be blocked by large metal objects or walls; you might also be too far from the base, or the handset's battery may be weak.

- ◆ Try moving around while you're on a call or moving closer to the base to see if the sound gets louder.
- ◆ Make sure the handset's battery is fully charged.
- ◆ Try adjusting the volume of the earpiece or the audio tone (see below).

Adjust the audio tone

During a call, press **TONE** to cycle through the three audio tone options: *High Tone*, *Natural Tone* (recommended for hearing aid users), or *Low Tone*. (The tone setting appears in the display as you do this.) You may have to experiment to figure out which audio tone works best for you.

Noise or Static On The Line

The most common cause of noise or static on a cordless phone is interference. Here are some common household sources of interference:

- ◆ electrical appliances, especially microwave ovens
- ◆ computer equipment, especially wireless LAN equipment and DSL modems
- ◆ radio-based wireless devices, such as room monitors, wireless controllers, or wireless headphones or speakers
- ◆ large florescent light fixtures (especially if they give off a buzzing noise)
- ◆ other services that use your phone line, like alarm systems, intercom systems, or broadband Internet service

Do you have a T-Coil hearing aid?

If you have a hearing aid equipped with a telecoil (T-coil) feature, the interaction between the hearing aid and digital cordless phones can cause noise in the handset. If you have a T-coil hearing aid and you have problems with noise on the line, try turning on *T-coil* mode. Open the menu. Select *Handset Setup*, then select *T-coil*.

Using T-coil mode can shorten the handset's talk time; make sure to watch your battery status and keep the battery charged.

Here are some hints for when the static is...

on 1 handset or in 1 location:	on all handsets or in all locations:
<ul style="list-style-type: none">- Check nearby for one of the common interference sources.- Try moving the handset away from a suspected source, or try moving the suspected source so it's not between the handset and the base.- Try moving closer to the base. There is always more noise at the edges of the base's range. If the handset displays an <i>Out of Range</i> message, you need to move closer to the base.	<ul style="list-style-type: none">- Check near the base for the source of interference.- Try moving the base away from a suspected source, or turn off the source if possible.- If the base has an adjustable antenna, try raising the antenna so it stands straight up.- If you have any service that uses the phone line, you might need a filter (see below).

Installing a telephone line filter or DSL filter

Sometimes, broadband Internet services that use the telephone line can interfere with phones. One of these services—DSL—often causes static on telephones. A *DSL filter* or telephone line filter usually solves this problem. The technician who installed your DSL service might have left some filters for you; if not, call your DSL provider or look in any electronics store.

Plug the DSL filter into the telephone wall jack and then plug your phone's base into the filter. Make a test call to make sure the noise is gone.

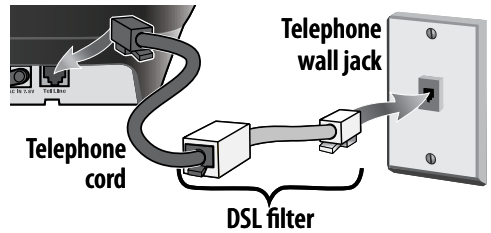

Changing from Tone to Pulse Dialing

Your phone can communicate with the telephone network in two different ways: tone dialing or pulse dialing. These days, most telephone companies use tone dialing. If your phone company uses pulse dialing, you need to change the dial mode.

- 1) With the phone in standby, open the menu and select *Global Setup*.
- 2) Select *Dial Mode*, then select *Pulse*. The phone sounds a confirmation tone.

If you use pulse dialing and you need to send DTMF tones during a call (if you're using an automated response system, for example), press ***** to temporarily switch to tone dialing. When the call ends, the phone automatically returns to pulse dialing mode.

Resetting and Registering Handsets

If you are having trouble with a handset or if you want to replace one, you need to clear the registration information from the base and the handset:

Do you have the base the handset is registered to?	
Yes	No
<ol style="list-style-type: none"> 1. Press and hold FLASH/EXIT and POUND (#) until the <i>System Reset</i> menu appears (about 5 seconds). 2. Select <i>Deregister HS</i>. The display lists all registered handsets. 3. Select the handset you want to reset. 4. When the phone asks you to confirm, select <i>Yes</i>. The handset clears its information from the base and deletes its own link to the base. 	<ol style="list-style-type: none"> 1. Press and hold FLASH/EXIT and POUND (#) until the <i>System Reset</i> menu appears (about 5 seconds). 2. Select <i>Base Unavailable</i>. 3. When the phone asks you to confirm, select <i>Yes</i>. The handset deletes its own link without contacting the base.

When you reset a handset (or if you purchase a new one), that handset displays a *Handset Not Registered* message. If you see this message on a handset, you need to register it to a base before you can use it.

Registering a handset

Does the handset fit in the base cradle?	
Yes	No
Place the handset in the base. The display should say <i>Handset Registering</i> .	<ol style="list-style-type: none">1. Disconnect the base AC adapter.2. Press and hold FIND while you reconnect the adapter.3. On the handset, press and hold POUND (#) until the display says <i>Handset Registering</i> (about 2 seconds).

In about 30 seconds, the display should say *Registration Complete*. Pick up the handset and press **TALK**. Make sure you get a dial tone.

If...	Try...
- you don't hear a dial tone - the display says <i>Registration Failed</i>	Making sure the handset is fully charged, then trying again.

To register a handset to a different base, see the section "Expanding Your Phone" in the user's guide for the other base.

Handling Liquid Damage

Moisture and liquid can damage your cordless phone.

- ◆ If the handset or base is exposed to moisture or liquid, but only the exterior plastic housing is affected, wipe off the liquid & use as normal.
- ◆ If moisture or liquid has entered the plastic housing (i.e. liquid can be heard in the phone or liquid has entered the handset battery compartment or vent openings on the base), follow the steps below:

Handset	Base
<ol style="list-style-type: none">1. Remove the battery cover and leave it off for ventilation.2. Disconnect the battery pack. Leave the battery cover off & the battery pack disconnected for at least 3 days.3. Once the handset is completely dry, reconnect the battery pack and the battery cover.4. Recharge the battery pack for 15-20 hours before using.	<ol style="list-style-type: none">1. Disconnect the AC adapter, cutting off electrical power.2. Disconnect the telephone cord from the base.3. Let dry for at least 3 days.

IMPORTANT: You must unplug the telephone line while recharging the battery pack to avoid charge interruption.

CAUTION! DO NOT use a microwave oven to speed up the drying process. This will cause permanent damage to the handset, base and the microwave oven.

Important Information

Terms Used In This Guide

Accessory Handset	An extra handset that can register to and be used with an expandable phone base. All accessory handsets must be registered to a base.
Base	The main part of the phone. It connects to your phone line and lets you make and receive calls. Most bases also have a cradle to store a handset.
CIDCW	(CID on Call Waiting.) A service that shows CID for calls that come in during another call.
Call Waiting	A service that lets you receive calls while you are on another call.
Caller ID	(Also called CID.) A service that shows the name and number of incoming callers.
Charger	A cradle that stores and charges a handset but doesn't connect to the phone line.
Cradle	The part of the phone that stores a handset. While in a cradle, a handset is always in standby, and any keys are locked.
During a call	The handset is currently on a call or has activated a dial tone.
Handset	A cordless handset that you use to dial the phone and talk to callers.
In standby	The phone is inactive at the moment: there is no dial tone, no handset is on a call or listening to messages.
TTS	(Text to speech) A technology that reads data in a synthesized voice. TTS is used to announce incoming CID information, read numbers from the phonebook, etc.

Specifications

AC adapter		Base	Charger
	Part number	PS-0034	PS-0035
	Input voltage	120V AC, 60 Hz	120V AC, 60 Hz
	Output voltage	7.8V AC @ 450mA	8V AC @ 300mA
Battery pack	Part number	BT-1007	
	Capacity	500mAh, 2.4V DC	

- ◆ Use only the supplied AC adapters.
- ◆ Be sure to use the proper adapter for the base and any chargers.
- ◆ Do not place the base in direct sunlight or subject it to high temperatures.
- ◆ Do not place the power cord where it creates a trip hazard or where it could become chafed and create a fire or electrical hazard.

Battery Information

- ◆ Fully charged, the battery should provide about 10 hours of talk time and about 7 days of standby time. For best results, return the handset to the cradle after each call to keep it fully charged.
- ◆ Keep an eye on the battery status icon. When the battery gets too low, the handset shows a low battery alert. If you hear a strange beep during a call, check the display: if you see the low battery alert, finish your conversation as quickly as possible and return the handset to the cradle. If the handset is in standby, none of the keys will operate.
- ◆ With normal use, the battery should last about one year. Replace the battery when the talk time becomes short even when the battery is charged. To buy a replacement battery, call the Parts Department listed on the front cover.

Rechargeable Nickel-Cadmium Battery Warning

CAUTION! Risk of explosion if battery is replaced by an incorrect type! Dispose of used batteries according to the instructions. Do not open or mutilate the battery. Disconnect the battery before shipping this product.

- ◆ This equipment contains a rechargeable nickel-cadmium (Ni-Cd) battery.
- ◆ Cadmium and Nickel are chemicals known to the State of California to cause cancer.
- ◆ Do not short-circuit the battery.

- ◆ The rechargeable Ni-Cd battery contained in this equipment may explode if disposed of in a fire.
- ◆ Do not charge the battery used in this equipment in any charger other than the one designed to charge this battery as specified in the owner's manual. Using another charger may damage the battery or cause it to explode.
- ◆ As part of our commitment to protecting our environment and conserving natural resources, Uniden voluntarily participates in an RBRC® industry program to collect and recycle used Ni-Cd batteries within the United States. Please call 1-800-8-BATTERY for information on Ni-Cd battery recycling in your area. (RBRC® is a registered trademark of the Rechargeable Battery Recycling Corporation.)



Rechargeable Batteries Must Be Recycled or Disposed of Properly.

Uniden works to reduce lead content in PVC coated cords in our products and accessories.

Warning! The cords on this product and/or accessories contain lead, a chemical known to the State of California to cause birth defects or other reproductive harm. Wash hands after handling.

Compliance information

FCC Part 68 information

This equipment complies with Part 68 of the FCC rules and the requirements adopted by the ACTA. On the bottom of this equipment is a label that contains, among other information, a product identifier in the format US: AAAEQ##TXXXX. If requested, this number must be provided to the phone company.

An applicable Universal Service Order Codes (USOC) certification for the jacks used in this equipment is provided (i.e., RJ11C) in the packaging with each piece of approved terminal equipment. A plug and jack used to connect this equipment to the premises wiring and telephone network must comply with the applicable FCC Part 68 rules and requirements adopted by the ACTA. A compliant telephone cord and modular plug is provided with this product. It is designed to be connected to a compatible modular jack that is also compliant. See installation instructions for details.

The REN is used to determine the number of devices that may be connected to a phone line. Excessive RENs on a phone line may result in devices not ringing in response to an incoming call. In most but not all areas, the sum of RENs should not exceed five (5.0). To be certain of the number of devices that may be connected to a line, as determined by the total RENs, contact the telephone provider. The REN for this product is part of the product identifier that has the format US: AAAEQ##TXXXX. The digits represented by ## are the REN without a decimal point (e.g., 03 is a REN of 0.3).

If this equipment causes harm to the telephone network, the telephone company will notify you in advance that temporary discontinuance of service may be required. But if advance notice isn't practical, the telephone company will notify the customer as soon as possible. Also, you will be advised of your right to file a complaint with the FCC if you believe it is necessary. The telephone company may make changes in its facilities, equipment, operations or procedures that could affect the operation of the equipment. If this happens the telephone company will provide advance notice in order for you to make necessary modifications to maintain uninterrupted service.

Please follow instructions for repairing, if any (e.g. battery replacement section); otherwise do not substitute or repair any parts of the device except as specified in this manual. Connection to party line service is subject to state tariffs. Contact the state public utility commission, public service commission or corporation commission for information. This equipment is hearing aid compatible.

If you experience trouble with this equipment, contact the manufacturer (see the cover of this manual for contact information) or an authorized agent. If the equipment is causing harm to the telephone network, the telephone company may request that you disconnect the equipment until the problem is resolved.

If your home has wired alarm equipment connected to a phone line, be sure that installing the system does not disable your alarm equipment. If you have questions about what will disable alarm equipment, contact your telephone company or a qualified installer.

Any changes or modifications to this product not expressly approved by the manufacturer or other party responsible for compliance could void your authority to operate this product.

NOTICE: According to telephone company reports, AC electrical surges, typically resulting from lightning strikes, are very destructive to telephone equipment connected to AC power sources. To minimize damage from these types of surges, a surge arrestor is recommended.

FCC Part 15 information

This device complies with part 15 of the FCC rules. Operation is subject to the following two conditions: (1) This device may not cause harmful interference, and (2) This device must accept any interference received, including interference that may cause undesired operation. Privacy of communications may not be ensured when using this phone.

FCC PART 15.105(b): Note: This equipment has been tested and found to comply with the limits for a Class B digital device, pursuant to part 15 of the FCC Rules. These limits are designed to provide reasonable protection against harmful interference in a residential installation. This equipment generates, uses and can radiate radio frequency energy and, if not installed and used in accordance with the instructions, may cause harmful interference to radio communications. However, there is no guarantee that interference will not occur in a particular installation. If this equipment does cause harmful interference to radio or television reception, which can be determined by turning the equipment off and on, the user is encouraged to try to correct the interference by one or more of the following measures:

- ◆ Reorient or relocate the receiving antenna.
- ◆ Increase the separation between the equipment and receiver.
- ◆ Connect the equipment into an outlet on a circuit different from that to which the receiver is connected.
- ◆ Consult the dealer or an experienced radio/TV technician for help.

This product complies with FCC radiation exposure limits under the following conditions:

- ◆ The base must be placed to allow a minimum of 20 cm (8 in) between the antenna and all persons during normal operation.
- ◆ The base must not be collocated or operated in conjunction with any other antenna or transmitter.
- ◆ The handset is designed for body-worn operation and meets FCC RF exposure guidelines when used with any belt clip, carrying case, or other accessory supplied with this product. (All necessary accessories are included in the package; any additional or optional accessories are not required for compliance with the guidelines.) Third party accessories (unless approved by the manufacturer) should be avoided as these might not comply with FCC RF exposure guidelines.

Industry Canada (I.C.) Notice

Terminal equipment

NOTICE: This equipment meets the applicable Industry Canada Terminal Equipment Technical Specifications. This is confirmed by the registration number. The abbreviation *IC* before the registration number signifies that registration was performed based on a Declaration of Conformity indicating that Industry Canada technical specifications were met. It does not imply that Industry Canada approved the equipment.

NOTICE: The Ringer Equivalence Number (REN) for this terminal equipment is marked on the equipment itself. The REN assigned to each terminal equipment provides an indication of the maximum number of terminals allowed to be connected to a telephone interface. The termination on an interface may consist of any combination of devices subject only to the requirement that the sum of the Ringer Equivalence Numbers of all the devices does not exceed 5.

Radio equipment

The term *IC* before the radio certification number only signifies that Industry Canada technical specifications were met. Operation is subject to the following two conditions: (1) this device may not cause interference, and (2) this device must accept any interference, including interference that may cause undesired operation of the device. "Privacy of communications may not be ensured when using this telephone".

One-year Limited Warranty

Important: Evidence of original purchase is required for warranty service.

WARRANTOR: UNIDEN AMERICA CORPORATION ("Uniden") ELEMENTS OF WARRANTY:

Uniden warrants, for one year, to the original retail owner, this Uniden Product to be free from defects in materials and craftsmanship with only the limitations or exclusions set out below.

WARRANTY DURATION: This warranty to the original user shall terminate and be of no further effect 12 months after the date of original retail sale. The warranty is invalid if the Product is (A) damaged or not maintained as reasonable or necessary, (B) modified, altered, or used as part of any conversion kits, subassemblies, or any configurations not sold by Uniden, (C) improperly installed, (D) serviced or repaired by someone other than an authorized Uniden service center for a defect or malfunction covered by this warranty, (E) used in any conjunction with equipment or parts or as part of any system not manufactured by Uniden, or (F) installed or programmed by anyone other than as detailed by the owner's manual for this product.

STATEMENT OF REMEDY: In the event that the product does not conform to this warranty at any time while this warranty is in effect, warrantor will either, at its option, repair or replace the defective unit and return it to you without charge for parts, service, or any other cost (except shipping and handling) incurred by warrantor or its representatives in connection with the performance of this warranty. Warrantor, at its option, may replace the unit with a new or refurbished unit. THE LIMITED WARRANTY SET FORTH ABOVE IS THE SOLE and ENTIRE WARRANTY PERTAINING TO THE PRODUCT and IS IN LIEU OF and EXCLUDES ALL OTHER WARRANTIES OF ANY NATURE WHATSOEVER, WHETHER EXPRESS, IMPLIED OR ARISING BY OPERATION OF LAW, INCLUDING, BUT NOT LIMITED TO ANY IMPLIED WARRANTIES OF MERCHANTABILITY OR FITNESS FOR A PARTICULAR PURPOSE. THIS WARRANTY DOES NOT COVER OR PROVIDE FOR THE REIMBURSEMENT OR PAYMENT OF INCIDENTAL OR CONSEQUENTIAL DAMAGES. Some states do not allow this exclusion or limitation of incidental or consequential damages so the above limitation or exclusion may not apply to you.

LEGAL REMEDIES: This warranty gives you specific legal rights, and you may also have other rights which vary from state to state. This warranty is void outside the United States of America and Canada.

PROCEDURE FOR OBTAINING PERFORMANCE OF WARRANTY: If, after following the instructions in the owner's manual you are certain that the Product is defective, pack the Product carefully (preferably in its original packaging). Disconnect the battery from the Product and separately secure the battery in its own separate packaging within the shipping carton. The Product should include all parts and accessories originally packaged with the Product. Include evidence of original purchase and a note describing the defect that has caused you to return it. The Product should be shipped freight prepaid, by traceable means, to warrantor at:

Uniden America Service
4700 Amon Carter Blvd.
Fort Worth, TX 76155

As an Energy Star® Partner, Uniden has determined that this product meets the Energy Star® guidelines for energy efficiency. Energy Star® is a U.S. registered mark.



- ◆ Uniden® is a registered trademark of Uniden America Corporation.
- ◆ Call waiting, CID, CIDCW, and Voice Mail are telephone line services. Your phone supports these services, but you have to arrange for them through your telephone provider. Contact your provider for details.
- ◆ The pictures in this manual are for example only. Your phone may not look exactly like the pictures.

May be covered under one or more of the following U.S. patents:

5,801,466	5,825,161	5,864,619	5,893,034	5,912,968	5,915,227	5,929,598	5,930,720	5,960,358
5,987,330	6,044,281	6,070,082	6,076,052	6,125,277	6,253,088	6,314,278	6,321,068	6,418,209
6,618,015	6,714,630	6,782,098	6,788,920	6,788,953	6,839,550	6,889,184	6,901,271	6,907,094
6,914,940	6,940,867	6,953,118	7,023,176	7,030,819	7,146,160	7,203,307	7,206,403	7,310,398

Other patents pending.
© 2009 Uniden America Corp.
Ft. Worth, TX 76155

Printed in Vietnam
UNZZ01054BA(1)

Free Manuals Download Website

<http://myh66.com>

<http://usermanuals.us>

<http://www.somanuals.com>

<http://www.4manuals.cc>

<http://www.manual-lib.com>

<http://www.404manual.com>

<http://www.luxmanual.com>

<http://aubethermostatmanual.com>

Golf course search by state

<http://golfingnear.com>

Email search by domain

<http://emailbydomain.com>

Auto manuals search

<http://auto.somanuals.com>

TV manuals search

<http://tv.somanuals.com>