

Uniden®

OWNER'S MANUAL

TRU348



24.4GHZ
DIGITAL SPREAD SPECTRUM



Contents

Introduction/Features	2	Memory Dialing	
Controls and Functions	4	Storing phone numbers and names	21
Getting Started		Making calls with memory dialing	23
Read this first	6	Editing a stored name and/or phone number	25
Step 1: Checking the package contents	7	Erasing a stored name and phone number	27
Step 2: Setting up the base unit	8	Telephone Features	
Step 3: Installing the handset battery pack	10	3-way conferencing	28
Step 4: Setting Caller ID options	12	Page	29
Entering your Area Code	13	Caller ID Features	
Basics		Caller ID	30
Making a call	14	When the telephone rings	30
Receiving a call	16	Viewing the Caller ID Message list	31
Adjusting the volume	18	Deleting information from the Caller ID list	32
Redialing a call	19	Using the Caller ID list	33
Traveling out-of-range	20	Using "Caller ID on call waiting" service	35
		Call Waiting Features	36

The Integrated Answering Device

Features	37
Setting up your answering system	38
Using your answering system	42

Additional Information

Changing the digital security code	47
Installing the beltclip	48
Headset installation	48
Note on power sources	49
Maintenance	50
Troubleshooting	51
General Information	53
Technical Information	54
Index	57

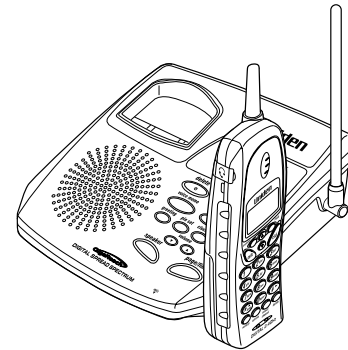

Welcome

Congratulations on your purchase of the TRU 348 cordless telephone. This phone is designed for reliability, long life and outstanding performance utilizing the latest in 2.4 GHz Spread Spectrum technology.

Note: Some illustrations in this manual may differ from the actual unit for explanation purposes.

Features

- 2.4 GHz Spread Spectrum Technology
- Secure Digital Transmission
- Integrated Answering Device
- Caller ID and Call Waiting Caller ID
- Advanced Caller ID with Call Waiting Options
- 50 Number Caller ID Memory
- 20 Number Memory
- 3 Line, 16 Character Backlit Handset Display
- 3 Redial Memories (up to 32 digits)
- Flash and Pause
- Pulse / Tone Dialing
- 10 Day Standby Battery Life
- 6 Hour Talk Time
- Handset Earpiece and Ringer Volume Control
- Base Speakerphone
- 3-Way Conference Operation

Digital Spread Spectrum Technology utilizes a “wider frequency band” vs. a “single narrow band” used in standard digital transmissions. The 2.4 GHz frequency range was recently released to commercial communications. The result is a more secure conversation with the clarity of digital sound, extended range, and minimal interference from other cordless phones.

Random Code™ digital security automatically selects one of over 65,000 codes for the handset and base.

These features enhance your phone’s security and also prevents unauthorized calls as a result of your phone being activated by other equipment.

Throughout this manual, terms such as Standby and Talk Mode are used. Below is the terminology explanation.

- **Standby Mode** - The handset is not in use, off the base and *talk* has not been pressed. A dial tone is not present and the display is blank.
- **Talk Mode** - The handset is off the base and *talk* has been pressed enabling a dial tone. **Talk** appears in the display.

Uniden® is a registered trademark of Uniden America Corporation.

Random Code™ and Auto Talk™ are trademarks of Uniden America Corporation.

Controls and Functions

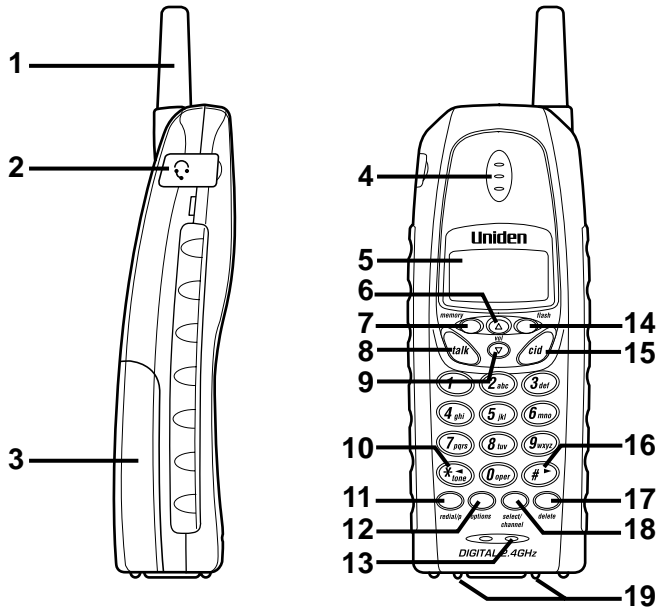

1. Handset Antenna
2. Headset Jack Cover
3. Handset Battery Compartment
4. Handset Earpiece
5. LCD Display
6. Volume Up Key
7. Memory Key
8. Talk Key
9. Volume Down Key
10. * /Tone/Left Cursor Key
11. Redial/p (pause) Key
12. Options Key
13. Handset Microphone
14. Flash Key
15. Caller ID Key
16. # /Right Cursor Key
17. Delete Key
18. Select/Channel Key
19. Handset Charging Contacts

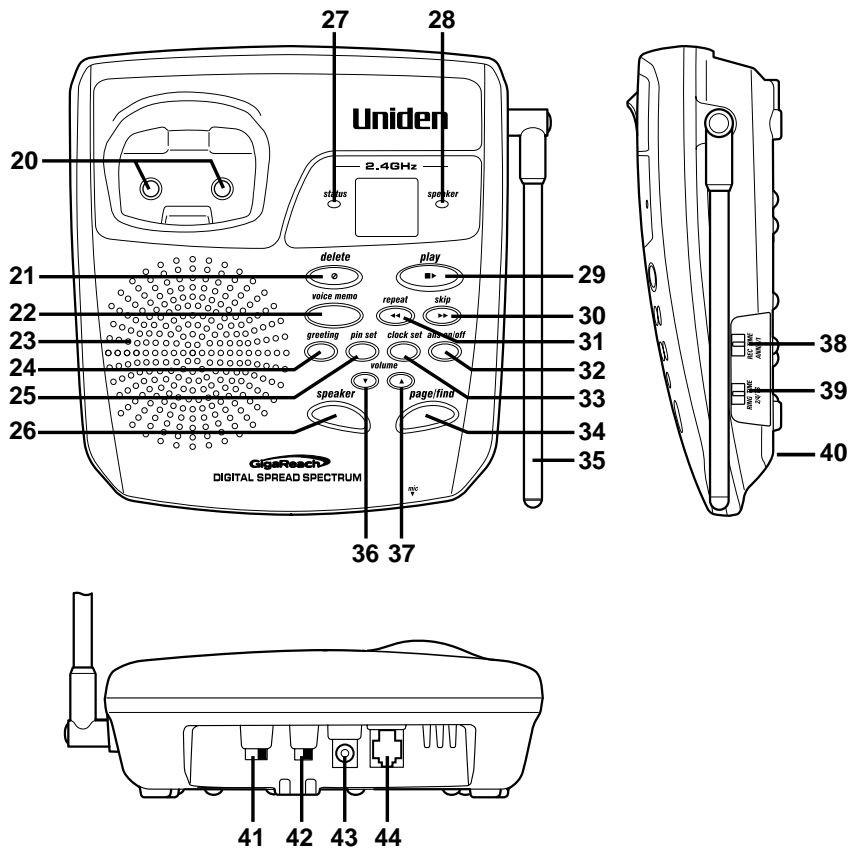

- 20. Base Charging Contacts
- 21. Delete Key
- 22. Voice Memo Key
- 23. Base Speaker
- 24. Greeting Key
- 25. Pin Set Key
- 26. Speaker Key
- 27. Status LED
- 28. Speaker LED
- 29. Play Key
- 30. Skip Key
- 31. Repeat Key
- 32. Answer On/Off Key
- 33. Clock Set Key
- 34. Page/Find Key
- 35. Base Antenna
- 36. Volume Down Key
- 37. Volume Up Key
- 38. Record Time Switch
- 39. Ring Time Switch
- 40. Base Microphone
- 41. Base Ringer Switch
- 42. Pulse-Tone Switch
- 43. DC Power Input
- 44. Phone Jack

Read This First

This cordless telephone must be set up before use. Follow these steps:

Step 1 (page 7)

Unpack the telephone and accessories.

Step 2 (page 8 to 9)

Next, choose the best location to set up the base unit.



Base unit

Step 3 (page 10 to 11)

Then, insert the battery pack into the handset. You must charge the battery pack for **15 hours before plugging into the phone line and using the phone.**



Handset

Step 4 (page 12 to 13)

Finally, set the Caller ID options and store your area code in the memory to use the Caller ID service.



Handset

Note: Skip the area code setting if your calling area requires 10-digit dialing.

About the digital security code

This cordless telephone uses a digital security code to prevent unauthorized access to your base unit. This security code prevents other cordless handsets from making calls through your base unit.

A random security code will be assigned automatically between your base unit and handset when you charge the battery pack for the first time. If you want to reset the security code, see page 47.

Checking the Package Contents

Make sure you have received the following items in the package.
If any of these items are missing or damaged, contact the Uniden Parts Department (see below).

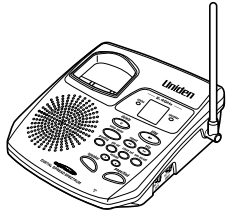

• Base unit



• Handset

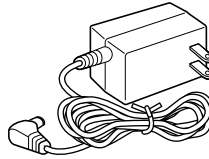

• AC adapter (AD-312)

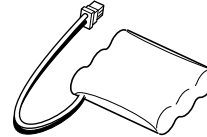

• Rechargeable
battery pack
(BT-905)

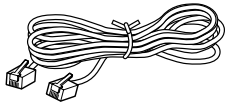

• Telephone line cord



• Beltclip

- This Owner's Manual
- Quick Reference Guide
- Precautions and Important Safety Instructions
- Registration Card

Uniden Parts Department

(800) 554-3988

Hours: M-F 7:00 AM to 5:00 PM CST.

We can also be reached on the web at www.uniden.com

Setting Up the Base Unit

Do the following steps:

- Choose the best location
- Connect the base unit
- Choose the dialing mode

Choose the best location

Before choosing a location for your new phone, read the INSTALLATION CONSIDERATIONS included in the PRECAUTIONS AND IMPORTANT SAFETY INSTRUCTIONS brochure. Here are some important guidelines you should consider:

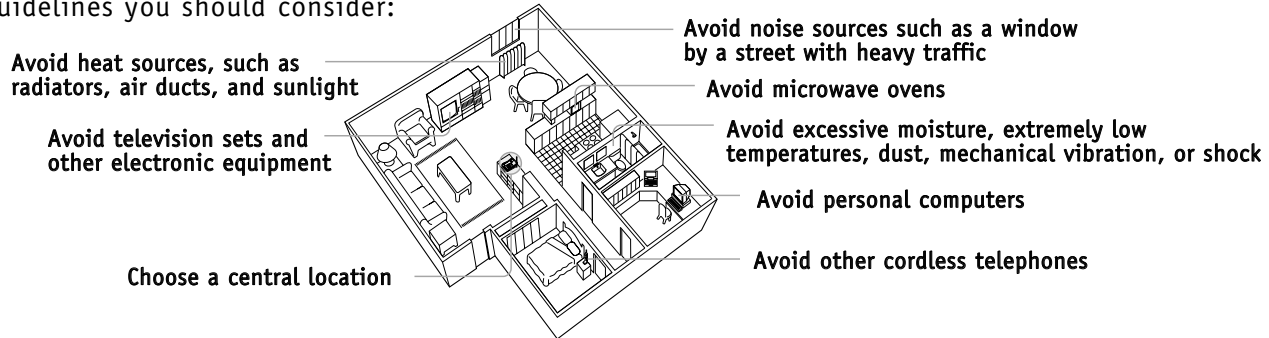

- After installing the battery pack in the handset, you should charge your handset for **15 hours before using the phone**. Once the handset battery pack is fully charged, connect the telephone line cord to the base and telephone wall outlet.
- The location should be close to both a phone jack and a continuous power outlet which is not switchable.
- Keep the base and handset away from sources of electrical noise such as motors and fluorescent lighting.
- Be sure there is sufficient space to raise the base antenna to a vertical position.

Connect the base unit

- 1 Connect the telephone line cord to the **TEL LINE** jack and to a telephone outlet.
- 2 Connect the AC adapter to the **DC IN 9V** jack and to a standard 120V AC wall outlet.
- 3 Set the base unit on a desk or tabletop. Place the handset on the base unit as shown. Then raise the antenna to a vertical position.



If your telephone outlet isn't modular, contact your telephone company for assistance.

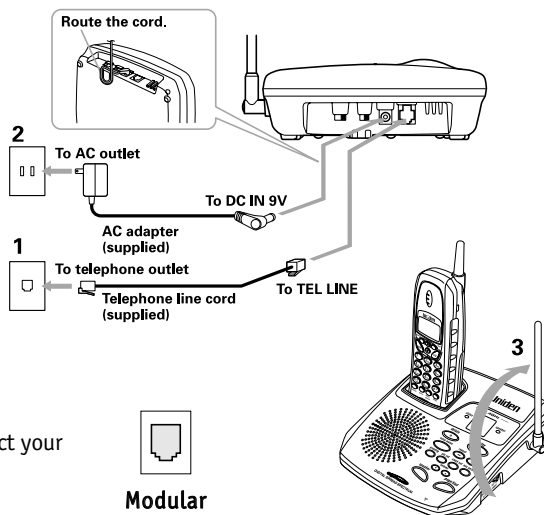

Choose the dialing mode

Depending on your dialing system, set the **PULSE-TONE** switch as follows:

If your dialing system is	Set the switch to
Tone	TONE
Pulse	PULSE

If you aren't sure of your dialing system, make a trial call with the PULSE-TONE switch set to **TONE**.

If the call connects, leave the switch as is; otherwise, set to **PULSE**.

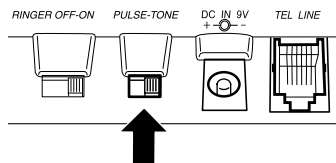

- Place the power cord so it does not create a trip hazard or where it could become chafed and create a fire or electrical hazard.
- Use only the supplied AD-312 AC adapter. Do not use any other AC adapter.
- Connect the AC adapter to a continuous power supply.
- Place the base unit close to the AC outlet so that you can unplug the AC adapter easily.

Installing the Handset Battery Pack

Charge the battery pack for 15 hours before you start using your phone.

- 1 Press in on the battery cover release and slide the cover down until it comes off.
- 2 Connect the battery pack connector with the correct polarity (black and red wires), then insert the battery pack into the battery compartment.
- 3 Slide the battery cover forward until it snaps into place.
- 4 Place the handset on the base as shown.
- 5 Make sure that the **status** LED lights. If the LED doesn't light, check to see that the AC adapter is plugged in and that the handset makes good contact with the base charging contacts.



Use only the Uniden Battery (BT-905) supplied with your phone. Replacement batteries are also available through the Uniden Parts Department (See page 7).

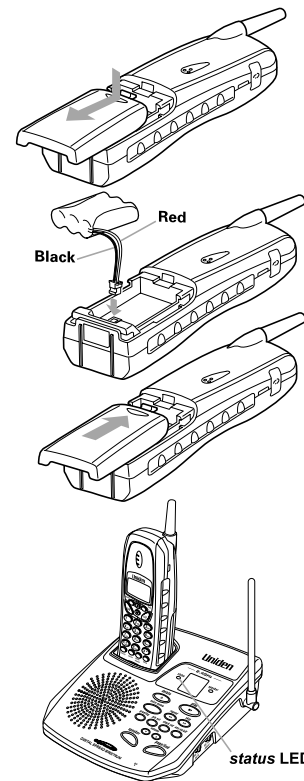

Battery use time (per charge)

From fully charged

- 6 hours continuous use.
- 10 days when the handset is in the standby mode.

When the battery charge becomes low

When the voltage of the battery pack in the handset is very low and needs to be charged, the phone is programmed to eliminate functions in order to save power. If the battery charge becomes low, "Low Battery" appears on the LCD. If during a call, the handset beeps. Complete your conversation as quickly as possible and return the handset to the base unit for charging.

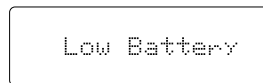

The handset memory backup can hold numbers and names stored in the memory minutes even if the battery pack is completely discharged.

Cleaning the charging contacts

To maintain a good charge, it is important to clean the battery contacts on the handset and base unit with a dry cloth or a pencil eraser about once a month.

Do not use any liquids or solvents.

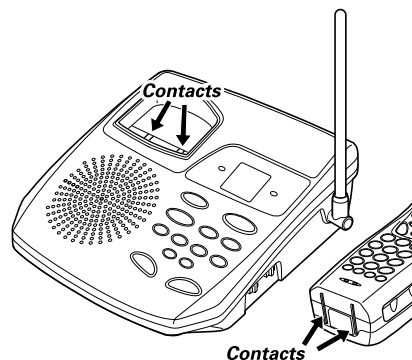

- Even when the battery pack is not being used, it will gradually discharge over a long period of time. For optimum performance, be sure to return the handset to the base unit after each telephone call.
- The previously dialed number in the redial memory is retained for up to 2 minutes while you replace the battery pack.
- If you must replace the battery pack during a telephone call, complete the replacement of the battery pack within 30 seconds, and you can return to the original call.

Setting Caller ID Options

There are three Caller ID setup options available: AutoTalk, CIDCW (Caller ID on Call Waiting), and Area Code. (See page 13 for Area Code setup instructions.)

AutoTalk™ allows you to answer the phone without pressing the **(talk)** button. If the phone rings when AutoTalk is on, simply remove the handset from the base and the phone automatically answers the call. Or if the handset is not on the base, press any key to answer the call. If the phone rings when AutoTalk is off, you must press **(talk)** to answer the call.

Caller ID on Call Waiting (CIDCW) performs the same as regular Caller ID on a call waiting number. Call waiting options allow you to handle call waiting calls in six different ways. (See page 36.)

You must subscribe to CIDCW from your phone company in order to use this feature. The Call Waiting options are a separate service available through your phone company.

To change your Caller ID options:

1 Press **(options)**. The following screen appears.

```
1# Auto Talk:Off
2 CIDCW      :On
3 Area Code#
```

2 Use **(▲)** and **(▼)** or a number key (1-3) to move the pointer to the selection that you would like to change.

Press **(select/channel)** to toggle between "On" and "Off" for "Auto Talk". For "CIDCW", choose "On", "Off", or "Off" depending upon the type of service to which you subscribe.

3 After you have made your Caller ID selections, press **(options)** and return the handset to the base.

Entering Your Area Code

If you enter a 3-digit area code number in the Area Code option, your local area code does not appear in Caller ID messages. Do not program this option, if your calling area requires 10-digit dialing.

When reviewing Caller ID messages, you will see only the local seven digit number. For calls received from outside your local area code, you will see a full 10-digit number.

1 When the phone is in the standby mode, press **(options)** .
The Caller ID setting screen appears.

```
1▶ Auto Talk: Off
2 CIDCW      : On
3 Area Code:
```

2 Press **(3)** to select "Area Code" or press **(▼)** .

```
1 Auto Talk: Off
2 CIDCW      : On
3▶ Area Code:
```

3 Press **(select/channel)** .

```
1 Auto Talk: Off
2 CIDCW      : On
3 Area Code: █
```

4 Use the number keypad (**(0)** to **(9)**) to enter the 3-digit area code.

5 Press **(select/channel)** . A tone sounds and the displayed area code is entered.

6 Press **(options)** to complete the setting or return the handset to the base. The handset returns to the standby mode.

```
1 Auto Talk: Off
2 CIDCW      : On
3 Area Code: 817
```

note

When the area code has already been stored in memory, the stored area code will be displayed. To change it, use the **(delete)** and number keypad to enter the new area code. Then press **(select/channel)** . To complete the setting, press **(options)** or return the handset to the base unit.



If your calling area requires 10-digit dialing, do not program this option.



- Press **(delete)** if you enter a wrong number in step 1. To delete all the numbers that you have entered, press and hold **(delete)** until the display clears.
- You must press a key within 20 seconds or the phone will return to standby.
- Refer to terminology explanation on page 3 if necessary.

Making a Call

Dialing from Standby Mode



1 Enter the phone number.



2 Press **(talk)**.

“Talk” flashes on the display.

Then current volume setting is displayed.



3 The number is dialed. After about 5 seconds, the call-time display appears.



4 To hang up, press **(talk)** or place the handset on the base. The call-time will be displayed for about 5 seconds.



Other Operations

To	Do this
To improve the reception	Press (select/channel) during a call.
To adjust the earpiece volume	Press (▲) or (▼) during a call.
To temporarily switch to tone dial (when the base is set to pulse mode)	Press (←*) . The following numbers will be sent as tone dialing.
To enter a pause within the dialing sequence	Press (redial/p) . “P” appears in the display which represents a pause.

Dialing from Talk Mode

1 Press **(talk)**. "Talk" flashes on the display.

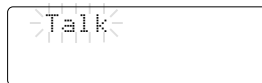

Then the current volume setting is displayed.

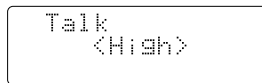

2 Dial the phone number.

Example: Enter 8178583300

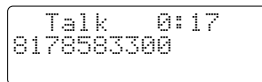

3 To hang up, press **(talk)** or place the handset on the base.
The call-time will be displayed for about 5 seconds.

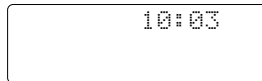

Receiving a Call

From the handset

- 1 The phone rings. "Incoming Call" appears on the display.
- 2 Press **talk**. "Talk" and volume setting appear on the display.
- 3 Talk with the caller.
- 4 To hang up, press **talk** or place the handset on the base. The call-time will be displayed for about 5 seconds.

Incoming Call

Talk 0:00
<Normal>

Talk 0:02

115:35

AutoTalk when ringing

When the AutoTalk setting is on and there is an incoming call, simply lift the handset from the base unit to answer the phone. See "Setting Caller ID Options" on page 12 for more details.

Any key answer when ringing

When the AutoTalk setting is on and the handset is off the base, press any handset key to answer the incoming call.

Call Waiting

Note: You must subscribe to Call Waiting service to use this feature.

When a call is received during a telephone call already in progress, press **flash** to switch to the new call. If you also subscribe to Call Waiting on Caller ID, you will see the name and number of the caller in call waiting. (See page 35.)

From the base

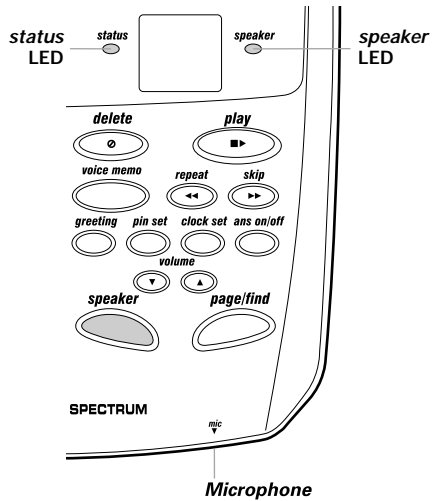

- 1 The phone rings. The **status** LED on the base flashes.
- 2 Press **speaker** and begin speaking. The **speaker** LED lights.
- 3 To hang up, press **speaker** .



The base microphone is located under the base. Position yourself as near to the base as possible and speak clearly.

Adjusting the Volume

Handset ringer tone and volume

Press **▲** or **▼** in Standby mode to select one of four ringer tone and volume combinations. (Refer to terminology explanation on page 3, if necessary.)

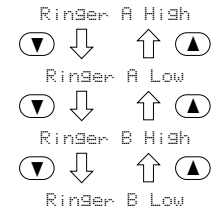

Earpiece volume

Pressing **▲** or **▼** during a call will change the earpiece volume of the handset. This setting will remain in effect after the telephone call has ended.

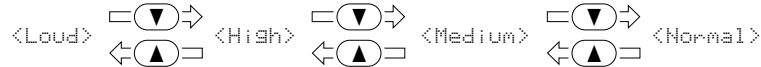

When you press **▲** in Loud mode or **▼** in Normal mode, an error tone sounds.

Base ringer switch

This switch turns the base ringer on or off.

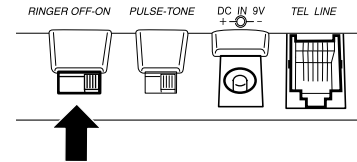

Base speaker volume

To control the speaker volume of the base, adjust the **volume** **▲** and **▼** as desired.

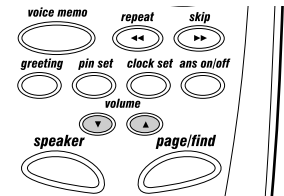

Redialing a Call

The last three phone numbers dialed can be quickly redialed.

Redialing from Standby Mode

From the Handset

- 1 Press **(redial/p)**.

The phone number that was last dialed appears on the display.

- 2 Press **(redial/p)** again.

Each press of **(redial/p)** will display one of the last three numbers dialed.

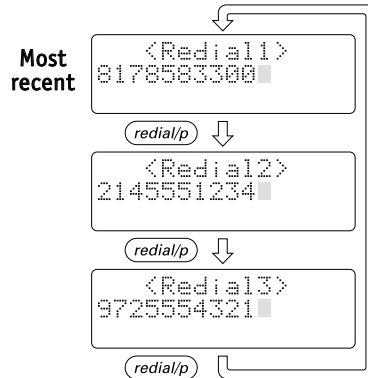

- 3 Press **(talk)**. "Talk" appears on the display, then the volume setting is displayed.
- 4 The selected number is dialed. After about 5 seconds, the call-time display appears.
- 5 To hang up, press **(talk)** or place the handset on the base. The call-time will be displayed for about 5 seconds.



- If the number exceeds 32 digits, only the first 32 digits are retained for redialing.
- Press and hold **(delete)** to delete the displayed redial number.
- Refer to terminology explanation on page 3, if necessary.



Only the last number dialed can be accessed after **(talk)** has been pressed.

Redial from Talk Mode

- 1 Press **(talk)**.
"Talk" appears on the display.
- 2 Press **(redial/p)**.
The last number dialed will be displayed and redialed.
- 3 To hang up, press **(talk)** or place the handset on the base. The call-time will be displayed for about 5 seconds.

Traveling Out-of-Range

During a call, as you begin to move your handset too far from your base unit, noise increases. If you pass the range limits of the base unit, your call will terminate within 30 seconds.

Storing Phone Numbers and Names

Memory Dialing allows you to dial a number using just a few key strokes. Your TRU 348 stores up to 20 names/numbers in the handset.

With the Handset

- 1 Press and hold **memory** until "Memory Store" is displayed.
- 2 Press **▲** and **▼** or enter a two-digit number (01 - 20) to select the memory location where you would like to store the number.

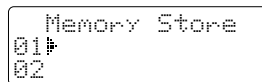

```
Memory Store
01
02
```

- 3 Press **select/channel**. The following screen appears and a cursor flashes indicating that the display is ready for the name to be entered.

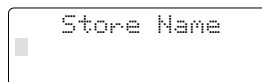

```
Store Name
█
```

If this screen appears, the selected memory location is already stored. Then you must either change the entry in this location, clear the entry in this location, or select "Go Back" to choose another location.

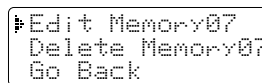

```
▶ Edit Memory07
Delete Memory07
Go Back
```

- 4 Use **▲**, **▼**, **#▶**, ***/tone/◀**, or **delete** to enter the name. The name cannot exceed 13 characters.
 - Use **▲** and **▼** to scroll through the character menu. It contains upper and lower case letters and various characters.
 - Use **#▶** and ***/tone/◀** to move the cursor to the desired location.
 - Use **delete** to delete characters as needed.
 - Press and hold **delete** to delete all the characters.



In memory dialing operation, you must press a key within 20 seconds or the phone will return to standby. If you return the handset to the base, the phone will return to standby also.



- The pause feature is useful for long distance calling, credit card dialing, or sequences that require a pause between digits.
- The 10 memory locations are represented by the numbers 0-9 on the keypad. If you store a number in one of the locations, then attempt to store a different number in the same location later, the new number will overwrite the previous one.

5 Press **(select/channel)**. "Store Number" is displayed. The cursor flashes indicating that the display is ready for the number to be entered.

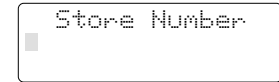

- 6 Use the number keypad to enter the phone number. The phone number cannot exceed 20 digits.
- Use **(redial/p)** to enter pause in the dialing sequence. The display shows a "P". Each pause counts as one digit and represents a two second delay of time between the digits.
 - Use **(delete)** to delete digits as needed.

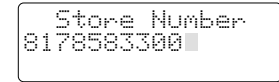

7 Press **(select/channel)**. The handset beeps and displays the confirmation screen. Memory storage is complete. For example, if you store a name and number into memory location number 07, the display shows "Memory07 Stored". After about 2 seconds, "Memory Store" is displayed.

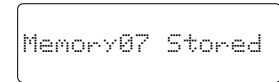

8 Press **(memory)** to return to standby mode.

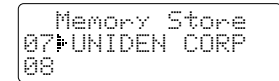

Making Calls with Memory Dialing

With the Handset

Memory dialing from Standby Mode

- 1 Press **(memory)**.
The handset displays your programmed memory locations.
- 2 Press **(▲)** and **(▼)** or enter a two-digit number (01 - 20) to select the memory location you would like to dial.
- 3 Press **(talk)**. "Talk" and the volume setting appear on the display. Then the displayed number is dialed.

```
01 UNIDEN CORP
02 JOHN DOE
03▶MOM AND DAD
```

```
→Talk←
0123456789012
```

Display a Programmed Number

Use **(#▶)** and **(*/tone/◀)** to toggle between the names display and the numbers display.

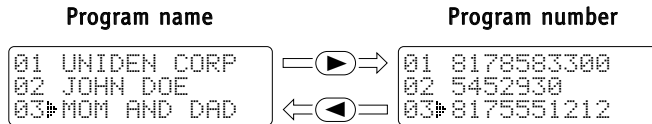

When the stored phone number has 14 or more digits, "▶" is displayed next to the 12th digit. Press **(#▶)** to see the extra digits and **(*/tone/◀)** to return.

```
05 012345678901
06▶011813554329+
07
```



- If you press **(select/channel)** before **(talk)**, you can confirm the name and number stored in the selected memory location. To exit this mode, press and hold **(delete)** until the display clears.
- To exit the memory function without dialing, press **(memory)**. The handset returns to standby.
- Whenever you are using a menu screen, you must press a key within 20 seconds or the phone will return to standby.



If you select a memory location that does not have a stored number, the handset will beep rapidly and the phone will not dial.

Memory dialing from Talk Mode

1 Press **talk**. "Talk" and the volume setting appear.

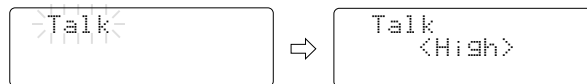

2 Press **memory**.

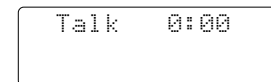

3 Enter a two-digit number (01 - 20) to select the memory location of the desired phone number. The selected phone number is displayed. Then the number is dialed.

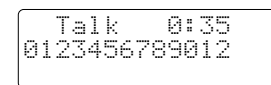

4 To hang up, press **talk**.

Chain Dialing

On certain occasions after dialing a number, you may be requested to enter an access code, such as your account number. You can enter this number into a memory location for later use by doing the following:

- 1 Store the access code into one of the memory locations (01-20) following the steps on page 21.
- 2 Dial the party or service main number.
- 3 When you need to enter the special number, press **memory** followed by the memory location (01-20).

Editing a Stored Name and/or Phone Number

- 1 Press and hold **memory** until "Memory Store" is displayed.
- 2 Press **▲** and **▼** or enter a two-digit number (01 - 20) to select the memory location you would like to edit.
- 3 Press **select/channel**.
The following screen appears with the memory location number that you have selected in the display.
- 4 Press **▲** or **▼** to select "Edit Memory", then press **select/channel**. The following screen appears.
The cursor flashes indicating that the display is ready for the name to be edited. When a name has not been stored, the cursor appears at the beginning of the second line.
- 5 Press **▲**, **▼**, **#▶**, ***/tone/◀**, or **delete** to edit the name.
(See page 21.)
To edit only the phone number, skip this step.
- 6 Press **select/channel**. The following screen appears.
The cursor flashes indicating that the display is ready for the number to be edited.

```
Memory Store
01▶UNIDEN CORP
02 JOHN DOE
```

```
▶Edit Memory01
Delete Memory01
Go Back
```

```
Store Name
UNIDEN CORP█
```

```
Store Number
817858330█
```

7 Use the number keypad, *redial/p* or *delete* to edit the phone number. The phone number cannot exceed 20 digits. (See page 22.)

If you don't want to change the phone number, skip this step.

8 Press *select/channel*. The handset beeps and displays the confirmation screen. The memory storage is complete. For example, if you store a name and number into memory location number 01, the display shows "Memory01 Stored". After about 2 seconds, "Memory Store" is displayed.

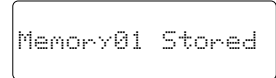
A rectangular box containing the text "Memory01 Stored" in a monospaced font.A rectangular box containing the text "Memory Store" on the first line, "01 UNIDEN CORP" on the second line, and "02 JOHN DOE" on the third line, all in a monospaced font.

9 Press *memory* to return to standby mode.

Erasing a Stored Name and Phone Number

- 1 Press and hold **(memory)** until "Memory Store" is displayed.
- 2 Press **(▲)** and **(▼)** or enter a two-digit number (01 - 20) to select the memory location you would like to edit.
- 3 Press **(select/channel)**.
The following screen appears with the memory location number that you have selected in the display.
- 4 Press **(▼)** to move the pointer down to "Delete Memory" command line.
- 5 Press **(select/channel)**. The following confirmation screen appears.
- 6 Press **(▲)** to move the pointer to "Yes".
- 7 Press **(select/channel)** or **(delete)**.
There is a confirmation tone and the entry is deleted.
The following screen appears.
- 8 After a few seconds the display returns to the "Memory Store" screen.
You may select another number to delete (return to step 2) or press **(memory)** to return to standby.

```
Memory Store
01▶UNIDEN CORP
02 JOHN DOE
```

```
▶Edit Memory02
Delete Memory02
Go Back
```

```
Edit Memory02
▶Delete Memory02
Go Back
```

```
Delete Memory02?
Yes
▶No
```

```
Memory02 Deleted
```

```
Memory Store
02▶
03 MOM AND DAD
```



- Pressing the **speaker** key on the base while dialing with the handset will set the 3-way conversation mode, and dialing is not affected.
- During a 3-way conversation, you can only dial from the handset.

3-way Conferencing

The Uniden TRU 348 permits 3-way conversations between the handset, base, and outside line.

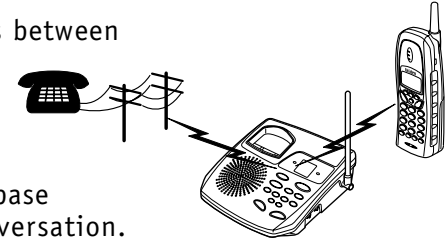

When speaking on the handset

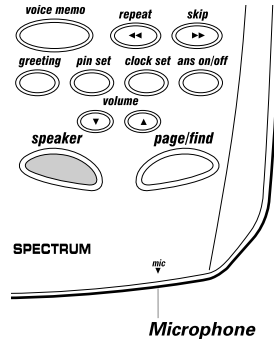

- 1 Press **speaker** on the base to join the 3-way conversation.
- 2 To hang up, press **speaker** on the base. The handset will still be connected to the call.

When speaking on the base

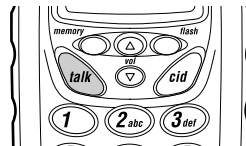

- 1 Press **talk** on the handset to join the 3-way conversation.
- 2 To hang up, return the handset to the base, or press **talk** on the handset. The base will still be connected to the call.

Page

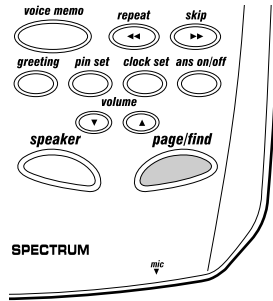

To locate the handset (while it's off the base), press **page/find** on the base. The handset beeps for 5 seconds. Paging is displayed.

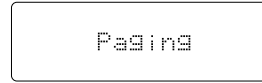

To cancel the page, press any key on the handset, press **page/find** on the base or return the handset to the base. Press and hold **page/find** for more than 2 seconds to page the handset for a minute. If you hold down **page/find** for more than a minute, the handset beeps until you release **page/find**.



- If you press **talk** during paging, the handset will be placed in off-hook (talk) mode.
- When an incoming call is received during paging, paging is canceled and the telephone is switched to the incoming call.



- If you answer a call before the Caller ID message is received (Example: before the second ring), the Caller ID message will not appear.
- When the call is received via a telephone company that does not offer Caller ID service, the caller's phone number and name do not appear. (This includes international calls.)
- When the call is via a private branch exchange (PBX), the caller's phone number and name may not appear.

Caller ID

You must subscribe to Caller ID service to use this feature.

When the telephone rings, the Caller ID feature allows you to view the caller's name and phone number on the display before you answer the phone.

The handset displays the phone number of the incoming call, the name, time, and the number of calls. Additionally, you can dial the displayed number and store the information for memory dialing.

Make sure you have turned on the Caller ID/Call Waiting feature (See page 12).

When the Telephone Rings

- 1 When the Caller ID message is received, the display shows the caller's phone number along with the date and time. The incoming call information is stored in the Caller ID record. If the Caller ID service includes the caller's name, the caller's name appears on the display (up to 15 letters).

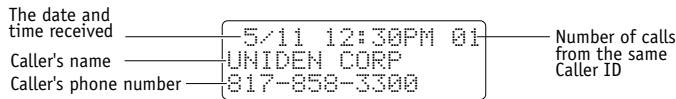

Here are some typical displays;

When the phone number and name data are received

```
5/11 12:30PM 01
UNIDEN CORP
817-858-3300
```

When invalid data is received

```
Incomplete Data
```

When a private name is received

```
5/11 12:30PM 01
Private Name
817-858-3300
```

When a private number is received

```
5/11 12:30PM 01
UNIDEN CORP
Private Number
```

When an unknown name is received

```
5/11 12:30PM 01
Unknown Name
817-858-3300
```

When an unknown number is received

```
5/11 12:30PM 01
UNIDEN CORP
Unknown Number
```

2 When you pick up the phone, the display changes to "Talk".



Data errors appear as "■".

Viewing the Caller ID Message List

The Caller ID list stores information for up to 50 incoming calls - even unanswered calls.

1 Press **(cid)**.

The summary screen appears.

The screen shows the number of new messages and total messages.

```
New :01
Total:02
```

2 Press **(v)** to display the latest Caller ID message.

```
5/17 12:30PM 03
UNIDEN CORP
817-858-3300
```

3 Press **(v)** to see the next message. Or press **(u)** to see previous message.

4 Press **(cid)** to return to standby.



- In Caller ID operation, if no key is pressed within 20 seconds, an error tone sounds and the telephone returns to the standby mode.
- If a call comes in via a telephone system that does not offer Caller ID service, no information is stored.
- "End" appears when you have reviewed all messages in the Caller ID list. Press **(u)** repeatedly to return to the summary screen.
- Each message can be up to 15 characters for the phone number and the name.



- While using the “Delete All?” or “Delete Message?” screen if no key is pressed within 20 seconds, an error tone sounds and the telephone returns to standby.
- If you get an incoming call or page, the deleting operation is canceled and the telephone returns to standby so you can answer the call or page.

Deleting Information from the Caller ID List

The TRU 348 stores up to 50 messages. If the phone receives the 51st message, the oldest one in the list is automatically deleted. Caller ID data can also be deleted manually.

Deleting a Caller ID message

- 1 Press **(cid)**. Display the message to be deleted from the Caller ID list by pressing **(▲)** or **(▼)**.
- 2 Press **(delete)**.
- 3 Press **(▲)** or **(▼)** to select “Yes” or “No”.
- 4 Press **(select/channel)** or **(delete)**.

```
5/17 12:30PM 03
UNIDEN CORP
817-858-3300
```

```
Delete Message?
▶Yes
No
```

When the pointer is at “Yes”:

A tone sounds and the Caller ID message is deleted. The next Caller ID message is then displayed.

When the pointer is at “No”:

The display returns to the Caller ID message.

Deleting all Caller ID names/numbers

- 1 Press **(cid)**.
- 2 Press **(delete)**.

```
New :01
Total:02
```

```
Delete All?
Yes
▶No
```

3 Press **▲** or **▼** to select "Yes" or "No".

4 Press **(select/channel)** or **(delete)**.

When the pointer is at "Yes":

A tone sounds and all stored Caller ID messages are deleted.

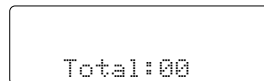

When the pointer is at "No":

The display returns to the summary screen.

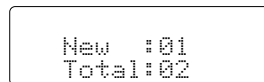

Using the Caller ID List

Calling a party from the Caller ID list

You can place a call from the Caller ID list. The TRU 348 stores up to 50 messages.

1 Press **(cid)**. Select the phone number that you want to dial by pressing **▲** or **▼**.

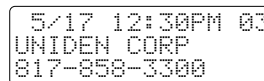

2 Press **(talk)**. The displayed phone number dials automatically.

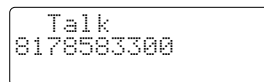

Long Distance calls and Area Code Setting/Cancellation

Pressing **①** while the incoming call information is displayed (in step 1) will set or cancel a long distance call. Pressing **③** will set or cancel an area code setting.

Dial edit

You can edit the phone number of the Caller ID data when you press **(select/channel)** after step 1.



- You cannot make a call from the Caller ID list if your TRU 348 is connected to a private branch exchange (PBX).
- When a long distance call has been set, "1" appears in the display.



- You can not store a Caller ID message if no phone number appears in the message.
- If there is an incoming call or page, memory storage is canceled and the telephone is set to receive the incoming call or page.

Storing Caller ID messages in Memory dialing

Messages shown in the Caller ID list can be stored in memory dialing. Using the incoming call information (i.e., Caller ID list), the phone number of the party on the Caller ID list can be stored in memory dialing.

1 Press **(cid)**.

Select the phone number to be stored from the Caller ID list by pressing **(▲)** or **(▼)**.

```
5/17 12:30PM 03
UNIDEN CORP
817-858-3300
```

2 Press **(memory)**.

```
Select Location
01 UNIDEN CORP
02 JUNE DOE
```

3 Press **(▲)** and **(▼)** or enter a two-digit number (01 - 20) to select the memory location to be stored.

4 Press **(select/channel)**.

A tone will sound. The number is stored in memory, and the display returns to the Caller ID list.

```
5/17 12:30PM 03
UNIDEN CORP
817-858-3300
```



If a message has already been stored in the selected memory number location, a confirmation screen is displayed. Press **(▲)** to select "Yes". Press **(select/channel)** to overwrite. The display returns to the Caller ID list.

```
Replace Memory?
Yes
▶ No
```

Using “Caller ID on Call Waiting” Service

“Caller ID” and “Call Waiting” are separate services. CIDCW (Caller ID on Call Waiting) performs the same as regular Caller ID on a Call Waiting number. You must subscribe to the “Caller ID on Call Waiting (CIDCW) services” before you can use the following features. The “Call Waiting” service can also be used independently. Please contact your local telephone company for details.

1 When a new incoming call arrives during your current telephone call, the phone number and the name of the caller are displayed.

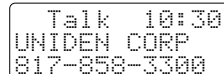

```
Talk 10:30
UNIDEN CORP
817-858-3300
```

2 Press *flash*.

You will be able to talk with the second caller. The first caller will be put on hold.

3 To return to the first caller, press *flash* again.



When CIDCW is set to “OFF” in the Caller ID setup menu (see page 12), you can press the *options* key after receiving a call waiting call and view a list of ways to handle the new call. Choose an option using the ▲ and ▼ keys and press *select/channel* to activate.



You can also answer a call waiting call immediately by pressing **(flash)**. The first caller will be placed on hold. To return to the original caller, press **(flash)** again.

Call Waiting Features

Your TRU 348 gives you new options for call waiting. At the touch of a button, you can ask the caller to hold or conference them into your current call. You may be required to subscribe to call waiting and call waiting options to use these features. Not all features are available in all areas. Check with your local telephone company for details.

1 When you receive a call waiting call, press **(options)** for a list of options.

```
1 Ask to Hold
2 Tell Busy
3 Answer/Drop 1
```

2 Press the **(▲)** or **(▼)** key or number keys to select an option.

(▲)/**(▼)** **(↓)**

```
4 Conference
5 Drop First
6 Drop Last
```

3 Press **(select/channel)**.
A confirmation screen will appear.

Your TRU 348 is pre-programmed with six call waiting options. You may select to ask the calling party to **hold**, send them a **busy** message, or **conference** them into the current call. You may also select to **answer and drop** the first caller or, at any time, choose to **drop the first** or **drop the last caller**.

Check with your local telephone company for a full list of options.

The Integrated Answering Device

The TRU 348 has a built-in answering system that answers and records incoming calls.

You can also use your answering system to record a conversation, leave a voice memo message for others who use the phone, or to announce a special message to callers when you're away from your phone.

Features

- Digital Tapeless Recording
- 15 Minutes of Recording Time
- Selective Greetings (Outgoing Messages)
- Message Received Time and Day Announcement
- Remote Message Retrieval and Room Monitor
- Toll Saver
- Conversation Recording

Digital Tapeless Recording allows you to quickly review, save or delete the messages. You'll never have to worry about a tape wearing out, jamming, or resetting improperly.

The Integrated Answering System is easy and convenient to use, but please read through all of the instructions carefully.

Setting Up Your Answering System

Turning the answering system on/off

- 1 To turn the answering system on, press **ans on/off**. The current greeting message will be played and a tone will sound.
- 2 To turn the answering system off, press **ans on/off** again.



When the answering system is full, **FL** displays on the base and the system announces “No remaining time”. You should delete some messages so that the system can record new messages.



- Press and hold **skip ►►** or **repeat ◀◀** to quickly scroll through numbers on the display.
- If you don't complete the clock setting within two minutes, the system returns to standby.

Setting the clock

The clock on TRU 348 Answering System starts when power is supplied to the base. Follow these steps to set the clock to the correct time.

- 1 Press and hold **clock set** until a tone sounds.
- 2 First, press **skip ►►** or **repeat ◀◀** repeatedly until the correct day of the week is announced. (Number **1** through **7** displays on the base as each day is announced.) Press **clock set** again to select the day.
- 3 Next, press **skip ►►** or **repeat ◀◀** repeatedly until you hear the correct hour setting. Numbers **1** through **12** display on the base as each hour is announced. Press **clock set** again to select the correct hour.
- 4 Press **skip ►►** or **repeat ◀◀** repeatedly until you hear the correct minute setting. Numbers **0** through **59** display on the base as each minute is announced. Press **clock set** again to select the correct minute.

- 5 The LED displays *A* or *P*. Press **(skip ►►)** or **(repeat ◀◀)** until you hear the correct AM/PM setting.
- 6 Press **(clock set)** again to end the time/day setting. The TRU 348 announces the time that you have set.

Setting your greeting

When you receive a call, the answering system automatically plays either a preset message or your own greeting.

▼ Preset Message

The following message is prerecorded:

“Hello, no one is available to take your call. Please leave a message after the tone.”

▼ Recording a personal outgoing message (Greeting)

- 1) Press and hold **(greeting)** until you hear a tone. Start recording your message immediately after you hear the tone end.
- 2) When you finish recording your message, press **(greeting)** or **(play ►)**. A tone sounds and your message plays back on the phone.

▼ Choosing between the two outgoing messages

- 1) Press **(greeting)** to play the outgoing message.
- 2) Press **(greeting)** again while the message is playing. This switches between the two options.



- You can record a greeting up to 30 seconds.
- Position yourself as near to the base as possible and speak clearly when recording your outgoing message.

Selecting the message record time

You can set your answering system to record messages up to one or four minutes long.

One minute option: move the **REC TIME** switch to **1**.

Four minutes option: move the **REC TIME** switch to **4**.

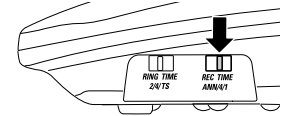

▼ Announce only feature:

The announce only feature plays an outgoing message, but it will not allow the caller to leave a message. Move the **REC TIME** switch to the **ANN** position.

The message counter LED displays "A" when the system is on standby.

Prerecorded outgoing message for Announce only feature is:

"Hello, no one is available to take your call." (twice)

Selecting a PIN code

To play your messages from a remote location, you will need to enter a two-digit Personal Identification Number (PIN) code (00-99). To select a PIN, perform the following steps.

- 1 On the base, press and hold **(pin set)** until a tone sounds and the LED displays **00**.
- 2 To set the first number, press **(skip ▶▶)** or **(repeat ◀◀)** repeatedly to scroll from 0 to 9. When the desired number appears in the display, press **(pin set)**.
- 3 To set the second number, press **(skip ▶▶)** or **(repeat ◀◀)** to scroll from 0 to 9. When the desired number appears in the display, press **(pin set)**. Then the entered PIN code is announced.



Press and hold **(skip ▶▶)** or **(repeat ◀◀)** to quickly scroll through numbers on the display.

Setting ring time switch

The ring time/toll saver switch allows you to set the number of rings the caller hears before the answering system plays your outgoing message. You can set the switch to answer after two rings or after four rings. Once the greeting has started, you can stop it when you pick up the call at the handset or base.

In the **TS** (Toll Saver) position, the answering system picks up after two rings if you have new messages, and after four rings if there is none. This way, if you call long distance to check your messages, you can hang up after the third ring to avoid billing charges.

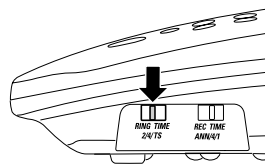

If you answer at another phone extension and the greeting has started, you cannot stop the message. Wait until your greeting is complete before starting your conversation.



- To stop playing your messages, press **play** again.

- If you have several messages, press **repeat** and hold until you return to the message you want to replay.

Using Your Answering System

Playing your messages

The base LED display shows the number of total messages. If the display is blinking, then there are new messages waiting for you. The TRU 348 is designed to play your new messages first. After you play your new messages you can then play your old messages.

- 1 Press **play**. The system announces the number of new and old messages, then the incoming messages are played. The time and day each message was received is announced after the message is played.
- 2 When all new messages have played, a tone is heard. The message counter LED stops flashing to indicate that all of the new messages have been reviewed.
- 3 After you have reviewed all your messages, you can play your old messages. Press **play** and follow the instructions above.

Repeating a message

- 1 Press **play** to review your message. The number of stored messages is announced.
- 2 After a message has played for more than two seconds, (four seconds for remote access) press **repeat** to repeat the message. If you press **repeat** before two seconds (four seconds for remote access) the system repeats the previous message.
- 3 Press **play** at any time to stop reviewing messages and return to standby. The message counter LED shows the total number of messages still on the system.

Skipping a message

- 1 Press **(play▶▶)** to review your messages. The number of messages is announced.
- 2 Press **(skip▶▶)** at anytime to skip to the next message.
- 3 Press **(play▶▶)** at any time to stop reviewing your messages and return to standby. The message counter LED shows the total number of messages on the system.

Deleting a message

▼ Deleting an individual message

- 1 Press **(play▶▶)** to review your message.
- 2 If you decide to delete a message, press **(delete)** anytime during the message. The system beeps and immediately goes to the next message.

▼ Deleting all messages

Press and hold **(delete)** while the system is in standby. A tone sounds when all messages are deleted. If there are any messages you have not reviewed, you can not delete all messages at once. An error tone occurs.



- Each time **(skip▶▶)** is pressed, the system scans forward one message.
- If you have several messages, press and hold **(skip▶▶)** to find the message you want to play.
- When you press **(delete)**, you are permanently deleting the message. The message cannot be replayed.



- The voice memo function is completely independent of the outgoing message. It's handy for leaving others a quick message.
- A voice memo message will be stored as a typical recorded message.
- Position yourself as near to the base as possible and speak clearly.
- A recorded conversation is stored and played back with typical recorded messages.

Voice memo

The voice memo function allows the user to record a message (up to 10 minutes) on the base.

- 1 Press and hold **voice memo** until you hear a tone. The message counter LED blinks.
- 2 Speak into the microphone.
- 3 When you have finished, press **voice memo** or **play▶▶** to stop recording. The system returns to standby.
- 4 To play voice memo, press **play▶▶**.

Recording a conversation

You can record up to 10 minutes of conversation while you are making your call from the handset.

- 1 During the conversation from the handset, press and hold **voice memo** on the base. The unit begins recording and the LED blinks. Both parties can hear tones every 15 seconds.
- 2 To stop the recording, press **voice memo** or **play▶▶**.



You cannot record a conversation while you are speaking on the base.

Remote access away from home

You can operate your answering system from a remote location using any touch-tone telephone. Use this function to check for recorded messages, to play or delete messages, to record a new outgoing message, and to monitor sounds in the room.

- 1 Call your telephone number.
- 2 While the greeting message is played, press # and your PIN code within 2 seconds.
If the answering system is off, let it ring 10 times. The tone sounds. Then, press # and your PIN code within 2 seconds.
- 3 The answering system announces the time and day and the number of messages stored in memory. Then the message playback automatically begins.
- 4 You may continue to listen to your message, or you may select a command from the following chart.

Command	Function
# then 1	Repeat a message
# then 2	Playing your messages
# then 3	Skipping a message
# then 4	Deleting a message
# then 5	Stop message playback
# then 6	Answering system on
# then 7	Voice memo record/stop (up to 4 minutes recording time)
# then 8	Greeting message record/stop
# then 9	Answer system off
# then *	Room monitor

- 5 After all of your messages have played, or the playback time exceeds 4 minutes, you will hear intermittent beeps indicating that the system is in the command waiting mode. You may enter another command at this time from the chart above.



- During the remote operation, \overline{r} displays on the base.
- You must enter a command within 15 seconds of entering command waiting mode. Otherwise the answering system automatically hangs up and returns to standby.
- The system will only playback messages for four minutes and then it returns to command waiting mode. To continue playing your message, press # then 2 again within 15 seconds.



If you enter an incorrect PIN code three times, an error tone sounds and the phone automatically hangs up.

- 6 When you finish, hang up to exit the system.
The answering system automatically returns to standby.

Remote room monitor

You can call your answering system from any touch-tone phone and monitor sounds in the room where your base is installed.

- 1 Call your telephone number.
- 2 While the greeting message is playing, press # and your PIN code.
- 3 The answering system begins announcing the time and day.
- 4 Press # then 5 to stop the messages.
- 5 Press # then *. You hear sounds in the room where your phone is installed.
After 15 seconds, the answering system returns to the command waiting mode.
- 6 Press # then * to monitor the room for another 15 seconds. Or select another remote function. Or hang up to exit the system. The answering system automatically returns to standby.

Turn on the answering machine remotely

If you have forgotten to turn on your answering machine, you can turn it on remotely from any touch-tone telephone.

- 1 Call your telephone number.
- 2 Wait ten rings until the machine answers.
- 3 Press # and enter your PIN code within 2 seconds. The answering system begins to announce the time and day.
- 4 Press # then 6 to turn the answering system on.
- 5 Hang up the phone and subsequent calls will be answered by the machine.

Changing the Digital Security Code

The digital security code is an identification code used to connect the handset and the base unit. Normally, setting the code is not necessary.

The first time you charge your handset, the security code is automatically set. (See page 6.)

In the rare situation that you suspect another cordless telephone is using the same security code, you can change the code.

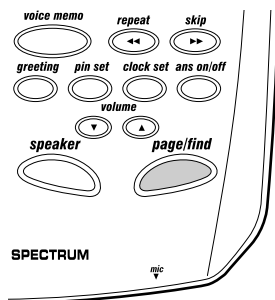

- 1 Remove the handset from the base unit.
Press **page/find** on the base.
- 2 While the handset is emitting the paging sound, place the handset on the base unit holding **page/find**. The paging tone stops.
Leave the handset on the base for more than 3 seconds. A random, new security code is set.



If the handset battery pack is completely discharged or the battery pack is removed, the digital security code will be lost. If this happens, a new security code is set automatically next time the battery pack is charged.

Installing the Beltclip

To attach the beltclip

Insert the beltclip into the holes on each side of the handset. Press down until it clicks.

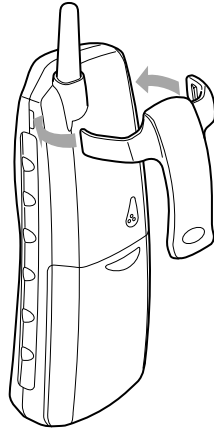

To remove the beltclip

Pull both sides of the beltclip to release the tabs from the holes.

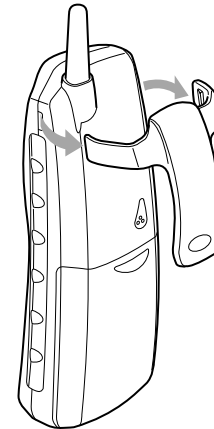

Headset Installation

Your phone may be used with an optional headset, the Uniden HS910. To use this feature, insert headset plug into the headset jack. Your phone is ready for hands-free conversations. (Headset may be purchased by calling the Uniden Parts Department or visiting the website. See Page 7.)

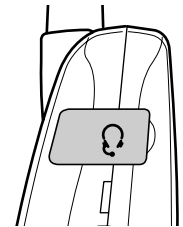

Note on Power Sources

Battery replacement and handling

When the operating time becomes short, even after a battery is recharged, please replace the battery.

With normal usage, your battery should last about one year.

Please contact your place of purchase or the Uniden Parts Department for a replacement battery. (See Page 7.)

Power Failure

During the period that the power is off, you will not be able to make or receive calls with the telephone.

RECYCLING NICKEL-CADMIUM BATTERIES

NICKEL-CADMIUM BATTERIES MUST BE DISPOSED OF PROPERLY.



Nickel-cadmium cells are used in the battery pack. Please take your used nickel-cadmium battery packs to a store that recycles nickel-cadmium batteries.

Caution

- Use the specified battery pack.
- Do not remove the battery from the handset to charge it.
- Never throw the battery into a fire, disassemble it, or heat it.
- Do not remove or damage the battery casing.

Maintenance

When slightly dirty

Wipe with a soft, dry cloth.

When very dirty

Wipe with a soft cloth that has been dampened with diluted, neutral detergent. Dry with a dry cloth.

When the charging terminals become dirty

Wipe with a dry cloth or a pencil eraser, if necessary.

Caution

Do not use paint thinner, benzene, alcohol, or other chemical products. Doing so may discolor the surface of the telephone and damage the finish.

Troubleshooting

If your phone is not performing to your expectations, please try these simple steps first.

Symptom	Suggestion
The status LED won't light when the handset is placed in the base unit.	<ul style="list-style-type: none"> • Make sure the AC adapter is plugged into the base unit and wall outlet. • Make sure the handset is properly seated in the base unit. • Make sure the charging contacts on the handset and base unit are clean.
The audio sounds weak and/or scratchy.	<ul style="list-style-type: none"> • Press <i>(select/channel)</i> during a call to help eliminate background noise. • Make sure that the base unit antenna is in a vertical position. • Move the handset and/or base unit to a different location away from metal objects or appliances and try again. • Make sure that you are not too far from the base.
Can't make or receive calls.	<ul style="list-style-type: none"> • Check both ends of the base unit telephone line cord. • Make sure the AC adapter is plugged into the base unit and wall outlet. • Disconnect the AC adapter for a few minutes, then reconnect it. • Reset the digital security code (See page 47). • Make sure <i>(talk)</i> is pressed.
The handset doesn't ring or receive a page.	<ul style="list-style-type: none"> • The battery pack may be weak. Charge the battery on the base unit for more than 15 hours. • The handset may be too far away from the base unit. • Place the base unit away from appliances or metal objects. • Reset the digital security code (See page 47).
The Caller ID/CIDCW does not display.	<ul style="list-style-type: none"> • The handset was picked up before the second ring. • The call was placed through a switch board. • Call your local telephone company to verify your Caller ID service is current. • Charge the handset.

Symptom	Suggestion
The answering system does not work.	<ul style="list-style-type: none"> • Make sure the base unit is plugged in. • Make sure that the answering system is turned on. • Make sure that the message record time is not set to ANN (See page 40).
Messages are incomplete.	<ul style="list-style-type: none"> • The incoming messages may be too long. Remind callers to leave a brief message. • The memory may be full. Delete some or all of the saved messages.
After a power failure, the outgoing message is deleted.	<ul style="list-style-type: none"> • Record your greeting again. The preset message remains.
No sounds on the base unit speaker during call monitoring or message playback.	<ul style="list-style-type: none"> • Adjust the speaker volume on the base unit.
Cannot access remote call-in features from another touch-tone phone.	<ul style="list-style-type: none"> • Make sure you are using the correct PIN number. • Make sure that the touch-tone phone you're using can transmit the tone for at least two seconds. If it cannot, you may have to use another phone to access your message.
Severe noise interference.	<ul style="list-style-type: none"> • Keep the handset away from microwave ovens, computers, remote control toys, wireless microphones, alarm systems, intercoms, room monitors, fluorescent lights and electrical appliances. • Move to another location or turn off the source of interference.

General Information

The TRU 348 complies with FCC Parts 15 and 68.

Operating Temperature: -10°C to +50°C (+14°F to +122°F)

AC Adapter Information

AC Adapter part number: AD-312
Input Voltage: 120V AC 60Hz
Output Voltage: 9V DC 350 mA

Battery Information

Battery part number: BT-905
Capacity: 600 mAH, 3.6V
Battery Use Time (per charge)
From fully charged:
Talk Mode duration 6 hours
Standby Mode duration 10 days



If the handset is left off of the base, the actual Talk Mode duration will be reduced respective to the amount of time the handset is off the base.

Recharge your phone on a regular basis about once a week by placing the handset on the base for 15 hours. When the operating time becomes short, even after the battery is recharged, please replace the battery. With normal usage, the battery should last about one year.

Replacement batteries may be purchased at your local Uniden dealer or by contacting the Uniden Parts Department (800) 554-3988. Hours are from 7:00 a.m. to 5:00 p.m. Central Time, Monday through Friday. We can also be reached on the web at www.uniden.com

Specifications, features, and availability of optional accessories are all subject to change without prior notice.

Technical Information

The FCC wants you to know!

Changes or modifications to this product not expressly approved by Uniden, or operation of this product in any way other than as detailed by the owner's manual, could void your authority to operate this product. The equipment cannot be used on public coin phone service provided by the telephone company. Connection to party line service is subject to state tariffs. (Contact the state public utility commission, public service commission or corporation commission for information.)

Below is some information that might concern you while using your new phone.

Range

Your new phone is designed to achieve the maximum possible range by transmitting and receiving according to the highest specifications set forth by the FCC. We have rated this phone to operate at a maximum distance with the qualification that the range depends upon the environment in which the telephone is used. Many factors limit range, and it would be impossible to include all the variables in our rating. The Maximum Range rating of this phone is meant to be used as a means of comparison against other range claims.

Telephone Line Problems

The FCC has granted the telephone company the right to disconnect service in the event that your phone causes problems on the telephone line. Also, the telephone company may make changes in facilities and services which may affect the operation of your unit. However, your telephone company must give adequate notice in writing prior to such actions to allow you time for making necessary arrangements to continue uninterrupted service.

If you are having trouble with your telephone service, you must first disconnect your phone to determine if it is the cause of your problem. If you determine that it is the cause, you must leave it disconnected until the trouble has been corrected.

Radio Interference

Radio interference may occasionally cause buzzing and humming in your cordless handset, or clicking noises in the base. This interference is caused by external sources such as TV, refrigerator, vacuum cleaner, fluorescent lighting, or electrical storm. Your unit is NOT DEFECTIVE. If these noises continue and are too distracting, please check around your home to see what appliances may be causing the

problem. In addition, we recommend that the base not be plugged into a circuit that also powers a major appliance because of the potential for interference. Be certain that the antenna on the unit is fully extended when needed.

In the unlikely event that you consistently hear other voices or distracting transmissions on your phone, you may be receiving radio signals from another cordless telephone or other source of interference. If you cannot eliminate this type of interference, you need to change to a different channel.

Finally, it should be noted that some cordless telephones operate at frequencies that may cause interference to nearby TVs and VCRs. To minimize or prevent such interference, the base of the cordless telephone should not be placed near or on top of a TV or VCR. If interference is experienced, moving the cordless telephone farther away from the TV or VCR will often reduce or eliminate the interference.

More Than One Cordless Telephone

If you want to use more than one cordless telephone in your home, they must operate on different channels. Press the channel key to select a channel that provides the clearest communication.

Cordless Telephone Privacy

Cordless telephones are radio devices. Communications between the handset and base of your cordless telephone are accomplished by means of radio waves which are broadcasted over the open airways. Because of the inherent physical properties of radio waves, your communications can be received by radio receiving devices other than your own cordless telephone unit. Consequently, any communications using your cordless telephone may not be private.

Index

0 - 9

3-way conferencing 28

A

Adjusting the volume 18

Answering device

 Features 37

 Setting up 38

 Using 42

B

Base ringer switch 18

Base speaker volume 18

Battery pack

 Preparing and charging 10

 Replacement and handling 49

C

Caller ID

 Caller ID service 30

 Calling 33

 Call Waiting 36

 Deleting 32

 Features 12

 Setting 12

 Storing 34

 Using 33

 Viewing 31

Connection 9

D

Dialing mode 9

Digital security code 6, 47

E, F, G

Earpiece volume 18

H

Headset installation 48

I, J, K, L

Installing the beltclip 48

M, N, O

Maintenance 50

Making a call 14

Memory dialing

 Erasing a stored name

 and phone number 27

 Making calls

 with memory dialing 23

 Storing phone

 numbers and names 21

P, Q

Package contents 7

Page 29

R

Receiving a call 16

Redialing a call 19

Ringer volume 18

S

Setting up the Base unit 8

Setting up the Handset 10

Setting up your

 answering system

 Selecting a PIN code 40

 Selecting the

 message record time 40

 Setting ring time switch 41

 Setting the clock 38

 Setting your greeting 39

 Turning the answering

 system on/off 38

T

Troubleshooting 51

U, V, W, X, Y, Z

Using your answering system

 Deleting a message 43

 Playing your messages 42

 Recording a conversation 44

 Remote access

 away from home 45

 Remote room monitor 46

 Repeating a message 42

 Skipping a message 43

 Voice memo 44

At Uniden, we'll take care of you!

If you need any assistance with this product, please call our Customer Hotline at

1-800-297-1023

PLEASE DO NOT RETURN THIS PRODUCT TO THE PLACE OF PURCHASE.

Our Uniden representatives will be happy to help you with any matters regarding the operation of this unit, available accessories, or any other related matters.

Thank you for purchasing a Uniden product.

Hours: M-F 7:00 AM to 7:00 PM CST.

THANK YOU FOR PURCHASING A UNIDEN CORDLESS PHONE

A World Without Wires | **Uniden**[®]

Covered under one or more of the following U.S. patents:

4,511,761	4,523,058	4,595,795	4,797,916	5,381,460	5,426,690
5,434,905	5,491,745	5,533,010	5,574,727	5,650,790	5,660,269
5,661,780	5,663,981	5,671,248	5,717,312	5,754,407	5,768,345
5,787,356	5,838,721	5,864,619	5,893,034	5,912,968	5,915,227
5,929,598	5,930,720	5,960,358	5,987,330		

© 2001 Uniden America Corporation, Fort Worth, TX
All rights reserved.

Printed in China
UCZZ01722BZ

Free Manuals Download Website

<http://myh66.com>

<http://usermanuals.us>

<http://www.somanuals.com>

<http://www.4manuals.cc>

<http://www.manual-lib.com>

<http://www.404manual.com>

<http://www.luxmanual.com>

<http://aubethermostatmanual.com>

Golf course search by state

<http://golfingnear.com>

Email search by domain

<http://emailbydomain.com>

Auto manuals search

<http://auto.somanuals.com>

TV manuals search

<http://tv.somanuals.com>