

Uniden[®]

TRU 8865

SERIES

OWNER'S

MANUAL

OWNER'S MANUAL

Contents

WELCOME/FEATURES/TERMINOLOGY	2	Copying Phonebook Locations	47
CONTROLS & FUNCTIONS	4	CALLER ID	48
DISPLAY AND ICONS	6	Caller ID and CIDCW (Caller ID on Call Waiting)	48
SOFT KEY FUNCTION	8	Deleting a Caller ID Message	50
GETTING STARTED	9	Using the Caller ID Message List	51
Setting up the Phone	9	Call Waiting Deluxe Features	53
Mounting the Base Unit on a Wall	12	MULTI-HANSET FEATURES	54
Expanding Your Phone	14	Multi-Handset Features	54
Connecting the Charger	14	Using the DirectLink Mode	54
Register the Handset	15	Intercom/Call Transfer Feature	55
Main Menu Options	16	ADDITIONAL INFORMATION	58
Setting Menu Options	17	Changing the Digital Security Code	58
BASICS	31	Find Handset	58
Making and Receiving Calls	31	Installing the Beltclip	59
Call Waiting	31	Headset Installation	59
Placing a Call on Hold	32	Note on Power Sources	60
Redialing a Call	32	General Information	62
Adjusting the Ringer, and Earpiece and Speaker Volume	33	TROUBLESHOOTING	63
Muting the Ringer	34	Troubleshooting	63
Mute Microphone	35	Liquid Damage	65
Tone Dialing Switch-over	35	PRECAUTIONS & WARRANTY	66
Traveling Out of Range	36	I.C. NOTICE	68
Privacy Mode	36	MEMORY LIST	69
Conferecing	37	INDEX	71
Using One Touch Voice Mail Access	39	40 MAIN MENU FLOW CHART	72
PHONEBOOK	40		
Phonebook (Storing Phone Numbers, Names, Distinctive Rings and Speed Dial)	40		
Chain Dialing	41		
Steps for Entering Names and Special Characters	42		
Viewing the Phonebook	44		
Making Calls Using the Phonebook	45		
Speed Dialing	45		
Editing or Erasing a Stored Name, Phone Number, Distinctive Ring and Speed Dial	46		

Welcome

Congratulations on your purchase of the Uniden Digital Expandable Cordless Telephone System! This unit is different from conventional cordless telephones. When the base unit is connected to AC power and a telephone line, it can support up to 10 handsets. You can now place a fully-featured cordless handset anywhere in your home or office where AC power is available to connect the handset chargers. Extra handsets also allow you to establish a 4-way conference call among 2 handsets, the base speakerphone, and an outside line.

Note: Some illustrations in this manual may differ from the actual unit for explanation purposes.



As an Energy Star[®] Partner, Uniden has determined that this product or product models meets the Energy Star[®] guidelines for energy efficiency. Energy Star[®] is a U.S. registered mark.

Features

- 5.8GHz Digital Expandable
- Dual Keypad and LCD Screen at Base
- 10 Multi-Handset Expandability
- Hands-Free Duplex Speakerphone in the Handset and Base
- Caller ID/Call Waiting Deluxe (subscribe through local telephone company)
- 100 (handset) and 50 (base) Programmable CID or Memory Locations
- Trilingual Display Options (English, French and Spanish)
- Intercom/Call Transfer Between Handsets
- 20 Distinctive Ring Options (10 ringer tones and 10 melody ringers)
- Mute and Hold Features
- Do Not Disturb (DND) Feature
- DirectLink™ Mode
- Room/Baby Monitoring
- Battery Level Indicator
- Clock Display
- Animation Displays

This series features **AutoTalk™** and **AutoStandby™**. AutoTalk allows you to answer a call by just removing the handset from the cradle so you don't have to waste time pushing buttons. AutoStandby allows you to hang up by simply returning the handset to the cradle.

To protect you against mis-billed calls that might result from your phone being activated by other equipment, this series has **Random Code™** digital security, which automatically selects one of more than 10,000,000 digital security codes for the handset and base.

Digital Spread Spectrum Technology uses a wider frequency band than standard digital transmissions. The result is a more secure conversation with the clarity of digital sound, extended range, and minimal interference from other cordless phones.

IntegriSound™ Built in sound quality which provides life-like conversations.

With **DirectLink™** mode, you can use 2 or more handsets as radio tranceivers (walkie-talkies).

Be sure to visit our web site: www.uniden.com

Uniden® is a registered trademark of Uniden America Corporation.

AutoTalk, AutoStandby, DirectLink, IntegriSound and Random Code are trademarks of Uniden America.

Terminology

- **Standby Mode** - The handset is not in use, and **talk/flash** or **speaker** has not been pressed. No dial tone is present.
- **Talk Mode** - The handset is not in the cradle, and **talk/flash** or **speaker** has been pressed, enabling a dial tone. Talk appears on the display.

Controls & Functions

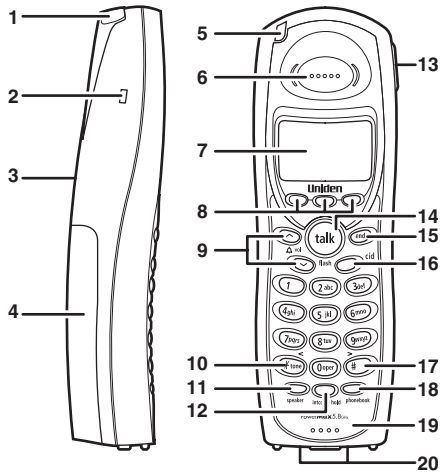

1. Handset Antenna
2. Beltclip Hole
3. Speakerphone Speaker and Ringer
4. Handset Battery Compartment
5. New Message LED
6. Handset Earpiece
7. LCD Display
8. **soft** Keys (P. 8)
9. Δ /**vol** \wedge /**v** (volume up/down) (P. 34 & 17)
10. ***/tone/**< (P. 36 & 42)
11. **speaker** (P. 31)
12. **intcom/hold** (P. 55 & 32)
13. Headset Jack Cover
14. **talk/flash** (P. 31 & 32)
15. **end** (P. 31)
16. **cid** (P. 49)
17. ***/>** (P. 42)
18. **phonebook** (P. 40)
19. Handset Microphone
20. Handset Charging Contacts

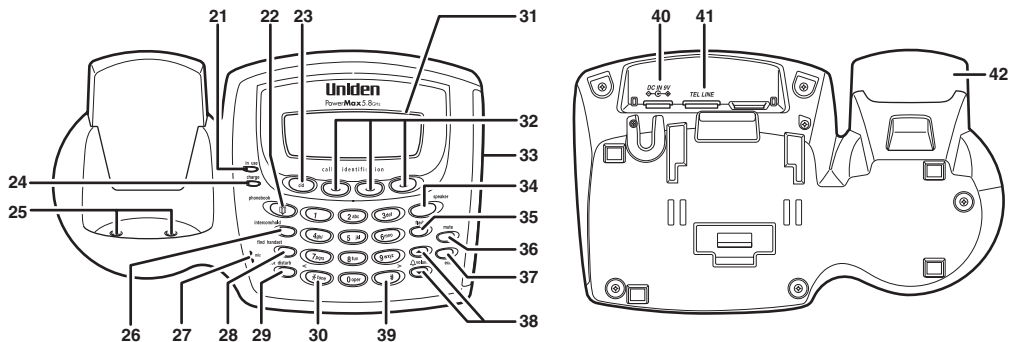

21. In use LED

22. **phonebook** (P. 40)

23. **cid** (P. 49)

24. Charge LED

25. Base Charging Contacts

26. **intercom/hold** (P. 55 & 34)

27. **mic** (microphone)

28. **find handset** (P. 58)

29. **do not disturb** (P. 35)/DND LED

30. **tone** < (P. 36)

31. LCD Display

32. **soft** Keys (P. 8)

33. Base Speaker

34. **speaker**/speaker LED (P. 31)

35. **flash** (P. 32)

36. **mute** (P. 35)

37. **exit** (P. 44)

38. **volume** ▲/▼ (volume up/down)
(P. 34 & 17)

39. **# >** (P. 42)

40. **DC IN 9V** Jack

41. **TEL LINE** Jack

42. Base Antenna

Display and Icons

Example of the standby mode display

• Handset



— Ringer off icon (when the ringer is off)/ day of the week and time / battery icon
 — Handset ID and Banner
 — Number of new Caller ID calls received (If there are no new Caller ID messages, the Handset ID appears here.)

• Base



* This icon changes depending on ringer volume level (High, low and off)

ICON	Appears During	DESCRIPTION
	Standby/Talk	Battery icons indicate the handset battery status. This icon changes depending on the battery status (empty, low, medium and full).
	Standby	The Ringer off icon indicates that ringer is turned off.
	Talk	The Mute icon appears when you mute the handset or base.
	Talk	The Speaker icon appears when the handset speaker phone is used (handset only).
	Talk	The Privacy icon appears when the Privacy Mode is turned on.
	Standby	When a new message is received, an envelope icon is displayed on the LCD screen (base only).

Animation Displays (Handset only)

The handsets have a variety of animation displays. Below are examples of the animation screens and what they mean:

Turning on the phone

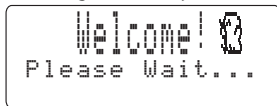

Hanging up the phone



Confirmation (Done!)

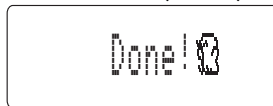

Deleting (Deleted!)

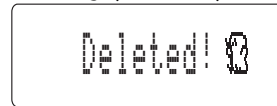

Making a call



Find Handset/Paging the Handset



Also, the animation display changes depending on the ringer volume setting.



Out of Range



Unavailable



Low Battery



Soft Key Function

"Soft" keys are keys that change function during the operation of the phone. There are three soft keys on the base and three on each handset. Soft keys allow you to:

- Access the main menu
- Set up CIDCW options
- Store or edit phone numbers
- Access stored Caller ID messages
- Redial one of the last three numbers dialed from the handset

Note: The soft keys will not appear while the handset is charging.

The function of each soft key is determined by the icon that appears directly above it. For example, when the handset is in standby mode, pressing soft key 1 will redial the last number. When the handset is in talk mode, pressing soft key 1 will mute the microphone.

Complete information on the features controlled by the soft keys can be found under each feature.

In standby mode Handset

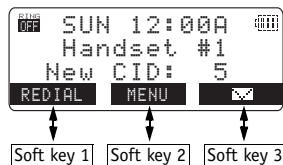

In talk mode Handset



Base

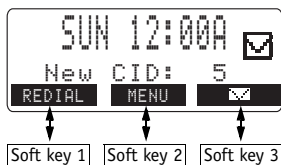

Base



Setting up the Phone

Do the following steps:

- Choose the best location
- Install the rechargeable battery pack into the handset.
- Connect the base unit.

A. Choose the best location

Before choosing a location for your new phone, read "Installation Considerations" on page 67. Here are some important guidelines you should consider:

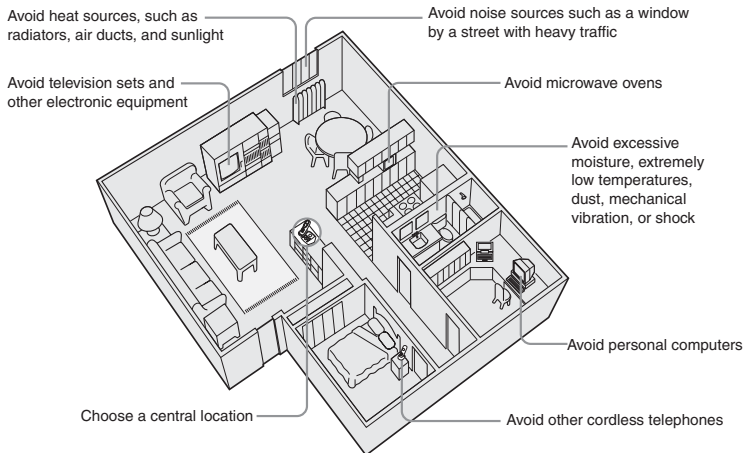

If your home has specially wired alarm equipment connected to phone line, be sure that installing the system does not disable your alarm equipment. If you have questions about what will disable alarm equipment, contact your telephone company or a qualified installer.



For maximum range:

- Keep the antenna free of obstruction.
- When the handset is not in use place the handset in an upright position.
- Do not hold the handset where you would block the signal.



- Metal and reinforced concrete may affect cordless telephone performance.



• Use only the Uniden (BT-446) rechargeable battery pack supplied with your cordless telephone.

• Replacement battery packs are also available through the Uniden Parts Department at (800) 554-3988, Monday thru Friday from 8:00 a.m. to 5:00 p.m. or online at www.uniden.com

B. Install the rechargeable battery pack into the handset

The handset is powered by a rechargeable battery pack. The battery recharges automatically when the handset is placed in the base unit. To maximize the charge capacity of your battery pack, DO NOT plug the telephone cord into the base unit and wall jack until the battery is fully charged.

- 1) Press down on the handset battery case cover (use the finger indentation for a better grip) and slide the cover downward to remove.
- 2) Turn the battery pack so that the connector with the red and black wires is near the jack inside the battery compartment. Match the connector's wire colors to the polarity label in the battery compartment (the connector notches fit into the grooves of the jack only one way). Push the battery pack connector into the jack until it clicks into place.
- 3) Make sure you have a good connection by gently pulling on the battery wires. If the connection is secure, the battery jack will remain in place.
- 4) Place the battery case cover back on the handset and slide it upwards until it clicks into place.

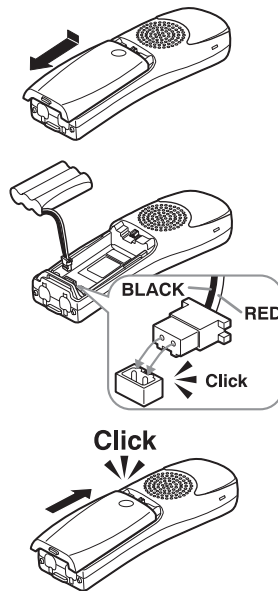

C. Connect the base unit

- 1) Connect the AC adapter to the **DC IN 9V** jack and to a standard 120V AC wall outlet.
Connect the AC adapter to a continuous power supply (i.e., an outlet that is not controlled by a switch).
- 2) Set the base on a desk or tabletop, and place the handset in the base unit.
Place the base unit close to the AC outlet so that you can unplug the AC adapter easily.
- 3) Make sure that the **charge** LED illuminates.
If the LED does not illuminate, check to see that the AC adapter is plugged in and the handset makes good contact with the base charging contacts.
- 4) After installing the battery pack in the handset, charge your handset for at least **15-20 hours before plugging into the phone line.**
- 5) Once the handset battery pack is fully charged, connect the telephone line cord to the **TEL LINE** jack and to a telephone outlet.



If your telephone outlet isn't modular, contact your telephone company for assistance.

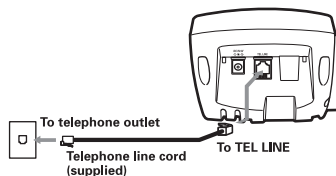
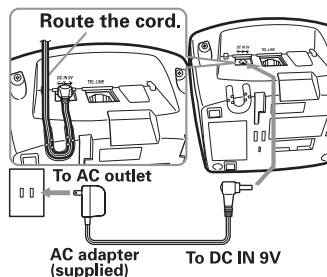

Modular



- Use only the supplied [AD-830] AC adapter. Do not use any other AC adapter.
- Place the power cord so that it does not create a trip hazard or where it could become chafed and create a fire or electrical hazard.



DO NOT use an AC outlet controlled by a wall switch.

Mounting the Base Unit on a Wall

Standard wall plate mounting

This phone can be mounted on any standard wall plate.

- 1) Make the AC adapter and the telephone line cord through the hole on the wall mount adapter.
- 2) Plug the AC adapter into the **DC IN 9V** jack.
- 3) Plug the telephone line cord into the **TEL LINE** jack.
- 4) Slide the wall mount adapter into the notches on the base.
- 5) Plug the AC adapter into a standard 120V AC wall outlet. Hook the cord on the notch of the wall mount adapter.
- 6) Plug the telephone line cord into the telephone outlet. Hook the cord on the notch of the wall mount adapter.
- 7) Align the mounting slots on the base with the mounting posts on the wall. Then push in and down until the phone is firmly seated.

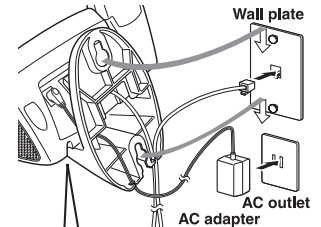
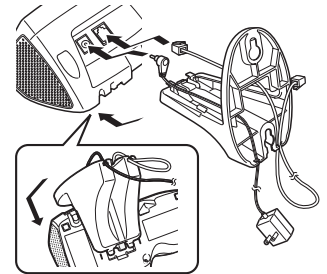

Direct wall mounting

If you don't have a standard wall plate, you can mount your phone directly to the wall. Before doing this, consider the following:

- Avoid electrical cables, pipes, or other items behind the mounting location that could cause a hazard when inserting screws into the wall.
- Try to mount your phone within 5 feet of a working phone jack to avoid excessive lengths.
- Make sure the wall material is capable of supporting the weight of the base and handset.
- Use #10 screws (minimum length of 1 & 3/8 inches) with anchoring devices suitable for the wall material where the base unit will be placed.

- 1) Insert two mounting screws into the wall (with their appropriate anchoring device), 3 & 15/16 inches apart. Allow about 1/8 of an inch between the wall and screw heads for mounting the phone.
- 2) Refer to steps 1 through 7 on page 12 to mount the telephone.

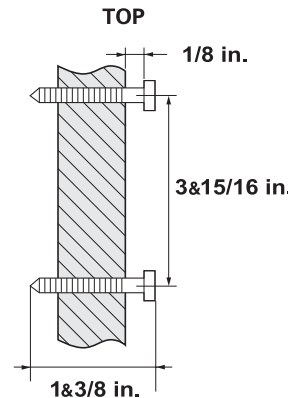



Expanding Your Phone

10 Handset Expandability

Your phone supports up to 10 handsets, including any handsets supplied with your phone. You can now place a fully-featured cordless handset anywhere AC power is available to connect the handset charger.

Up to 2 handsets can be used in DirectLink

Mode or on an intercom call without interfering with incoming calls. It is possible to have a 4-way conference among the base, 2 handsets, and one outside line. All of the handsets ring when a call is received.

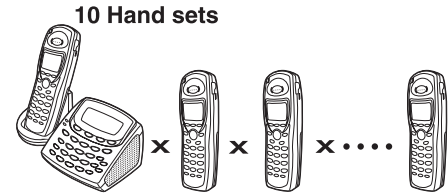

IMPORTANT:

If you purchase a TCX800 extra handset, please register the handset to the original/main base before use. The TCX800 will not operate until it is registered.

If you change a global setting in one handset, you change that particular setting for all registered handsets. All other settings (not included under Global Setup) must be set separately through each handset.

Connecting the Charger

- 1) Connect the AC adapter to the **DC IN 9V** jack and to a standard 120V AC wall outlet.
- 2) Set the charger on a desk or tabletop, and place the handset in the charger with the keypad facing forward. (See "Install the rechargeable battery pack into the handset" on page 10.)

Charge the handset battery pack for at least 15-20 hours before using your new cordless telephone for the first time.

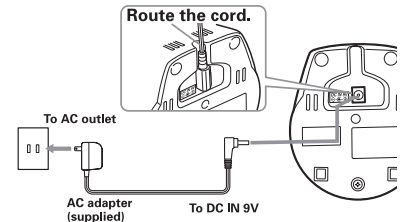

Register the Handset

If you purchase an extra handset, you need to register the handset before use. Only one handset can be registered at a time.

Handsets supplied with the phone are registered to the base by the factory. When charged, pre-registered handsets display a handset ID number. Handsets that have not been registered display *Place handset on main base to register*. When you register an extra handset to the base, the handset ID will be assigned.

Place handset
on main base
to register

An extra handset can be registered when the main base is in standby mode.

- 1) Before registering the extra handset, the battery pack **MUST** be charged for 15-20 hours.
- 2) Place the extra handset in the main base unit to begin registration.
- 3) While the handset is registering, *Handset Registering* will appear in the LCD. When *Registration Complete* is displayed, the handset has been registered to the base. If *Registration Failed* appears, please try these steps again.

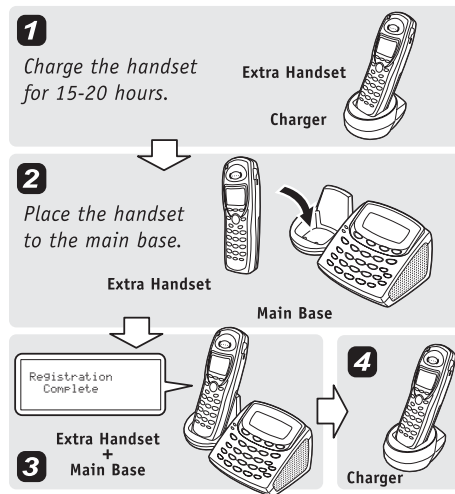



- For Global Setup, and Deregister HS menu options, make sure the line is not in use and the handsets are within range of the base.
- Main menu flow chart is provided on page 72.

Main Menu Options

Your phone has six main menu options: **DirectLink Mode**, **Room/Baby Monitor**, **Handset Setup**, **Base Setup**, **Global Setup** and **Deregister HS**. You can change **Room/Baby Monitor**, and **Global Setup** settings from the base or from any handset. **DirectLink Mode**, **Handset Setup**, and **Deregister HS** are only available from a handset. **Base Setup** is only available from the base.

Default Settings

The default settings set from the factory match the features that most people use. You may not need to change them. However, there are a number of options you must set and entries you must make in memory to take full advantage of all the phone features. The table below lists the default settings.

Function	Handset	Base	Function	Handset	Base
Edit Voice Mail	None		Day & Time	SUN 12:00 AM	
Ringer Tone	Flicker	-	CW / CWDX	CW on/CWDX off	
Distinctive Ring	On	-	Area code	None	
Auto Talk	Off	-	Dial Mode	Tone	
Anykey Answer	Off	-	Voice Mail Tone	On	
Banner	" "	-			
Language (LCD)	English				
Contrast	Level 5				
Key touch tone	On	-			
Animation Screen	On	-			

Setting Menu Options

Using the interface

Below are some tips for using the software interface on your phone.

- Press the **MENU** soft key to access the main menu.
- Use Δ **volume up/down** to scroll through options.
- Press the OK soft key to make a selection.
- Press the **BACK** soft key to return to the previous screen.
- Press **end** to exit the menu.

•Handset



•Base





You must have at least two handsets to use Direct Link Mode.

DirectLink Mode (Handset only)

In DirectLink mode, a pair of handsets can function as two-way radios. DirectLink Mode allows two handsets to communicate with each other without the base unit or a telephone line. Use them at sporting events or while shopping to stay in contact with family members or friends. You must set both handsets to DirectLink Mode to activate this feature.

Using DirectLink Mode

- 1) Press the **MENU** soft key and select the DirectLink Mode menu. To enter DirectLink mode Press [ENTER] appears.
- 2) Press the **ENTER** soft key to enter the DirectLink mode. You will hear a confirmation tone, and DirectLink Mode Complete appears.
- 3) To return back to the normal mode, press the **CANCEL** soft key and then the **OK** soft key, or return the handset to the cradle.

```
To enter
DirectLink mode
Press [ENTER]
[BACK] [ENTER]
```

Room/Baby Monitor

This feature allows you to monitor sounds in another room. Place the base or a handset in the room you wish to monitor; it will function as a microphone. A second handset can be set to function as a remote speaker, allowing you to monitor sounds in the room.

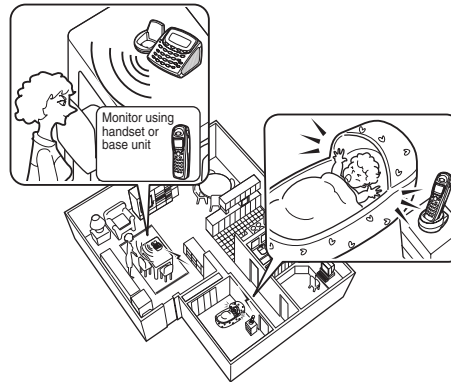

Using Room/Baby Monitor

- 1) Press the **MENU** soft key and select Room Monitor menu. To Room Monitor appears.
- 2) Select the handset or base you want to monitor by using Δ **volume up/down**.
- 3) Press the **OK** soft key. RoomMonitor appears, and you hear sounds in the room where the handset or the base is installed.
- 4) To turn off the Room Monitor, press the **END** soft key, or **end**.



note

This feature only works when the handset(s) is within the range of the base.

Handset Setup / Base Setup

The following submenu options must be set separately for each handset and the base.

Programming your Voice Mail Access Number

Edit voice Mail allows you to program or delete the voice mail access number.

- 1) Press the **MENU** soft key. Select the Handset Setup menu or the Base Setup menu, and then the Edit Voice Mail submenu.

Edit V_mail No. appears.

- 2) Enter your personal access number using the number keypad (**0-9**), ***/tone/<**, **#/>**, the **DELETE** soft key, or the **PAUSE** soft key (up to 20 digits).
- 3) Press the **OK** soft key. You will hear the confirmation tone.



To delete the current Voice Mail Access Number, delete all numbers in step2 using the **DELETE** soft key and the **OK** soft key.

Selecting a Ringer Tone (Handset only)

Ringer tone lets you choose from 10 ringer tones or 10 melodies:

- Ringers (Flicker, Clatter, Soft Alert, Wake Up, Light Bug, Beep Boop, Tone Board, Chip Chop, Party Clap, Reminder)
 - Melodies (Beethoven's Symphony #9 [Beethoven9], For Elise [Elise], We Wish You A Merry Christmas [Merry- Xmas], Home Sweet Home [Hm Swt Hm], Lorri Song #6 [Lorri Song], When the Irish Eyes Are Smiling [Irish Eyes], Aura Lee, Let Me Call You Sweet Heart [Sweetheart], Star Spangled Banner [Star Spngl], Old MacDonald [Old MacDld])
- You must set a separate ringer tone on the base and each handset.

- 1) Press the **MENU** soft key. Select the Handset Setup menu, and then the Ringer Tone submenu.
- 2) Press Δ **volume up/down** to move the pointer. You will hear the ringer or melody as you scroll through the options.
- 3) Press the **OK** soft key. You will hear a confirmation tone.

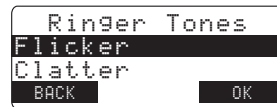

Distinctive Ringer Setup (Handset only)

Distinctive Ringer allows you to assign a designated ring tone to a stored phonebook number. When a call is received and the Caller ID information matches the information in one of the phonebook memory locations, the phone uses the distinctive ring assigned to that particular caller. You can assign distinctive rings to multiple phonebook memory locations. Switching the setting to Distinctive Off disables distinctive ringing: all incoming calls will have a normal ring tone. Switching to Distinctive On activates all programmed distinctive ring memory locations.

- 1) Press the **MENU** soft key. Select the Handset Setup menu, and then the Distinctive Ring submenu.
- 2) Press Δ **volume up/down** to select On or Off.
- 3) Press the **OK** soft key. You will hear a confirmation tone.



Setting AutoTalk (Handset Only)

Autotalk allows you to answer the phone simply by removing the handset from the cradle. You do not have to press any buttons to answer the call.

- 1) Press the **MENU** soft key. Select the Handset Setup menu, and then the AutoTalk submenu.
- 2) Press Δ **volume up/down** to select On or Off.
- 3) Press the **OK** soft key. You will hear a confirmation tone.



Setting Anykey Answer (Handset only)

Anykey Answer allows you to answer the phone by pressing any number key, ***/tone/<**, or **#/>** on the handset.

- 1) Press the **MENU** soft key. Select the Handset Setup menu, and then the Anykey Answer submenu.
- 2) Press Δ **volume up/down** to select On or Off.
- 3) Press the **OK** soft key. You will hear a confirmation tone.



Setting the True Banner (Handset only)

True Banner lets you customize the name your handset displays.

The name will be displayed on the LCD screen during Standby Mode, Intercom, Intercom Hold, Room Monitor and Copy Phonebook operation. The banner name will be displayed on the receiving handset as well.

- 1) Press the **MENU** soft key. Select the Handset Setup menu, and then the Banner submenu.
- 2) Use the number keypad (**0-9**), ***/tone/<**, **#/>**, or the **DELETE** soft key to enter or edit the name.
- 3) Press the **OK** soft key. You will hear a confirmation tone.



Selecting a Language

You can change the language the menu display will use. Choose from English, French, or Spanish.

- 1) Press the **MENU** soft key. Select the Handset Setup menu or the Base Setup menu, and then the Language submenu.
- 2) Press **Δ volume up/down** to choose "English", "Français" (French), or "Español" (Spanish).
- 3) Press the **OK** soft key. You will hear a confirmation tone.

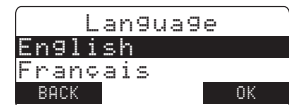

Adjusting the LCD Contrast

Contrast adjusts the handset LCD brightness. Choose one from the 10 levels for optimum viewing.

- 1) Press the **MENU** soft key. Select the Handset Setup or the Base Setup menu, and then the Contrast submenu.
- 2) Press Δ **volume up/down** to adjust the contrast of the LCD (10 levels.)
- 3) Press the **OK** soft key. You will hear a confirmation tone.



Setting the Key Touch Tone (Handset only)

Key Touch Tone is the tone your keypad makes when keys are pressed. You can turn this tone on or off.

- 1) Press the **MENU** soft key. Select the Handset Setup menu, and then the Key Touch Tone submenu.
- 2) Press Δ **volume up/down** to select On or Off.
- 3) Press the **OK** soft key. You will hear a confirmation tone.



Setting the Animation Screen (Handset Only)

The Animation Screen displays animation on the handset LCD. The animations will be displayed on the LCD screen during a call, ringer volume setting, paging operation, when you hang up and so on.

- 1) Press the **MENU** soft key. Select the Handset Setup menu, and then the Animation Screen submenu.
- 2) Press Δ **volume up/down** to select On or Off.
- 3) Press the **OK** soft key. You will hear a confirmation tone.

See "Animation Displays (Handset only)" on page 7 for all the available screens.

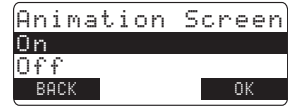

Global Setup

If you change one of the global settings, you change that setting for all registered handsets and the base. Only one handset can change global settings at a time.

Setting Day and Time

Day & Time sets the day and time of your display.

- 1) Press the **MENU** soft key. Select the Global Setup menu, and then the Day & Time submenu option.
- 2) Press Δ **volume up/down** to select the day of the week, and then the \rightarrow soft key.
- 3) Press Δ **volume up/down** to set hour, and then press the \rightarrow soft key.
- 4) Press Δ **volume up/down** to set minute, and then press the \rightarrow soft key.
- 5) Press Δ **volume up/down** to choose AM or PM, and then press the **SAVE** soft key. You will hear a confirmation tone.



note

- Any changes to the global settings menu affect all registered handsets and the base.
- For setting the Day and Time, the idle time-out is extended to 2 minutes.



If the area code has already been stored in memory, the stored area code will be displayed. To change it, use the **DELETE** soft key and number keys to enter the new area code.

Setting CIDCW (Caller ID on Call Waiting)

CIDCW sets the Caller ID on Call Waiting (CIDCW) displays the name and number of an incoming call while you are on the line. Call Waiting Deluxe (CWDX) allows you to handle call waiting calls in seven different ways.

- 1) Press the **MENU** soft key. Select the Global Setup menu, and then the CIDCW submenu.
- 2) Press Δ **volume up/down** to select CW On/CWDX On, CW On/CWDX Off, or CW Off/CWDX Off, and then press the **OK** soft key. You will hear a confirmation tone.



Setting the Area Code

If you enter a 3-digit area code number in the "Area Code" option, your local area code does not appear in the Caller ID message. For calls received from outside your local area code, you will see a full 10-digit number.

- 1) Press the **MENU** soft key. Select the Global Setup menu, and then the Area Code submenu.
- 2) Press the number keypad (**0-9**) to enter a 3-digit area code.
- 3) Press the **OK** soft key. You will hear a confirmation tone.

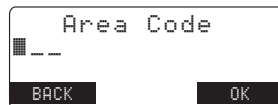

Setting the Dial Mode

Dial Mode sets the dial mode to tone or pulse. Most phone systems use tone dialing; the default setting is tone dialing. Set the dialing mode to match the dialing system used by your local phone service.

- If you are not sure of your dialing system, set the unit to tone dialing. Make a trial call. If the call connects, leave the setting as is; otherwise set the unit to pulse dialing.
- If your phone system requires pulse dialing and you need to send DTMF tones in certain situations during a call, you may switch over to tone dialing (refer to "Tone Dialing Switch-over" on page 36).

- 1) Press the **MENU** soft key. Select the Global Setup menu, and then the Dial Mode submenu.
- 2) Press Δ **volume up/down** to select Tone or Pulse (the initial setting is Tone).
- 3) Press the **OK** soft key. You will hear a confirmation tone.

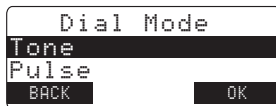

Setting Voice Mail Tone

Voice Mail Tone sets the voice mail tone. If your service does not support SDT message signal, set your VMWI (Visual Message Waiting Inculcator) not to detect SDT message signal.

- 1) Press the **MENU** soft key. Select the Global Setup menu, and then the Voice Mail Tone Submenu.
- 2) Press Δ **volume up** or Δ **volume down** to set the voice message indication (SDT message signal) to On or Off.
- 3) Press the **OK** soft key. You will hear a confirmation tone.



De-register the Handset (Handset only)

Deregister the handset's ID from the main base unit or the base ID from the handset. You will usually only deregister the handset if you are having a problem with your phone or if you need to change the digital security code (see page 58).

- 1) Press the **MENU** soft key. Select the Deregister HS in the menu and press the **OK** soft key. Deregister HS? appears.
- 2) Press Δ **volume up/down** to select Yes and then the **OK** soft key.
When de-registration is complete you will hear a confirmation tone, and Deregistration Complete appears.
- 3) After de-registering the handset, place the handset to the base to register. You must re-register the handset before you can use it.



Making and Receiving Calls

This handset has a built-in speakerphone that allows you to have a hands-free conversation. This feature allows you to easily communicate while performing other tasks, such as cooking.

🔊 icon appears on the display during hands-free conversations.

You can easily switch a call from normal conversation to hands-free conversation. To switch a call, press **speaker** during the call.

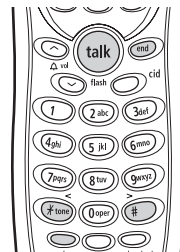

- To set "Autotalk", see page 23 or to set "Anykey Answer" see page 23.
- The handset microphone is located at the bottom of the handset (see "Controls and Functions" on page 4). Position yourself as near to the handset as possible and speak clearly.
- If the line is in use by another handset(s), "Line In Use" appears in the display of all registered handset's display that are not in use.
- The base microphone is located under the base (see "Controls and Functions" on page 5). Position yourself as near to the base as possible.

	From the Handset		From the Base
	Normal conversation	Hands-free conversation	
To answer a call	Handset On the Cradle Pick up the handset (AutoTalk is: on) or pick up the handset and press talk/flash (AutoTalk is: off). Handset Off the Cradle Press any number key, */tone/< , or */> (Any Key Answer), or press talk/flash .	Handset Off the Cradle Press speaker .	Press speaker .
To make a call	Handset Off the Cradle 1) Press talk/flash . 2) Listen for the dial tone. 3) Dial the number. OR Dial the number, and then press talk/flash .	Handset Off the Cradle 1) Press speaker . 2) Listen for the dial tone. 3) Dial the number. OR Dial the number, and then press speaker .	1) Press speaker . 2) Listen for the dial tone. 3) Dial the number. OR Dial the number, and then press speaker .
To hang up	Press end or return the handset to the cradle (AutoStandby).		Press speaker .
To enter a pause within the dialing sequence	When you dial the number in standby mode, press PAUSE soft key. P appears in the display, which represents a pause.		When you dial the number in standby mode, press PAUSE soft key.



- You must subscribe through your local telephone company to receive Call Waiting or Caller ID on call waiting service.
- You can place a call on hold for 5 minutes. When 5 minutes has passed, the call is disconnected, and the phone returns to standby mode.
- While a call is on hold, CIDCW can not be received.

Call Waiting

If you have Call Waiting service and a call waiting tone sounds while you are on a call, press **talk/flash** on the handset or **flash** on the base to accept the waiting call. There is a short pause, and then you will hear the new caller. To return to the original caller, press **talk/flash** on the handset or **flash** on the base again.

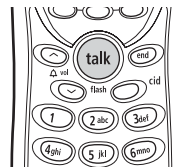

Placing a Call on Hold

- 1) During a call, press **intcom/hold** on the handset or **intercom/hold** base. The call will be put on hold.



If you leave a call on hold for more than 10 seconds, the display screen will read, Line On Hold.

- 2) To talk to the caller, press **talk/flash** or **speaker** on a handset (or **speaker** on the base). The phone will return back to the call.

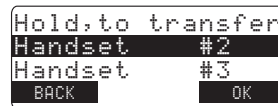

Redialing a Call

The last three phone numbers dialed can be quickly redialed from the handset or base.

- 1) Press the **REDIAL** soft key in standby mode.
- 2) Press Δ **volume up/down**. Each press of Δ **volume up/down** will display one of the last three number redialed.
- 3) Press **talk/flash** or **speaker** on the handset (or **speaker** on the base). The selected number is dialed.
- 4) To hang up, press **end** (or **speaker** on the base).

Deleting a Redial Record (Handset only)

- 1) Press the **REDIAL** soft key in standby mode.
- 2) Press Δ /**vol**/ \wedge or Δ /**vol**/ \vee repeatedly to display the number to be deleted.
- 3) Press the **DELETE** soft key.
- 4) Press Δ /**vol**/ \wedge or Δ /**vol**/ \vee to choose **Yes**.
- 5) Press the **OK** soft key. The redialed number is deleted.

Storing a Redial Record (from the handset only)

- 1) Press the **REDIAL** soft key in standby mode.
- 2) Press Δ /**vol**/ \wedge or Δ /**vol**/ \vee repeatedly to display the number to be stored.
- 3) Press the **STORE** soft key. **Store/Edit Name** appears.
- 4) To complete the setting, follow the steps 3-8 in "Phonebook (Storing Phone Numbers, Names, Distinctive Rings, and Speed dial)" on page 40.

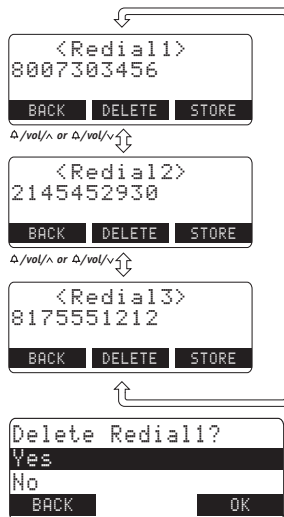

note

- If the number exceeds 32 digits, only the first 32 digits are retained in redial memory.
- If the redial memory is empty, you will hear a beep.
- Redial numbers stored in the handset and the base are independent from each other.

Adjusting the Ringer, and Earpiece and Speaker Volume

Ringer volume

In standby mode, press the volume up key or volume down key on the handset or base to select one of three ringer volume (Off, Low, or High).

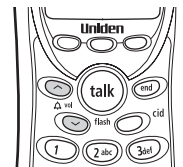

Earpiece and Speaker Volume

You can select from among six volume levels on the handset and ten levels on the base. Pressing the volume up key or volume down key on the handset or base during a call will change the earpiece or speaker volume. This setting will remain in effect after the telephone call has ended.

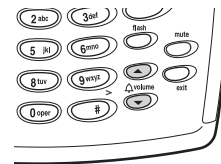

If you press the volume up key when the earpiece is at the maximum volume level, an error tone sounds. The error tone also sounds if you press the volume down key at the lowest volume.

Muting the Ringer

Do Not Disturb (DND)

The do not disturb feature (DND) allows you to mute the ringer, the base, and any registered handsets at the same time. The phone must be in standby mode. Press and hold **do not disturb** on the base. You will hear a confirmation tone, and the **DND** LED illuminates. To cancel the DND feature, press **do not disturb** again. You can also mute the ringer tone while the phone is ringing by pressing **do not disturb** on the base.

Temporarily Muting the Ringer

To mute the ringer tone temporarily for each handset or the base, when the phone is ringing, press the **MUTE** soft key on the handset you want to mute or the base. The mute will last for the current incoming call only. The ringer tone will return to the previous setting starting with the next incoming call.

Mute Microphone

With the handset

You can temporarily mute the microphone so that the caller cannot hear you. Press the **MUTE** soft key during talk mode (while the phone is in use) to mute the microphone. **Mute On** and  appear in the display. To cancel muting, press the **MUTE** soft key again. **Mute Off** appears.

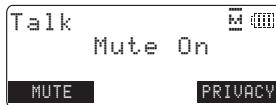

While charging a handset, you can not mute the ringer tone for the handset.

With the base

While using the base speakerphone, press **mute** on the base to mute the microphone. Mute On and  appear in the display. To cancel muting, press **mute** again or press **speaker**. Mute Off appears.

Tone Dialing Switch-over

If your telephone company requires pulse dialing, you can switch-over to tone dialing after the call connects. This feature is useful when you need tone dialing to use any automated menu systems, such as telephone bank tellers, telephone prescription refills, customer support menus, etc.

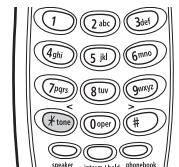

If your phone is set to pulse dialing mode, make your call normally. Once your call connects, press the ***/tone/<** key. Any digits you enter from then on will be sent as tone digits. When this particular call ends, the phone automatically returns to pulse dialing mode.

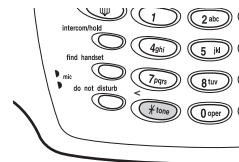

Traveling Out of Range

During a call, as you begin to move your handset too far from your base unit, noise may increase. If you pass the range limits of the base unit, you will hear a beep and see **Out of Range** on the display, and then the handset returns to standby mode.

Privacy Mode

Privacy prevents interruption from other registered handsets or the base. **This works only when the phone is in use.**

Press the **PRIVACY** soft key *on the handset or base during talk mode.*

Privacy Mode On and  appear in the display. To exit the Privacy Mode, press the **PRIVACY** soft key again when the Privacy Mode is on. Privacy Mode Off appears.



Conferencing

If you have more than one handset, up to four people can participate in a conference call.

3-Way Conferencing

- Outside line + Handset + Base (or Handset)

4-Way Conferencing

- Outside line + Handset + Handset + Base

When speaking on the handset

- 1) Press **speaker** on the base to initiate the 3-conference call.
- 2) To hang up, press **speaker** on the base. The handset will still be connected to the call.

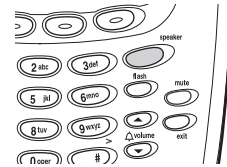

When speaking on the base

- 1) Press **talk/flash** or **speaker** on the handset to initiate the 3 or 4-conference call.
- 2) To hang up, return the handset to the cradle, or press **end** on the handset. The base will still be connected to the call.

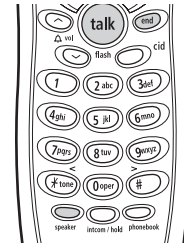



Using One Touch Voice Mail Access

If you subscribe to voice mail service, you can use your phone to access your voice mailbox. The New Message LED flashes whenever you have messages waiting in your voice mailbox.

Just program the handset with your access number, and you can get your messages at the touch of a button. (The voice mail service provider will supply you with the access number. This number may be simply a phone number. Refer to the provider's literature).

To program or delete your Voice Mail Access Number, See page 20.

When you have messages, simply press the  soft key on the handset or base. If you have not entered the access number or it has been deleted, when you press the the  soft key, No Number Stored To store number press [MENU] appears and you will hear a beep. The phone returns to standby mode.

Resetting the New Message LED

If the LED remains on after you've retrieved your messages, you may need to reset the indicators. With the phone is in standby mode, press and hold ***find handset*** on the base until the paging sound stops (about 5 seconds).



note

You must subscribe to voice mail service from your telephone company in order to use this feature. The voice mail service company will provide you with the access number.



- Selecting a Phonebook location where a number is already stored overwrites the old number. The new number will be stored in the Phonebook location.
- When the memory is full, you will hear a beep and **Memory Full** appears. You cannot store names and numbers.
- The pause key counts as one digit. Pressing the **PAUSE** soft key more than once increases the length of the pause between numbers. Each pause represents a 2 second delay.

Phonebook (Storing Phone Numbers, Names, Distinctive Rings and Speed Dial)

You can store names and numbers in your phone's phonebook, search for names alphabetically, and dial phonebook entries with just a few key presses. You can store up to 50 numbers in the base and up to 100 additional numbers in each registered handset.

The phone uses the same memory locations to store phonebook entries and Caller ID messages. Any empty phonebook locations are used to store Caller ID messages. For example, if you have stored 50 phonebook entries on your base unit, the base will not store Caller ID messages.

- 1) When the phone is in standby mode, press **phonebook**.

The following items appear:

- (1st line) The number of the phonebook locations used
- (2nd line) How to search (press the number keypad, **△ volume up/down**)
- (3rd line) How to store (press the **STORE** soft key)
- (4th line) The **BACK**, **COPY**, and **STORE** soft keys.



- 2) Press the **STORE** soft key, **Store/Edit Name** appears.
- 3) Enter the name (up to 16 characters) by using the number keypad (see the "Steps for Entering Names and Special Characters" on page 42).

If a name is not required, go to step 4. <No Name> will be used as the name.



- 4) Press the **OK** soft key to store the name; Store/Edit No. appears.
- 5) Use the number keypad, ***/tone/<**, or **#/>** to enter the phone number (up to 20 digits).
If you make an error, use the **DELETE** soft key to erase the incorrect digits. When you are finished, press the **OK** soft key to store the number.
- 6) If you store the phonebook location from the handset, Distinctive Ring appears. Press **△ volume up/down** to move the pointer to one of the Distinctive Ring options and then press the **OK** soft key.
- 7) Speed Dial appears. Press **△ volume up/down** to move the pointer to select the Speed dial location (10 locations: SPD1-SPD0).
- 8) Press the **OK** soft key. You will hear a confirmation tone, and Done! appears in the display.

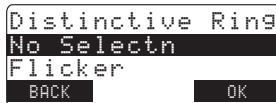

- If you choose not to store a Distinctive Ring, simply select the "No Selectn" option.
- If you choose not to store the name/number as a Speed Dial, simply choose the "No Selectn" option.

Chain Dialing

The memory locations in the handset are not limited to phone numbers. You can also store a group of numbers (up to 20 digits) that you need to enter once your call connects. This is referred to as Chain Dialing.

An example of this is a bank account number. Store the account number in one of the phonebook locations (refer to "Phonebook (Storing Phone Numbers, Names, Distinctive Rings and Speed Dial)" on page 40). When you call your bank and are prompted to enter the account number, scroll through your phonebook locations until you find your account number, and then press the **DIAL** soft key.

Steps for Entering Names and Special Characters

Refer to the letters on the number keys to select the desired characters. With each press of a number key (**0-9**), the displayed character appears in the following order: Upper case letters first, lower case letters next and finally the number corresponding to the key.

	Number of times key is pressed								
keys	1	2	3	4	5	6	7	8	9
1	1								
2 abc	A	B	C	a	b	c	2		
3 def	D	E	F	d	e	f	3		
4 ghi	G	H	I	g	h	i	4		
5 jkl	J	K	L	j	k	l	5		
6 mno	M	N	O	m	n	o	6		
7 pqrs	P	Q	R	S	P	q	r	s	7
8 tuv	T	U	V	t	u	v	8		
9 wxyz	W	X	Y	Z	w	x	y	z	9
0 oper	&	<	>	<	>	/	(blank)	--	--
	.	,	=	?	!	@	'	"	*
	#	0							

If you make a mistake while entering a name

Use ***/tone/**< or **#/**> to move the cursor to the incorrect character.

Press the **DELETE** soft key to erase the wrong character, and then enter the correct character. To delete all characters press and hold the **DELETE** soft key.

For example, to enter **Movies**:

- 1) When the phone is in standby mode, press **Phonebook** and the **STORE** soft key.
Store/Edit Name appears.
- 2) Press **6** once, and then press **#/>** to move the cursor to the right.
- 3) Press **6** six times.
- 4) Press **8** six times.
- 5) Press **4** six times.
- 6) Press **3** five times.
- 7) Press **7** eight times.
- 8) When finished, press the **OK** soft key.

To continue to store the telephone number, proceed to step 5 in "Phonebook (Storing Phone Numbers, Names, Distinctive Rings, and Speed dial)" on page 41.



If the next character uses the same number key, you must press **#/>** to move the cursor over. Otherwise the next time you press the number key, it changes the character that was previously set.

Viewing the Phonebook

Your phone stores names/numbers in the phonebook memory locations, and you can search names in alphabetical order. You can view the phonebook even while the phone is in use.

- 1) Press **phonebook**. If you recall the phonebook during a call, the **COPY** and **STORE** soft key will not appear.



- 2) Press Δ **volume up/down**, or the number keypad to scroll through the phonebook locations. Phonebook locations appear in alphabetical order (from first to last when you press Δ **volume down**, from last to first when you press Δ **volume up**).

You can also use the letters on the number keys to select the first letter of the desired name. Press a number key (**2-9** and **0**) once for the first letter, twice for the second letter, and so on. The first location that begins with the letter you entered appears.

For example, to search for Movies, press **6** once. Press Δ **volume up/down**, until the phonebook location is displayed.

- 3) To finish the viewing operation:

From Handset - press **end** (or the **BACK** soft key or **talk/flash** during a call).

From Base - press **exit** key or the **BACK** soft key.



During a call, don't press **end** on the handset or the call will be disconnected.

Making Calls Using the Phonebook

From Standby Mode

- 1) When the phone is in standby mode, view the phonebook location to dial (see "Viewing the Phonebook" on page 44).
- 2) Press **talk/flash** or **speaker** on the handset or **speaker** on the base. The displayed number is dialed.
- 3) To hang up press **end** on the handset or **speaker** on the base.



From Talk Mode

- 1) Press **talk/flash** or **speaker** on the handset or **speaker** on the base.
- 2) View the phonebook location to dial (see "Viewing the Phonebook" on page 44).
- 3) Press the **DIAL** soft key. The number in the displayed phonebook location is dialed.
- 4) To hang up press **end** on the handset or **speaker** on the base.

Speed Dialing

If you store a phone number in a speed dial memory location (10 locations: SPD1 - SPD0), you can use the speed dialing feature. When the phone is in standby mode, press and hold a number key (**0-9**) associated with the speed dial until the phone number appears, and then press **talk/flash** or **speaker** on the handset or **speaker** on the base. The number stored in the speed dial (SPD1 - SPD0) is dialed.

Editing or Erasing a Stored Name, Phone Number, Distinctive Ring and Speed Dial

- 1) When the phone is in standby mode, press **phonebook**.
- 2) Press Δ **volume up/down**, or the number keypad to select the phonebook locations (see "Viewing the Phonebook" on page 44).
 - a. Editing the Stored Data
 - 1) When the phonebook location to be edited appears, press the **EDIT** soft key. *Store/Edit Name* appears.
 - 2) Follow the steps 3 to 7 under "Phonebook (Storing Phone Numbers, Names, Distinctive Rings, and Speed Dial)" on page 40 to complete the editing operation.
 - 3) Press the **OK** soft key. You will hear a confirmation tone.
 - b. Deleting the Stored Data
 - 1) When the phonebook location to be deleted appears, press the **DELETE** soft key. *Delete Memory?* appears.
 - 2) Press Δ **volume up/down** to move the pointer to *Yes*.
 - 3) Press the **OK** soft key. You hear a confirmation tone. *Deleted!* appears in the display.



Copying Phonebook Locations

Copy Phonebook allows you to transfer stored phonebook locations from handset to handset or from base to handset (or from handset to base) without having to manually re-enter names and numbers. You can transfer one memory (phonebook location) at a time, or all memory locations at once.

- 1) When the phone is in standby mode, press **phonebook**.
- 2) Press the **COPY** soft key.
- 3) Press Δ **volume up/down** to select the handset or base to which you want transfer the phonebook locations and then press the **OK** soft key.
- 4) Press Δ **volume up/down** to select One Memory or All Memories: and then press the **OK** soft key.

If you select All Memory, Are you sure? appears on the display screen.

Press Δ **volume up/down** to select Yes, and then press the **OK** soft key.

If you select One Memory, press Δ **volume up/down**, or the number key (**2-9** and **0**) to select the phonebook location you want to export and then press the **COPY** soft key.

- 5) The phonebook locations will be transferred to the handset (or the base). Copying and the receiving handset name (or base) appear. When the transfer is completed Done! appears on the handset (or the base).

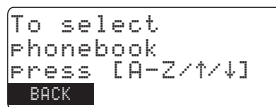
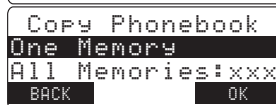
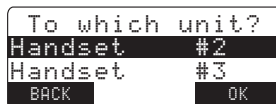

If the memory location on the receiving handset or base is full, and can not store the phonebook locations, you will hear a beep.



- If you answer a call before the Caller ID message is received (for example, before the second ring), the Caller ID message will not appear.
- When the call is received via a telephone company that does not offer Caller ID service, the caller's phone number and name does not appear. (This includes some international calls.)
- When the call is via a private branch exchange (PBX), the caller's phone number and name may not appear.

Caller ID and CIDCW (Caller ID on Call Waiting)

You must subscribe to Caller ID services through your local telephone provider to use these features.

When the telephone rings, the Caller ID feature allows you to view the caller's name, phone number, date and time of call. With CIDCW (Caller ID on Call Waiting), you will hear a call waiting tone while you are on a call, and the Caller ID data is displayed. To accept the waiting call, press **talk/flash** on the handset or **flash** on the base (see page 32). Additionally, you can dial a number stored in the Caller ID list or save data to your Phonebook locations.

Important:

Memory locations for Caller ID messages and Phonebook locations (including Speed Dials) are common; you can store up to 100 locations for each handset and up to 50 locations for the base. A Caller ID message is not stored when you have stored 100 of the phonebook locations in the handset (or 50 locations in the base). When you have stored 100 of the phonebook locations and Caller ID messages in the handset (or 50 in the base) in total, the earliest Caller ID message is overwritten.

The date and time received	12/21 12:30PM
Caller's name	Jane Smith
Caller's phone number	214-555-1234
	BACK DELETE STORE

- 1) When the Caller ID message is received, the display shows the caller's phone number along with the date and time. The incoming call information is stored in the Caller ID record. If the Caller ID service includes the caller's name, the name will appear in the display (up to 15 characters).

You may receive any one of the following messages:

When invalid data is received; Incomplete Data

When a private name is received; Private Name

When a private number is received; Private Number

When a unknown name is received; Unknown Name

When a unknown number is received; Unknown Number

- 2) When you pick up the phone, the display changes to Talk.
(AutoTalk feature is set to on).



Data errors appear as "■."

Viewing the Caller ID List

You can view the Caller ID list through the handset or base during a call or when the phone is in standby mode.

- 1) Press **cid**.

The summary screen appears. The screen shows the number of new messages and total messages.

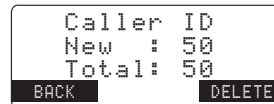

- 2) To view the Caller ID messages in historical order (from new to old or from old to new), repeatedly press

▲ **volume down** to scroll through the messages from the latest to the earliest,
or ▲ **volume up** to scroll back through the messages.



The number of calls from the same Caller ID appears next to the received time. Once you view the new message, the number will be cleared and disappear.



- During a call, don't press **end** on the handset or the call will be disconnected.
- Once the Caller ID data has been deleted, the information cannot be retrieved.

To view the Caller ID messages with alphabetical search, press the number key pad (**2-9** and **0**) with the letter associated with the first letter of the desired message.



Once you view the Caller ID list with alphabetical search, you cannot switch back to historical order (from new to old or from old to new) unless you exit and re-enter the operation.

3) To finish the viewing operation:

From Handset - press **end** (or the **BACK** soft key or **talk/flash** during a call).

From Base - press **exit** key or the **BACK** soft key.

Deleting a Caller ID Message

Deleting Information from the Caller ID List

- 1) When the phone is in standby mode, view the Caller ID information to be deleted (see "Viewing the Caller ID List" on page 49).
- 2) Press the **DELETE** soft key. Delete Caller ID appears.
- 3) Press Δ **volume up/down** to choose **Yes**.
- 4) Press the **OK** soft key. You will hear a confirmation tone.

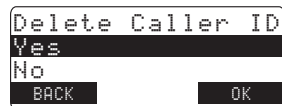

Deleting all Caller ID names/numbers

- 1) When the phone is in standby mode, press **cid**. Press the **DELETE** soft key. Delete All? appears.
- 2) Press **▲ volume up/down** to choose Yes.
- 3) Press the **OK** soft key. You will hear a confirmation tone.

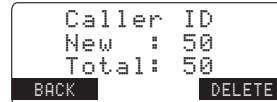

You cannot make a call from the Caller ID list if your phone is connected to a private branch exchange (PBX).

Using the Caller ID Message List

Calling a party from the Caller ID list

Standby mode

- 1) When the phone is in standby mode, select the Caller ID message (see "Viewing the Caller ID List" on page 49).
- 2) To have the phone dial a "1" before the displayed Caller ID number, press ***/tone/<**. To have the phone dial the stored area code before the displayed Caller ID number, press **#/>**.
- 3) Press **talk/flash** or **speaker** on the handset or **speaker** on the base. The displayed phone number dials automatically.





- When a long distance call has been set, "1" appears in the display.
- If the Caller ID message was received as a private/unknown number, or the message does not have the number, you cannot store the message in the Phonebook. If it was received as private/unknown name, the message will be stored as <No Name>.
- Even if the 100 memory locations are full (50 locations for the base), the message will be stored in the Phonebook. However, the message will be erased from the Caller ID list.

Talk mode

- 1) During talk mode press **cid** to review Caller ID message.
- 2) Select the Caller ID message you want to dial (see "Viewing the Caller ID List" on page 49).
- 3) When the Caller ID number is located, press the **DIAL** soft key and the number will be dialed.

Storing Caller ID messages in the Phonebook

Messages shown in the Caller ID list can be stored in the phonebook. The phone number and name of the party on the Caller ID list can be stored in memory.

- 1) When the phone is in standby mode, select the Caller ID message to be stored. Then press the **STORE** soft key. *Store/Edit Name* appears. If the Caller ID message is already stored in memory, you will hear a beep and *This data is already stored!!* appears. The number will not be stored.
- 2) To complete the setting, follow the steps 4-8 in "Phonebook (Storing Phone Numbers, Names, Distinctive Rings, and Speed dial)" on page 40.

Call Waiting Deluxe Features

Your phone gives you new options for call waiting. At the touch of a button, you can place the caller on hold, send them to your voice mail service, or conference them into your current call. You must subscribe to Call Waiting and Call Waiting Deluxe to use these features. Not all features are available in all areas. Check with your local telephone company for details.

- 1) When you receive a Call Waiting call, press the **CWDX** soft key for a list of options.
- 2) Press Δ **volume up/down** or the number keypad (1-7) to select an option.

For example:



- 3) Press the **OK** soft key. A confirmation screen will appear, and the phone returns to the call.

Your phone is pre-programmed with seven call waiting options. You can select to ask the calling party to hold, send them a busy message, forward them to your voice mail, or answer and drop the first caller. You can also select to conference them into the current call or, at any time, choose to drop the first or drop the last caller. Check with your local telephone company for a full list of options.



- To activate features and display the **CWDX** soft key, select **CW** or **CWDX On** in the **CIDCW** option. See page 28.
- You can also answer a waiting call immediately by pressing **talk/flash**, the first caller will be placed on hold. To return to the original caller, press **talk/flash** again.
- If you don't press a key within 30 seconds while in the operation, the phone return to the call.
- To return to call, press the **BACK** soft key.



Handsets can be in Direct Link mode while other handsets are in use.

Multi-Handset Features

The features in this section require a minimum of two handsets to operate. To add additional handsets to your system, see "Expanding Your Phone" on page 14.

Using the DirectLink Mode

To use this feature, you must enter the handsets into DirectLink mode first.

To enter DirectLink mode, see page 18.

DirectLink call

- 1) When the phone is in the DirectLink standby mode, press the **DirecLink** soft key (example of DirectLink from handset #1).
- 2) Select the handset to which you wish to DirectLink with by pressing the number keys (**0-9**). Your handset will then page the other handset.
- 3) On the receiving handset, press **talk/flash**, the **ANSWER** soft key, or if Any Key Answer is on, press any number key, ***/tone/**<, or **#/**>.
- 4) When you finish your conversation, press **end** or the **END** soft key on either handset. Return the handset to the cradle, or press the **CANCEL** soft key and then the **OK** soft key to return to normal standby mode (canceling DirectLink mode).

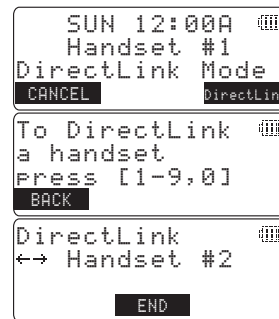
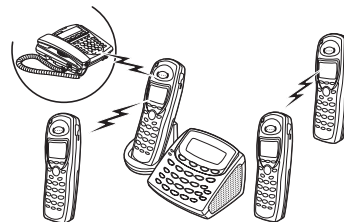

Intercom/Call Transfer Feature

Intercom and Call Transfer features are available for your phone.

Intercom

From handset to handset or handset to the base

- 1) In standby mode, press **intercom/hold**.
- 2) Select the base or the handset you want to talk with within 30 seconds. To select the handset (or the base), press Δ /**vol**/ \wedge or Δ /**vol**/ \vee , and then press the **OK** soft key. If you select **All**, all other handsets and the base will be paged. An intercom tone sounds.



To cancel intercom, press the **CANCEL** soft key.

- 3) To answer the page on a handset, press **talk/flash**, **intercom/hold**, or the **ANSWER** soft key. If Any Key Answer is enabled, pressing a number key, ***/tone/**<, or **#/**> will answer the page. If AutoTalk is enabled, you can answer the page by simply picking up the handset. To answer a page from the base, press **intercom/hold**, **speaker**, or the **ANSWER** soft key.
- 4) To hang up the intercom call, press **end** or the **END** soft key on either handset (or the **END** soft key or **intercom/hold** on the base).



- If the party is busy or out of range, the handset returns to standby mode.
- If you receive an outside/intercom call or page while selecting the other handset (or the base), the operation will be canceled.
- If the party does not answer within one minute, the operation is canceled.

From the base to a handset

- 1) In standby mode, press **intercom/hold** on the base.
- 2) Select the handset you want to talk with within 30 seconds. To select the handset, press **△/volume/▲** or **△/volume/▼**, and then press the **OK** soft key. If you select **A11**, all handsets will be paged. An intercom tone sounds. To cancel intercom, press **intercom/hold** or the **CANCEL** soft key.
- 3) Follow the steps 3-4 under "From handset to handset or handset to the base" on page 55.

Call Transfer Feature

From handset to handset or to the base

- 1) During a call, press **intcom/hold** on the handset.
- 2) Select a handset or the base to transfer the call to within 10 seconds. To select the handset (or the base), press **△/vol/▲** or **△/vol/▼**, and then press the **OK** soft key. If you select **A11**, all other handsets and the base will be paged.

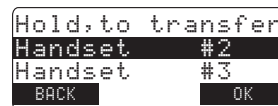

The call will automatically be placed on hold, and an intercom tone sounds.

To cancel the transfer, press **talk/flash**, the **CANCEL** soft key or **speaker** on the initiating handset.

- 3) To answer the page on a handset, press **talk/flash**, **intcom/hold**, or the **ANSWER** soft key. If Any Key Answer is enabled, pressing a number key, ***/tone/<**, or **#/>** will answer the page. If AutoTalk is enabled, you can answer the page by simply picking up the handset. To answer a page from the base, press **intercom/hold**, **speaker**, or the **ANSWER** soft key.
- 4) To hang up the intercom call, press the **END** soft key or **end** key on the handset.

- 5) To speak to the caller, press **talk/flash** on the receiving handset or **speaker** on the base.

From the base to a handset

- 1) During a call, press **intercom/hold** on the base. The call will automatically be placed on hold.
- 2) Select the handset you want to talk with within 10 seconds. To select the handset, press **△/volume/▲** or **△/volume/▼** and then press the **OK** soft key. If you select **ALL**, all handsets will be paged. An intercom tone sounds. To cancel the transfer, press **intercom/hold**, **speaker** or the **CANCEL** soft key on the base.
- 3) To answer the page on a handset, press **talk/flash**, **intcom/hold**, or the **ANSWER** soft key. If Any Key Answer is enabled, pressing a number key, ***/tone/<**, or **#/>** will answer the page. If AutoTalk is enabled, you can answer the page by simply picking up the handset.
- 4) To hang up the intercom call, press **intercom/hold** on the base.
- 5) To speak to the caller, press **talk/flash** on the receiving handset.

Changing the Digital Security Code

The digital security code is an identification code used to connect the handset and the base unit. Normally, setting the code is not necessary. In the rare situation that you suspect another cordless telephone is using the same security code, you can change the code. To change the digital security code:

1. De-register all the handsets you have (see "De-register the handset (Handset only)" on page 30).
2. Register the handsets by following step 2-3 in "Register the handset" on page 15.



note

If the battery pack is completely drained, the handset will not beep when paging.

Find Handset

To locate the handset, press **find handset** on the base when the phone is in standby mode. All registered handsets beep for 60 seconds, and **Paging** appears on the handset display. To cancel paging, press any key on the handset or **find handset** on the base.

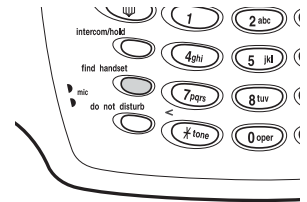

Installing the Beltclip

To attach the beltclip

Insert the beltclip into the holes on each side of the handset. Press down until it clicks.

To remove the beltclip

Pull either side of the beltclip to release the tabs from the holes.

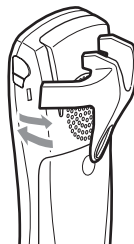

Headset Installation

Your phone may be used with an optional headset. To use this feature, insert the headset plug into the headset jack. Your phone is ready for hands-free conversations. (Headset may be purchased by calling the Uniden Parts Department or visiting the web site. See page 62.)



Note on Power Sources

Battery replacement and handling

When the operating time becomes short, even after a battery is recharged, please replace the battery. With normal usage, your battery should last about one year. Please contact your place of purchase or the Uniden Parts Department for a replacement battery.

Warning

To avoid the risk of personal injury or property damage from fire or electrical shock, only use the Uniden battery model and Uniden adapter model specifically designated for this product.

Power Failure

During the period that the power is off, you will not be able to make or receive calls with the telephone.



Even when the battery pack is not being used, it will gradually discharge over a long period of time. For optimum performance, be sure to return the handset to the base unit after each telephone call.

Caution

- Use only the specified Uniden battery pack (BT-446).
- Do not remove the batteries from the handset to charge them.
- Never throw the battery into a fire, disassemble them, or heat them.
- Do not remove or damage the battery casing.

Low battery alert

When the battery pack is very low, the phone is programmed to eliminate functions in order to save power.

The battery pack needs to be charged when:

- The empty battery icon appears.
- Low Battery appears in the display.

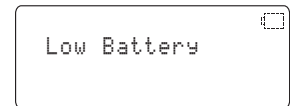

If the phone is in standby mode, none of keys will operate. If you are on a call, complete your conversation as quickly as possible, and return the handset to the cradle.

Cleaning the battery charging contacts

To maintain a good charge, it is important to clean the charging contacts on the handset once a month. Using water only, dampen a cloth to clean the charging contacts. Then make sure to go back over the charging contacts with a dry cloth before returning the handset to the base to charge.

Caution: Do not use paint thinner, benzene, alcohol, or other chemical products. Doing so may discolor the surface of the telephone and damage the finish.



General Information

The phone complies with FCC Parts 15 and 68. Operating temperature:
0 °C to +50 °C (+32 °F to +122 °F)

AC Adapter Information

AC Adapter part number: AD-830 for the base	AD-0005 for the charger (TRU8865-2 only)
Input Voltage: 120 AC 60Hz	120V AC 60Hz
Output Voltage: 9V DC 400mA	9V DC 210mA

Battery Information

Battery part number: BT-446
Capacity: 800mAh, 3.6V



- To avoid damage to the phone use only Uniden AD-830 and BT-446, and AD-0005 with your phone.
- If the handset is left off of the base, the actual Talk mode duration will be reduced respective to the amount of time the handset is off the base.

Recharge your phone on a regular basis by returning the handset to the base after each phone call. When the operating time becomes short even after the battery is recharged, please replace the battery. With normal usage, the battery should last about one year.

A replacement Uniden adapter or battery may be purchased by contacting the Uniden Parts Department (800) 554-3988. Hours are from 8:00 a.m. to 5:00 p.m. Central Time, Monday through Friday, or www.uniden.com.

Specifications, features, and availability of optional accessories are all subject to change without prior notice.

Troubleshooting

If your phone is not performing to your expectations, please try these simple steps first.

Symptom	Suggestion
The charge LED won't illuminate when the handset is placed in the cradle.	<ul style="list-style-type: none"> • Make sure the AC adapter is plugged into the base or the charger (if you have more than one handset) and wall outlet. • Make sure the handset is properly seated in the cradle. • Make sure the charging contacts on the handset are clean.
The audio sounds weak.	<ul style="list-style-type: none"> • Move the handset and/or base away from metal objects or appliances and try again. • Make sure that you are not too far from the base.
Can't make or receive calls.	<ul style="list-style-type: none"> • Check both ends of the base telephone line cord. • Make sure the AC adapter is plugged into the base and wall outlet. • Disconnect the AC adapter for a few minutes, and then reconnect it. • De-register the handset (see "De-register the Handset (Handset only)" on page 30) and register the handset (see "Register the Handset" on page 15). • Make sure that you are not too far from the base. • Make sure the line is not in use. • If an outside call is already established, you can not make another outside call.
The handset doesn't ring or receive a page.	<ul style="list-style-type: none"> • Charge the batteries in the handset for 15-20 hours by placing the handset on the base or charging cradle. • Make sure that you are not too far from the base. • De-register the handset (see "De-register the Handset (Handset only)" on page 30) and register the handset (see "Register the Handset" on page 15).
Unavailable appears in the display.	<ul style="list-style-type: none"> • Make sure that another handset(s) or the base is not in use, and try the phone again. • Make sure that you are not too far from the base.

Symptom	Suggestion
Severe noise interference.	<ul style="list-style-type: none"> • Keep the handset away from microwave ovens, computers, remote control toys, wireless microphones, alarm systems, intercoms, room monitors, fluorescent lights, and electrical appliances. • Move to another location or turn off the source of interference.
The Caller ID does not display.	<ul style="list-style-type: none"> • The handset was picked up before the second ring. • The call was placed through a switchboard. • Call your local telephone company to verify your Caller ID service is current. There may be a problem with your Caller ID service.
You cannot register the handset at the base.	<ul style="list-style-type: none"> • Charge the battery pack for 15-20 hours. • De-register the handset (see "De-register the Handset (Handset only)" on page 30) and register the handset (see "Register the Handset" on page 15).
The handset doesn't communicate with other handsets.	<ul style="list-style-type: none"> • De-register the handset (see "De-register the Handset (Handset only)" on page 30) and register the handset (see "Register the Handset" on page 15). • Make sure that you have registered all handsets.
An extra handset can't join the conversation.	<ul style="list-style-type: none"> • Make sure there are not 2 handsets already using the 3-way conference feature.
The handset or the base can't join the conversation	<ul style="list-style-type: none"> • Make sure that another handset or base is in privacy mode.
Room Monitor feature does not work.	<ul style="list-style-type: none"> • Make sure to place the handset(s) within the range of the base.

Liquid Damage

Moisture and liquid can damage your cordless phone. In case of accidental submersion, please read the following steps.

Case	Action
If the handset or base is exposed to moisture or liquid, but only affects the exterior plastic housing.	Wipe off the liquid, and use as normal.
If moisture or liquid has entered the plastic-housing (i.e. liquid can be heard in the phone or liquid has entered the handset battery compartment or vent openings on the base).	<p>Handset:</p> <ol style="list-style-type: none"> 1) Remove the battery cover and leave it off for ventilation. 2) Remove the battery pack by disconnecting. 3) Leave the battery cover off and the battery pack disconnected for at least 3 days. 4) Once the handset is completely dry, reconnect the battery pack and the battery cover. 5) Recharge the handset's battery pack for 20 hours before using again. <p>Base:</p> <ol style="list-style-type: none"> 1) Disconnect the AC adapter from the base unit, cutting off electrical power. 2) Disconnect the telephone cord from the base unit. 3) Let dry for at least 3 days. <p>IMPORTANT: You must unplug the telephone line while recharging the battery packs to avoid charge interruption.</p> <p>CAUTION: DO NOT use a microwave oven to speed up the drying process. This will cause permanent damage to the handset, base and the microwave oven.</p> <p>After following these steps, if your cordless telephone does not work, please send to:</p> <p style="text-align: center;">Uniden America Corporation Parts and Service Division 4700 Amon Carter Blvd. Ft. Worth TX 76155 1-800-554-3988. Monday through Friday 8 a.m. to 5 p.m. CST</p>

Precautions!

Before you read anything else, please observe the following:

Warning!

Uniden America Corporation DOES NOT represent this unit to be waterproof. To reduce the risk of fire, electrical shock, or damage to the unit, DO NOT expose this unit to rain or moisture.

Rechargeable Nickel-Metal-Hydride Battery Warning

- This equipment contains a rechargeable Nickel-Metal-Hydride battery.
- Nickel is a chemical known to state of California to cause cancer.
- The rechargeable Nickel-Metal-Hydride battery contained in this equipment may explode if disposed of in a fire.
- Do not short-circuit the battery.
- Do not charge the rechargeable Nickel-Metal-Hydride battery used in this equipment in any charger other than the one designed to charge this battery as specified in the owner's manual. Using another charger may damage the battery or cause the battery to explode.

Rechargeable Nickel-Metal-Hydride Batteries Must Be Recycled or Disposed of Properly

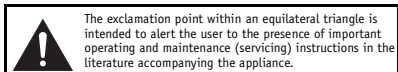

The exclamation point within an equilateral triangle is intended to alert the user to the presence of important operating and maintenance (servicing) instructions in the literature accompanying the appliance.

Uniden works to reduce lead content in our PVC coated cords in our products and accessories.

Warning!

The cords on this product and/or accessories contain lead, a chemical known to the State of California to cause birth defects or other reproductive harm. **Wash hands after handling.**

Important Safety Instructions

When using your telephone equipment, these basic safety precautions should always be followed to reduce the risk of fire, electrical shock, and injury to persons:

1. Read and understand all instructions.
2. Follow all warnings and instructions marked on the product.
3. Unplug this product from the wall outlet before cleaning. Use a dry cloth for cleaning without liquid or aerosol cleaners.
4. Do not use this product near water; for example, near a bathtub, swimming pool, kitchen sink or laundry tub, in a wet basement, or near a swimming pool.
5. Do not place this product on an unstable cart, stand, or table. The telephone may fall, causing serious damage to the unit.

6. Slots and openings in the cabinet and the back or bottom are provided for ventilation. To protect the product from overheating, these openings must not be blocked or covered. This product should never be placed near or over a radiator or heat register. This product should not be placed in a built-in installation unless proper ventilation is provided.
7. This product should be operated only from the type of power source indicated on the marking label. If you are not sure of the type of power supply to your home, consult your dealer or local power company.
8. Do not allow anything to rest on the power cord. Do not locate this product where the cord will be damaged by persons walking on it.
9. Do not overload wall outlets and extension cords, as this can result in the risk of fire or electrical shock.
10. Never push objects of any kind into this product through cabinet slots, as they may touch dangerous voltage points or short out parts that could result in a risk of fire or electric shock. Never spill liquid of any kind on the product.
11. To reduce the risk of electric shock, do not disassemble this product. Take it to qualified service personnel when service or repair work is required. Opening or removing covers may expose you to dangerous voltages or other risks. Incorrect reassembly can cause electric shock when the appliance is subsequently used.
12. Unplug this product from the wall outlet and refer servicing to qualified service personnel under the following conditions:
 - A. When the power supply cord is damaged or frayed.
 - B. If liquid has been spilled into the product.
 - C. If the product has been exposed to rain or water.
 - D. If the product does not operate normally when following the operating instructions. (Adjust only those controls that are covered by the operating instructions. Improper adjustment of other controls may result in damage and will often require extensive repair work by a qualified technician.)
 - E. If the product has been dropped or the cabinet has been damaged.
 - F. If the product exhibits a distinct change in performance.
13. Do not use the telephone to report a gas leak in the vicinity of the leak.

Additional Battery Safety Precautions

Caution! To reduce the risk of fire or injury to persons by the battery, read and follow these instructions:

1. Use only the Uniden battery pack specified in the owner's manual.
2. Do not dispose of the battery pack in a fire. The cell may explode. Check the Nickel Metal Hydride battery disposal package insert for disposal instructions.
3. Do not open or mutilate the battery pack. Released electrolyte is corrosive and may cause damage to the eyes or skin. It may be toxic if swallowed.
4. Exercise care in handling the battery in order not to short the battery with conducting materials such as rings, bracelets, and keys. The battery or conductor may overheat and cause burns.

5. Charge the battery pack provided with or identified for use with this product only in accordance with the instructions and limitations specified in the owners manual provided for this product.
6. Observe proper polarity orientation between the battery pack and battery charger.

SAVE THESE INSTRUCTIONS!

Important Electrical Considerations

Unplug all electrical appliances when you know an electrical storm is approaching. Lightning can pass through your household wiring and damage any device connected to it. This phone is no exception.

The FCC Wants You To Know

Changes or modifications to this product not expressly approved by Uniden, or operation of this product in any way other than as detailed by the owner's manual, could void your authority to operate this product. Your telephone complies with Part 68 of FCC Rules. You must, upon request, provide the FCC registration number and the REN to your telephone company. Both numbers are on the base unit.

Note: You must not connect your phone to:

- coin-operated systems
- most electronic key telephone systems

This device complies with part 15 of the FCC rules. Operation is subject to the following two conditions: (1) This device may not cause harmful interference, and (2) This device must accept any interference received, including interference that may cause undesired operation. Privacy of communications, may not be ensured when using this phone.

To insure the safety of users, the FCC has established criteria for the amount of radio frequency energy various products may produce depending on their intended usage. This product has been tested and found to comply with the FCC's exposure criteria. For body worn operation, the FCC RF exposure guidelines were also met when used with the Uniden accessories supplied or designed for this product. Use of other accessories may not ensure compliance with FCC RF exposure guidelines and should be avoided.

Range

Your new phone is designed to achieve the maximum possible range by transmitting and receiving according to the highest specifications set forth by the FCC. We have rated this phone to operate at a maximum distance with the qualification that the range depends upon the environment in which the telephone is used. Many factors limit range, and it would be impossible to include all the variables in our rating. The Maximum Range rating of this phone is meant to be used as a means of comparison against other range claims.

Telephone Line Problems

The FCC has granted the telephone company the right to disconnect service in the event that your phone causes problems on the telephone line. Also, the telephone company may make changes in facilities and services which may affect the operation of your unit. However, your telephone company must give adequate notice in writing prior to such actions to allow you time for making necessary arrangements to continue uninterrupted service. If you are having trouble with your telephone service, you must first disconnect your phone to determine if it is the cause of your problem. If you determine that it is the cause, you must leave it disconnected until the trouble has been corrected.

Radio Interference

Radio interference may occasionally cause buzzing and humming in your cordless handset, or clicking noises in the base. This interference is caused by external sources such as TV, refrigerator, vacuum cleaner, fluorescent lighting, or electrical storm. Your unit is NOT DEFECTIVE. If these noises continue and are too distracting, please check around your home to see what appliances may be causing the problem. In addition, we recommend that the base not be plugged into a circuit that also powers a major appliance because of the potential for interference. Be certain that the antenna on the unit is fully extended when needed. In the unlikely event that you consistently hear other voices or distracting transmissions on your phone, you may be receiving radio signals from another cordless telephone or other source of interference. If you cannot eliminate this type of interference, you need to change to a different channel. Finally, it should be noted that some cordless telephones operate at frequencies that may cause interference to nearby TVs and VCRs. To minimize or prevent such interference, the base of the cordless telephone should not be placed near or on top of a TV or VCR. If interference is experienced, moving the cordless telephone farther away from the TV or VCR will often reduce or eliminate the interference.

More than One Cordless Telephone

If you want to use more than one cordless telephone in your home, they must operate on different channels. Press the channel key to select a channel that provides the clearest communication.

Cordless Telephone Privacy

Cordless telephones are radio devices. Communications between the handset and base of your cordless telephone are accomplished by means of radio waves which are broadcast over the open airways. Because of the inherent physical properties of radio waves, your communications can be received by radio receiving devices other than your own cordless telephone unit. Consequently, any communications using your cordless telephone may not be private.

Installation Considerations

Selecting a Location

Before choosing a location for your new phone, there are some important guidelines you should consider:

- The location should be close to both a phone jack and continuous power outlet. (A continuous power outlet is an AC outlet which does not have a switch to interrupt its power.)
- Keep the base and handset away from sources of electrical noise such as motors or fluorescent lighting.
- Be sure there is sufficient space to fully extend the base antenna.
- The base can be placed on a desk or tabletop or mounted on a standard telephone wall plate.
- You should charge your new phone for 15-20 hours before completing the installation or using the handset.

Telephone Line Outlets

There are two types of phone outlets:

Modular Jack

Most phone equipment available now uses modular jacks. Phone cords are fitted with a molded plastic connector which plugs into this type of jack. If you do not have modular phone jacks, contact your local telephone company for information about their installation.

Hardwired Jack

Some equipment is wired directly to a phone jack, and these types of installations require a modular jack converter. This type of installation is not difficult; however, you should contact your Uniden telephone dealer or a telephone supply store for advice about the proper adapter or converter for your particular situation.

Connecting the Telephone Cords

Consider these safety guidelines before connecting the telephone cords: Caution!

- *Never install telephone wiring during a lightning storm.*
- *Never touch uninsulated telephone wires or terminals unless the telephone line has been disconnected.*
- *Use caution when installing or modifying telephone lines.*

Applying Power to the Base

This phone requires an AC outlet, without a switch to interrupt power, and the included AC adapter. To relieve strain on the DC plug when the phone is placed on a desk or table, wrap the power cord around the strain relief notch on the bottom of the base.

NOTE: Place the power cord so that it does not create a trip hazard, or where it could become chafed and create a fire or other electrical hazards.

One Year Limited Warranty

Important: Evidence of original purchase is required for warranty service. WARRANTY: UNIDEN AMERICA CORPORATION ("Uniden") ELEMENTS OF WARRANTY: Uniden warrants, for one year, to the original retail owner, this Uniden Product to be free from defects in materials and craftsmanship with only the limitations or exclusions set out below.

WARRANTY DURATION: This warranty to the original user shall terminate and be of no further effect 12 months after the date of original retail sale. The warranty is invalid if the Product is (A) damaged or not maintained as reasonable or necessary, (B) modified, altered, or used as part of any conversion kits, subassemblies, or any configurations not sold by Uniden, (C) improperly installed, (D) serviced or repaired by someone other than an authorized Uniden service center for a defect or malfunction covered by this warranty, (E) used in any conjunction with equipment or parts or as part of any system not manufactured by Uniden, or (F) installed or programmed by anyone other than as detailed by the owner's manual for this product.

STATEMENT OF REMEDY: In the event that the product does not conform to this warranty at any time while this warranty is in effect, warrantor will either, at its option, repair or replace the defective unit and return it to you without charge for parts, service, or any other cost (except shipping and handling) incurred by warrantor or its representatives in connection with the performance of this warranty. Warrantor, at its option, may replace the unit with a new or refurbished unit. THE LIMITED WARRANTY SET FORTH ABOVE IS THE SOLE AND ENTIRE WARRANTY PERTAINING TO THE PRODUCT AND IS IN LIEU OF AND EXCLUDES ALL OTHER WARRANTIES OF ANY NATURE WHATSOEVER, WHETHER EXPRESS, IMPLIED OR ARISING BY OPERATION OF LAW, INCLUDING, BUT NOT LIMITED TO ANY IMPLIED WARRANTIES OF MERCHANTABILITY OR FITNESS FOR A PARTICULAR PURPOSE. THIS WARRANTY DOES NOT COVER OR PROVIDE FOR THE REIMBURSEMENT OR PAYMENT OF INCIDENTAL OR CONSEQUENTIAL DAMAGES. Some states do not allow this exclusion or limitation of incidental or consequential damages so the above limitation or exclusion may not apply to you.

LEGAL REMEDIES: This warranty gives you specific legal rights, and you may also have other rights which vary from state to state. This warranty is void outside the United States of America and Canada. PROCEDURE FOR OBTAINING PERFORMANCE OF WARRANTY: If, after following the instructions in the owner's manual you are certain that the Product is defective, pack the Product carefully (preferably in its original packaging). The Product should include all parts and accessories originally packaged with the Product. Include evidence of original purchase and a note describing the defect that has caused you to return it. The Product should be shipped freight prepaid, by traceable means, to warrantor at:

Uniden America Corporation
Parts and Service Division
4700 Amon Carter Blvd.
Fort Worth, TX 76155

(800) 297-1023, 8 a.m. to 5 p.m. CST, Monday through Friday

I.C. Notice

TERMINAL EQUIPMENT

NOTICE: This equipment meets the applicable Industry Canada Terminal Equipment Technical Specifications. This is confirmed by the registration number. The abbreviation, IC, before the registration number signifies that registration was performed based on a Declaration of Conformity indicating that Industry Canada technical specifications were met. It does not imply that Industry Canada approved the equipment.

NOTICE: The Ringer Equivalence Number (REN) for this terminal equipment is marked on the equipment itself. The REN assigned to each terminal equipment provides an indication of the maximum number of terminals allowed to be connected to a telephone interface. The termination on an interface may consist of any combination of devices subject only to the requirement that the sum of the Ringer Equivalence Numbers of all the devices does not exceed five.

RADIO EQUIPMENT

The term "IC:" before the radio certification number only signifies that Industry Canada technical specifications were met.

Operation is subject to the following two conditions: (1) this device may not cause interference, and (2) this device must accept any interference, including interference that may cause undesired operation of the device. "Privacy of communications may not be ensured when using this telephone".

Memory List

	Name	Phone No.		Name	Phone No.		Name	Phone No.
1			35			69		
2			36			70		
3			37			71		
4			38			72		
5			39			73		
6			40			74		
7			41			75		
8			42			76		
9			43			77		
10			44			78		
11			45			79		
12			46			80		
13			47			81		
14			48			82		
15			49			83		
16			50			84		
17			51			85		
18			52			86		
19			53			87		
20			54			88		
21			55			89		
22			56			90		
23			57			91		
24			58			92		
25			59			93		
26			60			94		
27			61			95		
28			62			96		
29			63			97		
30			64			98		
31			65			99		
32			66			100		
33			67					
34			68					

Memo

Index

- 0-9**
- 20 ring options 21
- A**
- Animation screen 26
- Anykey Answer 23
- Area Code 28
- AutoTalk 23
- B**
- Banner 24
- Battery
 - Preparing and charging 10
 - Replacement and handling. 60
- Beltclip 59
- C**
- Call transfer feature. 56
- Caller ID
 - Call Waiting 32
 - Caller ID services 48
 - Calling 51
 - CIDCW 48
 - CWDX 53
 - Deleting 50
 - Setting. 28
 - Storing 52
 - Viewing 49
- Chain dialing 41
- Clock 27
- Conferencing 37
- Contrast 25
- Copying phonebook 47
- D**
- Deluxe Call Waiting Features 53
- De-register the handset 30
- Dial mode 29
- Digital security code 58
- DirectLink. 54
- Distinctive ringer. 22
- E, F, G, H**
- Earpiece volume. 34
- Expanding your phone 14
- General information 62
- hands-free conversation 31
- Headset installation 59
- Hold 32
- I, J, K, L**
- I.C. notice 68
- Important safety instructions. 66
- Intercom 55
- Key touch tone 25
- Language 24
- Liquid damage. 65
- M, N, O**
- Making a call. 31
- Mute 35
- P, Q**
- Phonebook
 - Editing 46
 - Erasing 46
 - Making calls. 45
 - Storing 40
 - Viewing. 44
- Precautions. 66
- Privacy Mode. 37
- R**
- Receiving a call 31
- Redialing a call 33
- Register the handset. 15
- Ringer
 - Adjusting. 34
 - Do not disturb 35
 - mute 35
- Room/baby monitor 19
- S**
- Setting up
 - base unit 11
 - extra handset 14
 - Handset. 10, 20
 - Menu options 17
- Soft Key 8
- Speed dialing. 45
- T, U, V, W, X, Y, Z**
- Transferring a call 56
- Troubleshooting 63
- Voice Mail Access 39
- Warranty 67

Main Menu Flow Chart

- From standby mode
- Base

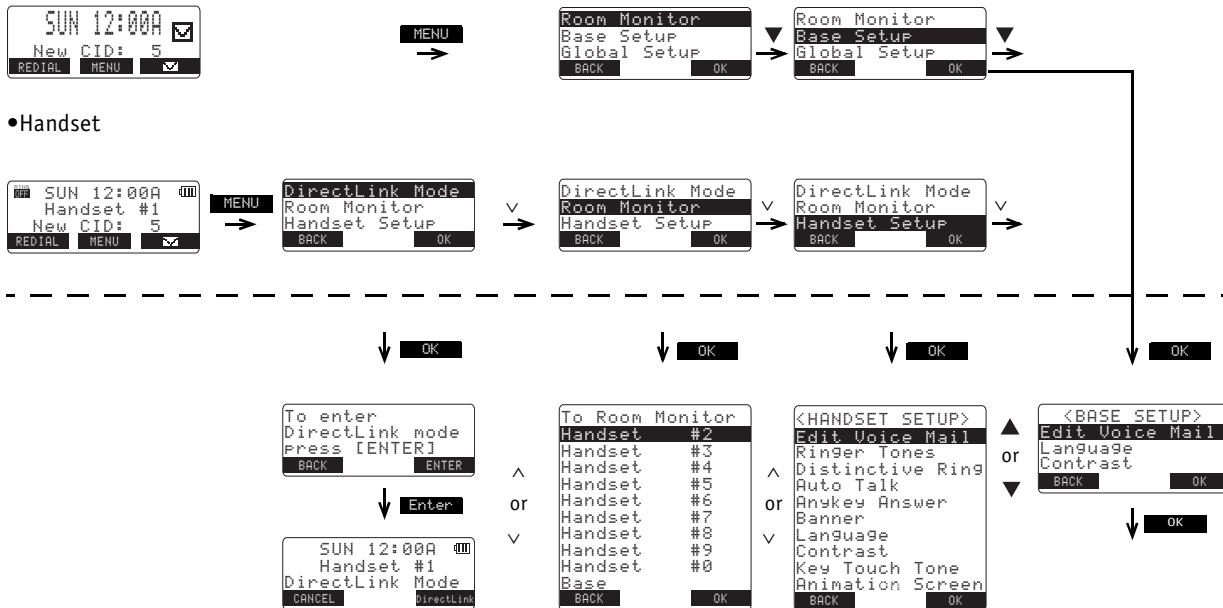

•Base



•Handset

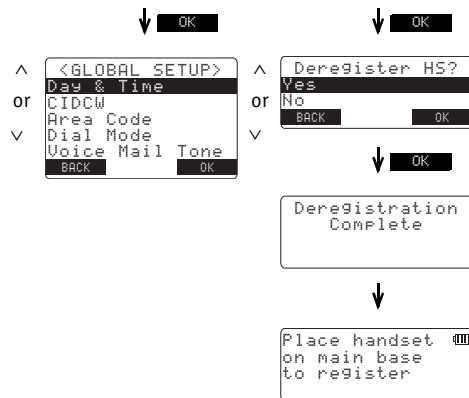
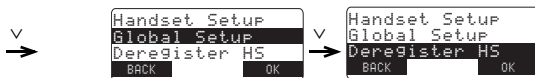

At Uniden, we'll take care of you!

If you need any assistance with this product, please call our Customer Hotline at

1-800-297-1023

PLEASE DO NOT RETURN THIS PRODUCT TO THE PLACE OF PURCHASE.

Our Uniden representatives will be happy to help you with any matters regarding the operation of this unit, available accessories, or any other related matters.

Thank you for purchasing a Uniden product.

Hours: M-F 8:00 AM to 5:00 PM CST.

www.uniden.com



For information on the accessibility features of this product, please call

1-800-874-9314 (V/TTY)

Uniden®

May be covered under one or more of the following U.S. patents:

4,523,058	4,595,795	4,797,916	5,381,460	5,426,690	5,434,905
5,491,745	5,493,605	5,533,010	5,574,727	5,581,598	5,650,790
5,660,269	5,661,780	5,663,981	5,671,248	5,696,471	5,717,312
5,732,355	5,754,407	5,758,289	5,768,345	5,787,356	5,794,152
5,801,466	5,825,161	5,864,619	5,893,034	5,912,968	5,915,227
5,929,598	5,930,720	5,960,358	5,987,330	6,044,281	6,070,082
6,125,277	6,253,088	6,314,278	6,418,209		

FOR
ACCESSORIES,
GO ONLINE @
WWW.UNIDEN.COM

REGISTER ONLINE TODAY!

THANK YOU FOR BUYING A UNIDEN PRODUCT.

A World Without Wires | **Uniden[®]**

Free Manuals Download Website

<http://myh66.com>

<http://usermanuals.us>

<http://www.somanuals.com>

<http://www.4manuals.cc>

<http://www.manual-lib.com>

<http://www.404manual.com>

<http://www.luxmanual.com>

<http://aubethermostatmanual.com>

Golf course search by state

<http://golfingnear.com>

Email search by domain

<http://emailbydomain.com>

Auto manuals search

<http://auto.somanuals.com>

TV manuals search

<http://tv.somanuals.com>