

Uniden®

OWNER'S MANUAL

TRU3466



24.4GHZ
DIGITAL SPREAD SPECTRUM

www.uniden.com

Welcome

The Uniden TRU3466 2.4 GHz Cordless phones are designed and engineered to exacting standards for reliability, longlife, and outstanding performance.

Note: Some illustrations in this manual may differ from the actual unit for explanation purposes.

Features

- 2.4 GHz Extended Range
- 2-Line Operation with Intercom
- Caller ID and Call Waiting Caller ID
- 80 Number Caller ID Memory (40 for each line)
- 30 Number Memory Dialing
- 32 Digit Redial
- Flash and Pause
- Tone/Pulse Dialing
- 10 Days Standby Battery Life
- 6 Hour Talk Time
- Handset Earpiece and Ringer Volume Control
- Speakerphone
- 3-Way and 4-Way Conference Operation
- 2-Way Page/Intercom

The TRU3466 features include **AutoTalk™** and **AutoStandby™**. AutoTalk allows you to answer a call by just removing the handset from the base so you don't have to waste time pushing buttons or flipping switches. AutoStandby allows you to hang up by simply returning the handset to the base.

To protect you against misbilled calls which might result from your phone being activated by other equipment, the TRU3466 has **Random Code™** digital security which automatically selects one of over 65,000 digital security codes for the handset and base. Also, the **AutoSecure™** feature electronically locks your phone when the handset is in the base.

Be sure to visit our web site: www.uniden.com

Uniden® is a registered trademark of Uniden America Corporation.

AutoTalk, AutoStandby, Random Code, and AutoSecure are trademarks of Uniden America Corporation.

Contents

Welcome/Features		Using your TRU3466 intercom	24
Controls and Functions	2, 3	Call Transfer Feature	25
Getting Started		Using the speakerphone	25
Read this first	4	Memory Features	
Checking the package contents	5	Storing a phone numbers and names	26
Setting up the phone	6	Steps for Entering Names and Special Characters	28
Setting Caller ID options	11	Making calls with memory dialing	30
Entering your Area Code	12	Chain dialing	31
Basics		Editing a stored name and/or phone number	31
Making and receiving calls	13	Erasing a stored name and phone number	33
Terminology	13	Caller ID Features	
Adjusting the handset ringer and earpiece volume	14	Caller ID	34
Redialing a call	15	When the telephone rings	34
Tone dialing switch-over	16	Viewing the Caller ID message list	35
Traveling out-of-range	17	Using the Caller ID list	36
Selecting a different channel	17	Deleting information from the Caller ID list	38
Flash and call waiting	17	Using CIDCW (Caller ID with Call Waiting)	39
Answering a call from the base	18	Additional Information	
Answering a call from the handset	18	Changing the digital security code	40
Making a call from the base	19	Installing the beltclip	41
Making a call from the handset	19	Headset installation	41
Placing a call on hold	20	Note on power sources	42
Using the speakerphone mute feature	20	Maintenance	42
2-Line Features		Troubleshooting	43
2-Line operation	21	General information	44
3-way conferencing	22	Technical information	45
4-way conferencing	23	Index	47

Controls and Functions

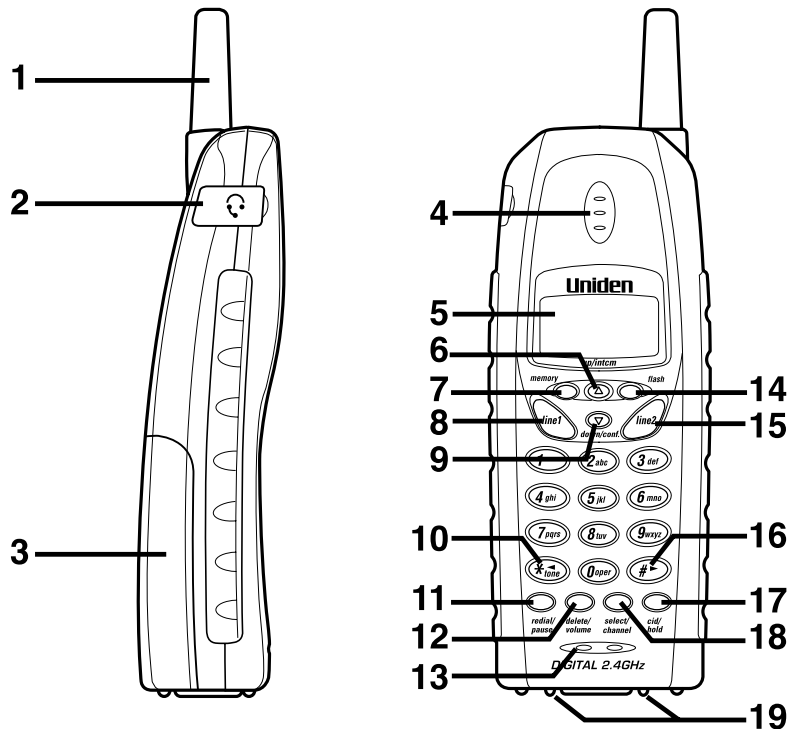

1. Handset Antenna
2. Optional Headset Jack
3. Handset Battery Compartment
4. Handset Earpiece
5. LCD Display
6. ▲/Up/Intercom Key
7. Memory Key
8. Line 1 Key
9. ▼/ Down/Conference Key
10. * / ◀ / Tone Key
11. Redial/Pause Key
12. Delete/Volume Key
13. Handset Microphone and Ringer Speaker
14. Flash Key
15. Line 2 Key
16. # / ▶ Key
17. Caller ID/Hold Key
18. Select/Channel Key
19. Handset Charging Contacts

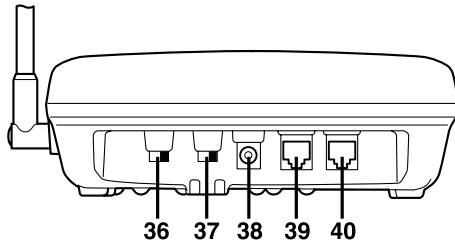
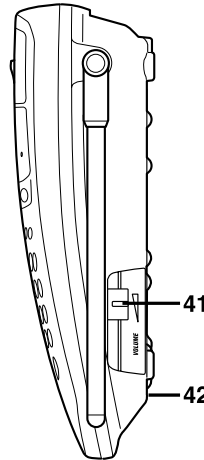
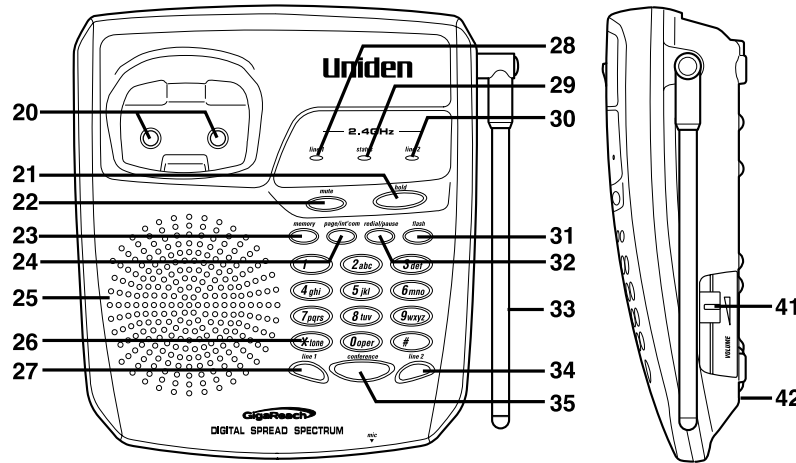

- 20. Base Charging Contacts
- 21. Hold Key
- 22. Mute Key
- 23. Memory Key
- 24. Page/Intercom Key
- 25. Base Speaker
- 26. */Tone Key
- 27. Line 1 Key
- 28. Line 1 LED
- 29. Status LED
- 30. Line 2 LED
- 31. Flash Key
- 32. Redial/Pause Key
- 33. Base Antenna
- 34. Line 2 Key
- 35. Conference Key
- 36. L2 Ring Volume Switch
- 37. L1 Ring Volume Switch
- 38. DC Power Input
- 39. Phone Jack (2nd Line)
- 40. Phone Jack (Line 1 and Line 2)
- 41. Base Speaker Volume Control
- 42. Base Microphone

Read This First

This cordless telephone must be set up before use. Follow these steps:

Step 1 (page 5)

Unpack the telephone and accessories.

Step 2 (page 6)

Next, choose the best location to set up the base unit.

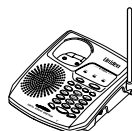

Step 3 (page 7 to 10)

Then, insert the battery pack into the handset. Connect the base unit. You must charge the battery pack for **15-20 hours before plugging into the telephone line and using the phone.**



Step 4 (page 11 to 12)

Finally, set the Caller ID options and store your area code in the memory to use the Caller ID service.

Note: Skip the area code setting if your calling area requires 10-digit dialing.



To realize the full capabilities of your two-line phone, contact the phone company requesting a two-line subscription.

About the digital security code

This cordless telephone uses a digital security code to prevent unauthorized access to your base unit. This security code prevents other cordless handsets from making calls through your base unit.

A random security code will be assigned automatically between your base unit and handset when you charge the battery pack for the first time.

If you want to reset the security code, see page 40.

Checking the Package Contents

Make sure you have received the following items in the package. If any of these items are missing or damaged, contact the Uniden Parts Department (see below).

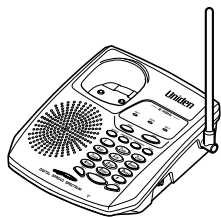

• Base unit



• Handset

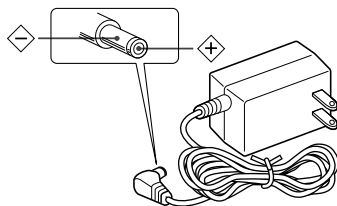

• AC adapter (AD-313)

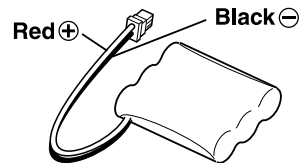

• Rechargeable battery pack (BT-800)

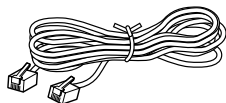

• Telephone line cord



• Beltclip

Also included

- This Owner's Manual
- Quick Reference Guide
- Other Printed Material

Uniden Parts Department at (800) 554-3988
Hours: M-F 7:00 a.m. to 5:00 p.m. CST.
We can also be reached on the web at www.uniden.com

Setting up the Phone

Do the following steps:

- A. Choose the best location
- B. Install the battery pack
- C. Connect the base unit
- D. Choose the dialing mode

A. Choose the best location

Before choosing a location for your new phone, read the **INSTALLATION CONSIDERATIONS** included in the **PRECAUTIONS AND IMPORTANT SAFETY INSTRUCTIONS** brochure. Here are some important guidelines you should consider:

Avoid heat sources, such as radiators, air ducts, and sunlight

Avoid television sets and other electronic equipment

Choose a central location

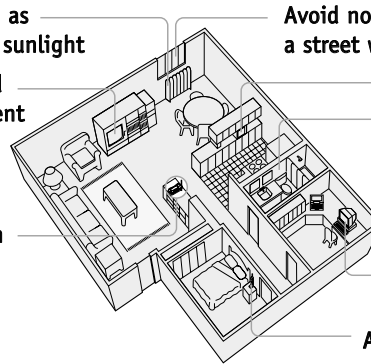

Avoid noise sources such as a window by a street with heavy traffic

Avoid microwave ovens

Avoid excessive moisture, extremely low temperatures, dust, mechanical vibration, or shock

Avoid personal computers

Avoid other cordless telephones

- The location should be close to both a phone jack and a continuous power outlet which is not switchable.
- Keep the base and handset away from sources of electrical noise such as motors, microwave ovens, and fluorescent lighting.
- Be sure there is sufficient space to raise the base antenna to a vertical position.
- The base can be placed on a desk or tabletop.
- If your second phone line has a separate modular jack, place your phone so you can access both jacks.



 note

Use only the Uniden Battery (BT-800) supplied with your phone. Replacement batteries are also available through the Uniden Parts Department (See page 5).

B. Install the battery pack

Charge the battery pack for at least 15-20 hours before plugging the phone line into your phone.

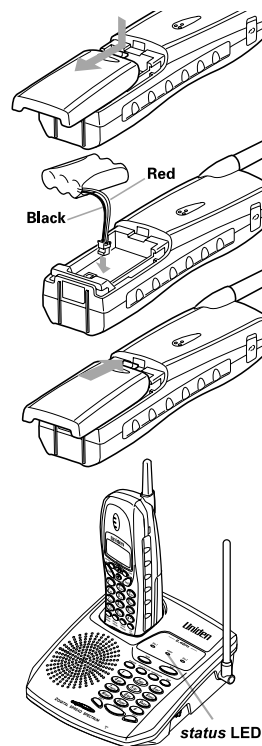
- 1) Press in on the battery cover release and slide the cover down until it comes off.
- 2) Connect the battery pack connector observing correct polarity (black and red wires) to the jack inside the battery compartment.
Do not exert any force on this connection. It could cause damage to the battery or handset. The plastic connector will fit together only one way. Once you are certain that you have made a good connection, then insert the battery pack into the battery compartment. Do not pinch the wires.
- 3) Securely close the battery compartment cover by sliding it up until it snaps into place.
- 4) Place the handset in the base unit.





- Even when the battery pack is not being used, it will gradually discharge over a long period of time. For optimum performance, be sure to return the handset to the base unit after each telephone call.
- If you must replace the battery pack during a telephone call, complete the replacement of the battery pack within 30 seconds, and you can return to the original call.

Battery use time (per charge)

From fully charged

- Six hours continuous use.
- Ten days when the handset is in the standby mode.

Low battery alert

When the battery pack is very low and needs to be charged, the phone is programmed to eliminate functions in order to save power. If the phone is not in use, "Low Battery" flashes on the LCD and none of the keys will operate.

If the phone is in use, "Low Battery" flashes and the handset beeps. Complete your conversation as quickly as possible and return the handset to the base unit for charging.

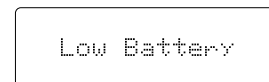

The last number dialed in the redial memory is retained for up to 2 minutes. The handset memory backup can hold names and numbers stored in the memory locations even if the battery pack is completely discharged.

Cleaning the charging contacts

To maintain a good charge, it is important to clean the battery contacts on the handset and base unit with a dry cloth or a pencil eraser about once a month.

Do not use any liquids or solvents.

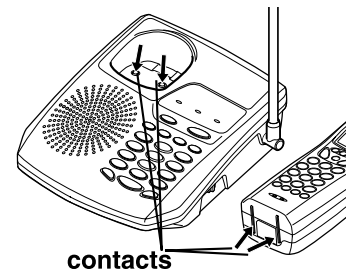

C. Connect the base unit

- 1) Connect the AC adapter to the **DC IN 9V** jack and a standard 120V AC wall outlet.
- 2) Set the base on a desk or tabletop, and place the handset in the base unit as shown.

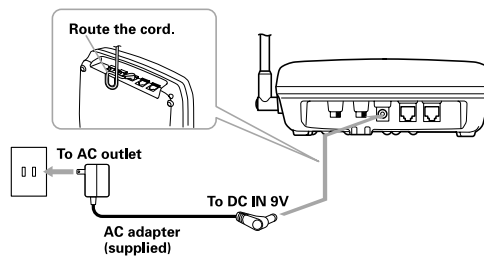

- 3) Raise the antenna to a vertical position.
- 4) Make sure the **status** LED lights. If the LED does not light, check to see that the AC adapter is plugged in and the handset makes good contact with the base charging contacts.

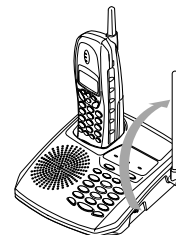

note

- Use only the supplied AD-313 AC adapter. Do not use any other AC adapter.
- Connect the AC adapter to a continuous power supply.
- Place the base unit close to the AC outlet so that you can unplug the AC adapter easily.



Place the power cord so that it does not create a trip hazard or where it could become chafed and create a fire or electrical hazard.



For 2 line subscriptions,

- If the two phone lines are in one modular jack, connect using **TEL LINE 1-2** jack.
- If the two phone lines are on two separate modular jacks, connect using both **TEL LINE 1-2** and **TEL LINE 2** jacks.
- Make sure your battery pack is fully charged before choosing the dial mode.



If your telephone outlet isn't modular, contact your telephone company for assistance.



Modular

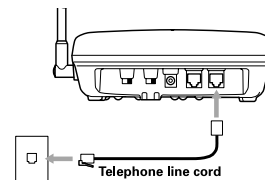

After installing the battery pack in the handset, **charge your handset at least 15-20 hours before plugging into the phone line.** Once the handset battery pack is fully charged, connect the telephone line cord to the base and telephone wall outlet.

5) Connect the telephone line cord to the **TEL LINE 1-2** or **TEL LINE 2** jack and a telephone outlet once the handset is fully charged.

D. Choose the dialing mode

Most phone systems use tone dialing which sends DTMF tones through the phone lines. However some phone systems still use pulse dialing such as in rural areas. The default setting is tone dialing. Depending on your dialing system, set the mode as follows:

- 1) Press and hold **flash** on the base until you hear a confirmation tone.
 - 2) To set the dial mode for pulse dialing, press **#**.
Or to set the dial mode for tone dialing, press *** /tone**. A confirmation tone sounds to indicate the setting is complete.
- If you aren't sure of your dialing system, make a trial call.
If the call connects, leave the setting as is; otherwise, set for pulse dialing.
 - If your phone system requires pulse dialing and you need to send DTMF tones for certain situations during a call, you may "switch-over" to tone dialing. (Refer to "Tone Dialing Switch-over" on page 16.)

Setting Caller ID Options

There are three Caller ID setup options available; they are AutoTalk, CIDCW (Caller ID on Call Waiting), and Area Code. See page 12 for Area Code setup instructions.

AutoTalk allows you to answer the phone without pressing **line 1**.

If the phone rings when AutoTalk is on, simply remove the handset from the base and the phone automatically answers the call. Or if the handset is not on the base, press any key to answer the call. If the phone rings when AutoTalk is off, you must press **line 1** to answer the call.

Caller ID on Call Waiting (CIDCW) performs the same as regular Caller ID on a call waiting number. **You must subscribe to CIDCW from your phone company in order to use this feature.**

To change your Caller ID options:

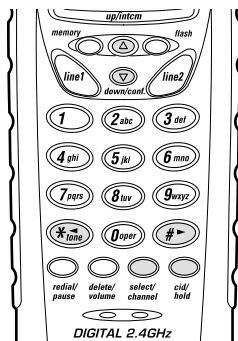

- 1) When the phone is in the standby mode, press and hold **cid/hold** until the Caller ID setting screen appears.

```
Caller ID Setup
┌Line1 Line2
```

- 2) Press *** / ◀ / tone** or **# / ▶** to select "Line1" or "Line2".

- 3) Press **▲ / up/intcm** or **▼ / down/conf.**. The following screen appears.

```
01 Auto Talk: Off
02 CIDCW : On
03 Area Code:
```

- 4) Press **▲ / up/intcm** or **▼ / down/conf.** to move the cursor to the selection that you would like to change. Press the **select/channel** key to toggle between "On" and "Off".

- 5) After you have made your selections, press **cid/hold** and return the handset to the base.



If your calling area requires 10-digit dialing, do not program this option.

Entering Your Area Code

If you enter your 3-digit area code number in the "Area Code" option, your local area code does not appear in the Caller ID messages. Do not program this option, if your calling area requires 10-digit dialing. When reviewing Caller ID messages, you will see only the local seven digit number. For calls received from outside your local area code, you will see a full 10-digit number.

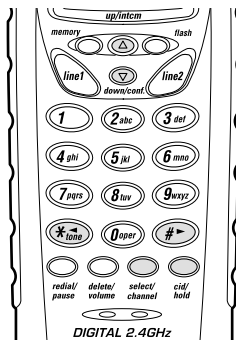

- 1) When the phone is in the standby mode, press and hold **cid/hold** until the Caller ID setting screen appears.
- 2) Press *** /◀ /tone** or **# /▶** to select "Line1" or "Line2".
- 3) Press **▲ /up/intcm** to select "Area Code".
- 4) Press **select/channel**.
- 5) Use the dial buttons (**0** to **9**) to enter the 3-digit area code.
- 6) Press **select/channel**. A tone sounds and the displayed area code is entered.
- 7) Press **cid/hold** to complete the setting. Or return the handset to the base unit. The handset returns to standby mode.

```
Caller ID Setup
▶Line1 Line2
```

```
01 Auto Talk:Off
02 CIDCW :On
03 Area Code:
```

```
01 Auto Talk:Off
02 CIDCW :On
03 Area Code:█
```





When the area code has already been stored in memory, the stored area code will be displayed. To change it, use the **delete/volume** and number keypad to enter the new area code. Then press **select/channel**. To complete the setting, press **cid/hold** or return the handset to the base unit.

```
01 Auto Talk:Off
02 CIDCW :On
03 Area Code:817
```

Making and Receiving Calls

Basic 2-line operation

	Handset On Base 	Handset Off Base 	Base Only 
To answer a call	Pick up the handset (When the AutoTalk is set to on) or pick up the handset and press <i>line1</i> .	Press any key (When the AutoTalk is set to on) or press <i>line1</i> .	Press <i>line 1</i> or <i>line 2</i> .
To make a call	<ol style="list-style-type: none"> 1) Pick up the handset. 2) Press <i>line1</i>. 3) Listen for the dial tone. 4) Dial the number. 	<ol style="list-style-type: none"> 1) Press <i>line1</i>. 2) Listen for the dial tone. 3) Dial the number. 	<ol style="list-style-type: none"> 1) Press <i>line 1</i>. 2) Listen for the dial tone. 3) Dial the number.
To hang up	Press <i>line1</i> , or return the handset to the base (Auto Standby).		Press <i>line 1</i> .

For clarity, the instructions in this owner's manual designates line 1 unless the procedure requires using line 2. The same instructions apply to line 2.

Terminology

Throughout this manual, terms such as Standby and Talk Mode are used. Below is the terminology explanation.

- **Standby Mode** - The handset is not in use, off the base and *line 1* or *line 2* has not been pressed. A dial tone is not present.
- **Talk Mode** - The handset is off the base and *line 1* or *line 2* has been pressed enabling a dial tone.



- You must have a 2-line subscription from your phone company to use the 2-line features.
- Refer to page 11 "Setting Caller ID Options" to turn on the AutoTalk feature if desired.

Adjusting the Handset Ringer and Earpiece Volume

Ringer volume

When the phone is in standby mode, pressing the **delete/volume** on the handset selects the handset ringer volume. There are two ringer volume levels. Press **delete/volume** key to listen to volume levels. The phone keeps the last ringer volume setting selected.

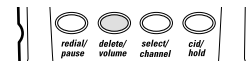

Ringer off

During the standby mode or tone/volume setting, press and hold **delete/volume** until the phone beeps and "Ringer off" appears.

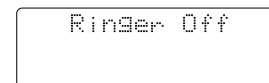

To turn the ringer back on, simply press **delete/volume**. "Ringer High" appears.

Earpiece volume

The handset earpiece volume settings (Low, Medium, High and Maximum) can only be adjusted during a call. Press **delete/volume** repeatedly to select Low, Medium, High or Maximum. When you hang up, the phone keeps the last volume setting selected.

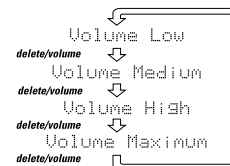

Base ringer volume

The ringer control for the base of your TRU3466 allows you turn the ringer **OFF** or to select **LO/HI** volume for each line.

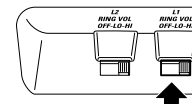

Base speaker volume

To control the speaker volume of the base, adjust the **VOLUME** control switch as desired.

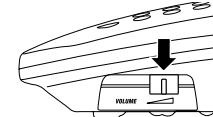

Redialing a Call

The last three phone numbers dialed can be quickly redialed.

Redialing from Standby Mode

From the Handset

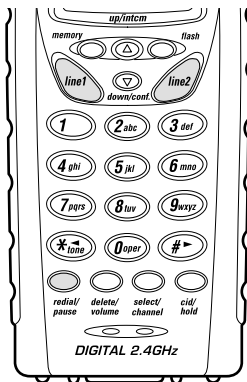

- 1) Press **redial/pause**.
The phone number that was last dialed appears on the display.
- 2) Press **redial/pause** again.
Each press of **redial/pause** will display one of the last three numbers dialed.
- 3) Press **line1**. The "Line1" appears on the display, then the volume setting is displayed.
- 4) The selected number is dialed. After about 5 seconds, the call-time display appears.
- 5) To hang up, press the selected line key or place the handset on the base. The call-time will be displayed for about 5 seconds.

Most recent

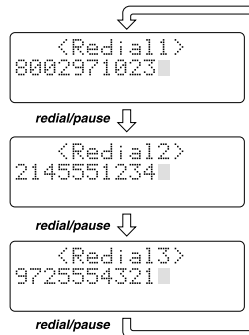

tip

The redial memory function in the handset and base are independent from one another.

note

- If the number exceeds 32 digits, only the first 32 digits are retained for redialing.
- Press and hold **delete/volume** to delete the displayed redial number.
- Refer to terminology explanation on Page 13, if necessary.



Only the last number dialed can be accessed after the selected line key has been pressed.



The tone feature only applies when the dial mode is set to pulse.

Redial from Talk Mode

- 1) Press **line1**.
- 2) Press **redial/pause**.
The last number dialed will be displayed and redialed.
- 3) To hang up, press the select line key or place the handset on the base. The call-time will be displayed for about 5 seconds.

From the Base

- 1) To call the last number dialed from the base, press **line 1**.
- 2) Press **redial/pause**. The last number dialed from the base is redialed.
- 3) To hang up, press the selected line key.

Tone Dialing Switch-over

Some telephone companies use equipment that require pulse dialing (sometimes referred to as rotary dialing). If you need to enter tone dialing digits, you can switch-over to tone dialing during the call. An example of this could be entering your bank account number after you have called your bank. The digits of your bank account can be entered using DTMF tones.

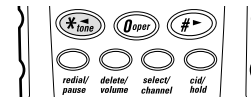

Initially make your call with the pulse dialing mode. Once your call connects, press *** / ◀ / tone** for the handset, or *** / tone** for the base. Enter the desired number (like in example above the bank account number). These digits will be sent as tone dialing. This special number can be stored in a memory location. This is referred to as Chain Dialing (See page 31). Once the call ends, the tone mode is canceled and pulse dialing mode resumes.

Traveling Out-of-Range

During a call, as you begin to move your handset too far from your base unit, noise increases. If you pass the range limits of the base unit, your call will terminate within 30 seconds.

Selecting a Different Channel

If you encounter interference while using your phone, you can manually change the channel for clearer operation. Interference can come from appliances or other phones in your home. This function works only when the phone is use.

The **select/channel** on the handset allows you to choose between 35 different channels. During the course of a conversation, if you hear static or noise which makes it difficult to hear, press **select/channel**. The following screen appears and

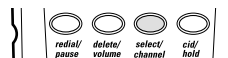

the phone changes to a different channel. For more information on

interference, refer to "Technical Information" on page 45.

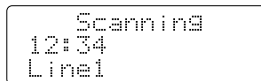

Flash and Call Waiting

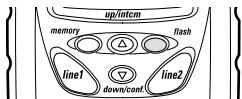

If you have "Call Waiting" service and a call waiting tone sounds while you are on a call, press **flash** to accept the waiting call. There is a short pause, then you will hear the new caller. To return to the original caller, press **flash** again.



You must subscribe through your local telephone company to receive Call Waiting Service.



The flash feature does not function when **line 1** and **line 2** are on a conference call. (See 3-way conferencing and 4-way conferencing, pages 22 and 23).

Answering a Call from the Base

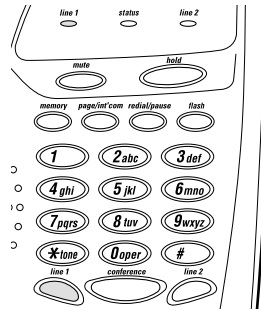

- 1) The base rings. The corresponding **line 1** LED on the base flashes.
- 2) Press **line 1** and speak.
- 3) When you finish the call, press **line 1** to hang up.



If you have the AutoTalk feature on, and the handset is on the base, just pick up the handset and speak. Each line setting is independent for this feature.

Answering a Call from the Handset

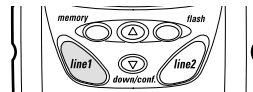

- 1) The handset rings and the following screen appears:
- 2) Press **line1** to answer your call.
- 3) When you finish the call, press **line1** on the handset, or return the handset to the base.

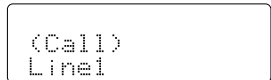

Making a Call from the Base

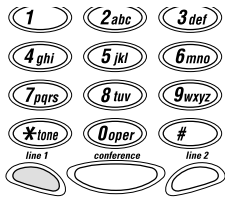

- 1) Press **line 1**.
- 2) Dial the number on the keypad, or use one of the memory features. (See "Making Calls with Memory Dialing", page 30.)
- 3) When you finish the call, press **line 1** to hang up.

Making a Call from the Handset

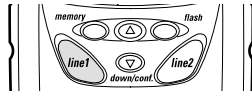

Dialing from talk mode

- 1) Pick up the handset.
- 2) Press **line1**.
- 3) Dial the number on the keypad. Or use one of the memory features. (See "Making Calls with Memory Dialing", page 30.)
- 4) When you finish the call, press **line1** or, return the handset to the base.

Dialing from Standby

To call a number while the handset is in standby mode, dial the number on the keypad, or use one of the memory features. Press **line1**. (See "Making Calls with Memory Dialing", page 30.)

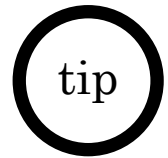

AutoStandby automatically hangs up when you place the handset on the base. There is no need to press **line 1** to hang up.



If a line is in use, or a phone is off the hook, "In Use Line 1" appears on the display.



- Do not use the base and the handset keypads at the same time to place a call on hold.
- If a line is in use, or a phone is off the hook, "In Use Line 1" appears on the display.

Placing a Call on Hold

Use either the keypad on the handset or the keypad on the base.

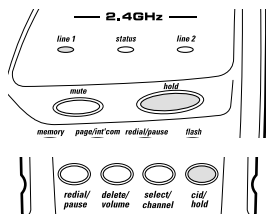

- 1) To place line 1 on hold at the base, press **hold**. The **line 1** LED turns from green to red.
- 2) To place line 1 on hold at the handset, press **cid/hold**. The following screen appears:
- 3) To pick up the call that is holding, press **line 1** on the base or handset.

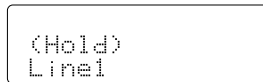

Using the Speakerphone Mute Feature

Your TRU3466 allows you to mute your conversation from the base. This prevents the party you are speaking to from hearing what you, or someone else in the room, is saying.

For example, to use this privacy feature while using line 1.

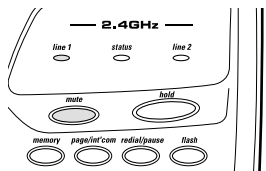

- 1) Press **mute**. The **line 1** LED flashes red. You can hear the party on line 1, but they cannot hear you.
- 2) When you are ready to continue your conversation with the party on line 1, press **mute** again or **line 1**. The **line 1** LED changes to green.

2-Line Operation

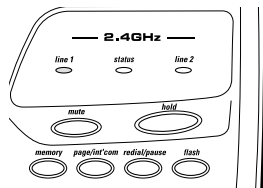

The handset and the base can be used on separate telephone lines at the same time. For example, if the handset is on a call with line 1, you can make, or receive calls at the base on line 2.

The **line 1** LED on the base flashes green to indicate line 1 is in use at the handset.

When line 1 is in use at the base, the LCD screen displays the following:

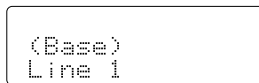

Extension In Use

The Extension In Use feature prevents accidental interruption of ongoing telephone conversations.

If you attempt to make a call and another phone is in use on line 1, the handset LCD indicates an extension is in use. (The **line 1** LED at the base blinks.) If you press **line 1**, you will hear a beep. This warns you the line is in use. To make your call, you must use line 2.



- When you attempt to make a call, the TRU3466 informs you if a line is currently in use.
- If you want to join a conversation on an extension currently in use, press **line 1** or **line 2** twice.



The flash feature does not function when the phone is in conference mode.

3-Way Conferencing

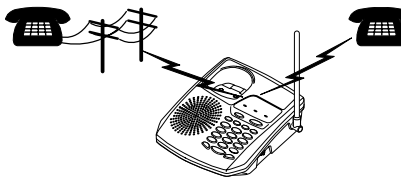

This feature lets you add a third party to your conversation from either the handset or the base.

For example, to add a party to the current call on line 1 at the base:

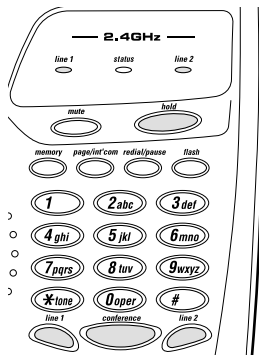

- 1) Press **hold** to place the caller on hold. The **line 1** LED turns from green to red.
- 2) Press **line 2**.
- 3) Dial the number of the person you want to add to the conversation. When the person answers, you can speak privately before bringing the original caller back on the line.
- 4) Press **conference** to bring the original call back on line. The **line 1** and **line 2** LEDs are green.

If the third person's number is busy or doesn't answer, press **line 2** to hang up. Return to the original call by pressing **line 1**.

- 5) To remove either caller from your conversation, ask one of the parties to hang up. Press the corresponding line button to end the call.

Follow steps 1-5 to conference using the handset. When you return the handset to the base, all calls are disconnected.

4-Way Conferencing

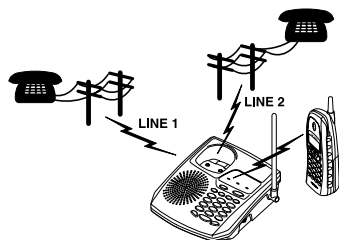

A fourth person, at either the handset or the base, may be added to a conference call.

For example, to add a fourth party at the handset to an ongoing conference call at the base:

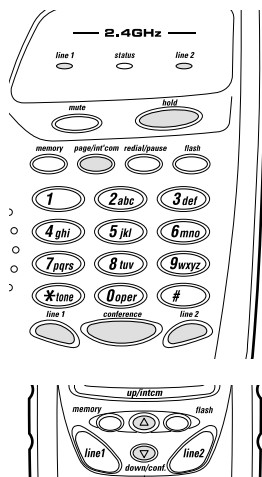

- 1) Press **hold**. The **line 1** and **line 2** LEDs turn red.
- 2) Press **page/int'com** on the base to contact the handset.
- 3) Press **▲/up/intcm** on the handset. Speak to answer the page.
- 4) Press **conference** at the base or **▼/down/conf.** at the handset to bring the party at the handset in on the call. The **line 1** and **line 2** LEDs are green.

The following screen appears:

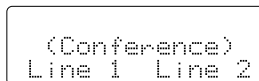

- 5) To remove either caller from your conversation, ask one of the parties to hang up. Press the corresponding line button to end the call.

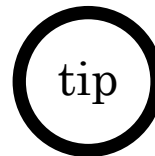

- When the base is paged, the base will ring even when the **RING VOL** switch is set to **OFF**.
- The person at the handset can join the conversation by pressing the line number currently in use.

Using Your TRU3466 Intercom

Paging from the base to handset

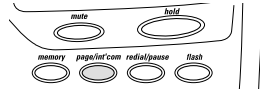

- 1) Press **page/int'com** on the base.
The handset beeps. (If no answer, press **page/int'com** on the base again to disconnect.)

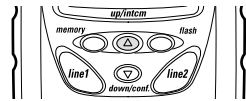

- 2) Press any key on the handset.
Speak into the mouthpiece to answer the page.
- 3) To turn off the intercom, press **page/int'com** on the base or **▲/up/intcm** on the handset.

Paging from the handset to base

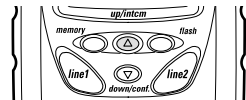

- 1) Press **▲/up/intcm** on the handset. (If no answer, press **▲/up/intcm** on the handset to disconnect.)

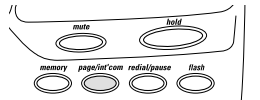

- 2) At the base, press **page/int'com**.
Speak into the base microphone to answer the page.
- 3) To turn off the intercom, press **page/int'com** at the base or **▲/up/intcm** on the handset.

Call Transfer Feature

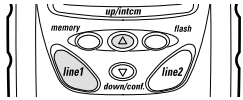

To Transfer from the Handset to the Base

- 1) Press **▲/up/intcm** on the handset. The caller is put on hold and the intercom tone sounds on the base.
- 2) Press **page/int'com** on the base. The intercom mode is activated, but the caller is still on hold.
- 3) To transfer the call to the base, press **▲/up/intcm** on the handset. To cancel the transfer, press **page/int'com** on the base.

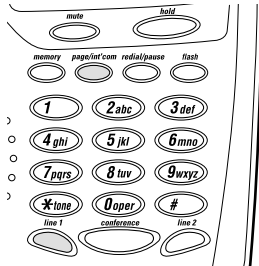

To Transfer from the Base to the Handset

- 1) Press **page/int'com** on the base. The caller is put on hold and the intercom tone sounds on the handset.
- 2) Press **▲/up/intcm** on the handset. The intercom mode is activated, but the caller is still on hold.
- 3) To transfer the call to the handset, press **page/int'com** on the base. To cancel the transfer, press **▲/up/intcm** on the handset.

Using the Speakerphone

You may use the phone as a speakerphone to answer calls by pressing **line 1** on the base. To hang up, press **line 1** again.

The base microphone is located under the phone. Position yourself as near to the base as possible and speak clearly.

If the handset is on the base, you may use either the base keypad or memory dialing to place a call.



- In memory dialing operation, you must press a key within 20 seconds or the phone will return to standby. If you return the handset to the base, the phone will return to standby also.
- You have 20 seconds after pressing *memory* to enter the number you wish to store. Otherwise, an error tone will sound.

Storing a Phone Number and Name

Memory Dialing allows you to dial a number using just a few key presses. TRU3466 series stores up to 30 names/numbers in the handset and 10 numbers in the base.

With the Handset

- 1) Press and hold *memory* until "Memory Store" is displayed.
- 2) Press ▲/*up/intcm* and ▼/*down/conf.* or enter a number (01-30) to select the memory location where you would like to store the number.

```
Memory Store
01 John Smith
02*
```

- 3) Press *select/channel*.
The following screen appears and a cursor flashes indicating that the display is ready for the name to be entered.

```
* Store Name
```

If this screen appears, the selected memory location is already stored. Then you must either change the entry in this location, clear the entry in this location, or select "Go back" to choose another location.

```
Edit Memory01
Delete Memory01
Go Back
```

- 4) To enter a name (up to 13 characters), use the number keys.
 - See "Steps for Entering Names and Special Characters". (See pages 28-29.)
 - Use #/▶ and */◀/*tone* to move the cursor to the desired locations.
 - Use *delete/volume* to delete characters as needed.
 - Press and hold *delete/volume* to delete all the characters.
 - If a name is not required, go to step 5.

- 5) Press ***select/channel***. "Store Number" is displayed. The cursor flashes indicating that the display is ready for the number to be entered.
- 6) Use the number keys to enter the phone number. The phone number cannot exceed 20 digits.
 - Use ***redial/pause*** to enter a pause in the dialing sequence. The display shows a "P". Each pause counts as one digit and represents a two second delay of time between the digits as they are sent.
 - Use ***delete/volume*** to delete digits as needed.
- 7) Press ***select/channel***. The handset beeps and displays the confirmation screen. Memory storage is complete. For example, if you store a name and number into memory location number 7, the display shows "Memory07 Stored". After about 2 seconds, "Memory Store" is displayed. Repeat steps 2-7 to store more numbers.
- 8) Press ***memory*** to return to standby mode.

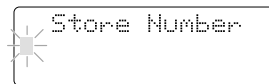

Store Number

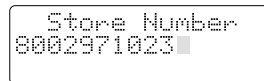

Store Number
0002971023

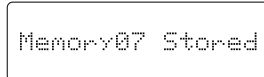

Memory07 Stored

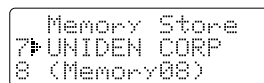

Memory Store
7 UNIDEN CORP
8 (Memory08)



- The pause feature is useful for long distance calling, credit card dialing, or sequences that require a pause between digits.
- The pause key counts as one digit. Pressing ***redial/pause*** more than once increases the length of a pause between numbers.

Steps for Entering Names and Special Characters

Refer to the letters on the number keys to select the desired characters. With each press of a numeric key, the displayed character appears in the following order: Upper case letters first, lower case letters next and finally the number corresponding to the key.

	Number of times key is pressed								
keys	1	2	3	4	5	6	7	8	9
1	1								
2abc	A	B	C	a	b	c	2		
3def	D	E	F	d	e	f	3		
4ghi	G	H	I	g	h	i	4		
5jkl	J	K	L	j	k	l	5		
6mno	M	N	O	m	n	o	6		
7pqrs	P	Q	R	S	P	q	r	s	7
8tuv	T	U	V	t	u	v	8		
9wxyz	W	X	Y	Z	w	x	y	z	9
0	*	#	-	&	()	(blank)	0	

If you make a mistake while entering a name

Use ** /◀/tone* or *# /▶* to move the cursor to the incorrect character. Press *delete/volume* to erase the wrong character, then enter the correct character. To delete all characters, press and hold *delete/volume*.

For example, to enter **Uniden**:

- 1) Pick up the handset. Press and hold *memory*.
- 2) Enter a two-digit number or press ▲/*up/intcm* , ▼/*down/conf*. to select a memory location number.
- 3) Press *select/channel*.
- 4) Press **8** twice.
- 5) Press **6** five times.
- 6) Press **4** six times.
- 7) Press **3** four times, then press #/▶ to move the cursor to the right.

note If the next character uses the same number key, you must press #/▶ to move the cursor over. Otherwise the next time you press the number key, it changes the character that was previously set.

- 8) Press **3** five times.
- 9) Press **6** five times.
- 10) When finished, Press *select/channel*.

To continue to store the telephone number, proceed to step 6 on page 27.

With the base

- 1) Press *memory*.
- 2) Enter the number you wish to store.
- 3) Press *memory*. Enter the memory location number (**0-9**) on the keypad.

A confirmation tone indicates the number is stored.



Making Calls with Memory Dialing

Follow the steps below to dial a number using a programmed memory location:

With the handset

- 1) Press **memory**.
The handset displays your programmed memory locations.
- 2) Press ▲/**up/intcm** and ▼/**down/conf**. or enter a number (01-30) to select the memory location you would like to dial.
- 3) Press **line1**. The number is dialed.

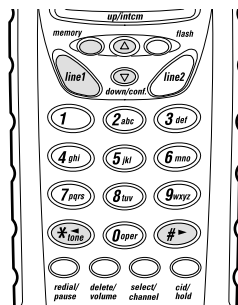

Display a programmed number

Use #/▶ and */◀/tone to toggle between the names display and the numbers display.

Program name

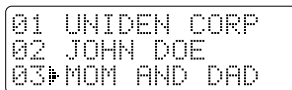

Program number

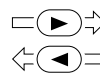
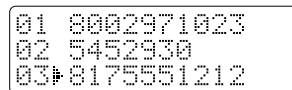

When the stored phone number has 14 or more digits, "➔" is displayed next to the 12th digit. Press #/▶ to see the extra digits and */◀/tone to return.

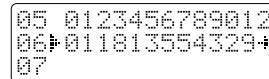

With the base

- 1) Press **line 1**.
- 2) Press **memory**. Enter the memory location number (0-9), to dial the number.

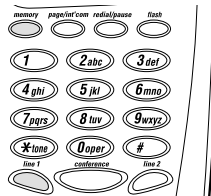

- If you press **select/channel** before **line 1** or **line 2**, you can confirm the name and the number stored in the selected memory location.
- To exit the memory function without dialing press **memory**. The handset returns to standby.
- Whenever you are using a menu screen, you must press a key within 20 seconds or the phone will return to standby.

Chain Dialing

The memory locations on the handset and the base are not limited to phone numbers. You may want to store in memory a group of numbers (up to 20 digits) that you need to enter once your call connects. This is referred to as Chain Dialing.

An example of this is a bank account number. Once you have called your bank, when you are prompted to enter the account number, simply press *memory* and then the location where the special number has been stored.

Store your special number with identifying name in memory as you would a phone number. (Refer to "Storing a Phone Number and Name" on page 26.) Enter a pause as necessary in the sequence.

A pause counts as one digit and represents a two second delay in time between digits as they are sent.

Editing a Stored Name and/or Phone Number

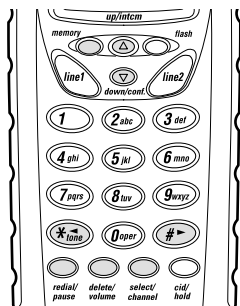

- 1) Press and hold *memory* until "Memory Store" is displayed.

Memory Store
 01 UNIDEN CORP
 02 JOHN DOE
- 2) Press **▲/up/intcm** and **▼/down/conf.** or enter a number (*01-30*) to select the memory location you would like to edit.
- 3) Press *select/channel*.

Edit Memory01
 Delete Memory01
 Go Back

- 4) Press **▲/up/intcm** or **▼/down/conf.** to select "Edit Memory", then press **select/channel**.

The following screen appears.

The cursor flashes indicating that the display is ready for the name to be edited. When a name has not been stored, the cursor appears at the beginning of the second line.

```
Store Name
UNIDEN CORP
```

- 5) Use the number keys, ***/◀/tone**, **#/▶**, or **delete/volume** to edit the name. (See page 26.) To edit only the phone number, skip this step.

- 6) Press **select/channel**. The following screen appears. The cursor flashes indicating that the display is ready for the number to be edited.

```
Store Number
0002971023
```

- 7) Use the number keys, **redial/pause** or **delete/volume** to edit the phone number. The phone number cannot exceed 20 digits. (See page 27.) If you don't want to change the phone number, skip this step.

- 8) Press **select/channel**. The handset beeps and displays the confirmation screen. The memory storage is complete. For example, if you store a name and number into memory location number 1, the display shows few "Memory01 Stored". After a few seconds, "Memory Store" is displayed.

```
Memory01 Stored
```

```
Memory Store
01▶UNIDEN CORP
02 JOHN DOE
```

- 9) Press **memory** to return to standby mode.

Erasing a Stored Name and Phone Number

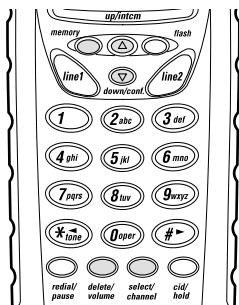

- 1) Press and hold **memory** until "Memory Store" is displayed.
- 2) Press **▲/up/intcm** and **▼/down/conf.** or enter a number (**01-30**) to select the memory location you would like to edit.
- 3) Press **select/channel**.
The following screen appears with the memory location number that you have selected in the display.
- 4) Press **▼/down/conf.** to move the pointer down to "Delete Memory".
- 5) Press **select/channel**. The following confirmation screen appears.
- 6) Press **▲/up/intcm** to move the pointer to "Yes".
- 7) Press **select/channel** or **delete/volume**.
The following screen appears.
- 8) After a few seconds the display returns to the "Memory Store" screen.
You may delete the information in another memory location (return to step 2) or press **memory** to return to standby.

```
Memory Store
01▶UNIDEN CORP
02 JOHN DOE
```

```
▶Edit Memory02
Delete Memory02
Go Back
```

```
Edit Memory02
▶Delete Memory02
Go Back
```

```
Delete Memory02?
Yes
▶No
```

```
Memory02 Deleted
```

```
Memory Store
02▶
03 MOM AND DAD
```



- If you answer a call before the Caller ID message is received (Example : before the second ring), the Caller ID message will not appear.
- When the call is received via a telephone company that does not offer Caller ID service, the caller's phone number and name does not appear. (This includes international calls.)
- When the call is via a private branch exchange (PBX), the caller's phone number and name may not appear.

Caller ID

You must subscribe to Caller ID from your phone company to use this feature.

When the telephone rings, the Caller ID feature allows you to review the caller's name and phone number on the display before you answer the phone. At the second ring, the handset displays the phone number of the incoming call and the name. If your Caller ID service is number only, the name does not appear.

```
Call(Line 1)
UNIDEN CORP
800-297-1023
```

If a name or number is not available, the display shows a message such as "Unknown Number", "Unknown Name", "Private Number", "Private Name", etc.

Additionally, you can dial the displayed number and store the information for memory dialing. Make sure you have turned on the Caller ID/Call Waiting feature (See page 11).

When the Telephone Rings

- 1) When the Caller ID message is received, the display shows the caller's name and phone number. The incoming call information is stored in the Caller ID record. If the Caller ID service includes the caller's name, the caller's name appears on the display (up to 15 letters).

```
Call(Line 1)
UNIDEN CORP
800-297-1023
```

Caller's name ——— UNIDEN CORP
Caller's phone number ——— 800-297-1023



Here are some typical displays:

**When the phone number
and name data are received**

```
Call(Line 1)
UNIDEN CORP
800-297-1023
```

When a private name is received

```
Call(Line 1)
Private Name
800-297-1023
```

When an unknown name is received

```
Call(Line 1)
Unknown Name
800-297-1023
```

When invalid data is received

```
Call(Line 1)
Incomplete Data
```

When a private number is received

```
Call(Line 1)
UNIDEN CORP
Private Number
```

When an unknown number is received

```
Call(Line 1)
UNIDEN CORP
Unknown Number
```

2) When you pick up the phone, the display changes to "Line 1" or "Line 2".
(AutoTalk feature is set to on.)



Data errors appear as "■"

Viewing the Caller ID Message List

The Caller ID list stores information for up to 80 (40 for each line) incoming calls - even unanswered calls.

To review your Caller ID names/numbers, follow the steps below:

1) Press **cid/hold**.

The following screen appears:

```
▶Line1 Line2
NEW 00 02
TTL 03 04
```

2) Use *** /◀/tone , # /▶** to select "Line1" or "Line2" for Caller ID.

- If you have no Caller ID name/numbers, then the total is shown as "00".
- Once a Caller ID message has been viewed, it is no longer considered a new message.



- For long distance calling, insert a "1" by pressing **1** on the keypad before pressing **line 1**.

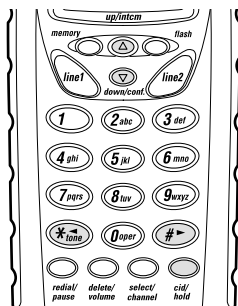

- 3) Press **▼/down/conf.** to display the latest Caller ID message for that line.
- 4) Press **▼/down/conf.** to scan backwards. Or press **▲/up/intcm** to scan forward.
- 5) Press **cid/hold** to return to standby.

Using the Caller ID List

Calling a Caller ID name/number

You can place a call from the Caller ID list. The TRU3466 stores up to 80 (40 for each line) messages.

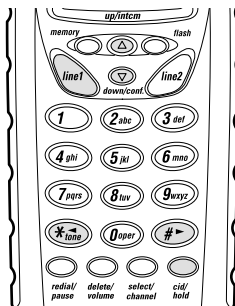

- 1) Press **cid/hold**. The Caller ID summary screen shows the number of new callers and total number of calls.

#	Line1	Line2
NEW	00	02
TTL	03	04

- 2) Use ***/◀/tone** or **#/▶** to select "Line1" or "Line2" caller ID.
- 3) Press **▼/down/conf.** to scan backwards. Press **▲/up/intcm** to scan forward through the list.
- 4) Select the name/number that you would like to dial.
- 5) Press **line1**. The number automatically dials.

Deleting Information from the Caller ID List

The TRU3466 stores up to 80 messages (40 messages each line). If the phone receives the 41st message for a line, the oldest one in the list is automatically deleted. Caller ID data can also be deleted manually.



- While using the "Delete All ?" or "Delete Message ?" screen if no key is pressed within 20 seconds, an error tone sounds and the telephone returns to standby.
- If there is an incoming call or page, the deleting operation is canceled and the phone is set to receive the incoming call or page.

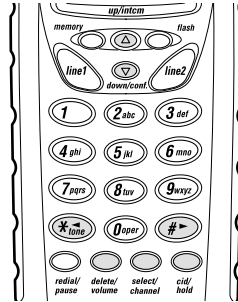

Deleting a Caller ID message

To delete a single Caller ID message, follow the steps below.

- 1) Press **cid/hold**. The Caller ID summary screen shows the number of new callers and total number of calls.
- 2) Use *** / ◀ / tone** or **# / ▶** to select "Line1" or "Line2" Caller ID.
- 3) Select the number that you would like to delete. Press **▲ / up/intcm** or **▼ / down/conf** to find the name/number.

▶Line1	Line2
NEW 00	02
TTL 03	04

- 4) Press **delete/volume**. The following screen appears: If you select "No", the Caller ID screen returns.

12/21 12:30PM 03
Schlitz Maren
817-555-1212

- 5) Press **select/channel** or **delete/volume**. A confirmation tone sounds. The Caller ID screen returns with the next name/number displayed.
- 6) Press **cid/hold** to return to standby.

Delete Message?
▶Yes
No

Deleting all Caller ID names/numbers

To delete all of your Caller ID messages, follow the steps below.

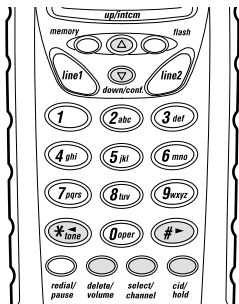

- 1) Press **cid/hold**. The Caller ID summary screen shows the number of new callers and total number of calls.

```

Line1 Line2
NEW 00 02
TTL 03 04
  
```

- 2) Press **delete/volume** to delete names/numbers on line 1. The following screen appears:

```

Del All, Line 1?
Yes
No
  
```

- 3) Use the **▲/up/intcm** to move the cursor to "Yes".

- 4) Press **delete/volume** or **select/channel**. A confirmation tone sounds. The following screen appears:

```

Line1 Line2
NEW 00 00
TTL 00 00
  
```

- 5) Repeat steps 2 through 4. All your Caller ID messages are deleted.

Using CIDCW (Caller ID with Call Waiting)

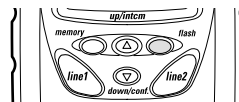

- 1) During a call, when you hear the Call Waiting tone, check the handset display for the name and number of the incoming calls.

```

Call(Line 1)
Schlitz Maren
817-555-1212
  
```

- 2) Press **flash** to accept the incoming call. (See "Flash and Call Waiting", page 18.)



If the handset battery pack is completely discharged or the battery pack is removed, the digital security code will be lost.

If this happens, a new security code is set automatically next time the battery pack is charged.

Changing the Digital Security Code

The digital security code is an identification code used to connect the handset and the base unit. Normally, setting the code is not necessary.

The first time you charge your handset, the security code is automatically set. (See page 4.) In the rare situation that you suspect another cordless telephone is using the same security code, you can change the code.

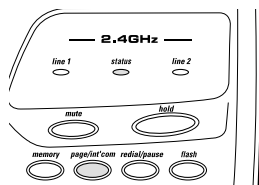

- 1) Remove the handset from the base unit.
- 2) Press and hold *page/int'com* on the base.
- 3) While the handset is emitting a paging sound, place the handset on the base unit. The paging sound stops. Leave the handset on the base for more than 3 seconds or until the *status* LED stops flashing. A new random security code is set.

Installing the Beltclip

To attach the beltclip

Insert the beltclip into the holes on each side of the handset. Press down until it clicks.

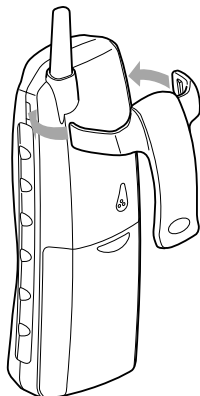

To remove the beltclip

Pull both sides of the beltclip to release the tabs from the holes.

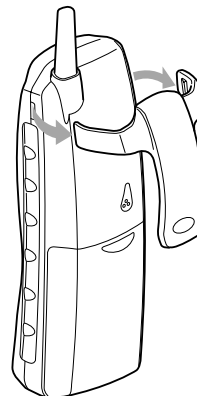

Headset Installation

Your phone may be used with an optional headset, the Uniden HS910. To use this feature, insert the headset plug into the headset jack. Your phone is ready for hands-free conversations. (Headset may be purchased by calling the Uniden Parts Department or visiting the web site. See Page 5.)

If you are using an optional headset, you must still use the handset keypad for phone operations.

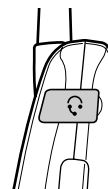

Use only Uniden HS910 headset specifically designed for Uniden phones.

Note on Power Sources

Battery replacement and handling

When the operating time becomes short, even after a battery is recharged, please replace the battery.

With normal usage, your battery should last about one year.

Please contact your place of purchase or the Uniden Parts Department for a replacement battery.

Power Failure

During the period that the power is off, you will not be able to make or receive calls with the telephone.

Caution

- Use the specified battery pack.
- Do not remove the battery from the handset to charge it.
- Never throw the battery into a fire, disassemble it, or heat it.
- Do not remove or damage the battery casing.

Maintenance

When slightly dirty

Wipe with a soft, dry cloth.

When very dirty

Wipe with a soft cloth that has been dampened with diluted, neutral detergent. Dry with a dry cloth.

When the charging terminals become dirty

Wipe with a dry cloth or a pencil eraser, if necessary.

RECYCLING NICKEL-CADMIUM BATTERIES



**NICKEL-CADMIUM BATTERIES
MUST BE DISPOSED OF
PROPERLY.**

Nickel-cadmium cells are used in the battery pack. Please take your used nickel-cadmium battery packs to a store that recycles nickel-cadmium batteries.

Caution

Do not use paint thinner, benzene, alcohol, or other chemical products. Doing so may discolor the surface of the telephone and damage the finish.

Troubleshooting

If your phone is not performing to your expectations, please try these simple steps first.

Symptom	Suggestion
The status LED won't light when the handset is placed in the base unit.	<ul style="list-style-type: none"> • Make sure the AC adapter is plugged into the base unit and wall outlet. • Make sure the handset is properly seated in the base unit. • Make sure the charging contacts on the handset and base unit are clean.
The audio sounds weak and/or scratchy.	<ul style="list-style-type: none"> • Press select/channel during a call to help eliminate background noise. • Make sure that the base unit antenna is in a vertical position. • Move the handset and/or base unit to a different location away from metal objects or appliances and try again. • Make sure that you are not too far from the base.
Can't make or receive calls.	<ul style="list-style-type: none"> • Check both ends of the base unit telephone line cord. • Make sure the AC adapter is plugged into the base unit and wall outlet. • Disconnect the AC adapter for a few minutes, then reconnect it. • Change the digital security code (See page 40). • Make sure line 1 or line 2 is pressed.
The handset doesn't ring or receive a page.	<ul style="list-style-type: none"> • The battery pack may be weak. Charge the battery on the base unit for more than 15-20 hours. • The handset may be too far away from the base unit. • Place the base unit away from appliances or metal objects. • Change the digital security code (See page 40).
Severe noise interference.	<ul style="list-style-type: none"> • Keep the handset away from microwave ovens, computers, remote control toys, wireless microphones, alarm systems, intercoms, room monitors, fluorescent lights, and electrical appliances. • Move to another location or turn off the source of interference.
The Caller ID/CIDCW does not display.	<ul style="list-style-type: none"> • The handset was picked up before the second ring. • The call was placed through a switchboard or private PBX. • Call your local telephone company to verify your Caller ID service is current. • Make sure that the CIDCW option is set to "On". • Charge the handset.

General Information

The phone complies with FCC Parts 15 and 68.

Operating temperature: 0°C to +50°C (+32°F to +122°F)

AC Adapter Information

AC Adapter part number: AD-313

Input Voltage: 120V AC 60Hz

Output Voltage: 9V DC 400 mA

Battery Information

Battery part number: BT-800

Capacity: 800 mAh, 3.6V

Battery use time (per charge)

From fully charged

Talk mode duration: 6 hours

Standby mode duration: 10 days



If the handset is left off of the base, the actual Talk mode duration will be reduced respective to the amount of time the handset is off the base.

Recharge your phone on a regular basis by returning the handset to the base after each phone call. When the operating time becomes short, even after the battery is recharged, please replace the battery. With normal usage, the battery should last about one year.

Replacement batteries may be purchased at your local Uniden dealer or by contacting the Uniden Parts Department (800) 544-3988. Hours are from 7:00 a.m. to 7:00 p.m. Central Time, Monday through Friday. We can also be reached on the web at www.uniden.com

Specifications, features, and availability of optional accessories are all subject to change without prior notice.

Technical Information

The FCC wants you to know!

Changes or modifications to this product not expressly approved by Uniden, or operation of this product in any way other than as detailed by the owner's manual, could void your authority to operate this product. The equipment cannot be used on public coin phone service provided by the telephone company. Connection to party line service is subject to state tariffs. (Contact the state public utility commission, public service commission or corporation commission for information.)

Below is some information that might concern you while using your new phone.

Range

Your new phone is designed to achieve the maximum possible range by transmitting and receiving according to the highest specifications set forth by the FCC. We have rated this phone to operate at a maximum distance with the qualification that the range depends upon the environment in which the telephone is used. Many factors limit range, and it would be impossible to include all the variables in our rating. The Maximum Range rating of this phone is meant to be used as a means of comparison against other range claims.

Telephone Line Problems

The FCC has granted the telephone company the right to disconnect service in the event that your phone causes problems on the telephone line. Also, the telephone company may make changes in facilities and services which may affect the operation of your unit. However, your telephone company must give adequate notice in writing prior to such actions to allow you time for making necessary arrangements to continue uninterrupted service.

If you are having trouble with your telephone service, you must first disconnect your phone to determine if it is the cause of your problem. If you determine that it is the cause, you must leave it disconnected until the trouble has been corrected.

Radio Interference

Radio interference may occasionally cause buzzing and humming in your cordless handset, or clicking noises in the base. This interference is caused by external sources such as TV, refrigerator, vacuum cleaner, fluorescent lighting, or electrical storm. Your unit is NOT DEFECTIVE. If these noises continue and are too distracting, please check around your home to see what appliances may be causing the problem. In addition, we recommend that the base

not be plugged into a circuit that also powers a major appliance because of the potential for interference. Be certain that the antenna on the unit is fully extended when needed.

In the unlikely event that you consistently hear other voices or distracting transmissions on your phone, you may be receiving radio signals from another cordless telephone or other source of interference. If you cannot eliminate this type of interference, you need to change to a different channel.

Finally, it should be noted that some cordless telephones operate at frequencies that may cause interference to nearby TVs and VCRs. To minimize or prevent such interference, the base of the cordless telephone should not be placed near or on top of a TV or VCR. If interference is experienced, moving the cordless telephone farther away from the TV or VCR will often reduce or eliminate the interference.

More Than One Cordless Telephone

If you want to use more than one cordless telephone in your home, they must operate on different channels. Press the channel key to select a channel that provides the clearest communication.

Cordless Telephone Privacy

Cordless telephones are radio devices. Communications between the handset and base of your cordless telephone are accomplished by means of radio waves which are broadcasted over the open airways. Because of the inherent physical properties of radio waves, your communications can be received by radio receiving devices other than your own cordless telephone unit. Consequently, any communications using your cordless telephone may not be private.

Index

0 - 9

- 2-line features
 - 2-line operation21
 - 3-way conferencing22
 - 4-way conferencing23
 - Transferring calls.....25
 - Using the speakerphone25
 - Using your TRU3466 intercom24

A

- Answering a call.....18
- Area code12

B

- Battery pack
 - Install the battery pack7
 - Replacement and handling42

C

- Caller ID features
 - Deleting a Caller ID message38
 - Deleting all Caller ID names/numbers.....39
 - Storing a Caller ID number
 - in a memory location37
 - Using CIDCW (Caller ID with Call Waiting).....39
 - Using the Caller ID list36
 - Viewing Caller ID message list35
- Connect the base unit.....9

D

- Dialing mode10
- Digital security code4, 40

E, F, G

- Earpiece volume14
- Flash and call waiting17

H

- Headset installation41

I, J, K, L

- Installing the beltclip41

M, N

- Maintenance42
- Making a call.....19
- Making and receiving calls13
- Memory features
 - Editing a stored name and/or phone number31
 - Erasing a stored name and phone number33
 - Making calls
 - with memory dialing30
 - Storing a phone number
 - in memory26

O

- Out-of-range17

P, Q

- Package contents5

R

- Redial15
- Ringer volume14

S

- Setting Caller ID options11
- Setup
 - Base unit9
 - Handset7
- Speaker volume14
- Specifications44

T

- Tone dialing switch-over16
- Troubleshooting43

U, V, W, X, Y, Z

- Using the speakerphone mute feature20

Memo

Memo

Memo

At Uniden, we'll take care of you!

If you need any assistance with this product, please call our Customer Hotline at

1-800-297-1023

PLEASE DO NOT RETURN THIS PRODUCT TO THE PLACE OF PURCHASE.

Our Uniden representatives will be happy to help you with any matters regarding the operation of this unit, available accessories, or any other related matters.

Thank you for purchasing a Uniden product.

Hours: M-F 7:00 AM to 7:00 PM CST.

THANK YOU FOR PURCHASING A UNIDEN CORDLESS PHONE

A World Without Wires | **Uniden**[®]

Covered under one or more of the following U.S. patents:

4,511,761	4,523,058	4,595,795	4,797,916	5,381,460	5,426,690
5,434,905	5,491,745	5,533,010	5,574,727	5,650,790	5,660,269
5,661,780	5,663,981	5,671,248	5,717,312	5,754,407	5,768,345
5,787,356	5,838,721	5,864,619	5,893,034	5,912,968	5,915,227
5,929,598	5,930,720	5,960,358	5,987,330	6,044,281	6,070,082
6,125,277					

© 2001 Uniden America Corporation, Fort Worth, TX
All rights reserved.

Printed in China
UCZZ01747BZ

Free Manuals Download Website

<http://myh66.com>

<http://usermanuals.us>

<http://www.somanuals.com>

<http://www.4manuals.cc>

<http://www.manual-lib.com>

<http://www.404manual.com>

<http://www.luxmanual.com>

<http://aubethermostatmanual.com>

Golf course search by state

<http://golfingnear.com>

Email search by domain

<http://emailbydomain.com>

Auto manuals search

<http://auto.somanuals.com>

TV manuals search

<http://tv.somanuals.com>