

www.uniden.com

Welcome

Congratulations on your purchase of the Uniden TRU548 cordless telephone and answering system. This phone is designed and engineered to exacting standards for reliability, long life, and outstanding performance utilizing the latest in 2.4 GHz Spread Spectrum technology.

Note: Some illustrations in this manual may differ from the actual unit for explanation purposes.

Features

- 2.4 GHz Spread Spectrum Technology
- Secure Digital Transmission
- Integrated Answering Device
- Caller ID and Call Waiting Caller ID
- Advanced Caller ID with Call Waiting Options
- 50 Number Caller ID Memory
- 20 Number Memory
- 3 Line, 16 Character Backlit Handset Display
- 3 Redial Memories (up to 32 digits)
- Flash and Pause
- Pulse / Tone Dialing
- 10 Day Standby Battery Life
- 6 Hour Talk Time
- Handset Earpiece and Ringer Volume Control
- Base Speakerphone
- 3-Way Conference Operation
- Bilingual Language, option

The TRU548 features include **AutoTalk™** and **AutoStandby™**. AutoTalk allows you to answer a call by just removing the handset from the base so you don't have to waste time pushing buttons or flipping switches. AutoStandby allows you to hang up by simply returning the handset to the base.

Digital Spread Spectrum Technology utilizes a "wider frequency band" vs. a "single narrow band" used in standard digital transmissions. The 2.4 GHz frequency range was recently released to commercial communications. The result is a more secure conversation with the clarity of digital sound, extended range, and minimal interference from other cordless phones.

To protect you against misbilled calls which might result from your phone being activated by other equipment, the TRU548 has **Random Code™** digital security which automatically selects one of over 65,000 digital security codes for the handset and base. Also, the **AutoSecure™** feature electronically locks your phone when the handset is in the base.

Be sure to visit our web site: www.uniden.com

Uniden® is a registered trademark of Uniden America Corporation.

AutoTalk, AutoStandby, Random Code, and AutoSecure are trademarks of Uniden America Corporation.



Contents

Welcome/Features	iv	3-way conferencing	21
Controls and Functions	2	Flash and call waiting	21
Getting Started		Memory Dialing	
Read this first	4	Storing phone numbers and names	22
Step 1: Checking the package contents	5	Steps for entering names and special characters	24
Step 2: Setting up the phone	6	Making calls with memory dialing	26
Step 3: Installing the battery pack	7	Chain dialing	27
Step 4: Setting Caller ID options/Language	13	Editing a stored name and/or phone number	28
		Erasing a stored name and phone number	30
Basics		Caller ID Features	
Making and receiving calls	15	Caller ID	31
Terminology	16	When the telephone rings	31
Adjusting the volume	17	Viewing the Caller ID Message list	32
Redialing a call	18	Deleting information from the Caller ID list	33
Tone dialing switch-over	19	Using the Caller ID list	34
Traveling out-of-range	20	Call Waiting Features	36
Selecting a different channel	20		
Page	20		

The Integrated Answering Device

Features	37
Turning the answering system on/off	38
Setting up your answering system	38
Using your answering system	42

Additional Information

Changing the digital security code	47
Installing the beltclip	48
Headset installation	48
Note on power sources	49
Maintenance	49
Troubleshooting	50
General Information	52
Technical Information	53
Precautions & Warranty	55
Index	57

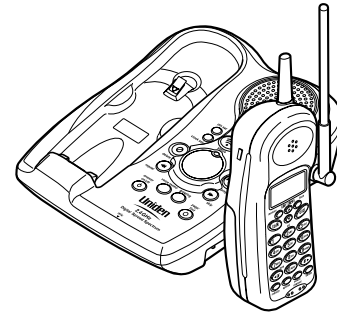

Controls and Functions

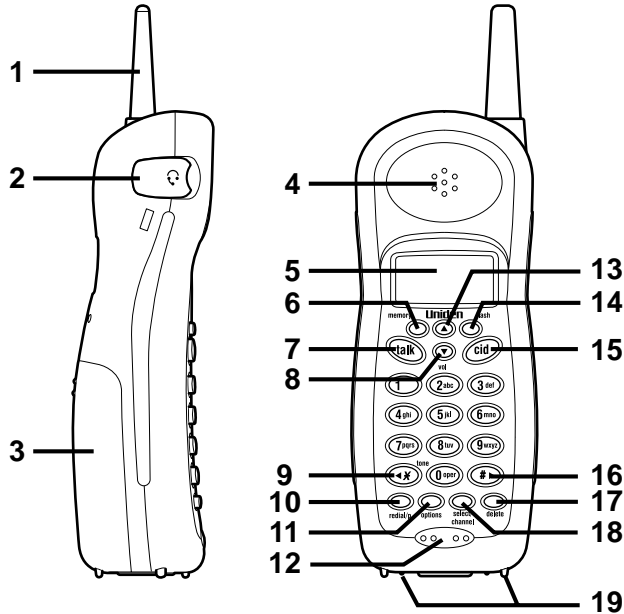

1. Handset antenna
2. Headset jack cover
3. Handset battery compartment
4. Handset earpiece
5. LCD display
6. Memory key
7. Talk key
8. Vol (volume)/▼(cursor down) key
9. */◀(left cursor)/tone key
10. Redial/p (redial/pause) key
11. Options key
12. Handset microphone
13. Vol (volume)/▲(cursor up) key
14. Flash key
15. Cid (Caller ID) key
16. #/▶(right cursor) key
17. Delete key
18. Select/Channel key
19. Handset charging contacts

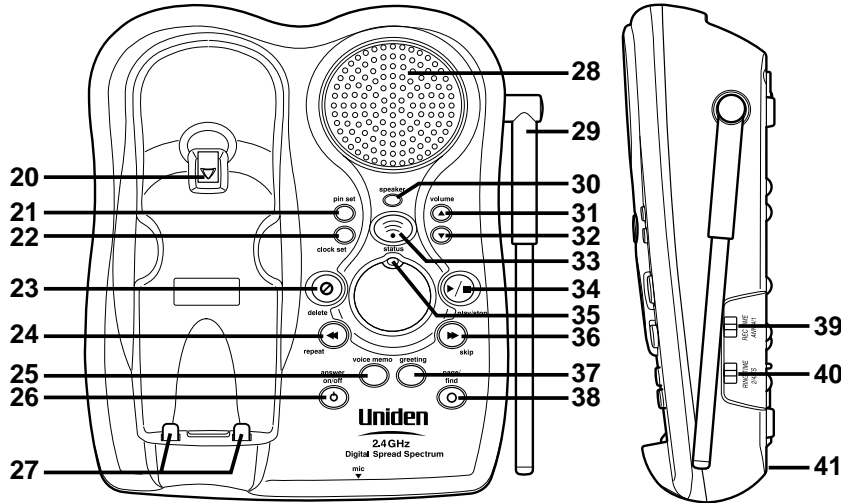

- 20
- 21
- 22
- 23
- 24
- 25
- 26
- 27
- 28
- 29
- 30
- 31
- 32
- 33
- 34
- 35
- 36
- 37
- 38

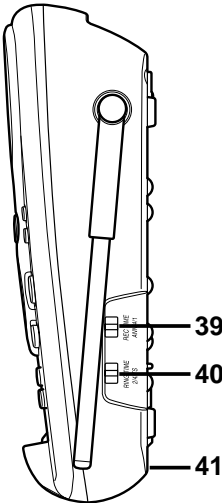

- 20. Base Retainer
- 21. Pin Set Key
- 22. Clock Set Key
- 23. ⓧ (Delete) Key
- 24. ⏮ (Repeat) Key
- 25. Voice Memo Key
- 26. Ⓞ (Answer On/Off) Key
- 27. Base Charging Contacts
- 28. Base Speaker
- 29. Base Antenna
- 30. Speaker LED
- 31. ▲ (Volume Up) Key
- 32. ▼ (Volume Down) Key
- 33. 📶 (Speaker) Key
- 34. ▶/■ (Play/Stop) Key
- 35. Status LED
- 36. ⏭ (Skip) Key
- 37. Greeting Key
- 38. Ⓞ (Page/find) key
- 39. Record Time Switch
- 40. Ring Time Switch
- 41. Base Microphone
- 42. Base Ringer Switch
- 43. Pulse-Tone Switch
- 44. DC Power Input
- 45. Phone Jack

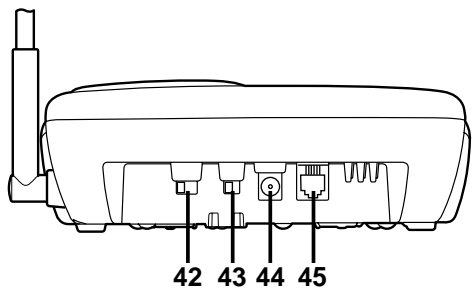

- 42
- 43
- 44
- 45

Read This First

This cordless telephone must be set up before use. Follow these steps:

Step 1 (page 5)

Unpack the telephone and accessories.

Step 2 (page 6)

Next, choose the best location to set up the base unit.



Base unit

Step 3 (page 7 to 10)

Then, insert the battery pack into the handset. You must charge the battery pack for **15-20 hours before plugging into the phone line and using the phone.**



Handset

Step 4 (page 13 to 14)

Finally, set the Caller ID options and store your area code in the memory to use the Caller ID service.



Note: Skip the area code setting if your Handset calling area requires 10-digit dialing.

About the digital security code

This cordless telephone uses a digital security code to prevent unauthorized access to your base unit. This security code prevents other cordless handsets from making calls through your base unit.

A random security code will be assigned automatically between your base unit and handset when you charge the battery pack for the first time.

If you want to reset the security code, see page 47.

Checking the Package Contents

Make sure you have received the following items in the package.
If any of these items are missing or damaged, contact the Uniden Parts Department (see below).

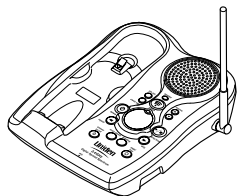

• Base unit



• Handset

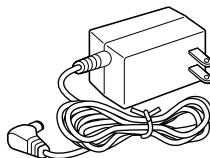

• AC adapter (AD-313)

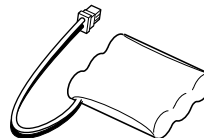

• Rechargeable battery pack (BT-800)

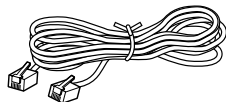

• Telephone line cord



• Beltclip

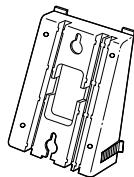

• Wall mount adapter

Also included:

- This Owner's Manual
- Quick Reference Guide
- Registration Card

Uniden Parts Department

(800) 554-3988

Hours: M-F 7:00 AM to 5:00 PM CST.

We can also be reached on the web at www.uniden.com

Setting Up the Phone

Do the following steps:

- A. Choose the best location
- B. Install the battery pack
- C. Connect the base unit
- D. Choose the dialing mode

A. Choose the best location

Before choosing a location for your new phone, read the “Installation Considerations” included in the “Precaution & Warranty”. Here are some important guidelines you should consider:

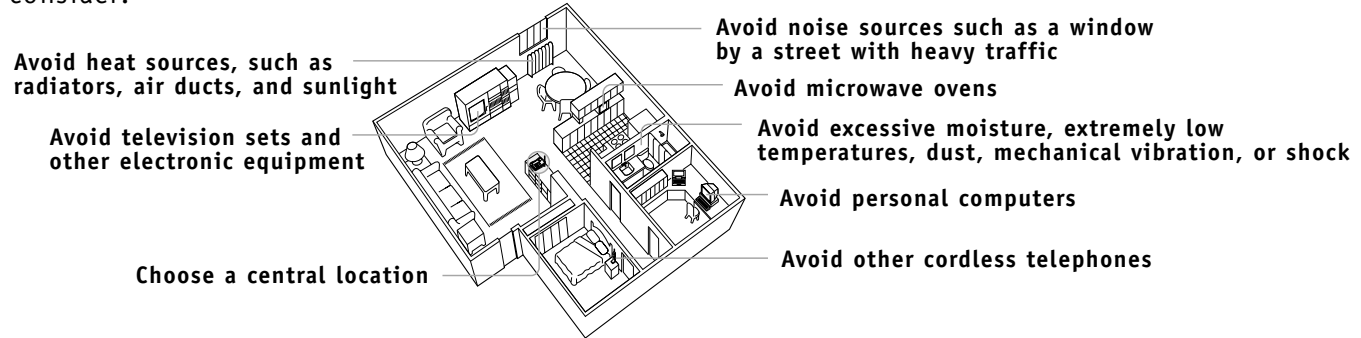

- The location should be close to both a phone jack and a continuous power outlet which is not switchable.
- Keep the base and handset away from sources of electrical noise such as motors and fluorescent lighting.
- Be sure there is sufficient space to raise the base antenna to a vertical position.
- The base can be placed on a desk, tabletop, or mounted on a standard wall plate.

B. Installing the Battery Pack

Charge the battery pack for at least 15-20 hours before plugging the telephone jack and start using your phone.

- 1 Press in on the battery cover release and slide the cover down until it comes off.
- 2 Connect the battery pack connector with the correct polarity (black and red wires) to the jack inside of the battery compartment.

Do not exert any force on this connection. It could cause damage to the battery or to the handset. The plastic connectors will fit together in only one way. Once you are certain that you have made a good connection, then insert the battery pack into the battery compartment. Do not pinch the wires.

- 3 Securely close the battery compartment cover by sliding it up until it snaps into place.
- 4 Place the handset on the base. Remove the beltclip, if attached, for face up charging.

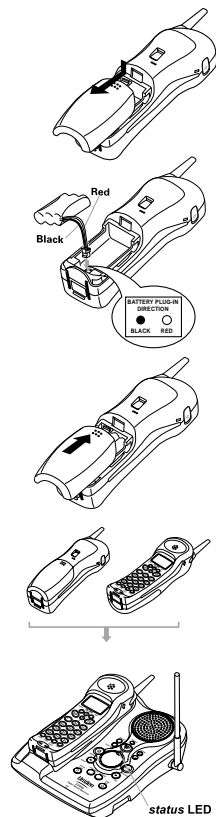

Use only the Uniden Battery (BT-800) supplied with your phone. Replacement batteries are also available through the Uniden Parts Department (See page 5).



- Even when the battery pack is not being used, it will gradually discharge over a long period of time. For optimum performance, be sure to return the handset to the base unit after a telephone call.
- If you must replace the battery pack during a telephone call, complete the replacement of the battery pack within 30 seconds, and you can return to the original call.

Battery use time (per charge)

From fully charged

- 6 hours continuous use
- 10 days when the handset is in the standby mode

Low Battery Alert

When the battery pack is very low and needs to be charged, the phone is programmed to eliminate functions in order to save power. If the phone is not in use, “Low Battery” appears on the LCD and none of the keys will operate.



If the phone is in use, “Low Battery” flashes and the handset beeps. Complete your conversation as quickly as possible and return the handset to the base unit for charging.



The last number dialed in the redial memory, the names and the numbers stored in the memory locations are retained for up to 2 minutes while you replace the battery pack.

Cleaning the Battery Charging Contacts

To maintain a good charge, it is important to clean the battery contacts on the handset and base unit with a dry cloth or a pencil eraser about once month.

Do not use any liquids or solvents.

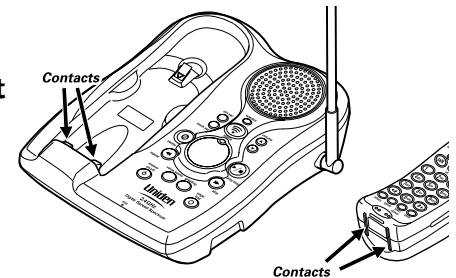

C. Connect the base unit

- 1 Connect the AC adapter to the **DC IN 9V** jack and to a standard 120V AC wall outlet.
- 2 Set the base on a desk or tabletop, and place the handset on the base unit as shown. Remove the beltclip, if attached, for face up charging. (See "Mounting the Base Unit on a Wall", on page 11.)
- 3 Then raise the antenna to a vertical position.
- 4 Make sure that the **status** LED lights. If the LED does not light, check to see that the AC adapter is plugged in and that the handset makes good contact with the base charging contacts.

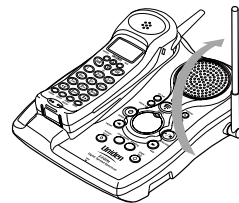
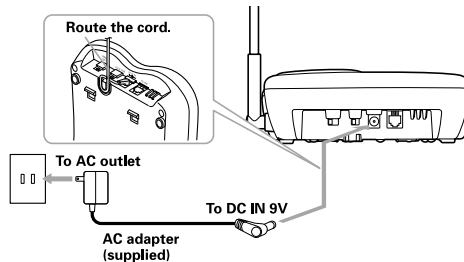

note

- Use only the supplied AD-313 AC adapter. Do not use any other AC adapter.
 - Connect the AC adapter to a continuous power supply.
 - Place the base unit close to the AC outlet so that you can unplug the AC adapter easily.
- 5 After installing the battery pack in the handset, charge your handset **at least 15-20 hours before plugging into the phone line**. Once the handset battery pack is fully charged, connect the telephone line cord to the base and telephone wall outlet.
- 5 Connect the telephone line cord to the **TEL LINE** jack and to a telephone outlet once the handset is fully charged.

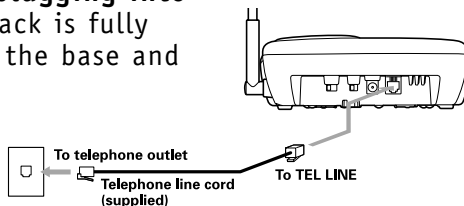

note

If your telephone outlet isn't modular, contact your telephone company for assistance.



The handset can be placed up or face down in the base for charging.



Place the power cord so that it does not create a trip hazard or where it could become chafed and create a fire or electrical hazard.

D. Choose the dialing mode

Most phone systems use tone dialing which sends DTMF tones through the phone lines. However some phone systems still use pulse dialing such as in rural areas. The default setting is tone dialing. Depending on your dialing system, set the mode as follows:

If your dialing system is	Set the switch to
Tone	<i>TONE</i>
Pulse	<i>PULSE</i>

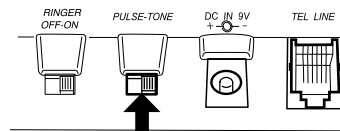

- If you are not sure of your dialing system, set for tone dialing. Make a trial call. If the call connects, leave the setting as is, otherwise set for pulse dialing.
- If your phone system requires pulse dialing and you need to send the DTMF tones for certain situations during a call, you may “switch-over” to tone dialing. (Refer to “Tone Dialing Switch-over” on page 19.)

Mounting the base unit on a wall

Setting the handset retainer clip for wall mounting

- 1 On the base unit, pull the handset retainer out of the slot. Rotate it clockwise 180 degrees.
- 2 Flip the retainer from front to back. Slide it back into the slot so that the lip of the retainer is up and the oval is down. The retainer holds the handset in place.



Standard wall plate mounting

This phone can be mounted on any standard telephone wall plate.

- 1 Snap the wall mount adapter into the notches on the base.
- 2 Plug the AC adapter to the **DC IN 9V** jack. Route the AC adapter cord inside the molded wiring channel as shown.
- 3 Plug the AC adapter into a standard 120V AC wall outlet.
- 4 Plug the telephone line cord into the **TEL LINE** jack. Route the cord inside the molded wiring channel as shown.
- 5 Plug the telephone line cord into the telephone outlet.
- 6 Raise the antenna to a vertical position.
- 7 Align the mounting slots on the base with the mounting posts on the wall. Push in and down until the phone is firmly seated.

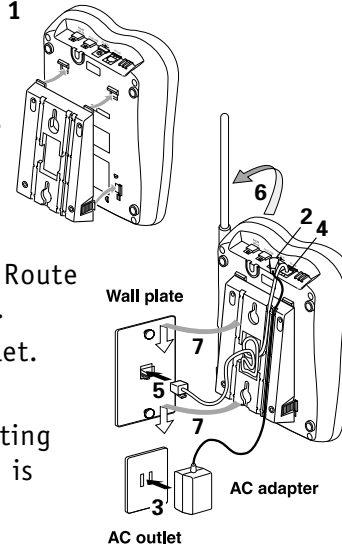

Do not use an outlet controlled by a wall switch.

Direct wall plate mounting

If you don't have a standard wall plate, you can mount your phone directly to the wall. Before doing this, consider the following:

- Avoid electrical cables, pipes, or other items behind the mounting location that could cause a hazard when inserting screws into the wall.
- Try to mount your phone within 10 - 15 feet of a working phone jack to avoid excessive cord lengths.
- Make sure the wall material is capable of supporting the weight of the base and handset.
- Use #10 screws (minimum length of 1-3/8 inches) with anchoring devices suitable for the wall material where the base unit will be placed.

1 Insert two mounting screws into the wall, (with their appropriate anchoring device), 1/8 inches apart. Allow about 3/16 of an inch between the wall and screwheads for mounting the phone.

2 Set the retainer clip if necessary.

3 Refer to steps 1 through 7 on page 11 to mount the telephone.

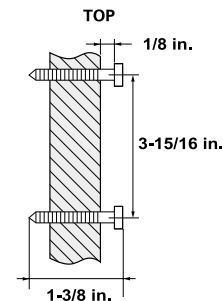

Setting Caller ID Options/Language

There are three Caller ID setup options available: AutoTalk, CIDCW (Caller ID on Call Waiting), and Area Code. (See page 14 for Area Code setup instructions.)

AutoTalk™ allows you to answer the phone without pressing the **(talk)** button. If the phone rings when AutoTalk is on, simply remove the handset from the base and the phone automatically answers the call. Or if the handset is not on the base, press any key to answer the call. If the phone rings when AutoTalk is off, you must press **(talk)** to answer the call.

Caller ID on Call Waiting (CIDCW) performs the same as regular Caller ID on a call waiting number. Call waiting options allow you to handle call waiting calls in six different ways. (See page 36.)

You must subscribe to CIDCW from your local phone company in order to use this feature. The Call Waiting options are a separate service available through your phone company.

Language option can be used to choose the language of your display. You can select either English or French.

To change your Caller ID options/Language:

- 1 Press **(options)** in the standby mode.

The following screen appears.

```
1#Auto Talk:Off
2 CIDCW      :On
3 Area Code:
```

- 2 Use **(▲)** and **(▼)** or a number key (1-3) to move the pointer to the selection that you would like to change. Press **(select/channel)** to toggle between "On" and "Off" for "Auto Talk". For "CIDCW", choose "On", "Off", or "Off" depending upon the type of service to which you subscribe.

- 3 To set up the language of your display, press **(▼)** or the number key **(4)** to move the pointer to "Language".

Press **(select/channel)** to select "Eng" (English) or "Fr." (French).

```
2 CIDCW      :On
3 Area Code:
4#Language :Eng
```

- 4 After you have made your Caller ID selections, press **(options)** and return the handset to the base.



If your calling area requires 10-digit dialing, do not program this option.

Entering Your Area Code

If you enter a 3-digit area code number in the Area Code option, your local area code does not appear in Caller ID messages. Do not program this option, if your calling area requires 10-digit dialing.

When reviewing Caller ID messages, you will see only the local seven digit number. For calls received from outside your local area code, you will see a full 10-digit number.

- 1 When the phone is in the standby mode, press **(options)** .
The Caller ID setting screen appears.

```
1 Auto Talk:Off
2 CIDCW      :On
3 Area Code:
```

- 2 Press **(3)** to select "Area Code" or press **(v)** .

```
1 Auto Talk:Off
2 CIDCW      :On
3 Area Code:
```

- 3 Press **(select/channel)** .

```
1 Auto Talk:Off
2 CIDCW      :On
3 Area Code:
```

- 4 Use the number keypad (**(0)** to **(9)**) to enter the 3-digit area code.

- 5 Press **(select/channel)** . A tone sounds and the displayed area code is entered.

- 6 Press **(options)** to complete the setting or return the handset to the base. The handset returns to the standby mode.



When the area code has already been stored in memory, the stored area code will be displayed. To change it, use the **(delete)** and number keypad to enter the new area code. Then press **(select/channel)** .

To complete the setting, press **(options)** or return the handset to the base unit.

```
1 Auto Talk:Off
2 CIDCW      :On
3 Area Code:817
```

Making and Receiving Calls

From the handset

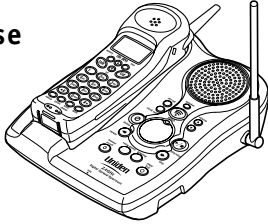
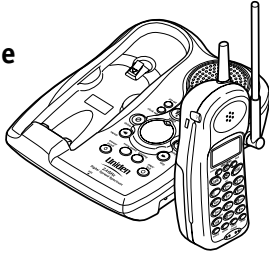
	Handset On the Base 	Handset Off the Base 
To answer a call	Pick up the handset (AutoTalk) or pick up the handset and press talk .	Press any key (Any Key Answer).
To make a call	1) Pick up the handset. 2) Press talk . 3) Listen for the dial tone. 4) Dial the number. OR 1) Pick up the handset. 2) Dial the number, then press talk .	1) Press talk . 2) Listen for the dial tone. 3) Dial the number. OR Dial the number, then press talk .
To hang up	Press talk , or return the handset to the base (AutoStandby).	Press talk .



Refer to page 13 "Setting Caller ID Options/ Language" to turn on Auto Talk feature if desired.



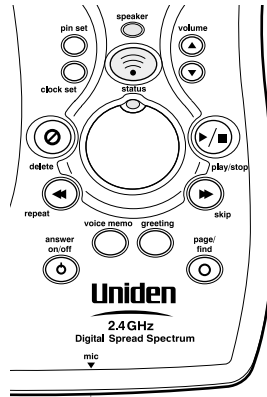

The base microphone is located under the base. Position yourself as near to the base as possible and speak clearly.

From the base (Receiving Calls only)





Microphone

- 1 The phone rings. The **status** LED on the base flashes.
- 2 Press  and begin speaking. The **speaker** LED lights.
- 3 To hang up, press .

Terminology

Throughout this manual, terms such as Standby and Talk Mode are used. Below is the terminology explanation.

- **Standby Mode** -The handset is not in use, off the base, and  has not been pressed. A dial tone is not present and the display is blank.
- **Talk Mode** -The handset is off the base and  has been pressed enabling a dial tone. "Talk" appears on the display.

Adjusting the Volume

Handset ringer tone and volume

Press or in standby mode to select one of four ringer tone and volume combinations.

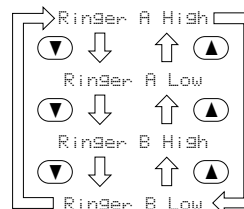

Earpiece volume

Pressing or during a call will change the earpiece volume of the handset. This setting will remain in effect after the telephone call has ended.



note When you press in Maximum mode or in Low mode, an error tone sounds.

Ringer off

During the standby mode or tone/volume setting, press and hold until the phone beeps and "Ringer Off" appears.

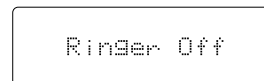

To turn the ringer back on, simply press or . "Ringer A High" appears.

Base ringer switch

This switch turns the base ringer on or off.

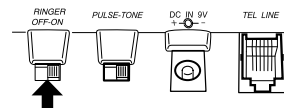

Base speaker volume

To control the speaker volume of the base, adjust the **volume** and as desired.

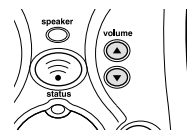



- If the number exceeds 32 digits, only the first 32 digits are retained for redialing.
- Press and hold **(delete)** to delete the displayed redial number.
- Refer to terminology explanation on page 16, if necessary.

Redialing a Call

The last three phone numbers dialed can be quickly redialed.

Redialing from Standby Mode

From the Handset

- 1 Press **(redial/p)**.

The phone number that was last dialed appears on the display.

- 2 Press **(redial/p)** again.

Each press of **(redial/p)** will display one of the last three numbers dialed.

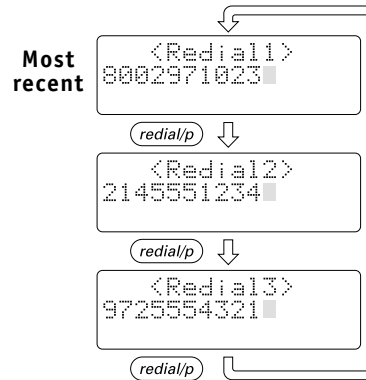

- 3 Press **(talk)**. "Talk" appears on the display, then the volume setting is displayed.
- 4 The selected number is dialed. After about 5 seconds, the call-time display appears.
- 5 To hang up, press **(talk)** or place the handset on the base. The call-time will be displayed for about 5 seconds.

Redial from Talk Mode

- 1 Press **(talk)**.
"Talk" and the volume setting appears on the display.

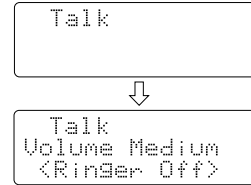

- note** If you set the ringer to off, "<Ringer Off>" appears on the display.

- 2 Press **(redial/p)**.
The last number dialed will be displayed and redialed.

- 3 To hang up, press **(talk)** or place the handset on the base. The call-time will be displayed for about 5 seconds.

Tone Dialing Switch-over

Some telephone companies use equipment that require pulse dialing (sometimes referred to as rotary dialing). If you need to enter tone dialing digits, you can switch-over to tone dialing during the call. An example of this could be entering your bank account number after you have called your bank. The digits of your bank account can be sent using DTMF tones. Initially make your call with the pulse dialing mode. Once your call connects, press **(*/tone)**. Enter the desired number (like in the example above, the bank account number). These digits will be sent as tone dialing. This special number can be stored in a memory location. This is referred to as Chain Dialing (See page 27). Once the call ends, the tone mode is canceled and pulse dialing mode resumes.

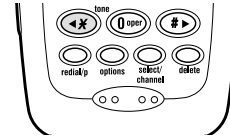

- Only the last number dialed can be accessed after **(talk)** has been pressed.

- The tone feature only applies when the dial mode is set to pulse.

Traveling Out-of-Range

During a call, as you begin to move your handset too far from your base unit, noise increases. If you pass the range limits of the base unit, your call will terminate within 30 seconds.

Selecting a Different Channel

If you encounter interference while using your phone, you can manually change the phone's channel for clear operation. Interference can come from appliances or other phones in your home. This function works only when the phone is in use.

During the course of a conversation, if you hear static or noise which makes it difficult to hear, press **(select/channel)**. "Scanning" appears on the display, indicating the phone is changing to another channel. For more information on interference, refer to "Technical Information" on page 53.



When an incoming call is received during paging, paging is canceled and the telephone is switched to the incoming call.

Page

To locate the handset

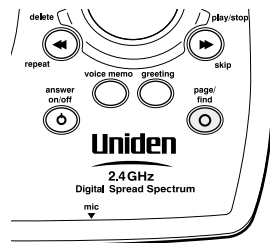

- 1 Press **(power)** on the base.
- 2 The handset beeps for 60 seconds. The following screen appears:

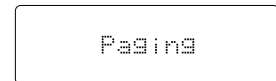



- 3 Press any key on the handset or **(power)** on the base, or return the handset to the base to end the page.

3-way Conferencing

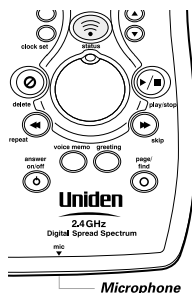

The Uniden TRU548 permits 3-way conversations between the handset, base, and on outside lines.



When speaking on the base

- 1 Press  on the base to join the 3-way conversation.
- 2 To hang up, press  on the base. The handset will still be connected to the call.

When speaking on the handset

- 1 Press  on the handset to join the 3-way conversation.
- 2 To hang up, return the handset to the base, or press  on the handset. The base will still be connected to the call.

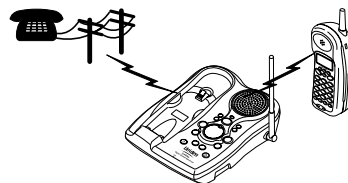



note

- You must subscribe through your local telephone company to receive Call Waiting Service.
- You must set the CIDCW to “on” in the Caller ID set up options (see page 13).

note

Pressing the  key on the base while dialing with the handset will set the 3-way conversation mode, and dialing is not affected.

Flash and Call Waiting

If you have “Call Waiting” service and a call waiting tone sounds while you are on a call, press  to accept the waiting call. There is a short pause, then you will hear the new caller. To return to the original caller, press  again.

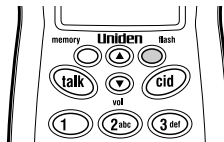



- In memory dialing operation, you must press a key within 20 seconds or the phone will return to standby. If you return the handset to the base, the phone will return to standby also.
- You have 20 seconds after pressing **memory** to enter the number you wish to store. Otherwise, an error tone sounds.

Storing Phone Numbers and Names

Memory Dialing allows you to dial a number using just a few key presses. Your TRU548 stores up to 20 names/numbers in the handset.

With the Handset

1 Press and hold **memory** until "Memory Store" is displayed.

```
Memory Store
01
02
```

2 Press **▲** and **▼** or enter a two-digit number (01 - 20) to select the memory location where you would like to store the number.

3 Press **select/channel**. The following screen appears and a cursor flashes indicating that the display is ready for the name to be entered.

```
Store Name
█
```

If this screen appears, the selected memory location is already stored. Then you must either change the entry in this location, clear the entry in this location, or select "Go Back" to choose another location.

```
Edit Memory07
Delete Memory07
Go Back
```

4 Use number keys, **#>**, ***/</tone**, or **delete** to enter the name. The name cannot exceed 13 characters.

- See the "Steps for entering names and special characters" (See pages 24-25).
- Use **#>** and ***/</tone** to move the cursor to the desired location.
- Use **delete** to delete characters as needed.
- Press and hold **delete** to delete all the characters.
- If a name is not required, go to step 5.

- 5 Press **(select/channel)**. "Store Number" is displayed. The cursor flashes indicating that the display is ready for the number to be entered.
- 6 Use the number keypad to enter the phone number. The phone number cannot exceed 20 digits.
 - Use **(redial/p)** to enter pause in the dialing sequence. The display shows a "P". Each pause counts as one digit and represents a two second delay of time between the digits.
 - Use **(delete)** to delete digits as needed.
- 7 Press **(select/channel)**. The handset beeps and displays the confirmation screen. Memory storage is complete. For example, if you store a name and number into memory location number 07, the display shows "Memory07 Stored". After about 2 seconds, "Memory Store" is displayed.
- 8 Press **(memory)** to return to standby mode.

```
Store Number
█
```

```
Store Number
8002971023█
```

```
Memory07 Stored
```

```
Memory Store
07▶UNIDEN CORP
08
```



- The pause feature is useful for long distance calling, credit card dialing, or sequences that require a pause between digits.
- The pause key counts as one digit. Pressing **(redial/p)** more than once increases the length of pause between numbers.
- The 20 memory locations are represented by the numbers 01-20 on the keys. If you store a number in one of locations, then attempt to store a different number in the same location later, the new number will overwrite the previous one.

Steps for Entering Names and Special Characters

Refer to the letters on the number keys to select the desired characters. With each press of a numeric key, the displayed character appears in the following order: Upper case letters first, lower case letters next and finally the number corresponding to the key.

	Number of times key is pressed								
keys	1	2	3	4	5	6	7	8	9
1	1								
2abc	A	B	C	a	b	c	2		
3def	D	E	F	d	e	f	3		
4ghi	G	H	I	g	h	i	4		
5jkl	J	K	L	j	k	l	5		
6mno	M	N	O	m	n	o	6		
7pqrs	P	Q	R	S	P	q	r	s	7
8tuv	T	U	V	t	u	v	8		
9wxyz	W	X	Y	Z	w	x	y	z	9
0oper	*	#	-	&	()	(blank)	0	

If you make a mistake while entering a name

Use ***/←/tone** or **#▶** to move the cursor to the incorrect character. Press **delete** to erase the wrong character, then enter the correct character. To delete all characters, press and hold **delete**.

For example, to enter **Uniden**:

- 1 Pick up the handset and press and hold **(memory)** .
- 2 Enter a number or press **(▲)** , **(▼)** to select a memory location number.
- 3 Press **(select/channel)** .
- 4 Press **(8)** twice.
- 5 Press **(6)** five times.
- 6 Press **(4)** six times.
- 7 Press **(3)** four times, then press **(#▶)** to move the cursor to the right.

note If the next character uses the same number key, you must press **(#▶)** to move the cursor over. Otherwise the next time you press the number key, it changes the character that was previously set.

- 8 Press **(3)** five times.
- 9 Press **(6)** five times.
- 10 When finished, Press **(select/channel)** .

To continue to store the telephone number, proceed to step 6 on page 23.



- If you press **(select/channel)** before **(talk)**, you can confirm the name and number stored in the selected memory location. To exit this mode, press and hold **(delete)** until the display clears.
- To exit the memory function without dialing, press **(memory)**. The handset returns to standby.
- Whenever you are using a menu screen, you must press a key within 20 seconds or the phone will return to standby.

Making Calls with Memory Dialing

Memory dialing from Standby Mode

- 1 Press **(memory)**.
The handset displays your programmed memory locations.
- 2 Press **(up)** and **(down)** or enter a two-digit number (01 - 20) to select the memory location you would like to dial.
- 3 Press **(talk)**. "Talk" and the volume setting appear on the display. Then the displayed number is dialed.

```
01 UNIDEN CORP
02 JOHN DOE
03▶MOM AND DAD
```

```
▶Talk◀
0123456789012
```

Display a Programmed Number

Use **(#▶)** and **(*/◀/tone)** to toggle between the names display and the numbers display.

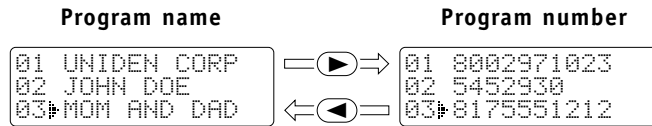

When the stored phone number has 14 or more digits, "→" is displayed next to the 12th digit. Press **(#▶)** to see the extra digits and **(*/◀/tone)** to return.

```
05 012345678901
06▶011813554329+
07
```

Memory dialing from Talk Mode

1 Press **talk**. "Talk" and the volume setting appears.

note If you set the ringer to off, "<Ringer Off>" appears on the display.

2 Press **memory**.

3 Enter a two-digit number (01 - 20) to select the memory location of the desired phone number. The selected phone number is displayed. Then the number is dialed.

4 To hang up, press **talk**.

```
>Talk<
```



```
Talk  
Volume Medium  
<Ringer Off>
```

```
Talk 0:00
```

```
Talk 0:35  
0123456789012
```



If you select a memory location that does not have a stored number, the handset will beep rapidly and the phone will not dial.

Chain Dialing

The 20 memory locations on the handset are not limited to phone numbers. You may want to store in memory a group of numbers (up to 20 digits) that you need to enter once your call connects. This is referred to as Chain Dialing. An example of this is a bank account number. Once you have called your bank, when you are prompted to enter the account number, simply press **memory** and then the location where the special number has been stored. Store your special number with identifying name in memory as you would a phone number (Refer to "Storing Phone Numbers and Names" on page 22). Enter a pause as necessary in the sequence. A pause counts as one digit and represents a two second delay in time between digits as they are sent.

Editing a Stored Name and/or Phone Number

1 Press and hold **memory** until “Memory Store” is displayed.

```
Memory Store
01▶UNIDEN CORP
02 JOHN DOE
```

2 Press **▲** and **▼** or enter a two-digit number (01 - 20) to select the memory location you would like to edit.

3 Press **select/channel**.

The following screen appears with the memory location number that you have selected in the display.

```
▶Edit Memory01
Delete Memory01
Go Back
```

4 Press **▲** or **▼** to select “Edit Memory”, then press **select/channel**. The following screen appears.

The cursor flashes indicating that the display is ready for the name to be edited. When a name has not been stored, the cursor appears at the beginning of the second line.

```
Store Name
UNIDEN CORP■
```

5 Use the number keypad, **#▶**, ***/◀/tone**, or **delete** to edit the name (See page 22).
To edit only the phone number, skip this step.

6 Press **select/channel**. The following screen appears.
The cursor flashes indicating that the display is ready for the number to be edited.

```
Store Number
8002971023■
```

7 Use the number keypad, **redial/p** or **delete** to edit the phone number. The phone number cannot exceed 20 digits (See page 23).

If you don't want to change the phone number, skip this step.

8 Press **select/channel**. The handset beeps and displays the confirmation screen. The memory storage is complete. For example, if you store a name and number into memory location number 01, the display shows "Memory01 Stored". After about 2 seconds, "Memory Store" is displayed.



Memory01 Stored

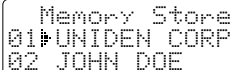

Memory Store
01 UNIDEN CORP
02 JOHN DOE

9 Press **memory** to return to standby mode.

Erasing a Stored Name and Phone Number

1 Press and hold **(memory)** until "Memory Store" is displayed.

```
Memory Store
01▶UNIDEN CORP
02 JOHN DOE
```

2 Press **(▲)** and **(▼)** or enter a two-digit number (01 - 20) to select the memory location you would like to erase.

3 Press **(select/channel)**.

The following screen appears with the memory location number that you have selected in the display.

```
▶Edit Memory02
Delete Memory02
Go Back
```

4 Press **(▼)** to move the pointer down to "Delete Memory" command line.

```
Edit Memory02
▶Delete Memory02
Go Back
```

5 Press **(select/channel)**. The following confirmation screen appears.

```
Delete Memory02?
Yes
▶No
```

6 Press **(▲)** to move the pointer to "Yes".

7 Press **(select/channel)** or **(delete)**.

There is a confirmation tone and the entry is deleted. The following screen appears.

```
Memory02 Deleted
```

8 After a few seconds the display returns to the "Memory Store" screen.

You may select another number to erase (return to step 2) or press **(memory)** to return to standby.

```
Memory Store
02▶
03 MOM AND DAD
```

Caller ID

You must subscribe to Caller ID service to use this feature.

When the telephone rings, the Caller ID feature allows you to view the caller's name and phone number on the display before you answer the phone.

The handset displays the incoming call phone number, name, time, and the number of calls. Additionally, you can dial the displayed number and store the information for memory dialing.

Make sure you have turned on the Caller ID/Call Waiting feature (See page 13).

When the Telephone Rings

- 1 When the Caller ID message is received, the display shows the caller's name and phone number. The incoming call information is stored in the Caller ID record. If the Caller ID service includes the caller's name, the caller's name appears on the display (up to 15 letters).

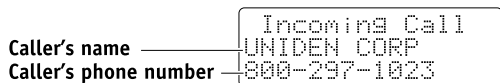

Here are some typical displays;

**When the phone number
and name data are received**

```
Incoming Call
UNIDEN CORP
800-297-1023
```

When invalid data is received

```
Incoming Call
Incomplete Data
```

When a private name is received

```
Incoming Call
Private Name
800-297-1023
```

When a private number is received

```
Incoming Call
UNIDEN CORP
Private Number
```



- If you answer a call before the Caller ID message is received (Example: before the second ring), the Caller ID message will not appear.
- When the call is received via a telephone company that does not offer Caller ID service, the caller's phone number and name do not appear. (This includes international calls.)
- When the call is via a private branch exchange (PBX), the caller's phone number and name may not appear.



- In Caller ID operation, if no key is pressed within 20 seconds, an error tone sounds and the telephone returns to the standby mode.
- If a call comes in via a telephone system that does not offer Caller ID service, no information is stored.
- Each message can be up to 15 characters for the phone number and the name.

When an unknown name is received

```
Incoming Call
Unknown Name
800-297-1023
```

When an unknown number is received

```
Incoming Call
UNIDEN CORP
Unknown Number
```



When the ringer is set off, "<Ringer Off>" appears.

2 When you pick up the phone, the display changes to "Talk". (AutoTalk feature is set to on)



Data errors appear as "■".

```
Incoming Call
UNI■EN CORP
800-2■■-1023
```

Viewing the Caller ID Message List

The Caller ID list stores information for up to 50 incoming calls - even unanswered calls.

1 Press **(cid)** in the Standby mode.
The summary screen appears.
The screen shows the number of new messages and total messages.

```
New :01
Total:02
```

2 Press **(v)** to display the latest Caller ID message.

```
5/17 12:30PM 03
UNIDEN CORP
800-297-1023
```

3 Press **(v)** to see the next message. Or press **(u)** to see previous message.

4 Press **(cid)** to return to standby.

Deleting Information from the Caller ID List

The TRU548 stores up to 50 messages. If the phone receives the 51st message, the oldest one in the list is automatically deleted. Caller ID data can also be deleted manually.

Deleting a Caller ID message

- 1 Press **(cid)**. Display the message to be deleted from the Caller ID list by pressing **(▲)** or **(▼)**.
- 2 Press **(delete)**.
- 3 Press **(▲)** or **(▼)** to select "Yes" or "No".
- 4 Press **(select/channel)** or **(delete)**.

```
5/17 12:30PM 03
UNIDEN CORP
800-297-1023
```

```
Delete Message?
▶ Yes
  No
```

When the pointer is at "Yes":

A tone sounds and the Caller ID message is deleted. The Caller ID message is then displayed.

When the pointer is at "No":

The display returns to the Caller ID message.

Deleting all Caller ID names/numbers

- 1 Press **(cid)**.
- 2 Press **(delete)**.

```
New :01
Total:02
```

```
Delete All?
  Yes
▶ No
```



- While using the "Delete All?" or "Delete Message?" screen, if no key is pressed within 20 seconds, an error tone sounds and the telephone returns to standby.
- If you get an incoming call or page, the deleting operation is canceled and the telephone returns to Standby so you can answer the call or page.



- You cannot make a call from the Caller ID list if your TRU548 is connected to a private branch exchange (PBX).
- When a long distance call has been set, “1” appears in the display.

3 Press **▲** or **▼** to select “Yes” or “No”.

4 Press **(select/channel)** or **(delete)**.

When the pointer is at “Yes”:

A tone sounds and all stored Caller ID messages are deleted.

When the pointer is at “No”:

The display returns to the summary screen.

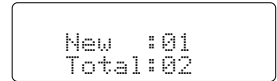

Using the Caller ID List

Calling a party from the Caller ID list

You can place a call from the Caller ID list. The TRU548 stores up to 50 messages.

1 Press **(cid)**. Select the phone number that you want to dial by pressing **▲** or **▼**.

2 Press **(talk)**. The displayed phone number dials automatically.

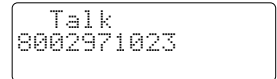
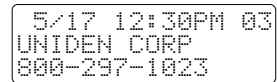

Long Distance calls and Area Code Setting/Cancellation

Pressing **①** while the incoming Caller ID information is displayed (in step 1) will place the prefix “1” in the display to set up for a long distance call.

Pressing **③** will set or cancel an area code setting.

Dial edit

You can temporarily edit the Caller ID number that is displayed by pressing **(select/channel)**. A cursor appears in the display. Press **(delete)** to move the cursor left, make your changes, and then press **(talk)**. This will not change the number in the Caller ID list memory. If you want to save this new number, store the information in memory (See page 35).

Storing Caller ID messages in Memory dialing

Messages shown in the Caller ID list can be stored in memory dialing. Using the incoming call information (i.e., Caller ID list), the phone number of the party on the Caller ID list can be stored in memory dialing.

- 1 Press **(cid)**.
Select the phone number to be stored from the Caller ID list by pressing **(▲)** or **(▼)**.
- 2 Press **(memory)**.
- 3 Press **(▲)** and **(▼)** or enter a two-digit number (01 - 20) to select the memory location to be stored.
- 4 Press **(select/channel)**.
A tone will sound. The number is stored in memory, and the display returns to the Caller ID list.

```
5/17 12:30PM 03
UNIDEN CORP
800-297-1023
```

```
Select Location
01▶UNIDEN CORP
02 JONE DOE
```

```
5/17 12:30PM 03
UNIDEN CORP
800-297-1023
```



If a message has already been stored in the selected memory number location, a confirmation screen is displayed. Press **(▲)** to select "Yes". Press **(select/channel)** to overwrite. The display returns to the Caller ID list.

```
Replace Memory?
Yes
▶No
```



- You can not store a Caller ID message if no phone number appears in the message.
- If there is an incoming call or page, memory storage is canceled and the telephone is set to receive the incoming call or page.



When CIDCW is set to "Off" in the Caller ID setup options (see page 13), you can view a list of ways to handle the new call.

Call Waiting Features

Your TRU548 gives you new options for call waiting. At the touch of a button, you can ask the caller to hold or conference them into your current call. You may be required to subscribe to call waiting and call waiting options to use these features. Not all features are available in all areas. Check with your local telephone company for details.

- 1 When you receive a call waiting call, press **(options)** for a list of options.
- 2 Press the **(▲)** or **(▼)** key or number keys to select an option.
- 3 Press **(select/channel)**.
A confirmation screen will appear.

```
1▶ Ask to Hold
2 Tell Busy
3 Answer/Drop 1
```

```
4▶ Conference
5 Drop First
6 Drop Last
```

Your TRU548 is pre-programmed with six call waiting options. You may select to ask the calling party to **hold**, send them a **busy** message, or **conference** them into the current call. You may also select to **answer and drop** the first caller or, at any time, choose to **drop the first** or **drop the last caller**.

Check with your local telephone company for a full list of options.

The Integrated Answering Device

The TRU548 has a built-in answering system that answers and records incoming calls. You can also use your answering system to record a conversation, leave a voice memo message for others who use the phone, or to announce a special message to callers when you're away from your phone.

Features

- Digital Tapeless Recording
- 15 Minutes of Recording Time
- Selective Greetings (Outgoing Messages)
- Message Received Time and Day Announcement
- Remote Message Retrieval and Room Monitor
- Toll Saver
- Conversation Recording

Digital Tapeless Recording allows you to quickly review, save or delete the messages. You'll never have to worry about a tape wearing out, jamming, or resetting improperly.

The Integrated Answering System is easy and convenient to use, but please read through all of the instructions carefully.

Turning the answering system on/off

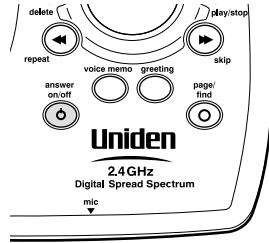

- 1 To turn the answering system on, press . The current greeting message will be played and you will hear a tone. The message counter displays the number of messages stored in memory. If the display flashes, then there are new messages waiting for you.
- 2 To turn the answering system off, press again. After the announcement "Answer Off" the message counter display goes out.



When the answering system is full, *FL* displays on the base and the system announces "No remaining time". You should delete some messages so that the system can record new messages.





- Press and hold or to quickly scroll through numbers on the display.
- If you don't complete the clock setting within two minutes, the system returns to standby.
- You must press a key within 2 minutes or the phone returns to standby.

Setting Up Your Answering System

Setting the clock

The clock on TRU548 answering system starts when power is supplied to the base. Follow these steps to set the clock to the correct time.

- 1 Press and hold until a tone sounds.
- 2 Press or repeatedly until the correct day of the week is announced. (Number *0* through *6* displays on the base as each day is announced.) Press again to select the day.
- 3 Press or repeatedly until you hear the correct hour setting. Numbers *1* through *12* display on the base as each hour is announced. Press again to select the correct hour.
- 4 Press or repeatedly until you hear the correct minute setting. Numbers *0* through *59* display on the base as each minute is announced. Press again to select the correct minute.

- 5 The LED displays *A* or *P*. Press  or  until you hear the correct AM/PM setting.
- 6 Press *clock set* again to end the time/day setting. The TRU548 announces the day and time that you have set.

Setting your greeting

When you receive a call, the answering system automatically plays either a prerecorded message or your own greeting.

▼ Preset Message

The following message is prerecorded:

“Hello, no one is available to take your call. Please leave a message after the tone.”

▼ Recording a personal outgoing message (Greeting)

- 1) Press and hold *greeting* until you hear a tone. Start recording your message immediately after you hear the tone end.
- 2) When you finish recording your message, press *greeting* or . A tone sounds and your message plays back on the phone.



▼ Choosing between the two outgoing messages

- 1) Press *greeting* to play the outgoing message.
- 2) Press *greeting* again while the message is playing. This switches between the two options.



- You can record a greeting up to 30 seconds.
- Position yourself as near to the base as possible and speak clearly when recording your outgoing message.



Press and hold  or  to quickly scroll through numbers on the display.

Selecting the message record time

You can set your answering system to record messages up to one or four minutes long.

One minute option: move the **REC TIME** switch to **1**.
Four minute option: move the **REC TIME** switch to **4**.

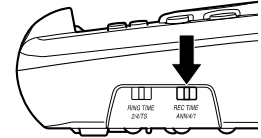

▼ Announce only feature:

The announce only feature plays an outgoing message, but it will not allow the caller to leave a message. Move the **REC TIME** switch to the **ANN** position.









The message counter LED displays “**R**” when the system is on standby.

Prerecorded outgoing message for Announce only feature is:

For example: “Hello, no one is available to take your call.” (twice)

Selecting a PIN code

To play your messages from a remote location, you will need to enter a two-digit Personal Identification Number (PIN) code (00-99). To select a PIN, perform the following steps.

- 1 On the base, press and hold  until a tone sounds and the LED displays .
- 2 To set the first number, press  or  repeatedly to scroll from 0 to 9. When the desired number appears in the display, press .
- 3 To set the second number, press  or  to scroll from 0 to 9. When the desired number appears in the display, press . Then the entered PIN code is announced.

Setting ring time switch

The ring time/toll saver switch allows you to set the number of rings the caller hears before the answering system plays the outgoing message. You can set the switch to answer after two rings or after four rings.

Once the greeting has started, you can stop it when you pick up the call at the handset or base.

In the **TS** (Toll Saver) position, the answering system picks up after two rings if you have new messages, and after four rings if there are none. This way, if you make a long distance call to check your messages, you can hang up after the second ring to avoid billing charges.

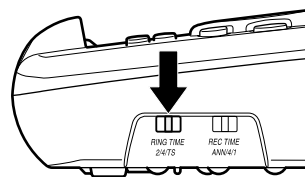

If you answer at another phone extension and the greeting has started, you cannot stop the message. Wait until your greeting is complete before starting your conversation.





- To stop playing your messages, press  again.
- If you have several messages, press and hold  until you return to the message you want to replay.





Using Your Answering System

Playing your messages



The base LED display shows the number of total messages. If the display is blinking, then there are new messages waiting for you. The TRU548 is designed to play your new messages first. After you play your new messages you can then play your old messages.

- 1 Press . The system announces the number of new and old messages, then the incoming messages are played. The time and day each message was received is announced after the message is played.
- 2 When all new messages have played, a tone is heard. The message counter LED stops flashing to indicate that all of the new messages have been reviewed.
- 3 After you have reviewed all your new messages, you can play your old messages. Press  and follow the instructions above.

Repeating a message



- 1 Press  to review your message. The number of stored messages is announced.
- 2 After a message has played for more than two seconds, (four seconds for remote access) press  to repeat the message. If you press  before two seconds (four seconds for remote access) the system repeats the previous message.
- 3 Press  at any time to stop reviewing messages and return to standby.

Skipping a message

- 1 Press  to review your messages. The number of messages is announced.
- 2 Press  at anytime to skip to the next message.
- 3 Press  at any time to stop reviewing your messages and return to standby.

Deleting a message



▼ Deleting an individual message

- 1 Press  to review your message.
- 2 If you decide to delete a message, press  anytime during the message. The system beeps and immediately goes to the next message.

▼ Deleting all messages

Press and hold  while the system is in standby. A tone sounds when all messages are deleted. If there are any messages you have not reviewed, you can not delete all messages at once. An error tone occurs.



- Each time  is pressed, the system scans forward one message.
- If you have several messages, press and hold  to find the message you want to play.
- When you press , you are permanently deleting the message. The message cannot be replayed.



- The voice memo function is completely independent of the outgoing message. It's handy for leaving others a quick message.
- A voice memo message will be stored as a typical recorded message.
- Position yourself as near to the base as possible and speak clearly.
- A recorded conversation is stored and played back with typical recorded messages.

Voice memo

The voice memo function allows the user to record a message (up to 10 minutes) on the base.

- 1 Press and hold **voice memo** until you hear a tone. The message counter LED blinks.
- 2 Speak into the microphone.
- 3 When you have finished, press **voice memo** or **▶/■** to stop recording. The system returns to standby.
- 4 To play voice memo, press **▶/■**.

Recording a conversation

You can record up to 10 minutes of conversation while you are making your call from the handset.

- 1 During the conversation from the handset, press and hold **voice memo** on the base. The unit begins recording and the LED blinks. Both parties can hear tones every 15 seconds.
- 2 To stop the recording, press **voice memo**, **▶/■** or **talk**, or return the handset to the base.



You cannot record a conversation while you are speaking on the base.

Remote access away from home

You can operate your answering system from a remote location using any touch-tone telephone. Use this function to check for recorded messages, to play or delete messages, to record a new outgoing message, and to monitor sounds in the room.

- 1 Call your telephone number.
- 2 While the greeting message is played, press # and your PIN code within 2 seconds.
If the answering system is off, let it ring 10 times. The tone sounds. Then, press # and your PIN code within 2 seconds.
- 3 The answering system announces the time and day and the number of messages stored in memory. Then the message playback automatically begins.
- 4 You may continue to listen to your message, or you may select a command from the following chart.

Command	Function
# then 1	Repeat a message
# then 2	Playing your messages
# then 3	Skipping a message
# then 4	Deleting a message
# then 5	Stop message playback
# then 6	Answering system on
# then 7	Voice memo record/stop (up to 4 minutes recording time)
# then 8	Greeting message record/stop
# then 9	Answer system off
# then *	Room monitor

- 5 After all of your messages have played, or the playback time exceeds 4 minutes, you will hear intermittent beeps indicating that the system is in the command waiting mode. You may enter another command at this time from the chart above.



- During the remote operation,  displays on the base.
- You must enter a command within 15 seconds of entering command waiting mode. Otherwise the answering system automatically hangs up and returns to standby.
- The system will only playback messages for four minutes and then it returns to command waiting mode. To continue playing your message, press # then 2 again within 15 seconds.



If you enter an incorrect PIN code three times, an error tone sounds and the phone automatically hangs up.

- 6 When you finish, hang up to exit the system.
The answering system automatically returns to standby.

Remote room monitor

You can call your answering system from any touch-tone phone and monitor sounds in the room where your base is installed.

- 1 Call your telephone number.
- 2 While the greeting message is playing, press # and your PIN code.
- 3 The answering system begins announcing the time and day.
- 4 Press # then 5 to stop the messages.
- 5 Press # then *. You hear sounds in the room where your phone is installed. After 15 seconds, the answering system returns to the command waiting mode.
- 6 Press # then * to monitor the room for another 15 seconds. Or select another remote function. Or hang up to exit the system. The answering system automatically returns to standby.

Turn on the answering machine remotely

If you have forgotten to turn on your answering machine, you can turn it on remotely from any touch-tone telephone.



- 1 Call your telephone number.
- 2 Wait ten rings until the machine answers.
- 3 Press # and enter your PIN code within 2 seconds. The answering system begins to announce the time and day.
- 4 Press # then 6 to turn the answering system on.
- 5 Hang up the phone and subsequent calls will be answered by the machine.

Changing the Digital Security Code

The digital security code is an identification code used to connect the handset and the base unit. Normally, setting the code is not necessary. The first time you charge your handset, the security code is automatically set (See page 4).

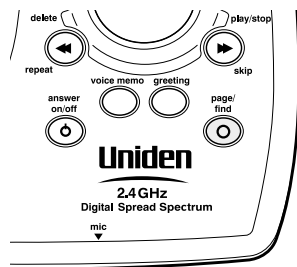
In the rare situation that you suspect another cordless telephone is using the same security code, you can change the code.



- 1 Remove the handset from the base unit. Press and hold  on the base.
- 2 While the handset is emitting the paging sound, replace the handset to the base unit. Release the . The paging tone stops. Leave the handset on the base for more than 3 seconds. A random, new security code is set.



If the handset battery pack is completely discharged or the battery pack is removed, the digital security code will be lost. If this happens, a new security code is set automatically next time the battery pack is charged.

Installing the Beltclip

To attach the beltclip

Insert the beltclip into the holes on each side of the handset. Press down until it clicks.

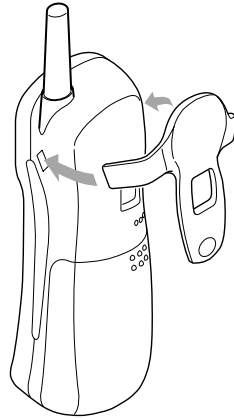

To remove the beltclip

Pull both sides of the beltclip to release the tabs from the holes.

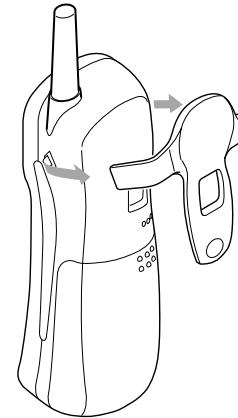

Headset Installation

Your phone may be used with an optional headset, the Uniden HS910. To use this feature, insert headset plug into the headset jack. Your phone is ready for hands-free conversations.

(Headset may be purchased by calling the Uniden Parts Department or visiting the website. See Page 5.)

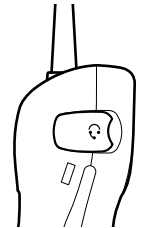

Note on Power Sources

Battery replacement and handling

When the operating time becomes short, even after a battery is recharged, please replace the battery.

With normal usage, your battery should last about one year.

Please contact your place of purchase or the Uniden Parts Department for a replacement battery.

Power Failure

During the period that the power is off, you will not be able to make or receive calls with the telephone.

Caution

- Use the specified battery pack.
- Do not remove the battery from the handset to charge it.
- Never throw the battery into a fire, disassemble it, or heat it.
- Do not remove or damage the battery casing.

RECYCLING NICKEL-CADMIUM BATTERIES



Nickel-cadmium cells are used in the battery pack. Please take your used nickel-cadmium battery packs to a store that recycles nickel-cadmium batteries.

Maintenance

When slightly dirty

Wipe with a soft, dry cloth.

When very dirty

Wipe with a soft cloth that has been dampened with diluted, neutral detergent. Dry with a dry cloth.

When the charging terminals become dirty

Wipe with a dry cloth or a pencil eraser, if necessary.

Caution

Do not use paint thinner, benzene, alcohol, or other chemical products. Doing so may discolor the surface of the telephone and damage the finish.

Troubleshooting

If your phone is not performing to your expectations, please try these simple steps first.

Symptom	Suggestion
The <i>status</i> LED won't light when the handset is placed in the base unit.	<ul style="list-style-type: none"> • Make sure the AC adapter is plugged into the base unit and wall outlet. • Make sure the handset is properly seated in the base unit. • Make sure the charging contacts on the handset and base unit are clean.
The audio sounds weak and/or scratchy.	<ul style="list-style-type: none"> • Press (<i>select/channel</i>) during a call to help eliminate background noise. • Make sure that the base unit antenna is in a vertical position. • Move the handset and/or base unit to a different location away from metal objects or appliances and try again. • Make sure that you are not too far from the base.
Can't make or receive calls.	<ul style="list-style-type: none"> • Check both ends of the base unit telephone line cord. • Make sure the AC adapter is plugged into the base unit and wall outlet. • Disconnect the AC adapter for a few minutes, then reconnect it. • Reset the digital security code (See page 47). • Make sure (<i>talk</i>) is pressed.
The handset doesn't ring or receive a page.	<ul style="list-style-type: none"> • The battery pack may be weak. Charge the battery on the base unit for 15-20 hours. • The handset may be too far away from the base unit. • Place the base unit away from appliances or metal objects. • Reset the digital security code (See page 47). • Make sure that Ringer Volume is not set to Ringer Off.
The Caller ID/CIDCW does not display.	<ul style="list-style-type: none"> • The handset was picked up before the second ring. • The call was placed through a switch board. • Call your local telephone company to verify your Caller ID service is current. • Charge the handset. • Make sure that "CIDCW" is not set to "Off".

Symptom	Suggestion
The answering system does not work.	<ul style="list-style-type: none"> • Make sure the base unit is plugged in. • Make sure that the answering system is turned on. • Make sure that the message record time is not set to ANN (See page 40).
Messages are incomplete.	<ul style="list-style-type: none"> • The incoming messages may be too long. Remind callers to leave a brief message. • The memory may be full. Delete some or all of the saved messages.
After a power failure, the outgoing message is deleted.	<ul style="list-style-type: none"> • Record your greeting again. The default message should remain.
No sound on the base unit speaker during call monitoring or message playback.	<ul style="list-style-type: none"> • Adjust the speaker volume on the base unit.
Cannot access remote call-in features from another touch-tone phone.	<ul style="list-style-type: none"> • Make sure you are using the correct PIN number. • Make sure that the touch-tone phone you're using can transmit the tone for at least two seconds. If it cannot, you may have to use another phone to access your message.
Severe noise interference.	<ul style="list-style-type: none"> • Keep the handset away from microwave ovens, computers, remote control toys, wireless microphones, alarm systems, intercoms, room monitors, fluorescent lights and electrical appliances. • Move to another location or turn off the source of interference.
If you still have a problem.	<ul style="list-style-type: none"> • Call our customer hotline at 1-800-297-1023

General Information

The TRU548 complies with FCC Parts 15 and 68.

Operating Temperature: 0°C to +50°C (+32°F to +122°F)

AC Adapter Information

AC Adapter part number: AD-313

Input Voltage: 120V AC 60Hz

Output Voltage: 9V DC 400 mA

Battery Information

Battery part number: BT-800

Capacity: 800 mAh, 3.6V

Battery Use Time (per charge)

From fully charged:

Talk Mode duration 6 hours

Standby Mode duration 10 days



If the handset is left off of the base, the actual Talk Mode duration will be reduced respective to the amount of time the handset is off the base.

Recharge your phone on a regular basis about once a week by placing the handset on the base for 15-20 hours. When the operating time becomes short, even after the battery is recharged, please replace the battery. With normal usage, the battery should last about one year.

Replacement batteries may be purchased at your local Uniden dealer or by contacting the Uniden Parts Department (800) 554-3988. Hours are from 7:00 a.m. to 5:00 p.m. Central Time, Monday through Friday.

We can also be reached on the web at www.uniden.com

Specifications, features, and availability of optional accessories are all subject to change without prior notice.

Technical Information

The FCC wants you to know!

Changes or modifications to this product not expressly approved by Uniden, or operation of this product in any way other than as detailed by the owner's manual, could void your authority to operate this product. The equipment cannot be used on public coin phone service provided by the telephone company. Connection to party line service is subject to state tariffs. (Contact the state public utility commission, public service commission or corporation commission for information.)

Below is some information that might concern you while using your new phone.

Range

Your new phone is designed to achieve the maximum possible range by transmitting and receiving according to the highest specifications set forth by the FCC. We have rated this phone to operate at a maximum distance with the qualification that the range depends upon the environment in which the telephone is used. Many factors limit range, and it would be impossible to include all the variables in our rating. The Maximum Range rating of this phone is meant to be used as a means of comparison against other range claims.

Telephone Line Problems

The FCC has granted the telephone company the right to disconnect service in the event that your phone causes problems on the telephone line. Also, the telephone company may make changes in facilities and services which may affect the operation of your unit. However, your telephone company must give adequate notice in writing prior to such actions to allow you time for making necessary arrangements to continue uninterrupted service.

If you are having trouble with your telephone service, you must first disconnect your phone to determine if it is the cause of your problem. If you determine that it is the cause, you must leave it disconnected until the trouble has been corrected.

Radio Interference

Radio interference may occasionally cause buzzing and humming in your cordless handset, or clicking noises in the base. This interference is caused by external sources such as TV, refrigerator, vacuum cleaner, fluorescent lighting, or electrical storm. Your unit is NOT DEFECTIVE. If these noises continue and are too distracting, please check around your home to see what appliances may be

causing the problem. In addition, we recommend that the base not be plugged into a circuit that also powers a major appliance because of the potential for interference. Be certain that the antenna on the unit is fully extended when needed.

In the unlikely event that you consistently hear other voices or distracting transmissions on your phone, you may be receiving radio signals from another cordless telephone or other source of interference. If you cannot eliminate this type of interference, you need to change to a different channel.

Finally, it should be noted that some cordless telephones operate at frequencies that may cause interference to nearby TVs and VCRs. To minimize or prevent such interference, the base of the cordless telephone should not be placed near or on top of a TV or VCR. If interference is experienced, moving the cordless telephone farther away from the TV or VCR will often reduce or eliminate the interference.

More Than One Cordless Telephone

If you want to use more than one cordless telephone in your home, they must operate on different channels. Press the channel key to select a channel that provides the clearest communication.

Cordless Telephone Privacy

Cordless telephones are radio devices. Communications between the handset and base of your cordless telephone are accomplished by means of radio waves which are broadcasted over the open airways. Because of the inherent physical properties of radio waves, your communications can be received by radio receiving devices other than your own cordless telephone unit. Consequently, any communications using your cordless telephone may not be private.

Precautions!

Before you read anything else, please observe the following:

Warning!

Uniden America Corporation DOES NOT represent this unit to be waterproof. To reduce the risk of fire, electrical shock, or damage to the unit, DO NOT expose this unit to rain or moisture.

Rechargeable Nickel-Cadmium Battery Warning

- This equipment contains a rechargeable nickel-cadmium battery.
- Cadmium is a chemical known to the State of California to cause cancer.
- The rechargeable nickel-cadmium battery contained in this equipment may explode if disposed of in a fire.
- Do not short-circuit the battery.
- Do not charge the rechargeable nickel-cadmium battery used in this equipment in any charger other than the one designed to charge this battery as specified in the owner's manual. Using another charger may damage the battery or cause the battery to explode.

Rechargeable Nickel-Cadmium Batteries Must Be Recycled or Disposed of Properly



- Uniden voluntarily participates in an RBRC® industry program to collect and recycle nickel-cadmium batteries at the end of their useful life, when taken out of service within the United States. The RBRC® program provides a convenient alternative to placing used nickel-cadmium batteries into the trash or municipal waste stream, which is illegal in some areas.
- Through the RBRC® program, Uniden makes it easy for you to drop off the used battery at local retailers of replacement nickel-cadmium batteries. You may also contact your local recycling center for information on where to return the used battery. Please call 1-800-8-BATTERY for information on Ni-Cd battery recycling in your area. Uniden's involvement in this program is part of its commitment to protecting our environment and conserving natural resources.
- RBRC® is a registered trademark of the Rechargeable Battery Recycling Corporation.



The exclamation point within an equilateral triangle is intended to alert the user to the presence of important operating and maintenance (servicing) instructions in the literature accompanying the appliance.

Important Safety Instructions

When using your telephone equipment, these basic safety precautions should always be followed to reduce the risk of fire, electrical shock, and injury to persons:

1. Read and understand all instructions.
2. Follow all warnings and instructions marked on the product.
3. Unplug this product from the wall outlet before cleaning. Use a dry cloth for cleaning without liquid or aerosol cleaners.
4. Do not use this product near water; for example, near a bath tub, wash bowl, kitchen sink or laundry tub, in a wet basement, or near a swimming pool.
5. Do not place this product on an unstable cart, stand, or table. The telephone may fall, causing serious damage to the unit.
6. Slots and openings in the cabinet and the back or bottom are provided for ventilation. To protect the product from overheating, these openings must not be blocked or covered. This product should never be placed near or over a radiator or heat register. This product should not be placed in a built-in installation unless proper ventilation is provided.
7. This product should be operated only from the type of power source indicated on the marking label. If you are not sure of the type of power supply to your home, consult your dealer or local power company.
8. Do not allow anything to rest on the power cord. Do not locate this product where the cord will be damaged by persons walking on it.
9. Do not overload wall outlets and extension cords, as this can result in the risk of fire or electrical shock.
10. Never push objects of any kind into this product through cabinet slots, as they may touch dangerous voltage points or short out parts that could result in a risk of fire or electric shock. Never spill liquid of any kind on the product.
11. To reduce the risk of electric shock, do not disassemble this product. Take it to qualified service personnel when service or repair work is required. Opening or removing covers may expose you to dangerous voltages or other risks. Incorrect assembly can cause electric shock when the appliance is subsequently used.
12. Unplug this product from the wall outlet and refer servicing to qualified service personnel under the following conditions:
 - A. When the power supply cord is damaged or frayed.
 - B. If liquid has been spilled into the product.
 - C. If the product has been exposed to rain or water.
 - D. If the product does not operate normally when following the operating instructions. (Adjust only those controls that are covered by the operating instructions. Improper adjustment of other controls may result in damage and will often require extensive repair work by a qualified technician.)
 - E. If the product has been dropped or the cabinet has been damaged.
 - F. If the product exhibits a distinct change in performance.
13. Do not use the telephone to report a gas leak in the vicinity of the leak.

Additional Battery Safety Precautions

Caution! To reduce the risk of fire or injury to persons by the battery, read and follow these instructions:

1. Use only the appropriate type and size battery pack specified in the owner's manual.
2. Do not dispose of the battery pack in a fire. The cell may explode. Check the nickel-cadmium battery disposal package insert for disposal instructions.
3. Do not open or mutilate the battery pack. Released electrolyte is corrosive and may cause damage to the eyes or skin. It may be toxic if swallowed.
4. Exercise care in handling the battery in order not to short the battery with conducting materials such as rings, bracelets, and keys. The battery or conductor may overheat and cause burns.
5. Charge the battery pack provided with or identified for use with this product only in accordance with the instructions and limitations specified in the owner's manual provided for this product.
6. Observe proper polarity orientation between the battery pack and battery charger.

SAVE THESE INSTRUCTIONS!

Important Electrical Considerations

Unplug all electrical appliances when you know an electrical storm is approaching. Lightning can pass through your household wiring and damage any device connected to it. This phone is no exception.

Warning!

Please do not attempt to unplug any appliance during an electrical storm.

The FCC Wants You To Know

Changes or modifications to this product not expressly approved by Uniden, or operation of this product in any way other than as detailed by the owner's manual, could void your authority to operate this product. The equipment cannot be used on public coin phone service provided by the telephone company. Connection to party line service is subject to state tariffs. (Contact the state public utility commission, public service commission or corporation commission for information.)

Range

Your new phone is designed to achieve the maximum possible range by transmitting and receiving according to the highest specifications set forth by the FCC. We have rated this phone to operate at a maximum distance with the qualification that the range depends upon the environment in which the telephone is used. Many factors limit range, and it would be impossible to include all the variables in our rating. The Maximum Range rating of this phone is meant to be used as a means of comparison against other range claims.

Telephone Line Problems

The FCC has granted the telephone company the right to disconnect service in the event that your phone causes problems on the telephone line. Also, the telephone company may make changes in facilities and services which may affect the operation of your unit. However, your telephone company must give adequate notice in writing prior to such actions to allow you time for making necessary arrangements to continue uninterrupted service. If you are having trouble with your telephone service, you must first disconnect your phone to determine if it is the cause of your problem. If you determine that it is the cause, you must leave it disconnected until the trouble has been corrected.

Radio Interference

Radio interference may occasionally cause buzzing and humming in your cordless handset, or clicking noises in the base. This interference is caused by external sources such as TV, refrigerator, vacuum cleaner, fluorescent lighting, or electrical storm. Your unit is NOT DEFECTIVE. If these noises continue and are too distracting, please check around your home to see what appliances may be causing the problem. In addition, we recommend that the base not be plugged into a circuit that also powers a major appliance because of the potential for interference. Be certain that the antenna on the unit is fully extended when needed.

In the unlikely event that you consistently hear other voices or distracting transmissions on your phone, you may be receiving radio signals from another cordless telephone or other source of interference. If you cannot eliminate this type of interference, you need to change to a different channel.

Finally, it should be noted that some cordless telephones operate at frequencies that may cause interference to nearby TVs and VCRs. To minimize or prevent such interference, the base of the cordless telephone should not be placed near or on top of a TV or VCR. If interference is experienced, moving the cordless telephone farther away from the TV or VCR will often reduce or eliminate the interference.

More Than One Cordless Telephone

If you want to use more than one cordless telephone in your home, they must operate on different channels. Press the channel key to select a channel that provides the clearest communication.

Cordless Telephone Privacy

Cordless telephones are radio devices. Communications between the handset and base of your cordless telephone are accomplished by means of radio waves which are broadcast over the open airways. Because of the inherent physical properties of radio waves, your communications can be received by radio receiving devices other than your own cordless telephone unit. Consequently, any communications using your cordless telephone may not be private.

Installation Considerations

Selecting a Location

Before choosing a location for your new phone, there are some important guidelines you should consider:

- The location should be close to both a phone jack and continuous power outlet. (A continuous power outlet is an AC outlet which does not have a switch to interrupt its power.)
- Keep the base and handset away from sources of electrical noise such as motors or fluorescent lighting.
- Be sure there is sufficient space to fully extend the base antenna.
- The base can be placed on a desk or tabletop or mounted on a standard telephone wall plate.
- You should charge your new phone for 15-20 hours before completing the installation or using the handset.

Telephone Line Outlets

There are two types of phone outlets:

Modular Jack

Most phone equipment available now uses modular jacks. Phone cords are fitted with a molded plastic connector which plugs into this type of jack. If you do not have modular phone jacks, contact your local telephone company for information about their installation.

Hardwired Jack

Some equipment is wired directly to a phone jack, and these types of installations require a modular jack converter. This type of installation is not difficult; however, you should contact your Uniden telephone dealer or a telephone supply store for advice about the proper adapter or converter for your particular situation.

Connecting the Telephone Cords

Consider these safety guidelines before connecting the telephone cords:

Caution!

- *Never install telephone wiring during a lightning storm.*
- *Never touch uninsulated telephone wires or terminals unless the telephone line has been disconnected.*
- *Use caution when installing or modifying telephone lines.*

Applying Power to the Base

This phone requires an AC outlet, without a switch to interrupt power, and the included AC adapter. To relieve strain on the DC plug when the phone is placed on a desk or table, wrap the power cord around the strain relief notch on the bottom of the base.

NOTE: Place the power cord so that it does not create a trip hazard, or where it could become chafed and create a fire or other electrical hazards.

Adapter Safety Features

If you cannot plug the AC adapter into the outlet, contact someone about replacing the outlet.

Plug the AC Adapter into a standard 120 VAC wall outlet.

Do not use an outlet controlled by a wall switch.



Use only the Uniden AC Adapter supplied with this phone.

One Year Limited Warranty

Important: Evidence of original purchase is required for warranty service.

WARRANTOR: UNIDEN AMERICA CORPORATION ("Uniden")

ELEMENTS OF WARRANTY: Uniden warrants, for one year, to the original retail owner, this Uniden Product to be free from defects in materials and craftsmanship with only the limitations or exclusions set out below.

WARRANTY DURATION: This warranty to the original user shall terminate and be of no further effect 12 months after the date of original retail sale. The warranty is invalid if the Product is (A) damaged or not maintained as reasonable or necessary, (B) modified, altered, or used as part of any conversion kits, subassemblies, or any configurations not sold by Uniden, (C) improperly installed, (D) serviced or repaired by someone other than an authorized Uniden service center for a defect or malfunction covered by this warranty, (E) used in any conjunction with equipment or parts or as part of any system not manufactured by Uniden, or (F) installed or programmed by anyone other than as detailed by the owner's manual for this product.

STATEMENT OF REMEDY: In the event that the product does not conform to this warranty at any time while this warranty is in effect, warrantor will either, at its option, repair or replace the defective unit and return it to you without charge for parts, service, or any other cost (except shipping and handling) incurred by warrantor or its representatives in connection with the performance of this warranty. Warrantor, at its option, may replace the unit with a new or refurbished unit. THE LIMITED WARRANTY SET FORTH ABOVE IS THE SOLE AND ENTIRE WARRANTY PERTAINING TO THE PRODUCT AND IS IN LIEU OF AND EXCLUDES ALL OTHER WARRANTIES OF ANY NATURE WHATSOEVER, WHETHER EXPRESS, IMPLIED OR ARISING BY OPERATION OF LAW, INCLUDING, BUT NOT LIMITED TO ANY IMPLIED WARRANTIES OF MERCHANTABILITY OR FITNESS FOR A PARTICULAR PURPOSE. THIS WARRANTY DOES NOT COVER OR PROVIDE FOR THE REIMBURSEMENT OR PAYMENT OF INCIDENTAL OR CONSEQUENTIAL DAMAGES. Some states do not allow this exclusion or limitation of incidental or consequential damages so the above limitation or exclusion may not apply to you.

LEGAL REMEDIES: This warranty gives you specific legal rights, and you may also have other rights which vary from state to state. This warranty is void outside the United States of America.

PROCEDURE FOR OBTAINING PERFORMANCE OF WARRANTY: If, after following the instructions in the owner's manual you are certain that the Product is defective, pack the Product carefully (preferably in its original packaging). The Product should include all parts and accessories originally packaged with the Product. Include evidence of original purchase and a note describing the defect that has caused you to return it. The Product should be shipped freight prepaid, by traceable means, to warrantor at:

Uniden America Corporation
Parts and Service Division
4700 Amon Carter Blvd.
Fort Worth, TX 76155

(800) 297-1023, 7 a.m. to 7 p.m. Central, Monday through Friday

Index

O - 9

3-way conferencing 21

A

Adjusting the volume 17

Answering device

 Features 37

 Setting up. 38

 Using. 42

B

Base ringer switch 17

Base speaker volume 17

Battery pack

 Preparing and charging 7

 Replacement and handling. . 49

C

Caller ID

 Caller ID service 31

 Calling 34

 Call Waiting. 36

 Deleting 33

 Features 13

 Setting 13

 Storing 35

 Using. 34

 Viewing 32

Connection 9

D

Dialing mode 10

Digital security code. 4, 47

E, F, G

Earpiece volume 17

H

Headset installation. 48

I, J, K, L

Installing the beltclip 48

M, N, O

Maintenance. 49

Making a call 15

Memory dialing

 Erasing a stored name

 and phone number. 30

 Making calls

 with memory dialing 26

 Storing phone

 numbers and names. 22

Mounting the base unit. 11

P, Q

Package contents 5

Page 20

Precautions 55

R

Receiving a call 15

Redialing a call. 18

Ringer volume. 17

S

Setting up the base unit. 9

Setting up the handset. 7

Setting up your answering system

 Selecting a PIN code 40

 Selecting the

 message record time 40

 Setting ring time switch. . . 41

 Setting the clock 38

 Setting your greeting. 39

 Turning the answering

 system on/off 38

T

Technical Information. 53

Troubleshooting 50

U, V, W, X, Y, Z

Using your answering system

 Deleting a message 43

 Playing your messages 42

 Recording a conversation . . 44

 Remote access

 away from home 45

 Remote room monitor. 46

 Repeating a message 42

 Skipping a message 43

 Voice memo. 44

Warranty 56

Memo

Memo

Memo

At Uniden, we'll take care of you!

If you need any assistance with this product, please call our Customer Hotline at

1-800-297-1023

PLEASE DO NOT RETURN THIS PRODUCT TO THE PLACE OF PURCHASE.

Our Uniden representatives will be happy to help you with any matters regarding the operation of this unit, available accessories, or any other related matters.

Thank you for purchasing a Uniden product.

Hours: M-F 7:00 AM to 7:00 PM CST.

Thank you for purchasing a Uniden Cordless Phone.

A World Without Wires | **Uniden**[®]

Covered under one or more of the following U.S. patents:

4,511,761	4,523,058	4,595,795	4,797,916	5,381,460	5,426,690
5,434,905	5,491,745	5,533,010	5,574,727	5,650,790	5,660,269
5,661,780	5,663,981	5,671,248	5,717,312	5,754,407	5,768,345
5,787,356	5,838,721	5,864,619	5,893,034	5,912,968	5,915,227
5,929,598	5,930,720	5,960,358	5,987,330	6,044,281	6,070,082
6,125,277					

© 2001 Uniden America Corporation, Fort Worth, TX
All rights reserved.

Printed in China
UCZZ01758ZZ

Free Manuals Download Website

<http://myh66.com>

<http://usermanuals.us>

<http://www.somanuals.com>

<http://www.4manuals.cc>

<http://www.manual-lib.com>

<http://www.404manual.com>

<http://www.luxmanual.com>

<http://aubethermostatmanual.com>

Golf course search by state

<http://golfingnear.com>

Email search by domain

<http://emailbydomain.com>

Auto manuals search

<http://auto.somanuals.com>

TV manuals search

<http://tv.somanuals.com>