

Uniden® | A World Without Wires®

UNIDEN
CORDLESS
PHONES



TRU9485

OWNER'S MANUAL

Contents

Welcome	4
Accessibility	4
Terminology used in this Manual	5
Product Overview	6
TRU9485 Features:	6
Answering Machine Features:	6
TRU9485 - Parts of the Phone	7
Using the Interface	9
Reading the Handset Display	9
Reading the Base Display	10
Using the Four-way Function Key.....	12
Using the Handset and Base Menus	12
Entering Text from your Phone	13
Installing the Phone	14
Choosing the Best Location	14
Wall Mounting the Base	15
Direct Wall Mounting.....	16
Installing the Rechargeable Battery.....	17
Connecting the Base and Charging the Handset .	18
Installing the Belt Clip	19
Connecting to the Phone Line	19
Testing the connection	19
Changing the Dial Mode	20

Basic Setup	21
Selecting a Language	21
Setting the Date and Time	21
Activating Caller ID on Call Waiting and Call Waiting Deluxe.....	22
Activating Personal Ring (Handset only)	22
Activating the Key Touch Tone.....	23
Adjusting the LCD contrast.....	23
Adding Accessory Handsets	24
Compatible Handsets	24
Charge the Accessory Handset	24
Registering TCX905 Accessory or Extra Handsets	25
Registering Other Compatible Handsets	25
Resetting the Handsets	26
Base Unavailable (Handset Only).....	26
Setting up the Phonebook	27
Creating Phonebook Entries.....	27
Finding a Phonebook Entry	28
Editing Phonebook Entries	29
Storing Caller ID or Redial Numbers in the Phonebook.....	29
Erasing Phonebook Entries	30
Deleting All Phonebook Entries	30
Copying Phonebook Entries to another Station.....	30

Customizing Your Phone	32	Finding a Lost Handset	42
Changing the Handset Banner	32	Using Hold, Conference and Transfer	42
Selecting a Ring Tone (Handset only).....	33	Placing a Call on Hold	42
Activating AutoTalk (Handset only)	34	Conferencing	42
Activating Any Key Answer (Handset only).....	34	Transferring a Call	43
Using your Phone	35	Answering a Transferred Call	43
Making a call from the Phonebook	36	Using Special Features	44
Making a call with Speed Dial	36	Do Not Disturb (All Calls).....	44
Switching to the Handset Speakerphone		Muting the Ringer (One Call Only).....	44
during a Call.....	36	Muting the Microphone	44
Using Caller ID, Call Waiting and Redial Lists	37	Privacy Mode	44
Using the Caller ID List	37	Using the DirectLink Feature	45
Making a call from a Caller ID Record	38	Intercom	46
Deleting Caller ID Numbers	38	Room/Baby Monitor	47
Using Call Waiting and Call Waiting Deluxe	39	Tone Dialing Switch Over.....	48
Redialing a Number	40	Installing the Optional Headset.....	49
Deleting a Redial Record.....	40	Seven-Digit Dialing	49
Adjusting the Ringer, Earpiece and		Inuse Line Setup (Base only).....	49
Speaker Volume	41	Setting Up the Answering Machine	50
Adjusting the Ringer Volume	41	Features.....	50
Adjusting the Speaker Volume	41	Using the Answering Machine Interface	51
T-coil (Handset only).....	41	Selecting the Language	52
		Your Greeting.....	52
		Setting the Number of Rings.....	55

Setting the Record Time (or Announce Only)	55	Common Issues.....	71
Activating the Message Alert	56	Liquid Damage	74
Activating Call Screening.....	56	Precautions!	75
Setting a Security Code or Personal Identification Number (PIN).....	56	Rechargeable Nickel-Metal-Hydride Battery Warning	75
Using the Answering Machine	57	The FCC Wants You To Know	77
Turning your Answering Machine On and Off	57	I.C. Notice	78
Reviewing Messages.....	58	One Year Limited Warranty.....	79
Screening Calls.....	60	Index.....	80
Recording a Conversation	61	Remote Operation Card	82
Recording a Voice Memo.....	62		
Message Alert	63		
Remotely Operating Your Answering Machine.....	64		
Maintenance.....	66		
Specifications.....	66		
Battery Replacement and Handling	67		
Cleaning the Battery Contacts	67		
Low Battery Alert	68		
Talk and Standby Times.....	68		
Troubleshooting	69		
Resetting the Handset	69		
Resetting the Handset without the Base.....	70		
Changing the Digital Security Code.....	70		
Traveling Out of Range.....	70		

Welcome

Thank you for purchasing a Uniden Multi-Handset phone.

Note: Illustrations in this manual are used for explanation purposes. Some illustrations in this manual may differ from the actual unit.

As an Energy Star®; Partner, Uniden has determined that this product or product models meets the Energy Star®; guidelines for energy efficiency. Energy Star®; is a U.S. registered mark.

Uniden; is a registered trademark of Uniden America Corporation. AutoStandby, DirectLink, IntegriSound and Random Code are trademarks of Uniden America.



Accessibility

Uniden provides a customer service hotline for accessibility questions. If you have a disability and need customer service assistance or if you have any questions about how Uniden's products can accommodate persons with disabilities, please call the accessibility voice/TTY line: 1-800-874-9314.

A representative is available to talk to you M-F, 8:00 am to 5:00 pm, CST. After hours, you can leave us a message, and we will call you back. Information is also available on our website, www.uniden.com, under the "Accessibility" link.

Terminology used in this Manual

Standby	The handset and the base are not in use. If the handset is on the cradle or [[/flash] or [⏏] on the handset or [⏏] on the base is not pressed, no line has been activated. No dial tone is present.
CID	Caller ID is available from your Telephone provider and is offered to users on a subscription basis. With this service and a display on your cordless phone, you will be able to see the incoming caller information such as name and phone number.
CID Deluxe or Call Waiting Deluxe	Caller ID with Call Waiting Deluxe features are offered by your Telephone provider with a monthly service subscription. With this service and while on an existing phone call, you can use additional menu options when a new caller rings you. By selecting Menu Options, you will be able to see a complete list of additional features that are available to you. Please see page 39 for details.
CID/CW or CIDCW	Caller ID with Call Waiting is available by subscription from your Telephone provider. With this service, you will be able to view incoming caller information while on a call with another user. This will allow you the ability to select to talk to this user and put your existing party on hold or make the decision to ring them back.
DirectLink	If you have accessory handsets on your system, you can use two handsets as 2-way radios.
Accessory or Extra Handsets	This phone system is expandable and will support a total of ten (10) handsets to one base. The accessory, or extra handset, is a handset that is compatible with this model.
Global settings	Apply to registered handsets and the base. If you change something under the global menu, you change it for all handsets and the base. Only one handset or the base can change global settings at a time, and you have to make sure the phone is not currently being used.
Station	Any handset or the base.
Talk	A telephone line has been activated on the handset or base, enabling a dial tone.

Product Overview

TRU9485 Features:

- 5.8GHz DSS Expandable System
- Expands up to 10 Handsets
- Integrated Digital Answering Machine
- Caller ID/Call Waiting Deluxe
- Base Keypad
- Advanced Phonebook Features:
 - Store Up to 100 Names for each station
 - Store Up to 2 Numbers per Name (200 #'s Total)
 - Alphabetical Search
 - Personalized Ring by Party
 - Transfer Single Listing or Entire Phonebook
- DirectLink™
- Room/Baby Monitoring
- Speakerphones on Base & Handset
- 20 Ringer Options on Handset (10 Tones/10 Melodies)
- 10 Speed Dial Numbers
- Last 3 Number Redial
- Trilingual Menu Displays (English, Spanish and French)
- Call Transfer
- Conferencing
- Intercom

Answering Machine Features:

- Digital Tapeless Recording
- Up to 12 Minutes of Recording Time
- Call Screening
- Personal or Pre-recorded Outgoing Messages
- Trilingual Voice Prompts for Menu Setup (English, Spanish and French)
- Day and Time Announcement
- Remote Message Retrieval
- Toll Saver
- Conversation Recording
- Voice Memo
- Message Alert
- Records Up to 59 messages

TRU9485 - Parts of the Phone

The following illustrations show you all of the different parts of your phone.

Handset

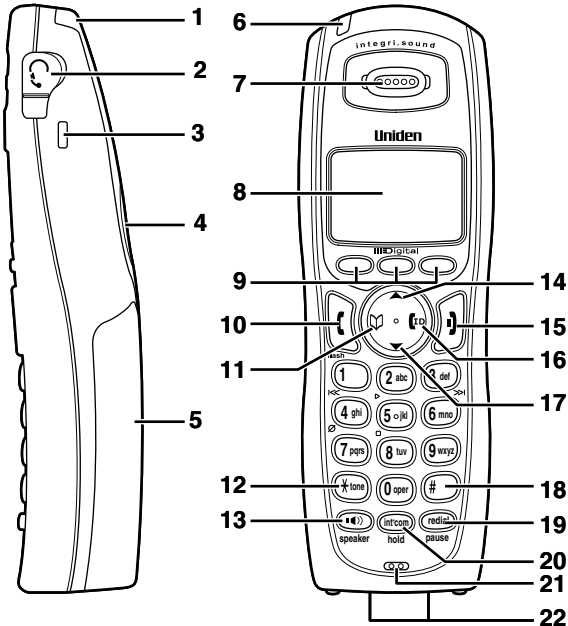

1. Handset Antenna
2. Headset Jack Cover
3. Beltclip Hole
4. Speakerphone Speaker and Ringer
5. Handset Battery Compartment
6. New Message LED
7. Handset Earpiece
8. LCD Display
9. Soft keys
10. **[[/flash]** (talk/flash) key
11. **[v]** (phonebook) key
12. **[*tone]** key
13. **[speaker]** (speaker) key
14. **[▲]** (up) key
15. **[end]** (end call) key
16. **[id]** (caller ID) key
17. **[▼]** (down) key
18. **[#]** key
19. **[redial/pause]** key
20. **[int'com/hold]** (intercom/hold) key
21. Handset Microphone
22. Handset Charging Contacts

Parts of the Answering Machine Base

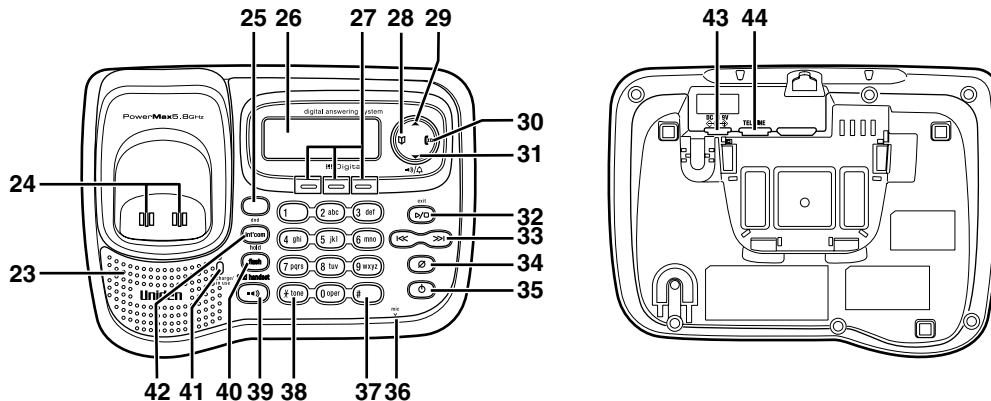









- 23. Base Speaker
- 24. Base Charging Contacts
- 25. **[dnd]** (do not disturb) key and LED
- 26. Base LCD
- 27. Soft Keys
- 28. **[M]** (phonebook) key
- 29. **[▲]** (up) key
- 30. **[CID]** (caller ID) key
- 31. **[▼]** (down) key
- 32. **[▶/◻/exit]** (play/stop/exit) key
- 33. **[i<< / >>]** (repeat/skip) key
- 34. **[∅]** (delete) key
- 35. **[Ⓞ]** (answering machine on/off) key
- 36. Base Microphone
- 37. **[#]** key
- 38. **[✖tone]** key
- 39. **[◀▶]** (speaker) key and speaker LED
- 40. **[flash/find handset]** key
- 41. charge/in use LED
- 42. **[int'com/hold]** (intercom/hold) key
- 43. DC IN 9V Jack
- 44. TEL LINE Jack

Using the Interface









Reading the Handset Display

The handset display uses icons to tell you the status of your phone. The table below lists the icons and what they mean.

Icon	Status	Description
	Talk	The privacy icon appears when Privacy mode is turned on.
	Talk	The call record icon appears while recording a conversation.
	Talk	The mute icon appears when you mute the handset.
	Talk	The speaker icon appears when the handset speakerphone is in use.
	Talk	This icon appears when T-coil mode is turned on.
	Talk	The talk icon appears while on a call.
	Standby	The ringer off icon indicates that the ringer is turned off.
	Standby/Talk	The battery icon indicates the handset battery status: empty, low, medium, and full.

Reading the Base Display

The base display uses icons to tell you the status of your phone. The table below lists the icons and what they mean.

Icon	Status	Description
	Talk	The talk icon appears while on a call.
	Talk	The privacy icon appears when Privacy mode is turned on.
	Talk	The call record icon appears while recording a conversation.
	Talk	The mute icon appears when you mute the base.
	Standby	The new message icon appears when a new messages is received.
	Standby/Talk	The answering machine off icon appears when the answering machine is turned off.
	Standby/Talk	The answering machine full icon appears when the memory on the answering machine is full.
	Standby/Talk	The answering machine announce only icon appears when the answering machine is set to announce only greeting.
	Standby	The ringer off icon indicates that the ringer is turned off.

The Standby Screen

When the phone is in standby, the handset and base display shows the following items:

- Handset



— Ringer off icon (when the ringer is off)/ day of the week and time / battery icon

— Handset ID and Banner

— Number of new Caller ID calls received (If there are no new Caller ID messages, the Handset ID appears here.)

- Base

Status of your
answering machine
Number of
message



— Day of the week and time

— Date and year

Using the Four-way Function Key

Your handset and the base have a four-way function key that allows you to move the cursor (or highlighted area) on the display and access the most commonly used features at the touch of a button. By moving this key to the left, you open the Phonebook. Move the key to the right to access Caller ID information. To use this four-way key, place your thumb over the key on the station and move to the four positions to get the feel of how it moves and operates.

Using the Handset and Base Menus

To open the menu, press the **MENU** soft key. Highlight the option you want by pressing the four-way function key. This will move the cursor; the option currently highlighted appears in reversed out text. Select the highlighted option by pressing the **OK** soft key. To exit the menu and return to standby, press **[*]** on the handset and **[>/< /exit]** on the base.

If you do not press a key within 30 seconds, the phone will time out and exit the menu. When setting Date and Time, the time-out period is extended to two minutes.

Note: For GLOBAL SETUP and DEREGISTRATION menu options, make sure the line is not in use and the handsets are within range of the base.

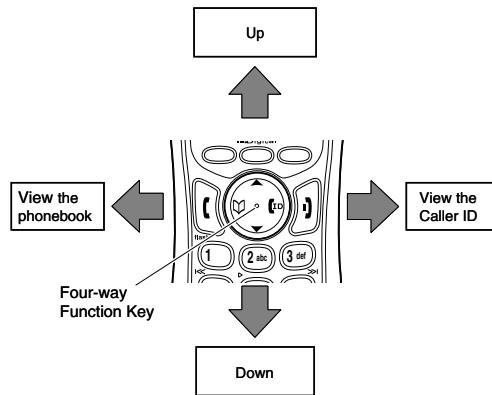

Entering Text from your Phone

You can use the number keypad on your handset or base to enter text by referring to the letters printed on each number key. When you press the number key in a text entry field, the phone displays the first letter printed on the number key. Press the number key twice to display the second letter and three times to display the third. Capital letters are displayed first, then lower case letters, then the number on the key.

If two letters in a row use the same number key, enter the first letter, then use **[right]** or **[left]** on the four-way function key to move the cursor to the next position to enter the second letter. For example, to enter Movies:

- 1) Press 6 once to enter M.
- 2) Use **[right]** on the four-way function key to move the cursor to the right.
- 3) Press 6 six times to enter o.
- 4) Press 8 six times to enter v.
- 5) Press 4 six times to enter i.
- 6) Press 3 five times to enter e.
- 7) Press 7 eight times to enter s.
- 8) Press the **OK** soft key to end your text entry.

If you make a mistake while entering a name, use **[right]** or **[left]** on the four-way function key to move the cursor to the incorrect character. Press the **DELETE** soft key to erase the wrong character, and then enter the correct character. To delete all characters, press and hold the **DELETE** soft key.

	Number of times key is pressed								
keys	1	2	3	4	5	6	7	8	9
1	1								
2 abc	A	B	C	a	b	c	2		
3 def	D	E	F	d	e	f	3		
4 ghi	G	H	I	g	h	i	4		
5 jkl	J	K	L	j	k	l	5		
6 mno	M	N	O	m	n	o	6		
7 pqrs	P	Q	R	S	P	q	r	s	7
8 tuv	T	U	V	t	u	v	8		
9 wxyz	W	X	Y	Z	w	x	y	z	9
0 oper	&	<	>	<	>	/	(blank)	-	_
	.	,	:	?	!	@	'	"	*
	#	0							

Installing the Phone

Choosing the Best Location

When choosing a location for your new phone, here are some important guidelines you should consider:

- The location should be close to both a phone jack and a continuous power outlet (one which is not connected to a switch).
- The base and handset should be kept away from sources of electrical noise such as motors, microwave ovens, and fluorescent lighting.
- For better reception, place the base as high as possible.
- The base should be placed in an open area for optimum range and reception.
- If your home has wired alarm equipment connected to a phone line, be sure that installing the system does not disable your alarm equipment. If you have questions about what will disable alarm equipment, contact your telephone company or a qualified installer.

Note: For maximum range:

- Keep the antenna free of obstruction.
- When the handset is not in use, place the handset in an upright position.
- Do not hold the handset where you would block the signal.
- Metal and reinforced concrete may affect cordless telephone performance.

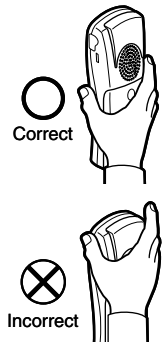

Wall Mounting the Base

This phone can be mounted on any standard wall plate.

- 1) Snap the wall mount adapter into the notches on the base top.
- 2) Plug the AC adapter into the DC IN 9V jack.
- 3) Wrap the AC adapter cord inside the molded wiring channel as shown.
- 4) Plug the AC adapter into a standard 120V AC wall outlet.
- 5) Plug the telephone line cord into the TEL LINE jack.
- 6) Plug the telephone line cord into the telephone outlet.
- 7) Align the mounting slots on the base with the mounting posts on the wall. Then push in and down until the phone is firmly seated.

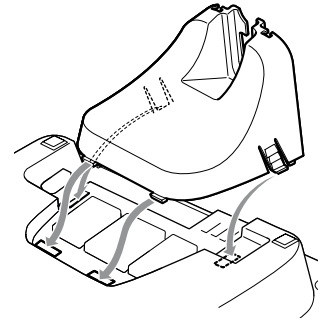

Note: DO NOT use an AC outlet controlled by a wall switch.

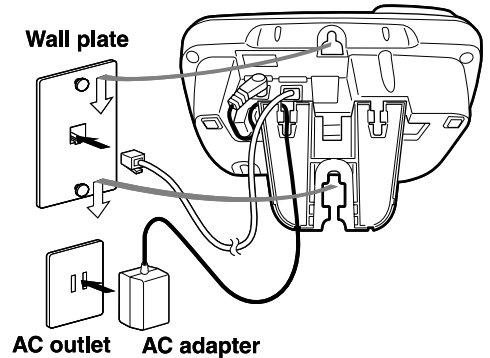

Direct Wall Mounting

If you don't have a standard wall plate, you can mount your phone directly to the wall. Before doing this, consider the following:

- Avoid electrical cables, pipes, or other items behind the mounting location that could cause a hazard when inserting screws into the wall.
 - Try to mount your phone within 5-feet of a working phone jack to avoid excessive wire lengths.
 - Make sure the wall material is capable of supporting the weight of the base and handset.
 - Use #10 screws with a minimum length of 1-3/8 inches, with anchoring devices suitable for the wall material where the base unit will be placed.
- 1) Insert two mounting screws into the wall, using the appropriate anchoring device, 3-15/16 inches apart. Allow about 1/8 inch between the wall and screw heads for mounting the phone.
 - 2) Refer to the steps on page 15 to complete the mounting process.

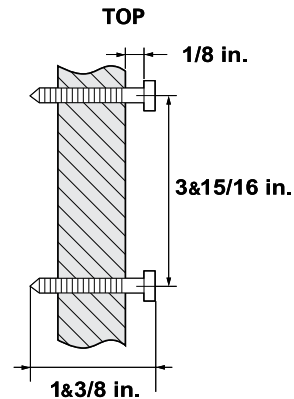

Installing the Rechargeable Battery

Use only the Uniden BT-446 rechargeable battery pack supplied with your cordless telephone.

Follow the steps below to install a battery:

- 1) Press in on the handset battery case cover (use the finger indentation for a better grip) and slide the cover downward to remove.
- 2) Plug the battery cable into the battery jack. Be sure to match the red and black wires to the label near the jack. The cable should snap into place. Gently pull on the battery cable. If the battery connector comes loose, try connecting again until the battery snaps into place.
- 3) Place the battery case cover back on the handset and slide it upwards until it clicks into place.

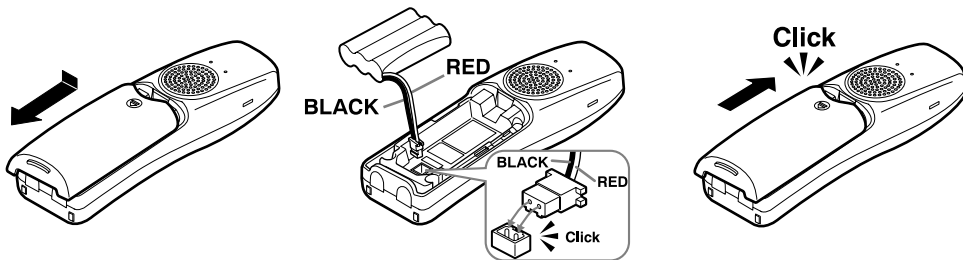

Connecting the Base and Charging the Handset

- 1) Connect the AC adapter to the DC IN 9V jack.
- 2) Connect the AC adapter to a continuous power supply (i.e., an outlet that is not controlled by a switch).
- 3) Close the handset and place it in the base with the LCD screen facing forward.
- 4) Make sure that the charge/in use LED illuminates. If the LED does not illuminate, check to see that the AC adapter is plugged in and the handset makes good contact with the base charging contacts.
- 5) Charge your handset at least 15-20 hours before plugging into the phone line.

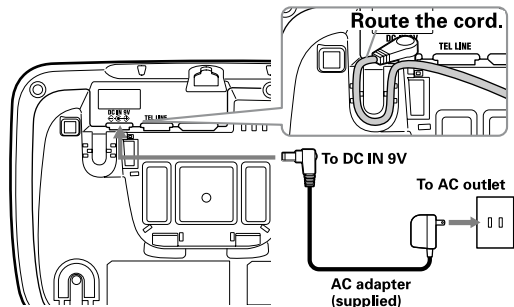

Installing the Belt Clip

- 1) Line up the holes on each side of the handset. To attach the belt clip, insert into the holes on each side of the handset. Press down until it clicks.
- 2) To remove the belt clip, pull either side of the belt clip to release the tabs from the holes.

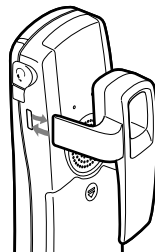

Connecting to the Phone Line

Once the handset battery pack is fully charged, connect the telephone line cord to the TEL LINE jack and to a telephone outlet.

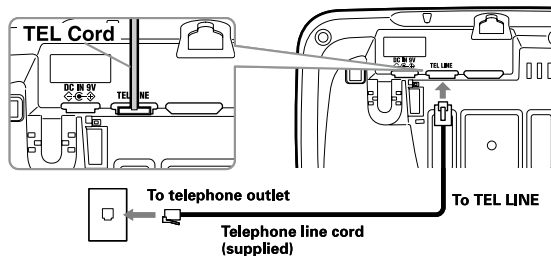

Testing the connection

To test your connection, try making a call. If your call connects, the settings are fine. If your call does not connect, check the following:

- 1) Check the AC adapter cord. Make sure it is securely connected to the DC IN connector and to a standard AC power outlet.
- 2) Check to make sure the battery is fully charged. (If you don't see the "battery full" icon, check to make sure the battery is properly connected.)
- 3) Change dial mode (instructions on page 20).

Changing the Dial Mode

Your phone can communicate with the telephone network in two different ways: tone dialing or pulse dialing. These days, most phone networks use a method called tone dialing, so your phone comes programmed for tone dialing. If your phone company uses pulse dialing, you will need to change your phone's dial mode. If you cannot connect to the telephone network, please follow the steps below to modify your phone's settings:

- 1) Press the **MENU** soft key. Select the GLOBAL SETUP menu, and then the DIAL MODE submenu.
- 2) Press [**▼**] on the four-way function key to select PULSE. (The initial setting is Tone).
- 3) Press the **OK** soft key. You will hear a confirmation tone.

If you ever need to change the dial mode back to Tone, follow the same procedure, but select **TONE** in step 2.

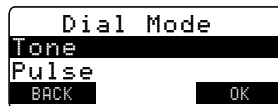

Basic Setup

Selecting a Language

Your phone supports three languages: English, French and Spanish. Once you select a language, the menus on the phone will display in that language. The default language is English.

- 1) Press the **MENU** soft key. Select the HANDSET SETUP or BASE SETUP menu, and then the HANDSET LANGUAGE or BASE LANGUAGE submenu.
- 2) Move the cursor to choose ENGLISH, FRANÇAIS (French), or ESPAÑOL (Spanish).
- 3) Press the **OK** soft key. You will hear a confirmation tone.



Setting the Date and Time

To change the day and time shown in the display, follow the steps listed below.

Note: If you don't press any keys for two minutes when setting the date and time, the phone will exit the menu.

- 1) Press the **MENU** soft key. Select the GLOBAL SETUP menu, and then the DATE & TIME submenu.
- 2) Use the four-way key to move the cursor to highlight the month, day, year, hours, and minutes. To change, press the number keypad.
- 3) To select AM or PM, press **[*tone]**, then press the **SAVE** soft key. You will hear a confirmation tone.

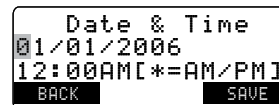

Activating Caller ID on Call Waiting and Call Waiting Deluxe

Your phone supports Caller ID on Call Waiting (CIDCW), so you can see the name and number of someone who calls when you're already on the line. Your phone also supports Call Waiting Deluxe (CWDX), which gives you a choice of how you want to handle a waiting call. You'll need to subscribe to these features with your phone company before you can use them. To let your phone support these features, follow the steps below:

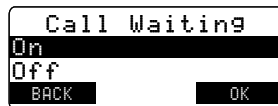

See page 39 for instructions on using Call Waiting Deluxe.

- 1) Press the **MENU** soft key. Select the GLOBAL SETUP menu, and then the CALL WAITING submenu.
- 2) Move the cursor to select ON or OFF.
- 3) If you select ON, CALL WAIT DELUXE submenu appears. Move the cursor to select ON or OFF.
- 4) Press the **OK** soft key. You will hear a confirmation tone.

Activating Personal Ring (Handset only)

You can assign special ring tones to anyone in your phonebook. When your phone gets a call, it looks up the Caller ID information in your phonebook. If you've assigned a personal ring to that number, the phone uses it so you know who is calling. To turn on personal ring, follow these steps:

- 1) Press the **MENU** soft key. Select the HANDSET SETUP menu, and then the PERSONAL RING submenu.
- 2) Move the cursor to select ON or OFF.
- 3) Press the **OK** soft key. You will hear a confirmation tone.

Activating the Key Touch Tone

Key Touch Tone is the tone your keypad makes when keys are pressed. You can turn this tone on or off.

- 1) Press the **MENU** soft key. Select the HANDSET SETUP or BASE SETUP menu, and then the KEY TOUCH TONE submenu.
- 2) Move the cursor to select ON or OFF.
- 3) Press the **OK** soft key. You will hear a confirmation tone.

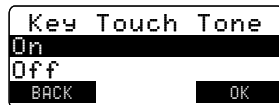

Adjusting the LCD contrast

Contrast adjusts the handset and base LCD brightness. Choose one from the 10 levels for optimum viewing.

- 1) Press the **MENU** soft key. Select the HANDSET SETUP or BASE SETUP menu, and then the LCD CONTRAST submenu.
- 2) Press [**▲/▼**] on the four-way function key to adjust the contrast of the LCD.
- 3) Press the **OK** soft key. You will hear a confirmation tone.



Adding Accessory Handsets

Your phone supports up to ten (10) handsets, including any handsets supplied with your phone. Accessory handsets do not need to be connected to a phone jack. You can now place a fully-featured cordless handset anywhere AC power is available to connect the handset charger.

Compatible Handsets

Your phone is compatible with the following Uniden 5.8 GHz Digital Accessory Handsets: TCX805, TCX905, TCX400, TCX440, TWX977 and ELX500. Please visit our website at www.uniden.com for the most up-to-date list of compatible handsets. If you purchase an accessory or extra handset, you must register the handset to the original or main base before use. Accessory handsets will not operate until they are registered.

Charge the Accessory Handset

The handset is powered by a rechargeable battery pack. The battery recharges automatically when the handset is placed in the charger.

- 1) Connect the AC adapter to the **DC IN 9V** jack and to a standard 120V AC wall outlet.
- 2) Set the charger on a desk or tabletop, and place the handset in the charger with the keypad facing forward.
- 3) Make sure that the **charge** LED illuminates. If the LED does not illuminate, check to see that the AC adapter is plugged in and the handset makes good contact with the base charging contacts.
- 4) Charge the handset battery pack for at least 15-20 hours before using your new cordless telephone for the first time.

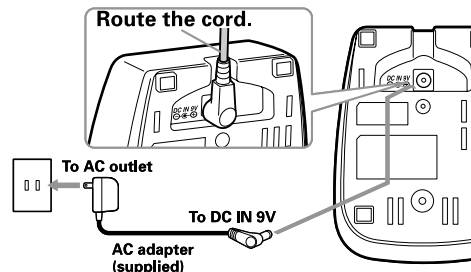

Registering TCX905 Accessory or Extra Handsets

If you purchase an accessory handset, you need to register the handset before use. Only one handset can be registered at a time. Handsets supplied with the phone are registered to the base by the factory. When charged, pre-registered handsets display a handset ID number. Handsets that have not been registered display MODELS VARY! PLACE HANDSET ON THE BASE FOR REGISTRATION OR REFER TO OWNER'S MANUAL. (If an accessory handset has ever been registered to a base, you must reset the handset before you can register it to a new base. See Resetting the Handsets on page 26.)

When you register an extra handset to the base, the handset ID will be assigned.

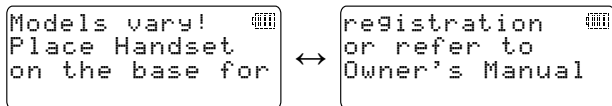

- 1) Before registering the **TCX905** accessory or other extra handset, the battery pack **MUST** be charged for 15-20 hours.
- 2) Place the handset in the base charging cradle to begin registration.
- 3) While the handset is registering, **HANDSET REGISTERING** will appear in the LCD. When **REGISTRATION COMPLETE** is displayed; the handset has been registered to the base. If **REGISTRATION FAILED** appears, please try these steps again.

Registering Other Compatible Handsets

- 1) With the base in standby, press the **MENU** soft key.
- 2) Move the cursor to select **REGISTER HANDSET**. Press the **OK** soft key.
- 3) On the handset, press and hold **[#]** until you hear a beep.
- 4) While the handset is registering, **HANDSET REGISTERING** will appear in the LCD. When **REGISTRATION COMPLETE** is displayed; the handset has been registered to the base. If **REGISTRATION FAILED** appears, please try these steps again.



Resetting the Handsets

If you want to register a handset to a different base or replace a handset with another one, you must first clear the existing registration data. To clear, please follow these steps:

- 1) Press the **MENU** soft key. Select the DEREGISTRATION submenu.
- 2) ARE YOU SURE? appears. Move the cursor to select YES. Press the **OK** soft key.

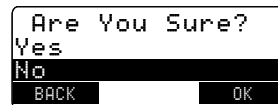

To clear other handset information, please follow these steps:

- 1) From the handset, press and hold **[*]** and **[#]** for more than 5 seconds. Select the DEREGISTER HS submenu.
- 2) Move the cursor to select the handset ID to be de-registered from the list, and then press the **OK** soft key.
- 3) DEREGISTER HS appears. Move the cursor to select YES. Press the **OK** soft key.
- 4) ARE YOU SURE? appears. Move the cursor to select YES, and then press the **OK** soft key. You will hear a confirmation tone.

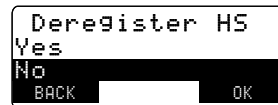

Base Unavailable (Handset Only)

To clear the base registration data in the handset, please follow these steps:

- 1) Press and hold **[*]** and **[#]** for more than 5 seconds. Select the BASE UNAVAILABLE submenu.
- 2) BASE UNAVAILABLE appears. Move the cursor to select YES, and then press the **OK** soft key.
- 3) ARE YOU SURE? appears. Move the cursor to select YES. Press the **OK** soft key.

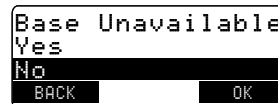

Setting up the Phonebook

Your phone allows you to store up to 2 numbers per name and up to 100 names in your handset and base phonebook. Your phone shares memory between your phonebook and CID with a total of 100 entries which are not used up by the 2 phone numbers that can be stored per 1 name entry. Once you store 100 phonebook entries, CID information will not be stored and will only display at time of new incoming calls. When Phonebook entries are full, you will hear a beep and MEMORY FULL appears. You cannot store any additional names and numbers unless you delete some of the existing ones.

You can also use the Phonebook or speed dial locations to store a group of numbers (up to 32 digits) that you may need to enter once your call connects. This is referred to as Chain Dialing.

Creating Phonebook Entries

To store names and numbers in your Phonebook, please follow these steps:

- 1) When the phone is in standby mode, press **[M]** (on the left side of the four-way key).
- 2) To create a new phonebook entry, press the **NEW** soft key. Edit Name appears.
- 3) **Enter the name for this entry (Edit Name).**
Use the keypad to enter a name for this entry; the name can contain up to 16 characters. (See page 13 for instructions on entering text.) If you do not want to enter a name for this entry, your phone will store this entry as No Name. Press the **OK** soft key when you are finished.
- 4) **Enter the number for this entry (Edit Number 1).**

Once you have stored a name, EDIT NUMBER 1 appears next. Use the number keypad, **[right]** or **[left]** on the four-way function key, or the **DELETE** soft key to enter the phone number 1; the phone number can contain up to 32 digits. If you need the phone to pause between digits when it's dialing (for example, to enter an extension or an access code), press **[redial/pause]** on the handset or the **PAUSE** soft key on the handset or the base to insert a two-second pause. You will see a P in the display. You can also use more than one pause together if two seconds is not long enough. Each pause counts as one digit. Press the **OK** soft key when you are finished. EDIT NUMBER 2 appears next. Use the same procedure when entering the phone number 1 to enter the phone number 2. Press the **OK** soft key when you are finished.

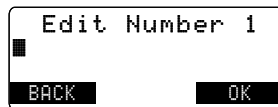
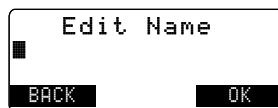

- 5) **Assign a personal ring tone for this entry (Personal Ring) (Handset only).** You can attach a personalized ring tone to each phonebook entry; the phone will use this ring tone when this person calls. Move the cursor to highlight one of the 20 different ring tone options. As you highlight each ring tone, you will hear a sample of that tone. When you hear the ring tone you want to use, press the **OK** soft key. If you do not want to use a personal ring tone for this phonebook entry, select the NO SELECTION option, and the phone will use your standard ring tone setting.

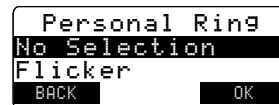

- 6) **Assign this entry to a Speed Dial number (Speed Dial).** Your phone has 10 speed dial numbers, 0 to 9. Move the cursor to select the speed dial number you want to assign to this phonebook entry, and press the **OK** soft key. Select NO SELECTION if you do not want to assign this entry to a speed dial number.
- 7) You will hear a tone confirming that the new phonebook entry has been stored, and DONE! appears in the display.

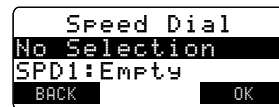

Note: When the shared memory is full, the oldest Caller ID message is overwritten.

Finding a Phonebook Entry

Phonebook entries are stored in alphabetical order. To scroll through the phonebook, press **[M]** and then press **[▲]** or **[▼]** on the four-way function key. Press and hold **[▲]** or **[▼]** on the four-way function key to scroll through the display quickly. When viewing the phonebook entry, use the **[→]** soft key or **[right]** on the four-way function key to display the DIAL NUMBER 2. To show the personal ring and speed dial, press the **[→]** soft key or **[right]** on the four-way function key.

You can also use the letters on the number keys to jump to a name that starts with that letter. Press **[M]** and a number key (**0, 2-9**) once for the first letter, twice for the second letter, and so on. The phonebook jumps to the first entry that begins with the letter you entered; you can then use **[▲]** or **[▼]** on the four-way function key to scroll to other entries. For example, to search for an entry beginning with the letter M, press **6** once.

To close the phonebook, press **[END]** on the handset or **[P/0/exit]** on the base. If you are looking up a phonebook entry during a call and want to close the phonebook, press the **BACK** soft key instead of **[END]**.

Editing Phonebook Entries

- 1) Press **[M]** to open.
- 2) Use **[▲]** or **[▼]** on the four-way function key to scroll through the phonebook entries. When you come to the entry you want to edit, press the **OPTIONS** soft key.
- 3) Move the cursor to select EDIT SELECTION submenu. Press the **OK** soft key.
- 4) Follow the steps for Creating Phonebook Entries on page 27. If you do not wish to change the information at any step, simply press the **OK** soft key to go to the next step.

Storing Caller ID or Redial Numbers in the Phonebook

You can store Caller ID or redial numbers in the phonebook so you can use them later. Go to the Caller ID or redial list and select the number you want to store. (If the Caller ID information did not include the number, then you will not be able to store it.)

- 1) When the phone is in standby, press **[☎]** (on the right side of the four-way key) to open the Caller ID list, or press the **REDIAL** soft key on the handset or the base or **[redial/pause]** on the handset to open the redial list.
- 2) Use **[▲]** or **[▼]** on the four-way function key to scroll through the Caller ID records or redial numbers. When you come to the information you want to store, press the **STORE** soft key. < ADD TO PHONEBK > appears.
- 3) Move the cursor to select NEW ENTRY or STORE & EDIT to add to an existing phonebook location. Press the **OK** soft key.
For the additional phone number, if the phone location is already full, THIS PERSON'S PHONE NUMBER MEMORY IS FULL. appears in the display. The number will not be stored.

Follow the steps for Creating Phonebook Entries on page 27.

Note: If the Caller ID message was received as a private or unknown number, or the message does not have the number, you cannot store the message in the phonebook. If it was received as private or unknown name, the message will be stored as <NO NAME>.

Erasing Phonebook Entries

You can erase individual phonebook entries or erase all the phonebook entries at once.

- 1) When the phone is in standby, press **[M]**.
- 2) Use **[▲]** or **[▼]** on the four-way function key or the number keypad to select desired phonebook entry, then press the **OPTIONS** soft key.
- 3) Move the cursor to select DELETE SELECTION. Press the **OK** soft key.
- 4) ARE YOU SURE? appears in the display. Select YES, and then press the **OK** soft key.
- 5) You will hear a confirmation tone, and DELETED! appears in the display.



Deleting All Phonebook Entries

- 1) When the phone is in standby, press **[M]**. Press the **OPTIONS** soft key.
- 2) Move the cursor to select DELETE ALL, and press the **OK** soft key.
- 3) ARE YOU SURE? appears in the display. Select YES and then press the **OK** soft key. You will hear a confirmation tone, and DELETED! appears in the display.

Copying Phonebook Entries to another Station

You can transfer stored phonebook entries from one handset to another or handset to the base without having to re-enter names and numbers. You can transfer one phonebook entry at a time or all phonebook entries at once.

- 1) When the phone is in standby, press **[M]**.
- 2) Use **[▲]** or **[▼]** on the four-way function key or the number keypad to select desired phonebook entry, then press the **OPTIONS** soft key.
- 3) Move the cursor to select COPY SELECTION. Press the **OK** soft key. TO WHICH UNIT? will appear.
- 4) Scroll through the list until the station you wish to copy listings to is highlighted. Press the **OK** soft key.

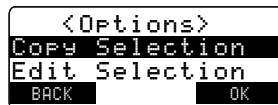

The phonebook entries will be transferred to the designated handset or the base. During the copy process, the receiving handset shows RECEIVING and the Banner name of the sending handset or base. When the transfer is completed, DONE! appears.

Copying all the phonebook entries at once:

- 1) When the phone is in standby, press **[M]**. Press the **OPTIONS** soft key.
- 2) Move the cursor to select COPY ALL. Press the **OK** soft key. TO WHICH UNIT? will appear.
- 3) Scroll through the list until the station you wish to copy listings to is highlighted. Press the **OK** soft key.
- 4) ARE YOU SURE? appears. Select YES or NO. Press the **OK** soft key.

The phonebook entries will be transferred to the designated handset or the base. During the copy process, the receiving handset shows RECEIVING and the Banner name of the sending handset or base. When the transfer is completed, DONE! appears.

Note:

- If your Phonebook contains 100 entries, you cannot store any new phonebook entries. You will hear a beep, and NOT ENOUGH MEMORY IN RECEIVING UNIT appears on the display.
- If the selected handset is out of range or data transfer is canceled, UNAVAILABLE appears in the display. Phonebook listings will not be transferred.

Customizing Your Phone

Changing the Handset Banner

Each handset will display a banner name once it is registered to the base.

The default banner is Handset #1, Handset #2, etc. You can change the name your phone displays by changing the banner display. If you have more than one handset, you can use the banner name to identify your handset during handset-to-handset functions like intercom and DirectLink. The banner lets you customize the name your handset displays. The name will be displayed on the LCD screen during Standby, Intercom, Intercom Hold, Room/Baby Monitor, and Copy Phonebook operations. The banner name will be displayed on the receiving handset as well.



- 1) Press the **MENU** soft key.
- 2) Select the **HANDSET SETUP** menu, and then the **BANNER DISPLAY** submenu.
- 3) Use the keypad or the **DELETE** soft key to enter or edit the banner name. (See page 13 for detailed instructions on entering text.)
- 4) Press the **OK** soft key. You will hear a confirmation tone.

Selecting a Ring Tone (Handset only)

You may choose from 10 melodies or 10 tones for your phone's primary ring tone. Each station can use a different ring tone or melody. The available ring tones are listed below:

Melodies	Ringers
Beethoven's Symphony #9 [Beethoven9]	Flicker
For Elise [Elise]	Clatter
We Wish You A Merry Christmas [Merry- Xmas]	Soft Alert
Home Sweet Home [Hm Swt Hm]	Wake Up
Lorri Song #6 [Lorri Song]	Lighting Bug
When the Irish Eyes Are Smiling [Irish Eyes]	Bebop (Beep Boop)
Aura Lee	Tone Board
Let Me Call You Sweet Heart [Sweetheart]	Chirp
Star Spangled Banner [Star Spngl]	Party Clap
Old MacDonald [Old MacDld]	Reminder

- 1) Press the **MENU** soft key. Select the HANDSET SETUP menu, and then the RINGER TONES submenu.
- 2) Move the cursor to highlight a ring tone. As each ring tone is highlighted, you will hear a sample of the ring tone.
- 3) When you hear the tone you want to use, press the **OK** soft key. You will hear a confirmation tone.

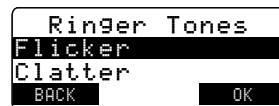

Activating AutoTalk (Handset only)

AutoTalk allows you to answer the phone simply by removing the handset from the cradle. You do not have to press any keys to answer the call.

- 1) Press the **MENU** soft key
- 2) Select the **HANDSET SETUP** menu, and then the **AUTOTALK** submenu.
- 3) Select **ON** or **OFF**, and press the **OK** soft key. You will hear a confirmation tone.

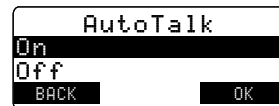

Activating Any Key Answer (Handset only)

Any Key Answer allows you to answer the phone by pressing any key in the number keypad.

- 1) Press the **MENU** soft key.
- 2) Select the **HANDSET SETUP** menu, and then the **ANY KEY ANSWER** submenu.
- 3) Select **ON** or **OFF**, and then press the **OK** soft key. You will hear a confirmation tone.



Using your Phone

	From the base speakerphone	From a cordless handset	From a handset speakerphone
Making a call	1) Press [*00] . 2) Listen for the dial tone. 3) Dial the number. OR 1) Dial the Number. 2) Press [*00] .	1) Remove the handset from the charging cradle. 2) Press [*/flash] . 3) Listen for the dial tone. 4) Dial the number. OR 1) Remove the handset from the charging cradle. 2) Dial the number. 3) Press [*/flash] .	1) Remove the handset from the charging cradle. 2) Press [*00] . 3) Listen for the dial tone. 4) Dial the number. OR 1) Remove the handset from the charging cradle. 2) Dial the number. 3) Press [*00] .
Answering a call	1) Press [*00] .	1) Pick up the handset. (If AutoTalk is on, the phone will answer when you remove the handset from the charging cradle.) 2) Press [*/flash] . (If Any Key Answer is on, you can also press any number keypad.)	1) Pick up the handset. 2) Press [*00] .
Hanging up	1) Press [*00] .	1) Press [*] .	1) Press [*] .

Making a call from the Phonebook

- 1) When the phone is in standby, press **[☑]** to open the phonebook.
- 2) Scroll through the list with the **[▲]** or **[▼]** on the four-way function keys until you find the phonebook entry you want to call. (See Finding a Phonebook Entry on page 28).
- 3) Press **[*/flash]** or **[*☎]** on the handset or **[*☎]** on the base to dial the number.

Or

- 1) Press **[*/flash]** or **[*☎]** on the handset or **[*☎]** on the base.
- 2) Press **[☑]** to open the phonebook.
- 3) Scroll through the list with the **[▲]** or **[▼]** on the four-way function keys until you find the phonebook entry you want to call. (See Finding a Phonebook Entry on page 28).
- 4) Press the **DIAL** soft key to dial the number.

To insert a 1 in front of a phonebook number to enable long distance dialing, press **[*1tone]**. To remove area code, press **[#]**.

Making a call with Speed Dial

- 1) When the phone is in standby, press and hold the number key **[0]-[9]** until the assigned phonebook entry appears in the display.
- 2) Press **[*/flash]** or **[*☎]** on the handset or **[*☎]** on the base to dial the number.

Switching to the Handset Speakerphone during a Call

To switch a normal call to the speakerphone, press **[*☎]** on the handset. To switch from a speakerphone call to a normal call, press **[*☎]**.

Using Caller ID, Call Waiting and Redial Lists

If you subscribe to Caller ID from your phone company, your phone will show you the caller's phone number and name (if available) whenever a call comes in. If you subscribe to both Call Waiting and Caller ID, the phone also shows you the name and the number of any call that comes in while you are on the line.

Note:

- If you answer a call before the Caller ID message is received (for example, before the second ring), the Caller ID message may not appear.
- When the call is received via a Telephone Company that does not offer Caller ID service, the caller's phone number and name will not appear. (This includes some international calls.)
- When the Call is from a PBX (private branch exchange), the caller's phone number and name may not appear, but you may see a main company phone number for that PBX appear.

Using the Caller ID List

You can store up to 100 Caller ID numbers in each handset or the base. Your phone shares up to 100 memory entries between your Phonebook and Caller ID. When the shared memory is full and when you store a new phonebook entry, the oldest Caller ID message is overwritten. Once you reach your maximum phonebook entries of 100, Caller ID information will not be stored (but it will still display when the call comes in).

To open the Caller ID list, press **[F10]** (on the right side of the four-way key). The phone will show the total number of stored Caller ID records. Use **[▲]** or **[▼]** to scroll through the list, or enter a letter on the keypad to jump to the first caller ID name that starts with that letter. To scroll quickly through the list, press and hold **[▲]** or **[▼]** on the four-way function key.

Note: The number of calls from the same Caller ID will appear next to the time to indicate that this is an unread message. Once you view the new message, the number will disappear.

Making a call from a Caller ID Record

- 1) When the phone is in standby, press **[F10]** (on the right side of the four-way key) to open the Caller ID list.
- 2) Use **[▲]** or **[▼]** to find the Caller ID record you want to dial.
- 3) To add (or delete) a “1” at the beginning of the displayed phone number, press **[*tone]**. To add (or remove) the stored area code, press **[#]**.
- 4) Press **[/flash]** or **[⏏]** on the handset or **[⏏]** on the base to dial the number.

Or

- 1) Press **[/flash]** on the handset or **[⏏]** on the handset or **[⏏]** on the base.
- 2) Press **[F10]** to open the Caller ID list.
- 3) Use **[▲]** or **[▼]** to find the Caller ID you want to dial.
- 4) To add (or delete) a “1” at the beginning of the displayed phone number, press **[*tone]**. To add (or remove) the stored area code, press **[#]**.
- 5) Press the **DIAL** soft key to dial the number.

Deleting Caller ID Numbers

To delete only one Caller ID number, go to the Caller ID list and select the number you want to delete. Press the **DELETE** soft key. When the phone asks you to confirm, select YES.

To delete all the Caller ID numbers, go to the Caller ID list and press the **DELETE** soft key. Select YES when asked if you want to DELETE ALL.

Note: When you delete a Caller ID number, you delete it permanently.

Using Call Waiting and Call Waiting Deluxe

If you have Call Waiting service and a second call comes in when you are on the phone, a call waiting tone will sound. Press **[*/flash]** on the handset or **[flash/find handset]** on the base to accept the waiting call. There is a short pause, and then you will hear the new caller. To return to the original caller, press **[*/flash]** on the handset or **[flash/find handset]** on the base.

Note: You must subscribe through your telephone provider to receive Call Waiting services.

Your phone gives you new options for Call Waiting Deluxe. At the touch of a button, you can place the caller on hold, send them to your voice mail service, or conference them into your current call. You must subscribe to Call Waiting and Call Waiting Deluxe to use these features. Not all features are available in all areas. Check with your telephone provider for details.

Note:

- To active features, select the CALL WAITING submenu and the CALL WAIT DELUXE submenu to ON. See page 22.
 - If you don't choose a CWDX option within 30 seconds, the phone returns to the call.
 - To return to the call, press the **BACK** soft key.
- 1) When you receive a Call Waiting call, press the **MENU** soft key.
 - 2) Move the cursor to CALLWAITDELUXE, and then press the **OK** soft key.
 - 3) Move the cursor or use the number keypad **[1-7]** to select an option.

Ask to Hold — A prerecorded message states that the user will be available shortly, and the call is place on hold.

Tell Busy — A prerecorded message tells the caller you are busy, and the waiting call is disconnected.

Forward — The caller is sent to your voice mail box, if available.

Answer/Drop — Disconnects the first call, and connects to the new caller.

Conference — Starts a conference call with your first and second callers.

Drop First/Drop Last — During a conference call, allows you to choose to drop the first or last caller.

- 4) Press the **OK** soft key. A confirmation screen will appear, and the phone returns to the call.

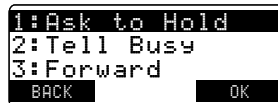

Redialing a Number

You can quickly redial the last 3 numbers dialed on each handset and the base.

- 1) With the phone in standby, press the **REDIAL** soft key on the handset or base or **[redial/pause]** on the handset to open the redial list.
- 2) Use **[▲/▼]** to scroll through the redial list.
- 3) When you find the number you want to dial, press **[/flash]** or **[⏏]** on the handset or **[⏏]** on the base to dial the number.

Or

- 1) Press **[/flash]** or **[⏏]** on the handset or **[⏏]** on the base to dial the number.
- 2) Press **[redial/pause]** on the handset or **REDIAL** soft key on the base to open the redial list.
- 3) Use **[▲/▼]** to scroll through the redial list.
- 4) Press the **DIAL** soft key to dial the number.

Note:

- If the number exceeds 32 digits, only the first 32 digits are retained in redial memory.
- If the redial memory is empty, you will hear a beep.

Deleting a Redial Record

If you want to delete a phone number from the redial list, follow the steps below:

- 1) With the phone in standby, press the **REDIAL** soft key on the base or handset or **[redial/pause]** on the handset.
- 2) Use **[▲/▼]** to scroll through the redial list.
- 3) When you find the redial number you want to delete, press the **DELETE** soft key.
- 4) Select YES, and press the **OK** soft key. The redialed number is deleted.

Adjusting the Ringer, Earpiece and Speaker Volume

Adjusting the Ringer Volume

You can choose from three ringer volume settings on the handset and base (off, low, and high). With the phone in standby, use [▲/▼] on the four-way function keys to adjust the ringer volume.

Adjusting the Speaker Volume

Ear speaker: You can choose from six volume levels for the earpiece speaker. To adjust the earpiece volume while on a call, press [▲] (to make it louder) or [▼] (to make it softer).

Speaker: You can choose from six volume levels for the handset speakerphone and ten volume levels for the base speakerphone. To adjust the speaker volume while on a call, press [▲] (to make it louder) or [▼] (to make it softer).

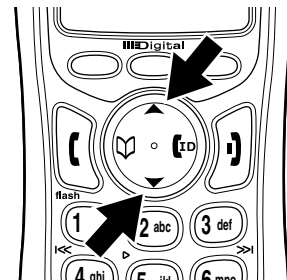

T-coil (Handset only)

The T-coil feature, used by hearing aid users, reduces the magnetic noise interference generated by digital cordless phones. Individuals using hearing aids will turn off the hearing aid microphone to avoid interference issues and turn on T-coil. By toggling back and forth between T-coil on/off and the hearing aid microphone on/off, you avoid excessive interference and are able to hear clearly with the hearing aid device.

- 1) Press the **MENU** soft key.
- 2) Select the HANDSET SETUP menu, and then the T-COIL submenu.
- 3) Move the cursor to select ON or OFF.
- 4) Press the **OK** soft key. You will hear a confirmation tone.

Note: Using the T-coil feature may shorten your battery's talk time, please set to off when not using this feature.

Finding a Lost Handset

To locate a misplaced handset, press **[flash/find handset]** key on the base when the phone is in standby. All registered handsets will beep for 60 seconds, and PAGING appears on the handset display. To cancel paging, press any key on the found handset or press **[flash/find handset]** key on the base.

Note: If the battery pack is completely drained, the handset will not beep when paging.

Using Hold, Conference and Transfer

Placing a Call on Hold

- 1) During a call, press **[int'com/hold]** to place the caller on hold. If you leave a caller on hold for more than ten seconds, the display screen will read, HOLD.
- 2) To return to the party on hold, press **[/flash]** or **[⏮]** on a handset or **[⏮]** on the base. The phone will return to the holding party.

Note:

- You can only place a caller on hold for 5 minutes. Once 5 minutes has passed, that party's line will be disconnected and the phone will return to standby.
- While a call is on hold, Caller ID and Call Waiting cannot be received.

Conferencing

If you have more than one handset, up to four people can participate in a conference call. A four-way conference call consists of an outside line, two handsets, and the base speakerphone. You can easily join a call already in progress.

- 1) Press **[/flash]** or **[⏮]** on the handset or **[⏮]** on the base to join the call.
- 2) To hang up, return the handset to the cradle or press **[⏹]** on the handset or **[⏮]** on the base. The other party will still be connected to the call.

Transferring a Call

You can transfer a call from one station to another.

- 1) During a call, press **[int'com/hold]**.
- 2) Use **[▲]** or **[▼]** to select the station you want to transfer the call to, then press the **OK** soft key.

The call will automatically be placed on hold, and a paging tone sounds. To cancel the transfer, press **[/flash]** or **[⏏]** on the initiating station.

- 3) When another station accepts the transferred call, your call will be disconnected. If you want to rejoin the call, press **[/flash]** or **[⏏]** on the handset or **[⏏]** on the base again.



Answering a Transferred Call

When a station receives a call transfer, it sounds a paging tone and shows the ID of the station that is paging. To accept the call transfer:

- 1) Press **[/flash]**, **[int'com/hold]**, or the **ANSWER** soft key from the handset (or **[int'com/hold]**, **[⏏]**, or the **ANSWER** soft key on the base).
- 2) To speak to the caller, press **[/flash]** on the receiving handset or **[⏏]** on the base.

If you have multiple handsets, only the first handset to answer the transfer page will be connected to the call. If the transfer page is not picked up within one minute, the operation will be canceled.

Using Special Features

Do Not Disturb (All Calls)

DND allows you to mute the ringer of all registered handsets and the base. With the phone in standby, press and hold **[dnd]** on the base. You will hear a confirmation tone and the **dnd** LED illuminates. To cancel, press **[dnd]** again. You can also mute the ringer tone while the phone is ringing by pressing **[dnd]** on the base.

Note: If the answering machine is off, it will automatically turn on when you activate DND. If you turn the answering machine off while DND is on, DND automatically turns off along with the answering machine.

Muting the Ringer (One Call Only)

While a handset is ringing, press the **MUTE** soft key on the handset or base, or press **[M]** on the handset or **[P/O /exit]** on the base to mute the ringer for this call. The phone will ring again normally on the next call. (The handset must be off the cradle to mute the ringer.)

Muting the Microphone

Mute turns off the microphone so the caller can not hear you. The display shows the MUTE ON icon while the microphone is muted.

- 1) While you are on a call, press the **MUTE** soft key.
- 2) MUTE ON will appear in the display for 2 seconds, but the  icon will appear and remain in the display until the feature is turned off.
- 3) To cancel muting, press the **MUTE** soft key. MUTE OFF appears.

Privacy Mode

If you don't want another station to interrupt you while on a call, you can turn on privacy mode. As long as your station is in privacy mode, other stations won't be able to join your call or make any calls of their own.

From the Handset

- 1) While on a call, press the **PRIVACY** soft key.

- 2) PRIVACY MODE ON will appear in the display for 2 seconds, but the  icon will appear and remain in the display until the feature is turned off. Other stations will not be able to make a call and their display will list UNAVAILABLE.

To turn Privacy off, press the **PRIVACY** soft key again. PRIVACY MODE OFF appears.

From the Base:

- 1) While on a call, press the **MENU** soft key.
- 2) Move the cursor to **CALL PRIVACY**, and then press the **OK** soft key. PRIVACY MODE ON will appear in the display for 2 seconds, but the  icon will appear and remain in the display until the feature is turned off. Other stations will not be able to make a call and their display will list UNAVAILABLE.

To turn Privacy off, repeat the procedures listed above. PRIVACY MODE OFF appears.

Using the DirectLink Feature

A pair of handsets (or two pairs of handsets at one time) can function as two-way radios. This feature is called DirectLink and will not interfere with the base's ability to make or receive telephone calls while in use. To activate, you must set both handsets to the DirectLink feature. While using this feature, these two handsets will not be able to make or receive normal phone calls until this operation is canceled; however, other handsets will function normally.

Note: If the party is out of range, NO SIGNAL appears in the display and the operation will be canceled.

- 1) Press the **MENU** soft key. Select DIRECTLINK MODE menu.
- 2) Press the **OK** soft key. The display shows TO ENTER DIRECTLINK MODE PRESS [ENTER].
- 3) Press the **ENTER** soft key. You will hear a confirmation tone, and DIRECTLINK MODE COMPLETE appears in the display.

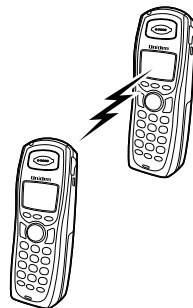

To enter DirectLink mode Press [ENTER]	
BACK	ENTER

Making a DirectLink Call

- 1) To call another handset with DirectLink, press the **DirectLink** soft key.
- 2) Move the pointer to select the handset you want to call, and press the **OK** soft key. If the handset is out of range or not in DirectLink operation, the display shows OUT OF RANGE.
- 3) On the receiving handset, press the **ANSWER** soft key or **[[/flash]**.

Exiting a DirectLink Call

To exit the DirectLink feature and return to standby, press the **CANCEL** soft key and then press the **OK** soft key. DIRECTLINK MODE CANCEL appears in the display.

Intercom

Making an Intercom Page

You can use the intercom to talk to another station without using the phone line.

- 1) With the phone in standby, press **[int'com/hold]**.
- 2) Use **[▲]** or **[▼]** to select the handset or base you want to talk with, and then press the **OK** soft key. If you select ALL, all other registered handsets and base will be paged. An intercom tone sounds. To cancel intercom, press **[j]** on either handset (or **[int'com/hold]** or **[⏪]** on the base).

Answering an Intercom Page

When the intercom page tone sounds, the display will show the ID of the station that is paging.



- 1) Press **[flash]**, **[int'com/hold]**, or the **ANSWER** soft key (or **[int'com/hold]**, **[MUTE]** or the **ANSWER** soft key on the base). Or press a number key, **[*tone]**, or **[#]** (when Any Key Answer is enabled), or pick up the handset from the cradle (when AutoTalk is on).
- 2) To hang up an intercom page, press the **END** soft key or **[END]** on either handset (or **[int'com/hold]**, on the base).

Note:

- If the party is busy, the handset returns to standby. If the party is out of range, UNAVAILABLE appears in the display and the operation will be canceled.
- If you receive an outside or intercom call or page while selecting the other handset, the operation is canceled.
- If you do not select a handset within 30 seconds, the operation will be canceled.
- If the party does not answer within one minute, the operation is canceled.

Room/Baby Monitor

This feature allows you to monitor sounds in another room. Place a handset (or the base) in the room you wish to monitor; it will function as a microphone. Another handset (or the base) can be set to function as a remote speaker, allowing you to monitor sounds in the room.

- 1) Press the **MENU** soft key and enter the Room Monitor menu. TO WHICH UNIT? appears.
- 2) Select the handset or base you want to monitor by using **[▲]** or **[▼]**.

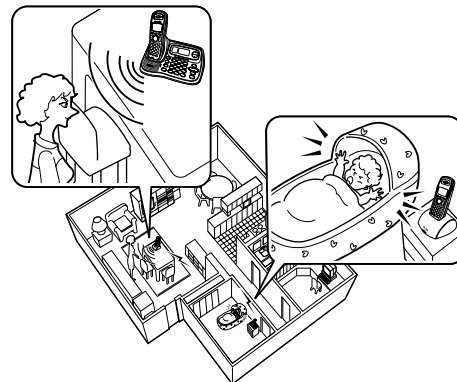

- 3) Press the **OK** soft key. **MONITOR** appears on the handset or the base, and **MONITORING** appears on the base or the handset, and you hear sounds in the room where the handset or base is installed.
- 4) To turn off the Room Monitor, press the **END** soft key or **[*]** on either handset or return the handset to the cradle.

If you want to prevent other handsets or the base from monitoring the station, press the **MENU** soft key on the handset or base. Select the **HANDSET SETUP** menu or the **BASE SETUP** menu, and then the **ROOM MONITOR** submenu. Select **OFF** and press the **OK** soft key.

Note:

- This feature only works when both handsets are within range of the base.
- If the party is out of range, **UNAVAILABLE** appears in the display and the operation will be canceled.
- While a pair of handsets is in Room/Baby Monitoring, they cannot be used to make or receive calls; however, other handsets can still make and receive calls normally.

Tone Dialing Switch Over

If your telephone company requires pulse dialing, you can switch to tone dialing after the call connects. This feature is useful when you need tone dialing to use automated menu systems, such as telephone bank tellers, telephone prescription refills, customer support menus, etc. If your phone is set to pulse dialing, make your call normally. Once your call connects, press **[*tone]** on the handset or base. Any digits you enter from then on will be sent as tone dialing. When this call ends, the phone automatically returns to pulse dialing.

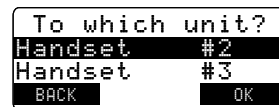

Installing the Optional Headset

Your phone may be used with an optional headset. To use this feature, insert the headset plug into the headset jack. Your phone is ready for hands-free conversations. Headsets may be purchased by calling the Uniden Parts Department. See back cover page for contact information.

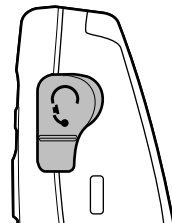

Seven-Digit Dialing

If you can make a local call by dialing only 7 digits (instead of 10), you can program your local area code into your phone. If you get a call from within your area code, you'll only see the 7-digit phone number. If you get a call from outside your area code, you'll see all 10 digits. To enter an area code, follow the steps below:

- 1) Press the **MENU** soft key. Select the GLOBAL SETUP menu, and then the AREA CODE submenu.
- 2) Use the number keypad (**0-9**) to enter a 3-digit area code. If an area code has already been stored, it will appear in the display. Press the **DELETE** soft key to delete the stored code, and then enter a new one.
- 3) Press the **OK** soft key. You will hear a confirmation tone.

Inuse Line Setup (Base only)

Change this option only when instructed to by customer service. You can choose from TYPE-A, TYPE-B, or OFF. Default is Type-A.

- 1) Press the **MENU** soft key. Select the GLOBAL SETUP menu, and then the INUSE LINE SETUP submenu.
- 2) CHANGE ONLY IF INSTRUCTED BY CUSTOMER SERVICE appears. Press the **OK** soft key.
- 3) Move the cursor to select TYPE – A, TYPE – B, or OFF.
- 4) Press the **OK** soft key. You will hear a confirmation tone.

Setting Up the Answering Machine

Your phone has a built-in answering machine that answers and records incoming calls. You can also use your answering machine to record a conversation or leave a voice memo.

Features

- Digital Tapeless Recording
- Up to 12 Minutes of Recording Time
- Call Screening
- Personal or Pre-recorded Outgoing Messages
- Voice Prompts for Menu Setup (English, Spanish, or French)
- Day and Time Announcement
- Remote Message Retrieval
- Toll Saver
- Conversation Recording
- Voice Memo
- Message Alert
- Hands Free Speakerphone at Base
- Records Up to 59 messages

Digital Tapeless Recording allows you to quickly review, save, or delete the messages you choose. You will never have to worry about a tape wearing out, jamming, or resetting improperly.

Using the Answering Machine Interface

Using Handset and Base Menus

You can set up your answering machine's primary features from the base or handset. The menu options of the base have voice prompt.

When the phone is in standby, press the **MENU** soft key and then scroll down and select **ANSW. SETUP**. Press the **OK** soft key. Use [**▲**] or [**▼**] to scroll through the answering machine setup menu options. Select the option by pressing the **OK** soft key.

To exit the menu and return to standby, press [**⏏**] on the handset and [**▶/□/exit**] on the base.

Handset operation

You can use your handset to operate your answering machine from anywhere in your home. When the phone is in standby, press the **☒** soft key on the handset to access the answering machine. **REMOTE ANSWERING MACHINE OPERATION** appears on the handset display, and the answering machine announces the time, and number of new and old messages. Keep the following things in mind when you use your handset to access your answering machine:

- You can enter a command at any time during the announcements.
- After the first announcement, you have 30 seconds to enter your first command before the answering machine returns to standby.
- If you receive a call, the remote operation is cancelled.
- During the remote operation **HANDSET REMOTE MODE** appears on the base.

Selecting the Language

You can select the language (English, French, and Spanish) of your answering machine announcements. The default answering machine language is English.

From the base or handset:

- 1) Press the **MENU** soft key. Select the ANSW. SETUP menu option, then the ANSW LANGUAGE submenu and press the **OK** soft key.
- 2) Move the cursor to choose ENGLISH, FRANÇAIS (French), or ESPAÑOL (Spanish).
- 3) Press the **OK** soft key. You will hear a confirmation tone.

Your Greeting

Your answering machine comes with a pre-recorded outgoing message or greeting that plays when you receive a call:

"Hello, no one is available to take your call. Please leave a message after the tone."

Or you can record your own personal outgoing greeting. Your recorded greeting must be between 2 seconds and 30 seconds long. Once you have recorded a personal greeting, you can switch back and forth between the pre-recorded greeting and your own greeting.

	From the base	From the handset
To Record a Personal Greeting	<ol style="list-style-type: none"> 1) Press the MENU soft key. Select the ANSW. SETUP menu option, then the RECORD GREETING submenu and press the OK soft key. 2) Press the START soft key. 3) The answering machine announces, "Record Greeting", begin recording after the announcement. 4) The message counter on the base displays "30", and then begins to count down. 5) When you finish recording, press the STOP soft key, [▷/◁ /exit]. You will hear a beep, and the answering machine plays back your greeting for confirmation. 	<ol style="list-style-type: none"> 1) With the phone in standby, press the  soft key. REMOTE ANSWERINGMACHINE OPERATION appears on the display, and the answering machine announces the time, and the number of new and old messages. 2) Press [8]. 3) The answering machine announces, "Record Greeting", begin recording after the announcement. 4) When you finish recording, press the STOP soft key, [5], or [8]. You will hear a beep, and the answering machine plays back your greeting for confirmation.

	From the base	From the handset
To Select a pre-recorded Greeting	<ol style="list-style-type: none"> 1) With the phone in standby, press the MENU soft key. Select ANSW. SETUP menu option, then the GREETINGOPTIONS submenu and press the OK soft key. The answering machine plays the current greeting. 2) To keep this greeting, do nothing. 3) To switch to the other greeting, press the CHANGE soft key while the answering machine is playing the current greeting. 4) Each time you press the CHANGE soft key, the answering machine switches between the pre-recorded and the personal greeting. The last greeting you hear is used as the current greeting. 	<ol style="list-style-type: none"> 1) With the phone in standby, press the ☒ soft key. REMOTE ANSWERINGMACHINE OPERATION appears on the display, and the answering machine announces the time, and the number of new and old messages. 2) To switch to the other greeting, press [6]. 3) Each time you press [6], the answering machine switches between the pre-recorded and the personal greeting. The last greeting you hear is used as the current greeting.

Deleting your Personal Greeting (Base Only)

You can delete your personal greeting from the base. You cannot delete the pre-recorded greeting.

- 1) When the phone is in standby, press the **MENU** soft key. Select ANSW. SETUP menu option, then the GREETINGOPTIONS submenu and press the **OK** soft key. The answering machine plays the current greeting.
- 2) While the personal greeting is playing, press the **DELETE** soft key.
- 3) The answering machine announces "Greeting has been deleted" and automatically switches back to the pre-recorded greeting.

Setting the Number of Rings

The ring time setting allows you to set the number of rings the caller hears before your answering machine plays the outgoing message. You can set the ring time to answer after two, four, or six rings. If you enable the Toll Saver (TS setting), the answering machine picks up after two rings if you have new messages, and after four rings if there are none. This way, if you make a long distance call to check your messages, you can hang up after the second ring to avoid long distance billing charges.

From the base or handset:

- 1) Press the **MENU** soft key. Select the ANSW. SETUP menu, and then the RING TIME submenu.
- 2) Move the cursor to select a Ring Time (2 TIMES, 4 TIMES, 6 TIMES or TOLL SAVER).
- 3) Press the **OK** soft key. You will hear a confirmation tone.

Setting the Record Time (or Announce Only)

You can choose how long callers have to record a message. Set the record time to 1 MINUTE or 4 MINUTES to limit the record time for incoming messages. If you set the record time to ANNOUNCE ONLY, the answering machine answers the call but prevents callers from leaving a message.

From the base or handset:

- 1) Press the **MENU** soft key. Select the ANSW. SETUP menu, and then the RECORD TIME submenu.
- 2) Move the cursor to select Record Time (1 MINUTE, 4 MINUTES, or ANNOUNCE ONLY).
- 3) Press the **OK** soft key. You will hear a confirmation tone.

While your answering machine is set to ANNOUNCE ONLY, the base screen will display ANNOUNCE ONLY. If you are using the prerecorded greeting, the answering machine automatically switches to the following message: "Hello, no one is available to take your call. Please call again." If you are using a personal greeting, the answering machine continues to use that greeting.

Activating the Message Alert

The Message Alert feature sounds a short alert tone every 15 seconds whenever you have a new message. To turn on the message alert:

From the base or handset:

- 1) Press the **MENU** soft key. Select the ANSW. SETUP menu, and then the MESSAGE ALERT submenu.
- 2) Move the cursor to select ON or OFF.
- 3) Press the **OK** soft key. You will hear a confirmation tone.

Activating Call Screening

Your phone allows you to listen to callers leaving you a message. This, Call Screen, feature can be turned on or off.

From the base or handset:

- 1) Press the **MENU** soft key. Select the ANSW. SETUP menu and then the CALL SCREEN submenu.
- 2) Move the cursor to select ON or OFF.
- 3) Press the **OK** soft. You will hear a confirmation tone.

Setting a Security Code or Personal Identification Number (PIN)

To play your messages from a remote location, you will need to enter a two-digit Personal Identification Number (PIN) or PIN Code.

From the base or handset:

- 1) Press the **MENU** soft key. Select the ANSW. SETUP menu, and then the SECURITY CODE submenu.
- 2) Enter a two-digit security code (01-99) using the number keypad **[0-9]**.
- 3) Press the **OK** soft. You will hear a confirmation tone.



Using the Answering Machine

The message counter on the LCD displays the number of messages stored in memory. If the display flashes, then there are new messages waiting for you that you have not yet listened to. The answering machine plays your new messages first. After you listen to all of your new messages, you can then play your old messages.

Note: Time stamp will not be heard until you have set the time.

Turning your Answering Machine On and Off

	From the base	From the handset
Turning On	<ol style="list-style-type: none">1) With the phone in standby, press [⓪].2) The answering machine announces "Answering System is on" and plays the current greeting.3) The message counter displays the number of messages stored in memory. If the counter flashes, then you have new messages waiting.	<ol style="list-style-type: none">1) With the phone in standby, press the  soft key on the handset. REMOTE ANSWERINGMACHINE OPERATION appears on the handset display, and the answering machine announces the time, and the number of new and old messages.2) Press [9] at any time during the announcement.3) The answering machine announces "Answering System is on" and plays the current greeting message.

	From the base	From the handset
Turning Off	<ol style="list-style-type: none"> 1) With the phone in standby, press [∅]. 2) The phone announces "Answering System is off." 3)  appears. 	<ol style="list-style-type: none"> 1) With the phone in standby, press the  soft key on the handset. REMOTE ANSWERING MACHINE OPERATION appears on the handset display, and the answering machine announces the time, and the number of new and old messages. 2) Press [9] at any time during the announcement. The answering machine announces "Answering System is off."

Reviewing Messages

When you have a new message, the new message LED on the handset blinks. The LED stops blinking when you listen to all of your new messages. The answering machine will play your new messages first. After you play all of your new messages, you can then play your old messages.

You can review your messages from the base or from the handset:

	From the base	From the handset
Playing your messages	Press [▶/∅/exit]. The answering machine announces the number of new and old messages. It announces the message number, plays the message, and then announces the time and date that message was received.	Press the  soft key. REMOTE ANSWERING MACHINE OPERATION appears on the handset display, and the answering machine announces the time, and the number of new and old messages. Press [▶/2] to play your messages. After playing the message, the answering machine announces the time and date that message was received.

	From the base	From the handset
Repeating a message	Press [⏮] or the ⏮ soft key once to go to the beginning of the current message. Press [⏮] or the ⏮ soft key repeatedly to go back to a previous message. Press and hold to rewind through the current message.	Press [⏮/1] once to go to the beginning of the current message. Press [⏮/1] repeatedly to go back to a previous message.
Skipping a message	Press [⏭] or the ⏭ soft key to go to the beginning of the next message. Press and hold to fast forward through the current message.	Press [⏭/3] to go to the beginning of the next message.
Deleting a message	While a message is playing, press [⏻] or the DELETE soft key to delete it. The message is permanently deleted.	While a message is playing, press [⏻/4] to delete it. The message is permanently deleted.
Deleting all messages	With the phone in standby, press [⏻] to delete all messages. When the answering machine asks you to confirm, press [⏻] again. All messages are permanently deleted.	Not available
Stopping a message review	Press [⏻/exit] to stop a message playback and return to standby.	Press [⏻/5] or the STOP soft key to stop a message playback. Press [⏻] to exit the answering machine and return to standby.

Note:

- You cannot delete unheard messages. If you try to delete messages before listening to them, the answering machine will beep and say "Please playback all messages."
- If you press [**⏮**] or the **⏮** soft key on the base during the first two seconds (or press [**⏮/1**] on the handset during the first four seconds) of a message, the answering machine goes back to the previous message.

Screening Calls

Your phone allows you to listen to callers leaving a message without answering the phone. You can always hear callers from the base speaker. To screen an incoming call from the handset and base:

From the base	From the handset
<ol style="list-style-type: none">1) After the answering machine answers, the base speaker will let you hear the calls at the machine records the messages.2) To answer the call, press [MUTE].3) To mute the call screen, press the MUTE soft key, or [MUTE]. To cancel muting, press the SCREEN soft key.	<ol style="list-style-type: none">1) Press the SCREEN soft key when the answering machine is answering. If another station is screening a call, you will hear a beep and you will not be able to screen the call.2) To answer the call, press [MUTE].3) To mute the call screen, press the MUTE soft key. To cancel muting press the SCREEN soft key.

Recording a Conversation

You can record a conversation between 2 seconds and 10 minutes long from the handset or the base. These recorded conversations are treated just like regular messages. When the answering machine is full, **Full** will appear on the base LCD and recording will be terminated. You can not record 3-way calls or intercom conversations with this feature.

	From the base	From the handset
Starting a Recording	<ol style="list-style-type: none">1) During a conversation, press the MENU soft key then select CALL RECORD. Press the OK soft key.2) The LCD will display RE- CORDING CALL. A confirmation tone that can be heard by both parties sounds during recording.	<ol style="list-style-type: none">1) During a conversation, press the RECORD soft key. (If the CWDX is set to on, press the MENU soft key, and then [▼] or [▲] key to select CALL RECORD. Press the OK soft key.)2) RECORDING CALL appears on the display. A confirmation tone that can be heard by both parties sounds during recording.
Stopping a recording	<ol style="list-style-type: none">1) Press the MENU soft key then select CALL RECORD. Press the OK soft key.2) The LCD will display STOP RECORDING. You will hear a confirmation tone.	<ol style="list-style-type: none">1) Press the RECORD soft key. (If the CWDX is set to on, press the MENU soft key, and then [▼] or [▲] key to select CALL RECORD. Press the OK soft key.)2) STOP RECORDING appears on the display, and you will hear a confirmation tone.

Note:

- Every state has different regulations governing the recording of conversations over the telephone. Make sure to check your local, state and federal laws before using this product to record any telephone conversation in order to determine that your use is in compliance with such laws or guidelines.
- If the recording memory is full, UNAVAILABLE appears in the display. You cannot record a conversation until you clear some messages from the memory.
- You cannot record intercom conversations.

Recording a Voice Memo

The voice memo feature allows you to record messages that are between 2 seconds and 4 minutes long. You might want to use this feature to leave messages for other members of your household instead of written notes.

	From the base	From the handset
Starting a memo	<ol style="list-style-type: none">1) With the phone in standby, press the RECORD soft key, and then the START soft key.2) The answering machine announces "Record memo message." Begin your message after this announcement and a beep.	<ol style="list-style-type: none">1) With the phone in standby, press the  soft key.2) REMOTE ANSWERING MACHINE OPERATION appears on the display, and the answering machine announces the time, and the number of new and old messages.3) Press [7]. The answering machine announces "Record memo message." Begin your message after this announcement.

	From the base	From the handset
Stopping a memo	<ol style="list-style-type: none"> 1) Press the STOP soft key. 2) You hear a confirmation tone, and the answering machine returns to standby. 	<ol style="list-style-type: none"> 1) Press [7]. 2) You hear a confirmation tone, and the answering machine waits for your next command. 3) Press [▶/2] to hear the message you just recorded or [⏏] to exit and return to standby.

Message Alert

The Message Alert feature sounds a short alert tone whenever you have a new message. When a new message is received and Message Alert is on, the alert tone will sound every 15 seconds. Set the Message Alert to on or off by using **MENU**. To activate the message alert, see page 56 for details.

When all new messages are played back (see page 58), the Message Alert tone will automatically deactivate. The tone will not deactivate until all new messages are played back. To quickly turn off the Message Alert tone, press any key on the base.

Remotely Operating Your Answering Machine

You can access your answering machine while you are away from home to check, play, delete messages, or even record a new greeting message or to turn your answering machine on and off.

Note:

- The answering machine will only playback messages for four minutes and then it returns to the command-waiting mode. To continue playing your messages, press **[0]** then **[2]** again within 15 seconds.
- If you enter an incorrect security code three times, you will hear a beep and the answering machine will return to standby.

To operate from a remote location, use any touch-tone telephone and follow these steps:

- 1) Call your telephone number and wait for the answering machine to answer. If the answering machine is off, it will answer after about 10 rings and series of beeping sounds.
- 2) During the greeting message (or a series of beeps when the answering machine is off), press **[0]** and enter your PIN code within 2 seconds (see "Setting a Security Code or Personal Identification Number (PIN)" on page 56).
- 3) The answering machine announces the current time and the number of messages stored in memory. You hear "To play incoming messages, press zero-two. For help, press one-zero." You will hear a beep.
- 4) Enter a remote command within 15 seconds, each command there after must be entered within 2 seconds. You may select a command from the following chart:

Remote Commands

Command	Function	Command	Function
0 then 1	Repeat a Message*	0 then 6	Answering Machine On
0 then 2	Playback Messages	0 then 7	Memo Record/Stop**
0 then 3	Skipping a Message	0 then 8	Greeting Record/Stop**
0 then 4	Deleting a Message	0 then 9	Answer Machine Off
0 then 5	Stop Operation	1 then 0	Help Guidance

* To Repeat a Message, press **[0]** then **[1]** within four seconds to repeat the previous message, or press **[0]** then **[1]** after four seconds to repeat the current message.

** For the Memo Record and Greeting Record/Stop, the first time you enter the corresponding command, it starts the Recording. If you want to stop the recording, press **[0]** then **[7]**, **[8]**, or **[5]**.

- 5) When you finish, you will hear intermittent beeps indicating that the answering machine is in the command waiting mode. You can enter another command from the chart, or you can hang up to exit the answering machine.
- 6) When you hang up, the answering machine automatically returns to its normal standby setting.

Maintenance

Specifications

Operating Temperature	0° C to 50° C (32° F to 122° F)
AC Adapter Part Number	Base: AD-830 Charging Cradle: AD-0005
Input Voltage	Base: 120V AC, 60 Hz Charging Cradle: 120V AC, 60 Hz
Output Voltage	Base: 9V DC @ 400mA Charging Cradle: 9V DC @ 210mA
Battery Part Number	BT-446
Capacity	3.6V DC @ 800mAh

Notes:

- Use only the supplied AD-830 and AD-0005 AC adapters.
- Do not use any other AC adapter.
- Do not place the power cord where it creates a trip hazard or where it could become chafed and create a fire or electrical hazard.
- Do not place the base in direct sunlight or subject it to high temperatures.

Battery Replacement and Handling

With average use, your phone's battery should last approximately one year. To order replacement batteries, please contact Uniden's Parts Department. The contact information is listed on the back cover page.

Cleaning the Battery Contacts

To maintain a good charge, clean the charging contacts on the handset once a month. Dampen a cloth with plain water. Gently rub the damp cloth over the charging contacts until all visible dirt is removed. Dry the contacts thoroughly before returning the handset to the charging cradle.

Caution: Do not use paint thinner, alcohol, or other chemical products. Doing so may discolor the surface of the telephone and damage the finish.

Warning

To avoid the risk of personal injury or property damage from fire or electrical shock, use only Uniden AD-830 (9V 400mA) and AD-0005 AC adapters and Uniden BT-446 battery pack with your phone.

Caution:

- Use only the specified Uniden battery pack BT-446.
- Do not remove the batteries from the handset to charge them.
- Never throw the battery into a fire, disassemble, or heat them.
- Do not remove or damage the battery casing.
- A replacement Uniden adapter or battery may be purchased by calling Uniden's Parts department. See back cover page for contact information.

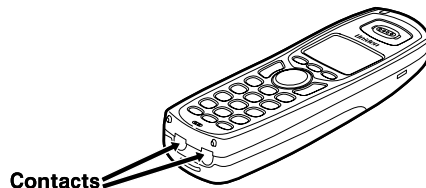

Low Battery Alert

When the battery pack is very low, the phone is programmed to eliminate functions in order to save power. When Low Battery appears in the display and the phone is in standby, none of the keys will operate. If you are on a call, complete your conversation as quickly as possible, and return the handset to the charging cradle.

The battery pack needs to be charged when the empty battery icon appears.

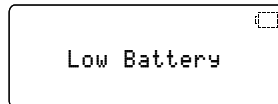

Talk and Standby Times

With average use, your handset battery provides approximately 5 hours of talk time and approximately 7 days of standby time. When your handsets are not being used and are left off of their charging cradles, the battery will gradually discharge. You can achieve optimum battery life and performance by returning the handset to the charging cradle after each use. If the handset is left off of the charging cradle, the actual talk time duration will be reduced respective to the amount of time the handset is off of the charging cradle.

Troubleshooting

Resetting the Handset

You may need to reset your handset in the following instances:

- You lose a handset and purchase a new one. When you try and register to your existing base you get registration failure.
- You are unable to register any handsets to the base.
- You had a base which needed to be exchanged by the manufacturer. When you register your existing handsets to the base, the handsets say #3 and #4, but you only have 2 handsets.
- When you are instructed to by the one of the manufacturer's call center representatives.

To reset, do the following:

- 1) Press and hold **[*]** and **[#]** for more than 5 seconds. Select DEREGISTER HS.
- 2) WHICH HANDSET? appears. Select the handset that you want to de-register, and press the **OK** soft key.
- 3) DEREGISTER HS appears. Select YES, and press the **OK** soft key.
- 4) ARE YOU SURE? appears. Select YES, and press the **OK** soft key. You will hear a confirmation tone. The handset will clear its registration information from the base, and then delete its own base information.

MODELS VARY! PLACE HANDSET ON THE BASE FOR REGISTRATION OR REFER TO OWNER'S MANUAL. To re-register the handset to the base (see page 25).

If the handset cannot contact the base, it will display OUT OF RANGE. Make sure the handset is in range of the base and the base is connected to power.

Note: It is also possible to reset the handset back to its original factory settings. All changes including Caller ID information will be erased. For more information on resetting the handset back to factory settings and when you need to do this, see www.uniden.com or call our Customer Service Hotline. See back cover page for contact information.

Resetting the Handset without the Base

If your original base is not available for some reason (for example, it is lost or somehow incapacitated), you can still reset the handset and use it with another base.

- 1) Press and hold **[*]** and **[#]** for more than 5 seconds.
- 2) Move the cursor to select **BASE UNAVAILABLE** and then press the **OK** soft key. **BASE UNAVAILABLE** appears.
- 3) Move the cursor to select **YES**, and then press the **OK** soft key. **ARE YOU SURE?** appears.
- 4) Move the cursor to select **YES**, and then press the **OK** soft key. You will hear a confirmation tone. The handset will delete its own base information without trying to contact the base. When the base information is deleted, the handset displays **MODELS VARY! PLACE HANDSET ON THE BASE FOR REGISTRATION OR REFER TO OWNER'S MANUAL**. Register the handset to the new base (see page 25).

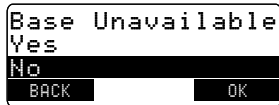

Changing the Digital Security Code

The digital security code is an identification code used to connect the handset and the base. Your unit ships from the manufacturer with a preset security code. Resetting this code is not normally necessary. In the rare situation that you suspect another cordless telephone is using the same security code or if you are instructed to change this code by a manufacturer's Call Center Representative, you can change the code by:

1. Perform "Resetting the Handset" for all of your handsets.
2. Re-register each handset by following the steps on page 25.

Traveling Out of Range

During a call, if you move your handset too far away from your base, noise may increase. If you pass the range limits of the base, you will hear a beep and see **OUT OF RANGE** on the display, and then the handset returns to standby.

Common Issues

If your phone is not performing to your expectations, please try these simple steps first. If these steps do not solve your problem, please call our Customer Hotline. See back cover page for contact information.

Symptom	Suggestion
The charge LED won't illuminate when the handset is placed in the cradle.	<ul style="list-style-type: none">• Make sure the AC adapter is plugged into the base or the charger (if you have more than one handset) and wall outlet.• Make sure the handset is properly seated in the cradle.• Make sure the charging contacts on the handset are clean.
The audio sounds weak.	<ul style="list-style-type: none">• Move the handset and/or base away from metal objects or appliances and try again.• Make sure that you are not too far from the base.
Can't make or receive calls.	<ul style="list-style-type: none">• Make sure that you are not too far from the base.• Make sure the line is not in use. If an outside call is already using a line, you cannot use that line to make another outside call.• Check both ends of the base telephone line cord.• Make sure the AC adapter is plugged into the base and wall outlet.• Disconnect the AC adapter and reconnect.• Change the Digital Security Code (see page 70).
The handset doesn't ring or receive a page.	<ul style="list-style-type: none">• Make sure that you are not too far from the base.• Charge the battery in the handset for at least 15-20 hours by placing the handset on the base or charging cradle.• Change the Digital Security Code (see page 70).
Severe noise interference.	<ul style="list-style-type: none">• Keep the handset away from microwave ovens, computers, remote control toys, wireless microphones, alarm systems, intercoms, room monitors, fluorescent lights, and electrical appliances.• Move to another location or turn off the source of interference.

Symptom	Suggestion
The Caller ID does not display.	<ul style="list-style-type: none"> • The call was placed through a switchboard. • Call your telephone provider to verify your Caller ID service is current. There may be a problem with your Caller ID service.
You cannot register the handset at the base.	<ul style="list-style-type: none"> • Charge the battery pack in the handset for 15-20 hours. • Change the Digital Security Code (see page 70). • Make sure you have not stored 10 handsets already.
The handset doesn't communicate with other handsets.	<ul style="list-style-type: none"> • Change the Digital Security Code (see page 70). • Make sure that you have registered all handsets.
An extra handset can't join the conversation.	<ul style="list-style-type: none"> • Make sure there are not 2 handsets already using the conference feature. • Make sure that another station is not in privacy mode.
The Room Monitor feature does not work.	<ul style="list-style-type: none"> • Make sure to place the handset(s) within the range of the base. • Make sure that the Room Monitor feature is turned on.
The answering machine does not work.	<ul style="list-style-type: none"> • Make sure the base is plugged in. • Make sure that the answering machine is turned on. • Make sure that the message record time is not set to Announce only (see page 55).
Messages are incomplete.	<ul style="list-style-type: none"> • The incoming messages may be too long. Remind callers to leave a brief message. • The memory may be full. Delete some or all of the saved messages.
There is no sound on the base or handset speaker during call monitoring or message playback.	<ul style="list-style-type: none"> • Adjust the speaker volume on the base or handset. • Make sure the call screen feature is set to on.

Symptom	Suggestion
Cannot access remote features from another touchtone phone.	<ul style="list-style-type: none">• Make sure you are using the correct PIN number.• Make sure that the touch-tone phone you are using can transmit the tone for at least two seconds. If it cannot, you may have to use another phone to access your phone.
Time stamp cannot be heard.	<ul style="list-style-type: none">• Make sure you have set the time (see "Setting the Date and Time" on page 21).

Liquid Damage

Moisture and liquid can damage your cordless phone. Follow the suggestions below if your phone gets wet.

Exterior

If the handset or base is exposed to moisture or liquid, but only the exterior plastic housing is affected, wipe off the liquid, and use as normal.

Interior

If moisture or liquid has entered the plastic housing (i.e. liquid can be heard in the phone or liquid has entered the handset battery compartment or vent openings on the base):

Handset:

1. Remove the battery cover and leave it off for ventilation.
2. Disconnect the battery pack. Leave the battery cover off and the battery pack disconnected for at least 3 days.
3. Once the handset is completely dry, reconnect the battery pack and the battery cover.
4. Recharge the handset's battery pack for 15 to 20 hours before using.

IMPORTANT: You must unplug the telephone line while recharging the battery packs to avoid charge interruption.

Base:

1. Disconnect the AC adapter from the base, cutting off electrical power.
2. Disconnect the telephone cord from the base.
3. Let dry for at least 3 days.

CAUTION: DO NOT use a microwave oven to speed up the drying process. This will cause permanent damage to the handset, base and the microwave oven. After following these steps, if your cordless telephone does not work, please call our Customer Service Hotline. See back cover page for contact information.

Precautions!

Before you read anything else, please observe the following:

Warning!

Uniden America Corporation DOES NOT represent this unit to be waterproof. To reduce the risk of fire, electrical shock, or damage to the unit, DO NOT expose this unit to rain or moisture.

Rechargeable Nickel-Metal-Hydride Battery Warning

- This equipment contains a rechargeable Nickel-Metal-Hydride battery.
- The rechargeable batteries contained in this equipment may explode if disposed of in a fire.
- Nickel is a chemical known to State of California to cause cancer.
- Do not short-circuit the battery.
- Do not charge the rechargeable battery used in this equipment in any charger other than the one specified in the owner's manual. Using another charger may damage the battery or cause the battery to explode.

Rechargeable Batteries Must Be Recycled or Disposed of Properly.



The exclamation point within an equilateral triangle is intended to alert the user to the presence of important operating and maintenance (servicing) instructions in the literature accompanying the appliance.

Uniden works to reduce lead content in our PVC coated cords in our products and accessories.

Warning!

The cords on this product and/or accessories contain lead, a chemical known to the State of California to cause birth defects or other reproductive harm. Wash hands after handling.

Important Safety Instructions

When using your telephone equipment, basic safety precautions should always be followed to reduce the risk of fire, electric shock and injury to persons, including the following:

1. Do not use this product near water, for example, near a bath tub, wash bowl, kitchen sink or laundry tub, in a wet basement or near a swimming pool.
2. Avoid using a telephone (other than a cordless type) during an electrical storm. There may be a remote risk of electric shock from lightning.
3. Do not use the telephone to report a gas leak in the vicinity of the leak.
4. Use only the power cord and batteries indicated in this manual. Do not dispose of batteries in a fire. They may explode. Check with local authorities for possible battery disposal instructions.
5. Do not disassemble any component of this product.

SAVE THESE INSTRUCTIONS

CAUTION

Risk of explosion if battery is replaced by an incorrect type. Dispose of used batteries according to the instructions. Do not open or mutilate the battery, and disconnect the battery before shipping this product.

The FCC Wants You To Know

This equipment complies with Part 68 of the FCC rules and the requirements adopted by the ACTA. On the bottom of this equipment is a label that contains, among other information, a product identifier in the format US:AAAEQ##TXXXX. If requested, this number must be provided to the telephone company.

An applicable Universal Service Order Codes (USOC) certification for the jacks used in this equipment is provided (i.e., RJ11C) in the packaging with each piece of approved terminal equipment. A plug and jack used to connect this equipment to the premises wiring and telephone network must comply with the applicable FCC Part 68 rules and requirements adopted by the ACTA. A compliant telephone cord and modular plug is provided with this product. It is designed to be connected to a compatible modular jack that is also compliant. See installation instructions for details.

The REN is used to determine the number of devices that may be connected to a telephone line. Excessive RENs on a telephone line may result in the devices not ringing in response to an incoming call. In most but not all areas, the sum of RENs should not exceed five (5.0). To be certain of the number of devices that may be connected to a line, as determined by the total RENs, contact the telephone provider. For products approved after July 23, 2001, the REN for this product is part of the product identifier that has the format US:AAAEQ##TXXXX. The digits represented by ## are the REN without a decimal point (e.g., 03 is a REN of 0.3). For earlier products, the REN is separately shown on the label.

If this equipment causes harm to the telephone network, the telephone company will notify you in advance that temporary discontinuance of service may be required. But if advance notice isn't practical, the telephone company will notify the customer as soon as possible. Also, you will be advised of your right to file a complaint with the FCC if you believe it is necessary.

The telephone company may make changes in its facilities, equipment, operations or procedures that could affect the operation of the equipment. If this happens the telephone company will provide advance notice in order for you to make necessary modifications to maintain uninterrupted service.

Please follow instructions for repairing, if any (e.g. battery replacement section); otherwise do not substitute or repair any parts of the device except as specified in this manual. Connection to party line service is subject to state tariffs. Contact the state public utility commission, public service commission or corporation commission for information. This equipment is hearing aid compatible.

Should you experience trouble with this equipment, please contact Uniden customer service at 800-297-1023. If the equipment is causing harm to the telephone network, the telephone company may request that you disconnect the equipment until the problem is resolved.

NOTICE: According to telephone company reports, AC electrical surges, typically resulting from lightning strikes, are very destructive to telephone equipment connected to AC power sources. To minimize damage from these types of surges, a surge arrestor is recommended.

Changes or modifications to this product not expressly approved by Uniden, or operation of this product in any way other than as detailed by the owner's manual, could void your authority to operate this product.

This device complies with part 15 of the FCC rules. Operation is subject to the following two conditions: (1) This device may not cause harmful interference, and (2) This device must accept any interference received, including interference that may cause undesired operation. Privacy of communications may not be ensured when using this phone.

To insure the safety of users, the FCC has established criteria for the amount of radio frequency energy various products may produce depending on their intended usage. This product has been tested and found to comply with the FCC's exposure criteria. For body worn operation, the FCC RF exposure guidelines were also met when used with the Uniden accessories supplied or designed for this product. Use of other accessories may not ensure compliance with FCC RF exposure guidelines and should be avoided.

Radio Interference

Radio interference may occasionally cause buzzing and humming in your cordless handset, or clicking noises in the base. This interference is caused by external sources such as TV, refrigerator, vacuum cleaner, fluorescent lighting, or electrical storm. Your unit is NOT DEFECTIVE. If these noises continue and are too distracting, please check around your home to see what appliances may be causing the problem. In addition, we recommend that the base not be plugged into a circuit that also powers a major appliance because of the potential for interference. Be certain that the antenna on the unit is fully extended when needed. In the unlikely event that you consistently hear other voices or distracting transmissions on your phone, you may be receiving radio signals from another cordless telephone or other source of interference. If you cannot eliminate this type of interference, you need to change to a different channel.

Finally, it should be noted that some cordless telephones operate at frequencies that may cause interference to nearby TVs and VCRs. To minimize or prevent such interference, the base of the cordless telephone should not be placed near or on top of a TV or VCR. If interference is experienced, moving the cordless telephone farther away from the TV or VCR will often reduce or eliminate the interference.

Cordless Telephone Privacy

Cordless telephones are radio devices. Communications between the handset and base of your cordless telephone are accomplished by means of radio waves which are broadcast over the open airways. Because of the inherent physical properties of radio waves, your communications can be received by radio receiving devices other than your own cordless telephone unit. Consequently, any communications using your cordless telephone may not be private.

I.C. Notice

Terminal Equipment

NOTICE: This equipment meets the applicable Industry Canada Terminal Equipment Technical Specifications. This is confirmed by the registration number. The abbreviation, IC, before the registration number signifies that registration was performed based on a Declaration of Conformity indicating that Industry Canada technical specifications were met. It does not imply that Industry Canada approved the equipment.

NOTICE: The Ringer Equivalence Number (REN) for this terminal equipment is marked on the equipment itself. The REN assigned to each terminal equipment provides an indication of the maximum number of terminals allowed to be connected to a telephone interface. The termination on an interface may consist of any combination of devices subject only to the requirement that the sum of the Ringer Equivalence Numbers of all the devices does not exceed five.

RADIO EQUIPMENT

The term "IC:" before the radio certification number only signifies that Industry Canada technical specifications were met.

Operation is subject to the following two conditions: (1) this device may not cause interference, and (2) this device must accept any interference, including interference that may cause undesired operation of the device. "Privacy of communications may not be ensured when using this telephone."

One Year Limited Warranty

Important: Evidence of original purchase is required for warranty service. **WARRANTOR:** UNIDEN AMERICA CORPORATION ("Uniden") **ELEMENTS OF WARRANTY:** Uniden warrants, for one year, to the original retail owner, this Uniden Product to be free from defects in materials and craftsmanship with only the limitations or exclusions set out below. **WARRANTY DURATION:** This warranty to the original user shall terminate and be of no further effect 12 months after the date of original retail sale. The warranty is invalid if the Product is (A) damaged or not maintained as reasonable or necessary, (B) modified, altered, or used as part of any conversion kits, subassemblies, or any configurations not sold by Uniden, (C) improperly installed, (D) serviced or repaired by someone other than an authorized Uniden service center for a defect or malfunction covered by this warranty, (E) used in any conjunction with equipment or parts or as part of any system not manufactured by Uniden, or (F) installed or programmed by anyone other than as detailed by the owner's manual for this product. **STATEMENT OF REMEDY:** In the event that the product does not conform to this warranty at any time while this warranty is in effect, warrantor will either, at its option, repair or replace the defective unit and return it to you without charge for parts, service, or any other cost (except shipping and handling) incurred by warrantor or its representatives in connection with the performance of this warranty. Warrantor, at its option, may replace the unit with a new or refurbished unit. **THE LIMITED WARRANTY SET FORTH ABOVE IS THE SOLE AND ENTIRE WARRANTY PERTAINING TO THE PRODUCT AND IS IN LIEU OF AND EXCLUDES ALL OTHER WARRANTIES OF ANY NATURE WHATSOEVER, WHETHER EXPRESS, IMPLIED OR ARISING BY OPERATION OF LAW,**

INCLUDING, BUT NOT LIMITED TO ANY IMPLIED WARRANTIES OF MERCHANTABILITY OR FITNESS FOR A PARTICULAR PURPOSE. THIS WARRANTY DOES NOT COVER OR PROVIDE FOR THE REIMBURSEMENT OR PAYMENT OF INCIDENTAL OR CONSEQUENTIAL DAMAGES. Some states do not allow this exclusion or limitation of incidental or consequential damages so the above limitation or exclusion may not apply to you.

LEGAL REMEDIES: This warranty gives you specific legal rights, and you may also have other rights which vary from state to state. This warranty is void outside the United States of America and Canada. **PROCEDURE FOR OBTAINING PERFORMANCE OF WARRANTY:** If, after following the instructions in the owner's manual you are certain that the Product is defective, pack the Product carefully (preferably in its original packaging). Disconnect the battery from the Product and separately secure the battery in its own separate packaging within the shipping carton. The Product should include all parts and accessories originally packaged with the Product. Include evidence of original purchase and a note describing the defect that has caused you to return it. The Product should be shipped freight prepaid, by traceable means, to warrantor at:

Uniden America Service

4700 Amon Carter Blvd.
Fort Worth, TX 76155

Index

A

Answering a Call.....	35
Answering Machine	
Handset operation	51
Using the handset & base menu	51
When away from home	64
Any Key Answer	34
Area Code	49
AutoTalk.....	34

B

Base Unavailable.....	70
Battery Contacts Maintenance	67
Battery Replacement and Handling	67

C

Caller ID on Call Waiting	22
Call screen.....	56, 60
Call Waiting Deluxe	22, 39
Conferencing	42
Controls Parts of the Phone	7

D

Date and Time	21
Deleting a Redial Record.....	40
Deleting Caller ID Numbers.....	38
Deregistration	26
Dial Mode	20
Digital Security Code	70
DirectLink.....	45
Do Not Disturb.....	44

E

Earpiece Volume	41
Entering Text from the Phone.....	13

G

Greetings	
Deleting.....	54
Recording	53
Selecting	54

H

Handset Banner.....	32
Hanging up	35

I

Important Safety Instructions.....	76
Installing the Belt Clip.....	19

Installing the Phone.....	14
Installing the Rechargeable Battery	17

K

Key Touch Tone	23
----------------------	----

L

Language.....	21
LCD contrast.....	23
Liquid Damage	74
Low Battery Alert	68

M

Maintenance	66
Making a call.....	35
Making a call from a Caller ID Record.....	38
Making a call with Speed Dial.....	36
Muting the Microphone.....	44
Muting the Ringer	44

O

Optional Headset.....	49
Out of Range	70

P		T	
Personal identification number		T-coil.....	41
(PIN).....	56	Talk and Standby Times	68
Personal Ring	22	The FCC Wants You To Know	77
Phonebook	27		
Placing a Call on Hold	42	V	
Privacy Mode.....	44	Voice Memo.....	62
Product Overview	6		
R		W	
Recording a call.....	61	Wall Mounting the Base.....	15
Redialing a Number.....	40		
Register Handset.....	25		
Resetting the Handset.....	69		
Ringer Tones	33		
Ringer Volume	41		
Room/Baby Monitor.....	47		
S			
Screening calls	56, 60		
Security code			
Answering system.....	56		
Seven-Digit Dialing	49		
Speaker Volume	41		
Speed Dial	36		

Remote Operation Card

CUT

REMOTE OPERATION CARD

Unlden®

Remote access away from home

1. Call your phone number from a touch-tone phone.
2. During the outgoing message, press 0 and enter your PIN code. The answering machine announces the number of messages stored in memory and the voice prompts.
3. To quit, hang up the phone.

Turn on the answering machine remotely

1. Call your phone and let it ring 10 times until you hear a beep.
2. Press 0 and then enter your PIN code.
3. Press 0 then 5 to stop the announcement.
4. Press 0 then 6 to turn the answering machine on.

CUT

REMOTE OPERATION CARD

Unlden®

Remote access away from home

1. Call your phone number from a touch-tone phone.
2. During the outgoing message, press 0 and enter your PIN code. The answering machine announces the number of messages stored in memory and the voice prompts.
3. To quit, hang up the phone.

Turn on the answering machine remotely

1. Call your phone and let it ring 10 times until you hear a beep.
2. Press 0 and then enter your PIN code.
3. Press 0 then 5 to stop the announcement.
4. Press 0 then 6 to turn the answering machine on.

CUT

REMOTE OPERATION CARD

Unlden®

Remote access away from home

1. Call your phone number from a touch-tone phone.
2. During the outgoing message, press 0 and enter your PIN code. The answering machine announces the number of messages stored in memory and the voice prompts.
3. To quit, hang up the phone.

Turn on the answering machine remotely

1. Call your phone and let it ring 10 times until you hear a beep.
2. Press 0 and then enter your PIN code.
3. Press 0 then 5 to stop the announcement.
4. Press 0 then 6 to turn the answering machine on.

CUT

REMOTE OPERATION CARD

Unlden®

Remote access away from home

1. Call your phone number from a touch-tone phone.
2. During the outgoing message, press 0 and enter your PIN code. The answering machine announces the number of messages stored in memory and the voice prompts.
3. To quit, hang up the phone.

Turn on the answering machine remotely

1. Call your phone and let it ring 10 times until you hear a beep.
2. Press 0 and then enter your PIN code.
3. Press 0 then 5 to stop the announcement.
4. Press 0 then 6 to turn the answering machine on.

CUT

Task	Key
Repeat a Message	<input type="radio"/> 0 <input type="radio"/> 1
Playing incoming Messages	<input type="radio"/> 0 <input type="radio"/> 2 abc
Skipping a Message	<input type="radio"/> 0 <input type="radio"/> 3 def
Deleting a Message	<input type="radio"/> 0 <input type="radio"/> 4 ghi
Stop Operation	<input type="radio"/> 0 <input type="radio"/> 5 jkl
Answering Machine On	<input type="radio"/> 0 <input type="radio"/> 6 mno
Memo Record/Stop	<input type="radio"/> 0 <input type="radio"/> 7 pqrs
Greeting Message Record/Stop	<input type="radio"/> 0 <input type="radio"/> 8 tuv
Answering Machine Off	<input type="radio"/> 0 <input type="radio"/> 9 wxyz
Help	<input type="radio"/> 1 <input type="radio"/> 0 oper

CUT

Task	Key
Repeat a Message	<input type="radio"/> 0 <input type="radio"/> 1
Playing incoming Messages	<input type="radio"/> 0 <input type="radio"/> 2 abc
Skipping a Message	<input type="radio"/> 0 <input type="radio"/> 3 def
Deleting a Message	<input type="radio"/> 0 <input type="radio"/> 4 ghi
Stop Operation	<input type="radio"/> 0 <input type="radio"/> 5 jkl
Answering Machine On	<input type="radio"/> 0 <input type="radio"/> 6 mno
Memo Record/Stop	<input type="radio"/> 0 <input type="radio"/> 7 pqrs
Greeting Message Record/Stop	<input type="radio"/> 0 <input type="radio"/> 8 tuv
Answering Machine Off	<input type="radio"/> 0 <input type="radio"/> 9 wxyz
Help	<input type="radio"/> 1 <input type="radio"/> 0 oper

CUT

Task	Key
Repeat a Message	<input type="radio"/> 0 <input type="radio"/> 1
Playing incoming Messages	<input type="radio"/> 0 <input type="radio"/> 2 abc
Skipping a Message	<input type="radio"/> 0 <input type="radio"/> 3 def
Deleting a Message	<input type="radio"/> 0 <input type="radio"/> 4 ghi
Stop Operation	<input type="radio"/> 0 <input type="radio"/> 5 jkl
Answering Machine On	<input type="radio"/> 0 <input type="radio"/> 6 mno
Memo Record/Stop	<input type="radio"/> 0 <input type="radio"/> 7 pqrs
Greeting Message Record/Stop	<input type="radio"/> 0 <input type="radio"/> 8 tuv
Answering Machine Off	<input type="radio"/> 0 <input type="radio"/> 9 wxyz
Help	<input type="radio"/> 1 <input type="radio"/> 0 oper

CUT

Task	Key
Repeat a Message	<input type="radio"/> 0 <input type="radio"/> 1
Playing incoming Messages	<input type="radio"/> 0 <input type="radio"/> 2 abc
Skipping a Message	<input type="radio"/> 0 <input type="radio"/> 3 def
Deleting a Message	<input type="radio"/> 0 <input type="radio"/> 4 ghi
Stop Operation	<input type="radio"/> 0 <input type="radio"/> 5 jkl
Answering Machine On	<input type="radio"/> 0 <input type="radio"/> 6 mno
Memo Record/Stop	<input type="radio"/> 0 <input type="radio"/> 7 pqrs
Greeting Message Record/Stop	<input type="radio"/> 0 <input type="radio"/> 8 tuv
Answering Machine Off	<input type="radio"/> 0 <input type="radio"/> 9 wxyz
Help	<input type="radio"/> 1 <input type="radio"/> 0 oper

Memo

Memo

At Uniden, we'll take care of you!

Thank you for purchasing a Uniden product. If you have any questions or problems, **please do not return this product to the place of purchase.**

Having Trouble? Our customer care specialists are here to help you! Visit our website at **www.uniden.com** or call our Customer Service Hotline at **1-800-297-1023**, Monday through Friday, 7 AM to 7 PM or Saturday/Sunday, 9 AM to 5 PM, CST. The Customer Service Hotline is closed on holidays.

Need A Part? To order headsets, additional handsets, replacement batteries, or other accessories, visit our website at **www.uniden.com** or call **1-800-554-3988**, Monday through Friday, 8 AM to 5 PM, CST.

Help For Our Customers with Special Needs If you need special assistance due to a disability, or have questions on the accessibility features of this product, please call **1-800-874-9314 (voice or TTY)**.

Uniden®

May be covered under one or more of the following U.S. patents:

4,797,916	5,381,460	5,426,690	5,434,905	5,491,745	5,493,605
5,533,010	5,574,727	5,581,598	5,650,790	5,660,269	5,661,780
5,663,981	5,671,248	5,696,471	5,717,312	5,732,355	5,754,407
5,758,289	5,768,345	5,787,356	5,794,152	5,801,466	5,825,161
5,864,619	5,893,034	5,912,968	5,915,227	5,929,598	5,930,720
5,960,358	5,987,330	6,044,281	6,070,082	6,125,277	6,253,088
6,314,278	6,418,209	6,618,015	6,671,315	6,714,630	6,782,098
6,788,920	6,788,953	6,839,550	6,889,184	6,901,271	6,907,094
6,914,940					

Uniden® | A World Without Wires®

**VISIT
WWW.UNIDEN.COM
TO REGISTER YOUR
PRODUCT**

© 2005 Uniden America Corporation, Fort Worth, Texas. Contains additional foreign articles. Printed in China.

Free Manuals Download Website

<http://myh66.com>

<http://usermanuals.us>

<http://www.somanuals.com>

<http://www.4manuals.cc>

<http://www.manual-lib.com>

<http://www.404manual.com>

<http://www.luxmanual.com>

<http://aubethermostatmanual.com>

Golf course search by state

<http://golfingnear.com>

Email search by domain

<http://emailbydomain.com>

Auto manuals search

<http://auto.somanuals.com>

TV manuals search

<http://tv.somanuals.com>