

Uniden[®]

XC631 Plus

Add-on Handset and Charging Base

Operating Guide

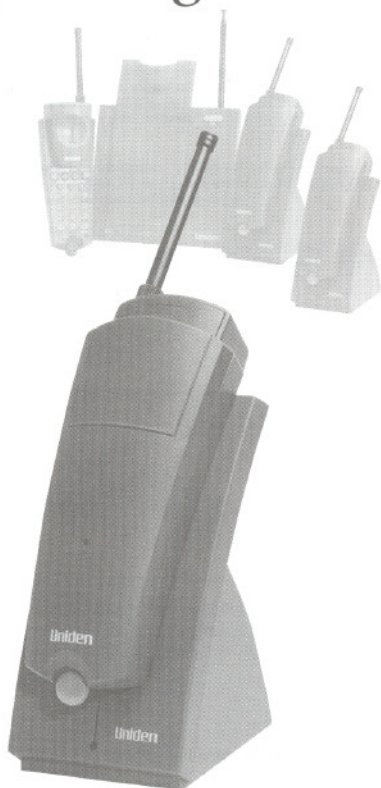

Unleash the Power

This page intentionally left blank.

CONTENTS

CONTENTS

Important Notes	5
Please Read this first	5
Safety Information	7
Battery Safety Precautions	9
Parts Checklist	11
Features	13
Handset Functions	15
Installation	17
Selecting the Installation Location	17
Installing the Battery Pack	18
Charging the Battery Pack	18
Low Battery Indicator	19
Cleaning the Battery Contacts	19
Using Your XC631 Plus	21
Registering your Handset for the first time	21
Digital Security Code	21
To Change or Set a new Digital Security Code	21
Placing a Call	22
Selecting a Channel	22
Using the Flash/Redial Button	23
Redialing the Last Number Called	23
Using the Flash Key with Call Waiting	23
Setting the Handset Receiver Volume	24
Using the Hold Button	24
Answering a Call	24
Transferring a Call to Another Handset	25
Storing a Number into the Memory	25
Storing a Mixed (Tone/Pulse Number	26
Storing Long Numbers in Memory	27
Dialing a Stored Number	28
Using the Page Feature	28
Using the Call Waiting Feature	28
Troubleshooting	29
Important Electrical Considerations	31
Operating Range	31
Radio Interference	32
More than One Cordless Telephone	32
Specifications	33
Warranty	35

This page intentionally left blank.

IMPORTANT NOTES

PLEASE READ THIS FIRST

Thank you for purchasing your XC631 Plus Add on Handset and Charging Base.

This product has been designed to expand your existing XC631 Cordless Telephone to give you the convenience of multiple Handset use. Please refer to the following Features Section for the benefits you can now enjoy.

THE NEW HANDSET MUST BE REGISTERED TO THE MAIN BASE UNIT BEFORE USING FOR THE FIRST TIME.

PLEASE REFER TO PAGE 21 "Registering your Handset for first time use".

NOTE:



Each Handset can be charged on the XC631 Plus Charging Base or the XC631 Base Unit. The XC631 Plus Charging Base is smaller than your existing XC631 Base Unit and does not require a telephone connection.

The XC631 Plus can not be used separately. It must be used in conjunction with your XC631 Cordless telephone.

We have designed your telephone to conform to Australian Communications Authority (ACA) regulations, and you can connect it to most telephone lines. However, each device that you connect draws power from the phone line. We refer to the power drawn as the device's Ringer Equivalence Number or REN. The REN is shown on the bottom of your telephone. If you are using more than one phone or other device on the line, add up all the REN's. If the total is more than three, your phones might not ring.

NOTE:



You must not connect your phone to any of the following:

- Coin operated systems
- Party-line systems
- Most electronic key phone systems

IMPORTANT NOTES

IMPORTANT NOTES

Your phone operates on standard radio frequencies. It is possible for other radio units operating nearby on similar frequencies to unintentionally intercept your conversation or cause interference. Possible lack of privacy can occur with any cordless telephone.



IMPORTANT NOTICE

- **You must charge the new battery for at least 12 hours before you first use the phone.**
- **Under power failure conditions, this telephone will not operate. Please ensure that a separate telephone, not dependent on local power, is available for use in emergencies.**
- **After the Handset has been fully charged, the Handset MUST be placed onto the main XC631 Base Unit to register it as an additional Handset before first time use. The Handset will not work with the Base Unit until it has been registered.**

SAFETY INFORMATION

When using your telephone equipment, basic safety precautions should always be followed to reduce the risk of fire, electrical shock, and injury to persons, including the following:

1. Read and understand all instructions.
2. Follow all warnings and instructions marked on the product.
3. Unplug this product from the wall outlet before cleaning. Do not use liquid cleaners or aerosol cleaners. Use a dry cloth for cleaning.
4. Do not use this product near water; for example, near a bath tub, wash bowl, kitchen sink or laundry tub, in a wet basement, or near a swimming pool.
5. Do not place this product on an unstable cart, stand, or table. The telephone may fall, causing serious damage to the unit.
6. Slots and openings in the cabinet and the back or bottom are provided for ventilation. To protect the product from overheating, these openings should never be blocked or covered. This product should never be placed near or over a radiator or heat register. This product should not be placed in a built-in installation unless proper ventilation is provided.
7. This product should be operated only from the type of power source indicated on the marking label. If you are not sure of the type of power supply to your home, consult your dealer or local power company.
8. Do not allow anything to rest on the power cord. Do not locate this product where the cord will be damaged by persons walking on it.

SAFETY INFORMATION

SAFETY INFORMATION

9. Do not overload wall outlets and extension cords, as this can result in the risk of fire or electrical shock.
10. Never push objects of any kind into this product through cabinet slots, as they may touch dangerous voltage points or short out parts that could result in a risk of fire or electrical shock. Never spill liquid of any kind on the product.
11. To reduce the risk of electrical shock, do not disassemble this product. Take it to qualified service personnel when service or repair work is required. Opening or removing covers may expose you to dangerous voltages or other risks. Incorrect re-assembly can cause electrical shock when the appliance is subsequently used.
12. Unplug this product from the wall outlet and refer servicing to qualified service personnel under the following conditions:
 - A. When the power supply cord is damaged or frayed.
 - B. If liquid has been spilled into the product.
 - C. If the product has been exposed to rain or water.
 - D. If the product does not operate normally when following the operating instructions. Adjust only those controls that are covered by the operating instructions. Improper adjustment of other controls may result in damage, and will often require extensive work by a qualified technician to restore to normal operation.
 - E. If the product has been dropped, or the cabinet has been damaged.
 - F. If the product exhibits a distinct change in performance.
13. Do not use the telephone to report a gas leak in the vicinity of the leak.

SAFETY INFORMATION

BATTERY SAFETY PRECAUTIONS



To reduce the risk of fire or injury to persons by the battery, read and follow these instructions:

1. Use only the operating type and size battery pack specified in this Operating Guide.
2. Do not dispose of the battery pack in a fire. The cell may explode.
3. Do not open or mutilate the battery pack. Released electrolyte is corrosive and may cause damage to the eyes or skin. It may be Toxic if swallowed.
4. Exercise care in handling the battery in order not to short the battery with conducting materials such as rings, bracelets, and keys. The battery or conductor may overheat and cause burns.
5. Charge the battery pack provided with or identified for use with this product only in accordance with the instructions and limitations specified in the instruction manual provided for this product.
6. Observe proper polarity orientation between the battery pack plug and socket.

SAVE THESE INSTRUCTIONS

This page intentionally left blank.

PARTS CHECKLIST

Congratulations on your purchase of this Uniden XC631 Plus add on Handset. This product has been designed and engineered to exact standards for reliability, long life, and outstanding performance. To get the most from your new purchase, please read this Operating Guide thoroughly.

Unpacking:

Your XC631 Plus box should contain the following items:

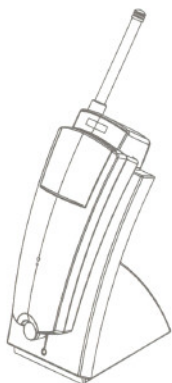

Handset
and Charge Base



NiMH Rechargeable Batteries



Memory
Storage Sticker

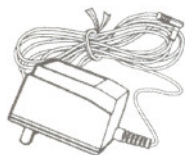

AC Adaptor

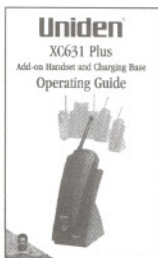

This Operating Guide
(read thoroughly)

PARTS CHECKLIST

If your Cordless Telephone is not performing up to your expectations, please try the simple steps listed in the Troubleshooting section of this manual. If you are still unable to resolve the problems, please contact your retailer or Uniden Customer Service for assistance, toll free on 1800 632 789.

If the unit must be returned for service, ship or deliver the product, freight prepaid to:

UNIDEN AUSTRALIA PTY LTD
Technical Service Division
345 Princes Highway, Rockdale
NSW 2216
Ph (02) 9599 3577
Fax (02) 9599 3278

FEATURES

FEATURES

XC631 plus Add-On Handset and Charging Base for use with the XC631 Cordless Phone, which supports up to 4 Handsets (supplied with 2).

- Calls can be transferred between Handsets.
- Colour coded for easy personal ownership and recognition.
- Up to four family members can have their own colour coded Handset.
- Each Handset can store up to 10 personal quick dial memories.
- Remote Charging

Extremely Portable - The XC631 clips onto clothing, allowing the Handset to be worn in any convenient position.

Unique Styling - Award winning design.

Compact Design - Palm size for convenience.

Lightweight - Weighs just 110gms including Battery.

Optional Pendant Clip - allows the user to wear the Uniden XC631 Handset comfortably around the neck.

Optional Hands-Free Headset - gives the ultimate hands-free conversation with the handset clipped onto the pendant clip or clothing.

This page intentionally left blank.

HANDSET FUNCTIONS

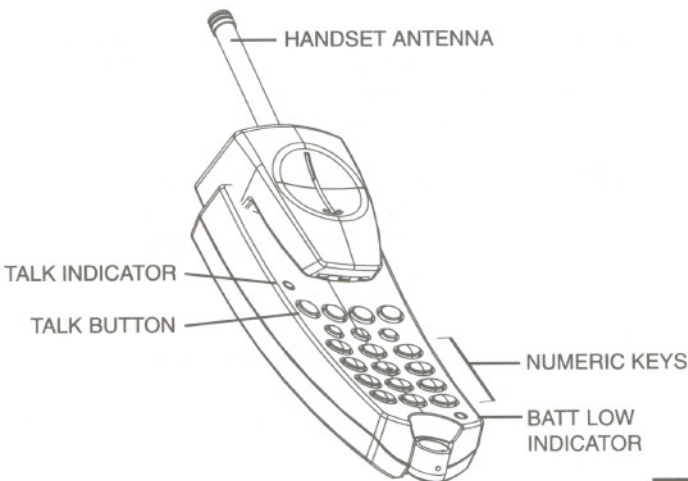

Handset Antenna Telescopic Antenna.

***batt low* Indicator** The red LED blinks when the Battery Pack is low and needs to be recharged.

Talk Press to place or answer a call.
When finished, press this button to hang up.

Talk* Indicator** The ***Talk LED lights when the phone is in use and blinks when you use memory functions.

Numeric Keys Use for dialing numbers and storing numbers in memory.

HANDSET FUNCTIONS

Flash/Rdl This button redials the last dialed number. When on a call, press to send a timed "hook-flash" on the telephone line for accessing special telephone services.

Channel Use to select 1 of the 10 channels for the clearest operation. (Note: Operates only when the phone is in use). If interference is heard during a telephone conversation, simply press the channel button to select a new channel.

Memory Use when storing numbers into the memory and when dialing a stored number.

NOTE: Each Handset has its own set of dial memories.



Call Wait When on a call and the call waiting tone is heard, press this button and the current call will be put on Hold and the incoming call will be answered.

Volume This button adjusts the volume of the earpiece speaker. Loud = Two Beeps
Soft = One Beep

Hold Pressing this button will put the call on hold. Neither you nor the other party will hear any sound.

1. Press the **Hold** button on your handset. The **Talk** light will flash at a slow rate to indicate that the call is muted.
2. To resume the call, press the **Talk** button. Doing this will turn on the **Talk** light and restore the connection, enabling you to resume speaking.

NOTE: If you put the call on hold and forget all about it, the call will be automatically be disconnected after 5 minutes.



INSTALLATION

INSTALLATION

Selecting the Installation Location

Select a location for the XC631 Plus to avoid excessive heat or humidity (as in a kitchen or bathroom). The Charging Base can be placed on a desk, tabletop or mounted on a wall near a standard 230/240V AC outlet.

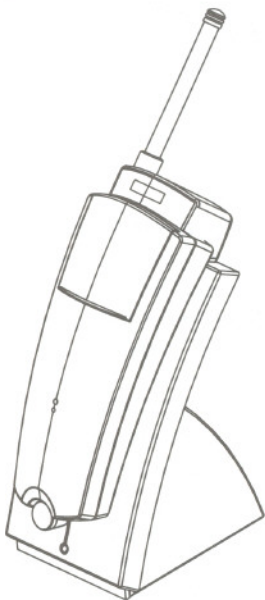

NOTE:



The XC631 Plus Charging Base does not connect to the telephone line.

INSTALLATION

Installing the Battery Pack

INSTALLATION

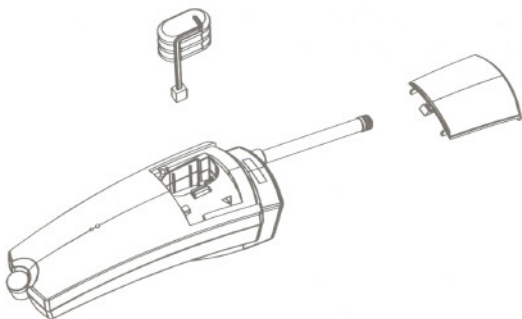

1. Remove the battery compartment cover on the back of the Handset by sliding it up.
2. Connect the Nickel-Metal Hydride Battery Pack by plugging it into the socket inside the battery compartment.

NOTE: The connector fits only one way and requires only a minimal amount of pressure to insert. Always install the Battery Cable with the Black wire to the top.

3. Place the Battery Pack inside the compartment and slide the battery cover back. Make sure the wires from the Battery Pack do not get caught in the cover.

Charging the Battery Pack

The rechargeable Nickel-Metal Hydride Battery Pack included with your XC631 Plus must be charged for approximately 12-16 hours before using the phone for the first time. Place the Handset on the Charging Base and make sure the **charge** LED lights.

If the **charge** LED does not light;

INSTALLATION

- Check to see that the AC Adaptor is plugged in and the wall outlet is switched on.
- Re-adjust the handset until the **charge** LED lights up.
- Clean the charge contacts.

Low Battery Indicator

When the Battery Pack voltage level in the Handset is very low and needs to be re-charged, the **batt low** LED blinks. If this occurs while you are on the phone, a short alert beep will also be heard. When this happens, complete your call as early as possible, and return the Handset to the Charging Base for charging. Allow 12 to 16 hours without any interruption for the handset to fully recharge.

Cleaning the Battery Charge Contacts

To maintain a good charge condition, it is important to clean all 6 charge contacts on the Handset and Charging Base about once a month. Use a pencil eraser or other contact cleaner. Do not use any liquids or solvents.

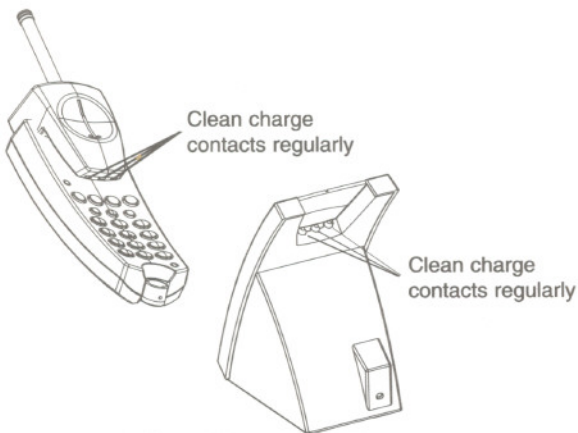

This page intentionally left blank.

USING YOUR XC631 PLUS

Registering your Handset for first time use

After the Handset has been fully charged, the Handset **MUST** be placed on to the main XC631 Base Unit to register it as an additional Handset before first time use.

The Handset will not work with the Base Unit until it has been registered.

Digital Security Code

Many Cordless telephones operate similarly and on the same frequency. Without digital code security, some one elses Handset could make calls using your Base Unit and telephone line. Therefore, to help prevent any unauthorised calls through your Base Unit, a Digital Code feature has been added to your XC631 Plus.

The code is randomly selected from over 65,000 combinations. The code is automatically set when you first place the Handset on to the Base Unit. Before using for the first time you **MUST** place the new Handset onto the original Base Unit to register it as an additional Handset.

Once the Base Unit has transfered the security code to the new Handset it can be used to make and receive calls on the same Base Unit.

The additional Charging Base (smaller size) has been supplied for you to conveniently locate and re-charge the additional Handset. This Charging Base does not connect to a telephone line and it does not assign the security code as explained above.

To change or set a new Digital Security Code

1. Remove the Handset from the Base Unit.
2. Unplug the AC Adaptor cord from the rear of the Base Unit for at least 5 seconds
3. Hold down the Page button and plug the AC Adaptor back into the Base Unit. "In Use" LED will blink twice. Release the page button.

USING YOUR XC631 PLUS

4. After five seconds unplug the AC Adaptor from the Base Unit again.
 5. Plug the AC Adaptor back into the Base Unit to restore the power.
 6. Place each Handset onto the Base Unit for at least 5 seconds.
- The new Digital Security Code has now been transferred to all Handsets.

Placing a Call

To place a call with your XC631Plus;

1. Remove the Handset from the Charging Base and Press **Talk**
2. Dial the number you are calling.
3. When you have finished the call, press **Talk** or return the Handset onto the Charging Base.

NOTE:  If you don't place the Handset back on the Charging Base, you will need to press **Talk** to hang up the phone.

Selecting a Channel

The **Channel** button on the Handset allows you to choose among 10 factory set channels. If you are receiving any interference on a channel, press the button to switch to another channel. If the noise persists, or if a double beep is heard, move closer to the Base Unit before pressing **Channel**.

NOTE:  If the noise or interference continues, refer to the section entitled "Trouble-shooting" in this manual. This function works only when the phone is in use.

NOTE:  Changing channels when the operating environment is extremely noisy may result in failure in communication between the Handset and Base Unit. As a result the Handset may fail to respond to keys pressed. To restore Handset operation, re-cradle it on the base for about 6 seconds.

USING YOUR XC631 PLUS

NOTE: If you have more than one cordless phone in your house, they must be set to different channels.

Using the **Flash/Rdl** Button

When initiating a call, this button will operate as a redial button. When on a call it will work as a flash button to access special telephone network services.

NOTE: If any other key is pressed before **Flash/Rdl** this will work as a Flash Button.

Redialing the Last Number Called

NOTE: Each Handset has independent dialing memory. It will only redial the last number last dialed from that particular Handset.

1. Remove the Handset from the Base Unit or Charging Base.
2. Press **Talk**.
3. Press **Flash/Rdl**.
4. When conversation is finished, press **Talk** or place Handset back on Base Unit or Charging Base to hang up.

Using the Flash Key with Call Waiting

To access the Telstra's Call Waiting Service, you can either use the **Call Wait** or the **Flash/Rdl** key.

1. While on a call, you will hear the Call Waiting signal (series of beep tones) when there is an incoming call.
2. Press **Flash/Rdl** then **2** to switch to the incoming call and put the current call on hold.
3. To switch back to original call, press **Flash/Rdl** then **1**.

USING YOUR XC631 PLUS

NOTE: The **Flash/Rdl** & **2** call waiting procedure toggles call between the incoming and original call and vice versa. The **Flash/Rdl** & **1** procedure will drop the current call connection and pick up the incoming call or the call on hold.

Setting the Handset Receiver Volume

While on the phone call using the handset, press the **Volume** button to select either loud or soft earpiece speaker volume.

Using the Hold Button

The **Hold** button allows you to put your call on hold.

NOTE: Note that while on hold, the call is muted.

1. Press the **Hold** button on your handset, the **talk** LED will flash at a slow rate to indicate the call is on hold.
2. To resume the call press the **Talk** button. Doing this will turn on the **talk** LED and restore the connection, allowing you to resume conversation.

NOTE: When the call is on hold neither you nor the other party will hear any sound.

Answering a Call

To answer a call at the Handset, press **Talk**. When you have finished your conversation, place the Handset back on the Charging Base. The *Auto Standby* functions automatically hang up the phone.

USING YOUR XC631 PLUS

NOTE:

If you don't place the Handset back on the Charging Base, press **Talk** to hang up the phone. Sometimes when you press **Talk** you may get an error tone and the phone will not disconnect. This may occur during conversations under noisy conditions. If this happens, place the Handset back on the Charging Base or press **Talk** again while holding the Handset close to the Base Unit.

Transferring a Call to Another Handset

To transfer a call, press **Hold** on your Handset, (the *talk* LED will flash). Press **1**, **3** **4** or **6** (corresponding colours for Blue, Green, Red and Yellow coded Handsets respectively).

Only the selected Handset will ring.

To pick up the call press **Talk** on the selected Handset.

To cancel the transfer, press **Talk** on the existing Handset.

To transfer to all handsets press **Hold** then *****, all Handsets will ring. Whichever Handset answers first will receive the call.

Storing a Number into Memory

You can store up to 10 numbers (0~9) in the Handset Memory.

NOTE:

Each Handset has its own set of dial memories. However, a particular memory can only be retrieved from the Handset in which it was stored.

1. Remove the Handset and press the **Memory** button. (The *talk* LED flashes.)
2. Enter the number (up to 16 digits) to be stored.

USING YOUR XC631 PLUS

3. If you wish to enter a delay between numbers (for accessing a switch board or long distance service), press **Flash/Rdl** at the point in the number sequence you wish to pause.
(Note: The **Flash/Rdl** button counts as one digit. Pressing **Flash/Rdl** more than once will increase the length of the pause between numbers).
4. Press **Memory** and a one digit number (0-9) for the memory location.
5. A 2-tone confirmation beep will be heard indicating that the number has been stored.

NOTE: You have 20 seconds after pressing **Memory** to enter the number you wish to store, and use only one digit for the memory location. Otherwise, an error tone will be heard

6. Write down the stored number and its memory location number on one of the enclosed stickers.

Storing a Mixed (Tone/Pulse) Number

If your phone is set up for Pulse Dialing, you can store a mixed mode number (up to 16 digits) to easily access long distance services.

1. Press **Memory** (The *talk* LED flashes)
2. Enter the number to be stored in Pulse Mode.
3. Press ***** on the Handset. (Note: The ***** counts as one digit)
4. Enter the number to be stored in Tone Mode.
5. If you wish to enter a delay between numbers (for accessing a switch board or long distance service), press **Flash/Rdl** at the point in the number sequence you wish to pause.
6. Press **Memory** and a one digit number (0-9) for the memory location.

USING YOUR XC631 PLUS

Storing Long Numbers in Memory

At times you may need to program a number longer than 16 digits – for your alternate long distance service or for telephone banking. To get around the 16 digit limitation (concerning memory location storage), divide the number between two different locations. Assign the first part of the number to one memory location, and assign the second part to another.

EXAMPLE:

To program 100-639-5975-239-51-6237, you could divide it as 1006395975 and 239516237

1. To store the first part of this sequence, press **Memory**
1 0 0 6 3 9 5 9 7 5 Memory 1
2. To store the second part, press **Memory**
2 3 9 5 1 6 2 3 7, Memory 2
3. To dial the complete number, press **Talk**, **Memory 1**
wait for dialing to stop and then press **Memory 2**

It is best to split the number at pauses or convenient breaks in the sequence, especially if you need to wait for necessary tones or signals before continuing.

USING YOUR XC631 PLUS

Dialing a Stored Number

To dial a number stored in memory, press **Talk**, then press **Memory** and then the memory location number (0~9)

Using the Page Feature

The Page Feature sends a signal from the Base Unit to the Handset causing it to beep. This is useful for locating the Handset when it is away from the Base Unit. Press the **Page** button on the Base Unit. The Handset will emit a "found" tone for 60 seconds.

NOTE:  If the handset is in use, it will not emit any sound. The Handset will also not sound if it is out of communication range. To turn off the found tone, press any button on the Handset.

Using the Call Waiting Feature

1. While on a call
2. The call waiting tone is heard, indicating that there is a second caller waiting
3. Press **Call Wait** button
4. The existing call is placed on hold and the incoming call is answered
5. Talk to the second caller
6. Press **Talk** button to end the call
7. The phone will ring back indicating that the first caller is still on hold
8. Press **Talk** button to answer the call
9. Press **Talk** button to end the call

NOTE:  Pressing the **Call Wait** button during the call will toggle between callers. The Pulse Mode Network does not support the Call Waiting feature.

TROUBLESHOOTING

If your Cordless Telephone is not performing to your expectations, please try these simple steps. If you are still unable to resolve the problems, contact Uniden Customer Service for assistance.

TROUBLESHOOTING

Problem	Suggestion
Charge light does not come on when Handset is placed onto the XC631 Plus Charging Base or the XC631 Base Unit.	<ul style="list-style-type: none">• Make sure the AC Adaptor is plugged into the Base Unit and wall outlet.• Make sure the Handset is properly seated on the Base Unit.• Make sure that the charge contacts on the Handset and Base Unit are clean. (See page 19 for instructions).
Audio sounds weak and/or scratchy.	<ul style="list-style-type: none">• Make sure that the Base Unit and Handset antennas are fully extended.• Move the Handset and/or Base Unit to different locations and try again.• Press the Channel button to select another channel.
Can't make or receive calls, or if the Handset does not ring during an incoming call.	<ul style="list-style-type: none">• The Handset MUST be placed on to the main XC631 Base Unit to register it as an additional Handset before first time use. The Handset will not work with the Base Unit until it has been registered.• Make sure that the Base Unit and Handset antennas are fully extended.• Move the Handset closer to the Base Unit.• Make sure the telephone line cord is connected firmly to the base and telephone socket.• Make sure the AC Adaptor is plugged into the Base Unit and wall outlet.

TROUBLESHOOTING

TROUBLESHOOTING

	<ul style="list-style-type: none">• Try unplugging some of the other phones. You may have too many extension phones on your telephone line.• Disconnect the AC Adaptor for a few minutes and reconnect it.
Handset can't ring or receive a page.	<ul style="list-style-type: none">• Battery Pack may be weak. Charge the battery on the Base Unit for more than 12 hours.• Extend the Base and Handset antennas fully.• The Handset may be too far away from the Base Unit. Try moving closer.• Place the Base Unit away from noise sources.• The Digital Security code may be erased. Set the Digital Security code. (See page 21 for instructions).
If you lose a call after changing channels.	<ul style="list-style-type: none">• You were probably almost out of range. Move closer to the base before changing channels. Before placing the call again, place the Handset on the base for at least 6 seconds.
Phone seems dead? Power off and on again.	<ul style="list-style-type: none">• Remove the Handset from Base Unit (if it is on the Base Unit).• Remove the Handset battery for 5 minutes.
If you are unable to turn the Handset ON/OFF, or if the base consistently fails to respond to the keys being pressed.	<ul style="list-style-type: none">• Unplug the base Unit from the main power supply for 5 minutes.• Reinstall the battery to the Handset.• Restore power to the Base Unit.• Place the Handset back on the Base Unit.

Important Electrical Considerations

Unplug all electrical appliances when you know an electrical storm is approaching. Lightning can pass through your household wiring and damage any device connected to it.

The XC631 Plus is no exception.

NOTE: Please do not attempt to unplug any appliance during an electrical storm.



Operating Range

Your Handset and the Base Station can communicate over a certain range. For clearest reception, keep the Base and Handset antennas fully extended when using your Handset away from the Base Unit.

Do make a few trial calls in and around your home or office to get a feel for the operating range in your particular surroundings.

NOTE: If you receive a call while you are out of range, the Handset may not ring. Even if it does ring, the call may not connect when you press the **Talk** button.



To receive the call, move closer to the Base Unit before you press the **Talk** button again.

Radio Interference

Radio interference may occasionally cause buzzing and humming in your cordless Handset, or clicking noises in the Base Unit. This interference is caused by external sources such as a TV, refrigerator, vacuum cleaner, fluorescent lighting, or electrical storm. Your unit is NOT DEFECTIVE. If these noises continue and are too distracting, please check around your home to see what appliances may cause the problem. In addition, we recommend that the base not be plugged into a circuit that also powers a major appliance because of the potential for interference. Be certain that the antenna of the base and Handset are fully extended.

In the unlikely event that you consistently hear other voices or distracting transmissions on your cordless telephone, you may be receiving radio signals from another cordless telephone or other source of interference. If you cannot eliminate this type of interference, you need to change the channel. Press **Channel** on the Handset to select the best channel for the clearest performance.

More than One Cordless Telephone

If you wish to use more than one cordless telephone in your house, they must be operated on different channels. During a conversation, press the **Channel** button to select one that provides the clearest performance.

SPECIFICATIONS

General

Frequency control	Crystal controlled transmission
Modulation	FM
Operating temperature	-0° C to 40° C

Charging Base Unit

Power Source	AAD 650U AC Adapter
	Approval Number 14700
	Output: 9V DC - 350 mA
	Input: 230 ~ 240V AC 50 Hz
Size	Approx. 119 x 63 x 80 mm
Weight	126 grams (without AC Adaptor)

Handset

Receive Frequency	30.075 to 30.300 MHz (10 channels)
Transmit Frequency	39.775 to 40.000 MHz (10 channels)
Size	Approx. 195 x 46 x 30 mm
	(with antenna)
Weight	110 grams (with batteries)
Power Requirements	Rechargeable NiMH Battery
Battery	CTA633
	Capacity 140mAh
	Talk Mode Approx. 3 hours
	Standby Mode Approx. 4 days

NOTE:



Shown are typical specifications and are subjected to change without notice.

This page intentionally left blank.

WARRANTY

Uniden XC631 1 YEAR WARRANTY (Batteries and Accessories are covered for 90 Days ONLY)

Note: Please keep your sales docket as it provides evidence of warranty. Warranty is only valid in the country where the product has been purchased.

WARRANTOR: Uniden Australian Pty Ltd. MCN 001 865 498

ELEMENTS OF WARRANTY: Uniden warrants to the original retail owner for the duration of this warranty, its product to be free from defects in materials and craftsmanship with only the limitations or exclusions set out below:

WARRANTY DURATION: This warranty to the original retail owner only, shall terminate and of no further effect ONE (1) Year after the date of original retail sale. This warranty will be deemed invalid if the product is: (A) Damaged or not maintained as reasonable and necessary, (B) Modified, altered or used as part of any conversion kits, subassemblies, or any configurations not sold by Uniden, (C) Improperly installed, (D) Repaired by someone other than an authorised Uniden Repair Agent for a defect or malfunction covered by this warranty, (E) Used in conjunction with any equipment or parts or as a part of a system not manufactured by Uniden, (F) Installed or serviced by anyone other than an authorised Uniden Repair Agent, (G) Where the Serial Number of the product has been removed or damaged beyond recognition.

STATEMENT OF REMEDY: In the event that the product does not conform to this warranty at any time while this warranty is in effect, the warrantor at its discretion, will repair the defect or replace the product and return it to you without charge for parts and service. THIS WARRANTY DOES NOT COVER OR PROVIDE FOR THE REIMBURSEMENT OR PAYMENT OF INCIDENTAL OR CONSEQUENTIAL DAMAGES. THIS GUARANTEE IS IN ADDITION TO AND DOES NOT IN ANY WAY AFFECT YOUR RIGHTS UNDER THE CONSUMER GUARANTEE ACT.

WARRANTY CARD: If a warranty card has been included with this product then please fill it in and return to us within 14 days of purchase. Your name and the Serial number of the product will then be registered in our database and this will help us process your claim with greater speed and efficiency should you require warranty service.

PROCEDURE FOR OBTAINING PERFORMANCE OF WARRANTY:

In the event that the product does not conform to this warranty, the Product should be shipped or delivered, freight pre-paid, with evidence of original purchase (e.g. a copy of the sales docket), with a full description of the problem, to the warrantor at:

UNIDEN AUSTRALIA PTY. LIMITED

SERVICE DIVISION

345 Princes Highway, Rockdale, NSW 2216

Ph: (02) 9599 3100 Fax: (02) 9599 3278

Free Call: 1800 632 789

Customers in other States should ship or deliver the Product freight pre-paid to their nearest Uniden Authorised Repair Centre. (Contact Uniden for the nearest Warranty Agent to you).

WARRANTY

NOTE:



Keep your receipt of purchase in a safe place in case you ever need warranty service. You should also save the carton and packaging material for storage or shipping purposes.

Uniden®

A Clear Signal of What's Ahead.

© 1998 UNIDEN CORPORATION. ALL RIGHTS RESERVED.

Free Manuals Download Website

<http://myh66.com>

<http://usermanuals.us>

<http://www.somanuals.com>

<http://www.4manuals.cc>

<http://www.manual-lib.com>

<http://www.404manual.com>

<http://www.luxmanual.com>

<http://aubethermostatmanual.com>

Golf course search by state

<http://golfingnear.com>

Email search by domain

<http://emailbydomain.com>

Auto manuals search

<http://auto.somanuals.com>

TV manuals search

<http://tv.somanuals.com>