

XS610

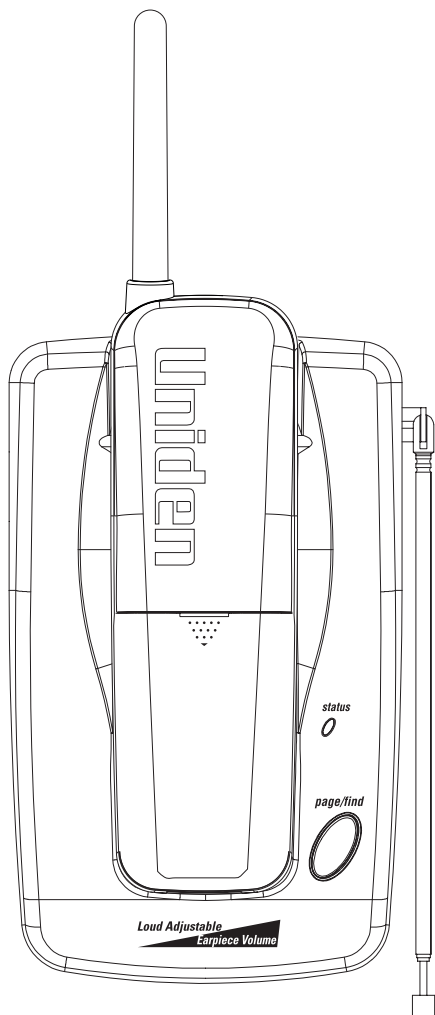

OWNER'S MANUAL

Uniden

CONTROLS AND FUNCTIONS

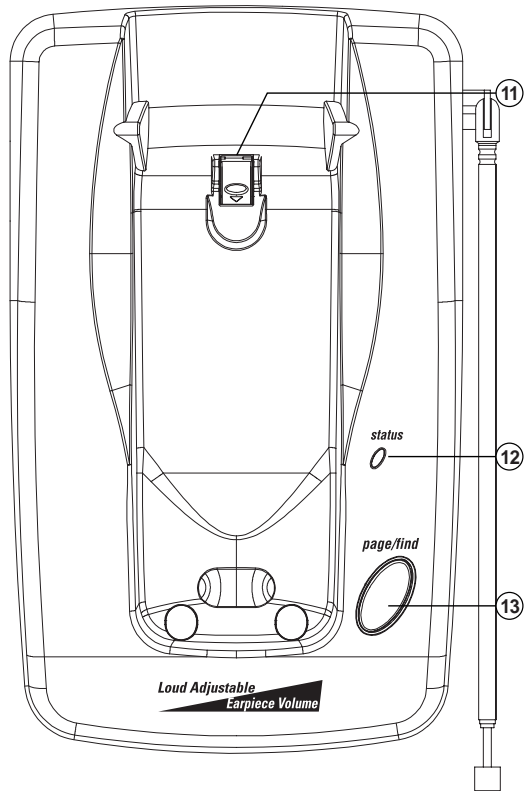
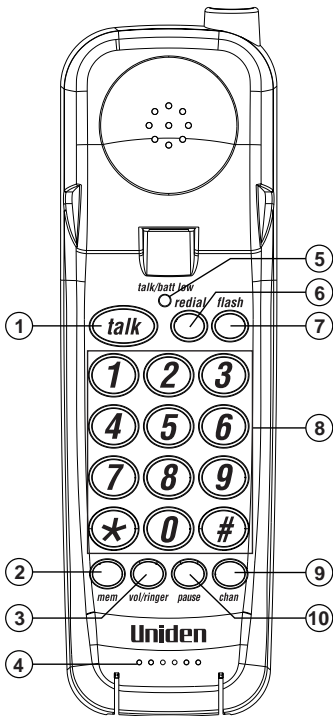

1. **Talk** - answers or places calls
2. **Mem** - stores or recalls numbers in memory
3. **Volume ringer** - sets the ringer or earpiece volumes
4. **Microphone/ringer**
5. **Talk/batt low** - LED indicates when phone is in use or the battery is low
6. **Redial** - redials the last number
7. **Flash** - access to call waiting (if waiting)
8. **Numeric key pad**
9. **Chan** - selects another channel for clearer reception
10. **Pause** - adds a timed pause in a memory dialling sequence
11. **Handset retainer** - hangs the handset on base for wall mounting.
12. **Status LED** - indicates the phone is in use or the handset is charging
13. **Page/find** - locates the handset

CONTENTS

Included in your Package	2
Important Electrical Considerations	3
Precautions	4
Important Safety Instructions	5
Radio Interference	6
More Than One Cordless Telephone	6
Battery Safety Precautions	6
Introduction	7
Features	7
Installation	
Selecting a Location	8
Connecting the Telephone Cord	8
Charging the Battery Pack	9
Charging the Handset	9
Low Battery Indicator	9
Cleaning the Battery Contacts	9
Desk or Tabletop Installation	
Wall Installation	10
Mounting on a Standard Wall Plate	11
Direct Wall Mounting	12
Setting up your Phone	
Raising the Antenna	13
Adjusting Ringer Volume and Earpiece Volume	13
Using Your Phone	
Making and Receiving the Calls	14
Storing a Number in Memory	15
Using the Flash Button	16
Chain Dialling	16
Erasing a Stored Number	16
Replacing a Stored Number	16
Selecting a Different Channel	17
Using the Page/Find Feature	17
Travelling out of Range	17
Troubleshooting	18
Specifications	20
One-Year Limited Warranty	21

INCLUDED IN YOUR PACKAGE

TIP

To get the most from your phone, please read this owner's manual thoroughly. Be sure to complete and mail the product registration form.

NOTE

If any of these items are missing or damaged, contact your place of purchase immediately.



Handset

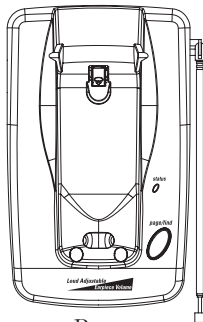

Base

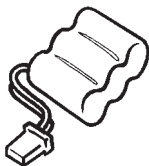

Rechargeable Battery
(BT434)

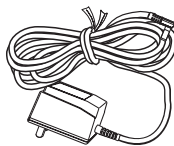

AC Adaptor

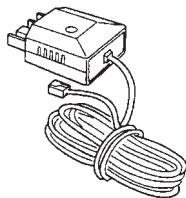

Long Telephone
Cord/Plug
(Australia Only)

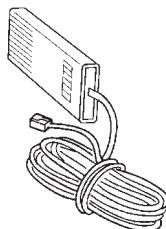

Long Telephone Cord
(NZ Only)

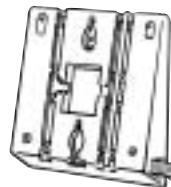

Wall Mount
Adaptor

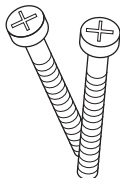

Mounting Screws

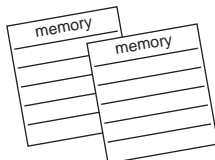

2 x Memory Stickers

- This Owner's Manual
- Registration Card
- and other printed materials

IMPORTANT ELECTRICAL CONSIDERATIONS

Unplug all electrical appliances when you know an electrical storm is approaching. Lightning can pass through your household wiring and damage any device connected to it. This phone is no exception.

Warning: Please do not attempt to unplug any appliance during an electrical storm.

Caution: Changes or modifications to this product not expressly approved by Uniden, or operation of this product in any way other than as detailed by this Operating Guide, could void your authority to operate this product.

Range

Your new phone is designed to achieve the maximum possible range by transmitting and receiving according to the highest specifications. We have rated this phone to operate at a maximum distance with the qualification that the range depends upon the environment in which the telephone is used. Many factors limit range, and it would be impossible to include all the variables in our rating. The Maximum Range rating of this phone is meant to be used as a means of comparison against other range claims.

Telephone Line Problems

If you are having trouble with your telephone service, you must first disconnect your phone to determine if it is the cause of your problem. If you determine that it is the cause, you must leave it disconnected until the trouble has been corrected.

PRECAUTIONS

Before you read anything else, please observe the following:

Warning!

UNIDEN DOES NOT represent this unit to be waterproof.

To reduce risk of fire, electrical shock or damage to the unit, DO NOT expose this unit to rain or moisture.

Rechargeable Nickel-Cadmium Battery Warning

- *This equipment contains a rechargeable Ni-Cad battery.*
- *The rechargeable Ni-Cad battery contained in this equipment may explode if disposed of in fire.*
- *Do not short-circuit the battery.*
- *Do not charge the rechargeable Ni-Cad battery used in this equipment in any charger other than the one designed to charge this battery as specified in this the owner's manual. Using another charger may damage the battery or cause the battery to explode.*
- *Rechargeable Nickel-Cadmium batteries must be recycled or disposed of properly!*

Warning!

Under power failure, this telephone will not operate. Please ensure that a separate phone not dependant on local power is available during emergencies.



The exclamation point within a triangle is intended to alert the user of an important operating or maintenance instruction.

IMPORTANT SAFETY INSTRUCTIONS

When using your telephone equipment, these basic safety precautions should always be followed to reduced the risk of fire, electrical shock, and injury to persons:

1. Read and understand all instructions.
2. Follow all warnings and instructions marked on the product.
3. Unplug this product from the wall outlet before cleaning, and use a dry cloth, without liquid or aerosol cleaners.
4. Do not use this product near water; for example, near a bath tub, shower, wash bowl, kitchen sink or laundry tub, in a wet basement, or near a swimming pool.
5. Do not place this product on an unstable stand, or table. The telephone may fall, causing serious damage to the unit.
6. Slots and openings in the cabinet and the back or bottom are provided for ventilation. To protect the product from overheating, these openings must not be blocked or covered. This product should never be placed near or over a radiator or heat register. This product should not be placed in a built-in installation unless proper ventilation is provided.
7. This product should be operated only from the type of power source indicated on the marking label. If you are not sure of the type of power supply to your home, consult your dealer or local power company.
8. Do not allow anything to rest on the power cord. Do not locate this product where the cord will be damaged by persons walking on it.
9. Do not overload wall outlets and extension cords, as this can result in the risk of fire or electrical shock.
10. Never push objects of any kind into this product through cabinet slots, as they may touch dangerous voltage points or short out parts that could result in a risk of fire or electrical shock. Never spill liquid of any kind on the product.
11. To reduce the risk of electric shock, do not disassemble this product. Take it to qualified service personnel when service or repair work is required. Opening or removing covers may expose you to dangerous voltages or other risks. Incorrect reassembly can cause electric shock when the appliance is subsequently used.
12. Unplug this product from the wall outlet and refer servicing to qualified service personnel under the following conditions:
 - A. When the power supply cord is damaged or frayed.
 - B. If Liquid has been spilled into the product.
 - C. If the product has been exposed to rain or water.
 - D. If the product does not operate normally when following the operating instructions. (Adjust only those controls that are covered by the

operating instructions. Improper adjustment of other controls may result in damage and will often require extensive repair work by a qualified technician.)

- E. If the product has been dropped or the cabinet has been damaged.
- F. If the product exhibits a distinct change in performance.

13. Do not use the telephone to report a gas leak in the vicinity of the leak.

Radio Interference

Radio interference may occasionally cause buzzing and humming in your cordless Handset, or clicking noises in the Base Unit. This interference is caused by external sources such as TV, refrigerator, vacuum cleaner, fluorescent lighting, or electrical storm. Your unit is NOT DEFECTIVE. If these noises continue and are too distracting, please check around your home to see what appliances may be causing the problem. In addition, we recommend that the Base not be plugged into a circuit that also powers a major appliance because of the potential for interference. Be certain that the antenna on the unit is fully extended.

In the unlikely event that you consistently hear other voices or distracting transmissions on your phone, you may be receiving radio signals from another cordless telephone or other source of interference. If you cannot eliminate this type of interference, change to a different channel (refer to page 17).

Finally, it should be noted that some cordless telephones operate at frequencies that may cause interference to nearby TVs and VCRs. To minimise or prevent such interference, the base of the cordless telephone should not be placed near or on top of a TV or VCR. If interference is experienced, moving the cordless telephone farther from the TV or VCR will often reduce or eliminate the interference.

More Than One Cordless Telephone

1. If you want to use more than one cordless telephone in your home, they must operate on different channels. Press the channel key to select a channel that provides the clearest communication.
2. Each telephone device that you connect draws power from the phone line. We refer to the power drawn as the devices Ringer Equivalence Number (REN). The REN is shown at the bottom part of your telephone. If you are using more than one phone or other device on the line, add up all the RENs. If the total is more than 3, your phones may not ring.

WELCOME

Congratulations on your purchase of the Uniden XS610 Cordless Telephone. This phone is designed to exacting standards which provide reliability, long life, and outstanding performance.

FEATURES

- *10 Channels (AUS)*
- *25 Channels (NZ)*
- *Random Code™ Digital Security*
- *UltraClear Plus™*
- *AutoTalk™*
- *10 Number Memory*
- *Redial Key*
- *Flash Key*
- *AutoSecure™*
- *Handset Ringer/Earpiece Volume Controls*
- *Tone Dialing*
- *AutoStandby™*
- *Page/Find Button*
- *10 Day Battery Life*

AutoTalk™ allows you to answer a call by just removing the Handset from the Base so you don't have to waste time pushing buttons or flipping switches. *AutoStandby™* allows you hang up by simply returning the Handset to the Base.

The *UltraClear Plus™* innovative technology, together with 10 (AUS) and 25 (NZ) different channels, virtually eliminates background noise and provides you with the best possible reception during all of your conversations.

To protect you against misbilled calls which might result from your phone being activated by other equipment, *Random Code digital security* automatically selects one of over 65 thousand digital security codes for the Handset and Base Unit. Also, the *AutoSecure™* feature electronically locks your phone when the Handset is on the Base.

To get the most from your phone, please read this Operating Guide thoroughly.

INSTALLATION

Selecting a Location

Before choosing a location for your new phone, there are some important guidelines you should consider:

- The location should be close to both a phone jack and power outlet.
- Keep the Base Unit and Handset away from sources of electrical noise such as motors or fluorescent lighting.
- Be sure there is sufficient space to fully extend the Base Unit antenna.
- The Base Unit can be placed on a desk or tabletop or mounted on a wall.
- If you decide to mount your phone on the wall, make sure to change the handset retainer so that the tab which holds the Handset faces up. (See page 10 for more information.)
- You should charge your new phone for 15-20 hours before completing the installation or using the Handset.

Connecting the Telephone Cord

Consider these safety guidelines before connecting the telephone cords:

CAUTION

- *Never install telephone wiring during a lightning storm.*
- *Never touch uninsulated telephone wires or terminals.*
- *Use caution when installing or modifying telephone lines.*



The battery connector will fit together only one way. Make sure the connector is properly aligned. Use only the Uniden battery pack (model BT-434)

Charging the Battery Pack

The rechargeable Nickel-Cadmium battery pack must be fully charged before using your phone for the first time. Before plugging the phone line into your new phone, you must charge the battery for approximately 15-20 hours without interruption.

1. Remove the Handset battery cover.
2. Plug the battery's cable into the handset and place the battery pack inside the battery compartment.
3. Replace the battery cover.

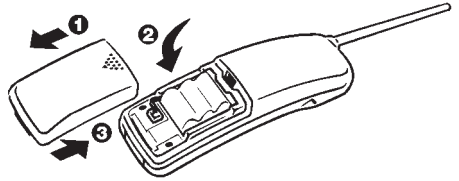

Charging the Handset

Place the handset on the base to charge. (The handset will charge only in the face-down position.)



Replace the handset on the base after use if convenient. However recharging the battery is only necessary when the low battery indicator is lit. On a monthly basis use the phone until the low battery indicator appears. Then charge the battery for 15-20 hours.

Low Battery Indicator

When the battery pack in the handset is low and needs to be charged, the talk/batt LED flashes every 3 seconds.

If this occurs while you are on the phone, you will hear an alert tone. Complete your call as quickly as possible, and return the handset to the base for charging.

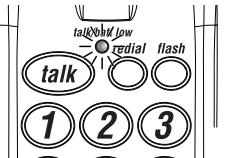

Cleaning the Battery Contacts

To maintain a good charge, it is important to clean all battery contacts on the handset and base about once a month. Use a pencil eraser or other contact cleaner. Do not use any liquids or solvents, or abrasive materials.

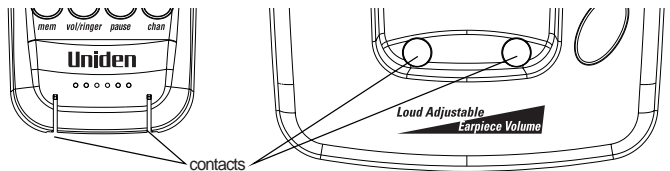



Use only the AC adaptor that came with the phone.

DESK OR TABLETOP INSTALLATION

1. Plug the AC adaptor cord into the 9V DC input jack on the base.
2. Wrap the AC adaptor cord inside the molded strain-relief.

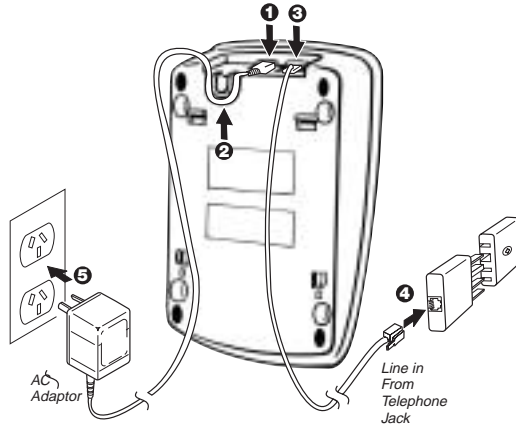

3. Plug one end of the long telephone cord into the TEL LINE jack on the base.
4. Plug the other end of the telephone cord into the telephone wall jack. (remember, the phone must be fully charged before you can use it.)
5. Plug the AC adaptor into a standard 240V AC wall outlet.
6. Fully extend the antenna on the base.



Use only the AC adaptor that came with the phone.

Wall Installation

Setting the handset Retainer for Wall mounting

1. Remove the handset retainer on the base by sliding it upward.
2. Rotate the retainer 180° and flip over so the tab is facing up.
3. Slide the retainer back onto the base.

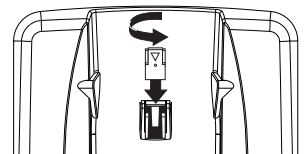
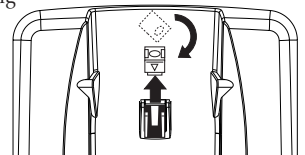



Use only the AC adaptor that came with the phone.

4. Fit the Wall Mounting adaptor to the Bottom of the telephone as shown.

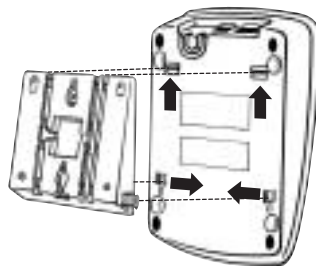

Mounting on a Standard Wall Plate

The phone is designed to be mounted on a standard telephone wall plate.

1. Plug the AC adaptor into the base.
2. Place the AC adaptor cord inside the left molded channel cord holder.
3. Plug the telephone cord into the TEL LINE jack on the base.

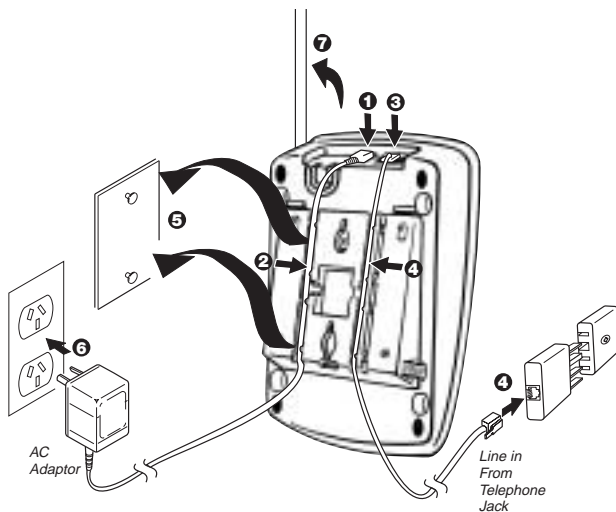

4. Place the telephone cord into the right molded channel cord holder and plug the other end of the cord into the wall jack. (Remember, the phone must be fully charged before you can use it.)
5. Place the base on the posts of the wall plate, and slide downward to secure.
6. Plug the AC adaptor into a standard 240V AC wall outlet.
7. Fully extend the antenna on the base.



Use only the AC adaptor that came with the phone.

Mounting Directly on a Wall

If you do not have a standard wall plate, you can mount the phone directly on a wall. Before mounting your cordless telephone, consider the following:

Select a location away from electrical cables, pipes, or other items behind the mounting location that could cause a hazard when inserting screws into the wall.

Make sure the wall material is capable of supporting the weight of the base and handset; otherwise, damage to the unit could result.

Use #10 screws with anchoring devices suitable for the wall material where the base will be placed.

1. Insert the screws, with their appropriate anchoring devices, 100mm apart. Allow 5mm between the wall and screw heads for mounting the phone.
2. Fit the Wall Mounting Adaptor to the Base.
3. Plug the AC adaptor into the base.
4. Place the AC adaptor cord inside the left molded channel cord holder.
5. Plug one end of the long telephone cord into the TEL LINE jack on the base.
6. Place the telephone cord into the right molded channel cord holder.
7. Place the base on the screws and push down until it's firmly seated.
8. Plug the other end of the telephone line into the telephone wall jack. (Remember; the phone must be fully charged before you can use it.)
9. Plug the AC adaptor into a standard 240V AC wall outlet.
10. Fully extend the antenna on the base.

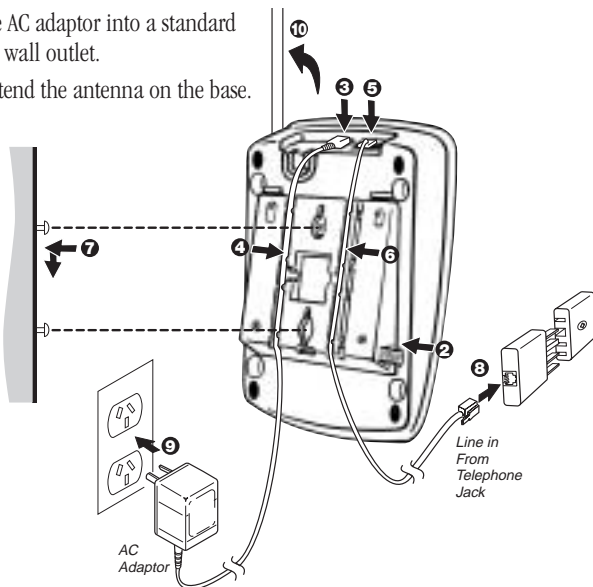
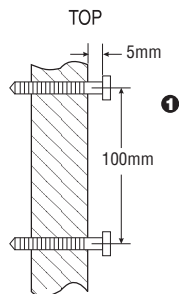

SETTING UP YOUR PHONE

Raising the Antenna

Before using your phone, be sure to fully raise the antenna to the vertical position.

ADJUSTING RINGER/EARPIECE VOLUME CONTROLS

Ringer Tone and Volume

1. While the handset is not in use, press **vol/ringer** key.
2. The phone has two ringer tones, each with two volume levels. Press **vol/ringer** key again until you hear the ringer tone and volume level you want.

Setting the Handset Earpiece Volume

1. While you are on a call, Press **vol/ringer** key.
2. The phone has three receiver volume levels. Normal, High, and Max. Press **vol/ringer** again until you hear the volume level you want.

When you hang up, the phone keeps the last volume setting selected.

MAKING AND RECEIVING CALLS

	Handset on Base	Handset off Base
Answer call	When the phone rings, remove the handset from the base. (<i>Autotalk</i>)	Press talk key.
Make call	<ol style="list-style-type: none"> 1. Remove the handset from the base and press talk. 2. The talk LED lights. 3. Listen for the dial tone. 4. Dial the number. 	<ol style="list-style-type: none"> 1. Pick up the handset and press talk. 2. The talk LED lights. 3. Listen for the dial tone. 4. Dial the number.
Hang up	Return handset to the base. (<i>AutoStandby</i>) or press talk .	Press talk .
Redial	<ol style="list-style-type: none"> 1. Remove the handset from the base and press talk. 2. Listen for the dial tone. 3. Press redial to dial the number. 	<ol style="list-style-type: none"> 1. Pick up the handset and press talk. 2. Listen for the dial tone. 3. Press redial to dial the number.



NOTE

You have 20 seconds after pressing **mem** to enter the number you wish to store. Otherwise, an error tone will sound.



NOTE

Remember, the phone number you wish to store cannot have more than 16 digits, including the pause. (The pause button counts as one digit.)



NOTE

If you attempt to dial a memory location that does not have a stored number, the handset will beep rapidly (error tone) and the phone will not dial.

STORING A NUMBER IN MEMORY

Your XS610 phone has 10 memory locations for storing important telephone numbers.

1. Remove the handset from the base and press **mem**. The **talk/batt low** LED flashes and you hear a beep.
2. Enter the phone number you want to store (up to 16 digits).
3. Press **mem** and enter a number (0-9) on the keypad for the memory location you want to use.

You hear a long beep and the **talk** LED goes out indicating the number has been stored successfully.

If you select any keys other than 0-9, the handset will beep rapidly (error tone) and no number will be stored.

Entering a Pause in Memory Dialling

If you would like to use a phone number stored in memory to access voice mail, for example, you can store a pause in the phone number sequence.

To use this function, follow *steps 1 and 2* in “Storing a Number in Memory,” then press the **pause** button on the handset to place a **pause** in the phone number sequence.

Follow the remaining steps in the “Storing a Number in Memory” section to complete the operation.

Dialling a Stored Number

To dial a phone number stored in memory, press **talk**, then press **mem** and the memory location (0-9). Your phone will dial the stored number.

NOTE

The **flash + 2** call waiting procedure toggles between the incoming and original call (and visa versa).

The **flash + 1** procedure will drop the current call connection and pick up the incoming call on hold.

USING THE FLASH BUTTON

Australia

If you have the “call waiting” service and a call waiting tone sounds while you are on a call, press **flash** then **2** to accept the waiting call. There is a short pause, then you will hear the new caller. To return to the original caller press **flash** then **1**.

New Zealand

If you have the “call waiting” service and a call waiting tone sounds while you are on a call, press the **flash** button to toggle between the incoming call and the original call (and visa versa).

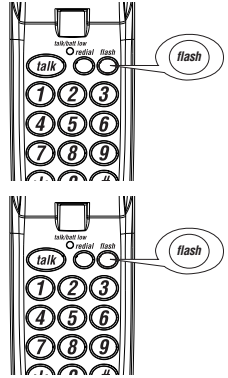

CHAIN DIALLING

After dialling a number you may be requested to enter a special access code, for example, when performing a banking transaction.

1. Store the access code into one of the memory locations (0-9).
2. Dial the main number.
3. Press **mem** and the memory location where you stored the access code at the appropriate time.

ERASING A STORED NUMBER

1. Remove the handset from the base.
2. Press **mem** twice.
3. Press the memory location number (0-9) you want to clear. You hear a long beep confirming that you have erased the number.

REPLACING A STORED NUMBER

Remember your XS610 phone has 10 memory locations, represented by the numbers 0-9 on the keypad. If you store a phone number in one of these locations, then attempt to store a different number in the same location later, the new number *will replace* the previous one.

SELECTING A DIFFERENT CHANNEL

If you encounter interference while using your phone you can manually change the phones channel for clear operation. Interference can come from appliances or other phones in your home. This function works only when the phone is in use.

The **chan** button on the handset allows you to choose between factory set channels (10 AUS/25NZ).

During the course of a conversation, if you hear static or noise which makes it difficult to hear, press **chan**. The **talk** LED flashes, indicating the phone is changing to another channel.

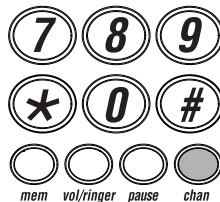

USING THE PAGE/FIND FEATURE

The Page/Find feature sends a signal from the base to the handset causing it to beep. This is useful for locating the handset when it is away from the base. To use this feature, press **page/find** on the base. The handset beeps for 60 seconds.

On the handset press any key (except talk button) or press page/find button on the base to end the page.

TRAVELLING OUT OF RANGE

When you begin to move too far from the base, you will first hear a clicking sound. As you travel further out of range, the voice transmission will begin to break up. If you pass the range limits of the base, your call will terminate.

NOTE

The paging feature does not work when the phone is in use.

TROUBLE SHOOTING

If your XS610 cordless telephone is not performing to your expectations, please try these simple steps first before calling Uniden customer service.

Caution: Do not attempt to service this until yourself. Servicing must be performed by qualified personnel.

PROBLEM	SUGGESTION
Charge light won't come on when handset is placed in base.	<ul style="list-style-type: none"> • Make sure the AC adaptor is plugged into the base and wall outlet. • Make sure the handset is properly seated in base. • Make sure the charging contacts on the handset and base are clean.
The audio sounds weak and/or scratchy.	<ul style="list-style-type: none"> • Make sure that the base antenna is fully extended in the vertical position. • Interference by other electronics equipment such as TVs, Computers microwaves etc. • You may have gone too far from the base. • Press the chan key to search for clearer reception.
Can't make or receive calls.	<ul style="list-style-type: none"> • Check both ends of the base telephone line cord. • Make sure the AC adaptor is plugged into the base and wall outlet. • Disconnect the AC adaptor for a few minutes, then reconnect it. • Reset security code by placing the handset back on the base for a few seconds. The status LED will blink indicating that the phone has been reset.
The handset doesn't ring or receive a page.	<ul style="list-style-type: none"> • The Nickel-Cadmium battery pack may be weak. Charge the battery for 15-20 hours. • The handset may be too far away from the base. Place the base away from appliances or metal objects. • Place the base away from appliances or metal objects. • Reset security code by placing the handset back on the charging cradle for a few seconds. The status LED will blink indicating that the phone has been reset.

PROBLEM	SUGGESTION
No dial tone.	<ul style="list-style-type: none"> • Check the telephone line cord connectors at both ends that they are pushed in firmly until they click. • If you had a power failure or had unplugged the base unit, replace the handset on the base unit for two to five second to reset the system.
Does not ring.	<ul style="list-style-type: none"> • You may have exceeded the Ringer Equivalence Number (REN) limit of how many phones can be connected to the same line. The REN total of all devices (printed on the label on the bottom of each unit) should not exceed three (3). Disconnect the appropriate units to lower the REN total.
No power on handset unit	<ul style="list-style-type: none"> • Check the Nickel-Cadmium battery connection inside the main battery compartment on the handset. • The handset rechargeable Nickel-Cadmium battery pack may need to be charged.
Does not charge	<ul style="list-style-type: none"> • Make sure the charging contacts on both the base unit and the handset are in contact during charging. • The charging contacts may need to be cleaned. Refer to page 9. • The Nickel-Cadmium battery may need to be discharged first before a full charge.
Range is limited	<ul style="list-style-type: none"> • Move the base unit so that it is centrally located in your residence or office and make sure that the base unit is not located near appliances.
Calls received flutters or fades	<ul style="list-style-type: none"> • The handset rechargeable Nickel-Cadmium battery may need charging. • You may be out of normal operating range. Move closer to the base unit.

GENERAL

Frequency Control: PLL
 Modulation: FM
 Operating Temperature: -10°C to 50°C

BASE UNIT

Receive Frequency: 39.775 to 40.00 MHz (10 channels AUS)
 39.800 to 40.450 MHz (25 channels NZ)
 Transmit Frequency: 30.075 to 30.300 MHz (10 channels AUS)
 30.100 to 30.750 MHz (25 channels NZ)
 Power requirements: 230V/240V AC 50 Hz
 Size (without antenna): 15mm (W) x 190mm (H) x 55.2mm (D)
 Weight: Approx. 280g

HANDSET

Receive Frequency: 30.075 to 30.000 MHz (10 channels AUS)
 30.100 to 30.750 MHz (25 channels NZ)
 Transmit Frequency: 39.775 to 40.000 MHz (10 channels AUS)
 39.800 to 40.450 MHz (25 channels NZ)
 Power requirements: Rechargeable Ni- Cd battery pack (BT434)
 Size (without antenna): 55mm (W) x 175.8mm (H) x 39.9mm (D)
 Weight: Approx. 280g (including battery)
 Battery: BT-434
 Capacity 300 mAh, 3.6V x 3 (AAA size)
 Talk mode 6 hours
 Standby mode 10 days

*Specifications, features and availability of optional accessories
 are all subject to change without prior notice.*

WARRANTY

One Year Limited Warranty

Important: Evidence of original purchase is required for warranty service.

Warrantor: Uniden Australia Pty Limited ACN 001 865 498
Uniden New Zealand Limited

ELEMENT OF WARRANTY: Uniden warrants to the original retail owner for the duration of this warranty, its XS610 (herein after referred to as the Product), to be free from defects in materials and craftsmanship with only the limitations or exclusions set out below.

WARRANTY DURATION: This warranty to the original retail owner only, shall terminate and be of no further effect 12 months after the date of original retail sale. This warranty will be deemed invalid if the product is; (A) Damaged or not maintained as reasonable and necessary, (B) Modified, altered or used as part of any conversion kits, subassemblies, or any configurations not sold by Uniden, (C) Improperly installed, (D) Repaired by someone other than an authorised Uniden Repair Agent for a defect or malfunction covered by this warranty, (E) Used in conjunction with any equipment or parts or as part of a system not manufactured by Uniden.

PARTS COVERED: This warranty covers for one (1) year, the Base Unit and Handset only. All accessories (eg. AC Adaptor etc.) are covered for 90 days only.

STATEMENT OF REMEDY: In the event that the product does not conform to this warranty at any time while this warranty is in effect, the warrantor at its discretion, will repair the defect or replace the product and return it to you without charge for parts or service. THIS WARRANTY DOES NOT COVER OR PROVIDE FOR THE REIMBURSEMENT OR PAYMENT OF INCIDENTAL OR CONSEQUENTIAL DAMAGES. THIS GUARANTEE IS IN ADDITION TO AND DOES NOT IN ANY WAY AFFECT YOUR RIGHTS UNDER THE CONSUMER GUARANTEE ACT.

WARRANTY CARD: If a warranty card has been included with this product then please fill it in and return to us within 14 days of purchase. Your name and the Serial number of the product will then be registered in our database and this will help us process your claim with greater speed and efficiency should you require warranty service.

PROCEDURE FOR OBTAINING PERFORMANCE OR WARRANTY: In the event that the product does not conform to this warranty, the Product should be shipped or delivered, freight pre-paid, with evidence of original purchase (eg. a copy of the sales docket), to the warrantor at:

UNIDEN AUSTRALIA PTY LIMITED
SERVICE DIVISION
345 Princes Highway,
Rockdale NSW 2216
Ph (02) 9599 3577 Ex (02) 9599 3278
Toll Free 1300 366 895

UNIDEN NEW ZEALAND LIMITED
SERVICE DIVISION
150 Harris Road,
East Tamaki, Auckland
Ph (9) 273 8383 Ex (9) 274 4253
Toll Free 0800 4 UNIDEN
4 864 336

Customers in other States should ship or deliver the Product freight pre-paid to their nearest Uniden Authorised Repair Centre (Contact Uniden for the nearest Warranty Agent to you)

WARRANTY

THANK YOU

FOR PURCHASING A UNIDEN PHONE!

Uniden

© 2000 Uniden Australia Pty Limited
Uniden New Zealand Limited
UDZZ01584ZZ

Free Manuals Download Website

<http://myh66.com>

<http://usermanuals.us>

<http://www.somanuals.com>

<http://www.4manuals.cc>

<http://www.manual-lib.com>

<http://www.404manual.com>

<http://www.luxmanual.com>

<http://aubethermostatmanual.com>

Golf course search by state

<http://golfingnear.com>

Email search by domain

<http://emailbydomain.com>

Auto manuals search

<http://auto.somanuals.com>

TV manuals search

<http://tv.somanuals.com>