

**Uniden®**

**XSA1255/XSA1255+1**

**Series Owner's Manual**

**OWNER'S MANUAL**

# Contents

<b>WELCOME/ FEATURES</b>	<b>2</b>	<b>USING THE SPEED DIAL MEMORY</b>	<b>23</b>
<b>CONTROLS &amp; FUNCTIONS</b>	<b>3</b>	<b>Using the Speed Dial Memory</b>	<b>23</b>
<b>TERMS USED IN THIS MANUAL</b>	<b>5</b>	Storing Caller ID Messages in Speed Dial Memory	26
<b>GETTING STARTED</b>	<b>6</b>	Making Calls from Speed Dial Memory	27
<b>Installing the Phone</b>	<b>6</b>	<b>CALLER ID FEATURES</b>	<b>28</b>
A. Choose the Best Location	6	<b>Caller ID and CIDCW (Caller ID on Call Waiting )</b>	<b>28</b>
B. Install the Rechargeable Battery Packs into the Handsets	7	Viewing the Caller ID Message List	29
C. Connect the Main Base and Charging Cradle(XSA1255+1), and Charge the Handsets	8	Deleting Information from the Caller ID List	30
D. Mount the Main Base on a Wall	9	Making a Call from the Caller ID List	31
Installing the Beltclip	10	<b>THE INTEGRATED ANSWERING DEVICE</b>	<b>32</b>
Headset Installation	11	<b>The Integrated Answering Device</b>	<b>32</b>
Register Handsets to the Main Base before Using! (XSA1255+1 only)	12	<b>Turning the Answering System On/Off</b>	<b>32</b>
When to Re-register Handsets (XSA1255+1 only)	13	<b>Setting Up Your Answering System</b>	<b>33</b>
<b>Basic Setup</b>	<b>14</b>	<b>Using Your Answering System</b>	<b>42</b>
Activating AutoTalk	14	Remote Operation	46
Activating Caller ID on Call Waiting	14	<b>ADDITIONAL INFORMATION</b>	<b>50</b>
Setting Name Tag (POP ID)	15	<b>Changing the Digital Security Code</b>	<b>50</b>
Setting Insert 0	16	<b>Note on Power Sources</b>	<b>51</b>
Selecting the Ring Tone and Volume (Handset only)	17	<b>General Information</b>	<b>53</b>
<b>BASICS</b>	<b>18</b>	<b>Troubleshooting</b>	<b>54</b>
<b>Using Your Phone</b>	<b>18</b>	Liquid Damage	57
Making and Receiving Calls	18	<b>Index</b>	<b>58</b>
Transferring a Call (XSA1255+1 only)	19	<b>Warranty</b>	<b>62</b>
Adjusting the Earpiece Volume	20		
Temporarily Mute Ringer	20		
Traveling Out-of-Range	20		
Selecting a Different Channel	21		
Find Handsets	21		
Using Call Waiting	21		
<b>ROCKETDIAL</b>	<b>22</b>		
<b>Rocketdial</b>	<b>22</b>		
Storing the Rocketdial	22		

## Welcome

Congratulations on your purchase of the Uniden single handset (XSA1255) or dual handset (XSA1255+1) cordless telephone and answering system. This phone is designed and engineered to exacting standards for reliability, long life, and outstanding performance.

**Note: Some illustrations in this manual may differ from the actual unit for explanation purposes.**

## Features

- 2.4GHz Extended Range Technology
- Caller ID\*
- Caller ID on Call Waiting\* (CIDCW)
- Integrated Telephone Answering Device (ITAD)
- 3-Line Backlit LCD
- 10 Number Memory Dialing
- Tone Dialing
- Dual Handset System (Extra Handset & Charger Included - XSA1255+1 only)
- Call Transfer from Handset to Handset(XSA1255+1 only)
- One Touch Rocketdial
- Last Number Redial
- Find Handset Key
- Earpiece/Ringer Volume Controls
- Hearing Aid Compatible
- 20 Channel Auto Scan
- Desk or Wall Mountable

\* Requires subscription to service provided by your network supplier. There is usually a fee for this service. Caller ID on Call Waiting service is currently unavailable in New Zealand.

**Be sure to visit our Website: [www.uniden.com.au](http://www.uniden.com.au) or [www.uniden.co.nz](http://www.uniden.co.nz)**

## Controls & Functions XSA1255 Handset

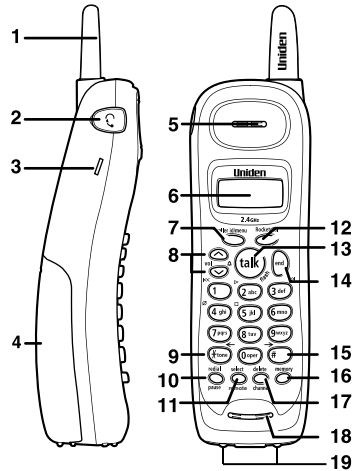

1. Handset Antenna
2. Jack for optional headset
3. Beltclip hole
4. Handset Battery Compartment
5. Handset Earpiece
6. LCD Display
7. **caller id/menu** key (P. 14 & 28)
8. **^ / v / vol** (volume up/down) key (P. 20 & 17)
9. **\* / tone / ←** key (left cursor) key (P. 19 & 24)
10. **redial/pause** key (P. 19 & 25)
11. **select/remote** key (P. 14 & 49) (XSA1255)  
**select/channel** key (P. 14, 21 & 23)  
(XSA1255+1)
12. **Rocketdial** key (P. 22)
13. **talk/flash** key (P. 18 & 21)
14. **end** key (P. 18)
15. **# / →** (right cursor) key (P. 19 & 24)
16. **memory** key (P. 23)
17. **delete/channel** key (P. 21 & 24) (XSA1255)  
**delete/transfer** key (P. 19 & 24) (XSA1255+1)
18. Handset Microphone
19. Handset Charging Contacts

## XSA1255+1 Handset

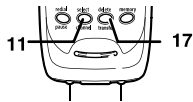

## Retrieve TAD message with Handset Remote keys

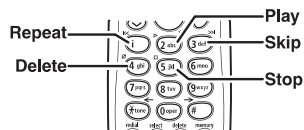

## Main Base

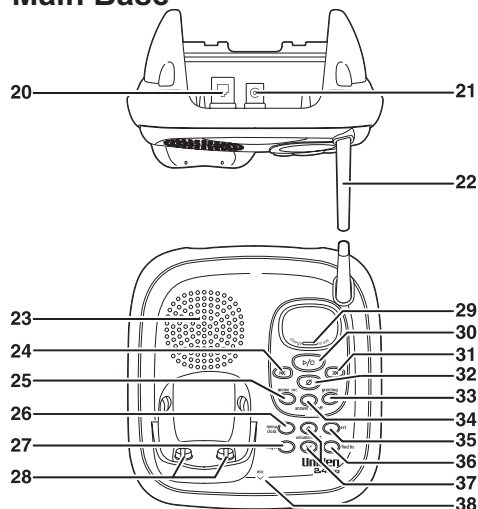

- 20. Telephone line jack
- 21. DC IN 9V jack
- 22. Base antenna
- 23. Base speaker
- 24. **⏮** (repeat/rewind) key (P. 43)
- 25. **memo rec** (record) key (P. 45)
- 26. **menu/clock** key (P. 33 & 34)
- 27. **ringer** key (P.41)
- 28. Base charging contacts
- 29. charge in use LED
- 30. **▶/□** (play/stop) key (P. 41 & 42)
- 31. **⏭** (skip/fast forward) key (P. 43)
- 32. **⊘** (delete) key (P. 44)
- 33. **greeting** key (P. 40)
- 34. **answer on/off** key (P. 32)
- 35. **set** key (P. 34)

## Extra Charging Cradle (XSA1255+1 only)

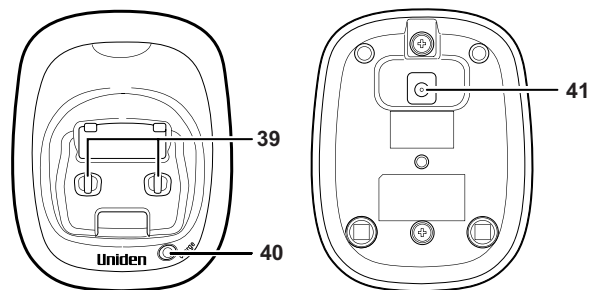

- 36. **find hs** (handset) key (P. 21 & 50)
- 37. **▲/▼/volume/select** keys (P. 33 & 41)
- 38. **mic** (microphone)
- 39. Charging contacts
- 40. Charge LED
- 41. DC IN 9V jack

## Terms Used in this Manual

- **Standby Mode** - The handset may be sitting in or off the cradle, but is NOT in use. The ***talk/flash*** key has not been pressed and there is no dial tone.
- **Talk Mode** - The handset is off the cradle and the ***talk/flash*** key has been pressed, enabling a dial tone.
- **CID** - Caller ID
- **CIDCW** - Caller ID on Call Waiting
- **RocketDial** - One touch speed dial
- **POP ID (Name Tag)** - Name is shown when Caller ID matches a phonebook entry where a name is stored.

## Installing the Phone

### Do the following steps:

- Choose the best location
- Install the rechargeable battery pack into the handset
- Connect the base unit and charge the handset
- Mount the base unit on a wall

### A. Choose the best location

When choosing a location for your new phone, here are some important guidelines you should consider:

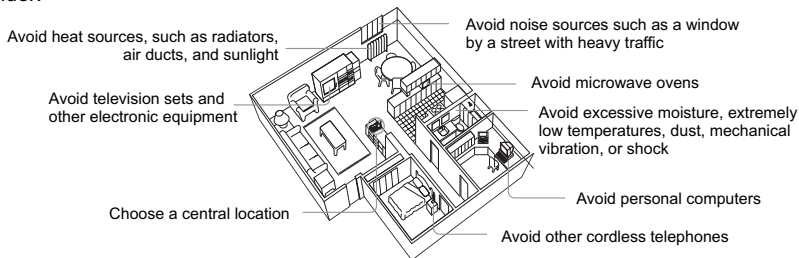

- The location should be close to both a phone jack and a continuous power outlet (one which is not connected to a switch).
- The base and handset should be kept away from sources of electrical noise such as motors and fluorescent lighting.
- The base can be placed on a desk, tabletop, or mounted on a standard wall plate. For better reception, place the base as high as possible.
- The base should be placed in an open area for optimum range and reception.



- If your home has specially wired alarm equipment connected to the telephone line, be sure that installing the system does not disable your alarm equipment.
- If you have questions about what will disable your alarm equipment, contact your telephone company or a qualified installer.



Use only the Uniden (BT-905 or BT-905s) rechargeable battery pack supplied with your cordless telephone.

## B. Install the Rechargeable Battery Packs into the Handsets

Both handsets are powered by rechargeable battery packs. The battery recharges automatically when the handset is placed in the main base or charging cradle.

- 1) Press down on the handset battery case cover (use the finger indentation for a better grip) and slide the cover down ward to remove.
- 2) Plug the battery pack connector (red & black wires) into the jack inside the battery compartment. (The connector notches fit into the grooves of the only one way.) Match the wire colors to the polarity label in the battery compartment, connect the battery and listen for a click to insure connection.
- 3) Make sure you have a good connection by slightly pulling on the battery wires. If the connection is secure, the battery jack will remain in place.
- 4) Place the battery case cover back in the handset by sliding it upwards until it clicks into place.

Repeat process for second handset (XSA1255+1 only).

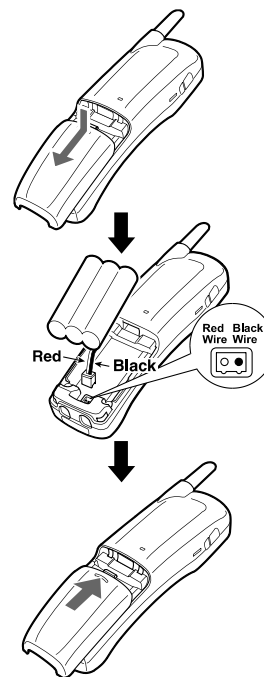



### C. Connect the Main Base and Charging Cradle(XSA1255+1 only), and Charge the Handsets

- 1) Connect each AC adapter to the **DCIN 9V** jack and to each standard **240V** AC wall outlet.
- 2) Place one handset in the main base and the other in the charging cradle with the keypad facing forward.
- 3) Make sure the **charge/in use** LED and **charge** LED illuminate. If the LED does not illuminate, check to see that the AC adapter is plugged in and the handset makes good contact with the cradle's charging contacts.

- note**
- Connect each AC adapter to a continuous power supply.
  - Place each cradle close to the AC outlet to avoid long extension cords.

- 4) Charge your handsets at least 15-20 hours before plugging the phone line.
- 5) Once the handset battery packs are fully charged, connect the telephone cord to the **TEL LINE** jack and a telephone outlet. If your telephone outlet isn't modular, contact your telephone company for assistance.

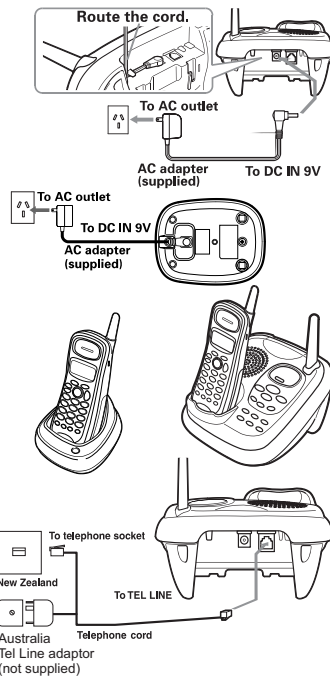

- Use only the supplied AAD-041S adapter. Do not use any other AC adapter.
- Do not place the power cord where it creates a trip hazard or where it could become chafed and create a fire or electrical hazard.

## D. Mount the Main Base on a Wall

### Standard wall plate mounting

This phone can be mounted on any standard wall plate.

- 1) Locate the base unit on the wall mount adapter as shown and slide the wall mount adapter into the notches on the base bottom.
- 2) Plug the AC adapter to the **DC IN 9V** jack.
- 3) Route the AC adapter cord through the moulded wiring channel as shown.
- 4) Plug the AC adapter into a standard **240V** AC wall outlet.
- 5) Plug the telephone cord into the **TEL LINE** jack. Route the cord through the moulded wiring channel as shown.
- 6) Plug the telephone cord into the telephone outlet (socket image is indicative only).
- 7) Align the mounting slots on the main base with the mounting posts on the wall. Then push in and down until the phone is firmly seated.

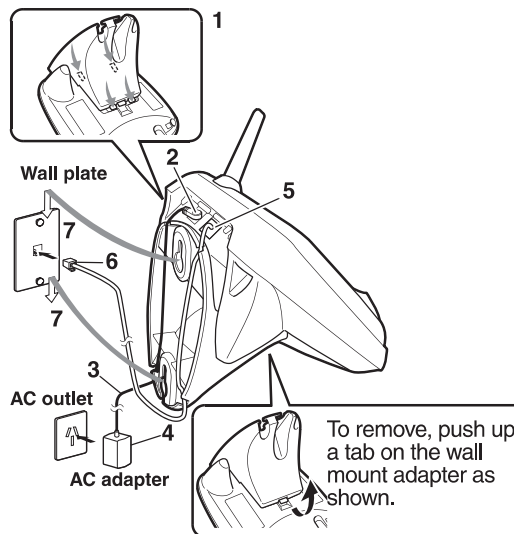

## Direct wall mounting

If you don't have a standard wall plate, you can mount your phone directly to the wall. Before doing this, consider the following:

- Avoid electrical cables, pipes, or other items behind the mounting location that could cause a hazard when inserting screws into the wall.
- Try to mount your phone within 1.5m of a working phone jack to avoid excessive cord lengths.
- Make sure the wall material is capable of supporting the weight of the main base and handset.
- Use #10 screws (minimum length of 35mm) with anchoring devices suitable for the wall material where the main base will be placed.

- 1) Insert two mounting screws into the wall, (with their appropriate anchoring device), 100mm apart. Allow about 3mm between the wall and screw heads for mounting the phone.
- 2) Refer to steps 1 through 7 on page 9 to mount the telephone.

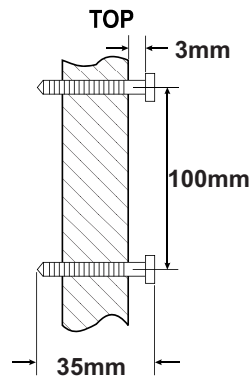

## Installing the Beltclip

### To attach the beltclip

Insert the beltclip into the holes on each side of the handset. Press down until it clicks.

### To remove the beltclip

Pull both sides of the beltclip to release the tabs from the holes.

## Headset Installation

Your phone may be used with an optional headset . To use this feature, insert the headset plug into the headset jack. Your phone is ready for hands-free conversations (Headsets may be purchased by visiting our website at [www.uniden.com.au](http://www.uniden.com.au) or [www.uniden.co.nz](http://www.uniden.co.nz).)

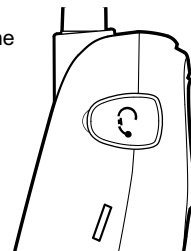

  
note

## Register Handsets to the Main Base before Using! (XSA1255+1 only)

Whichever handset you choose to charge in the main base will automatically register to the main base.

The second handset (charging in the extra charging cradle) **MUST** also be registered to the main base before use. Follow the steps below to register the second handset.

- 1) Be sure both handsets are fully charged.
- 2) Remove the handset from the charging cradle, and place it in the main base. The **charge/in use** LED light on the main base will begin to flash, indicating that the registration is taking place.
- 3) Wait for at least 5 seconds, then remove the handset from the main base.
- 4) Press the **talk/flash** key on one handset. If TALK appears on the display, the handset is registered, press the **end** key. Then, try with the second handset. If each handset displays TALK, a new security code is set. Otherwise, return to step 1 and try again.
- 5) Once both handsets are registered, it doesn't matter which handset is placed in the main base or the charger.

- When you charge the handsets, Caller ID summary screen and the name of the handset, Handset No.1 appears. If Handset No.2 appears, you are charging the handset No.2.

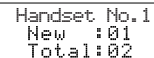

```
Handset No.1  
New :01  
Total:02
```

- The charging cradle can be used to charge either handset.



Make sure to return the handsets to the cradles after each phone call.

### **When to Re-register Handsets (XSA1255+1 only)**

- 1) You'll need to re-register the second handset (follow steps on page 12) each time the digital security code is changed. Refer to page 50 for details regarding the Digital Security Code.
- 2) When there is a power failure for more than one hour: If power failure occurs (e.g. due to electrical storm or if the unit is unplugged during a move), both handsets will need to be re-registered. To re-register, follow the same registration process on page 12.
- 3) If the second handset's battery becomes very low, the handset must be recharged for 15-20 hours and re-registered to main base. Make sure to return the handsets to the cradles after each phone call.

## Basic Setup

There are four basic options that you may need to set up: **AutoTalk**, **CIDCW** (Caller ID on Call Waiting), **Name Tag** and **Insert 0**. All options are available on the XSA1255 handset. For the XSA1255+1 the options are available as follows.

**CIDCW** option can only be set by using Handset 1. If you try to set by using Handset 2 (XSA1255+1 only), you will not see these options listed on the LCD screen. (On XSA1255+1, Handset 1 shows *Handset 1* in the display while the phone is charging.)

**AutoTalk**, **Name Tag** and **Insert 0** options can be set by using either Handset 1 or Handset 2 (XSA1255+1 only).

### Activating AutoTalk

AutoTalk allows you to answer the phone simply by removing the handset from the cradle. You do not have to press any keys.

- 1) When the phone is in standby mode, press and hold the **caller id/menu** key.
- 2) Press the **select/remote** key (XSA1255) or the **select/channel** key (XSA1255+1) to toggle and turn AutoTalk On or Off.
- 3) Press the **end** key or return the handset to the cradle to complete the setting. The handset returns to standby mode.

```
Auto Talk :Off
CIDCW    :On
Name Tag :On
```

### Activating Caller ID on Call Waiting

Caller ID allows you to see the name and number of the calling party before you answer the phone. Caller ID on Call Waiting (CIDCW) lets you see the name and number of a call that comes in when you are on the line.



- Caller ID on Call Waiting service is currently unavailable in New Zealand.

You must subscribe to Caller ID service through your local telephone provider to use this feature.

- 1) When the phone is in standby mode, press and hold the **caller id/menu** key.
- 2) Press the **✓ /vol/ ▲** key to select CIDCW.
- 3) Press the **select/remote** key (XSA1255) or the **select/channel** key (XSA1255+1) to toggle and turn on Caller ID on Call Waiting.
- 4) Press the **end** key and return the handset to the main base to complete the setting. The handset returns to standby mode.

```
▶ Auto Talk   :Off
  CIDCW       :On
  Name Tas    :On
```

```
Auto Talk     :Off
▶ CIDCW       :On
  Name Tas    :On
```

### Setting Name Tag (POP ID)

The Name Tag feature works with the Caller Display number from Caller ID. You must subscribe to Caller ID service through your local telephone provider to use this feature. There is usually a fee for this service. When the phone rings the caller display number, when received will be compared to numbers stored in the dial memory. If there is a match any name stored with the dial memory number will be displayed (see page 23).

- 1) When the phone is in standby mode, press and hold the **caller id/menu** key.
- 2) Press the **✓ /vol/▲** key twice to select Name Tas.
- 3) Press the **select/remote** key (XSA1255) or the **select/channel** key (XSA1255+1) to toggle and turn Name Tag on or off.
- 4) Press the **end** key or return the handset to the cradle to complete the setting. the handset returns to standby.

```
▶ Auto Talk   :Off
  CIDCW       :On
  Name Tas    :On
```

```
Auto Talk     :Off
  CIDCW       :On
▶ Name Tas    :On
```



## Setting Insert 0

This feature adds '0' or '00' to the number, when you receive Caller ID messages. The default setting for New Zealand is On. The default setting for Australia is Off.

- 1) When the phone is in standby mode, press and hold the **caller id/menu key**. The following screen appears.
- 2) Press the **✓/vol/⏏** key three times to select **Insert 0**.
- 3) Press the **select/remote** key (XSA1255) or the **select/channel** key (XSA1255+1) to toggle and turn **Insert 0** on or off.
- 4) Press the **end** key or return the handset to the cradle to complete the setting. The handset returns to standby mode.

```
▶Auto Talk   :Off
CIDCW       :On
Name Tas    :On
```

```
CIDCW       :On
Name Tas    :On
▶Insert 0   :On
```

## Selecting the Ring Tone and Volume (Handset only)

Your phone has five different ringer tone/volume combinations you can choose from.

- 1) With the phone in standby mode, press the **∇/vol/⏏** or **∧/vol/⏏** key.
- 2) The phone will sound the different ring tones at different volumes. To turn the ringer off, select Ringer Off.
- 3) When the phone sounds the ring tone and volume you wish to use, press the **end** key.

## Using Your Phone

### Making and Receiving Calls

#### Making a call

- 1) Remove the handset from the cradle.
- 2) Press the **talk /flash** key.
- 3) Listen for the dial tone.
- 4) Dial the number.

OR

- 1) Remove the handset from the cradle.
- 2) Dial the number.
- 3) Press the **talk /flash** key.

#### Receiving a call

- 1) Remove the handset from the cradle. (If AutoTalk is on, the phone will automatically answer the call when you pick it up.)
- 2) Press the **talk /flash** key.

OR

- 1) If the handset is off the cradle, press the **talk/flash**, **\* /tone/ ←**, **#/ →** key or any number key. (AutoTalk is on.)

#### Hanging up

Press the **end** key or return the handset to the cradle.

note

- To turn on the AutoTalk feature, see "Activating Auto Talk" on page 14.



- If you transfer a call and it is not picked up after 5 minutes, the call will be disconnected.

## Transferring a Call (XSA1255+1 only)

Your cordless phone allows you to transfer outside calls from handset to handset; only one handset at a time can talk with an outside caller. The second handset cannot go off hook to listen to conversations or make an outgoing call while the other handset is in use.

### To transfer a call

- 1) During a call, press the **delete/transfer** key. The call will automatically be placed on hold and the transfer tone sounds.
- 2) When the other handset receives the call, the transfer tone stops.  
To cancel the transfer and return to the caller, press the **delete/transfer** or **talk/flash** key on the handset.

Hold  
Transfer Call

### To receive a transfer call

Pick up the handset from the cradle (when AutoTalk is set to on), or pick up the handset and press the **talk/flash** key to answer the transferred call. Additionally, you can answer the transferred call by pressing **\* /tone/←**, **#/→** or any number key (when AutoTalk is set to on).

Transfer Call

## Redialing the Last Dialed Number

- 1) Remove the handset from the cradle.
- 2) Press the **talk/flash** key.
- 3) Listen for the dial tone.
- 4) Press the **redial/pause** key.

OR

- 1) Remove the handset from the cradle.
- 2) Press the **redial/pause** key.
- 3) Press the **talk/flash** key.

## Adjusting the Earpiece Volume

To change the earpiece volume, press the **V/vol/▲** or **^/vol/△** key during a call.

## Temporarily Mute Ringer

If the handset is off the cradle while an incoming call is ringing, simply press the **end** key to mute the incoming ring . The ringer will sound with the next incoming call.

## Traveling Out-of-Range

During a call, as you begin to move your handset too far from your main base, noise increases. If you pass the range limits of the main base, your call will terminate within one minute.

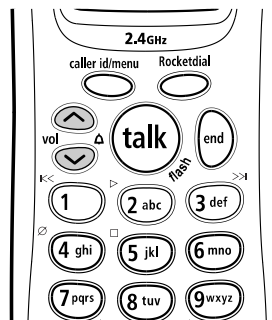

- You can only mute the handset ringer if the handset is off the cradle when the phone starts ringing.



- The **UltraClear Plus** true compander circuitry virtually eliminates background noise. This innovative technology, together with 20 different channels, provides you with the best possible reception during all your conversations.

## Selecting a Different Channel

If you encounter interference while using your phone, you can manually change the phone's channel for clear operation. While using your phone, press the **delete/channel** (XSA1255) or **select/channel** (XSA1255+1) key. Scanning appears on the display, indicating the phone is changing to another channel.

## Find Handsets

To locate the handsets, press the **find hs** key on the main base. The handsets beep for 60 seconds. To cancel paging, press any key on either handset or the **find hs** key on the main base.

Paging is also canceled when the phone receives an incoming call.

## Using Call Waiting

If you have Call Waiting, you can receive calls while on the line. If a call comes in while you are on the phone, you will hear a call waiting tone. If you have CIDCW activated, you will see the name and number of the incoming caller.

Australia: Press to **talk/flash** key and then **2** to switch between callers.

New Zealand: Press to **talk/flash** key to switch between callers.



You must subscribe to Call Waiting through your local telephone company.

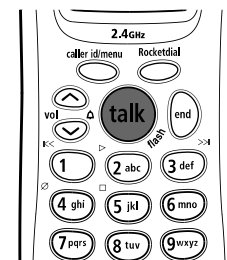
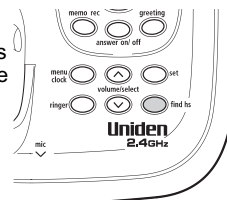

## RocketDial

RocketDial is a one-touch speed dial key. Store your most important or most frequently called number as your RocketDial number. Then, simply press the **Rocketdial** key, and your phone will automatically dial the number.

### Storing the RocketDial

- 1) When the phone is in standby mode, press and hold the **Rocketdial** key. Store Number appears. If the Rocketdial number is already programmed, the Edit screen appears. You can select Edit Number to edit this entry, select Delete Number to erase this entry or select Go Back to return to standby mode.
- 2) Store the number by following step 6 under "Storing Names and Numbers in Speed Dial Memory" on page 23.
- 3) Press the **select/remote** key (XSA1255) or the **select/channel** key (XSA1255+1). You hear a confirmation tone, and Number Stored appears. Memory storage is complete.

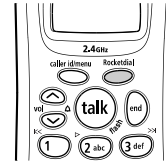

Store Number

Edit Number  
Delete Number  
Go Back

Store Number  
800

Number Stored



- When editing the speed dial memory, you must press a key within 30 seconds or the phone will return to standby mode. If you return the handset to the cradle, the phone will return to standby mode also.
- For New Zealand: Telecom access numbers are pre-programmed into speed dial locations as follows.
  - Divert On: SPD1
  - Divert Off: SPD2
  - Block CID: SPD3
  - Messages: SPD4
  - Directory: SPD6

## Using the Speed Dial Memory

The speed dial memory allows you to store up to 10 names and numbers in each handset. You can dial these numbers with just a few key presses.

The speed dial memory is not limited to phone numbers. You can store any number (up to 20 digits) that you need to enter once your call connects. This is referred to as Chain Dialing. For example, you can save your bank account number to speed dial memory. When you call your bank's telephone teller service and are prompted to enter your account number, simply press the **memory** key and the speed dial number where you stored your account number. Then press the **select/remote** key (XSA1255) or the **select/channel** key (XSA1255+1).

### Storing Names and Numbers in Speed Dial Memory

- 1) With the phone in standby mode, press the **memory** key.
- 2) Enter 0-9 to select the speed dial number where you would like to store this entry. You can also scroll through the list with the **∇/vol/▲** and **∧/vol/▲** keys. Press the **select/remote** key (XSA1255) or the **select/channel** key (XSA1255+1) twice.
- 3) Store Name appears and a cursor flashes indicating that the phone is ready for the name to be entered.

If the selected speed dial number is already assigned, the Edit screen appears. You can select Edit to edit this entry, select Delete to erase this entry, or select Go Back to choose another speed dial number.

```
Select Memory
01#
02 JOHN DOE
```

```
Store Name
```

```
▶ Edit Memory01
Delete Memory01
Go Back
```



- 4) Enter a name according to the instructions below, then press the **select/remote** key (XSA1255) or the **select/channel** key(XSA1255+1). If no name is required, go to step 5.
- The name can be up to 13 characters.
  - Use the **#/→** and **\* /tone/←** keys to move the cursor to the desired location.
  - Use the **delete/channel** key (XSA1255) or the **delete/transfer** key(XSA1255+1) to delete characters as needed.
  - Press and hold the **delete/channel** key (XSS1255) or the **delete/transfer** key(XSA1255+1) to delete all the characters.

Refer to the letters on the number keys to select the desired characters.

With each press of a numeric key, the displayed character appears in the following order: upper case letters first, lower case letters next and finally the number corresponding to the key. If you make a mistake while entering a name Use the **\* /tone/←** or **#/→** key to move the cursor to the incorrect character. Press the **delete/channel** key (XSA1255) or the **delete/transfer** key(XSA1255+1) to erase the wrong character. Then enter the correct character. To delete all characters, press and hold the **delete/channel** key(XSA1255) or the **delete/transfer** key(XSA1255+1) .

For example, to enter Movies.

- 1) Press **6**. Then press the **#/→** key to move the cursor to the right.
- 2) Press **6** six times.
- 3) Press **8** six times.
- 4) Press **4** six times.
- 5) Press **3** five times.
- 6) Press **7** eight times.

keys	Number of times key is pressed								
	1	2	3	4	5	6	7	8	9
1	1								
2abc	A	B	C	a	b	c	2		
3def	D	E	F	d	e	f	3		
4ghi	G	H	I	g	h	i	4		
5jkl	J	K	L	j	k	l	5		
6mno	M	N	O	m	n	o	6		
7pqrs	P	Q	R	p	q	r	s	7	
8tuv	T	U	V	t	u	v	8		
9wxyz	W	X	Y	Z	w	x	y	z	9
0oper	*	#	-	&	(	)	(blank)	0	



- If the next character uses the same number key, you must press the **#/→** key to move the cursor over. Otherwise the next time you press the number key, it changes the character that was previously set.

- 5) Store Number is displayed. The cursor flashes indicating that the phone is ready for the number to be entered.
- 6) Use the keypad to enter the phone number; each number can be up to 20 digits. If you need the phone to pause during the dialing sequence, press the **redial/pause** key to insert a two-second delay between the numbers. You can enter multiple pauses to increase the delay. Each pause counts as a digit. The display shows a P for every pause.

```
Store Number
█
```

```
Store Number
8007303456█
```

**note** When storing numbers into memory, if the handset is idle (i.e., no key is pressed) for more than 30 seconds, it will beep rapidly, and the phone will return to standby mode.

- 7) Press the **memory** key. You will hear a confirmation tone, and the following screen appears. Memory storage is complete. After about 2 seconds, the following screen displays all the speed dial memory entries.
- 8) Press the **end** key to exit memory set up mode. The phone returns to standby.

```
Memory01 Stored
```

```
01▶Movies
02 JOHN DOE
03 MOM AND DAD
```

## Storing Caller ID Messages in Speed Dial Memory

Messages (Caller ID names/numbers) shown in the Caller ID list can be stored in memory dialing. For instructions on viewing the Caller ID Message list, see page 29.

- 1) Press the **caller id/menu** key. Select the phone number to be stored from the Caller ID list by pressing the **^/vol/▲** or **^/vol/▲** key.

```
17/05 12:30PM
Jane Smith
2145551234
```

- 2) Press the **memory** key.

```
Select Memory
01▶
02 JOHN DOE
```

- 3) Enter a number (0-9) or press the **^/vol/▲** or **▼/vol/▲** key to select the memory location to be stored.

```
17/05 12:30PM
Jane Smith
2145551234
```

- 4) Press the **select/remote** key (XSA1255) or the **select/channel** key (XSA1255+1). You hear a confirmation tone, and the number is stored in memory. The display returns to the Caller ID list.

```
Replace Memory?
Yes
▶ No
```

note

If a message has already been stored in the selected memory number location, a confirmation screen is displayed. Press the **^/vol/▲** key to select **Yes**. Press the **select/remote** key (XSA1255) or the **select/channel** key (XSA1255+1) to overwrite. The display returns to the Caller ID list.

note

- You cannot store a Caller ID message if no phone number appears in the message.

## Making Calls from Speed Dial Memory

- 1) Press the **memory** key. The handset displays your programmed speed dial number.
- 2) Enter the number (0-9), or press the **^/vol/▲** or **∇/vol/▲** key to select the speed dial number you would like to dial.
- 3) Press the **talk/flash** key. Talk and the number selected appear on the display. Then the displayed number is dialed.

```
Select Memory
01 Movies
02 JOHN DOE
```

```
>Talk<
8007303456
```

### To cancel speed dialing

To cancel speed dialing, press the **end** key; the handset returns to standby mode. The handset will also return to standby mode if the handset is idle (i.e., no key is pressed) for 30 seconds.

## Easy Dial

Numbers stored in the speed dial memory can be accessed directly from standby mode as follows.

- 1) Press and hold a key from memory location for 1.5 seconds. The details of the memory location will appear on the display.
- 2) Press **talk/flash** key. The displayed number is dialed.

```
01: DIVERT ON
161
```

## Caller ID and CIDCW (Caller ID on Call Waiting)

You must subscribe to Caller ID services through your local telephone provider to use these features. CIDCW (Caller ID on Call Waiting) service is currently available in Australia only.

When the telephone rings, the Caller ID feature allows you to view the caller's, phone number, date and time of call, and Name Tag (POP ID) feature allows you to view the caller's name (see pages 15 and 29). The incoming call information is stored in the Caller ID record. If the Caller ID service includes the caller's name, the name will appear in the display (up to 15 characters).

**Caller ID information may take up to 2 to 3 rings before appearing on the display.**

The date and time received	11/05 12:30PM
Caller's name	Jane Smith
Caller's phone number	2145551234

You may receive any one of the following messages:

When a private name is received; Private

When a private number is received; Private

When an unknown name is received; Unavailable

When an unknown number is received; Unavailable

When invalid data is received; Incomplete Data

When an overseas call(0000) is received (New Zealand only): overseas call

When a call is coming from a payphone (Australia only): Payphone

note

Data errors appear as "■."

note

- If you answer a call before the Caller ID message is received, the Caller ID message will not appear.
- When the call is received via a Telephone company that does not offer Caller ID service, the caller's phone number and name does not appear. (This includes some international Calls.)
- When the call is received via a private branch exchange (PBX), the caller's phone number and name may not appear.



- In Caller ID operation, if no key is pressed for more than 30 seconds, an error tone sounds and the telephone returns to standby mode.  
Each message can be up to 15 characters for the name and 15 digits for the phone number.
- The number of calls from the same Caller ID appears next to the received time. Once you view the new message, the number will be cleared and disappear.
- During a call, don't press the **end** key, or the call will be disconnected.

## Viewing the Caller ID Message List

The Caller ID list stores information for up to 30 incoming calls - even unanswered calls. You can also view the Caller ID list during a call.

- 1) Press the **caller id/menu** key. The summary screen displays the number of new messages and total messages.
- 2) Use the **▼/vol/▲** key to scroll through the messages from the latest to the earliest, or use the **▲/vol/▲** key to scroll through the messages from the earliest to the latest.
- 3) Press the **caller id/menu** key to return to talk mode, or press the **end** key to return to standby mode.

```
Caller ID
New :01
Total:02
```

```
17/05 12:30PM
Jane Smith
2145551234
```

## Deleting Information from the Caller ID List

If the phone receives more Caller ID messages than it can store, the oldest one in the list is automatically deleted. Caller ID data can also be deleted manually.

### Deleting a Caller ID message

- 1) Press the **caller id/menu** key in standby mode. Find the message to be deleted from the Caller ID list by pressing the **▼/vol/▲** or **▲/vol/▲** key.
- 2) Press the **delete/channel** key(XSA1255) or the **delete/transfer** key(XSA1255+1) .
- 3) Press the **▼/vol/▲** or **▲/vol/▲** key to select **Yes**, and then press the **select/remote** key (XSA1255) or the **select/channel** key(XSA1255+1).

```
17/05 12:30PM
Jane Smith
2145551234
```

```
Delete Message?
▶ Yes
No
```

### Deleting all Caller ID names/numbers

- 1) With the phone in standby mode, press the **call id/menu** key.
- 2) Press the **delete/channel** key(XSA1255) or the **delete/transfer** key(XSA1255+1) .
- 3) Press the **▼/vol/▲** or **▲/vol/▲** key to select **Yes**, and then press the **select/remote** key (XSA1255) or the **select/channel** key(XSA1255+1). You hear a confirmation tone and all stored Caller ID messages are deleted.

```
Caller ID
New :01
Total:02
```

```
Caller ID
Total:00
```

note

- While using the **Delete All?** or **Delete Message?** screen, if no key is pressed for more than 30 seconds, an error tone sounds, and the handset returns to standby mode.
- If you get an incoming call or page, the deleting operation is cancelled, and you can answer the call or page.



- You cannot make a call from the Caller ID list if your cordless phone is connected to a private branch exchange (PBX).

## Making a Call from the Caller ID List

You can place a call from the Caller ID list.

- 1) Press the **caller id/menu** key in standby mode. Select the phone number that you want to dial by pressing the **▼/vol/▲** or **▲/vol/▲** key.
- 2) Press the **talk/flash** key.  
The displayed phone number dials automatically.

```
17/05 12:30PM  
Jane Smith  
2145551234
```

## Caller ID on Call Waiting (CIDCW)

With CIDCW, you will hear a Call Waiting tone while you are on a call, and the Caller ID data is displayed. See using Call Waiting on page 21 to accept waiting call.



## The Integrated Telephone Answering Device

The cordless phone has a built-in answering system that answers and records incoming calls. You can also use your answering system to, leave a voice memo message, or announce a special outgoing message to callers when you're away from your phone.

### Features

- Digital Tapeless Recording
- Retrieve Messages Using Handset (XSA1255 only)
- Up to 13 minutes of Recording Time
- Call Screening
- Personal or prerecorded Outgoing Messages
- Time and Day Announcement
- Remote Message Retrieval
- Toll Saver
- Voice Memo
- Selectable Ringer Options (High, Low or Off)

Digital Tapeless Recording allows you to quickly review, save, or delete any messages you choose. You will never have to worry about a tape wearing out, jamming, or resetting improperly. The Integrated Answering System is easy and convenient to use, but please read through all of the instructions carefully.

### Turning the Answering System On/Off

- 1) To turn the answering system on, press the **answer on/off** key. The system will announce "Answering system is on." The current greeting message will be played, and you hear a confirmation tone. The message counter displays the number of messages stored in memory. If the display flashes, there are new messages waiting for you.
- 2) To turn the answering system off, press the **answer on/off** key again. After the announcement "Answering system is off," the message counter display will no longer be illuminated. To turn the answering system back on, press the **answer on/off** key.

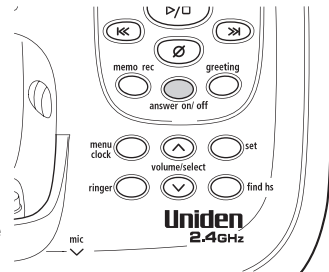



- For your convenience, voice prompts will guide you through the menu mode.
- After the setting, press the  $\triangleright/\square$  (play/stop) key to exit the menu mode, or the **menu/clock** key to move to the next menu option.

## Setting Up Your Answering System

### Answering System Settings

To set the following six functions you must enter the menu mode.

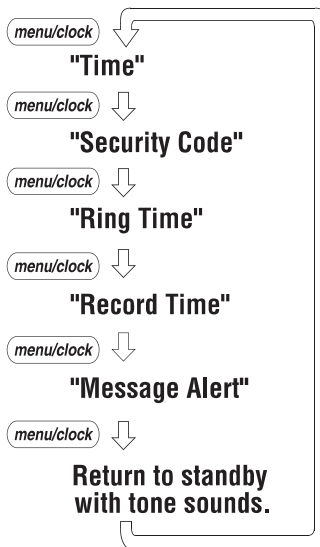

- To scroll through the menu options, repeatedly press the **menu/clock** key in standby mode. The system returns to standby after the last menu option. You hear a confirmation tone to indicate standby mode.
- If any of the following occurs during menu setup, the system returns to standby; you will have to start over with the procedure you were performing.
  - The **talk/flash** key is pressed
  - The  $\triangleright/\square$  (play/stop) key is pressed
  - 10 seconds elapse without a key press
  - An incoming call is received
- If the system remains idle for up to ten seconds after the announcement, the system returns to standby. Once the  $\wedge$  or  $\vee$  / **volume/select** key is pressed, the idle time is extended to 10 seconds.

## Setting the Time

The clock on the cordless phone's answering system starts when power is supplied to the base. Follow these steps to set the clock to the correct time.

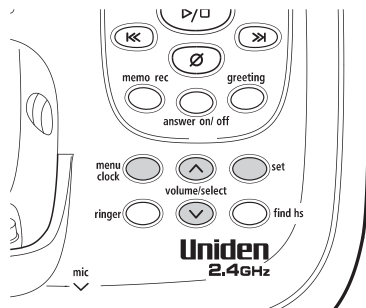

- 1) With the phone in standby mode, press the **menu/clock** key. The system announces "Time," the current time and the guidance for setting the time.
- 2) Press the **▲** or **▼/volume/select** key until the correct day is announced. The numbers [ / ] through [ 7 ] are displayed on the base.
- 3) Press the **set** key to select the day.
- 4) Press the **▲** or **▼/volume/select** key until you hear the correct hour setting. The numbers [ / ] through [ /2 ] are displayed on the base.
- 5) Press the **set** key to select the hour.
- 6) Press the **▲** or **▼/volume/select** key until you hear the correct minute setting. The numbers [ 00 ] through [ 59 ] are displayed on the base.

### note

- Normally, the system will return to standby if it remains idle for 10 seconds after the **▼** or **▲/volume/select** key is pressed. For setting the time, however, the idle time is extended to two minutes.
- Press and hold the **▼** or **▲/volume/select** key to quickly scroll through the numbers on the display.



- The PIN code is set to "80" when you purchase the cordless phone.

- 7) Press the **set** key to select the minute.
- 8) Press the **▲** or **▼** / **volume/select** key until you hear the correct AM or PM setting. The message counter displays [ **A** ] or [ **P** ].
- 9) Press the **set** key to select the AM/PM setting.

You hear a confirmation tone. Then the announcement "Time" and the day and time are announced for your review. After a few seconds, the system announces "To set security code, press menu again."

### Setting a Personal Security Code (PIN)

To play your messages from a remote location, you need to enter a two-digit Personal Identification Number (PIN) code (00-99). To select a PIN, perform the following steps:

- 1) With the phone in standby mode, press the **menu/clock** key twice. The system announces "Security code," and the current PIN code is announced as it is displayed on the base. Then the system announces the guidance for setting the PIN code.
- 2) Press the **▲** or **▼** / **volume/select** key until the desired number appears.
- 3) Press the **set** key to select the PIN code. You hear a confirmation tone, then the announcement "Security code" followed by the new PIN code. After a few seconds, the system announces "To set ring time, press menu again."

## Setting the Ring Time

The ring time setting allows you to set the number of rings the caller hears before your answering system plays the outgoing message. You can set the ring time to answer after six, nine, or twelve rings. Setting [ⓧ 5] (Toll Saver), the answering system picks up after six rings if you have new messages, and after nine rings if there are none. This way, if you make a long distance call to check your messages, you can hang up after the second ring to avoid billing charges.

- 1) With the phone in standby mode, press the **menu/clock** key three times. You hear "Ring time" and the current ring time ([ⓧ] 6, [ⓧ] 9, [ⓧ] 12, [ⓧ 5] Toll saver), and it is displayed on the base. Then you hear the guidance for setting the ring time.
- 2) Press the **∧** or **∨/volume/select** key until the desired ring time appears.
- 3) Press the **set** key to select the new ring time. You hear a confirmation tone, then the announcement "Ring time" followed by the new ring time. After a few seconds, the system announces "To set record time, press menu again."



- After setting the Announce only feature, you may want to change your outgoing message not to prompt the caller to leave a message. However, the prerecorded message changes automatically.

## Selecting the Message Record Time

You have three record time options. The options "One minute" or "Four minutes" set the duration for recording the incoming messages. "Announce only" answers the call with the preset greeting or your personal greeting but prevents the caller from leaving a message.

- 1) With the phone in standby mode, press the **menu/clock** key four times. You hear "Record time" and the current recording time ([ / ] one minute, [ 4 ] four minutes, [ A ] Announce only, No recording), and it is displayed on the base. Then you hear the guidance for setting the record time.
- 2) Press the **^** or **v** /**volume/select** key until the desired time appears.
- 3) Press the **set** key to select the new recording time. You hear a confirmation tone, then the announcement "Record time" followed by the new recording time. After a few seconds, the system announces "To set message alert, press menu again."

## ▼ Announce only feature

The announce only feature plays a prerecorded outgoing message, and will not allow the caller to leave a message. To set "Announce only," follow the steps above.

Your system comes with a prerecorded announce only greeting; "Hello, no one is available to take your call. Please call again."

To scroll between the prerecorded message or your own personal greeting, press the **greeting** key when the outgoing message is played. If you want to use your own greeting or want to omit the prompt "to leave a message" from your greeting, refer to "Recording a personal outgoing message (Greeting)" on page 40.

## Setting the Message Alert Tone

Message Alert feature lets you know you have new messages by sounding a short beeping tone. If you set the Message Alert to on when a new message is received, the alert tone will sound every 15 seconds.

- 1) With the phone in standby mode, press the **menu/clock** key five times. You hear "Message alert" and the current setting ([OFF] Off or [ON] On), and it is displayed on the base. Then you hear the guidance for setting the Message Alert Tone.
- 2) Press the **▲** or **▼/volume/select** key to make your selection.
- 3) Press the **set** key to select the new setting. You hear a confirmation tone, then the announcement "Message alert" followed by the current setting you have selected. When the first new message is received, the alert tone will begin to sound.

You can also turn off the Message Alert tone by pressing any key on the base unit. The tone will deactivate until another new message is received.

Turning Message Alert tone off when you're away from your phone:

When all **new messages** are played back using the remote playback feature (see page 46,) the Message Alert tone will automatically deactivate. The tone will not deactivate until all messages are played back.

## Setting Your Outgoing Message (Greeting)

When you receive a call, the answering system automatically plays either a preset message or your own greeting.

### ▼ Preset message

The following message is prerecorded: "Hello, no one is available to take your call. Please leave a message after the tone."



See "Selecting the Message Record Time" on page 37 on how to set the announce only feature.



### ▼ Recording a personal outgoing message (Greeting)

- 1) Press and hold the ***greeting*** key in standby mode. You hear the announcement "Record greeting" and a confirmation tone. [- -] flashes on the message counter.
- 2) Start recording your message. You have 30 seconds, and the message counter starts to count down [30] to [1] every second.
- 3) When you are finished recording your greeting, press the ***greeting***, **▶/□** (play/stop) or ***set*** key. You hear a confirmation tone, and then your greeting plays back for you.

### ▼ Choosing between the two outgoing messages

With the phone in standby mode, press the ***greeting*** key. Then press the ***greeting*** key again while the outgoing message is played. This switches between the prerecorded greeting and the personal greeting. After finishing playing back the message, a confirmation tone is heard.



To delete the personal greeting, press the **∅** (delete) key during the announcement and the system announces "Greeting has been deleted."



- Your greeting must be more than 2 seconds and less than 30 seconds to record.
- Position yourself as near to the base's microphone as possible and speak clearly when recording your outgoing message.

## note

- Although you have set the base ringer to off, you will still hear the ringer from the handset on the base if its ringer is on.

### Setting the Base Ringer Volume

You will hear three ringer options. One allows you to turn the ringer off. The other two are volume levels. You can change the ringer volume while in standby mode or the incoming call is ringing.

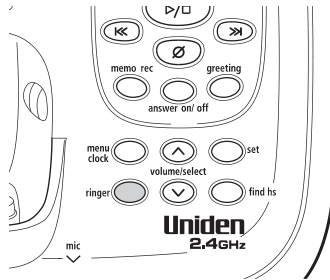

- 1) Press the **ringer** key. You hear the ringer at the current volume level ([ **H** ] high, [ **L** ] low, [ **OFF** ] off) (if you set the base ringer volume to off, "Ringer off" is announced) and it is displayed on the base.
- 2) Press the **ringer** key repeatedly until the desired ringer option appears.
- 3) The system displays the new ringer volume.

### Temporarily Mute the Base Ringer and Call Screen

Press the P/□ (play/stop) key to temporarily mute the incoming ring and call screen. To turn the ringer back on for this call, press the **ringer** key. To hear the answering machine and screen this call, press the **∧** or **∨**/**volume/select** key. The ringer will sound with the next incoming call.

### Adjusting the Speaker Volume Level

You can adjust the volume of the base speaker by pressing the **∧** or **∨**/**volume/select** key on the base. Press the **∧**/**volume/select** key for louder or the **∨**/**volume/select** key for softer while the base speaker is being used except for menu mode. The numbers [ **0** ]-[ **9** ] are displayed on the base indicating the volume levels. [ **0** ] being the softest and [ **9** ] being the loudest.

## Using Your Answering System

The message counter displays the number of messages stored in memory. If the display flashes, then there are new messages waiting for you. The answering system is designed to play your new messages first. After you play all your new messages, you can then play your old messages.

**note** When the answering system is full, [FL] is displayed on the base, and the system announces "No remaining time." You should delete some messages so that the system can record new messages. (Refer to "Deleting a Message" on page 44.)

### Playing your messages

- 1) When the base is in standby mode, press  $\triangleright/\square$  (play/stop). The system announces the number of new and old messages while the message counter displays only the number of new messages. The time and day that each message was received is announced after the message is played. The message counter will then display the number of currently stored messages.
- 2) When all new messages have been played, you hear a confirmation tone, and the system announces "End of messages." The system returns to standby. After you have reviewed your new messages, you can play your old messages by pressing  $\triangleright/\square$  (play/stop) again. Once you have listened to a new message, it then becomes an old message. The old messages will be played in the order in which they were received.

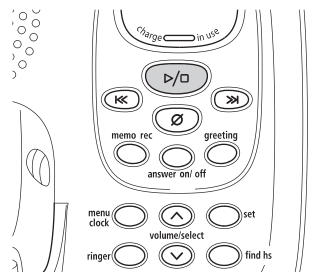

- To stop playing your messages, press the  $\triangleright/\square$  (play/stop) key again at any time.

### **Repeating a message**

- 1) Press  $\triangleright/\square$  (play/stop) to review your messages. The number of stored messages is announced.
- 2) To repeat the current message, press  $|\ll$  (repeat/rew) after a few seconds of beginning the message. To quickly scroll backwards through a message, press and hold  $|\ll$  (repeat/rew). To repeat the previous message, press  $|\ll$  (repeat/rew) within a few seconds (about four seconds during remote operation) after a message begins playing. If you have several messages, press  $|\ll$  (repeat/rew) repeatedly until you return to the message you want to replay. If the current message is the first new message, the system plays back from the beginning of the current message. The system will not go back into the old message group until all new messages have been heard.
- 3) Press  $\triangleright/\square$  (play/stop) at any time to stop reviewing messages and return to standby. The message counter shows the number of messages stored in memory.

### **Skipping a message**

- 1) Press  $\triangleright/\square$  (play/stop) to review your messages. The number of stored messages is announced.
- 2) Press  $\gg|$  (skip/ff) at anytime to skip to the next message.  
Each time you press  $\gg|$  (skip/ff), the system scans forward one message. If you have several messages, press  $\gg|$  (skip/ff) repeatedly to find the message you want to play. To quickly scroll through a message, press and hold  $\gg|$  (skip/ff). The system advances through the playback at double speed.
- 3) Press  $\triangleright/\square$  (play/stop) at anytime to stop reviewing your messages and return to standby. The message counter shows the number of messages stored in memory.

## Deleting a message

To maintain maximum record time, delete the old messages. When you press  $\emptyset$  (delete), you are permanently deleting the message. Once deleted, the message cannot be replayed or retrieved.

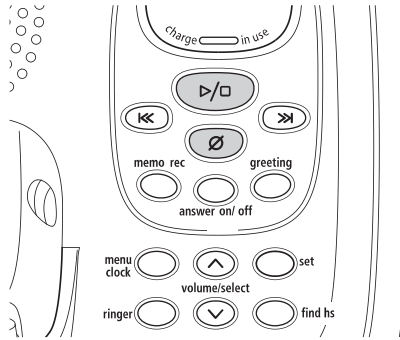

- 1) Press ▷/◻ (play/stop) to review your messages.
- 2) Press the  $\emptyset$  (delete) at anytime during the message to delete the message. You hear a confirmation tone and the message is deleted.
- 3) To delete all messages, press  $\emptyset$  (delete) when the phone is in standby mode. You will hear the announcement "To delete all messages, press  $\emptyset$  (delete) again".
- 4) Press  $\emptyset$  (delete) again. You hear a confirmation tone and [ ] is displayed on the base . All messages are deleted.

When you try to delete all messages without first listening to your new messages, you hear several short beeps followed by an announcement "Please playback all messages." This protects you from accidentally erasing messages you have not yet reviewed.

# note

- The voice memo recorded is completely independent of the greeting message.
- The voice memo messages are recorded as incoming messages.
- When the answering system is full, [ **FL** ] appears on the message counter, and recording is terminated.

## Voice memo

The voice memo function allows the user to record messages (more than two seconds and less than four minutes).

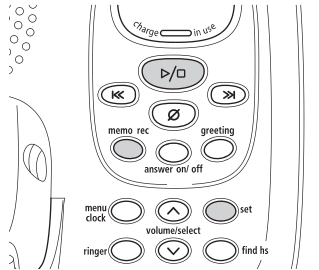

- 1) With the phone in standby mode, press and hold the **memo rec** key. You will hear the announcement "Record Memo Message" and a tone. [ - - ] flashes on the message counter.
- 2) Start your recording.
- 3) When you have finished, press the **▷/□** (play/stop), **memo rec** or **set** key to stop recording. You hear a confirmation tone and the system returns to standby.

## Remote Operation

You can operate your answering system from a remote location (when you are away from home, or from another room using a handset). Use this function to check for recorded messages, to play or delete message. When using any touch-tone telephone, you can even record a new greeting message.

### Remote access away from home

You can operate your answering system from a remote location using any touch-tone telephone.

- 1) Call your telephone number.
- 2) During the greeting message, press # and enter your PIN code (see page 35).
- 3) The answering system announces the current time and the number of messages stored in memory. You hear "To play incoming messages, press pound two. For help, press pound zero." (Pressing pound is the same as pressing # key)
- 4) You may continue to listen to the voice prompts or you may select a command from the following chart:



- For your convenience remote operation cards are provided for you to use while away from home (located in the back of this manual).
- Once you enter the remote access menu, you must enter a command within 15 seconds, or the answering system automatically hangs up and returns to standby.

Command	Function	Command	Function
# then 1	Repeat a Message*	# then 6	Answering System On
# then 2	Play incoming Messages	# then 7	Memo Record/ Stop**
# then 3	Skip a Message	# then 8	Greeting Message Record/ Stop**
# then 4	Delete a Message	# then 9	Answering System Off
# then 5	Stop Operation	# then 0	Help

\* For the Repeat a Message function, press # then 1 within about four seconds to repeat the previous message, or press # then 1 after about four seconds to repeat the current message.

\*\* For Memo Record and Greeting Message Record function, the first time you enter the corresponding command, it starts the Recording function. If you want to stop the recording, enter the command again.

5) After the command has finished, you hear intermittent beeps indicating that the system is in the command waiting mode. You may enter another command at this time from the chart above.

6) When you are finished, hang up to exit the system. The answering system automatically returns to standby.



## Turn on the Answering System Remotely

If you have forgotten to turn on your answering system, you can turn it on remotely from any touch-tone telephone.

- 1) Call your telephone number.
- 2) Wait 15 rings until the system answers. You hear intermittent beeps.
- 3) Press **#** and then enter your PIN code. The answering system announces the number of messages stored in memory. You hear "To play incoming messages, press pound two.  
For help, press pound zero."
- 4) Press **#** then **6** to turn the answering system on. You hear the outgoing message and a confirmation tone.
- 5) Hang up the phone, subsequent calls will be answered by the system.

## Remote access with the handset (XSA1255 only)

You can operate your answering system from another room using a handset.

- If you press the **end** key before the answering system answers, the phone will return to standby.
  - If the answering system does not answer within 5 seconds, you hear a beep and the phone will return to standby.
  - The base's keypad is disabled during remote operation
  - When you receive a call, the remote operation is cancelled.
  - You can change the handset volume during a remote operation.
  - If you have new messages and old messages, after you have reviewed your new messages, you can play your old messages by pressing **> / 2** again.
- 1) When the phone is in standby mode, press the **select/remote** key on the handset. Remote Answering Machine operation appears on the handset display. The answering system announces the current time and the number of messages stored in the memory.
  - 2) You hear the announcement, "To play incoming messages, press two; For help, press zero."
  - 3) Enter a command within 15 seconds. You may select a command from the chart below.
  - 4) After the command has finished, you hear intermittent beeps indicating that the system is in the command waiting mode. You may enter another command at this time from the chart below.
  - 5) When you are finished, hang up to exit the system. The answering system automatically returns to standby.

Command	Function	Command	Function
<b>&lt;&lt; / 1</b>	Repeat a Message	<b>□ / 5</b>	Stop Operation
<b>▷ / 2</b>	Play incoming Messages	<b>6</b>	Answering System On
<b>&gt;&gt; / 3</b>	Skip a Message	<b>9</b>	Answering System Off
<b>∅ / 4</b>	Delete a Message	<b>0</b>	Voice Prompts

## Changing the Digital Security Code

To protect you against misbilled calls which might result from your phone being activated by other equipment, the cordless phone provides **AutoSecure** (which electrically locks your phone when each handset is in the cradle) and **Random Code** digital security which automatically selects one of over 262,000 digital security codes for each handset and the main base. If the handset battery pack is completely discharged or the battery pack is removed, the digital security code will be lost. If this happens, a new security code is set automatically the next time the battery pack is charged. In the rare situation that you suspect another cordless telephone is using the same security code, you can change the code.

### For XSA1255;

- 1) Remove the handset from the cradle. Press and hold the **find hs** key on the main base.
- 2) While holding the **find hs** key, place the handset in the main base, and leave the handset in the main base for more than three seconds. A new random security code is set.

### For XSA1255+1;

- 1) Remove the handset from the cradle. Press and hold the **find hs** key on the main base.
- 2) While holding the **find hs** key, place the handset in the main base, and leave the handset in the main base for more than three seconds.
- 3) Remove the handset from the main base. Then place the second handset in the main base and wait for more than three seconds. No need to hold the **find hs** key this time.
- 4) Press the **talk/flash** key on one handset. Once you make sure **Talk** appears on the display, press the **end** key. Then, try with the second handset. If each handset displays **Talk**, a new security codes set. Otherwise, return to step 1 and try again.

## Note on Power Sources

**Low battery alert** When the battery pack is very low and needs to be charged, the phone is programmed to eliminate functions in order to save power. If the phone is not in use, **Low Battery** appears on the LCD and none of the keys will operate. If the phone is in use, **Low Battery** flashes and the handset beeps. Complete your conversation as quickly as possible and return the handset to the cradle for charging.

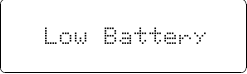

Information stored in the phone's memory will be retained for 30 minutes after the battery pack is removed. This includes all setup information, last number dialed, speed dial memory, RocketDial programming, and the CID list.

Even when the battery pack is not being used, it will gradually discharge over a long period of time. For optimum performance, be sure to return the handset to the cradle after a telephone call.

### Battery replacement and handling

When the operating time becomes short even after a battery is recharged, please replace the battery. With normal usage, your battery should last about one year. A replacement battery may be purchased by visiting our website [www.uniden.com.au](http://www.uniden.com.au) or [www.uniden.co.nz](http://www.uniden.co.nz)

**Warning:** To avoid the risk of personal injury or property damage from fire or electrical shock, only use the Uniden battery model and Uniden adapter model specifically designated for this product.

### Power Failure

During the period that the power is off, you will not be able to make or receive calls with the telephone.

### Caution

- Use only the specified Uniden battery pack (BT-905 or BT-905s).
- Do not remove the batteries from the handset to charge them.
- Never throw the battery into a fire, disassemble them, or heat them.
- Do not remove or damage the battery casing.

### Cleaning the battery charging contacts

To maintain a good charge, clean the charging contacts on the handset once a month. Dampen a cloth with plain water. Gently rub the damp cloth over the charging contacts until all visible dirt is removed.

Dry the contacts thoroughly before returning the handset to the base.

**Caution:** Do not use paint thinner, benzene, alcohol, or other chemical products. Doing so may discolour the surface of the telephone and damage the finish.

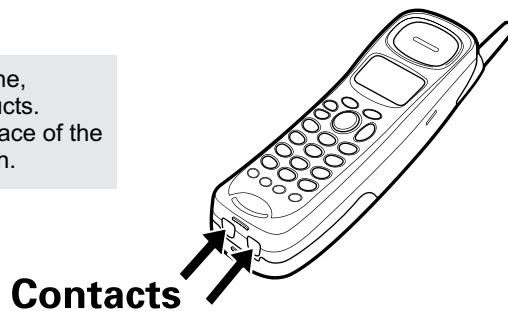

## General Information

### Operating temperature:

0 °C to +50 °C (+ 32 °F to +122 °F)

### AC Adapter Information

AC Adapter part number: AAD-041S, AAD-210S (XSA1255+1 extra charger adaptor)  
Input Voltage: 230-240VAC 50Hz  
Output Voltage: 9V DC 350mA , 210mA (XSA1255+1 extra charger adaptor)

### Battery Information

Battery part number: BT- 905 or BT-905s  
Capacity: 600mAh, 3.6V 500mAh, 3.6V



- To avoid damage to the phone use only Uniden AAD-041S and AAD-210S, and BT-905 or BT-905s with your phone.
- If the handset is left off of the base, the actual Talk mode duration will be reduced respective to the amount of time the handset is off the base.

Recharge your phone on a regular basis by returning the handset to the base after each phone call. When the operating time becomes short even after the battery is recharged, please replace the battery. With normal usage, the battery should last about one year.

Please contact your retailer for replacement adaptors or batteries or visit our website at [www.uniden.com.au](http://www.uniden.com.au) or [www.uniden.co.nz](http://www.uniden.co.nz).

Specifications, features, and availability of optional accessories are all subject to change without prior notice.

## Troubleshooting

If your phone is not performing to your expectations, please try these simple steps first. If these steps do not solve your problem, visit our website for further information ([www.uniden.com.au](http://www.uniden.com.au) or [www.uniden.co.nz](http://www.uniden.co.nz)).

Symptom	Suggestion
The <b>charge/ in use</b> LED or <b>charge</b> LED won't illuminate when the handset is placed in the cradle.	<ul style="list-style-type: none"> <li>• Make sure the AC adapter is plugged into the cradle and wall outlet.</li> <li>• Make sure the handset is properly seated in the cradle.</li> <li>• Make sure the charging contacts on the handsets are clean.</li> </ul>
Interference. The audio sounds weak and/ or scratchy.	<ul style="list-style-type: none"> <li>• Move the handset and/ or main base away from metal objects or appliances and try again.</li> <li>• Press the <b>delete/channel</b> key (XSA1255) or the <b>select/channel</b> key (XSA1255+1) in the talk mode to help eliminate background noise.</li> <li>• Make sure that the handset is not too far from the main base.</li> </ul>
Can't make or receive calls.	<ul style="list-style-type: none"> <li>• Re- register both handsets (see page 12) (XSA1255+1 only).</li> <li>• Check both ends of the telephone cord.</li> <li>• Make sure the AC adapter is plugged into the main base and wall outlet.</li> <li>• Disconnect the AC adapter for a few minutes. Then reconnect it.</li> <li>• Change the digital security code (see page 50).</li> <li>• Make sure that the handset is not too far from the main base.</li> <li>• Check the dialing mode used by your telephone company.</li> </ul>

Symptom	Suggestion
The handset doesn't ring or receive a page.	<ul style="list-style-type: none"> <li>• Re- register both handsets (see page 12)(XSA1255+1 only).</li> <li>• The battery pack may be weak. Charge the battery for 15- 20 hours.</li> <li>• The handset may be too far from the main base.</li> <li>• Place the main base away from appliances or metal objects.</li> <li>• Change the digital security code (see page 50).</li> <li>• Check the battery pack to ensure there is a secure connection.</li> <li>• Make sure ringer volume isn't set to "off."</li> </ul>
Severe noise interference.	<ul style="list-style-type: none"> <li>• Keep both handsets away from microwave ovens, computers, remote control toys, wireless microphones, alarm systems, intercoms, room monitors, fluorescent lights, and electrical appliances.</li> <li>• Move the main base to another location or turn off the source of interference.</li> <li>• Press the <b>delete/channel</b> key (XSA1255) or the <b>select/channel</b> key (XSA1255+1) in the talk mode to help eliminate background noise.</li> </ul>
The Caller ID does not display.	<ul style="list-style-type: none"> <li>• The call was answered before the second ring.</li> <li>• The call was placed through a switchboard.</li> <li>• Charge the handset.</li> <li>• Your Caller ID service may not be active; contact your local telephone service provider.</li> </ul>
The answering system does not work.	<ul style="list-style-type: none"> <li>• Make sure the AC adapter is plugged into wall outlet.</li> <li>• Make sure the answering system is turned on.</li> </ul>
The answering system does not record any messages.	<ul style="list-style-type: none"> <li>• Set the record time to either the one minute or four minutes option.</li> <li>• The memory may be full. Delete some or all of the saved messages.</li> </ul>
Messages are incomplete.	<ul style="list-style-type: none"> <li>• The incoming messages may be too long. Remind callers to leave a brief message.</li> </ul>



Symptom	Suggestion
After a power failure, the outgoing message is deleted.	<ul style="list-style-type: none"> <li>Record your personal outgoing message again. The default message should remain.</li> </ul>
No sound on the base unit speaker during call monitoring or message playback.	<ul style="list-style-type: none"> <li>Adjust the speaker volume on the base unit.</li> </ul>
Cannot access remote call-in features from another touch-tone phone.	<ul style="list-style-type: none"> <li>Make sure you're using the correct PIN code.</li> <li>Make sure that the touch-tone phone you're using can transmit the tone for at least two seconds. If it cannot, you may have to use another phone to access your messages.</li> </ul>
Handset No. 1 or No. 2 is not working (XSA1255+1 only).	<ul style="list-style-type: none"> <li>Make sure the battery pack is connected to the handset and fully charged.</li> <li>Re- register the non- functional handset.</li> </ul>
Unavailable message is displayed on the LCD screen of the handset (XSA1255+1 only).	<ul style="list-style-type: none"> <li>Make sure the other handset is not already in use. Both handsets cannot be in talk mode at the same time.</li> <li>Place the handset in the main base for at least 5 seconds to re- register to the main base.</li> <li>Make sure the handset is not too far from the main base when trying to use.</li> </ul>
The handset doesn't communicate with the main base or the other handset (XSA1255+1 only).	<ul style="list-style-type: none"> <li>Re- register both handsets</li> </ul>
No 3- way conversation	<ul style="list-style-type: none"> <li>Only one handset at a time can talk with an outside caller. To allow the other handset to talk to the caller, transfer the call.</li> </ul>

## Liquid Damage

Moisture and liquid can damage your cordless phone. In case of accidental submersion, please read the following steps.

Case	Action
If the handset or base is exposed to moisture or liquid, but it only affects the exterior plastic housing.	Wipe off the liquid, and use as normal.
If moisture or liquid has entered the plastic- housing (i. e. liquid can be heard in the phone or liquid has entered the handset battery compartment or vent openings on the base).	<p><b>Handset:</b></p> <ol style="list-style-type: none"><li>1) Remove the battery cover and leave it off for ventilation.</li><li>2) Remove the battery pack by disconnecting.</li><li>3) Leave the battery cover off and the battery pack disconnected for at least 3 days.</li><li>4) Once the handset is completely dry, reconnect the battery pack and he battery cover.</li><li>5) Recharge the handset's battery pack for 20 hours before using again.</li></ol> <p><b>Base:</b></p> <ol style="list-style-type: none"><li>1) Disconnect the AC adaptor from the base unit, cutting off electrical power.</li><li>2) Disconnect the telephone cord from the base unit.</li><li>3) Let dry for at least 3 days.</li></ol> <p><b>IMPORTANT:</b> You must unplug the telephone line while recharging the battery pack to avoid charge interruption.</p> <p><b>CAUTION:</b> DO NOT use a microwave oven to speed up the drying process. This will cause permanent damage to the handset, base and the microwave oven. After following these steps, if your cordless telephone does not work, please visit our website for further information (<a href="http://www.uniden.com.au">www.uniden.com.au</a> or <a href="http://www.uniden.co.nz">www.uniden.co.nz</a>).</p>

## Index

### A

AC adapter information	53
Announce only feature	37
Answering system	
Deleting a message	44
Playing a message	42
Remote access	46
Repeating a message	43
Skipping a message	43
Turning on/off	32

### B

Basic setup	14
Battery pack	
Information	53
Installing	7
Preparing and charging	7
Replacement and handling	51
Beltclip installation	10

### C

Call transfer feature	19
Call waiting	21
Caller ID service	28
Call waiting	31
Deleting	30
Making a call	31
Viewing	29
Channel	21
Charging the battery pack	8
Cleaning contacts	52
Clock	34
Connect the base unit	8

Controls and functions	3,4
------------------------	-----

### D

Digital security code	50
-----------------------	----

### E, F, G, H, I, J, K, L

Earpiece volume	20
Find Handset	21
General information	53
Greeting	39
Headset installation	11

### I

Installing the phone	6
Liquid damage	57

### M, N, O, P, Q

Making a call	18
Menu mode	33
Message alert	38
Outgoing message	39
Personal security code (PIN code)	35

### R

Receiving a call	18
Record time	37
Redial	19
Remote access	46
Ring time	36
Ringer tone	17
Ringer volume (Base)	41
RocketDial	22

### S

Second Handset	12
----------------	----

Speed dial memory	
Making calls from speed dial memory	23
Storing names and numbers in speed dial memory	23

### T, U

Transferring a call	19
Traveling out-of-range	20
Troubleshooting	54

### V, W, X, Y, Z

Voice Memo	45
Volume control	
Base	41
Handset	17,20
Wall mounting	9
Warranty	62



# Memo



# Remote Operation Card / Memory List

C U T

## REMOTE OPERATION CARD

Uniden

### Remote access away from home

1. Call your phone number from a touch-tone phone.
2. During the outgoing message, press # and enter your PIN code. The answering system announces the number of messages stored in memory and the voice prompts. The phone stands by for you to enter a command.
3. To quit, hang up the phone.

### Turn on the answering system remotely

1. Call your phone and let it ring 15 times until it answers.
2. Press # and enter your PIN code.
3. Press # then 5 to stop the announcement.
4. Press # then 6 to turn the answering system on.

C U T

## MEMORY LOCATION MEMO

Memory Location	Name	Phone Number
1		
2		
3		
4		
5		

C U T

## REMOTE OPERATION CARD

Uniden

### Remote access away from home

1. Call your phone number from a touch-tone phone.
2. During the outgoing message, press # and enter your PIN code. The answering system announces the number of messages stored in memory and the voice prompts. The phone stands by for you to enter a command.
3. To quit, hang up the phone.

### Turn on the answering system remotely

1. Call your phone and let it ring 15 times until it answers.
2. Press # and enter your PIN code.
3. Press # then 5 to stop the announcement.
4. Press # then 6 to turn the answering system on.

C U T

## MEMORY LOCATION MEMO

Memory Location	Name	Phone Number
1		
2		
3		
4		
5		

## Remote Operation Card / Memory List

C U T

### MEMORY LOCATION MEMO

Memory Location	Name	Phone Number
6		
7		
8		
9		
10		

C U T

Task	Key
Repeat a Message	# 1
Play Incoming Messages	# 2
Skip a Message	# 3
Delete a Message	# 4
Stop Operation	# 5
Answering System On	# 6
Memo Record/Stop	# 7
Greeting Message Record/Stop	# 8
Answer System Off	# 9
Voice Prompts	# 0

C U T

### MEMORY LOCATION MEMO

Memory Location	Name	Phone Number
6		
7		
8		
9		
10		

C U T

Task	Key
Repeat a Message	# 1
Play Incoming Messages	# 2
Skip a Message	# 3
Delete a Message	# 4
Stop Operation	# 5
Answering System On	# 6
Memo Record/Stop	# 7
Greeting Message Record/Stop	# 8
Answer System Off	# 9
Voice Prompts	# 0

## One Year Limited Warranty

### UNIDEN XSA1255/XSA1255+1 CORLDESS PHONE

**Important:** Evidence of original purchase is required for warranty service.

**Warrantor:** Uniden Australia Pty Limited A.B.N. 58 001 865 498 Uniden New Zealand Limited

**Warranty is only valid in the original country of purchase.**

**ELEMENT OF WARRANTY:** Uniden warrants to the original retail owner for the duration of this warranty, its XSA1255/XSA1255+1 (herein after referred to as the Product), to be free from defects in materials and craftsmanship with only the limitations or exclusions set out below.

**WARRANTY DURATION:** This warranty to the original retail owner only, shall terminate and be of no further effect ONE (1) year after the date of original retail sale. This warranty will be deemed invalid if the Product is;

- (A) Damaged or not maintained as reasonable and necessary,
  - (B) Modified, altered or used as part of any conversion kits, subassemblies, or any configurations not sold by Uniden,
  - (C) Improperly installed,
  - (D) Repaired by someone other than an authorized Uniden Repair Agent for a defect or malfunction covered by this warranty,
  - (E) Used in conjunction with any equipment or parts or as part of a system not manufactured by Uniden, or
  - (F) Where the Serial Number label of the product has been removed or damaged beyond recognition.
- Warranty only valid in the country of original retail/sale.

**PARTS COVERED:** This warranty covers for one (1) year, the Product and included accessories.

**STATEMENT OF REMEDY:** In the event that the Product does not conform to this warranty at any time while this warranty is in effect, the warrantor at its discretion, will repair the defect or replace the Product and return it to you without charge for parts or service. This warranty does not provide for reimbursement or payment of incidental or consequential damages.

This EXPRESS WARRANTY is in addition to and does not in any way affect your rights under the TRADE PRACTICES ACT 1974 (Cth) (Australia) or the CONSUMER GUARANTEES ACT (New Zealand).

**PROCEDURE FOR OBTAINING PERFORMANCE OR WARRANTY:** In the event that the Product does not conform to this warranty, the Product should be shipped or delivered, freight pre-paid, with evidence of original purchase (eg. a copy of the sales docket), to the warrantor at:

#### UNIDEN AUSTRALIA PTY LIMITED SERVICE DIVISION

345 Princes Highway,  
Rockdale,  
NSW 2216,  
AUSTRALIA  
Fax: (02) 9599 3278  
www.uniden.com.au

#### UNIDEN NEW ZEALAND LIMITED SERVICE DIVISION

150 Harris Road,  
East Tamaki,  
Auckland,  
NEW ZEALAND  
Fax: (09) 274 4253  
www.uniden.co.nz

**THANK YOU FOR BUYING A UNIDEN PRODUCT.**

**Uniden<sup>®</sup>**

© 2007 Uniden Australia Pty Limited. Uniden New Zealand Ltd. Printed in China UPZZ01062ZA(0)



## Free Manuals Download Website

<http://myh66.com>

<http://usermanuals.us>

<http://www.somanuals.com>

<http://www.4manuals.cc>

<http://www.manual-lib.com>

<http://www.404manual.com>

<http://www.luxmanual.com>

<http://aubethermostatmanual.com>

Golf course search by state

<http://golfingnear.com>

Email search by domain

<http://emailbydomain.com>

Auto manuals search

<http://auto.somanuals.com>

TV manuals search

<http://tv.somanuals.com>