

# PRO501XL

## Citizens Band Radio

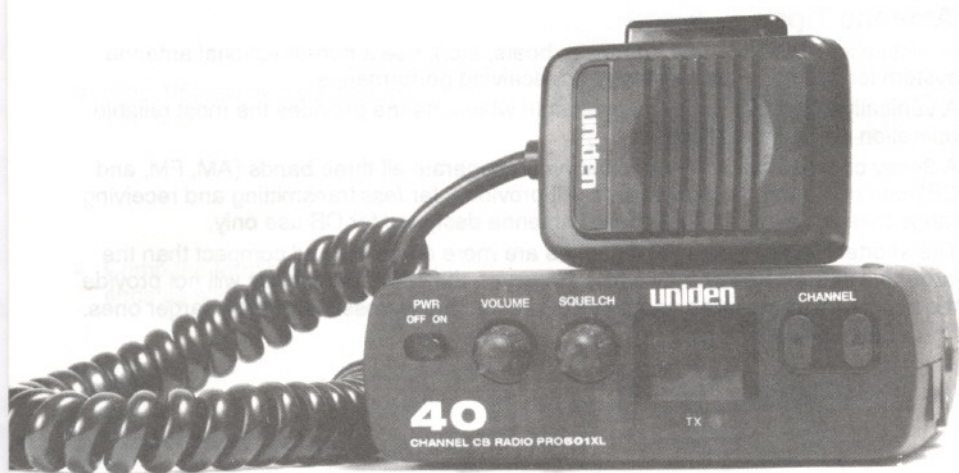

Australian Edition

**uniden®**

OPERATING GUIDE

---

---

# Introduction

---

---

Welcome to the world of CB radio communication. Your Uniden **PRO501XL** represents the most advanced portable radio ever designed for use in the Citizens Band Radio Service. This powerful unit operates on any of the 40 AM frequencies authorized by the Spectrum Management Agency (SMA).

Among its many features, the **PRO501XL** includes:

- *Superheterodyne circuitry* to enhance receiver quality.
- *Phase Locked Loop Synthesizer* techniques to assure precise frequency control.
- Built-in Automatic Noise Limiter

This radio has been type accepted and fully certified by the SMA.

## WARNING

The Citizen Band Radio Communication Service (CBRS) is under the jurisdiction of the Australian Spectrum Management Agency (SMA). Any adjustment or alteration which will change the performance of the transceiver's original SMA type acceptance is **STRICTLY PROHIBITED**. Replacement or substitution of power or frequency determining components e.g. Crystals, Transistors, IC's, Diodes, or any part of a unique nature, with parts other than those recommended by Uniden may cause violation to the SMA type acceptance technical requirement.

## Licensing Requirements

Before using your transceiver, you must obtain a Citizen Band Radio License from the Spectrum Management Agency (SMA). Application forms and brochures relating to CBRS are available at your nearest SMA office. Mail the completed application form and the appropriate fee to the Communications Manager of SMA, in the State or Territory in which the station will be operated.

## Unpacking Your CB Radio

The following items are included with your **PRO501XL**:

- **PRO501XL** CB Radio
- Mounting Bracket Kit
- This Operating Guide (Read it carefully and save)
- Microphone Hanger Clip
- Australian Warranty Program and Product Registration Form

The following items are included with your **PRO501AXL**:

- **PRO501AXL** CB Radio
- Microphone Hanger Clip
- Magnetic Mount Antenna
- Mounting Bracket Kit
- Cigarette Lighter Adapter Plug
- This Operating Guide (Read it carefully and save)
- Australian Warranty Program and Product Registration Form

If any items are missing or damaged, contact your place of purchase immediately. *Be sure to complete and mail in the Product Registration Card.*

*Features, Specifications and availability of Optional Accessories are all subject to change without notice.*

Uniden<sup>®</sup> is a registered trademark of Uniden Corporation.

---

---

# Operation

---

---

## Before operating the PRO501XL:

1. Be sure you read and understand SMA Rules and Regulations.
2. Be sure that the power cord, microphone and antenna are properly connected.
3. Turn the power on by sliding the **PWR** switch to ON.

## Receive

1. Use the **CHANNEL SELECTOR** buttons to select any of the 40 channels.
2. Set the **VOLUME** control to a comfortable listening level.
3. Adjust the **SQUELCH** control to eliminate background noise during the absence of a signal. Rotate **SQUELCH** to the right until the noise disappears (no signal should be present). Leave the control at this setting. The receiver will remain quiet until a signal is actually received.

**Note:** Do not advance the control too far, or some weaker signals will not be heard.

## Transmit

1. Set the **CHANNEL SELECTOR** to the desired channel.
2. If the channel is clear, press the **Push-To-Talk Button** on the microphone. Be sure to speak clearly into the microphone.

**IMPORTANT:** All channels, except channel 9, may be used for normal communication. Channel 9 is reserved for emergency communications involving the immediate safety of individuals or the protection of property.

**This is a rule and applies to all operators of CB radios.**

## Emergency Operation

1. Press the **CHANNEL SELECTOR** buttons to reach Channel 9. If the channel is clear, press the **Push-to-Talk** switch on the microphone to talk. Hold the microphone a few inches away and speak clearly.
2. It is possible that your present location is out of range to those who monitor Channel 9. If there is no response to your emergency call on Channel 9, set the **CHANNEL SELECTOR** to find an active channel. Ask the party on that channel for assistance in relaying your emergency message on Channel 9 in their area.

## Rules You Should Know

When operating your CB, there are a few important rules to observe:

- It is prohibited to blast others off the air by overpowering them with illegally amplified transmitter power.
- You must not use the CB to promote illegal activities.
- It is illegal to use profanity.
- You may not play music in your CB.
- You may not use your CB to sell merchandise or professional services.

# PRO501AXL Accessories

## To connect the Cigarette Lighter Adapter Plug:

**IMPORTANT:** *The Cigarette Lighter Adapter Plug is designed to be used **ONLY** with **negative** ground vehicles. Do not attempt to operate the unit with the Adapter Plug connected to a positive ground vehicle.*

1. Remove the screw from the top half of the plug shell (Be careful not to lose the hex nut).

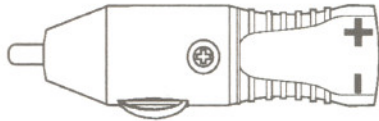

2. Carefully separate the two halves of the plug shell.

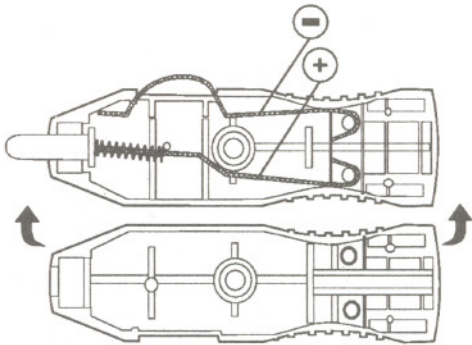

3. Strip 1/5 inch of insulation from each wire end.

4. Crimp the terminals onto the wire ends as shown.

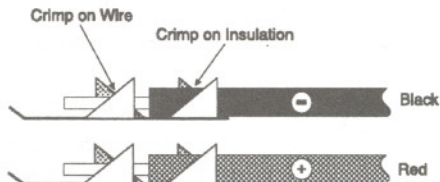

5. With the wires attached, insert the terminals into the plug shell.

**Note** *The **black** wire is inserted in the section of the shell marked **negative (-)**. The **red** wire is inserted into the section of the shell marked **positive (+)**.*

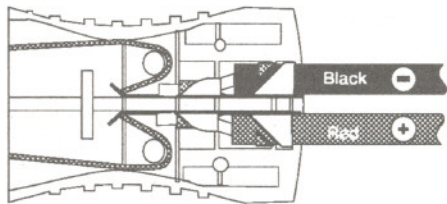

6. Join the two halves of the plug shell. Secure the plug shell with the screw and hex nut.

## Attaching the Magnetic Mount Antenna

1. Place the antenna in a convenient location on your vehicle.
2. Route the antenna cable through your vehicle's window, door, or other opening into the interior of the vehicle.
3. Attach the antenna cable to the terminal on the rear of the **PRO501AXL**.

**Note:** *Be sure to route the antenna where it will not interfere with the operation of your vehicle.*

---

---

## Controls And Functions

---

---

### Front Panel

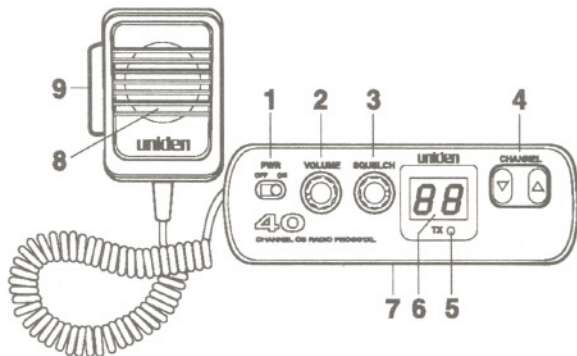

1. **PWR** Turns the unit on and off.
2. **VOLUME** Adjusts the volume level.
3. **SQUELCH** Adjusts the squelch level.
4. **Channel Selector** Selects any of the 40 CB channels.
5. **TX Indicator** LED lights to indicate when the radio is transmitting.
6. **Channel Display** A large LED shows the current channel in use.
7. **Speaker** Produces audible signals from incoming transmissions.
8. **Microphone** Transforms into transmission signals.
9. **Push-to-Talk Button** Switches the CB from receive to transmit mode.

### Rear Panel

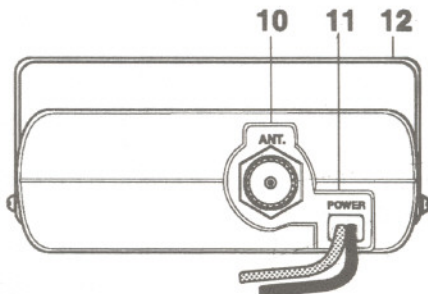

10. **Antenna connector** Provides a connection for an antenna.
11. **Power Cord** Connects to a vehicle's 12V negative ground electrical system.
12. **Mounting Bracket** A mounting kit is included with the radio.

---

---

# Installation

---

---

## Connecting the Power Cord

### WARNING

This radio can be used only in vehicles with a **negative ground** electrical system. Connecting this unit to a positive ground electrical system will result in serious damage to the radio.

1. Check the vehicle battery connections to determine which battery terminal (positive or negative) is grounded to the engine block or chassis. Most of today's automobiles are negative ground.
2. Connect the RED wire of the DC power cord to the accessory contact in your vehicle's +13.8 VDC fuse box.
3. Connect the BLACK wire of the DC power cord to the negative side of the automobile (usually the chassis).

## Mounting the Microphone Hanger

Mount the microphone hanger on the side of the radio. Mounting holes are provided on the right-hand side of the unit. Use the screws supplied. You can also mount the hanger on the dashboard if preferred.

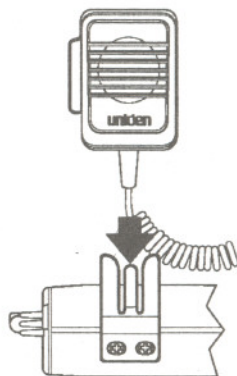

## Mounting the Radio Bracket

The design of the PRO501XL Mounting Bracket allows you to mount the radio in one of three angles for easy viewing of the front panel.

**Note:** *The speaker is located on the bottom of the radio. Be sure the mounting location does not obstruct this area.*

**Note:** *Mount the radio to the bracket only after the wiring has been connected to the rear panel and the microphone hanger has been installed.*

1. First select an ideal location in your vehicle to mount the PRO501XL. Make sure the location will not interfere with your driving. In a passenger car, the ideal installation is underneath the dashboard on the passenger side.
2. Remove the mounting bracket from the radio and use it as a template for marking the location of the mounting screws. (**Note:** If there are screws already holding the dashboard, you can use the same screw holes to mount the bracket in its place.)
3. Drill the necessary holes and secure the mounting bracket in place using the screws provided.

4. Secure the radio to the mounting bracket with the provided mounting knobs (2).
5. To mount the radio at an angle:
  - Loosen the mounting knobs.
  - Tilt the radio.
  - Tighten the mounting knobs.

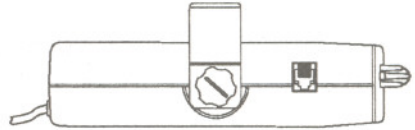

## Connecting the Microphone

Plug the Microphone Cord connector into the jack on the left-hand side of the radio.

## Connecting the Antenna

Connect the CB antenna plug to the **ANT.** jack on the rear panel. (For more information on antenna installation, please refer to the instruction guide that came with your antenna.)

## CB Antenna Tips

- In mobile installations (cars, trucks, or boats, etc.), use a non-directional antenna system for maximum transmitting and receiving performance.
- A vertically polarized, quarter-wavelength whip antenna provides the most reliable operation and greatest range.
- A 3-way combination antenna allows you to operate all three bands (AM, FM, and CB) with one antenna. However, it will provide a far *less* transmitting and receiving range than a standard "single band" antenna designed for CB use only.
- The shorter loaded-type whip antennas are more attractive and compact than the larger full quarter-wavelength whip. However, the shorter antennas will not provide the maximum transmitting and receiving range that is possible with the larger ones.

---

---

## Specifications

---

---

<b>Channels:</b>	40 AM
<b>Frequency Range:</b>	26.965 to 27.405 MHz
<b>Frequency Control:</b>	Phase Locked Loop (PLL) synthesizer
<b>Frequency Tolerance:</b>	$\pm 0.005\%$
<b>Operating Temperature:</b>	$-30^{\circ}\text{C}$ to $+60^{\circ}\text{C}$
<b>Microphone:</b>	Electret Condenser type
<b>Input Voltage:</b>	13.8 VDC nominal Negative Ground ONLY
<b>Size:</b>	120mm (W) x 170mm (D) x 40mm (H)
<b>Complete Package:</b>	0.46 kg.
<b>Antenna Connector:</b>	M-Type

### Transmitter

<b>Power Output:</b>	2.8 Watts (nom), 4.0 Watts (max)
<b>Modulation:</b>	Class B amplitude modulation
<b>Frequency Response:</b>	300 to 2500 Hz
<b>Output Impedance:</b>	50 $\Omega$ unbalanced

### Receiver

<b>Sensitivity:</b>	0.5 $\mu\text{V}$ for 10 dB; (S+N)/N typical
<b>Selectivity:</b>	6 dB @ 7 kHz, 70 dB @ 10 kHz typical
<b>Image Rejection:</b>	80 dB typical
<b>IF Frequency:</b>	Double Conversion Superheterodyne 1st: 10.692 MHz 2nd: 450 kHz
<b>Automatic Gain Control (AGC):</b>	Less than 10 dB change in audio output for inputs from 10 to 50,000 $\mu\text{V}$
<b>Squelch:</b>	Adjustable; threshold less than 1 $\mu\text{V}$
<b>Frequency Response:</b>	300 to 2000 Hz
<b>Distortion:</b>	Less than 10% at 0.4 watts, 1000 Hz
<b>Internal Speaker:</b>	16 $\Omega$ , 3 watts round

*Specifications shown are typical and subject to change without notice.*



---

---

## Troubleshooting

---

---

If the PRO501XL does not perform to your expectations, please try the troubleshooting suggestions listed below.

Problem	Suggestion
Unit does not power on.	<ul style="list-style-type: none"><li>• Check the wiring connections.</li><li>• Check the in-line fuse.</li><li>• Check the vehicle electrical system.</li></ul>
Poor reception.	<ul style="list-style-type: none"><li>• Check and adjust the SQUELCH.</li><li>• Check the antenna connections.</li></ul>
Weak Transmission.	<ul style="list-style-type: none"><li>• Check the antenna connections.</li></ul>

### Servicing Your CB

If you determine that service is necessary, contact your local dealer or return the unit in its original carton to Uniden - Service Division. Ship the item with a brief and concise description of the problem, your name, address, a telephone number where you can be reached during working hours and a copy of the original purchase receipt to the address listed in the warranty (at the end of this manual).

Technical information, diagrams, and charts are available upon request. It is the user's responsibility to see that this radio is operating at all times in accordance with the SMA Citizens Band Radio Service regulations. We highly recommend that you consult a qualified radiotelephone technician for service and alignment of this radio.

When ordering parts, please specify the correct model number and serial number of this radio.

Please refer to the "WARNING" information at the front of this manual.

---

---

## Care and Maintenance

---

---

The PRO501XL is designed to give you years of trouble-free service. There are no user-serviceable parts inside and, except for the fuse in the DC power cord, no maintenance is required.

**Note:** Do **not** expose the unit to moisture. Rain, dew, road splash, or other liquids may damage the internal components.

### Replacing the Fuse in the DC Power Cord

The in-line fuse holder contains a 2-ampere fuse to protect the radio from power surges.

To inspect or replace a blown fuse:

1. Press the ends of the fuse holder together and twist counterclockwise. Carefully separate the two halves.
2. Remove the fuse and inspect. If blown replace it with the *same* type.
3. Replace fuse inside the holder and reassemble the two halves by pressing the ends together and twisting clockwise.

---

---

# Warranty

---

---

## Uniden PRO501XL CB Radio Australian 2 Year Warranty. (Accessories are covered for 90 days only).

**Note:** Please keep your sales docket as it provides evidence of warranty.

**WARRANTOR:** Uniden Australia Pty. Ltd. ACN 001 885 498

**ELEMENTS OF WARRANTY:** Uniden warrants to the original retail owner for the duration of this warranty, its PRO501XL CB Radio (hereinafter referred to as the Product), to be free from defects in materials and craftsmanship with only the limitations or exclusions set out below.

**WARRANTY DURATION:** This warranty to the original user only shall terminate and be of no further effect Two (2) years after the date of original retail sale. This warranty will be deemed invalid if the product is (A) Damaged or not maintained as reasonable and necessary, (B) Modified, altered, or used as part of any conversation kits, subassemblies, or any configurations not sold by Uniden, (C) Improperly installed, (D) Repaired by someone other than an authorized Uniden Repair Agent for a defect or malfunction covered by this warranty, (E) Used in conjunction with any equipment or parts or as part of a system not manufactured by Uniden, (F) Installed, programmed or serviced by anyone other than an authorized Uniden Repair Agent, (G) Where the Serial Number label of the product has been removed or damaged beyond recognition.

**PARTS COVERED:** This warranty covers for 2 years; the PRO501XL Transceiver unit and Microphone only. All other accessories like Mounting Bracket, Mic Hanger, Leads, Screws, Magnet Mount Antenna (PRO501AXL only), and Cigarette Lighter Plug (PRO501AXL only), are covered for 90 days.

**STATEMENT OF REMEDY:** In the event that the product does not conform to this warranty at anytime while this warranty is in effect, the warrantor will at its discretion, repair the defect or replace the product and return it to you without charge for parts or service. THIS WARRANTY DOES NOT COVER OR PROVIDE FOR THE REIMBURSEMENT OR PAYMENT OF INCIDENTAL OR CONSEQUENTIAL DAMAGES.

**WARRANTY CARD:** If a warranty card had been included with this product, then please fill it in and return it to us within 14 days of purchase. Your name and the serial number of the product will then be registered in our database and this will help us to process your claim with greater speed and efficiency should you require warranty service.

**PROCEDURE FOR OBTAINING PERFORMANCE OF WARRANTY:** In the event that the Product does not conform to this warranty, the Product should be shipped or delivered, freight pre-paid, with evidence of original purchase, ( eg/ a copy of the sales docket), to the warrantor at:

### UNIDEN AUSTRALIA PTY. LTD.- SERVICE DIVISION

345 Princes Highway , Rockdale, NSW 2216

Ph(02) 599 3100 Fx (02) 599 3278

Customers in other States should ship or deliver the Product freight pre-paid to their nearest Uniden Authorized Repair Centre.  
(Contact Uniden for the nearest Warranty Agent to you).

## Free Manuals Download Website

<http://myh66.com>

<http://usermanuals.us>

<http://www.somanuals.com>

<http://www.4manuals.cc>

<http://www.manual-lib.com>

<http://www.404manual.com>

<http://www.luxmanual.com>

<http://aubethermostatmanual.com>

Golf course search by state

<http://golfingnear.com>

Email search by domain

<http://emailbydomain.com>

Auto manuals search

<http://auto.somanuals.com>

TV manuals search

<http://tv.somanuals.com>