

Uniden[®]

OWNER'S MANUAL

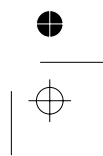

**UNIDEN Model uh089sx
UHF CB Radio**

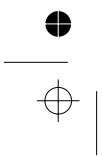

Contents

Introduction	
Features	2
Preventive Maintenance	2
Troubleshooting.....	2
Controls / Connectors	3
Indicators	4
Included with Your uh089sx	5
Operation	
Setting the Squelch	6
Monitor	6
Selecting a Channel	6
Transmitting	7
Call Function	7
Using Repeater Channels	7
Operating the uh089sx in Duplex Mode	8
Scanning.....	8
Open Scan (OS) Mode	8
Group Scan (GS) Mode.....	9
Programming Scan Channels	9
Selecting the Call tone	10
Roger Beep	10
Busy Channel Lockout	10
VOX Operation (optional VOX headset required)	11
Programming the Instant Priority Channel	11
Recalling the Instant Channel	11
CTCSS (Continuous Tone Coded Squelch System)	11
DCS (Digital Coded Squelch).....	11
UHF CB Channels & Frequencies.....	12
CTCSS & DCS Code List	13
Warranty	15

UNIDEN Model uh089sx UHF CB Radio

Introduction

The Uniden uh089sx is designed to provide you with years of trouble free service. Its rugged components and materials are capable of withstanding harsh environments. Please read this Operating Manual carefully to ensure you gain the optimum performance of the unit

NOTE

The citizen band radio service is licenced in Australia by ACMA Radio-communications (Citizen Band Radio Stations) Class Licence and in New Zealand by MED General User Licence for Citizen Band Radio and operation is subject to conditions contained in those licenses.

Features

- Transmit & Receive FM 40CH (UHF-CB, TX Power 5W), Transmission is inhibited at CH22 & CH23
- LCD Display with Backlight
- Signal Strength Meter
- RF Power Meter
- Speaker Audio Volume Level Meter
- Instant Channel
- One touch Instant Channel recalling
- Duplex Capability (from CH01 - CH08 per channel)
- Group Scan and Priority Channel Watch
- Open Scan
- Scan Channel Memory On/Off separately with Open Scan, Group Scan
- Rotary Channel Select
- Busy Channel Lock-out Function
- Roger Beep Function On/Off
- 2 Different CallTones
- 38 Built-in CTCSS (Continuous Tone Coded Squelch System) and 104 additional DCS (Digital Coded Squelch) codes that are user selectable
- Variable Squelch Level adjust
- Volume Control with Power On/Off Switch
- VOX (Voice Activated Function)
- 10 Steps VOX Mic sensitivity adjustment

Preventive Maintenance:

The following system checks should be made every six to twelve months:

- Check the Standing Wave Ratio (SWR).
- Inspect the tightness of all electrical connections.
- Inspect the antenna coaxial cable for wear or breaks on the shielding.
- Inspect the tightness of all screws and other mounting hardware.

Troubleshooting:

Should the unit malfunction or perform poorly, follow these procedures:

If the transceiver is completely inoperative: Check the power cord and fuse.

If there is trouble with receiving: Check the VOLUME control setting. Be sure the SQUELCH is adjusted properly. Possibly the radio is over-squelched.

If there is trouble with transmitting: Check that the transmission line (coaxial cable) is **securely connected to the ANTENNA** connector. Check that the antenna is fully extended for proper operation. Check that all transmission line (coaxial cable) connections are secure and free of corrosion.

NOTE

Blackening may occur on the Liquid Crystal Display if the uh089sx has been subjected to extreme high temperature (above 60°C) . This is not a fault. Normal LCD operation resumes when the temperature stabilizes back to standard operating operating condition (0-55°C).

UNIDEN Model uh089sx UHF CB Radio

Controls/Connectors

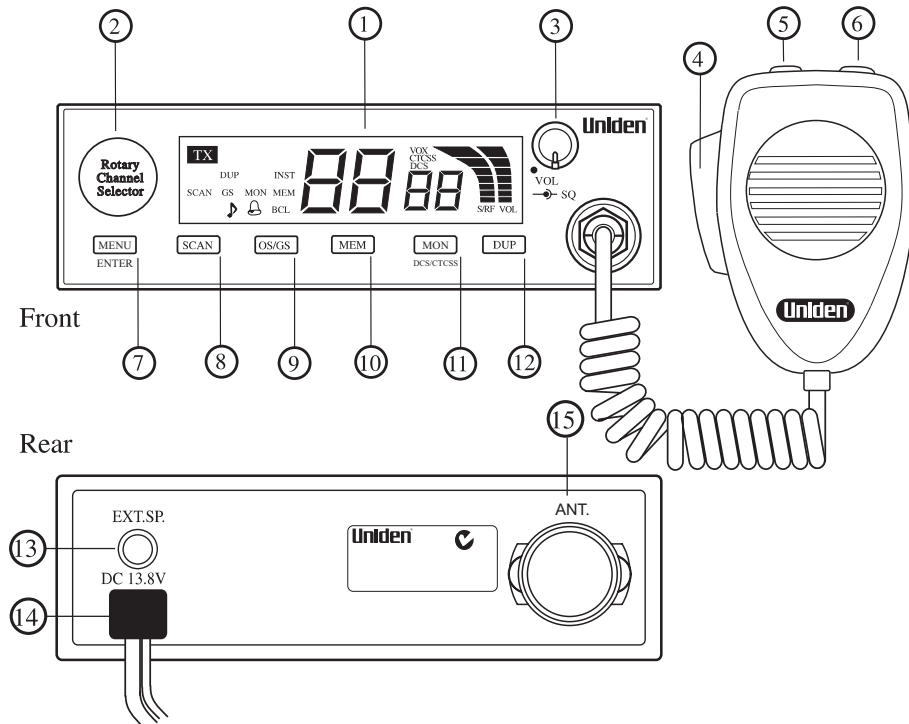

Controls and Connectors

Ref	Item	Page	Ref	Item	Page
①	Liquid Crystal Display (LCD)	4	⑨	OS/GS - Open or Group Scan	8,9
②	Rotary Channel Selector	6	⑩	MEM - Memory Scan Channels	8,9
③	On/Off Volume & Squelch	6	⑪	MON - DCS/CTCSS - Monitor and DCS/CTCSS Tone button	6,11
④	Push to Talk (PTT) Switch	7	⑫	DUP - Duplex On/Off	8
⑤	Call Button	7	⑬	External Speaker Jack	-
⑥	Instant Button	11	⑭	Power Input (13.8V DC)	-
⑦	Menu/Enter - Select Button	10	⑮	UHF Antenna Connection	-
⑧	SCAN - Scan On/Off	8,9			

Indicators

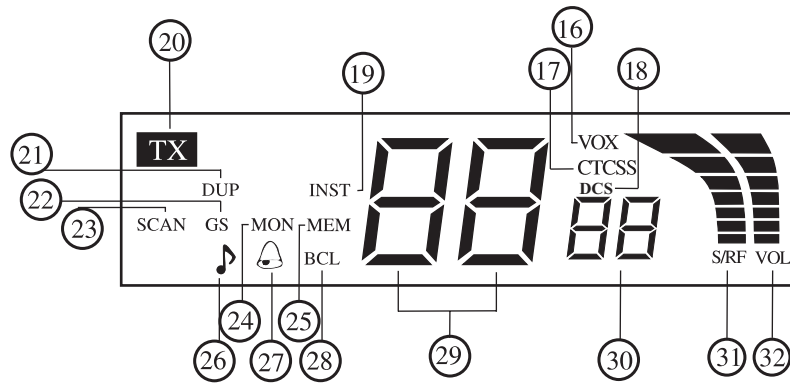

Indicators

Ref.	Item	Page	Ref.	Item	Page
①⑥	VOX - Voice Operated Microphone	11	②⑤	MEM - Memory	9
①⑦	CTCSS -Continuous Tone Coded Squelch System	11	②⑥	🎵 - Call Tone	10
①⑧	DCS - Digital Coded Squelch System	11	②⑦	🔔 - Roger Beep	10
①⑨	INST - Instant Channel	11	②⑧	BCL - Busy Channel Lockout	10
②①	TX - Transmit	7	②⑨	88 - Channel number	7
②②	DUP - Duplex	8	③①	88 - DCS/CTCSS Code Number	11
②③	GS - Group Scan	9	③②	S/RF- Receive Signal or Transmit RF Power Level Meter	-
②④	SCAN - Scan mode	8	③③	VOL - Receive Audio Volume Level Meter	-
②⑤	MON - Monitor	6			

UNIDEN Model uh089sx UHF CB Radio

Included with your uh089sx



uh089sx Owners Manual

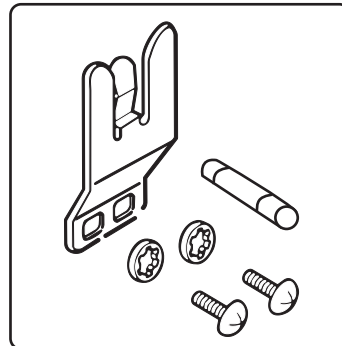

Microphone Hanger & Screws
Washers and spare fuse

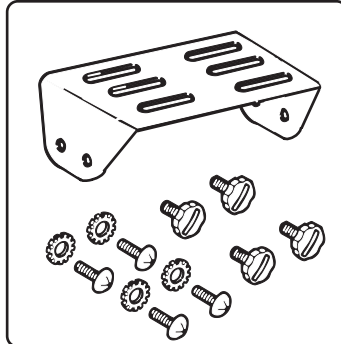

Mounting Bracket,
Mounting Screws, Washer Stars
And Screws

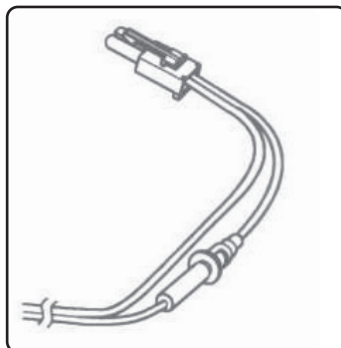

DC Power Cord with fuse

Optional Accessories

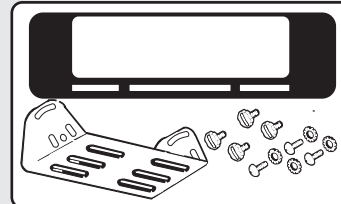

DIN Mounting Kit (DMK8990)



External Speaker (MS100)

Operation

Setting the Squelch

Turn the Unit ON by rotating the volume control clockwise. Turn the outer ring of the control to adjust the Squelch.

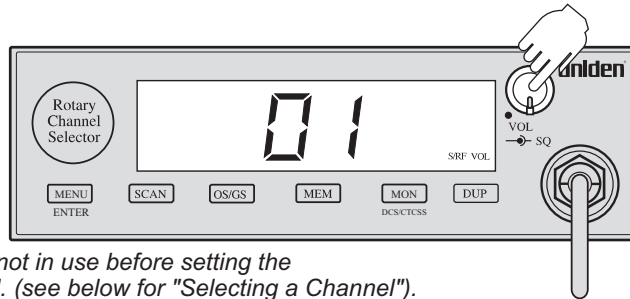

NOTE You must select a channel which is not in use before setting the SQUELCH control. (see below for "Selecting a Channel").

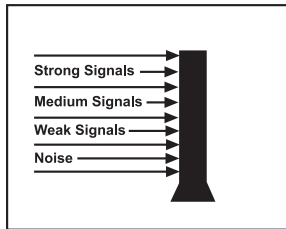

Think of the squelch control as a gate. If you turn Squelch fully clockwise it raises the 'Squelch gate' so high that no signals get through.

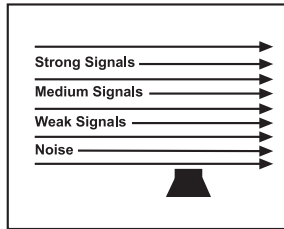

If you turn the Squelch fully counterclockwise it lowers the 'Squelch Gate' to the extent that all signals get through - weak, medium and strong signals and noise.

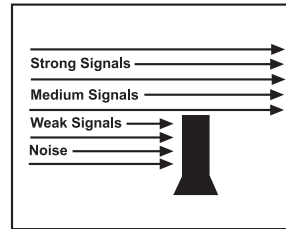

To set the 'Squelch Gate' to the desired level, turn the squelch knob counterclockwise until you hear noise. Then carefully turn the Squelch knob clockwise until the noise fades. Now only strong signals get through.

Monitor

Press **MON** to open the squelch and receive all weak signals.
Press **MON** again momentarily to cancel.

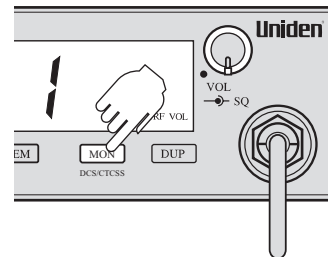

Selecting a Channel

Turn the Rotary Channel Selector to select the desired channel.

NOTE For your reference a list of the available channels, corresponding frequencies and guidelines for their use is printed on page 12. For Australia, Channels 05 and 35 are reserved for Emergency Calls.

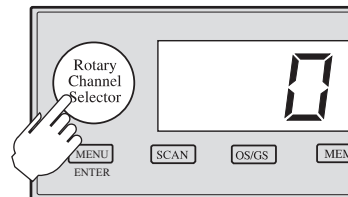

Operation

Transmitting

The uh089sx uses the 40 UHF-CB Channels (**Channels 22 and 23 are for telemetry and telecommand applications. Transmit is inhibited on these channels.**)

Select the desired channel. Press the microphone's PTT button and speak normally into the microphone. Hold it approx. 7cm from your mouth. Release the PTT button to end the transmission and listen for a reply.

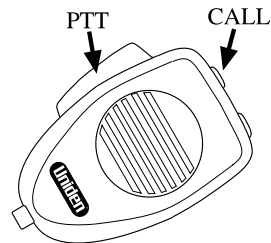

Call Function

Press the microphone Call Button. A two second ringing tone will be transmitted. You may select from 2 types of tones (see p.10).

Current regulations require calling tones to be restricted to one transmission per minute. If a second transmission is attempted within one minute then an error tone will sound.

Using Repeater Channels

UHF CB repeaters are used to retransmit or relay your signal. Repeaters will extend the range of your radio and overcome the shielding effect caused by solid obstructions. In normal Simplex operation, your radio transmits on one particular frequency and receives on that same frequency. If there is a barrier that partially blocks your transmitted signal, the probability of another radio receiving the signal is very slim. Hills, tall buildings, metallic structures,...etc tend to act as a screen between radios.

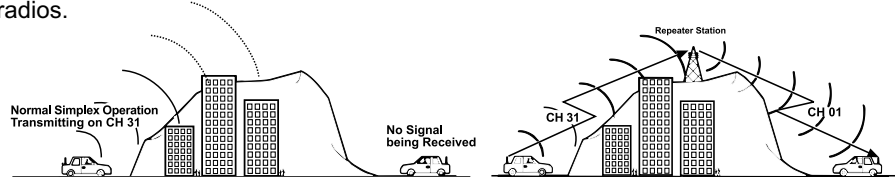

Standard Operation without the aid of a Repeater Station.

Operation with the aid of a Repeater Station (Duplex).

The signal coming from your radio is received by the Repeater Station and the re-transmitted at the same time on another channel. This operation is called "Duplexing".

For example,

CH01 on Duplex Mode will Receive on CH01 but Transmit on CH31

CH02 on Duplex Mode will Receive on CH02 but Transmit on CH32 etc...

If you transmit on CH01 Duplex mode, you are actually transmitting on CH31 the repeater station down-converts your signal and retransmits on CH01.

Operation

Operating the uh089sx in Duplex Mode

For this example we are adopting CH01 as the channel being used in your area for repeater use.

Press **[DUP]** to switch Duplex On.

If Duplex is not required - press **[DUP]** again to switch Duplex off.

Only channels 01 - 08 are available for Duplex.

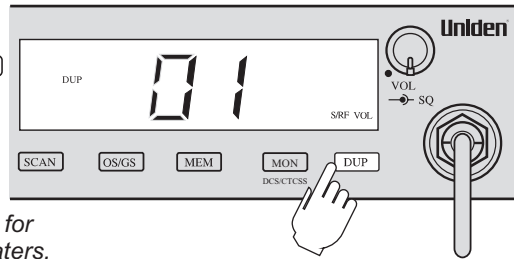

NOTE Check with your local Retailer for information on available repeaters.

Scanning

The uh089sx has a scanning feature that allows you to search for active channels automatically.

Furthermore, the uh089sx is designed to have two types of scanning; Open Scanning (OS) and Group Scanning (GS), to give you flexibility and allow you to use the radio more effectively.

Press **[SCAN]** and Scanning starts.

The **SCAN** icon appears.

The scan direction can be changed at any time by rotating the channel selector left or right.

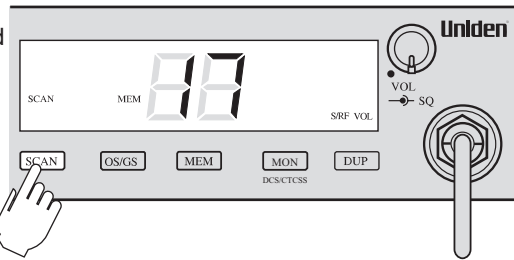

Open Scan (OS) Mode

Allows continuous scanning of all selected channels.

If an active channel is found, scanning will stop on that channel.

If the received signal ceases, the unit will wait 3 seconds for the signal to return, otherwise scanning resumes.



To skip the active channel, press **[MEM]** momentarily. Scanning resumes. To deactivate SCAN, press **[SCAN]** or the PTT button on the microphone.

NOTE If SCAN is deactivated while on an active channel, the uh089sx will stay on that active channel. If no channels are active, the uh089sx will reinstate the starting channel.

NOTE OS Mode is indicated by the absence of the GS icon.

Operation

Group Scan (GS) Mode

Allows you to monitor a Priority (Instant) Channel while scanning (Instant Priority channel see p. 11)



To use GS Mode Scanning, press **[OS/GS]**. GS icon appears on the display.

GS Scanning checks the Instant Priority Channel for activity regularly.

If the Priority Channel becomes active the radio will stay on that channel for as long as the signal is present. If the received signal ceases, Priority Scanning continues after 3 seconds.

If scanning stops on a channel which is not a Priority Channel, uh089sx will continue monitoring the Priority Channel for activity while listening to the active one.

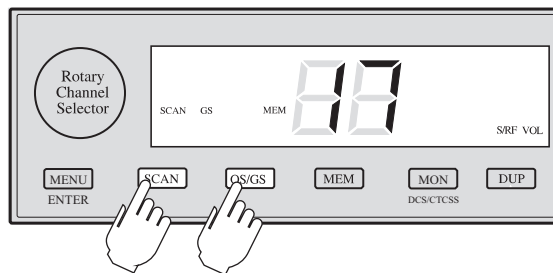

To deactivate SCAN, press the **[SCAN]** button or the PTT button on the microphone.

NOTE *If SCAN is deactivated while it is tuned to an active channel, the uh089sx will stay on that active channel.
If none of the channels are active, the uh089sx will reinstate the scan start channel.*

NOTE *If OS/GS Scanning is initiated when there are no channels programmed in OS/GS memory, an error tone will be heard and scanning will not start (see Programming Scan Channels - below).*

Programming Scan Channels

Select which Scanning Mode you wish to use - OS or GS.

Select the channel you want to store.

Press **[MEM]** to store. MEM icon appears and a short tone beep is heard.

To remove the channel from Memory, press **[MEM]** once more. The MEM icon disappears.

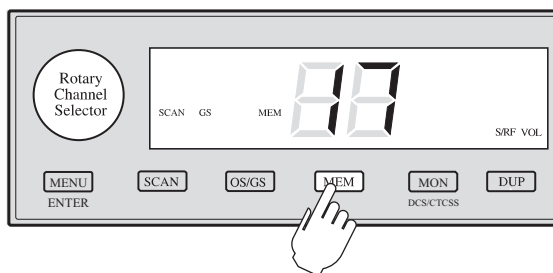

Operation

Selecting the Call tone

Press **[MENU]** once. Turn the Rotary Channel Selector to either *A* or *b*. Press **[MENU]** and hold for 3 seconds to store the new setting.

NOTE If a button is not pressed within 10 seconds the uh089sx will automatically exit the Menu Mode.

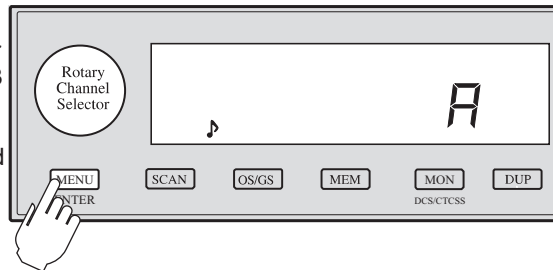

Roger Beep

A Roger Beep may be added to the end of transmission. Press **[MENU]** twice. Turn the Channel Selector to display *ON*. Press and hold **[MENU]** for 3 seconds to store the new setting.

NOTE If a button is not pressed within 10 seconds the uh089sx will automatically exit the Menu Mode.

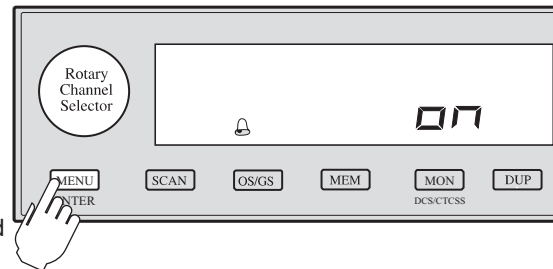

Busy Channel Lockout

If the channel is already in use, you can prevent the uh089sx from transmitting. This is particularly important when using CTCSS. Press **[MENU]** 3 times. Turn the Rotary Channel Selector to display *ON*. Press and hold **[MENU]** for 3 seconds to store the new setting.

NOTE If a button is not pressed within 10 seconds the uh089sx will automatically exit the Menu Mode.

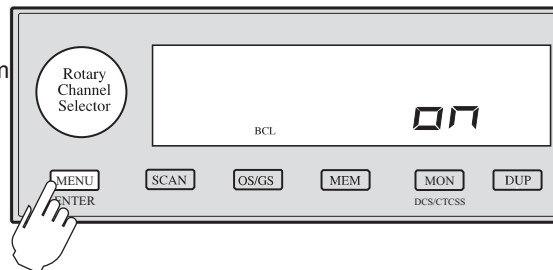

Operation

VOX Operation (optional VOX headset required)

Press **MENU** 4 times. Turn the Rotary Channel Selector to select the desired VOX sensitivity (oF, 1-9).

Press and hold **MENU** for 3 seconds to store the new setting. Connect the VOX headset.

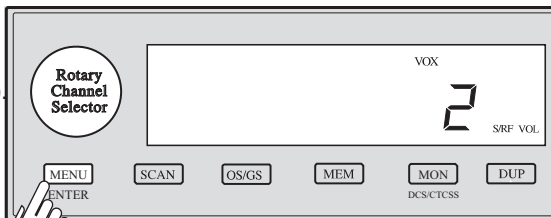

NOTE If a button is not pressed within 10 seconds the uh089sx will automatically exit the Menu Mode.

Programming the Instant Priority Channel

Turn the Rotary Channel Selector to select the Priority Channel you prefer.

Press and hold **INST** button on the microphone for 3 seconds to store the new setting. INST icon appears.

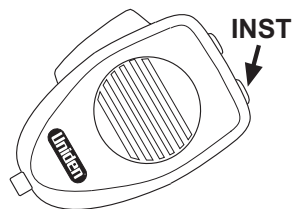

Recalling the Instant Channel

Momentarily press the **INST** button on the microphone at any time to return to the Instant Channel.

CTCSS (Continuous Tone Coded Squelch System)

Turn the Rotary Channel Selector to the desired channel to use CTCSS. Press and hold **MON** for 3 seconds. CTCSS icon appears.

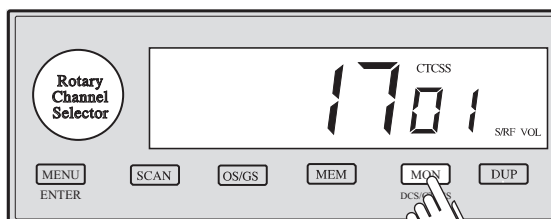

Turn the Rotary Channel Selector to select the desired CTCSS code 01 - 38. Press **MON** once to store the new setting. To turn off CTCSS (or DCS) select the oF code during setting.

DCS (Digitally Coded Squelch)

DCS is a digital extension of CTCSS. It provides 104 extra, digitally coded, squelch codes that follow after the 38 CTCSS codes. CTCSS 1-38, followed by DCS 1-99 plus DCS 100-104 (represented by o0-o4 on the display).

Follow the steps for setting a CTCSS code. Turn the Rotary Channel Selector until the DCS codes appear. Press **MON** to set. The **DCS** icon and code will display.

NOTE Channels 5 and 35 are used for emergency channels. CTCSS and DCS will not operate on these channels.

UNIDEN Model uh089sx UHF CB Radio

UHF CB Channels & Frequencies

NOTE

Please follow these guidelines for channel use in Australia:

- Channels 05 and 35 are Emergency Channels.
- Channel 11 is a Calling Channel.
- Channels 22 and 23 are for telemetry and telecommand applications and TX is inhibited on these channels.

General communication is accepted on all other channels with these guidelines:

- Channel 40 - road channel (Australia).
- Channels 01-08 (and 31-38) are repeater channels.

CH No.	Simplex Mode Transmit / Receive Frequency (MHz)	Duplex Mode Transmit Frequency (MHz)	CH No.	Simplex Mode Transmit/Receive Frequency (Mhz)
1	476.425	477.175 CH31	21	476.925
2	476.450	477.200 CH32	22	476.950 (RX only)
3	476.475	477.225 CH33	23	476.975 (RX only)
4	476.500	477.250 CH34	24	477.000
5	476.525	477.275 CH35	25	477.025
6	476.550	477.300 CH36	26	477.050
7	476.575	477.325 CH37	27	477.075
8	476.600	477.350 CH38	28	477.100
9	476.625		29	477.125
10	476.650		30	477.150
11	476.675		31	477.175
12	476.700		32	477.200
13	476.725		33	477.225
14	476.750		34	477.250
15	476.775		35	477.275
16	476.800		36	477.300
17	476.825		37	477.325
18	476.850		38	477.350
19	476.875		39	477.375
20	476.900		40	477.400

UNIDEN Model uh089sx UHF CB Radio

CTCSS & DCS Code List

CTCSS Code LIST

Code No.	Frequency (Hz)	Code No.	Frequency (Hz)	Code No.	Frequency (Hz)
"oF"	OFF	13	103.5	26	162.2
1	67.0	14	107.2	27	167.9
2	71.9	15	110.9	28	173.8
3	74.4	16	114.8	29	179.9
4	77.0	17	118.8	30	186.2
5	79.7	18	123.0	31	192.8
6	82.5	19	127.3	32	203.5
7	85.4	20	131.8	33	210.7
8	88.5	21	136.5	34	218.1
9	91.5	22	141.3	35	225.7
10	94.8	23	146.2	36	233.6
11	97.4	24	151.4	37	241.8
12	100.0	25	156.7	38	250.3

DCS Code LIST

Code No.	DCS Code (Octal)	Code No.	DCS Code (Octal)	Code No.	DCS Code (Octal)	Code No.	DCS Code (Octal)
1	023	27	152	53	311	79	466
2	025	28	155	54	315	80	503
3	026	29	156	55	325	81	506
4	031	30	162	56	331	82	516
5	032	31	165	57	332	83	523
6	036	32	172	58	343	84	526
7	043	33	174	59	346	85	532
8	047	34	205	60	351	86	546
9	051	35	212	61	356	87	565
10	053	36	223	62	364	88	606
11	054	37	225	63	365	89	612
12	065	38	226	64	371	90	624
13	071	39	243	65	411	91	627
14	072	40	244	66	412	92	631
15	073	41	245	67	413	93	632
16	074	42	246	68	423	94	654
17	114	43	251	69	431	95	662
18	115	44	252	70	432	96	664
19	116	45	255	71	445	97	703
20	122	46	261	72	446	98	712
21	125	47	263	73	452	99	723
22	131	48	265	74	454	100(o0)	731
23	132	49	266	75	455	101(o1)	732
24	134	50	271	76	462	102(o2)	734
25	143	51	274	77	464	103(o3)	743
26	145	52	306	78	465	104(o4)	754

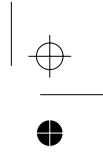
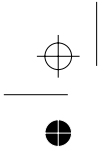

UNIDEN Model uh089sx UHF CB Radio

MEMO

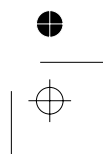
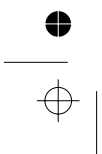

UNIDEN Model uh089sx UHF CB Radio

WARRANTY

UNIDEN UH089SX UHF CB TRANSCEIVER RADIO

Two Year Limited Warranty

Note: Please keep your sales docket as it provides evidence of warranty.

Warrantor: Uniden Australia Pty Limited ABN 58 001 865 498

Uniden New Zealand Limited

Warranty only available in original country of purchase

Elements of Warranty: Uniden warrants to the original retail owner for the duration of this warranty, its uh089sx UHF CB Radio (hereinafter referred to as the Product) to be free from defects in materials and craftsmanship with only the limitations or exclusions set out below.

Warranty Duration: This warranty to the original retail owner only, shall terminate and be of no further effect TWO (2) years after the date of original retail sale. This warranty will be deemed invalid if the Product is;

- (A) Damaged or not maintained as reasonable and necessary,
- (B) Modified, altered or used as part of any conversion kits, subassemblies, or any configurations not sold by Uniden,
- (C) Improperly installed,
- (D) Repaired by someone other than an authorized Uniden Repair Agent for a defect or malfunction covered by this warranty,
- (E) Used in conjunction with any equipment or parts or as part of a system not manufactured by Uniden, or
- (F) Where the Serial Number label of the product has been removed or damaged beyond recognition.

Warranty only valid in the country of original retail/sale.

Parts Covered: This warranty covers for TWO (2) years, the Product and included accessories.

Statement of Remedy: In the event that the Product does not conform to this warranty at any time while this warranty is in effect, the warrantor at its discretion, will repair the defect or replace the Product and return it to you without charge for parts or service. This warranty does not provide for reimbursement or payment of incidental or consequential damages.

This EXPRESS WARRANTY is in addition to and does not in any way affect your rights under the TRADE PRACTICES ACT 1974 (Cth) (Australia) or the CONSUMER GUARANTEES ACT (New Zealand).

Procedure for obtaining performance or warranty: In the event that the Product does not conform to this warranty, the Product should be shipped or delivered, freight prepaid, with evidence of original purchase, (eg. a copy of the sales docket), to the warrantor at:

UNIDEN AUSTRALIA PTY LTD

Service Division
345 Princes Highway,
Rockdale, NSW 2216
Fax (02) 9599 3278
www.uniden.com.au

UNIDEN NEW ZEALAND LTD

Service Division
150 Harris Road, East Tamaki,
Auckland
Fax (09) 274 4253
www.uniden.co.nz

Uniden®

© 2007 Uniden Australia Pty Limited/Uniden New Zealand Limited
Printed in China UTZZ01930ZA(0)

Free Manuals Download Website

<http://myh66.com>

<http://usermanuals.us>

<http://www.somanuals.com>

<http://www.4manuals.cc>

<http://www.manual-lib.com>

<http://www.404manual.com>

<http://www.luxmanual.com>

<http://aubethermostatmanual.com>

Golf course search by state

<http://golfingnear.com>

Email search by domain

<http://emailbydomain.com>

Auto manuals search

<http://auto.somanuals.com>

TV manuals search

<http://tv.somanuals.com>