

Uniden®

**BC246T
OWNER'S
MANUAL**

OWNER'S MANUAL

Precautions

Before you use this scanner, please read and observe the following.

IMPORTANT!

This scanning radio has been manufactured so that it will not tune to the radio frequencies assigned by the FCC for cellular telephone usage. The Electronic Communications Privacy Act of 1986, as amended, makes it a federal crime to intentionally intercept cellular or cordless telephone transmissions or to market this radio when altered to receive them. The installation, possession, or use of this scanning radio in a motor vehicle may be prohibited, regulated, or require a permit in certain states, cities, and/or local jurisdictions. Your local law enforcement officials should be able to provide you with information regarding the laws in your community.

Changes or modifications to this product not expressly approved by Uniden, or operation of this product in any way other than as detailed by this Operating Guide, could void your authority to operate this product.

EARPHONE WARNING!

Be sure to use only a monaural earphone with this scanner. You can also use an optional 32 ohm stereo headset. Use of an incorrect earphone or stereo headset might be potentially hazardous to your hearing. The output of the phone jack is monaural, but you will hear it in both headphones of a stereo headset.

Set the volume to a comfortable audio level coming from the speaker before plugging in the monaural earphone or a stereo headset of the proper impedance (32 ohm). Otherwise, you might experience some discomfort or possible hearing damage if the volume suddenly becomes too loud because of the volume control or squelch control setting. This might be particularly true of the type of earphone that is placed in the ear canal.

Precautions

WARNING!

Uniden **does not** represent this unit to be waterproof. To reduce the risk of fire or electrical shock, **do not** expose this unit to rain or moisture.

Motorola®, *SMARTNET®*, *PL®*, *Private Line®*, and *PRIVACY PLUS®* are registered trademarks of *Motorola, Inc.*

LTR® is a registered trademark of *E.F. Johnson Co.*

EDACS® is a registered trademark of *M/A-COM Private Radio Systems, Inc.*

Uniden® and *Bearcat®* are registered trademarks of *Uniden America Corporation.*

TrunkTracker™, *Trunk Tracking™*, and *Close Call™* are proprietary trademarks of *Uniden America Corporation.*

Other trademarks used throughout this manual are the property of their respective holders.

Precautions

Contents

The FCC Wants You to Know	7
Scanning Legally	7
Introduction	9
Feature Highlights	11
About This Manual	15
How the Scanner's Controls Are Represented in This Manual	15
Entering Text	16
Understanding Scanning	17
Understanding the Scanner's Memory	17
What is Scanning?	17
What is Searching?	18
What is CTCSS/DCS?	18
Conventional Scanning	20
Simplex Operation	20
Repeater Operation	21
What is Trunk Tracking?	21
Trunked Scanning	22
Types of Trunking Systems	23
Motorola Trunking	23
EDACS Trunking	24
LTR Trunking	25
Where To Get More Information	26
Information On The Internet	26
Using a Computer to Control Your BC246T	27
Included With Your Scanner	28
Setting Up Your Scanner	28
Using Internal Batteries	29
Using Rechargeable Batteries	31
Using AC Power	32
Connecting the Antenna	32
Connecting an Optional Antenna	32
Connecting an Earphone/Headphone	33
Connecting an Extension Speaker	33
Attaching the Belt Clip	33
Installing the Demo Software	34
A Look At The Keypad	35
A Look At The Display	38
Using Menu	39
Using Func	39
Using the Scroll Control	39
Basic Operation	40
Turning On the Scanner and Setting the Squelch	40
Scanning Systems	40
Preprogrammed System Tips	41
Selecting Systems to Scan	41
Selecting System Channel Groups	41
Locking/Unlocking Systems	42
Locking/Unlocking Channels	42
ID Scan/ID Search Mode	42
Temporarily Holding On a System	43
Holding On a Channel	43
Quickly Storing an ID During ID Search	43
Quick-Storing Channels	44
Quickly Recalling Channels	44
Other Settings	45
Displaying System Information	45
Viewing Memory Used	45
Viewing the Firmware Version	45
Adjusting the Key Beep	45
Locking/Unlocking the Keypad	45
Turning Power Save On or Off	45

Contents

Priority Scan	45
Using the Backlight	46
Initializing the Scanner's Memory	46
Using the Menu	47
Programming Radio Systems	49
Programming Conventional Systems	50
Entering/Editing Conventional Channel Groups	50
Entering/Editing Conventional Channels	51
Programming Motorola Systems	52
Setting System Frequencies	53
Entering/Editing Motorola Channel Groups	54
Entering/Editing Motorola Channels	54
Programming EDACS Systems	55
Setting System Frequencies	57
Entering/Editing EDACS Channel Groups	57
Programming LTR Systems	58
Setting System Frequencies	59
Entering/Editing LTR Channel Groups	60
Entering/Editing LTR Channels	60
Programming/Editing Optional Settings	62
System-Level Settings	62
Editing the System Name	62
Editing the System Quick Key	62
Setting System Lockout	63
Setting the System Hold Time	63
Setting the Channel Delay Time	64
Setting ID Scan/Search (Trunked Systems Only)	64
Setting Data Skip (Conventional Systems Only)	65
Editing the Fleet Map (Motorola Systems Only)	65
Setting the Motorola Status Bit (Motorola Systems Only)	66
Setting the End Code Operation (Motorola Systems Only)	67
Setting I-Call (Motorola and EDACS Systems Only)	67
Setting Emergency Alert (Motorola and EDACS Systems Only)	67
Setting the EDACS ID Format	68
Setting Control-Channel Only (Motorola Systems Only)	68
Setting System Attenuation (Trunked Systems Only)	69
Deleting Systems	69
Copying/Pasting Systems	70
Group-Level Settings	70
Entering/Editing the Group Name	70
Setting the Group Quick Key	71
Deleting Groups	71
Channel-Level Settings	72
Editing the Channel Name	72
Setting Channel Priority (Conventional Channels Only)	73
Setting Channel Alert	73
Setting CTCSS/DCS (Conventional Channels Only)	74
Setting Channel Modulation (Conventional Channels Only)	75
Setting Channel Attenuation (Conventional Channels Only)	75
Setting the Frequency Step (Conventional Channels Only)	76
Setting Channel Lockout	76
Deleting Channels	77
Copying/Pasting Channels	78
Searching	79
Custom Search	79
Editing a Custom Search Range	80
Custom Search When Control Channel-Only Mode is Selected	81
Service Search	81
Quick Search	82
CTCSS/DCS Search	83

Contents

Using the Close Call Feature	84
Setting the Close Call Mode	85
Search and Close Call Options	87
Managing Locked-Out Frequencies	87
Unlocking All Frequencies	87
Reviewing Locked Out Frequencies	87
Searching for Subaudible Tones	87
Screening Out Paging Systems	88
Finding Repeater Output Frequencies	88
Setting the Maximum Auto Store Value	89
Setting the Modulation Type	89
Setting Attenuation	90
Setting Data Skip	90
Setting the Delay Time	91
Setting the Search Frequency Step	91
Using Weather Alert (SAME)	92
Searching For a Weather Broadcast	92
Turning Weather Alert On/Off	92
Programming a SAME Group	93
Setting WX Alert Priority	94
Care and Maintenance	95
Birdies	96
Troubleshooting	97
Specifications	102
Optional Accessories	105
Appendix	106
Preset Fleet Maps	106
User Defined Fleet Maps	108
Type I Programming Information	108
Size Code Restrictions	109
Quick Start to Programming Your Scanner	110
Getting Started	110
Conventional Scanning Worksheet Instructions	113
Motorola Trunking Worksheet Instructions	114
LTR Trunking Worksheet Instructions	116
EDACS Trunking Worksheet Instructions	117
Conventional Scanning Worksheet	118
Motorola Trunking Worksheet	119
EDACS Trunking Worksheet	121
LTR Trunking Worksheet	123
Preprogrammed Systems	125
One-Year Limited Warranty	136

Contents

The FCC Wants You to Know

This scanner has been tested and found to comply with the limits for a scanning receiver, pursuant to Part 15 of the *FCC Rules*. These limits are designed to provide reasonable protection against harmful interference in a residential installation. This scanner generates, uses, and can radiate radio frequency energy and, if not installed and used in accordance with the instructions, may cause harmful interference to radio communications.

However, there is no guarantee that interference will not occur in a particular installation. If this scanner does cause harmful interference to radio or television reception, which can be determined by turning the scanner on and off, you are encouraged to try to correct the interference by one or more of the following measures:

- Reorient or relocate the receiving antenna
- Increase the separation between the scanner and the receiver

This device complies with Part 15 of the *FCC Rules*.

Operation is subject to the following two conditions:

1) This device may not cause harmful interference, and
2) this device must accept any interference received, including interference that may cause undesired operation.

Scanning Legally

Your scanner covers frequencies used by many different groups, including police and fire departments, ambulance services, government agencies, private companies, amateur radio services, military operations, pager services, and wireline (telephone and telegraph) service providers. It is legal to listen to almost every transmission your scanner can receive. However, there are some transmissions that you should never intentionally listen to. These include:

- Telephone conversations (cellular, cordless, or other private means of telephone signal transmission)
- Pager transmissions
- Any scrambled or encrypted transmissions

The FCC Wants You to Know

According to the Electronic Communications Privacy Act (ECPA), you are subject to fines and possible imprisonment for intentionally listening to, using, or divulging the contents of such a conversation unless you have the consent of a party to the conversation (unless such activity is otherwise illegal). This scanner has been designed to prevent the reception of cellular telephone transmissions and the decoding of scrambled transmissions. This is done to comply with the legal requirement that scanners be manufactured so they are not easy to modify to pick up these transmissions. Do not open your scanner's case to make any modifications that could allow it to pick up transmissions that are illegal to monitor. Modifying or tampering with your scanner's internal components or using it in a way other than as described in this manual could invalidate your warranty and void your FCC authorization to operate it.

In some areas, mobile use of this scanner is unlawful or requires a permit. Check the laws in your area. It is also illegal in many areas (and a bad idea everywhere) to interfere with the duties of public safety officials by traveling to the scene of an incident without authorization.

The FCC Wants You to Know

Introduction

Your BC246T scanner is a state-of-the-art scanner radio with TrunkTracking™ and automatic scanning capabilities. You can store frequencies such as police, fire/emergency, marine, air, amateur, and other communications into the scanner. You can carry it with you wherever you go, use it at home as a base unit, or install it in your vehicle as a mobile unit.

You can use the scanner's scroll control to quickly select channels and frequencies, and you can automatically program channels in a system using the AutoStore feature.

Use your scanner to monitor:

- Trunked public safety systems
- Police and fire departments (including rescue and paramedics)
- NOAA weather transmissions
- Business/Industrial radio
- Utilities
- Marine and amateur (ham radio) bands
- Air band

This table lists the frequency ranges, default frequency step, default mode (AM, FM, or Narrowband FM), and type of transmissions you can hear for each range.

Frequency Range (MHz)	Step (kHz)	Mode	Transmission
25.0-26.960	5	AM	Citizens Band/ Business Band
26.965-27.405	5	AM	Citizens Band Class D
27.410-27.995	5	AM	Business Band
28.0-29.690	10	FM	10 Meter Amateur Band
29.7-49.990	10	FM	VHF Low Band

Introduction

50.0-54.0	10	FM	6 Meter Amateur Band
108.0- 136.9750	25	AM	Aircraft Band
137.0- 143.995	5	FM	Military Band
144.0- 147.995	5	FM	2 Meter Amateur Band
148.0- 161.995	5	FM	VHF High Band
162.0-174.0	12.5	FM	Federal Government
216.0- 224.9950	5	FM	1.25 Meter Amateur Band
400.0- 405.9875	12.5	NFM	Unknown
406.0- 419.9875	12.5	NFM	Federal Land Mobile
420.0- 449.9875	12.5	NFM	70cm Amateur Band
450.0- 469.9875	12.5	NFM	UHF Standard Band
470.0-512.0	12.5	NFM	UHF TV Band
806.0- 823.9875	12.5	NFM	Public Service Band
849.0125- 868.9875	12.5	NFM	Public Service Band
894.0125- 956.0000	12.5	NFM	Public Service Band
1240.0000- 1300.0000	12.5	NFM	25 cm Amateur Band

Introduction

Feature Highlights

General

Close Call™ RF Capture Technology - you can set the scanner so it detects and provides information about nearby radio transmissions. See “Using the Close Call Feature” on Page 83 for more information.

Dynamically Allocated Channel Memory - your scanner’s memory is organized so that it more closely matches how radio systems actually work, making it easier to program and use your scanner and determine how much memory you have used and how much you have left.

Preprogrammed Systems - your scanner is preprogrammed with over 400 channels covering police, fire, and ambulance operations in the 25 most populated counties in the US. A complete list of the scanner’s preprogrammed systems is in “” on Page 119.

Quick Keys – You can set the scanner so you can select systems and groups by pressing a single key. This makes it easy to listen to or quickly lock out those systems or groups you don’t want to scan.

Pager Screen – You can set the scanner so it ignores hits generated by common pager frequencies while using the Close Call or search features.

Ten Service Searches - frequencies are preset in separate public safety, news, amateur radio, marine, railroad, air, CB radio, FRS/GMRS, racing, and special searches, to make it easy to find specific transmissions.

Lockout – You can lock out any system, group, frequency, or channel while scanning. If you lock out a system or group, any channels belonging to that system or group are also locked out.

You can lock out up to 200 frequencies. The scanner skips locked-out frequencies while using the Close Call feature or while searching.

CTCSS and DCS Squelch Modes – prevent interference from stations not using the mode you select.

Feature Highlights

Dropout Delay – You can set whether the scanner pauses at the end of a transmission to wait for a reply. You can set the delay time for each system you scan, and while searching and using the Close Call feature.

Attenuator – You can set the scanner’s attenuator to reduce the input strength of strong signals by about 18 dB received by the scanner.

Repeater Reverse – You can set the scanner so it switches to the input frequency on a conventional repeater system or trunked system.

Channel Alert – You can set the scanner so it alerts you when there is activity on any channel you specify.

Memory Check – Lets you see at a glance how much total memory is left.

Frequency Step – Lets you select a frequency step (5, 6.25, 7.5, 10, 12.5, 15, 25, 50 or 100 kHz) for manual mode and chain search mode. The scanner’s auto step feature lets you set the scanner so it automatically chooses the correct step.

Quick Recall – Lets you quickly select a specific channel by choosing the system, group, and channel.

Scan/Search Delay – You can set the scanner so it remains on a frequency up to 5 seconds after the last transmission to wait for a possible reply.

Text Tagging – You can name each system, group, channel, talk group ID, custom search range, and SAME group, using up to 16 characters per name.

Unique Data Skip – Allows your scanner to skip unwanted data transmissions and reduces birdies.

Duplicate Frequency Alert – Alerts you if you try to enter a duplicate name or frequency already stored in the scanner.

Memory Backup – If power is lost or disconnected, the scanner retains the frequencies you programmed in its memory.

Feature Highlights

21 Bands – Includes 21 bands, with Aircraft and 800 MHz.

Note: The scanner's frequency coverage is not continuous and does not include the cellular telephone band.

Trunk Tracking

Trunk Tracker™ Operation – Follows conversations on analog Motorola, EDACS, EDACS SCAT, and LTR trunked radio systems. The scanner can scan both conventional and trunked systems at the same time.

Control Channel Only Scanning – If the scanner is set to scan Motorola trunking frequencies, you can set it so it scans using only control channel data. You do not have to program voice channel frequencies into memory in this mode.

Weather

Weather Search – Lets your scanner receive your local NOAA weather transmission.

SAME Weather Alert – Lets your scanner alert you when a SAME weather alert is transmitted on a NOAA weather channel. The scanner also displays the transmitted alert type. This helps you quickly find out about severe weather in your area and lets you avoid false alarms.

Search

Service Search – Lets you quickly select and search the scanner's preprogrammed frequencies.

Custom Search – Lets you program up to 10 custom search ranges. You can search any of these ranges simultaneously.

CTCSS/DCS Search – Lets the scanner search for CTCSS or DCS tones. You can identify up to 50 CTCSS tones and 104 DCS tones.

Feature Highlights

Quick Search – Lets you search from the currently-tuned frequency if you are searching a conventional system, or from the currently-tuned trunk ID if you are searching a trunked system.

Auto Store

Frequency AutoStore – Automatically stores all active frequencies within a system you select.

Talk Group ID AutoStore – Automatically stores all new talk group ID's into a system you select.

Priority

Priority Scan – Priority channels let you keep track of activity on your most important channel(s) while monitoring other channels for transmissions.

Priority Plus – You can set the scanner so it scans only the priority channels

Backlight and Power

LCD Back Light – Makes the display easy to see in dim light. You can adjust the back light so it turns on when you press a key, when squelch breaks during a transmission, or manually.

Low Battery Alert – The scanner alerts you if the batteries need to be recharged or replaced.

Battery Save – You can set the scanner so it reduces the amount of power it needs if there are no transmissions.

Key Controls

Key Lock – You can deactivate the scanner's keys to help prevent accidentally changing the scanner's programming.

PC Control and Cloning

Feature Highlights

PC Control – You can transfer programming data to and from your scanner and your personal computer, and control the scanner using a computer. This helps you find frequencies listed on the Internet and load them into the scanner.

Clone Mode – You can clone all programmed data, including the contents of the scanner’s memory, menu settings, and other parameters from one BC246T scanner to another BC246T scanner.

About This Manual

The screen displays used in this manual are representations of what might appear when you use your scanner. Since what you see depends on the frequencies and user ID’s for your area and the settings you select, you might notice some differences between what is in this manual and what appears on your scanner.

How the Scanner’s Controls Are Represented in This Manual

To help navigate the scanner’s menus, the steps shown in this manual show the displays you see and the keys you press or control you operate to get a desired result.

This example shows you how to use the scanner’s menu to edit an existing system name. It shows you the key to press (**Menu**) to select a menu option and the option you see (*PROGRAM SYSTEM*) when you press **Menu**. It also instructs you to turn the scroll control (shown as **U**) to view a series of choices then select one choice (*EDIT NAME*).

Menu → *PROGRAM SYSTEM* → **E** **U** →

System name you want to edit or *NEW SYSTEM* → **E**

U → *EDIT NAME* → **E** → System Name

To get the most from this manual, review the contents to become familiar with the basic functions available. If you

Feature Highlights

are new to scanning or trunk tracking, be sure to read “Understanding Scanning” on Page 17 for a quick background on the technology. The first thing you’ll need to do is install batteries in the scanner. Then you need to connect the included antenna to the scanner. See “Setting Up Your Scanner” on Page 28 if you need any help doing this.

Entering Text

To enter a letter, turn the scroll control until the character you want appears. To enter a number, press a number key. To enter a decimal point, press **.**

To move the cursor to the left, hold **[Func]** then press **</4** or rotate the scroll control to the left. To move the cursor to the right, hold **[Func]** then press **6/>** or rotate the scroll control to the right.

To clear a character, press **No** once. To clear all characters, press **No** 3 times.

To accept an entry, press **E** or press down on the scroll control.

Feature Highlights

Understanding Scanning

This section provides you with background on how scanning works. You don't really need to know all of this to use your scanner, but some background knowledge will help you get the most from your BC246T.

Understanding the Scanner's Memory

Your scanner's memory is organized in an architecture called *Dynamic Allocated Channel* memory. This type of memory is organized differently and more efficiently than the bank/channel architecture used by traditional scanners. Dynamic Allocated design matches how radio systems actually work much more closely, making it easier to program and use your scanner and determine how much memory you have used and how much you have left.

Instead of being organized into separate banks and channels, your scanner's memory is contained in a *pool*. You simply use as much memory as you need in the pool to store as many frequencies, talk group ID's, and alpha tags as you need. No memory space is wasted, and you can tell at a glance how much memory you have used and how much remains.

With a traditional scanner, when you program it to track a trunked system, you must first program the frequencies. Since you can only program one trunking system per bank in a traditional scanner, if there were (for example) 30 frequencies, the remaining 70 or so channels in the bank are not used and therefore wasted. Also, since some trunked systems might have hundreds of talk groups, you would have had to enter those types of systems into multiple banks in order to monitor and track all the ID's.

What is Scanning?

Unlike standard AM or FM radio stations, most two-way communications do not transmit continuously. Your BC246T scans programmed channels until it finds an active frequency, then stops on that frequency and remains on that channel as long as the transmission

Understanding Scanning

continues. When the transmission ends, the scanning cycle resumes until the scanner receives another transmission.

What is Searching?

The BC246T can search each of its 21 bands and up to 10 bands together to find active frequencies. This is different from scanning because you are searching for frequencies that have not been programmed into the scanner. When you select frequency bands to search, the scanner searches for any active frequency within the lower and upper limits you specify. When the scanner finds an active frequency, it stops on that frequency as long as the transmission lasts. If you think the frequency is interesting, you can program it into the scanner's memory. If not, you can continue to search.

What is CTCSS/DCS?

Your scanner can monitor systems using a Continuous Tone Control Squelch (CTCSS) and Digital Coded Squelch (DCS) system, which allow squelch to open only when the tone you have programmed with a specific frequency is received along with a transmission.

CTCSS and DCS are subaudible tone signaling systems sometimes referred to as PL (Motorola's trademarked term for Private Line). CTCSS and DCS are used only for FM signals and are usually associated with both amateur and commercial two-way repeaters. These systems make use of a special subaudible tone that accompanies a transmitted signal.

CTCSS and DCS are used for many purposes. In many cases, CTCSS and DCS are used to restrict access to a commercial repeater, so that only those units, which transmit the correct tone along with their signal can "talk" to the repeater.

CTCSS and DCS are also used in areas that receive interference where there are several stations with output frequencies close to each other. When this occurs, you

Understanding Scanning

might hear multiple communications at the same time. The stations might even interfere with each other to the point where it is impossible to clearly receive any of the stations. A scanner equipped with CTCSS and DCS (like your scanner) can code each received frequency with a specific CTCSS or DCS frequency. Then, when you receive multiple signals, you only hear the transmission with the CTCSS or DCS tone you programmed. If you do not receive the correct tone with a signal, the scanner's squelch remains closed and you hear nothing.

Local frequency allocation groups set cooperative standards to establish the CTCSS and DCS tone for each transmitter (or repeater).

You can search for the following CTCSS frequencies and DCS codes.

CTCSS Frequencies (Hz)

67.0	69.3	71.9	74.4	77.0	79.7
82.5	85.4	88.5	91.5	94.8	97.4
100.0	103.5	107.2	110.9	114.8	118.8
123.0	127.3	131.8	136.5	141.3	146.2
151.4	156.7	159.8	162.2	165.5	167.9
171.3	173.8	177.3	179.9	183.5	186.2
189.9	192.8	196.6	199.5	203.5	206.5
210.7	218.1	225.7	229.1	233.6	241.8
		250.3	254.1		

DCS Codes (Octal)

023	025	026	031	032	036	043	047
051	053	054	065	071	072	073	074
114	115	116	122	125	131	132	134
143	145	152	155	156	162	165	172
174	205	212	223	225	226	243	244
245	246	251	252	255	261	263	265
266	271	274	306	311	315	325	331

Understanding Scanning

332	343	346	351	356	364	365	371
411	412	413	423	431	432	445	446
452	454	455	462	464	465	466	503
506	516	523	526	532	546	565	606
612	624	627	631	632	654	662	664
703	712	723	731	732	734	743	754

Conventional Scanning

Conventional scanning is a relatively simple concept. Each group of users in a conventional system is assigned a single frequency (for simplex systems) or two frequencies (for repeater systems). Any time one of them transmits, their transmission always goes out on the same frequency. Up until the late 1980s, this was the primary way that radio systems operated.

Even today, there are many 2-way radio users who operate using a conventional system:

- Aircraft
- Amateur radio
- FRS/GMRS users
- Broadcast AM/FM/TV stations
- Many business radio users

When you want to store a conventional system, all you need to know is the frequencies they operate on. When you are scanning a conventional system, the scanner stops very briefly on each channel to see if there is activity. If there isn't, the scanner quickly moves to the next channel. If there is, then the scanner pauses on the transmission until it is over.

Simplex Operation

Simplex systems use a single frequency for both transmit and receive. Most radios using this type of operation are limited to line-of-sight operation. This type of radio is frequently used at construction job sites, and with

Understanding Scanning

inexpensive consumer radios such as GMRS/FRS radios. The range is typically 1-8 miles, depending upon the terrain and many other factors.

Repeater Operation

Repeater systems use two frequencies: one transmits from the radio to a central repeater; the other transmits from the repeater to other radios in the system. With a repeater-based system, the repeater is located on top of a tall building or on a radio tower that provides great visibility to the area of operation. When a user transmits (on an input frequency), the signal is picked up by the repeater and retransmitted (on an output frequency). The user's radios always listen for activity on the output frequency and transmit on the input frequency. Since the repeater is located very high, there is a very large line of sight.

Typical repeater systems provide coverage out to about a 25-mile radius from the repeater location.

What is Trunk Tracking?

Your BC246T is designed to track the following types of trunking systems.

- Motorola Type I, Type II, Type III, hybrid, SMARTNET, and PRIVACYPLUS analog trunking systems, which are extensively used in 800 MHz communication systems.
- LTR trunking systems
- EDACS SCAT trunking systems
- EDACS trunking systems

When tracking these types of systems, you might want to remember these important points:

- Your scanner can track more than one trunking system at a time and scan conventional and trunked systems at the same time.

Understanding Scanning

-
-
- The frequencies for many of the 800 MHz public safety systems are listed in the *National Public Safety Trunked System Frequency Guide* included with your BC246T scanner.

Conventional scanning is a simple concept. You enter a frequency used by someone you want to monitor into your scanner's memory. For example, the police in your area might transmit on 460.500 MHz, the fire department on 154.445 MHz, the highway department on 37.900 MHz, etc. So when your scanner stops on a frequency, you usually know who it is, and more importantly, you can stop on a channel and listen to an entire conversation. This type of scanning is easy and fun.

However, as the demand for public communications has increased, many public radio users do not have enough frequencies to meet their needs, creating a serious problem. Trunking radio systems help solve this problem.

Trunked Scanning

While conventional scanning worked great while there were only a few groups wanting to use the frequencies, with the advent of smaller, lower-cost radios more and more agencies and businesses wanted to take advantage of the utility of 2-way radio. As a result, the bands that were used most became full, so new users were not able to take advantage of the technology as quickly as they wanted.

Trunking solved this frequency shortage by allowing multiple groups to use the same set of frequencies in a very efficient way. While each type of trunking system operates a little differently (see the next few sections), they all work on the same basic premise: even in a system with a lot of users, only a few users are ever transmitting at any one time.

Instead of being assigned a frequency, as with conventional systems, each group is assigned a talk group ID. A central computer controls the frequency each group operates on...and this frequency selection is made

Understanding Scanning

each time a user transmits. So, while on a conventional system queries, replies, and follow-ups are all on a single frequency, they could each be on completely different frequencies on a trunked system. This semi-random frequency assignment made monitoring such a system impossible prior to Uniden's invention of the Trunktracking scanner.

Not only does your BC246T scan channels like a conventional scanner, it actually follows the users of a trunked radio system. Once you know a talk group's ID, you won't miss any of the action.

If you are a new scanner enthusiast, you might want to read the first part of this manual and use your scanner in conventional mode before you begin trunk tracking. Understanding scanning fundamentals and terminology will make trunk tracking much easier. If you are already an experienced scanner operator, you might want to go to "Programming Motorola Systems" on Page 52, "Programming EDACS Systems" on Page 55, or "Programming LTR Systems" on Page 58 now.

Types of Trunking Systems

Trunking systems divide a few frequencies among many different users, but the way that each system does this is slightly different. This section describes some of the technical data behind Motorola, EDACS, and LTR trunked radio systems.

Motorola Trunking

While there are different types of Motorola trunking systems, they all use the same basic trunking method. The system consists of one control channel plus one or more voice channels (typically 10, 20, or 30 total channels). When a user presses Push To Talk (PTT) to transmit, their radio first sends their talk group information to the control channel. The computer then assigns that talk group to a specific voice channel and transmits that data over the control channel. All radios in that talk group switch over to the assigned voice channel and the user

Understanding Scanning

can begin speaking. This all typically takes place in about a second...the person transmitting hears a beep from their radio when the channel is assigned and then it is OK to start talking.

The systems in use are:

Motorola Type I – the radios send the radio ID, the fleet and subfleet talk group ID to the control channel each time they transmit. To program a Type I system, you need to know the system's *fleet map*. The most common fleet maps are included in "Preset Fleet Maps" on Page 105. You can also find fleet map resources on the web.

Motorola Type II – the radios only send the radio ID and radio channel code to the control channel. The central computer keeps a database of radio ID's and which talk group is assigned to which channel code for each radio, so with this system the user's radio sends only about $\frac{1}{3}$ the data as a Type I system with each transmission. Type II systems do not use Fleet-subfleet talk groups; instead they use a 5-digit ID for each talk group.

Type III Hybrid — these systems support a mix of both Type I and Type II users. Like Type I systems, you must know the system's fleet map to ensure proper tracking.

EDACS Trunking

EDACS trunking works in much the same way as Motorola trunking with a couple of major differences. In an EDACS system, each frequency used by the system is assigned a Logical Channel Number (LCN) so that less data needs to be transmitted by the control channel. Also, talk groups are assigned in an Agency-Fleet-Subfleet (AFS) hierarchy. Also, there is one variation of EDACS called SCAT that your BC246T can monitor.

Logical Channel Numbers – each frequency used by the system is assigned an LCN. This information is programmed into each user radio. When a user presses PTT, their radio sends their AFS information to the control channel. The computer then assigns that talk group to a channel and sends the LCN so that all other radios in that

Understanding Scanning

talk group will switch to the correct channel. To program an EDACS system in your scanner, you will need to know both the frequencies used by the system and the LCN for each frequency.

Agency-Fleet-Subfleet – talk group ID's for EDACS systems are assigned in a way that makes it easy to see at a glance the affiliation of the user. Each radio is assigned a 2-digit agency identifier from 00 – 15. For example, 01 might be used by the police, 02 by ambulance service, 03 by the fire department, and so on. Each agency is then subdivided up to 16 times to provide fleet identification, and then 8 more times to identify subfleets.

For example, the complete AFS for the Police Department West District's dispatch channel might be 01-062. 01 identifies the agency as the police department, 06 identifies the fleet as the West district, and 2 identifies the subfleet as the dispatch channel. While these assignments are somewhat arbitrary and vary from system to system, there are many resources on the web for finding the assignments for most systems. Because of the logical hierarchy of the AFS system, your BC246T lets you assign wildcard ID's that let you, for example, use only one ID memory to identify all units in either an agency or a fleet.

EDACS SCAT – EDACS SCAT (Single Channel Autonomous Trunking) systems operate on a single channel and alternate control data with analog voice traffic. While your BC246T cannot track ID's in this system, it can eliminate the control data so that all you hear is the voice transmissions when you monitor this type of system.

LTR Trunking

LTR (Logic Trunked Radio) systems are trunking systems used primarily by business or private communications service providers, such as taxicabs, delivery trucks, and repair services. These systems encode all control information as digital subaudible data that accompanies each transmission, so there is no separate control channel.

Understanding Scanning

Users on an LTR system are assigned to specific talk groups, which are identified by the radio as six digit numbers.

These numbers are in the form AHHUUU, where:

A = Area code (0 or 1)

H = Home repeater (01 through 20)

U = User ID (000 through 254)

When the scanner receives a transmission on a channel set to the LTR mode, it first decodes the LTR data included with the transmission. In the ID search mode, the scanner stops on the transmission and displays the talk group ID on the display. In the ID scan mode, the scanner only stops on the transmission if the LTR data matches a talk group ID that you have stored in the talk group ID list and have not locked out. LTR systems are frequently programmed so that each radio has a unique user ID.

Where To Get More Information

By itself, this manual really only provides part of what you need to know to have fun scanning – how to program and use the scanner. The two included conventional and trunking frequency guides will give you a good head start on the other part of what you need to know – what frequencies have interesting content.

Information On The Internet

The Internet is a great source for current frequencies and information about scanning. Many web sites have lists of frequencies for your area. You can use a search engine to find and use them.

Make a list of the agencies you want to listen to, then look up the frequencies and systems used by those agencies. Here are a few useful sites:

- <http://www.scannermaster.com> * - frequency resources and home of Police Call.

Understanding Scanning

You can also call them at 1 800 SCANNER (hours are from 10:00 a.m. to 5:00 p.m. Eastern Time Monday through Friday).

- <http://www.radioreference.com> * - the Internet's premier source for user-supported radio system information.
 - <http://www.bearcat1.com> - frequency information from National Communications.
 - svartifoss2.fcc.gov/reports/index.cfm * - conventional frequency information on file with the US Government
- * - This web site is not affiliated with Uniden Corporation.

To purchase another copy of the conventional or trunking frequency guide, contact your local dealer or:

Uniden Parts Department
(800) 554-3988
(Hours are from 8:00 a.m. to 5:00 p.m. Central Time Monday through Friday.)

For more information about Uniden and our other products, visit <http://www.uniden.com>.

Included With Your Scanner



Scanner

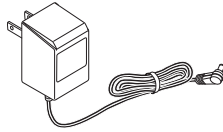

AC Adapter



Wrist Strap



Batteries

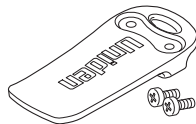

Belt Clip

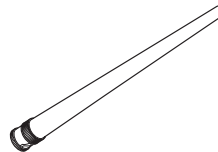

Antenna



Frequency Guide



Owners Manual

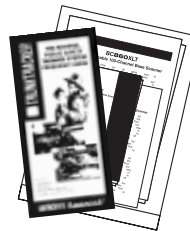

*National Public Safety
Trunked System
Frequency Guide*

If any of these items are missing or damaged, immediately contact your place of purchase or Uniden Customer Service at: (800) 297-1023, 8:00 a.m. to 5:00 p.m., Central, Monday through Friday.

Included With Your Scanner

Setting Up Your Scanner

These guidelines will help you install and set up your new scanner:

- If your scanner receives interference or electrical noise, move the scanner or its antenna away from the source.
- To improve the scanner's reception, use an optional external antenna designed for multi-band coverage. (You can purchase this type of antenna at a local electronics store). If the optional antenna has no cable, use 50-70 ohm coaxial cable for lead-in. A mating plug might be necessary for the optional antennas.
- Use an optional mono earphone or mono headset with proper impedance (32Ω) for private listening. Read the precautions on the inside front cover of this Owners Manual.
- Do not use the scanner in high-moisture environments such as the kitchen or bathroom.
- Avoid placing the scanner in direct sunlight or near heating elements or vents.

Using Internal Batteries

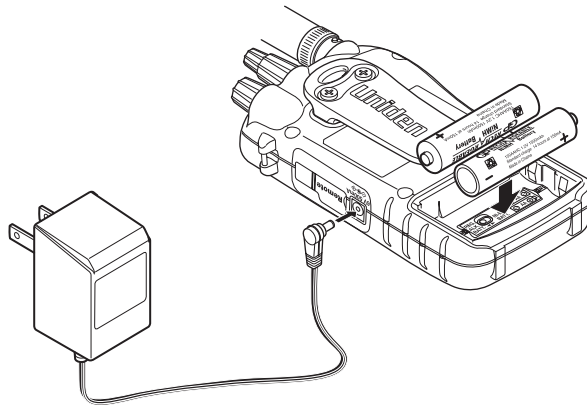

You can power your scanner using two alkaline, or rechargeable AA batteries.

Setting Up Your Scanner

Before installing batteries, set the switch in the battery compartment to match the type of batteries you will use. Select **ALKALINE** for non-rechargeable battery types and **RECHARGEABLE** for rechargeable battery types. See also “Using Rechargeable Batteries” on Page 31 when you use rechargeable batteries.

1. Remove the battery cover and set the battery switch.

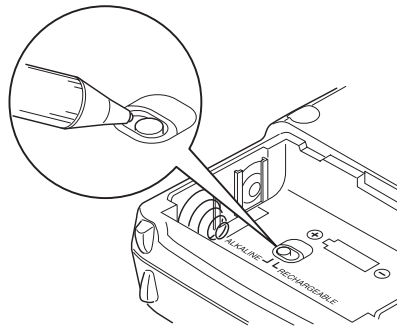

2. Install 2 AA batteries, matching the polarity symbols (+ -).

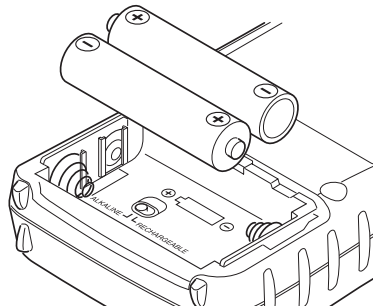

WARNING!

Set **ALKALINE/RECHARGEABLE** to **RECHARGEABLE** for use only rechargeable batteries. Never attempt to recharge non-rechargeable batteries. Non-rechargeable batteries can get hot or burst if you try to recharge them.

Setting Up Your Scanner

3. Replace the cover.

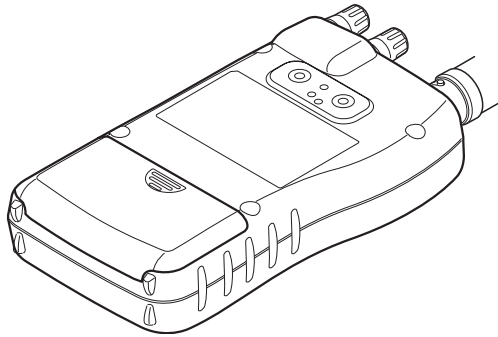

When **BATT** flashes and the scanner beeps every 15 seconds, replace both batteries.

Using Rechargeable Batteries

You can also use two rechargeable batteries to power your scanner. Before you use rechargeable batteries, you must charge them.

The scanner has a built-in circuit that lets you recharge batteries while they are in the scanner. To charge the batteries, set **ALKALINE/RECHARGEABLE** inside the battery compartment to **RECHARGEABLE**, install the batteries in the scanner, and connect the supplied AC adapter to the scanner's DC 6V jack (see "Using AC Power" on Page 32).

WARNING!

Do not connect the AC adapter to the scanner if non-rechargeable batteries (such as alkaline batteries) are installed in the scanner and **ALKALINE/RECHARGEABLE** is set to **RECHARGEABLE**, or if you are unsure of the switch's position. Non-rechargeable batteries will get hot and can even burst if you try to recharge them.

Setting Up Your Scanner

Before you use rechargeable batteries for the first time, charge them for 14 hours to bring them to a full charge.

Discharged batteries take about 14 hours to fully recharge.

Using AC Power

You can power the scanner using the supplied 6V, 500 mA AC adapter.

To use the scanner on AC power, plug the AC adapter into a standard AC outlet.

If rechargeable batteries are installed and **ALKALINE/RECHARGEABLE** is set to **RECHARGEABLE**, the adapter powers the scanner and recharges the installed batteries at the same time.

Connecting the Antenna

To attach the supplied flexible antenna to the connector on the top of your scanner, align the slots around the antenna's connector with the tabs on the scanner's BNC connector. Then slide the antenna's connector down over the scanner's connector and rotate the antenna connector's outer ring clockwise until it locks into place.

Connecting an Optional Antenna

The scanner's BNC connector makes it easy to connect a variety of optional antennas, including an external mobile antenna or outdoor base station antenna.

Note: Always use 50-ohm, RG-58, or RG-8, coaxial cable to connect an outdoor antenna. If the antenna is over 50 feet from the scanner, use RG-8 low-loss dielectric coaxial cable. You can get a BNC adapter at your local electronics store.

Setting Up Your Scanner

Connecting an Earphone/Headphone

For private listening, you can plug a 1/8-inch (3.5 mm) mini-plug earphone or headphones (not supplied) into the headphone jack on top of your scanner. This automatically disconnects the internal speaker.

Connecting an Extension Speaker

In a noisy area, an optional amplified extension speaker, positioned in the right place, might provide more comfortable listening. Plug the speaker cable's 1/8-inch (3.5-mm) mini-plug into your scanner's jack.

WARNING!

If you connect an external speaker to the scanner's headphone jack, never connect the audio output line to a power supply and ground. This might damage the scanner.

Attaching the Belt Clip

To make your scanner easier to carry when you are on the go, use the supplied belt clip. Use a Phillips screwdriver and the supplied screws to attach the clip to the scanner.

Installing the Demo Software

You can operate your scanner using a personal computer and the free demo software available at <http://www.uniden.com>.

If you have installed the software and it is running, select **Help** by right clicking anywhere on the opening screen. A selection popup appears. Move the cursor to **Help**. **BC246TSS Help** appears. Then click on **BC246TSS Help**.

Download the software, then double-click on the install package to begin installation. The BC246T SS Install program installs the software. You must install the software to use the scanner with your computer.

After you install the BC246T SS Install program, start it by double clicking on the desktop icon or by selecting it in the Start Programs list.

You can upgrade the included software to a full version by purchasing a registration key at <http://www.uniden.com>.

Setting Up Your Scanner

A Look At The Keypad

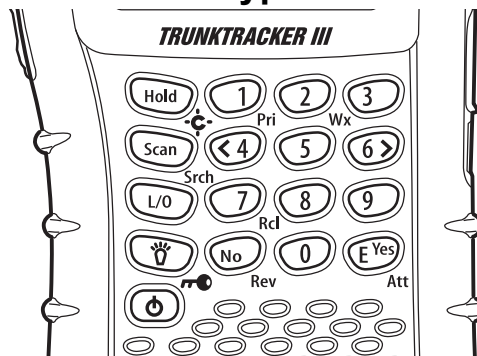



Your scanner's keys have various functions labeled on the key tops and below the keys.





To select the function labeled on a key, simply press the key. To select the function labeled below a key, hold down **Func** on the left side of the scanner then press the key.

F appears on the display.

If your scanner's keys seem confusing at first, the following information should help you understand each key's function.

Key Name	Description
Hold/ 	<p>Hold – Holds the scan or the frequency search.</p> <p>Func +  – Quickly turns the Close Call feature on or off (see “Setting Close Call Options” on Page 84).</p>
Scan/Srch	<p>Scan – Scans the stored channels.</p> <p>Func + Srch – Starts quick search or quickly accesses the search menu.</p>

Setting Up Your Scanner

Key Name	Description
L/O	<p>L/O – Lets you lock out a selected channel or skip a specified frequency.</p> <p>[Func] + L/O – Locks and unlocks a selected system in Scan or Scan Hold mode and reviews search lockout frequencies in Search or Search Hold mode.</p>
 / 	<p> – Turns the display backlight on or off.</p> <p>[Func] +  – Locks and unlocks the keypad.</p>
	<p>Press and hold for more than 2 seconds to turn the scanner on or off. Press quickly to cancel a prompt.</p>
1-9, 0	<p>1-9, 0 – Enters a frequency, enters quick key numbers, and selects a custom search range in Custom Search mode.</p> <p>Selects systems by quick key in scan mode.</p> <p>[Func] + 1-9, 0 – Selects groups by quick key in scan mode.</p>
1/Pri	<p>1 – Enters a 1.</p> <p>[Func] + Pri – Selects the priority mode in scan hold mode.</p>
2/Wx	<p>2 – Enters a 2.</p> <p>[Func] + WX – Selects the weather function in the menu in the Hold mode.</p>

Setting Up Your Scanner

Key Name	Description
</4	<p>4 – Enters a 4.</p> <p>[Func] + < – Moves the active character to the left while editing data.</p>
6/>	<p>6 – Enters a 6.</p> <p>[Func] + > – Moves the active character to the right while editing data.</p>
7/Rcl	<p>7 – Enters a 7.</p> <p>[Func] + Rcl – Displays a series of prompts to quickly select a specific channel in the scan hold mode.</p>
No/•/Rev	<p>• – Enters a decimal point or dash in a frequency or talk group ID, enters an “i” for I-Call input.</p> <p>At a prompt, answers “No.”</p> <p>[Func] + Rev – Monitors the currently-tuned frequency’s reverse frequency.</p>
E/Yes/Att	<p>E – Press to select input and menu items, to quickly edit a channel in Scan Hold Mode, and store a frequency into memory in Scan Hold mode.</p> <p>At a prompt, answers “Yes.”</p> <p>[Func] + Att – Turns the scanner’s attenuator on or off for the current channel (for conventional systems) or system (for trunked systems).</p>

Setting Up Your Scanner

A Look At The Display

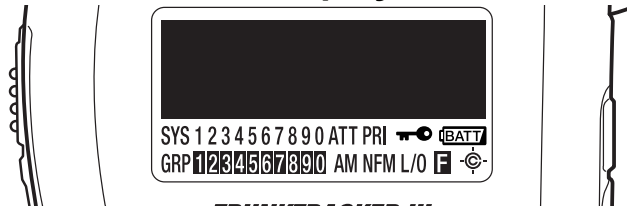



The display has indicators that show the scanner's current operating status. The display information helps you understand how your scanner operates. The dark area shown above the icons in this illustration is the text display area. Information about the currently tuned frequency appears here.

SYS - shows the currently activated system, appears with numbers (0-9). The currently active system indicator flashes.

ATT - appears when the attenuation feature is turned on (see "Setting System Attenuation (Trunked Systems Only)" on Page 68).

PRI - appears when the priority feature is turned on (see "Priority Scan" on Page 45).



 - appears when you lock the keypad (see "Locking/Unlocking the Keypad" on Page 45).

 - alerts you when the battery power gets low.

GRP - shows the currently activated group, appears with numbers (**0-9**). The currently active group indicator flashes.

AM/FM/NFM - appears to show the type of transmission.

L/O - appears when you manually select a channel you locked out or a skip frequency.

 - appears when you hold down  to select a function.

 - appears when the scanner is set to a Close Call feature mode (see "Using the Close Call Feature" on Page 83).

Setting Up Your Scanner

Using Menu

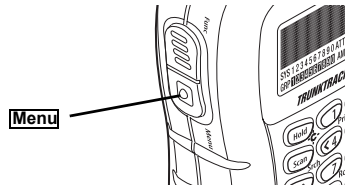

Press **Menu** on the left side of the scanner to enter the menu. See “Using the Menu” on Page 47 for more information about the scanner’s menu options.

Using Func

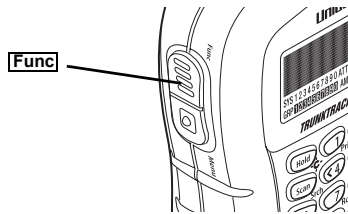

To select the function labeled below a key on the front of the scanner, hold down **Func** on the left side of the scanner, then press that key. To hold on a system while scanning or temporarily stop on a channel while searching, press **Func**. To select a system in Scan or Scan Hold mode, hold down **Func** and rotate the scroll control.

Using the Scroll Control

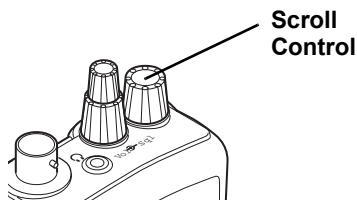

Turn the scroll control on top of the scanner to select a channel or frequency in Hold mode, select menu items in Menu mode, and to select a character while editing a name. You can also press the scroll control down instead of pressing **E** on the keypad to select an item.

Setting Up Your Scanner

Basic Operation

Turning On the Scanner and Setting the Squelch

Note: Make sure the scanner's antenna is connected before you turn it on.

1. Turn **Sq1** fully counterclockwise.
2. Press and hold **⏻** for about 2 seconds to turn on the scanner, then turn **Vol** clockwise until you hear a hissing sound.
3. Turn **Sq1** clockwise until the hissing stops.

Scanning Systems

To begin scanning programmed systems, press **Scan**. The BC246T scans all unlocked systems in all activated quick-key groups.

Notes:

- If no systems are programmed, or all systems are locked out, an error message appears. Program a system or select a system to scan.
- When scanning multiple systems, the BC246T scans systems according to the assigned quick key. Systems assigned to quick key 1 are scanned first, then 2, 3, 4, etc. Systems not assigned to a quick key are scanned last. Within a quick key, systems are scanned in the order they were assigned.
- Within a system, channels are scanned according to the assigned channel group, with the same priority as described above for systems.
- The BC246T scans a system for the duration you set using the System Hold Time option (see "Setting the System Hold Time" on Page 63). For trunked systems, the scanner moves to the next system after the hold time expires, the current transmission ends, and the channel delay expires. Conventional systems operate similarly, but all unlocked channels are scanned at least one time regardless of the hold time setting.

Basic Operation

Preprogrammed System Tips

All systems preprogrammed into the scanner are assigned to quick key 9. To turn the preprogrammed systems on or off, simply press **9** while scanning.

You can scan preprogrammed systems more efficiently by preventing the BC246T from scanning systems that are not in your area. There are three ways to do this:

- Lock out the faraway systems (see “Locking/Unlocking Systems” on Page 42).
- Reassign your local systems to another quick key (see “Editing the System Quick Key” on Page 62).
- Delete the faraway systems (see “Deleting Systems” on Page 69).

Important: You cannot restore preprogrammed systems if you delete them.

Selecting Systems to Scan

To select systems to scan, press **Scan** then press the number button corresponding to the quick key assigned to the system or systems. To stop scanning the system(s), press the number button again.

The SYS indicators on the display show the systems that are currently selected.

To select or lock out a system that is not assigned to a key, press and hold **FUNC** while you rotate the scroll control until the desired system is selected. Then, continue to hold **FUNC** and press **L/O** to either lock out or unlock the system.

Selecting System Channel Groups

Within a system, you can assign groups of channels to a group quick key (see “Setting the Group Quick Key” on Page 70).

Follow these steps to activate or deactivate a channel group within a system while scanning.

Basic Operation

-
-
1. Press **[Func]** to hold on the system (or hold **[Func]** and rotate the scroll control to select the system).
 2. Continue to hold **[Func]** and press the number key corresponding to the channel group you want to activate or deactivate.

Locking/Unlocking Systems

Follow these steps to lock out a system so that it does not scan even if its quick key is selected.

1. While holding down **[Func]**, rotate the scroll control to select the system.
2. Continue to hold down **[Func]** and press **L/O** to lock out the system.
3. Repeat Steps 1 and 2 to unlock a system you have previously locked.

Locking/Unlocking Channels

Follow these steps to lock out a channel so that it does not scan even if its system and channel group are selected.

1. While holding down **[Func]**, rotate the scroll control to select the system where the channel is stored.
2. Release **[Func]** then press **Hold** within 2 seconds to hold on the system.
3. Rotate the scroll control to select the channel you want to lock or unlock.
4. Press **L/O** to lock or unlock the channel.

You can also lock out an active channel by pressing **L/O** while the scanner is stopped on the channel.

ID Scan/ID Search Mode

While you are scanning a trunked system, the scanner can be in either ID Scan or ID Search mode:

Basic Operation

-
-
- ID Scan – the scanner only stops on talk group ID's that you have programmed into the system
 - ID Search – the scanner stops on any unlocked talk group that becomes active.

To toggle between ID Scan and ID Search, press **Scan** while the scanner is scanning the system.

Temporarily Holding On a System

To temporarily hold on a system, press and hold **Func**. To hold on a different system, continue to hold **Func** and rotate the scroll control to select the system. Normal scanning resumes 2 seconds after you release **Func**.

Holding On a Channel

To hold on a channel, press **Hold** while the channel is active. To select a different channel, rotate the scroll control. If you scroll past the beginning or end of the current system, the scanner selects channels in the previous or next system. To resume scanning, press **Scan**.

Quickly Storing an ID During ID Search

To quickly store an active talk group ID during ID search, press **E**. You see:

```
QUICK TGID SAVE?  
4128
```

To save the ID into a channel, press **E**. Otherwise, press **No**. If you press **E**, the scanner stores the ID into a channel group called *QUICK SAVE GRP* in the current system, then resumes normal scanning.

Basic Operation

Quick-Storing Channels

1. Hold on an existing channel in any system.
2. Enter the frequency or talk group ID you want to store (press **•** to enter hyphens in talk group ID's).

If you enter a frequency, the scanner stores it in the *QCK SAVE GRP* group in a system called *QCK SAVE CNV SYS*. These are created if they do not exist. Then, the scanner prompts you to save other channel settings.

If you enter a talk group ID, the scanner prompts you to rotate the scroll control to select the system where you want to store the ID. The ID is stored into a channel group named *QCK SAVE GRP* in the selected system. Only systems that match the ID type are shown.

Quickly Recalling Channels

1. Press **Hold** to hold on any channel.
2. Press **[Func] + Rcl**. The scanner prompts you to select the system where the channel is stored.
3. Rotate the scroll control to select the system, then press **E**. The scanner prompts you to select the channel group where the channel is stored.
4. Rotate scroll to select the group, then press **E**. The scanner prompts you to select a channel.
5. Rotate the scroll control to select the channel, then press **E** to hold on that channel.

Monitoring Trunking Activity (Motorola Only)

Press **HOLD** when no talk group is active. Or, press **HOLD**, then scroll to the control channel. Talk Group ID's appear as they become active on the system.

Other Settings

Displaying System Information

Viewing Memory Used

Menu → SEE SCANNER INFO → **E**
% MEMORY USED → **E**

A bar showing the percent of memory used appears.
Press a key, to returns to the previous menu.

Viewing the Firmware Version

Menu → SEE SCANNER INFO → **E**
FIRMWARE VERSION → **E**

Press a key to return to the previous menu.

Adjusting the Key Beep

Menu → ADJUST KEY BEEP → **E**

- *OFF*: The scanner is silent when you press a key.
- *ON*: The scanner beeps when you press a key.

Locking/Unlocking the Keypad

Press **Func** then / to lock or unlock the keypad.

Turning Power Save On or Off

Menu → SET BATTERY SAVE → **E**

- *ON*: The scanner goes into low-power mode when you monitor a conventional channel that has no activity.
- *OFF*: Power save is off.

Priority Scan

Menu → SET PRIORITY → **E**

Or, while holding on any channel, press **Func** + **1/Pri** to select one of these priority modes:





- *PRIORITY OFF*: Normal scanning

Other Settings

-
-
- *PRIORITY ON*: While scanning a conventional system, the scanner interrupts every 2 seconds and checks the priority channels in each unlocked conventional system. Priority channels in lower priority key numbered systems (starting from 1) have highest priority. *PRI* appears when you select this mode.
 - *PRIORITY PLUS*: The scanner only scans priority channels in unlocked conventional systems. *PRI* flashes when you select this mode.

Using the Backlight

Menu →  *SET BACKLIGHT* → **E**

- *10 SEC* The backlight stays on for 10 seconds after you press .
- *30 SEC* The backlight stays on for 30 seconds after you press .
- *SQUELCH* The backlight turns on when the squelch opens then stays on for 5 seconds.
- *KEYPRESS* The backlight turns on when any key is pressed then stays on for 10 seconds.
- *INFINITE* The backlight turns on when you press  then stays on until you press  again.

Pressing any key while the backlight is on extends the backlight period. Pressing  while the backlight is on turns off the backlight.

Initializing the Scanner's Memory

To initialize the scanner's memory, turn off the scanner. Then, press **2, 9**, and **Hold** while turning it on.

Important! This deletes all preprogrammed data. You cannot restore preprogrammed data that has been deleted.

Other Settings

Using the Menu

The scanner's menu lets you select options that let you set up and use the scanner.

To use the menu, press **Menu** on the left side of the scanner. In most cases, the current menu position appears on the upper line of the menu. Menu items and a place to input information appear on the lower line of the menu. To select a menu item, turn the scroll control on top of the scanner clockwise or counterclockwise. When the menu item you want to select appears, press **E** or press the scroll control down to select it. To back up a level or return to the previous level, press **Menu**. To exit the menu mode, press **Scan**.

This table shows the available menu options and where you can find more information about how to use them.

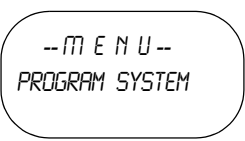
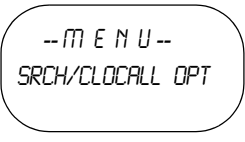
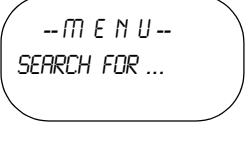
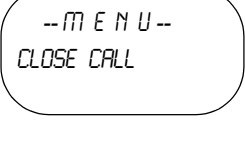
Menu Item	Lets You ...	See ...
	Set up the scanner's scan options.	"Programming Radio Systems" on Page 49.
	Set up the scanner's Close Call option.	"Using the Close Call Feature" on Page 83.
	Set up the scanner's search option.	"Searching" on Page 79.
	Set up the scanner's Close Call operation.	"Setting Close Call Options" on Page 84.

Using the Menu

Menu Item	Lets You ...	See ...
<p>--M E N U-- SET PRIORITY</p>	Set up priority options.	"Priority Scan" on Page 45.
<p>--M E N U-- WX OPERATION</p>	Set up weather options.	"Using Weather Alert (SAME)" on Page 91.
<p>--M E N U-- SET BACKLIGHT</p>	Set up backlight options.	"Displaying System Information" on Page 45.
<p>--M E N U-- ADJUST KEY BEEP</p>	Set up key beep options.	"Adjusting the Key Beep" on Page 45.
<p>--M E N U-- SET BATTERY SAVE</p>	Set up battery save options.	"Turning Power Save On or Off" on Page 45.
<p>--M E N U-- SEE SCANNER INFO</p>	View information about your scanner.	"Displaying System Information" on Page 45.
<p>--M E N U-- XFER INFORMATION</p>	Transfer information between it and your personal computer.	"Installing the Demo Software" on Page 34.

Using the Menu

Programming Radio Systems

Your BC246T comes preprogrammed with the major analog systems used in the 25 most populous counties in the US. However, to get the most enjoyment from your scanner (especially if you do not live near one of these counties), you must customize the programming for your area.

To edit an existing system, use the menu to navigate to the system setting you want to change. This section assumes you are programming a new system.

Programming radio systems is completed in two major steps. Don't skip either step!

1. Plan the system.
2. Program the system into your scanner according to the plan you prepared in Step 1.

To make planning easier, planning worksheets are included in the back of this manual for each system type. Copy the worksheets (or download this manual from the Uniden America Corporation website and print extra sheets), then use them to plan out how you will program the scanner.

Important! Before you start programming your scanner, make sure the batteries are fresh or fully charged. Losing power while programming the scanner might damage the scanner's memory.

General Notes

- You can store up to 200 channels per system
- You can store up to 20 channel groups per system
- Total channels are limited to about 2500.
- Channels that have text tags use more memory than those that do not. If you use a text tag for every channel, total channels are reduced from 2500 (1600 is typical).

Programming Radio Systems

Programming Conventional Systems

Menu → PROGRAM SYSTEMS → E ↻
NEW SYSTEM → E → CONVENTIONAL →
E → CONFIRM? → E

The scanner creates an empty conventional system, with a default name of *SYSTEM NNN C*. *NNN* increments as you add new systems. *C* indicates that this is a conventional system.

Refer to the appropriate section to set system-wide options:

- See “Editing the System Name” on Page 61
- See “Editing the System Quick Key” on Page 62
- See “Setting System Lockout” on Page 62
- See “Setting the System Hold Time” on Page 63
- See “Setting the Channel Delay Time” on Page 63
- See “Setting Data Skip (Conventional Systems Only)” on Page 64
- See “Deleting Systems” on Page 69
- See “Copying/Pasting Systems” on Page 69
- See “Entering/Editing Conventional Channel Groups” on Page 50

Entering/Editing Conventional Channel Groups

To enter channels in a conventional system, first set up a channel group (or groups) to hold the channels. Then, enter the channel and channel parameters in the group(s).

Setting Up a Channel Group

↻ → *EDIT GROUP* → **E** →

↻ → *NEW GROUP* → **E**

The scanner creates a group with a default name of *GROUP NN*. *NN* increments by one for each new group you create within a system.

Refer to the appropriate section to set group-wide options:

- See “Entering/Editing the Group Name” on Page 70
- See “Setting the Group Quick Key” on Page 70
- See “Deleting Groups” on Page 71
- See “Copying/Pasting Systems” on Page 69
- See “Entering/Editing Conventional Channels” on Page 51

Entering/Editing Conventional Channels

↻ → *EDIT CHANNEL* → **E** →

↻ → *NEW CHANNEL* → **E** → *INPUT FREQUENCY*

Enter the frequency for the channel, then press **E**. Then, refer to the appropriate section to change a channel setting:

- See “Editing the Channel Name” on Page 71
- See “Setting Channel Priority (Conventional Channels Only)” on Page 72
- See “Setting Channel Alert” on Page 73
- See “Deleting Channels” on Page 77
- See “Copying/Pasting Channels” on Page 77

To program another channel within the same group, press **Menu**, then repeat the above.

To create another channel group and enter more channels, press **Menu** twice, then proceed from “Setting Up a Channel Group” on Page 51.

Programming Radio Systems

Programming Motorola Systems

Menu → PROGRAM SYSTEMS → **E** ↻

NEW SYSTEM → **E** → MOT → **E**

Next, rotate the scroll control to select the type of Motorola System you will program, then press **E**.

- *800MHZ STANDARD* - Use for 800 MHz systems that use the standard band plan
- *800MHZ SPLINTER* - Use for 800 MHz systems that use the splinter band plan (typically near international borders)
- *900MHZ BAND* - Use for 900 MHz systems
- *VHF BAND* - Use for VHF systems
- *UHF BAND* - Use for UHF systems

Next, refer to the appropriate section to set system-wide options. For most settings, you can accept the default. However, for the items in **bold**, you must enter information in order for your scanner to scan the system.

- See “Editing the System Name” on Page 61
- See “Editing the System Quick Key” on Page 62
- See “Setting System Lockout” on Page 62
- See “Setting the System Hold Time” on Page 63
- See “Setting the Channel Delay Time” on Page 63
- See “Setting ID Scan/Search (Trunked Systems Only)” on Page 64
- See “Editing the Fleet Map (Motorola Systems Only)” on Page 65 (**must be set up for Type I systems**)
- See “Setting the Motorola Status Bit (Motorola Systems Only)” on Page 65
- See “Setting the End Code Operation (Motorola Systems Only)” on Page 66
- See “Setting I-Call (Motorola and EDACS Systems Only)” on Page 66
- See “Setting Emergency Alert (Motorola and EDACS Systems Only)” on Page 67

Programming Radio Systems

-
-
- See “Setting Control-Channel Only (Motorola Systems Only)” on Page 68
 - See “Setting System Lockout” on Page 62
 - See “Reviewing Locked Out Frequencies” on Page 86
 - See “Setting System Attenuation (Trunked Systems Only)” on Page 68
 - See “Deleting Systems” on Page 69
 - See “Copying/Pasting Systems” on Page 69
 - **See “Setting System Frequencies” on Page 53**
 - **See “Entering/Editing Motorola Channel Groups” on Page 53**

Setting System Frequencies

SET FREQUENCIES → E

↻ NEW FREQUENCY → E

Input a system frequency, then press E.

To enter additional frequencies, press **Menu**, use the scroll control to select *NEW FREQUENCY*, then repeat the above.

Note: If you select Control Channel Only mode (see “Setting Control-Channel Only (Motorola Systems Only)” on Page 68), you only need to enter the frequency(s) that can be assigned as the control channel (this is usually notated on the available frequency lists). Otherwise, you must enter all of the frequencies.

Entering/Editing Motorola Channel Groups

To enter channels in a system, first set up a channel group (or groups) to hold the channels. Then, enter the channel and channel parameters in the group(s).

Setting Up a Channel Group

↻ EDIT GROUP → E ↻ NEW GROUP → E

The scanner creates a group with a default name of *GROUP NN*. *NN* increments by one for each new group you create within a system.

Next, refer to the appropriate section to set group-wide options:

- See “Entering/Editing the Group Name” on Page 70
- See “Setting the Group Quick Key” on Page 70
- See “Deleting Groups” on Page 71
- See “Copying/Pasting Systems” on Page 69
- See “Entering/Editing Motorola Channels” on Page 54

Entering/Editing Motorola Channels

↻ EDIT CHANNEL → E

↻ NEW CHANNEL → E INPUT TGID

Enter the Talk Group ID for the channel, then press **E**.

Notes:

- Motorola Type 2 Talk Group ID's are entered as 5-digit numbers.
- Motorola Type 1 Talk Group ID's are entered as two numbers separated by a hyphen. Use the decimal point to enter the hyphen.
- To enter an I-Call ID, press •, then enter the ID. The • displays as *l* when entering the ID, but as *7* when it is active on a Type 2 system.

Then, refer to the appropriate section to change a channel setting:

- See “Editing the Channel Name” on Page 71
- See “Setting Emergency Alert (Motorola and EDACS Systems Only)” on Page 67

Programming Radio Systems

-
-
- See “Setting Channel Lockout” on Page 76
 - See “Deleting Channels” on Page 77
 - See “Copying/Pasting Channels” on Page 77

To program another channel within the same group, press **Menu**, then repeat the above.

To create another channel group and enter more channels, press **Menu** twice, then proceed from “Entering/Editing Motorola Channel Groups” on Page 53.

Programming EDACS Systems

Menu → PROGRAM SYSTEMS → **E** ↻
 NEW SYSTEM → **E** ↻ EDACS → **E**

Next, rotate the scroll control to select the type of EDACS system you will program, then press **E**.

- *WIDE* - Use for wideband EDACS systems
- *NARROW* - Use for narrowband EDACS systems
- *SCAT*- Use for EDACS SCAT (Single Channel Autonomous Trunking)

When the scanner prompts *CONFIRM?*, press **E** to accept the settings. The scanner creates an empty EDACS system, with a default name of *SYSTEM NNN E*. *NNN* increments as you add new systems. The *E* indicates that this is an EDACS system.

Next, refer to the appropriate section to set system-wide options. For most settings, you can accept the default. However, for the items in **bold**, you must enter information in order for your scanner to scan the system.

- See “Editing the System Name” on Page 61
- See “Editing the System Quick Key” on Page 62
- See “Setting System Lockout” on Page 62
- See “Setting the System Hold Time” on Page 63
- See “Setting the Channel Delay Time” on Page 63
- See “Setting ID Scan/Search (Trunked Systems Only)” on Page 64

Programming Radio Systems

-
-
- See “Setting I-Call (Motorola and EDACS Systems Only)” on Page 66
 - ee “Setting Emergency Alert (Motorola and EDACS Systems Only)” on Page 67
 - See “Setting the EDACS ID Format” on Page 67
 - See “Reviewing Locked Out Frequencies” on Page 86
 - See “Setting Channel Attenuation (Conventional Channels Only)” on Page 75
 - See “Deleting Systems” on Page 69
 - See “Copying/Pasting Systems” on Page 69
 - **See “Setting System Frequencies” on Page 56**
 - **See “Entering/Editing EDACS Channel Groups” on Page 56**

Setting System Frequencies

SET FREQUENCIES → E →

↻ → NEW FREQUENCY → E

Input a system frequency, then press **E**. The scanner then prompts you to enter the LCN for the entered frequency. Enter the LCN, then press **E**.

To enter additional frequencies, press **Menu**, scroll to *NEW FREQUENCY*, then repeat the above.

Note: The scanner only accepts a single frequency and no LCN for SCAT systems.

Entering/Editing EDACS Channel Groups

To enter channels in a system, first set up a channel group (or groups) to hold the channels. Then, enter the channel and channel parameters in the group(s).

Setting Up a Channel Group

↻ → EDIT GROUP → E →

↻ → NEW GROUP → E

The scanner creates a group with a default name of *GROUP NN*. *NN* increments by one for each new group you create within a system.

Next, refer to the appropriate section to set group-wide options:

- See “Entering/Editing the Group Name” on Page 70
- See “Setting the Group Quick Key” on Page 70
- See “Deleting Groups” on Page 71
- See “Editing the Channel Name” on Page 71

Entering/Editing EDACS Channels

↻ → *EDIT CHANNEL* → **E** →

↻ → *NEW CHANNEL* → **E** → *INPUT TGID*

Enter the Talk Group ID for the channel, then press **E**.

Notes:

- If you have selected to use AFS format for Talk Group ID's (the default), use the decimal point to enter the hyphens.
- To enter an I-Call ID, press **•**, then enter the ID.
- If you omit the fleet and/or subfleet, the scanner treats these fields as wildcards.

Then, refer to the appropriate section to change a channel setting:

- See “Editing the Channel Name” on Page 71
- See “Setting Channel Alert” on Page 73
- See “Setting Channel Lockout” on Page 76
- See “Deleting Channels” on Page 77
- See “Copying/Pasting Channels” on Page 77

To program another channel within the same group, press **Menu**, then repeat the above. To create another channel group and enter more channels, press **Menu** twice, then proceed from “Entering/Editing EDACS Channel Groups” on Page 56.

Programming Radio Systems

Programming LTR Systems

Menu → PROGRAM SYSTEMS → E ↻

NEW SYSTEM → E → LT →

E → CONFIRM? → E

When the scanner prompts *CONFIRM?*, press **E** to accept the settings. The scanner creates an empty LTR system, with a default name of *SYSTEM NNN L*. *NNN* increments as you add new systems. *L* indicates that this is an LTR system.

Next, refer to the appropriate section to set system-wide options. For most settings, you can accept the default. However, for the items in **bold**, you must enter information in order for your scanner to scan the system.

- See “Editing the System Name” on Page 61
- See “Editing the System Quick Key” on Page 62
- See “Editing the System Quick Key” on Page 62
- See “Setting the System Hold Time” on Page 63
- See “Setting the Channel Delay Time” on Page 63
- See “Setting ID Scan/Search (Trunked Systems Only)” on Page 64
- See “Reviewing Locked Out Frequencies” on Page 86
- See “Setting Channel Attenuation (Conventional Channels Only)” on Page 75
- See “Deleting Systems” on Page 69
- See “Copying/Pasting Systems” on Page 69
- **See “Setting System Frequencies” on Page 58**
- **See “Entering/Editing LTR Channel Groups” on Page 59**

Setting System Frequencies

SET FREQUENCIES → E

↻ NEW FREQUENCY → E

Programming Radio Systems

Input a system frequency, then press **E**. The scanner then prompts you to enter the LCN for the entered frequency. Enter the LCN, then press **E**.

To enter additional frequencies, press **Menu**, use the scroll control to select *NEW FREQUENCY*, then repeat the above.

Entering/Editing LTR Channel Groups

To enter channels in a system, first set up a channel group (or groups) to hold the channels. Then, enter the channel and channel parameters in the group(s).

Setting Up a Channel Group

↻ → *EDIT GROUP* → **E** →

↻ → *NEW GROUP* → **E**

The scanner creates a group with a default name of *GROUP NN*. *NN* increments by one for each new group you create within a system.

Next, refer to the appropriate section to set group-wide options:

- See “Entering/Editing the Group Name” on Page 70
- See “Setting the Group Quick Key” on Page 70
- See “Setting Channel Lockout” on Page 76
- See “Deleting Groups” on Page 71
- See “Copying/Pasting Systems” on Page 69
- See “Entering/Editing LTR Channels” on Page 59

Entering/Editing LTR Channels

↻ → *EDIT CHANNEL* → **E** →

↻ → *NEW CHANNEL* → **E** →

INPUT TGID

Enter the talk group ID for the channel, then press **E**.

Note: Press **No** to enter a hyphen.

Then, refer to the appropriate section to change a channel setting:

- See “Editing the Channel Name” on Page 71
- See “Setting Channel Alert” on Page 73
- See “Setting Channel Lockout” on Page 76
- See “Deleting Channels” on Page 77
- ee “Copying/Pasting Channels” on Page 77

To program another channel within the same group, press **Menu**, then repeat the above.

To create another channel group and enter more channels, press **Menu** twice, then proceed from “Entering/Editing LTR Channel Groups” on Page 59.

Programming/Editing Optional Settings

This section details the instructions for each of the optional programming steps referred to in “Programming Radio Systems” on Page 49. Use the instructions in the appropriate section to enter or edit a setting.

System-Level Settings

These settings apply to the entire system.

Editing the System Name

Menu → PROGRAM SYSTEMS → **E** ↻

Select the system → **E** ↻

System name you want to edit → **E**

Follow these steps to enter/edit the system name.

1. Rotate the scroll control to select the first letter.
2. Press **Func** then rotate the scroll control once to select the next letter.
3. Repeat Steps 1 and 2 until you have entered the system name. Then press **E** or press down on the scroll control to accept the setting.

Hints:

- Each system name can be up to 16 characters. Abbreviate as necessary to fit.
- The default system names include the following letter in the 16th position to indicate the system type:

M = Motorola

E = EDACS

L = LTR

C = Conventional

- Press **E** twice to delete the current character.
- Press **E** three times to clear the entire alpha tag.

Programming/Editing Optional Settings

Editing the System Quick Key

[MENU] → PROGRAM SYSTEMS → **E** ↻

Select the system → **E** ↻

EDIT SYS OPTION → **E** ↻

SET QUICK KEY → **E**

After selecting this option, press 0-9 to assign the system to a quick key or press **No** to assign the system to no quick key, then press **E**.

Hints:

- You can assign as many systems to the same quick key as you want.
- Preprogrammed systems are set to quick key 9.
- To be scanned, a system's quick key must be activated and the system must be unlocked.

Setting System Lockout

[Menu] → PROGRAM SYSTEMS → **E** ↻

Select the system → **E** ↻

EDIT SYS OPTION → **E** ↻

SET QUICK KEY → **E**

This setting controls whether the system is scanned when its quick key is enabled. Rotate the scroll control to select your setting, then press **E**.

LOCKED - the system is not scanned

UNLOCKED - the system is scanned

Note: You can also lock or unlock a system by pressing **[Func]**, selecting the system, then pressing **[Func]** + **L/O**.

Programming/Editing Optional Settings

Setting the System Hold Time

Menu → PROGRAM SYSTEMS → E ↻

Select the system → E ↻

EDIT SYS OPTION → E ↻

SET HOLD TIME → E

This setting controls how many seconds the scanner scans a system before moving to the next unlocked system. Enter a value from 0-255, then press **E** to save the setting.

Notes:

- If you select 0, the scanner stays on the system for a minimal time (only long enough to check current system activity).
- The default setting is 2 seconds for each system.
- For conventional systems, all channels will be scanned at least one time regardless of this setting.
- The scanner moves to the next system after the hold time expires, any current transmission ends, and the channel delay time expires.

Setting the Channel Delay Time

Menu → PROGRAM SYSTEMS → E ↻

Select the system → E ↻

EDIT SYS OPTION → E ↻

SET DELAY TIME → E

This setting controls how many seconds the scanner waits after a transmission ends before resuming scanning. Enter a value from 1-5 or OFF, then press **E**.

Notes:

- The default setting is 2 seconds for each system.
- This setting applies to all channels within the system.

Programming/Editing Optional Settings

Setting ID Scan/Search (Trunked Systems Only)

Menu → PROGRAM SYSTEMS → E ↻

Select the system → E ↻

EDIT SYS OPTION → E ↻

ID SCAN/SEARCH → E

This setting controls how the system will be scanned.
Select your setting, then press **E**.

ID SCAN - the scanner only stops on channels you have programmed into the system.

ID SEARCH - the scanner stops on any transmission for unlocked talk group ID's.

Note: You can also change this setting by pressing **Scan** while scanning the system.

Setting Data Skip (Conventional Systems Only)

Menu → PROGRAM SYSTEMS → E ↻

Select the system → E ↻

EDIT SYS OPTION → E ↻

SET DATA SKIP → E

This setting controls how the scanner behaves when it stops on a channel that has a constant-level signal.

ON - the scanner stops briefly on the channel, but then immediately resumes scanning automatically.

OFF - the scanner remains on the channel until the transmission stops.

Notes:

- This setting is ignored for AM channels.
- The default setting for this feature is *ON*.

Programming/Editing Optional Settings

Editing the Fleet Map (Motorola Systems Only)

Menu → PROGRAM SYSTEMS → E ↻

Select the system → E ↻

EDIT SYS OPTION → E ↻

EDIT FLEET MAP → E

For Motorola Type I systems, you must enter a system fleet map in order for the scanner to properly track and display talk group ID's. The fleet map is usually included in the same resource that provided system frequencies and talk group ID lists.

Rotate the scroll control to select the fleet map:

PRESET - select from the 16 most common fleet maps (see "Preset Fleet Maps" on Page 105)

CUSTOM - allows you to enter a custom fleet map. Enter the size code for each block.

Notes:

- If you don't know the fleet map for your Motorola Type I system, check the Internet. This information is commonly posted on sites such as those we reference in "Where To Get More Information" on Page 26.
- The default setting of no fleet map is the correct setting for Motorola Type II systems.

Setting the Motorola Status Bit (Motorola Systems Only)

Menu → PROGRAM SYSTEMS → E ↻

Select the system → E ↻

EDIT SYS OPTION → E ↻

SET STATUS BIT → E

Motorola systems use talk group ID's in multiples of 16. ID numbers that fall between these ID's indicate special

Programming/Editing Optional Settings

status flags for the system. This setting determines how the scanner will handle ID's that are not multiples of 16. Select your setting then press **E**.

IGNORE - the scanner rounds all received ID's down to the next interval of 16.

YES - the scanner treats all received ID's as unique ID's.

Note: The default setting is *IGNORE*.

Setting the End Code Operation (Motorola Systems Only)

Menu → *PROGRAM SYSTEMS* → **E** ↻

Select the system → **E** ↻

EDIT SYS OPTION → **E** ↻

SET END CODE → **E**

This setting determines how the scanner handles the transmission end code sent by most Motorola systems. Select your setting then press **E**.

YES - the scanner immediately returns to the control channel when it detects the end code.

IGNORE - the scanner does not return to the control channel until the carrier drops.

Note: The default setting is *YES*.

Setting I-Call (Motorola and EDACS Systems Only)

Menu → *PROGRAM SYSTEMS* → **E** ↻

Select the system → **E** ↻

EDIT SYS OPTION → **E** ↻

SET I CALL → **E**

I-calls are direct "individual" radio calls made from one radio to another. This setting determines how your scanner treats I-calls while ID Searching.

Programming/Editing Optional Settings

ON - the scanner tracks I-calls

OFF - the scanner ignores I-calls

ONLY - the scanner only tracks I-calls and ignores other radio traffic on the system.

Note: The default setting is *OFF*.

Setting Emergency Alert (Motorola and EDACS Systems Only)

Menu → PROGRAM SYSTEMS → E ↻

Select the system → E ↻

EDIT SYS OPTION → E ↻

SET EMERGENCY ALERT → E

This setting determines how your scanner handles radio traffic that has the emergency flag set. Select your setting then press **E**.

ALERT - the scanner sounds an alert beep to notify you of the emergency transmission.

IGNORE - the scanner does not alert you to emergency transmissions.

Note: The scanner defaults to *IGNORE*.

Setting the EDACS ID Format

EDACS talkgroup ID's are commonly provided in one of two formats: AFS and Decimal. This setting determines how you enter EDACS ID's and how the scanner displays them.

AFS FORMAT - the scanner uses AFS format for talkgroup ID's

DECIMAL FORMAT - the scanner uses decimal format for talkgroup ID's

Notes:

Programming/Editing Optional Settings

-
-
- The scanner defaults to AFS (agency, fleet, subfleet) format - the format used in most EDACS systems.
 - See “EDACS Trunking” on Page 24 for more information about the AFS format.

Setting Control-Channel Only (Motorola Systems Only)

Menu → PROGRAM SYSTEMS → **E** ↻
Select the system → **E** ↻
EDIT SYS OPTION → **E** ↻
SET C-CH ONLY → **E**

This setting determines the frequencies you need to enter for Motorola systems. Select your setting, then press **E**.

OFF - you must enter all voice and control channel frequencies.

ON - you only need to enter control channel frequencies.

Note: The scanner defaults to *OFF*.

Setting System Attenuation (Trunked Systems Only)

Menu → PROGRAM SYSTEMS → **E** ↻
Select the system → **E** ↻
SET ATTENUATION → **E**

This setting controls whether the attenuator will be on or off for the current system. Select your setting then press **E**.

OFF - the attenuator is off.

ON - system frequencies are attenuated by about 18dB.

Notes:

- Turn on this setting if you are near other strong signal sources. Attenuation sometimes helps to reduce

Programming/Editing Optional Settings

interference and desensitization that strong signals create.

- You can also turn this setting on or off by holding on a trunked system, then pressing **[Func]** + **E**.

Deleting Systems

[Menu] → PROGRAM SYSTEMS → **E** ↻

Select the system → **E** ↻

DELETE SYSTEM → **E**

The scanner prompts you to confirm deletion. To confirm, press **E**. To cancel, press **No**.

Notes:

- Deleted systems cannot be restored. You must re-enter them.
- You cannot restore preloaded systems.

Copying/Pasting Systems

To copy a system including all settings, groups, and channels:

[Menu] → PROGRAM SYSTEMS → **E** ↻

Select the system → **E** ↻

COPY SYSTEM → **E**

The scanner copies the system into a copy buffer.
To paste the system:

[Menu] → PROGRAM SYSTEMS → **E** ↻

Select the system → **E** ↻

PASTE SYSTEM → **E**

Then edit the system you copied to give it a unique name and other settings.

Note: The paste option appears only if you have previously copied a system.

Programming/Editing Optional Settings

Group-Level Settings

The settings in this section apply to all of the channels stored in the current group.

Entering/Editing the Group Name

Menu → PROGRAM SYSTEMS → **E** ↻

Select the system → **E** ↻

Select the group → **E**

EDIT NAME → **E**

Follow these steps to enter/edit the group name.

1. Rotate the scroll control to select the first letter.
2. Press **Func** then rotate the scroll control once to select the next letter.
3. Repeat Steps 1 and 2 until you have entered the system name. Then press **E** or press down on the scroll control to accept the setting.

Hints:

- Each system name can be up to 16 characters. Abbreviate as necessary to fit.
- The group name and system name alternate in the top line of the display when the scanner stops on a channel.
- Press **•** twice to delete the current character.
- Press **•** three times to clear the entire alpha tag.

Setting the Group Quick Key

Menu → PROGRAM SYSTEMS → **E** ↻

Select the system → **E** ↻

EDIT GROUP → **E**

Select the group → **E**

SET QUICK KEY → **E**

Programming/Editing Optional Settings

After selecting this option, press **0-9** to assign the group to a quick key or press **No** to assign the system to no quick key, then press **E**.

Hints:

- You can assign as many groups to the same quick key as you want.
- To be scanned, a group's quick key must be activated.

Deleting Groups

Menu → PROGRAM SYSTEMS → **E** ↻

Select the system → **E** ↻

EDIT GROUP → **E** ↻

Select the group → **E**

DELETE GROUP

The scanner prompts you to confirm deletion. To confirm, press **E**. To cancel, press **No**.

Note: Deleted groups cannot be restored. You must re-enter them.

Channel-Level Settings

These settings affect only the channel you are programming.

Editing the Channel Name

Menu → PROGRAM SYSTEMS → **E** ↻

Select the system → **E** ↻

EDIT GROUP → **E** ↻

Select the group → **E**

EDIT CHANNEL → **E** ↻

Select the channel → **E**

EDIT NAME → **E**

Follow these steps to enter/edit the channel name.

1. Rotate the scroll control to select the first letter.

Programming/Editing Optional Settings

-
-
2. Press **[Func]** then rotate the scroll control once to select the next letter.
 3. Repeat Steps 1 and 2 until you have entered the channel name. Then press **E** or press down on the scroll control to accept the setting.

Hints:

- Each channel name can be up to 16 characters. Abbreviate as necessary to fit.
- The channel name appears on the second line of the display when the scanner stops on a channel.
- If you do not enter a channel name, the scanner displays the frequency (for conventional systems) or the talk group ID (for trunked systems) when it stops on a channel.
- Press **•** twice to delete the current character.
- Press **•** three times to clear the entire alpha tag.
- Channel names take up extra memory. To maximize channels, use channel names only where necessary.

Setting Channel Priority (Conventional Channels Only)

[Menu] → PROGRAM SYSTEMS → **E** ↻

Select the system → **E** ↻

EDIT GROUP → **E** ↻

Select the group → **E**

EDIT CHANNEL → **E** ↻

Select the channel → **E**

SET PRIORITY → **E**

This setting controls whether the scanner treats the channel as a priority channel while scanning. Select your setting, then press **E**.

ON - when you turn on the Priority feature, the channel will be scanned every 2 seconds. *P* appears at the end of the default name.

Programming/Editing Optional Settings

OFF - the channel will not be treated with priority.

Note: The default setting is *OFF*.

Setting Channel Alert

Menu → PROGRAM SYSTEMS → **E** ↻

Select the system → **E** ↻

EDIT GROUP → **E** ↻

Select the group → **E**

EDIT CHANNEL → **E** ↻

Select the channel → **E**

SET ALERT → **E**

This setting controls whether the scanner will alert you when the channel becomes active. Select your setting, then press **E**.

ON - the scanner beeps when the channel becomes active.

OFF - no alert sounds.

Note: The default setting is *OFF*.

Setting CTCSS/DCS (Conventional Channels Only)

Menu → PROGRAM SYSTEMS → **E** ↻

Select the system → **E** ↻

EDIT GROUP → **E** ↻

Select the group → **E**

EDIT CHANNEL → **E** ↻

Select the channel → **E**

SET CTCSS/DCS → **E**

This setting controls a subaudible CTCSS or DCS is used for the channel. Select your setting, then press **E**.

OFF - any signal opens squelch.

SEARCH - the scanner searches for and displays any CTCSS or DCS tone that accompanies the transmission.

Programming/Editing Optional Settings

CTCSS - the scanner only opens squelch if the CTCSS tone you select is also present with the signal. The scanner then prompts you to enter or scroll to the desired tone.

DCS - the scanner only opens squelch if the DCS tone you select is also present with the signal. The scanner then prompts you to enter or scroll to the desired tone.

SET LOCKOUT - the scanner does not stop on the channel if the tone you select is present. The scanner prompts you to select a CTCSS or DCS tone.

Notes:

- The default setting is *OFF*.
- See “What is CTCSS/DCS?” on Page 18 for a complete list of CTCSS and DCS tones.

Setting Channel Modulation (Conventional Channels Only)

Menu → *PROGRAM SYSTEMS* → **E** ↻

Select the system → **E** ↻

EDIT GROUP → **E** ↻

Select the group → **E**

EDIT CHANNEL → **E** ↻

Select the channel → **E**

SET MODULATION → **E**

This setting controls the demodulation method used for the channel. Select your setting, then press **E**.

AUTO - the scanner uses the default modulation for the frequency (see the table at the front of the manual).

AM - the scanner uses AM (amplitude modulation) for the frequency.

FM - the scanner uses FM (frequency modulation) for the frequency.

Programming/Editing Optional Settings

NFM - the scanner uses narrowband FM for the frequency.

Note: The default setting is *AUTO*.

Setting Channel Attenuation (Conventional Channels Only)

Menu → *PROGRAM SYSTEMS* → **E** ↻

Select the system → **E** ↻

EDIT GROUP → **E** ↻

Select the group → **E**

EDIT CHANNEL → **E** ↻

Select the channel → **E**

SET ATTENUATOR → **E**

This setting controls whether the scanner attenuates signals on this channel. Select your setting, then press **E**.

ON - the channel is attenuated by about 18 dB

OFF - The channel is not attenuated.

Notes:

- The default setting is *OFF*.
- For trunked systems, the attenuation is a system-level setting.
- You can also toggle this setting by holding on the channel and pressing **Func** and **E/ATT**

Setting the Frequency Step (Conventional Channels Only)

Menu → *PROGRAM SYSTEMS* → **E** ↻

Select the system → **E** ↻

EDIT GROUP → **E** ↻

Select the group → **E**

EDIT CHANNEL → **E** ↻

Programming/Editing Optional Settings

Select the channel → **E**

SET STEP → **E**

This setting selects the frequency step used for setting the channel's. Select your setting, then press **E**.

AUTO - the step is based on the band (see the table at the front of the manual)

5.0 KHZ, 6.25 KHZ, 7.5 KHZ, 10.0 KHZ, 12.5 KHZ, 15.0 KHZ, 25.0 KHZ, 50.0 KHZ, 100.0 KHZ The scanner uses the selected step.

Note: The scanner defaults to *AUTO*.

Setting Channel Lockout

[MENU] → PROGRAM SYSTEMS → **E** ↻

Select the system → **E** ↻

EDIT GROUP → **E** ↻

Select the group → **E**

EDIT CHANNEL → **E** ↻

Select the channel → **E**

SET LOCKOUT → **E**

This setting determines whether the scanner will scan this channel when its system and group are enabled. Select your setting, then press **E**.

LOCKOUT - the channel is not scanned.

UNLOCKED - the channel is scanned.

Notes:

- The default setting is Unlocked.
- You can also lock or unlock a channel by selecting it while scanning or holding, then pressing **L/O**. See "Basic Operation" on Page 40.

Programming/Editing Optional Settings

Deleting Channels

Menu → PROGRAM SYSTEMS → E ↻

Select the system → E ↻

EDIT GROUP → E ↻

Select the group → E

EDIT CHANNEL → E ↻

Select the channel → E

DELETE CHANNEL → E

The scanner prompts you to confirm deletion. To confirm, press **E**. To cancel, press **No**.

Note: Deleted channels cannot be restored. You must re-enter them.

Copying/Pasting Channels

To copy a channel including all settings:

Menu → PROGRAM SYSTEMS → E ↻

Select the system → E ↻

EDIT GROUP → E ↻

Select the group → E

EDIT CHANNEL → E ↻

Select the channel → E

COPY CHANNEL → E

The scanner copies the channel into a copy buffer.

To paste the channel into the same or another system:

Menu → PROGRAM SYSTEMS → E ↻

Select the system → E ↻

EDIT GROUP → E ↻

Select the group → E

EDIT CHANNEL → E ↻

Programming/Editing Optional Settings

Select the channel → **E**

PASTE CHANNEL → **E**

Then, if necessary, edit the channel you copied to give it a unique name and other settings.

Note: The paste option appears only if you have previously copied a channel from a system of the same type you are currently editing.

Searching

Custom Search

Custom Search lets you program and search 10 custom search ranges. You can search any of these ranges simultaneously and select each custom search range you set. During custom search, the scanner searches starting with the lowest frequency in the search range you select to the highest frequency in the range.

Notes:

- Search ranges are preset. See “Editing a Custom Search Range” on Page 80 to change the range.
 - You cannot turn off all custom search ranges.
1. Press **[Menu]** then turn the scroll control until *SEARCH FOR ...* appears. Then press **E**. Or, press **[Func] + Src**, then select **No**. One of the search feature options appear.
 2. Turn the scroll control until *CUSTOM SEARCH* appears, then press **E** to select it. The scanner starts custom search of the custom search range you selected, stopping on any transmission it finds and displaying the frequency. Turn the scroll control to change the search direction. An arrow appears, showing the current search direction.

To turn search ranges on or off, press **0** and **1-9**.

To hold searching, press **Hold**. To resume searching, press **[Func]** then press **Scan/Srch** or **Hold** again.

To lock out a frequency found while searching, press **L/O**. *SEARCH LOCKOUT?* appears. Press **E** to lock out the frequency or **No** to continue monitoring.

If you turn off the active custom search range, the scanner skips to the next custom search range and continues searching.

Note: If all frequencies in all active custom search ranges are locked out, *ALL LOCKED!* appears and the scanner does not search.

Searching

Editing a Custom Search Range

You can edit up to 10 custom search ranges. The names of the custom search ranges appear on the display. The default custom search range names appear as *CUSTOM 1*, *CUSTOM 2*, and so on.

1. Press **Menu** then turn the scroll control until *SEARCH FOR ...* appears. Then press **E**. Or press **Func** and **Srch**, then **No**. One of the search feature options appear.
2. Turn the scroll control until *EDIT CUSTOM* appears, then press **E** to select it.
3. Turn the scroll control until the name of the custom search range you want to edit appears, then press **E** to select it. The following options appear as you turn the scroll control.

EDIT NAME - lets you edit the custom search range's name

EDIT SRCH LIMIT - lets you view and select the frequency ranges to search. The scanner prompts you to enter the upper and lower search limits.

SET DELAY TIME - lets you set the amount of time the scanner will delay before continuing to search after a transmission ends

SET MODULATION - lets you set the custom search range's modulation type

SET ATTENUATOR - lets you set whether the scanner will attenuate reception by 18dB during search

SET DATA SKIP - lets you set whether the scanner will skip data transmissions during search

SET STEP - lets you set the custom search range's step (the gap between frequencies)

4. Select the option you want to change for the custom search range you selected, then press **E**.

Searching

Service Search

Service Search lets you quickly select and search the scanner's preprogrammed search ranges. During service search, the scanner searches starting with the lowest frequency in the search range you select to the highest frequency in the range.

1. Press **Menu** then turn the scroll control until *SEARCH FOR . . .* appears. Then press **E**. Or press **Func** and **Srch**, then **No**. The search feature options appear.
2. Turn the scroll control until *SERVICE SEARCH* appears, then press **E** to select it.
3. Turn the scroll control until the type of service search you want appears, then press **E** to select it. The following search bands appear.

*PUBLIC SAFETY
NEWS
HAM RADIO
MARINE
RAILROAD
AIR
CB RADIO
FRS/GMRS
RACING
SPECIAL*

The scanner searches the service you selected, stopping on any transmission it finds and displaying the frequency. Turn the scroll control to change the search direction. An arrow appears, showing the current search direction.

To hold searching, press **Hold**. To resume searching, press **Func** then press **Scan/Srch** or **Hold**.

To lock out a frequency found while searching, press **L/O**. *SEARCH LOCKOUT?* appears. Press **E** to lock out the frequency or **No** to continue monitoring.

Searching

Notes:

- If all frequencies in the search band you selected are locked out, *ALL LOCKED!* appears and the scanner does not search the band.
- If the service you select uses channels (such as CB radio or marine), the scanner displays the service channel number.

Quick Search

Quick Search lets you search from the currently-tuned frequency if you are scanning a conventional system or sets the system to ID search if you are scanning a trunked system.

If you are on a conventional system or channel, press **Func** and **Scan/Srch** to start quick search. *QUICK SEARCH?* appears. Press **E** to start quick search or **No** to go to the search menu.

CTCSS/DCS Search

CTCSS/DCS Search lets you search for CTCSS or DCS tones when it finds an active frequency in search and Close Call modes. You can identify up to 50 CTCSS tones and 104 DCS codes.

Turning this option on lets the scanner search for CTCSS/DCS tones. If the scanner detects the tone, it displays the tone's frequency.

1. Press **Menu** then turn the scroll control until *SRCH/CLOO
CALL OPT* appears. Then press **E**. One of the search feature options appear.
2. Turn the scroll control until *CTCSS/DCS SEARCH* appears, then press **E** to select it.
3. Turn the scroll control until *ON* appears to turn on CTCSS/DCS search or until *OFF* appears to turn it off, then press **E**.

Searching

Using the Close Call Feature

Your scanner's Close Call™ feature lets you set the scanner so it detects, displays the frequency of, and lets you hear a nearby strong radio transmission. You can set the scanner so the Close Call feature works "in the background" while you are scanning other frequencies, turn off normal scanning while the Close Call feature is working, or turn off the Close Call feature and use the scanner normally. You can set the scanner so it alerts you when the Close Call feature finds a frequency. You can also set the frequency band where you want the scanner to look for transmissions.

To turn background Close Call detection on or off, press **[Func]** then **⌘**. When the feature is on, **⌘** appears on the display and normal operation is briefly interrupted about every 2 seconds.

Notes:

- The Close Call feature works well for locating the source of strong local transmissions such as mobile and handheld two-way radios in areas with no other strong transmission sources. Several factors affect Close Call performance, however. Performance is increased with higher transmit power, receive antenna tuned to the target band, and a low background RF level. Other than the antenna, you have no control over these factors, but they explain why performance might vary by both location and time.
- The Close Call feature cannot detect satellite dishes or any transmitter with a frequency above or below the frequency ranges listed under "Setting Close Call Options" on Page 84.
- The Close Call feature works better with some types of transmissions than others. It might not correctly display frequency information for transmitters using a highly directional antenna (such as an amateur radio beam antenna) or if there are many transmitters operating at the same time in the same area.

Using the Close Call Feature

Setting Close Call Options

1. Press **Menu** then turn scroll until *Close Call* appears. Then press **E**. Close Call feature options appear.
2. Turn scroll to select the option you want to change.
 - *CLOSE CALL ONLY*: Lets you set the scanner only for Close Call searching. The scanner does not scan frequencies or channels when this option is turned on. To select this option, press **E**.
 - *SET CC BANDS*: Lets you select the Close Call band settings. You can turn the following bands on or off.
 - VHF LOW* (25.0000 - 54.0000 MHz)
 - AIR BAND* (108.0000 - 136.9750 MHz)
 - VHF HIGH* (137.0000 - 224.9950 MHz)
 - UHF* (400.0000 - 512.0000 MHz)
 - 800MHz+* (806.0000 -956.0000 MHz)Use the scroll control to select a band, press **E**, then use the scroll control to select *ON* or *OFF* and press **E**. Turning off undesired bands speeds up Close Call operation. (The Close Call feature does not work for frequencies greater than 956 MHz.)
 - *SET CC ALERT*: Lets you select how the scanner alerts you when it receives a Close Call signal. You can select any of the following options.
 - Beep+Light* (the scanner beeps and the backlight turns on when it receives a Close Call signal)
 - Light* (the backlight turns on when it receives a Close Call signal)
 - Beep* (the scanner beeps when it receives a Close Call signal)
 - None* (the scanner does not alert)Turn scroll to display an option, then press **E**.
 - *SET CC OVERRIDE*: Lets you select how the Close Call feature works with other scanning activities. If you turn this option off, when the scanner detects a Close Call signal, *CC FOUND* and *E TO LISTEN*

Using the Close Call Feature

appear for about 3 seconds. Press **E** when this appears to jump to and hold on the frequency.

If this option is turned on, the scanner overrides the current channel and goes to the Close Call hit. The scanner displays *CC FOUND! PRESS ANY KEY*. When you press a key, the frequency is displayed.

Turn scroll to display an option, then press **E**.

- *SET CC MODE*: Lets you select the Close Call mode. If you turn this option on, the scanner sets itself to its Close Call settings about once every 2 seconds.

Turn scroll to display an option, then press **E**.

You can also toggle this setting by pressing **[Func]** then **↵**.

- *CC AUTOSTORE*: Lets you select whether the scanner automatically stores Close Call hits into channels. If you turn this option on, the scanner starts Close Call mode and stores any Close Call hits, up to the maximum you specified in the Max Auto Store setting. If the scanner stores more hits this setting, it stops Autostore operation.

Turn scroll to display an option, then press **E**.

Close Call Hits

When the scanner detects a Close Call hit, it alerts you according to the Override and Alert settings in the previous section. While listening to a Close Call hit, you can press **Hold** to hold on the hit frequency, press **E** to quickly save the frequency into memory, press **L/O** to lockout the frequency from Close Call and Search operation, or wait for the transmission to end.

If you are in Close Call Only or Close Call Override mode, and you do not press any key, the scanner returns to its previous operation after the transmission ends and the set delay time expires.

If you are holding on the frequency, press **Hold** again to resume the previous operation.

Using the Close Call Feature

Search and Close Call Options

The settings in this section affect custom searches, service searches, and Close Call operation.

Managing Locked-Out Frequencies

While searching or during Close Call operation, if you press **L/O** while the scanner is stopped on a frequency, this frequency is lockout out of these modes. You can lockout up to 200 frequencies.

Note: Locking out a frequency does not lock out a channel that contains that frequency.

Unlocking All Frequencies

Menu → **↻** *SRCH/CLOCALL OPT* → **E** **↻**
FREQ LOCKOUTS → **E** → *UNLOCK ALL* → **E**

The scanner prompts you to confirm deletion. To confirm and delete all locked-out frequencies, press **E**. Otherwise, to cancel, press **No**.

Reviewing Locked Out Frequencies

Menu → **↻** *SRCH/CLOCALL OPT* → **E** **↻**
FREQ LOCKOUTS → **E** → *RVW SEARCH L/O* → **E**

The scanner displays the first locked-out frequency and prompts you to unlock the frequency. Press **E** to unlock the frequency. Or, rotate scroll or press **No** to select a different frequency. To exit the review, press **Menu**.

Searching for Subaudible Tones

MENU → **↻** *SRCH/CLOCALL OPT* → **E** **↻**
CTCSS/DCS SEARCH → **E**

This setting controls whether the scanner will search for a subaudible tone when it stops on a transmission during search or Close Call operation.

OFF The scanner does not search for subaudible tones.

Search and Close Call Options

ON The scanner searches for and displays any subaudible tone found.

Note: This feature does not operate when the scanner is in AM modulation mode.

Screening Out Paging Systems

Menu → ↻ *SRCH/CLOCALL OPT* → **E** ↻
PAGER SCREEN → **E**

This setting determines whether the scanner automatically ignores transmissions found during searching or Close Call operation that are on common paging system frequencies.

ON The scanner skips known paging system frequencies.

OFF The scanner stops on any detected transmission, including paging systems.

Notes:

- The default setting for this feature is *ON*.
- The frequencies include paging systems and also the NOAA weather frequencies.
- Even with the feature on, you might hear some paging systems. Some frequencies are shared between business radio systems and paging systems. If the scanner stops on a paging system even with this feature turned on, manually lock it out by pressing **L/O**.

Finding Repeater Output Frequencies

Menu → ↻ *SRCH/CLOCALL OPT* → **E** ↻
REPEATER FIND → **E**

This feature sets whether the scanner tries to tune to a repeater output frequency when it detects a transmission on a repeater input frequency. Since you can normally only hear one side of a conversation when you listen to an input frequency transmission, turning this feature on can let you hear both sides of the conversation.

Search and Close Call Options

ON The scanner automatically applies repeater reverse to detected transmissions. If the scanner detects the transmission on the output frequency, it beeps and displays **Repeater Found** and remains on the output frequency until transmissions end. If it does not detect a transmission on the output frequency, it remains on the original frequency.

OFF The scanner does not try to find the output frequency.

Setting the Maximum Auto Store Value

Menu → **↶** *SRCH/CLOCALL OPT* → **E** **↶**
MAX AUTO STORE → **E**

This value sets how many hits the scanner will automatically store when it is in either Search and Store or Close Call Auto Store mode.

Use the number keys to enter a value from 1 - 256, then press **E**.

When the scanner reaches the maximum number of hits you set, it stops the auto-store operation.

Setting the Modulation Type

Menu → **↶** *SRCH/CLOCALL OPT* → **E** **↶**
SET MODULATION → **E**

This setting controls the modulation type used for quick search and Close Call operations. Select your setting, then press **E**.

AUTO Uses the default setting for the current frequency (see the table at the front of the manual)

AM Uses AM (amplitude modulation)

FM Uses FM (frequency modulation)

NFM Uses narrowband FM

Search and Close Call Options

Setting Attenuation

Menu → ↻ *SRCH/CLOCALL OPT* → **E** ↻
SET ATTENUATION → **E**

This setting controls the attenuator for quick search and Close Call operation. Select your setting, then press **E**.

OFF The attenuator is off.

ON Reception is attenuated by about 18 dB.

Note: Turn on this setting if you are near other strong signal sources. Attenuation sometimes helps to reduce interference and desensitization that strong signals create.

Setting Data Skip

Menu → ↻ *SRCH/CLOCALL OPT* → **E** ↻
SET DATA SKIP → **E**

This setting controls how the scanner behaves when it detects a constant-level transmission during quick search or Close Call operation. Select your setting, then press **E**.

OFF The scanner remains on the transmission until it ends.

ON The scanner quickly resumes searching or Close Call operation.

Notes:

- If you are trying to test the Close Call feature with a nearby transmitter and you do not talk into the transmitter, the scanner will detect this as data and will skip the frequency when Data Skip is on. Turn the feature off or talk into the transmitter.
- The default for this feature is *ON*.

Search and Close Call Options

Setting the Delay Time

Menu → ↻ *SRCH/CLOCALL OPT* → **E** ↻
SET DELAY TIME → **E**

This setting determines how long the scanner waits after a transmission ends before resuming quick search or Close Call operation. Select your setting, then press **E**.

OFF The scanner resumes immediately when the transmission ends.

105 SEC The scanner waits the set amount of time after the transmission ends before resuming.

Note: The default setting is 2 seconds.

Setting the Search Frequency Step

Menu → ↻ *SRCH/CLOCALL OPT* → **E** ↻
SET STEP → **E**

This setting selects the frequency step used for setting the channels. Select your setting, then press **E**.

AUTO The step is based on the band (see the table at the front of the manual)

5.0 KHZ, 6.25 KHZ, 7.5 KHZ, 10.0 KHZ, 12.5 KHZ, 15.0 KHZ, 25.0 KHZ, 50.0 KHZ, 100.0 KHZ The scanner uses the selected step.

Note: The scanner defaults to *AUTO*.

Search and Close Call Options

Using Weather Alert (SAME)

Your scanner has been primarily designed to be a radio scanner. While it incorporates weather alert as one of its features, we strongly recommend that you not use the scanner as your sole means for receiving emergency alerts. Your local electronics retailer carries several weather radios specifically designed for this function.

Your scanner allows you to search for a local NOAA weather broadcast and set it to alert when a SAME weather alert is broadcast on a NOAA channel. You can also program SAME codes into the scanner and set a weather channel as a priority channel.

In the following sections, you can also access the weather menu from Hold mode by pressing **[Func]** then **Wx**.

Searching For a Weather Broadcast

[Menu] →  *WX OPERATION* → **E** →
WEATHER SCAN → **E**

The scanner starts scanning the preprogrammed weather frequencies, and stops on the first signal. If this station is weak, rotate scroll to check for other weather broadcasts in your area.

Note: NOAA broadcasts are continuous broadcasts. You will only lose reception if you move out of a coverage area. If the signal is lost, the scanner resumes searching for a weather transmission.

Turning Weather Alert On/Off

In weather alert mode, your scanner functions as a severe weather warning radio. This is especially useful when your area is expecting severe weather conditions late at night. When you set the scanner to weather alert mode, it holds on the weather channel, but does not play the channel's audio. If it detects a weather alert, it sounds a tone, displays information about the weather alert, and turns on the audio so you can hear the weather broadcast.

Using Weather Alert (SAME)

Menu → ↻ *LWX OPERATION* → **E** ↻
WEATHER ALERT → ↻

This setting determines which types of signals will trigger an alert. Select your setting, then press **E**.

ALERT ONLY - the scanner alerts when it detects the 1050 Hz tone that accompanies all weather alerts.

ALL FIPS - the scanner alerts and displays information about the weather alert when it receives any FIPS code (see "Programming a SAME Group" on Page 92).

SAME 1-5 - the scanner alerts and displays information about the weather alert when it receives a weather alert signal that includes any FIPS code you have programmed into the specified SAME group.

Programming a SAME Group

You can edit any of the 5 SAME groups in your scanner. Each group can have up to 8 FIPS codes.

SAME (Specific Area Messaging System) is a system developed by the National Weather Service to reduce the number of alerts received by consumers by allowing them to hear alerts only for the county(ies) they are interested in. Each alert contains information about the type and severity of the alert, as well as the specific geographic locations affected by the alert.

The geographic locations are designated using FIPS codes. Each county or parish in the US and its territories are assigned a FIPS code. In addition, certain special regions and wildcard settings can be assigned.

FIPS codes are in the format nSSCCC:

n: A special subcounty designator. For an entire county, use 0.

SS: The state code.

CCC: The county code.

Using Weather Alert (SAME)

For example, Tarrant County in Texas is assigned to FIPS code 048439.

0 indicates the entire county

48 indicates the state of Texas

439 indicates Tarrant County

To get the FIPS code for your county, visit the National Weather Service web site at <http://www.nws.noaa.gov> and search for "FIPS Listing".

Menu → ↻ *WX OPERATION* → **E** ↻
PROGRAM SAME → **E** ↻ *SELECT SAME* →
↻ select the SAME group to edit → **E**

EDIT NAME - enter the name you want to assign to the SAME group you selected.

EDIT COUNTY - select the position you want to store the FIPS code into, then press **E**, enter the FIPS code, and press **E** again.

Setting WX Alert Priority

Menu → ↻ *WX OPERATION* → **E** ↻
WX ALT PRIORITY **E**

Then, select your desired option.

ON - the scanner checks the weather channels every 5 seconds for a 1050 Hz weather alert signal.

OFF - the scanner does not check the weather channels.

Using Weather Alert (SAME)

Care and Maintenance

General Use

- Turn the scanner off before disconnecting the power.
- Always write down the programmed frequencies in the event of memory loss.
- If memory is lost, simply reprogram each channel.
- Always press each button firmly until you hear the entry tone for that key entry.

Location

- Do not use the scanner in high-moisture environments such as the kitchen or bathroom.
- Avoid placing the unit in direct sunlight or near heating elements or vents.
- If the scanner receives strong interference or electrical noise, move it or its antenna away from the source of the noise. If possible, a higher elevation might provide better reception.
- Also try changing the height or angle of the antenna.

Cleaning

- Disconnect the power to the unit before cleaning.
- Clean the outside of the scanner with a mild detergent.
- To prevent scratches, do not use abrasive cleaners or solvents. Be careful not to rub the LCD window.
- Do not use excessive amounts of water.

Repairs

Do not attempt any repair. The scanner contains no user serviceable parts. Contact the Uniden Customer Service Center or take it to a qualified repair technician.

Birdies

All radios can receive “birdies” (undesired signals). If your scanner stops during Scan mode and no sound is heard, it might be receiving a birdie. Birdies are internally generated signals inherent in the electronics of the receiver.

Press **L/O** to lock out the channel.

If your BC246T is not performing properly, try the following steps.

Problem	Possible Cause	Suggestion
The scanner doesn't work.	The scanner might not be receiving any power.	Make sure the AC adapter is connected to an AC outlet and the scanner.
		If there is a wall switch that controls power to the AC outlet where you connected the AC adapter, make sure it is on.
Improper reception.	The scanner's antenna might need to be adjusted.	Check the antenna connection or move or reposition the antenna.
		Move the scanner.
		You might be in a remote area that could require an optional multi-band antenna. Check with your dealer or local electronics store.
Scan won't stop.	The squelch might need to be adjusted.	Adjust the squelch threshold. See "Turning On the Scanner and Setting the Squelch" on Page 40.

Troubleshooting

Troubleshooting

Scan won't stop (continued)	The antenna might need to be adjusted.	Check the antenna connection.
	One or more channels might be locked out.	Make sure the channels you want to scan are not locked out.
	The channel's frequency might not be stored in memory.	Make sure the channel's frequency is stored in the scanner's memory.
	The channel might not be active.	Wait for a transmission on the channel.
Scan won't start.	You must press Scan to scan.	Press Scan .
	The squelch might need to be adjusted.	Adjust the squelch threshold. See "Turning On the Scanner and Setting the Squelch" on Page 40.
	One or more channels might be locked out.	Make sure the channels you want to scan are not locked out.
	The antenna might need to be adjusted.	Check the antenna connection.

Troubleshooting

Weather scan doesn't work.	The squelch might need to be adjusted.	Adjust the squelch threshold. See "Turning On the Scanner and Setting the Squelch" on Page 40.
	The antenna might need to be adjusted.	Check the antenna connection.

If you experience difficulty while in TrunkTracker™ mode, try the following steps.

Problem	Possible Cause	Suggestion
Scanner won't track a trunked system.	The system might not be one your scanner can scan.	Scan another system.
	The data frequency might be missing.	Enter the data frequency.
	The scanner might need to be changed to a Type 1 scanner setup.	Change to a Type 1 scanner setup. Review "Motorola Trunking" on Page 23.

Troubleshooting

	The system you are trying to scan might be LTR or EDACS.	Set the scanner to scan LTR or EDACS systems. Review "LTR Trunking" on Page 25 and "EDACS Trunking" on Page 24.
Scanner won't stop scanning a trunked system.	No ID's have been programmed.	Program one or more ID's or use the ID Search mode.
	The ID's you have stored are not active.	Wait for the ID's to become active or scan another system.
Scanner won't acquire the data channel.	The squelch might need to be adjusted.	Adjust the squelch threshold. See "Turning On the Scanner and Setting the Squelch" on Page 40.
	The frequency used for the data channel might be missing.	Check your frequency list for the data channel.
Missing replies to conversations .	The scanner might need to be changed to a Type 1 scanner setup.	Change to a Type 1 scanner setup.

Troubleshooting

.	The fleet map might be incorrect.	Try another preset fleet map or program your own fleet map.
	One or more of the system's frequencies might not be entered.	Make sure all the system's frequencies have been entered.
Missing replies to conversations . (continued)	The system you are trying to scan might be LTR or EDACS.	Set the scanner to scan LTR or EDACS systems. Review "LTR Trunking" on Page 25 and "EDACS Trunking" on Page 24.

If you still cannot get satisfactory results while using your scanner or if you want additional information, please call or write the Uniden Parts and Service Division. The address and phone number are listed in the Warranty at the end of this manual. If you would like immediate assistance, please call Customer Service at (800) 297-1023.

If you have Internet access, you can visit <http://www.uniden.com> for additional information.

Troubleshooting

Specifications

Certified in accordance with FCC Rules and Regulations Part 15, Subpart C, as of date of manufacture.

Dynamic Allocation Capacity:

- With Name Assigned To Each System, Group, and Channel:

Basic :

10 Systems, 100 Groups, 1500 Channels

Minimum:

200 Systems, 500 Groups, 500 Channels

- With No Name Assigned:

Basic:

10 Systems, 100 Groups, 2500 Channels

Minimum:

200 Systems, 1000 Groups, 1000 Channels

Systems: 200

Groups 20 per system

Channels up to 2500

Channels per Trunked System up to 200

Attenuation: 18 dB (nominal), 10 dB (limit)

Frequency Range (MHz):

25.0-26.960

Citizens Band/Business Band

26.965-27.405

Citizens Band Class D

27.410-27.995

Business Band

137.0-143.995

Military Band

144.0-147.995

2 Meter Amateur Band

148.0-161.995

Specifications

VHF High Band

216.0–224.995

1.25 Meter Amateur Band

Above bands in 5 kHz steps

28.0-29.690

10 Meter Amateur Band

29.7–49.990

VHF Low Band

50–54

6 Meter Amateur Band

Above bands in 10 kHz steps

162.0–174.0

Federal Government

400.0-405.9875

Unknown

406.0–419.9875

Federal Land Mobile

420.0–449.9875

70 cm Amateur Band

450.0–469.9875

UHF Standard Band

470.0-512.0

UHF TV Band

806.0–823.9875

Public Service “800” Band

849.0125–868.9875

Public Service “800” Band

894.0125–956.0

Public Service “800” Band

Specifications

1240.0–1300.0

25 cm Amateur Band

Above bands in 12.5 kHz steps

108.0–136.9750

Aircraft Band

Above band in 25 kHz steps

Operating Temperature: –20°C to +60°C

Scan Rate: 100 channels per second

(conventional mode)

Search Rate: 300 steps per second

(5 kHz step only)

Scan Delay: 0-5 seconds

Audio Output: 2W nominal into

8 ohm internal speaker

Power Requirements: 12 VDC 500mAh

(AD140U AC adapter)

Antenna: 50 ohms (Impedance)

External Jacks: Antenna Jack BNC Type

Ext. Speaker Jack 3.5mm

Line Out Jack 3.5mm

DC Power Jack 5.5mm

Remote Jack D-sub9 Pins

Size: 10¹/₂ in. (W) x 7³/₈ in. (D) x 3¹/₂ in. (H)

Weight: 3.8 lbs

Features, specifications, and availability of optional accessories are all subject to change without notice.

Specifications

Optional Accessories

Contact your local Uniden Dealer or call the Uniden Parts Center at: (800)554-3988, 8:00AM to 5:00PM 246TEST, Monday through Friday, for information about ordering these optional accessories.

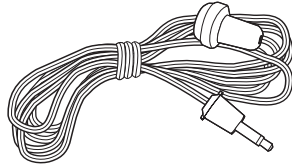

Earphone

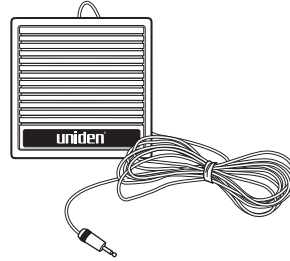

External Amplified Speaker



Betty Bearcat Frequency Directory/
Local Directories

PC Software (BC246T SS)
Available by download.

Optional Accessories

Appendix

Preset Fleet Maps

Preset Map 1

Block	Size Code
0	Size Code 11
1	Size Code 11
2	Size Code 11
3	Size Code 11
4	Size Code 11
5	Size Code 11
6	Size Code 11
7	Size Code 11

Preset Map 2

Block	Size Code
0	Size Code 4
1	Size Code 4
2	Size Code 4
3	Size Code 4
4	Size Code 4
5	Size Code 4
6	Size Code 4
7	Size Code 4

Preset Map 3

Block	Size Code
0	Size Code 4
1	Size Code 4
2	Size Code 4
3	Size Code 4
4	Size Code 4
5	Size Code 4
6	Size Code 12
7	(Size Code 12)

Preset Map 4

Block	Size Code
0	Size Code 12
1	(Size Code 12)
2	Size Code 4
3	Size Code 4
4	Size Code 4
5	Size Code 4
6	Size Code 4
7	Size Code 4

Preset Map 5

Block	Size Code
0	Size Code 4
1	Size Code 4
2	Size Code 12
3	(Size Code 12)
4	Size Code 4
5	Size Code 4
6	Size Code 4
7	Size Code 4

Preset Map 6

Block	Size Code
0	Size Code 3
1	Size Code 10
2	Size Code 4
3	Size Code 4
4	Size Code 12
5	(Size Code 12)
6	Size Code 12
7	(Size Code 12)

Preset Map 7

Block	Size Code
0	Size Code 10
1	Size Code 10
2	Size Code 11
3	Size Code 4
4	Size Code 4
5	Size Code 4
6	Size Code 4
7	Size Code 4

Preset Map 8

Block	Size Code
0	Size Code 1
1	Size Code 1
2	Size Code 2
3	Size Code 2
4	Size Code 3
5	Size Code 3
6	Size Code 4
7	Size Code 4

Preset Map 9

Block	Size Code
0	Size Code 4
1	Size Code 4
2	Size Code 0
3	Size Code 0
4	Size Code 0
5	Size Code 0
6	Size Code 0
7	Size Code 0

Preset Map 10

Block	Size Code
0	Size Code 0
1	Size Code 0
2	Size Code 0
3	Size Code 0
4	Size Code 0
5	Size Code 0
6	Size Code 4
7	Size Code 4

Preset Map 11

Block	Size Code
0	Size Code 4
1	Size Code 0
2	Size Code 0
3	Size Code 0
4	Size Code 0
5	Size Code 0
6	Size Code 0
7	Size Code 0

Preset Map 12

Block	Size Code
0	Size Code 0
1	Size Code 0
2	Size Code 0
3	Size Code 0
4	Size Code 0
5	Size Code 0
6	Size Code 0
7	Size Code 4

Preset Map 13

Block	Size Code
0	Size Code 3
1	Size Code 3
2	Size Code 11
3	Size Code 4
4	Size Code 4
5	Size Code 0
6	Size Code 0
7	Size Code 0

Preset Map 14

Block	Size Code
0	Size Code 4
1	Size Code 3
2	Size Code 10
3	Size Code 4
4	Size Code 4
5	Size Code 4
6	Size Code 12
7	(Size Code 12)

Preset Map 15

Block	Size Code
0	Size Code 4
1	Size Code 4
2	Size Code 4
3	Size Code 11
4	Size Code 11
5	Size Code 0
6	Size Code 12
7	(Size Code 12)

Preset Map 16

Block	Size Code
0	Size Code 3
1	Size Code 10
2	Size Code 10
3	Size Code 11
4	Size Code 0
5	Size Code 0
6	Size Code 12
7	(Size Code 12)

Appendix

User Defined Fleet Maps

Type I Programming Information

When a Type I system is designed, the address information for all the ID's is divided into 8 equal sized blocks, numbered 0–7. When you program your scanner to track a Type I system, you must select a size code for each of these blocks. When you have assigned a size code to all 8 blocks, you'll have defined the fleet map for the system you are tracking. Each size code determines the number of fleets, subfleets, and ID's each block will have. For example, a size code of S-4 has one fleet, which is divided into 16 separate subfleets, and it has a total of 512 individual ID's.

When a block is assigned a size code, the fleet or fleets created within the block are assigned a Type I ID. The way these ID's display on your scanner depend on the block number and the block's size code. When a Type I ID appears, the leftmost digit represents the block which contains the ID.

The next three digits identify which fleet is active, and the last digit(s) identifies the subfleet.

The details concerning how the size codes are selected by a Type I System designer are highly dependent on the specific needs of the system's users. Some organizations might want many subfleets with only a few radios each, while another organization might want only a few subfleets with many radios each. Your task is to program your fleet map with the same size code assignments as the trunked system. If you do this accurately, you'll track all the Fleet-Subfleet combinations used by the system. In other words, you'll hear complete communications while monitoring a trunked system.

If you don't already know the size codes used, you'll have to guess at them. But since you don't have to figure out all the blocks at once, this isn't as hard as it seems. Select a size code for a block, and then press **Scan**. Now listen to the communications. If you decide you are receiving most

Appendix

of the replies to the conversations with ID's assigned to the block you just programmed, then you've probably selected the right size code and can work on the next block of the map.

Finally, for most public safety systems there are some size codes which are more common. S-3 and S-4 are probably the most common, followed by S-10, S-11, and S-12.

Size Code Restrictions

If you select size code S-12, S-13, or S-14, there are some restrictions as to which blocks can be used for these codes.

S-12 can only be assigned to Blocks 0, 2, 4, or 6.

S-13 can only be assigned to Blocks 0 and 4.

S-14 can only be assigned to Block 0.

Since these size codes require multiple blocks, you will be prompted for the next available block when programming a fleet map. For example, if you assign Block 0 as an S-12, you will be prompted for b2, the next block available, instead of b1. And if you assign Block 0 as an S-14, you would not see another prompt because it uses all available blocks.

Collecting Information

Getting your scanner programmed and scanning takes a few steps. This help guides you through these steps that will make it easier for you to start scanning.

1. Collect information about the system(s) you want to monitor.

Do you want to listen to your local police and fire departments? How about the highway patrol, ambulance service, and aircraft? You might even want to listen to your local utility company as they track down a break in electrical service in your area.

Make a list of the agencies you want to listen to, then look up the frequencies and systems used by those agencies. The Internet is a great source for current frequencies and information about scanning. Here are a few useful sites:

- <http://www.scannermaster.com/> - frequency resources and home of Police Call.
You can also call them at 1 800 SCANNER (hours are from 10:00 a.m. to 5:00 p.m. Eastern Time Monday through Friday.)
- <http://www.radioreference.com/> - the Internet's premier source for user-supported radio system information.
- <http://www.bearcat1.com/> - frequency information from National Communications.
- <http://svartifoss2.fcc.gov/reports/index.cfm> - conventional frequency information on file with the US Government

Tips:

- Scanners are designed to monitor complex radio systems. That means that programming your scanner might seem like a daunting task at first. Be patient if you don't get it right the first time. You can also seek

Appendix

Planning

out help locally for the systems you want to scan by visiting the forums section of <http://www.radioreference.com/forums>.

- Before you start to program your scanner, decide how you want to organize the frequencies you want to scan. For example, some areas are best organized by geographic location (east, north, south, west, central, etc), while others are best organized by agency (police, sheriff, ambulance, fire, etc.). You might even find it easier to organize a mixture of frequencies (north, southeast, and west for police but fire all in one group for example).
2. Organize the system information using these system worksheets included in this help.
 - Use "" on Page 115 to organize information about conventional frequencies.
 - Use "" on Page 115 to organize information about Motorola frequencies.
 - Use "" on Page 115 to organize information about LTR frequencies.
 - Use "" on Page 115 to organize information about EDACS frequencies.
 3. Follow the instructions in "Filling Out The Conventional Scanning Worksheet" on Page 111, "Filling Out The Motorola Worksheet" on Page 112, "Filling Out the LTR and EDACS Worksheet" on Page 114, and "Filling Out the LTR and EDACS Worksheet" on Page 114 to program your scanner.

Tips:

- Before you start, make as many copies of the worksheets as you think you'll need. You can also go to the download section of <http://www.uniden.com/productsupport.cfm> and download the worksheets there.

Appendix

-
-
- All worksheet instructions assume that you have completed the critical Step 1 (collecting the system information). Don't skip this step.
 - Use a pencil to fill out the worksheets. This lets you change information if necessary.

Filling Out The Conventional Scanning Worksheet

System Name and Quick Key

Fill in a name that describes the system you want to create. For example, you can enter "Dallas Police" or "Amateur Radio" here. If you want to store more than one type of frequency, you can enter "Mixed."

Fill in the key you want to press to quickly activate/deactivate the system. You can assign the same quick key to multiple systems.

Group Name and Quick Key

Each worksheet documents the settings for one channel group within a system. If you have fewer channels in the group than fits on the page, you can skip a line and enter an additional group of channels (enter the group information in the line you skipped). If you have more channels for the group than will fit on the page, use additional pages.

Fill in the key you want to press with **FUNC** to quickly activate/deactivate the channel group. You can assign the same quick key to multiple groups within a system.

Frequency-Alpha Tag-Priority-CTCSS/DCS

Fill in the details for each channel you want to store in this channel group.

Appendix

Filling Out The Motorola Worksheet

System Name and Quick Key

Fill in a name that describes the system you want to create. For example, you can enter "Dallas Police" or "Amateur Radio" here. If you want to store more than one type of frequency, you can enter "Mixed."

Fill in the key you want to press to quickly activate/deactivate the system. You can assign the same quick key to multiple systems.

System Type

Circle in the type of Motorola system you are scanning.

- Type 1. A fleet map is supplied for this type of system.
- Type 2 800 MHz Standard. Used for most 800 MHz systems. No fleet map is supplied for this type of system.
- Type 2 800 MHz Splinter. Used for some 800 MHz systems near border areas.
- Type 2 900 MHz. The supplied frequencies are between 935.0125 MHz and 939.9875 MHz. No fleet map is supplied for this type of system.
- Type 2 UHF. The supplied frequencies are between 406 MHz and 512 MHz. No fleet map is supplied for this type of system.
- Type 2 VHF. The supplied frequencies are between 136 MHz and 174 MHz. No fleet map is supplied for this type of system.

System Frequencies

Enter the frequencies used by the system. Motorola systems can use up to 30 frequencies. Place an asterisk or other mark next to frequencies identified as data channels.

Appendix

Fleet Map (Type I or Type I/Type II Hybrid Only)

Fill in the fleet map used by this agency.

Band Plan (VHF or UHF Only)

A band plan is required so the scanner can correctly determine the voice channel frequency. Fill in the band plan used by this agency, consisting of:

- Base frequency
- Step frequency
- Channel offset

You can enter up to three band plans.

Group Name and Quick Key

Each “Motorola System Worksheet 2” documents the settings for one channel group within a system. If you have fewer channels in the group than fits on the page, you can skip a line and enter an additional group of channels (enter the group information in the line you skipped). If you have more channels for the group than will fit on the page, use additional pages.

Fill in the key you want to press with **FUNC** to quickly activate/deactivate the channel group. You can assign the same quick key to multiple groups within a system.

Talk Group ID-Alpha Tag-Priority

Fill in the details for each channel you want to store in this channel group.

Filling Out the LTR and EDACS Worksheet

System Name and Quick Key

Fill in a name that describes the system you want to create. For example, you can enter "Dallas Police" or "Amateur Radio" here. If you want to store more than one type of frequency, you can enter "Mixed."

Fill in the key you want to press to quickly activate/deactivate the system. You can assign the same quick key to multiple systems.

System Frequencies and LCN

Fill in each system frequency and its associated Logical Channel Number (LCN).

Group Name and Quick Key

Each "LTR/EDACS System Worksheet 2" documents the settings for one channel group within a system. If you have fewer channels in the group than fits on the page, you can skip a line and enter an additional group of channels (enter the group information in the line you skipped). If you have more channels for the group than will fit on the page, use additional pages.

Fill in the key you want to press with **FUNC** to quickly activate/deactivate the channel group. You can assign the same quick key to multiple groups within a system.

Talk Group ID-Alpha Tag-Priority

Fill in the details for each channel you want to store in this channel group.

Appendix

Motorola System Worksheet 1			
System Name			
System Quick Key			
System Frequencies	Type I		
	Type II 800 MHz:		
	Standard		
	Splinter		
	Type II UHF		
	Type II VHF		
	Fleet Map		
	Block 0		
	Block 1		
	Block 2		
	Block 3		
	Block 4		
	Block 5		
	Block 6		
	Block 7		
	Band Plan A		
	Base Frequency		
	Step Frequency		
	Offset		
	Band Plan B		
	Base Frequency		
	Step Frequency		
	Offset		
	Band Plan C		
	Base Frequency		
	Step Frequency		
	Offset		

Appendix

- Data used for the preprogrammed information was supplied courtesy of <http://www.radioreference.com>, the Internet's premier scanning resource (RadioReference is not affiliated with Uniden America Corporation).

State	County	City	System
Arizona			
Arizona	Maricopa	Avondale	Maricopa Conv
Arizona	Maricopa	Capitol	Maricopa Conv
Arizona	Maricopa	Chandler	Chandler MOT
Arizona	Maricopa	Chandler	Maricopa Conv
Arizona	Maricopa	El Mirage	Maricopa Conv
Arizona	Maricopa	Fort McDowell	
Arizona	Maricopa	Indian Community	Maricopa Conv
Arizona	Maricopa	Goodyear	Maricopa Conv
Arizona	Maricopa	Salt River Indian	
Arizona	Maricopa	Community	Maricopa Conv
Arizona	Maricopa	Scotsdale	Maricopa Conv
Arizona	Maricopa	Tempe	Tempe MOT
Arizona	Maricopa	Tolleson	Maricopa Conv
Arizona	Maricopa	Tonopah	Maricopa Conv
Arizona	Maricopa	Wickenburg	Maricopa Conv
California			
California	Alameda	Alameda	Alameda MOT
California	Alameda	Albany	Alameda Conv
California	Alameda	East Bay Park	Alameda Conv
California	Alameda	Fremont	Alameda MOT
California	Alameda	Hayward	Alameda MOT
California	Alameda	Newark	Alameda MOT
California	Alameda	Oakland	Oakland EDACS
California	Alameda	Piedmont	Oakland EDACS
California	Alameda	San Leandro	Alameda MOT
California	Alameda	Union City	Alameda MOT
California	Los Angeles	Alhambra	Los Angeles Conv
California	Los Angeles	Altaden Crest Valley	Los Angeles Conv
California	Los Angeles	Arcadia	Los Angeles Conv
California	Los Angeles	Avalon	Los Angeles Conv
California	Los Angeles	Baldwin Park	Los Angeles Conv
California	Los Angeles	Bell	Los Angeles Conv
California	Los Angeles	Bell Gardens	Los Angeles Conv
California	Los Angeles	Beverly Hills	Los Angeles Conv
California	Los Angeles	Burbank	Los Angeles Conv
State	County	City	System
California	Los Angeles	Carson	Los Angeles Conv
California	Los Angeles	Century	Los Angeles Conv
California	Los Angeles	Claremont	Los Angeles Conv
California	Los Angeles	College/Transit	Los Angeles Conv
California	Los Angeles	Compton	Los Angeles Conv

Preprogrammed Systems

California	Los Angeles	Covina	Los Angeles Conv
California	Los Angeles	Crescenta	Los Angeles Conv
California	Los Angeles	Culver City	Culver City MOT
California	Los Angeles	Downey	Los Angeles Conv
California	Los Angeles	El Segundo	Los Angeles Conv
California	Los Angeles	Gardena	Los Angeles Conv
California	Los Angeles	Glendora	Los Angeles Conv
California	Los Angeles	Hawthorn	Los Angeles Conv
California	Los Angeles	Hermosa Beach	Los Angeles Conv
California	Los Angeles	Huntington Park	Los Angeles Conv
California	Los Angeles	Industry	Los Angeles Conv
California	Los Angeles	Inglewood	Los Angeles Conv
California	Los Angeles	Irwindale	Los Angeles Conv
California	Los Angeles	LA County	Los Angeles Conv
California	Los Angeles	La Habra Heights	Los Angeles Conv
California	Los Angeles	La Verne	Los Angeles Conv
California	Los Angeles	Lakewood	Los Angeles Conv
California	Los Angeles	Lancaster	Los Angeles Conv
California	Los Angeles	Lennox	Los Angeles Conv
California	Los Angeles	Lomita	Los Angeles Conv
California	Los Angeles	Long Beach	Los Angeles Conv
California	Los Angeles	Lost Hills	Los Angeles Conv
California	Los Angeles	Manhattan Beach	Los Angeles Conv
California	Los Angeles	Marina Del Rey	Los Angeles Conv
California	Los Angeles	Maywood	Los Angeles Conv
California	Los Angeles	Monrovia	Los Angeles Conv
California	Los Angeles	Montebello	Los Angeles Conv
California	Los Angeles	Monterey Park	Los Angeles Conv
California	Los Angeles	Norwalk	Los Angeles Conv
California	Los Angeles	Pasadena	Los Angeles Conv
California	Los Angeles	Pico Rivera	Los Angeles Conv
California	Los Angeles	Pomona	Los Angeles Conv
California	Los Angeles	Redondo Beach	Los Angeles Conv
California	Los Angeles	San Dimas	Los Angeles Conv
California	Los Angeles	San Fernando	Los Angeles Conv
California	Los Angeles	Santa Clarita Valley	Los Angeles Conv
California	Los Angeles	Santa Monica	Los Angeles Conv
California	Los Angeles	Signal Hill	Signal Hill MOT
California	Los Angeles	South Bay	Los Angeles Conv
California	Los Angeles	Temple City	Los Angeles Conv
California	Los Angeles	Verdugo	Los Angeles Conv
California	Los Angeles	Walnut	Los Angeles Conv
California	Los Angeles	West Covina	Los Angeles Conv
California	Los Angeles	West Hollywood	Los Angeles Conv
California	Los Angeles	Whittier	Los Angeles Conv
California	Orange	Brea	Orange MOT
State	County	City	System
California	Orange	Costa Mesa	Orange MOT
California	Orange	La Habra	Orange MOT
California	Orange	Laguna Beach	Orange MOT
California	Orange	Orange County	Orange MOT

Preprogrammed Systems

California	Orange	Santa Ana	Orange MOT
California	Riverside	Banning	Riverside Conv
California	Riverside	Beaumont	Riverside Conv
California	Riverside	Blythe	Riverside Conv
California	Riverside	Cathedral	Riverside Conv
California	Riverside	Corona	Riverside Conv
California	Riverside	Desert Hot Springs	Riverside Conv
California	Riverside	Hemet	Riverside Conv
California	Riverside	Murrietta	Riverside Conv
California	Riverside	Palm Springs	Palm Springs MOT
California	Riverside	Palm Springs	Riverside Conv
California	Riverside	Riverside	Riverside Conv
California	Riverside	San Jacinto	Riverside Conv
California	San Bernadino	Adelanto	SanBernadinoE MOT
California	San Bernadino	Barstow	SanBernadinoD MOT
California	San Bernadino	Big Bear	SanBernadinoA MOT
California	San Bernadino	Chino	SanBernadinoA MOT
California	San Bernadino	Chino	SanBernadinoB MOT
California	San Bernadino	Colton	SanBernadinoA MOT
California	San Bernadino	Fontana	SanBernadinoB MOT
California	San Bernadino	Greater Highland	SanBernadinoB MOT
California	San Bernadino	Loma Linda	SanBernadinoB MOT
California	San Bernadino	Lucerne Valley	SanBernadinoC MOT
California	San Bernadino	Montclair	SanBernadinoA MOT
California	San Bernadino	Ontario	SanBernadinoA MOT
California	San Bernadino	Rancho Cucamonga	SanBernadinoB MOT
California	San Bernadino	Redlands	SanBernadinoB MOT
California	San Bernadino	Rialto	SanBernadinoB MOT
California	San Bernadino	San Bernadino	SanBernadinoA MOT
State	County	City	System
California	San Bernadino	Twin Peaks	SanBernadinoA MOT

Preprogrammed Systems

California	San Bernadino	Upland	SanBernadinoA MOT
California	San Bernadino	Wrightwood	SanBernadinoA MOT
California	San Bernadino	Yucaipa	SanBernadinoB MOT
California	San Diego	Camp Pendalton	San Diego MOT
California	San Diego	Del Mar	San Diego MOT
California	San Diego	Escondido	San Diego MOT
California	San Diego	Inland	San Diego MOT
California	San Diego	Monte Vista	San Diego MOT
California	San Diego	National City	National City MOT
California	San Diego	North County	San Diego MOT
California	San Diego	Rancho	San Diego MOT
California	San Diego	San Diego	San Diego City MOT
California	San Diego	San Diego County	San Diego Conv
California	San Diego	South Bay	San Diego MOT
California	Santa Clara	Gilroy	Santa Clara Conv
California	Santa Clara	Milpitas	Santa Clara Conv
California	Santa Clara	Mountain View	Santa Clara Conv
California	Santa Clara	Palo Alto	Santa Clara Conv
California	Santa Clara	San Jose	Santa Clara Conv
California	Santa Clara	Santa Clara	Santa Clara Conv
California	Santa Clara	Santa Clara	Santa Clara MOT
California	Santa Clara	Sunnyvale	Santa Clara Conv
Florida			
Florida	Broward	Broward	Broward County MOT
Florida	Broward	Coconut Creek	Broward Conv
Florida	Broward	Coral Springs	Coral Springs MOT
Florida	Broward	Dania	Hollywood EDACS
Florida	Broward	Fort Lauderdale	Ft.Lauderdale MOT
Florida	Broward	Hollywood	Hollywood EDACS
Florida	Broward	Margate	Coral Springs MOT
Florida	Broward	Miramar	Broward County MOT
Florida	Broward	Oakland Park	Ft.Lauderdale MOT
Florida	Broward	PembrokePines	Broward Conv
Florida	Broward	Plantation	Plantation MOT
Florida	Broward	Pompano	Ft.Lauderdale MOT
Florida	Broward	Pompano Beach	Ft.Lauderdale MOT
Florida	Broward	Sunrise	Broward Conv
Florida	Dade	Carol City	Dade EDACS
Florida	Dade	Cutler Ridge	Dade EDACS
Florida	Dade	Dade	Dade Conv
Florida	Dade	Dade	Dade Fire EDACS
Florida	Dade	Doral	Dade EDACS
Florida	Dade	Hammocks	Dade EDACS
Florida	Dade	Homestead	Dade Conv
State	County	City	System

Preprogrammed Systems

Florida	Dade	Intracostal	Dade EDACS
Florida	Dade	Kendall	Dade EDACS
Florida	Dade	Miami	Miami MOT
Florida	Dade	Miami Beach	Miami Beach MOT
Florida	Dade	Miami Lakes	Dade EDACS
Florida	Dade	Miccosokuee	Dade Fire EDACS
Florida	Dade	Municipal	Dade EDACS
Florida	Dade	Northside	Dade EDACS
Illinois			
Illinois	Cook	Alsip	Cook Conv
Illinois	Cook	Chicago	Cook Conv
Illinois	Cook	Englewood	Cook Conv
Illinois	Cook	Evergreen Park	Cook Conv
Illinois	Cook	Franklin Park	Cook Conv
Illinois	Cook	Hoffman	NW Central MOT
Illinois	Cook	Hometown	Cook Conv
Illinois	Cook	Merriont Park	Cook Conv
Illinois	Cook	Northlake	Cook Conv
Illinois	Cook	Northlake	Cook Conv
Illinois	Cook	Oak Lawn	Cook Conv
Illinois	Cook	Rosemont	Cook Conv
Illinois	Cook	Schaumburg	Schaumburg MOT
Illinois	Cook	Streamwood	NW Central MOT
Illinois	Cook	Veteran's Park	Cook Conv
Massachusetts			
Massachusetts	Middlesex	Ashby	Middlesex Conv
Massachusetts	Middlesex	Ayer	Middlesex Conv
Massachusetts	Middlesex	Belmont	Cambridge MOT
Massachusetts	Middlesex	Cambridge	Cambridge MOT
Massachusetts	Middlesex	Shirley	Middlesex Conv
Massachusetts	Middlesex	Townsend	Middlesex Conv
Michigan			
Michigan	Wayne	Allen Park	Wayne Conv
Michigan	Wayne	Belleville	Wayne Conv
Michigan	Wayne	Canton	Wayne Conv
Michigan	Wayne	Dearborn	Wayne Conv
Michigan	Wayne	Garden City	Wayne Conv
Michigan	Wayne	Huron	Wayne Conv
Michigan	Wayne	Northville	Wayne Conv
Michigan	Wayne	Plymouth	Wayne Conv
Michigan	Wayne	Redford	Wayne Conv
Michigan	Wayne	Romulus	Wayne Conv
Michigan	Wayne	Sumpter	Wayne Conv
Michigan	Wayne	Van Buren	Wayne Conv
Michigan	Wayne	WSU	Wayne Conv
Nevada			
Nevada	Clark	Clark County	Clark County MOT
Nevada	Clark	Henderson	Clark County MOT
State	County	City	System

Preprogrammed Systems

Nevada	Clark	Las Vegas	Clark County MO
Nevada	Clark	North Las Vegas	Clark County MO
New York			
New York	New York	Bronx	New York Conv
New York	New York	Brooklyn	New York Conv
New York	New York	Manhattan	New York Conv
New York	New York	New York	New York Conv
New York	New York	Queens	New York Conv
New York	New York	Staten Island	New York Conv
New York	Suffolk	Amangansett	East Hampton MO
New York	Suffolk	Amityville Village	SuffolkCounty MO
New York	Suffolk	Asharoken	SuffolkCounty MO
New York	Suffolk	Bridgehampton	East Hampton MO
New York	Suffolk	East Hampton	East Hampton MO
New York	Suffolk	East Hampton	East Hampton MO
		East Hampton	
New York	Suffolk	Village	East Hampton MO
New York	Suffolk	Islip Township	SuffolkCounty MO
New York	Suffolk	Lloyd Park	SuffolkCounty MO
New York	Suffolk	Montauk	East Hampton MO
New York	Suffolk	Northport	SuffolkCounty MO
New York	Suffolk	Ocean Beach	SuffolkCounty MO
New York	Suffolk	Riverhead	SuffolkCounty MO
New York	Suffolk	Sag Harbor	East Hampton MO
New York	Suffolk	Sag Harbor Village	East Hampton MO
New York	Suffolk	Smithtown	SuffolkCounty MO
New York	Suffolk	Springs	East Hampton MO
New York	Suffolk	Suffolk County	SuffolkCounty MO
Ohio			
Ohio	Cuyahoga	Bay Village	Cuyahoga Conv
Ohio	Cuyahoga	Beachwood	Cuyahoga Conv
Ohio	Cuyahoga	Bedford	Cuyahoga Conv
Ohio	Cuyahoga	Bedford Heights	Cuyahoga Conv
Ohio	Cuyahoga	Bentleyville	Cuyahoga Conv
Ohio	Cuyahoga	Berea	Cuyahoga Conv
Ohio	Cuyahoga	Bratenhal	Cuyahoga Conv
Ohio	Cuyahoga	Brecksville	Cuyahoga Conv
Ohio	Cuyahoga	Broadview Heights	Cuyahoga Conv
Ohio	Cuyahoga	Brooklyn	Parma EDACS
Ohio	Cuyahoga	Brooklyn Heights	Cuyahoga Conv
Ohio	Cuyahoga	Brookpark	Brook Park MO
Ohio	Cuyahoga	Chagrin Falls	Cuyahoga Conv
Ohio	Cuyahoga	Cleveland Heights	Cuyahoga Conv
Ohio	Cuyahoga	Cuyahoga	Cuyahoga Conv
Ohio	Cuyahoga	Cuyahoga Heights	Cuyahoga Conv
Ohio	Cuyahoga	East Cleveland	Cuyahoga Conv
Ohio	Cuyahoga	Euclid	Cuyahoga Conv
Ohio	Cuyahoga	Fairview Park	Cuyahoga Conv
Ohio	Cuyahoga	Garfield Heights	Cuyahoga Conv
Ohio	Cuyahoga	Gates Mills	Cuyahoga Conv

Preprogrammed Systems

State	County	City	System
Ohio	Cuyahoga	Glenwillow	Cuyahoga Conv
Ohio	Cuyahoga	Highland Heights	Cuyahoga Conv
Ohio	Cuyahoga	Highland Hills	Cuyahoga Conv
Ohio	Cuyahoga	Hunting Valley	Cuyahoga Conv
Ohio	Cuyahoga	Independence	Cuyahoga Conv
Ohio	Cuyahoga	Lakewood	Cuyahoga Conv
Ohio	Cuyahoga	Linndale	Parma EDACS
Ohio	Cuyahoga	Lyndhurst	Cuyahoga Conv
Ohio	Cuyahoga	Maple Heights	Cuyahoga Conv
Ohio	Cuyahoga	Mayfield	Cuyahoga Conv
Ohio	Cuyahoga	Middleburg Heights	Brook Park MOT
Ohio	Cuyahoga	Middleburg Heights	Cuyahoga Conv
Ohio	Cuyahoga	Moreland Hills	Cuyahoga Conv
Ohio	Cuyahoga	Newburg Heights	Cuyahoga Conv
Ohio	Cuyahoga	North Olmsted	Cuyahoga Conv
Ohio	Cuyahoga	North Randall	Cuyahoga Conv
Ohio	Cuyahoga	North Royalton	Brook Park MOT
Ohio	Cuyahoga	North Royalton	Cuyahoga Conv
Ohio	Cuyahoga	Oakwood	Cuyahoga Conv
Ohio	Cuyahoga	Olmstead Falls	Brook Park MOT
Ohio	Cuyahoga	Olmsted Falls	Cuyahoga Conv
Ohio	Cuyahoga	Olmsted Township	Cuyahoga Conv
Ohio	Cuyahoga	Orange	Cuyahoga Conv
Ohio	Cuyahoga	Parma	Parma EDACS
Ohio	Cuyahoga	Parma Heights	Brook Park MOT
Ohio	Cuyahoga	Pepper Pike	Cuyahoga Conv
Ohio	Cuyahoga	Richmond Heights	Cuyahoga Conv
Ohio	Cuyahoga	Rocky River	Cuyahoga Conv
Ohio	Cuyahoga	Seven Hills	Cuyahoga Conv
Ohio	Cuyahoga	Shaker Heights	Cuyahoga Conv
Ohio	Cuyahoga	Solon	Cuyahoga Conv
Ohio	Cuyahoga	South Euclid	Cuyahoga Conv
Ohio	Cuyahoga	Strongsville	Brook Park MOT
Ohio	Cuyahoga	University Circle	Cuyahoga Conv
Ohio	Cuyahoga	University Heights	Cuyahoga Conv
Ohio	Cuyahoga	Valley View	Cuyahoga Conv
Ohio	Cuyahoga	Walton Hills	Cuyahoga Conv
Ohio	Cuyahoga	Warrensville Heights	Cuyahoga Conv
Ohio	Cuyahoga	Westlake	Cuyahoga Conv
Ohio	Cuyahoga	Woodmere	Cuyahoga Conv
Pennsylvania			
Pennsylvania	Philadelphia	Temple PD	Philadelphia Conv
Texas			
Texas	Bexar	Alamo Heights	Bexar Conv
Texas	Bexar	Balcones Heights	Bexar Conv
Texas	Bexar	Bexar County	Bexar Conv
Texas	Bexar	Castle Hills	Bexar Conv
Texas	Bexar	Hollywood Park	Bexar Conv
Texas	Bexar	Kirby	Bexar Conv

Preprogrammed Systems

State	County	City	System
Texas	Bexar	Leon Valley	Bexar Conv
Texas	Bexar	Live Oak	Bexar Conv
Texas	Bexar	Shavano Park	Bexar Conv
Texas	Bexar	Terrell Hills	Bexar Conv
Texas	Bexar	Universal City	Bexar Conv
Texas	Bexar	Windcrest	Bexar Conv
Texas	Dallas	Addison	Carrolton MOT
Texas	Dallas	Carrolton	Carrolton MOT
Texas	Dallas	Cockrell Hill	Dallas MOT
Texas	Dallas	Coppell	Lewisville MOT
Texas	Dallas	Dallas	Dallas Conv
Texas	Dallas	Dallas	Dallas MOT
Texas	Dallas	Desoto	Dallas Conv
Texas	Dallas	Duncanville	Dallas Conv
Texas	Dallas	Farmers Branch	Carrolton MOT
Texas	Dallas	Flower Mound	Lewisville MOT
Texas	Dallas	Garland	Garland MOT
Texas	Dallas	Grand Prairie	Grand Prairie MOT
Texas	Dallas	Highland Park	Dallas Conv
Texas	Dallas	Highland Village	Lewisville MOT
Texas	Dallas	Hutchins	Dallas Conv
Texas	Dallas	Irving	Irving EDACS
Texas	Dallas	Lake Cities	Lewisville MOT
Texas	Dallas	Lancaster	Dallas Conv
Texas	Dallas	Lewisville	Lewisville MOT
Texas	Dallas	Mesquite	Mesquite MOT
Texas	Dallas	Richardson	Richardson EDACS
Texas	Dallas	Rowlett	Garland MOT
Texas	Dallas	Sachse	Garland MOT
Texas	Dallas	Seagoville	Dallas Conv
Texas	Dallas	Sunnyvale	Dallas Conv
Texas	Dallas	University Park	Dallas Conv
Texas	Dallas	Wilmer	Dallas Conv
Texas	Harris	Arcola	Starnet MOT
Texas	Harris	Baytown	Starnet MOT
Texas	Harris	Brazoria County	Starnet MOT
Texas	Harris	Cy-Fair	Harris Conv
Texas	Harris	Cypress Creek	Harris Conv
Texas	Harris	Fresno	Starnet MOT
Texas	Harris	Ft Bend County	Starnet MOT
Texas	Harris	Fulshar	Starnet MOT
Texas	Harris	Galena Park	Starnet MOT
Texas	Harris	Harris County	Starnet MOT
Texas	Harris	Humble	Starnet MOT
Texas	Harris	Jersey Village	Starnet MOT
Texas	Harris	Katy	Starnet MOT
Texas	Harris	Kendleton	Starnet MOT
Texas	Harris	Meadows	Starnet MOT
Texas	Harris	Needville	Starnet MOT
Texas	Harris	Pasadena	Starnet MOT

Preprogrammed Systems

State	County	City	System
Texas	Harris	Pecan Grove	Starnet MOT
Texas	Harris	Richmond	Starnet MOT
Texas	Harris	Rosehill	Harris Conv
Texas	Harris	Rosenberg	Starnet MOT
Texas	Harris	Tomball	Harris Conv
Texas	Harris	Webster	Starnet MOT
Texas	Harris	West University Place	Starnet MOT
Texas	Harris	Willow Fork	Starnet MOT
Texas	Tarrant	Arlington	Arlington MOT
Texas	Tarrant	Azle	Tarrant Conv
Texas	Tarrant	Bedford	NE Tarrant MOT
Texas	Tarrant	Benbrook	Tarrant Conv
Texas	Tarrant	Burleson	Tarrant Conv
Texas	Tarrant	Colleyville	NE Tarrant MOT
Texas	Tarrant	Crowley	Tarrant Conv
Texas	Tarrant	Dalworthington Gardens	Tarrant Conv
Texas	Tarrant	Eagle Mount	Tarrant Conv
Texas	Tarrant	Eules	NE Tarrant MOT
Texas	Tarrant	Forest Hill	Tarrant Conv
Texas	Tarrant	Forest Hills	Fort Worth MOT
Texas	Tarrant	Fort Worth	Fort Worth MOT
Texas	Tarrant	Grapevine	NE Tarrant MOT
Texas	Tarrant	Haltom City	Fort Worth MOT
Texas	Tarrant	Haslet	Tarrant Conv
Texas	Tarrant	Hurst	Tarrant Conv
Texas	Tarrant	Keller	NE Tarrant MOT
Texas	Tarrant	Kennedale	Fort Worth MOT
Texas	Tarrant	Lake Worth	Tarrant Conv
Texas	Tarrant	North Richland Hills	Fort Worth MOT
Texas	Tarrant	Rendon	Tarrant Conv
Texas	Tarrant	Richland Hills	Fort Worth MOT
Texas	Tarrant	Saginaw	Tarrant Conv
Texas	Tarrant	Southlake	Fort Worth MOT
Texas	Tarrant	Southlake	NE Tarrant MOT
Texas	Tarrant	Watauga	Tarrant Conv
Texas	Tarrant	Westlake	NE Tarrant MOT
Texas	Tarrant	White Settlement	Tarrant Conv
Washington			
Washington	King	Airport	PortOfSeattle MOT
Washington	King	Algona	Seattle MOT
Washington	King	Auburn	Seattle MOT
Washington	King	Bellevue	Seattle MOT
Washington	King	Bothell	Seattle MOT
Washington	King	Des Moines	Seattle MOT
Washington	King	Eastside	Seattle MOT
Washington	King	Enumclaw	Seattle MOT
Washington	King	Federal Way	Seattle MOT

Preprogrammed Systems

Washington	King	Issaquah	Seattle MOT
Washington	King	Kent	Seattle MOT
State	County	City	System
Washington	King	King County	Seattle MOT
Washington	King	Kirkland	Seattle MOT
Washington	King	Mercer Island	Seattle MOT
Washington	King	Muckleshoot	Seattle MOT
Washington	King	Normandy Park	Seattle MOT
Washington	King	Port	PortOfSeattle MOT
Washington	King	Redmond	Seattle MOT
Washington	King	Seattle	Seattle MOT
Washington	King	Snoqualmie	Seattle MOT
Washington	King	Tukwilla	Seattle MOT
Washington	King	Waterfront	PortOfSeattle MOT

Preprogrammed Systems

Important: Evidence of original purchase is required for warranty service.

WARRANTOR: UNIDEN AMERICA CORPORATION (“Uniden”)

ELEMENTS OF WARRANTY: Uniden warrants, for one year, to the original retail owner, this Uniden Product to be free from defects in materials and craftsmanship with only the limitations or exclusions set out below.

WARRANTY DURATION: This warranty to the original user shall terminate and be of no further effect 12 months after the date of original retail sale. The warranty is invalid if the Product is (A) damaged or not maintained as reasonable or necessary, (B) modified, altered, or used as part of any conversion kits, subassemblies, or any configurations not sold by Uniden, (C) improperly installed, (D) serviced or repaired by someone other than an authorized Uniden service center for a defect or malfunction covered by this warranty, (E) used in any conjunction with equipment or parts or as part of any system not manufactured by Uniden, or (F) installed or programmed by anyone other than as detailed by the Operating Guide for this product.

STATEMENT OF REMEDY: In the event that the product does not conform to this warranty at any time while this warranty is in effect, warrantor will repair the defect and return it to you without charge for parts, service, or any other cost (except shipping and handling) incurred by warrantor or its representatives in connection with the performance of this warranty. THE LIMITED WARRANTY SET FORTH ABOVE IS THE SOLE AND ENTIRE WARRANTY PERTAINING TO THE PRODUCT AND IS IN LIEU OF AND EXCLUDES ALL OTHER WARRANTIES OF ANY NATURE WHATSOEVER, WHETHER EXPRESS, IMPLIED OR ARISING BY OPERATION OF LAW, INCLUDING, BUT NOT LIMITED TO ANY IMPLIED WARRANTIES OF MERCHANTABILITY OR FITNESS FOR A PARTICULAR PURPOSE. THIS WARRANTY DOES NOT COVER OR PROVIDE FOR THE REIM-

One-Year Limited Warranty

BURSEMENT OR PAYMENT OF INCIDENTAL OR CONSEQUENTIAL DAMAGES. Some states do not allow this exclusion or limitation of incidental or consequential damages so the above limitation or exclusion might not apply to you.

LEGAL REMEDIES: This warranty gives you specific legal rights, and you might also have other rights which vary from state to state. This warranty is void outside the United States of America.

PROCEDURE FOR OBTAINING PERFORMANCE OF WARRANTY: If, after following the instructions in this Operating Guide you are certain that the Product is defective, pack the Product carefully (preferably in its original packaging). Include evidence of original purchase and a note describing the defect that has caused you to return it. The Product should be shipped freight prepaid, by traceable means, or delivered, to warrantor at:

Uniden America Corporation

Parts and Service Division

4700 Amon Carter Boulevard

Fort Worth, TX 76155

(800) 297-1023, 8:00 a.m. to 5:00 p.m., Central, Monday through Friday

One-Year Limited Warranty



One-Year Limited Warranty



One-Year Limited Warranty



One-Year Limited Warranty



One-Year Limited Warranty

One-Year Limited Warranty



One-Year Limited Warranty



One-Year Limited Warranty



One-Year Limited Warranty



One-Year Limited Warranty

FOR
ACCESSORIES,
GO ONLINE @
WWW.UNIDEN.COM

REGISTER ONLINE TODAY!

THANK YOU FOR BUYING A UNIDEN PRODUCT.

A World Without Wires | **Uniden®**

May be covered under one or more of the following U.S. patents:

4,398,304	4,409,688	4,455,679	4,461,036	4,521,915	4,597,104
4,627,100	4,841,302	4,888,815	4,932,074	4,947,456	5,014,348
5,199,109	5,408,692	5,428,826	5,438,688	5,448,256	5,465,402
5,471,660	5,483,684	5,630,236	5,648,832	5,651,071	5,674,995
5,877,076	5,908,430	5,830,223	5,842,424	5,710,892	5,669,975
5,896,492	5,891,346	5,981,603	6,012,168	6,025,738	6,034,873
6,084,270	6,266,521				

©2004 Uniden America Corporation, Fort Worth, Texas.
Contains additional foreign articles. Custom manufactured in China.

Free Manuals Download Website

<http://myh66.com>

<http://usermanuals.us>

<http://www.somanuals.com>

<http://www.4manuals.cc>

<http://www.manual-lib.com>

<http://www.404manual.com>

<http://www.luxmanual.com>

<http://aubethermostatmanual.com>

Golf course search by state

<http://golfingnear.com>

Email search by domain

<http://emailbydomain.com>

Auto manuals search

<http://auto.somanuals.com>

TV manuals search

<http://tv.somanuals.com>