

# UBC60XLT

## *Programmable Hand-Held Scanner*

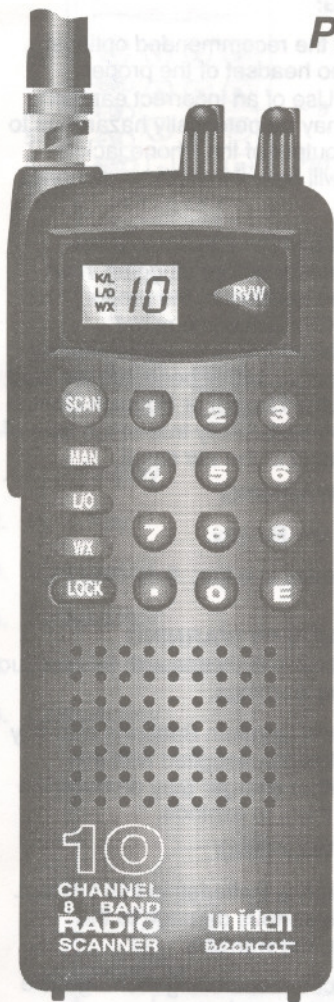

## OPERATING GUIDE

# PRECAUTIONS

---

Before you use this scanner, please read and observe the following:

## ■ WARNING!

Uniden **DOES NOT** represent this unit to be waterproof. To reduce the risk of fire or electrical shock, **DO NOT** expose this unit to rain or moisture.

## ■ EARPHONE WARNING:

- Be sure to use only the recommended optional earphone or a stereo headset of the proper impedance ( $32\Omega$ ). Use of an incorrect earphone or stereo headset may be potentially hazardous to your hearing. The output of the Phone jack is monaural, but you will hear it in both headphones of a stereo headset.
- Set the Volume to a comfortable audio level coming from the speaker before plugging in an earphone or a stereo headset of the proper impedance ( $32\Omega$ ). Otherwise you might experience some discomfort or possible hearing damage if the Volume suddenly becomes too loud because of the Volume Control or Squelch Control setting. This may be particularly true of the type of earphone that is placed in the ear canal.

## ■ GENERAL BATTERY WARNING

- Do not short circuit any Battery.
- Do not discard Batteries in a fire; they may explode.

## ■ NICKEL-CADMIUM BATTERY WARNING

When using Nickel-Cadmium Batteries with this product, take note of the following warnings:

- Do not charge Nickel-Cadmium Batteries with any charger other than the one supplied with this product. Using another charger may damage the Batteries, or cause them to explode.

## ■ ALKALINE BATTERY WARNING

- Do not recharge Alkaline Batteries in this product. Doing so may cause serious damage to the product and will void the warranty.
- Uniden does not recommend using rechargeable Alkaline Batteries in this product.

# Table of Contents

---

<b>About Your New UBC60XLT</b> .....	<b>2</b>
Feature Highlights .....	2
What is Scanning? .....	2
Types of Communication .....	3
<b>Included with the UBC60XLT</b> .....	<b>4</b>
<b>Setup</b> .....	<b>5</b>
Power .....	5
Installing Batteries .....	5
AC/DC Adaptor/Charger .....	6
Mounting the Flexible Antenna .....	6
Installing the Belt Clip .....	6
<b>Operation</b> .....	<b>7</b>
Keylock .....	7
Programming Channels .....	8
How Squelch Works .....	11
Setting the Squelch .....	12
Scanning Programmed Channels .....	12
Channel Lockout .....	15
Scanning Weather Channels .....	17
<b>Care and Maintenance</b> .....	<b>19</b>
Low Battery Warning .....	19
Replacing the Batteries .....	19
Location .....	19
Cleaning .....	19
Repairs .....	19
Proper Care of Your Scanner .....	19
<b>Optional Accessories and Replacement Parts</b> .....	<b>20</b>
<b>Operating Tips</b> .....	<b>21</b>
<b>Technical Specifications</b> .....	<b>23</b>
<b>Controls</b> .....	<b>Back Cover Foldout</b>

# About Your New UBC60XLT

---

The **UBC60XLT** is a brand new state-of-the-art information radio with automatic scanning capabilities. It can store frequencies such as police, fire/emergency, marine, amateur, and other communications into 10 channels.

## Feature Highlights

**10 Channels** Program one frequency in each channel. You must have at least one channel programmed to use this scanner.

**8 Bands, 66 MHz - 512 MHz** Scan these frequency ranges with your scanner. (**Note:** The frequency coverage is not totally continuous from 66.0 MHz to 512 MHz.)

**Weather Channels** Use your scanner as a weather information radio. (Weather Service is currently not available in Australia)

**Memory Backup** Frequencies programmed in the channels are retained in memory for at least 1 day, and typically 3 days, when batteries are removed from the scanner.

## What is Scanning?

Unlike standard AM or FM radio stations, most two-way communications (listed below) do not transmit continuously. The **UBC60XLT** scans programmed channels at the rate of nearly 10 channels per second until it finds an active frequency.

Scanning stops on an active frequency, and remains on that channel as long as the transmission continues. When the transmission ends, the scanner stays on the channel for 2 more seconds after the transmission stops, waiting for another transmission. The scanning cycle then resumes until another transmission is received.

While the **UBC60XLT** is scanning channels, it is in "SCAN Mode". When you stop the scanning with **(MAN)**, it is in "MANUAL Mode".

## Types of Communication

You will be able to monitor communication such as:

- Police and fire department (including rescue and paramedics)
- Business/industrial radio
- Motion picture and press relay
- Utility
- Land transportation frequencies, such as trucking firms, buses, taxis, tow trucks, and railroads
- Marine and amateur (ham radio) bands

And many more in the following 8 Bands:

### Frequency Range

66.0-88.0 MHz

137-144 MHz

144-148 MHz

148-174 MHz

406-420 MHz

420-450 MHz

450-470 MHz

470-512 MHz

### Transmission

VHF Low band

Land Mobile

2 Meter Amateur Band

VHF High Band

Land Mobile

70 cm Amateur Band

UHF Standard Band

Land Mobile

# Included with the UBC60XLT

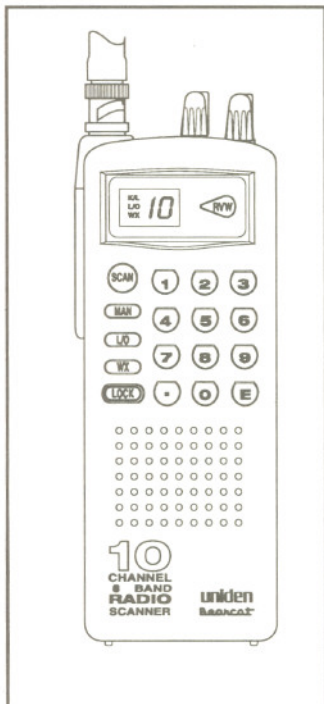

UBC60XLT  
Operating Guide

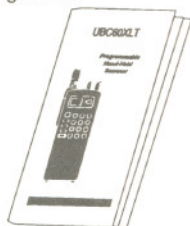

Belt Clip  
with  
Screws  
(BCK150)



Rubber Antenna  
(AT218)





# Setup

## Power

### Installing Batteries

1. Open cover.

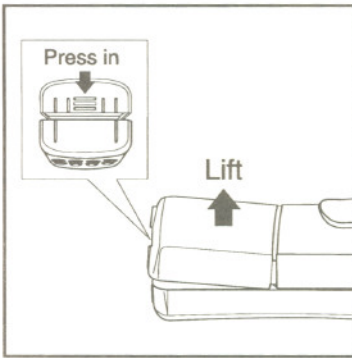

2. Insert batteries

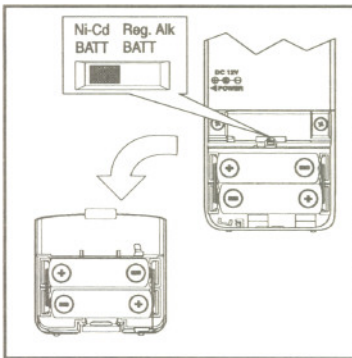

### IMPORTANT

If you are installing Alkaline Batteries, set the switch to "Reg. Alk BATT." If installing Nickel-Cadmium Batteries, set the switch to "Ni-Cd BATT."

**WARNING!** Do not mix Alkaline Batteries with Nickel-Cadmium Batteries. Be sure to install four Batteries of the same type.

3. Replace cover.

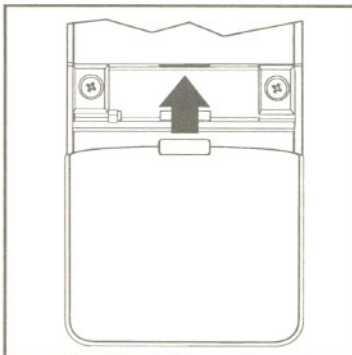

## AC Adaptor/Charger



Use the optional AC Adaptor/Charger to power the **UBC60XLT** from an AC source.

The AC Adaptor/Charger also recharges *Nickel-Cadmium* Batteries while they are installed in the scanner.

---

**WARNING!** *Do not* charge Alkaline Batteries in this scanner. Doing so may cause serious damage to the product and void the warranty. Before attempting to recharge Batteries, make sure you have installed four rechargeable *Nickel-Cadmium* Batteries and the selector switch is set to "Ni-Cd".

---

## Mounting the Flexible Antenna

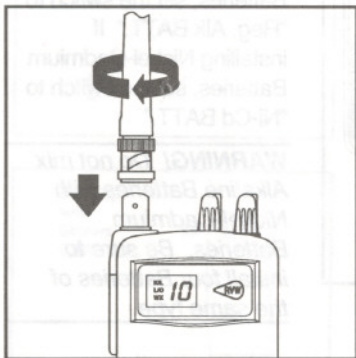

## Installing the Belt Clip

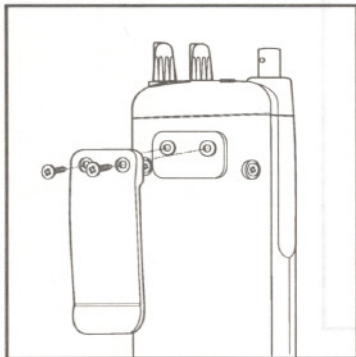

**CAUTION:** *Do not* tighten the screws too tight. You could damage the case or clip.



# Operation

## Keylock

Keylock prevents accidental key entries.

To lock:

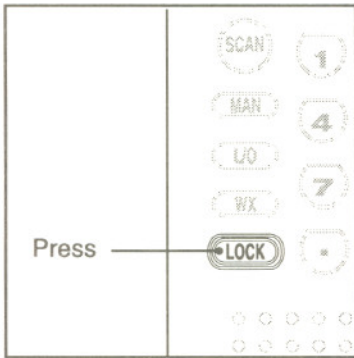

Only the **SCAN**, **MAN**, and **LOCK** keys will function.

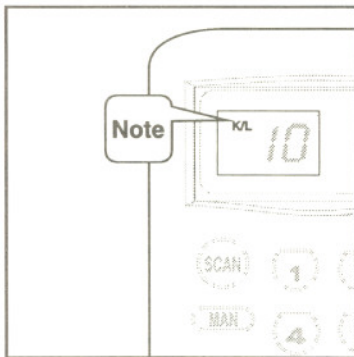

To unlock:

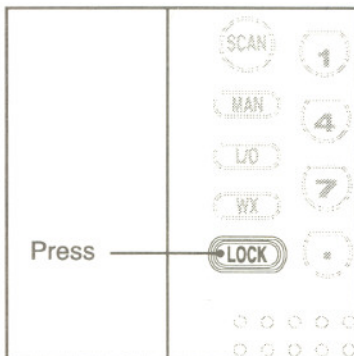

If keys do not work, press **LOCK** to unlock keys.

The **K/L** indicator disappears from the display.

# Programming Channels

1. Select frequency.

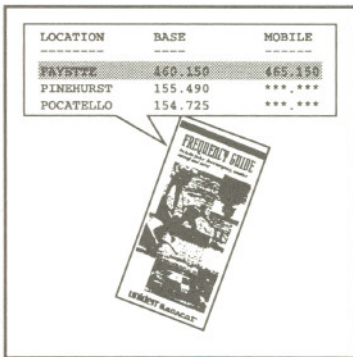

2. Select channel using Manual mode.

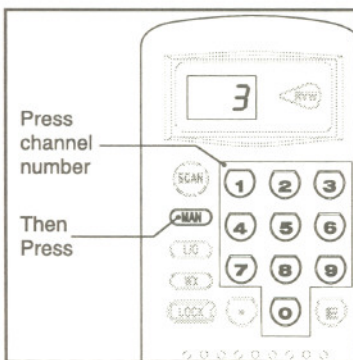
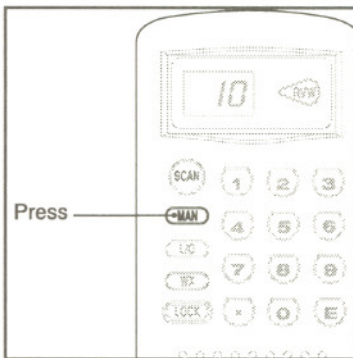

**Note:** For channel 10, press ①, ⑩.

— OR —

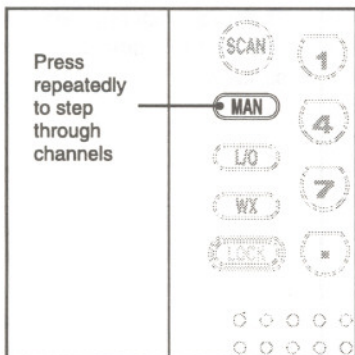

### 3. Enter frequency.

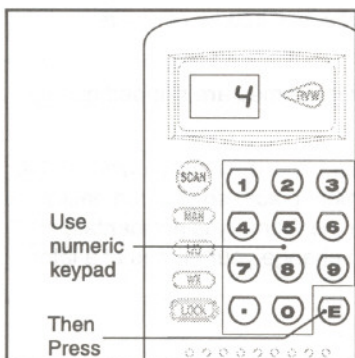

Each digit displays as you enter it.

The decimal displays as a dash.

If you make a mistake, press  twice and start over.

### 3a. If frequency outside range.

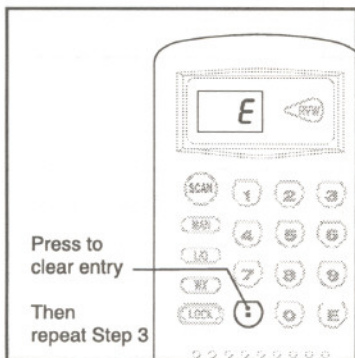

Programmed frequencies must be within the bands shown on the back of the scanner, and on page three of this guide.

#### 4. Recheck frequency.

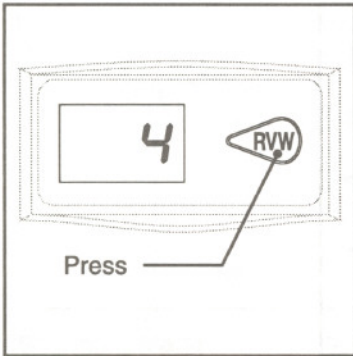

The frequency appears one digit at a time in sequence.

Repeat these steps to program each channel.

You can program the same frequency into two or more channels, if desired.

Channels with no frequency programmed are skipped during scanning.

After programming your scanner, record the frequencies in the table below (or another convenient place) so you can easily reprogram the scanner in case the memory is accidentally erased. Use pencil so you can change your entries at a later date.

Channel	Frequency	Notes
1		
2		
3		
4		
5		
6		
7		
8		
9		
10		

## How Squelch Works

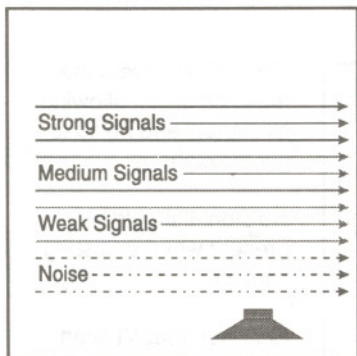

Think of "SQUELCH" as a gate.

If the gate is set too low (SQUELCH too low), everything (all noise as well as signals) gets through.

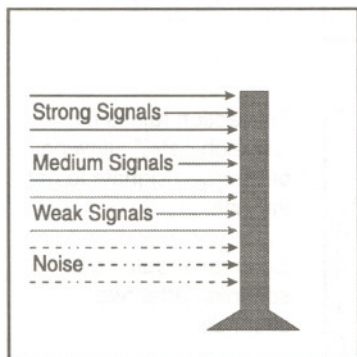

If the gate is set too high (SQUELCH too high), nothing gets through.

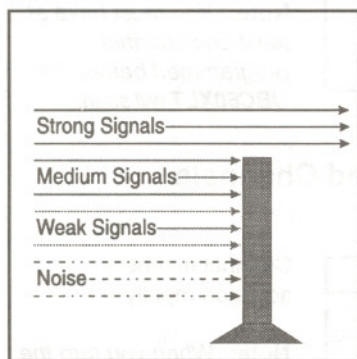

If the gate is set just right (SQUELCH set properly), just the desired signals get through.

## Setting the Squelch

1. Turn until hiss heard.



This action lowers the "squelch gate," allowing all signals and noise to get through.

No signal should be present when adjusting squelch.

Scanner doesn't scan with squelch open.

2. Turn just until hiss stops.



This action raises the "squelch gate," allowing only strong signals to get through.

Scanner should begin scanning after two seconds.

**Note:** You must have at least one channel programmed before the UBC60XLT will scan.

## Scanning Programmed Channels

Turn the scanner on.

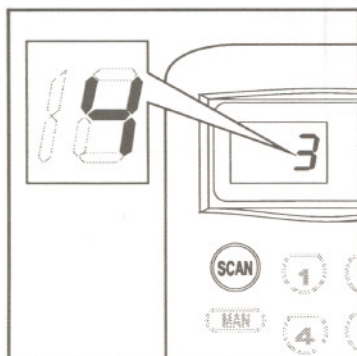

Channel numbers advance rapidly.

**Note:** When you turn the scanner on, it will always be in Scan mode.



The scanner skips any unprogrammed channels, and locked out channels.

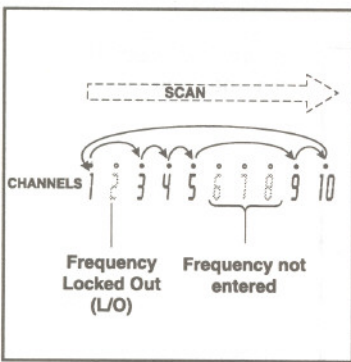

When transmission received:

Scanner stops on that channel.

When the transmission ends, scanning resumes after a two second delay.

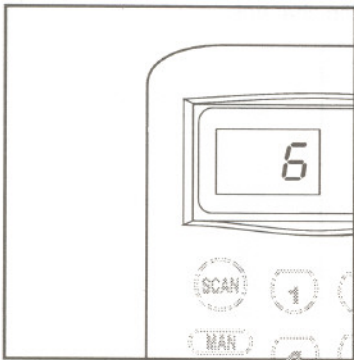

To hold on that channel:

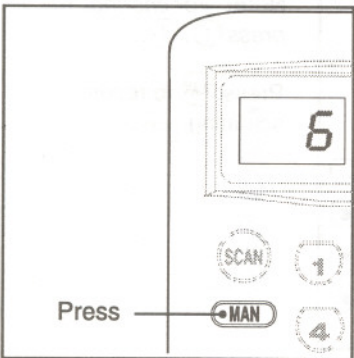

To resume scanning:

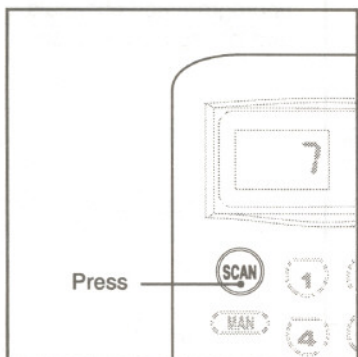

Scanner immediately resumes scanning.

To listen to or program a specific channel:

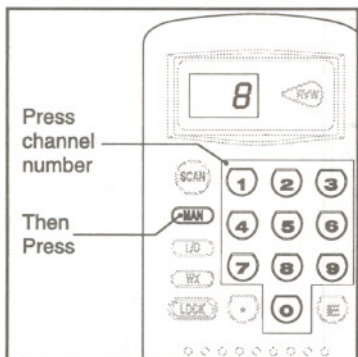
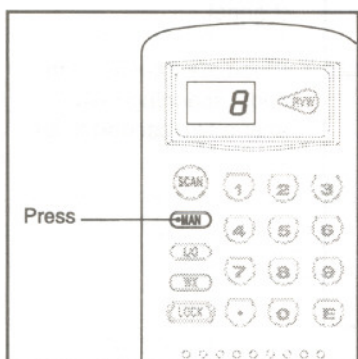

**Note:** For channel 10, press ①, ⑩.

Press **SCAN** to resume scanning.

## Channel Lockout

Channel Lockout lets you skip channels during scanning. There are two ways to lock out a channel:

### Manual Mode

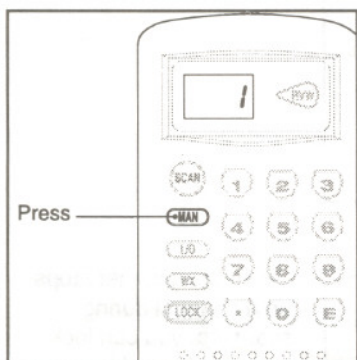

Use Manual mode to select the channel you want to lock out.

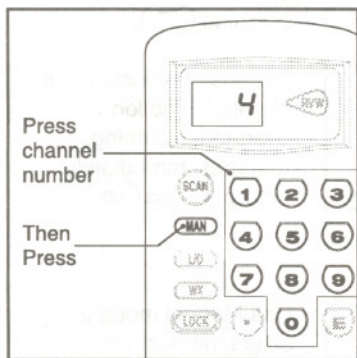

**Note:** For channel 10, press 1, 0.

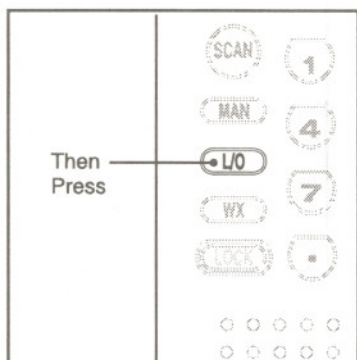

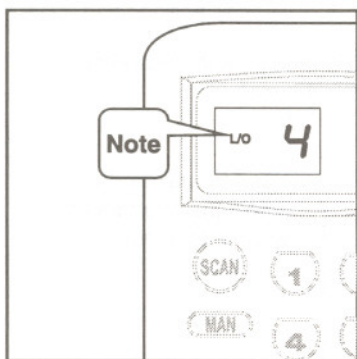

## Scanning Mode

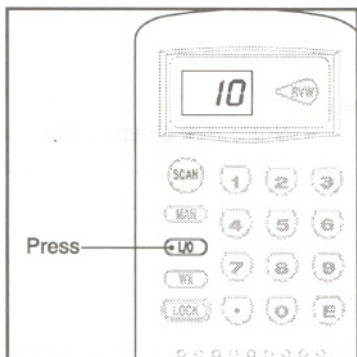

When the scanner stops on a channel during scanning, you can lock out that channel by pressing (L/O).

Because the locked out channel is no longer scanned, scanning resumes immediately after pressing (L/O).

## To unlock a channel:

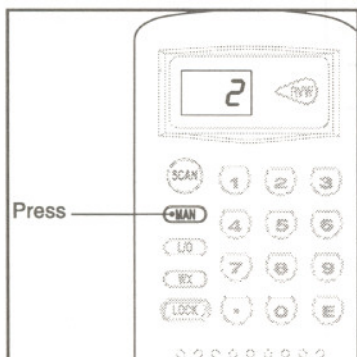

Use Manual mode to select the desired channel.

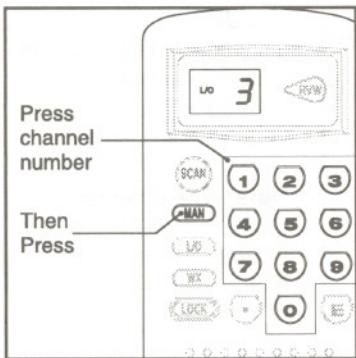

**Note:** For channel 10, press ①, ⑩.

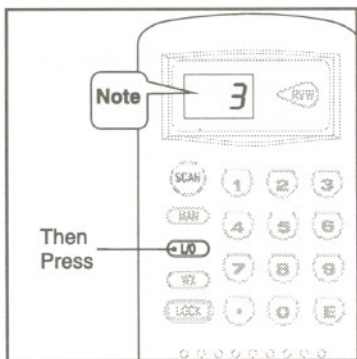

The L/O indicator disappears from the display after pressing L/O.

## Scanning Weather Channels (Weather Channels are not used in Australia)

To scan weather channels:

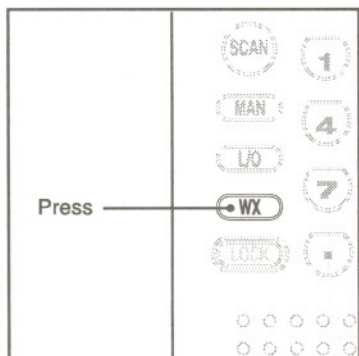

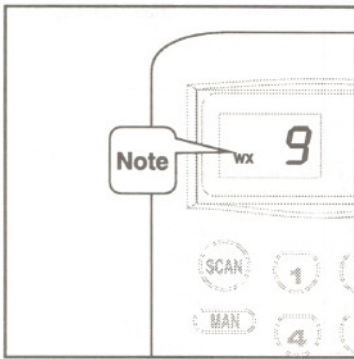

The **UBC60XLT** finds the active weather channel in your area from seven preprogrammed frequencies.

**Note:** *The channel number does not indicate weather frequency you hear.*

To review the weather frequency:

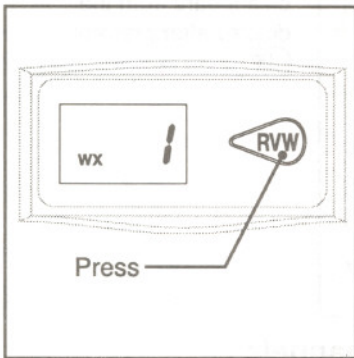

The frequency displays one digit at a time, in sequence.

To resume normal scanning:

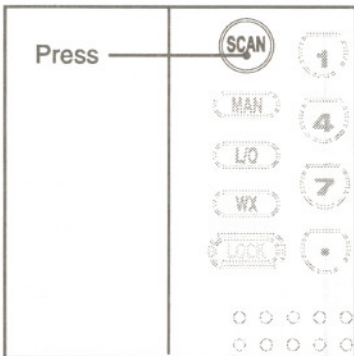



## Care and Maintenance

---

### Low Battery Warning

When the Batteries become weak, you will hear an audible warning. Be sure to replace Alkaline Batteries as soon as possible, or you can recharge *Nickel-Cadmium* Batteries while they are installed in the scanner.

### Replacing the Batteries

See page five.

### Location

- If strong interference or electrical noise is received, relocate the scanner or its antenna away from the source of the noise. A higher elevation, if possible, may provide better reception.
- **Do not** use the scanner in high-moisture environments such as the kitchen or bathroom.
- Avoid placing the unit in direct sunlight or near heating elements or vents.

### Cleaning

- Disconnect the power to the unit before cleaning.
- Clean the outside of the scanner with a mild detergent.
- To prevent scratches, **do not** use abrasive cleaners or solvents. Be careful not to rub the LCD window.
- **Do not** use excessive amounts of water.

### Repairs

**Do not** attempt any repair. The scanner contains no user serviceable parts. Contact the Uniden Customer Service Division or take it to a qualified repair technician.

### Proper Care of Your Scanner

- Use only suggested AC/Adaptor charger (optional).
- Avoid placing the scanner in direct sunlight or near heating elements or vents.
- Do not subject the scanner to extremes in temperature. If the scanner is exposed to temperatures below  $-10^{\circ}\text{C}$  or above  $+60^{\circ}\text{C}$ , the liquid crystal display may temporarily cease to function properly, or can become permanently damaged.

## Optional Accessories and Replacement Parts

The following optional accessories and replacement parts for your **UBC60XLT** are available from your local Uniden Dealer or through the Uniden Service Division:

Ear Phone (64  $\Omega$ )  
(EP009)



Cigarette Lighter Adapter  
(PS001)

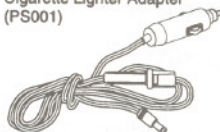

*(For 12V negative ground systems only)*

Rubber Antenna  
(AT218)



AC Adaptor/Charger



Belt Clip with  
Screws  
(BCK150)





UBC60XLT  
Operating Guide



## Operating Tips

If your **UBC60XLT** is not performing properly, try the steps listed below.

CONDITION	SUGGESTION
Scanner doesn't turn on.	<p>Rotate the Volume control to the right.</p> <p>Check the Batteries for correct installation.</p> <p>Check the power level of the Batteries. Replace or recharge Batteries as necessary.</p> <p>Check the (optional) AC Adaptor/Charger or the (optional) Cigarette Lighter Adaptor for a good electrical contact at the scanner. Make sure there is power at the AC outlet (or the vehicle's cigarette lighter).</p> <p>Check the in-line fuse on the (optional) Cigarette Lighter Adaptor cord. If blown, replace it with the <i>same type</i> of fuse.</p>
Poor reception.	<p>Check the antenna connection. Make sure the antenna is in a vertical position.</p> <p>If you're inside a building, move the scanner to a window, an outside wall, or outdoors.</p> <p>Check for sources of interference such as computers, microwave ovens, or other electrical devices. Move the scanner as necessary.</p> <p>You may be too far away from the stations using the frequencies you have programmed. Try another location, or program frequencies for stations closer to your area.</p>
<p>Scanner doesn't receive weather channels.</p> <p>Note: Currently Weather Broadcast is not available in Australia.</p>	<p>Adjust the Squelch setting. It may be too high.</p> <p>In some parts of the country, you may not be able to monitor weather broadcasts, such as in low lying areas. Move the scanner to a higher location.</p> <p>Reception may be poor. See above for suggestions.</p>

CONDITION	SUGGESTION
Scan doesn't stop.	<p>Adjust the Squelch setting. It may be too high.</p> <p>Check the antenna connection. Make sure the antenna is in a vertical position.</p> <p>Reception may be poor. See above for suggestions.</p> <p>It is possible that none of the programmed frequencies are active at the time.</p>
Scan doesn't start.	<p>Make sure there are some programmed channels.</p> <p>The scanner may be in Manual mode. Press  to begin scanning.</p> <p>The scanner may be stopped on a weather frequency. Press  to begin scanning.</p> <p>Adjust the Squelch setting. It may be too low.</p> <p>All the channels may be locked out. Turn off Lockout for the channels you want to scan.</p>
Keypad won't work.	<p>Check the Keylock. Make sure Keylock is off before programming or locking out channels.</p>

If you still cannot get satisfactory results and want additional information, or to return the unit for service, please call or write the Uniden Customer Service Division. The address and phone number are listed in the Warranty (at the end of this manual).

## Technical Specifications

---

<b>Channels:</b>	10
<b>WX:</b>	7 Programmed Channels (Weather Service is currently not available in Australia)
<b>Frequency Coverage:</b>	66.00 to 88.00 MHz 137.00 to 144.00 MHz 144.00 to 148.00 MHz 148.00 to 174.00 MHz 406.00 to 420.00 MHz 420.00 to 450.00 MHz 450.00 to 470.00 MHz 470.00 to 512.00 MHz
<b>Scan Rate:</b>	10 channels per sec.
<b>Scan Delay:</b>	2 seconds
<b>Audio Output:</b>	250 mW nominal into 8 $\Omega$ internal speaker
<b>Antenna:</b>	Rubber antenna included
<b>Operating Temperature:</b>	-10°C to +60°C
<b>Size:</b>	68 mm (W) x 42 mm (D) x 326 mm (H) (with antenna attached)
<b>Weight:</b>	360 g
<b>Power Requirements:</b>	6.0V DC — provided by 4 AA Alkaline Batteries, 4.8V DC — provided by 4 AA rechargeable Nickel-Cadmium Batteries, or External 12V DC — provided by the optional AC Adaptor/Charger, or an optional Cigarette Lighter Adaptor

*Features, specifications, and availability of optional accessories are all subject to change without notice.*



# Warranty

---

## Uniden UBC60XLT Scanning Receiver Australian 1 Year Warranty

**Note:** Please keep your sales docket as it provides evidence of warranty.

**WARRANTOR:** Uniden Australia Pty. Limited ACN 001 865 498

**ELEMENTS OF WARRANTY:** Uniden warrants to the original retail owner for the duration of this warranty, its UBC60XLT Scanning Receiver (hereinafter referred to as the Product), to be free from defects in materials and craftsmanship with only the limitations of exclusions set out below.

**WARRANTY DURATION:** This warranty to the original retail owner only, shall terminate and be of no further effect ONE (1) Year after the date of original retail sale. This warranty will be deemed invalid if the product is; (A) Damaged or not maintained as reasonable and necessary, (B) Modified, altered or used as part of any conversion kits, subassemblies, or any configurations not sold by Uniden, (C) Improperly installed, (D) Repaired by someone other than an authorized Uniden Repair Agent for a defect or malfunction covered by this warranty, (E) Used in conjunction with any equipment or parts or as part of a system not manufactured by Uniden, (F) Installed, programmed or serviced by anyone other than an authorized Uniden Repair Agent, (G) Where the Serial Number label of the product has been removed or damaged beyond recognition.

**PARTS COVERED:** This warranty covers for 1 year, the UBC60XLT Scanning Receiver Unit only. Antenna, Belt Clip, and all other accessories are covered for 90 days.

**STATEMENT OF REMEDY:** In the event that the product does not conform to this warranty at any time while this warranty is in effect, the warrantor at its discretion, will repair the defect or replace the product and return it to you without charge for parts and service.

**THIS WARRANTY DOES NOT COVER OR PROVIDE FOR THE REIMBURSEMENT OR PAYMENT OF INCIDENTAL OR CONSEQUENTIAL DAMAGES.**

**WARRANTY CARD:** If a warranty card has been included with this product then please fill it in and return it to us within 14 days of purchase. Your name and serial number of the product will then be registered in our database and this will help up process your claim with greater speed and efficiency should you require warranty service.

**PROCEDURE FOR OBTAINING PERFORMANCE OF WARRANTY:** In the event that the Product does not conform to this warranty, the Product should be shipped or delivered, freight pre-paid, with evidence of original purchase, (eg/ a copy of the sales docket), to the warrantor at:

**UNIDEN AUSTRALIA PTY. LIMITED  
SERVICE DIVISION**

345 Princes Highway, Rockdale, NSW 2216  
Ph (02) 599 3100 FAX (02) 599 3278

Customers in other States should ship or deliver the Product freight pre-paid to their nearest Uniden Authorized Repair Centre.  
(Contact Uniden for the nearest Warranty Agent to you)



# Controls

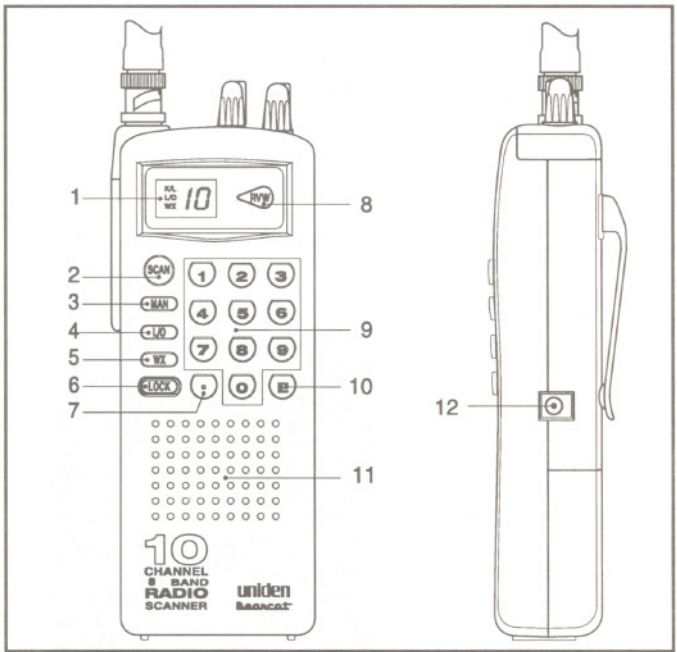

- |                     |                       |
|---------------------|-----------------------|
| 1. LCD Display      | 7. Decimal Key        |
| 2. Scan Key         | 8. Review Key         |
| 3. Manual Key       | 9. Numeric Key Pad    |
| 4. Lockout Key      | 10. Enter Key         |
| 5. Weather Scan Key | 11. Speaker           |
| 6. Keylock Key      | 12. 12V DC Power Jack |

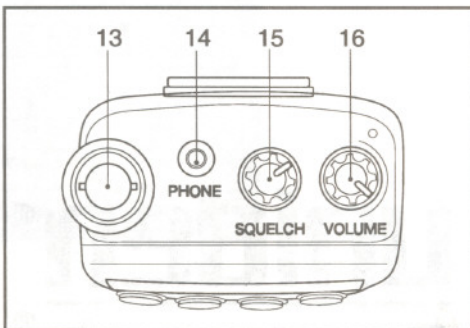

- |                       |                           |
|-----------------------|---------------------------|
| 13. Antenna Connector | 15. Squelch Control       |
| 14. Phone Jack        | 16. On/Off Volume Control |

**uniden**®  

---

**Beancat**®

## Free Manuals Download Website

<http://myh66.com>

<http://usermanuals.us>

<http://www.somanuals.com>

<http://www.4manuals.cc>

<http://www.manual-lib.com>

<http://www.404manual.com>

<http://www.luxmanual.com>

<http://aubethermostatmanual.com>

Golf course search by state

<http://golfingnear.com>

Email search by domain

<http://emailbydomain.com>

Auto manuals search

<http://auto.somanuals.com>

TV manuals search

<http://tv.somanuals.com>