

# D2998 Series User's Guide

## What's in the box?

Corded handset

Coiled cord  
(to connect handset to base)



D2998 base with answering system

Base AC adapter  
(PS-0034)

Telephone cord

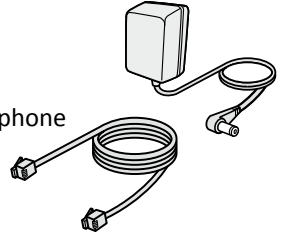

Desk/wall mount stand  
(may be attached to the base)

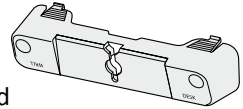

## You will also find:

DCX291 accessory handset and charger

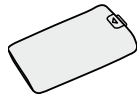

Battery cover

Charger AC adapter  
(PS-0035)

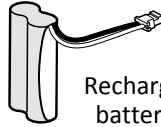
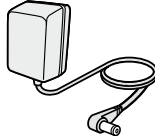

Rechargeable battery pack  
(BT-1016 or BT-1025)

If you purchased model number:	You should have:
D2998	1 of each
D2998-2	2 of each
D2998-3	3 of each
D2998-4	4 of each
D2998-5	5 of each
D2998-6	6 of each

- ◆ If any items are missing or damaged, contact our Customer Care Line immediately. Never use damaged products!
- ◆ Need Help? Get answers 24/7 at our website: [www.uniden.com](http://www.uniden.com).

If You...	Contact Uniden's...	Phone Number
have a question or problem	Customer Care Line*	817-858-2929 or 800-297-1023
need a replacement part or an accessory (headset, belt clip, etc.)	Parts Department*	800-554-3988
need special assistance due to a disability	Accessibility Help Line	800-874-9314 (voice or TTY)

\* During regular business hours, Central Standard Time. Visit our website for detailed business hours.

## What's in the manual?

<b>Getting Started</b> .....	<b>3</b>	Using an Optional Headset .....	17
Set Up the Base.....	3	Using Your Phone During a Power Failure .....	17
Set Up the Accessory Handset(s) .....	5	<b>Using the Answering System</b> .....	<b>18</b>
Getting to Know Your Phone.....	6	Answering System Options ( <i>Ans. Setup</i> ) ...	18
Using the Menus.....	10	Accessing the Answering System.....	18
Entering Text on Your Phone .....	11	Recording Your Personal Greeting.....	19
<b>Using Your Phone</b> .....	<b>12</b>	Getting Your Messages .....	20
Using Caller ID and Call Waiting.....	12	Using the System While You're Away from Home .....	21
Using the Phonebook.....	13	<b>Important Information</b> .....	<b>22</b>
<b>Using Special Features</b> .....	<b>14</b>	Solving Problems.....	22
Using Text-To-Speech .....	14	Resetting Stations .....	24
Adjusting the Base Visual Ringer .....	15	Registering a Handset.....	24
Using the Audio Boost.....	15	Compliance Information .....	25
Silent Mode.....	15	One-year Limited Warranty.....	27
Using Multi-Station Features .....	15		
Using Voice Message Notification.....	17		

## Important Safety Instructions!

When using your telephone equipment, basic safety precautions should always be followed to reduce the risk of fire, electric shock and injury to persons, including the following:

- ◆ **This unit is NOT waterproof.** DO NOT expose it to rain or moisture.
- ◆ Do not use this product near water, for example, near a bath tub, wash bowl, kitchen sink or laundry tub, in a wet basement or near a swimming pool.
- ◆ Avoid using a telephone (other than a cordless type) during an electrical storm. There may be a remote risk of electric shock from lightning.
- ◆ Do not use the telephone to report a gas leak in the vicinity of the leak.
- ◆ Use only the power cord and batteries indicated in this manual. Do not dispose of batteries in a fire. They may explode. Check with local codes for possible special disposal instructions.
- ◆ Do not place the handset in any charging cradle without the battery installed and the battery cover securely in place.

### SAVE THESE INSTRUCTIONS!

**CAUTION! Risk of explosion if battery is replaced by an incorrect type! Dispose of used batteries according to the instructions. Do not open or mutilate the battery. Disconnect the battery before shipping this product.**

For more details, see the *Important Information* section.

# GETTING STARTED

## Set Up the Base

### Attach the Stand

For desktop use

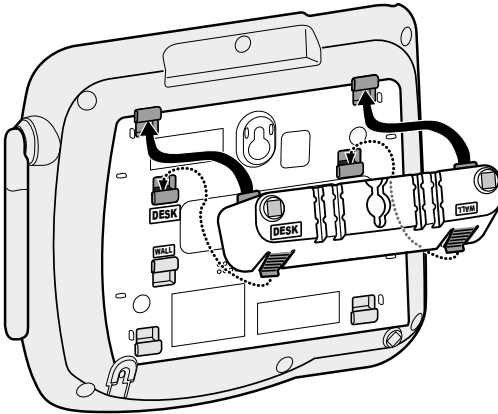

1. Turn the stand so the word **DESK** is right-side up (it will be on the left).
2. Insert the tabs into the notches at the top of the base.
3. Press in on the latches and slip them into the notches marked **DESK**.

For wall mount use

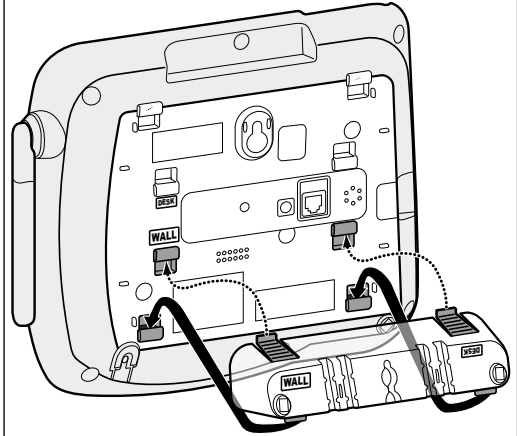

1. Turn the stand so the word **WALL** is right-side up (it will be on the left).
2. Insert the tabs into the notches at the bottom of the base.
3. Press in on the latches and slip them into the notches marked **WALL**.

### Remove the Stand

Press in on the latches and slide them out of the notches.

### Connect the Corded Handset

Use the coiled cord to connect the corded handset to the connector on the left side of the base.

#### For wall mount use only

1. On the front of the base, slide the clip out of its slot.
2. Rotate the clip 180 degrees.
3. Flip it from front to back and slide it back into the slot.

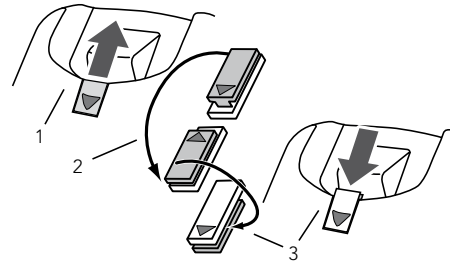

## Connect the Power and Telephone Cords

1. Connect the base AC adapter to the power jack and the telephone cord to the **TEL LINE** jack. Route the cords as shown below:

### For desktop use

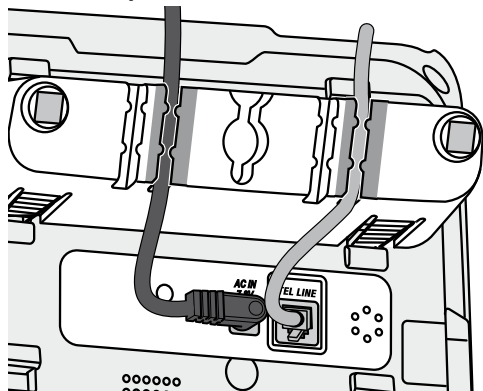

### For wall mount use

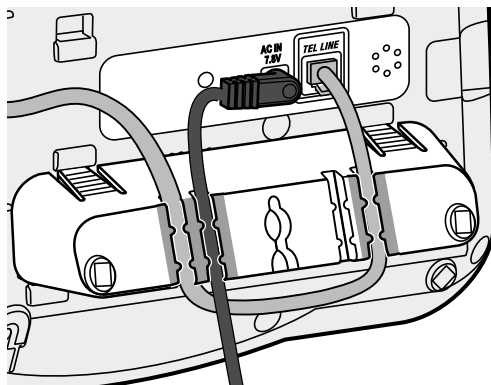

2. Plug the AC adapter into a standard 120 V AC power outlet, and connect the telephone cord to a standard telephone wall jack.
3. If you are mounting the phone on the wall, place the mounting slots over the pins on the wall plate, and slide the base down to lock it into place.

## Test the Connection

Pick up the corded handset from the base. You should hear a dial tone and the display on the base should say *Talk*. When you get a dial tone, make a quick test call.

If...	Try...
the display says <i>Check Tel Line</i> or you don't hear a dial tone	checking the connection between the base and the phone jack.
you keep hearing a dial tone	changing to pulse dialing.

## Changing from Tone to Pulse Dialing

Your phone uses tone dialing by default. If your phone company uses pulse dialing, you need to change your phone's dial mode.

1. Press **SELECT/MENU** and select *Global Setup* (see p. 10 for using the menus).
2. Select *Dial mode*, then *Pulse*. You'll hear a confirmation tone.

To send DTMF tones during a call (e.g., for an automated response system), press **\*** to temporarily switch to tone dialing. When you hang up, the phone automatically returns to pulse dialing.

# Set Up the Accessory Handset(s)

## Install and Charge the Battery

1. Unpack all handsets, battery packs, and battery covers. If any handset has the battery cover already attached, press in on the notch and slide the cover down and off.
  2. Line up the battery pack connector with the jack inside the handset. (The battery connector will only fit one way.)
  3. Push the battery pack connector in until it clicks into place. Tug gently on the wires to make sure the battery pack is securely connected.
  4. Place the batter cover and slide it up into place.
  5. Use an AC adapter to connect the power jack on each charger to a regular indoor (120V AC) power outlet.
  6. Place each handset in a charger with the display facing forward. If the **CHARGE** light on the charger doesn't light up, reseal the handset or connect the charger to a different outlet.
- 🔊 **Charge all handsets completely (about 15 hours) before using them.**

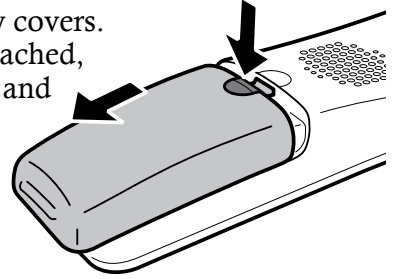

## Test the Connection

Pick up each handset and press **TALK/END**. You should hear a dial tone, and the display should say *Talk*. (Press **TALK/END** again to hang up.)

If there is noise or static, see p. 22 for tips on avoiding interference.

# Getting to Know Your Phone

## Parts of the Base

If the key name is spelled out on the key itself, it's not labeled in the drawing.

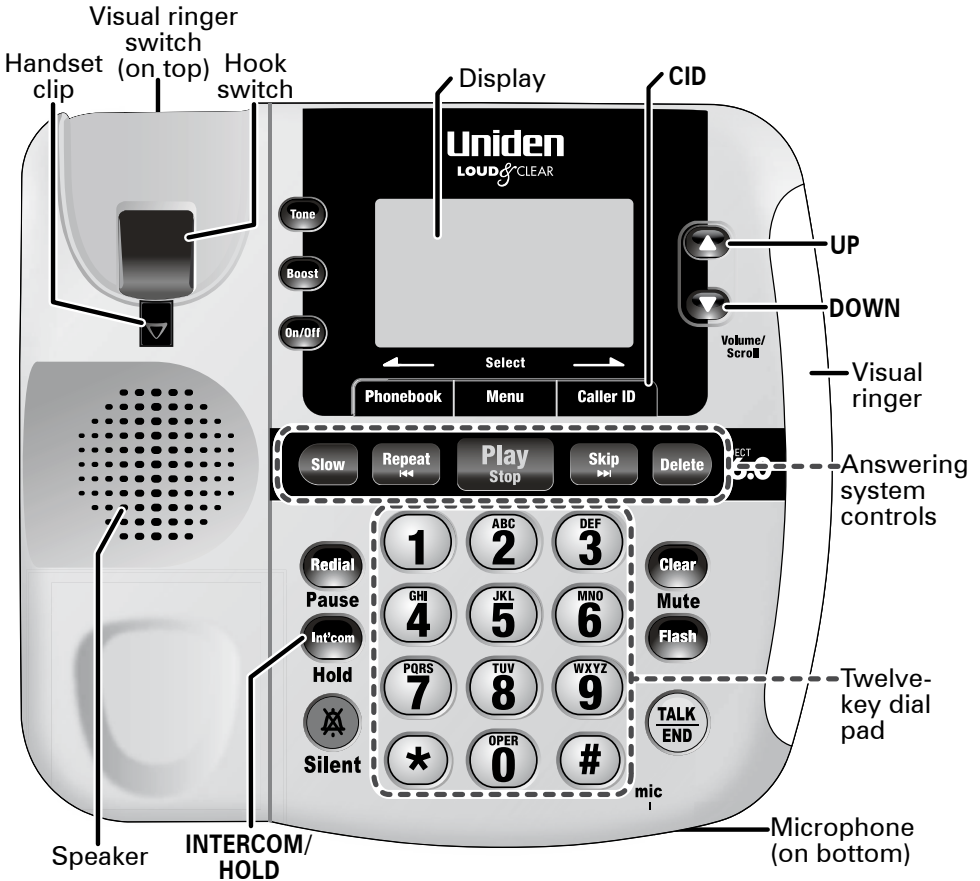

Key (icon)	What it does
<b>ON/OFF</b>	• In standby: turn the answering system on or off.
<b>SLOW</b>	• Reduce the speed of the answering system playback by 30%.
<b>REPEAT (K&lt;&lt;)</b>	• In the first 2 seconds of a message: go to the previous message. • Anytime after that: go back to the beginning of this message.
<b>PLAY/STOP</b>	• In standby: start playing new messages. • While a message is playing: stop playing messages.
<b>SKIP (&gt;&gt;I)</b>	• While a message is playing: skip to the next message.
<b>DELETE</b>	• In standby: delete all messages. • While a message is playing: delete this message.

Key (icon)	What it does
<b>INTERCOM/HOLD</b>	<ul style="list-style-type: none"> <li>• In standby: page a handset using the intercom.</li> <li>• During a call: put the call on hold and start a call transfer.</li> </ul>
<b>SILENT (📵)</b>	<ul style="list-style-type: none"> <li>• In standby: turn the Silent Mode on or off (see p. 15).</li> </ul>
<b>CLEAR/MUTE</b>	<ul style="list-style-type: none"> <li>• While the phone is ringing: ignore this call (mute the ringer).</li> <li>• During a call: mute the microphone.</li> <li>• While entering text: delete the last character, or press and hold to delete all the characters.</li> </ul>
<b>FLASH</b>	<ul style="list-style-type: none"> <li>• During a call: switch to a waiting call.</li> </ul>
<b>TALK/END</b>	<ul style="list-style-type: none"> <li>• In standby: start a speakerphone call (get a dial tone).</li> <li>• During a normal call: switch to the speakerphone.</li> <li>• During a speakerphone call: hang up.</li> </ul>

## Common Operation Keys

These keys work the same way on the base and the handset.

Key (icon)	What it does
<b>SELECT/MENU</b>	<ul style="list-style-type: none"> <li>• In standby: open the menu.</li> <li>• In any menu or list: select the highlighted item.</li> </ul>
<b>CID</b>	<ul style="list-style-type: none"> <li>• In standby or during a call: open the Caller ID list.</li> <li>• When entering text: move the cursor to the right.</li> </ul>
<b>PHONEBOOK</b>	<ul style="list-style-type: none"> <li>• In standby or during a call: open the phonebook.</li> <li>• In the menu: go back to the previous screen.</li> <li>• When entering text: move the cursor to the left.</li> </ul>
<b>UP (▲)</b>	<ul style="list-style-type: none"> <li>• In standby: increase the ringer volume.</li> <li>• During a call or while a message is playing: increase the volume.</li> <li>• In any menu or list: move the cursor up one line.</li> </ul>
<b>DOWN (▼)</b>	<ul style="list-style-type: none"> <li>• In standby: decrease the ringer volume.</li> <li>• During a call or while a message is playing: decrease the volume.</li> <li>• In any menu or list: move the cursor down one line.</li> </ul>
<b>REDIAL/PAUSE</b>	<ul style="list-style-type: none"> <li>• In standby: open the redial list.</li> <li>• During a phone number entry: insert a two-second pause.</li> </ul>
<b>TONE</b>	<ul style="list-style-type: none"> <li>• During a call: adjust the audio tone (see p. 22).</li> </ul>
<b>BOOST</b>	<ul style="list-style-type: none"> <li>• During a call: boost the volume of the earpiece (see p. 15).</li> </ul>

## Parts of the Handset

If the key name is spelled out on the key itself, it's not labeled in the drawing.

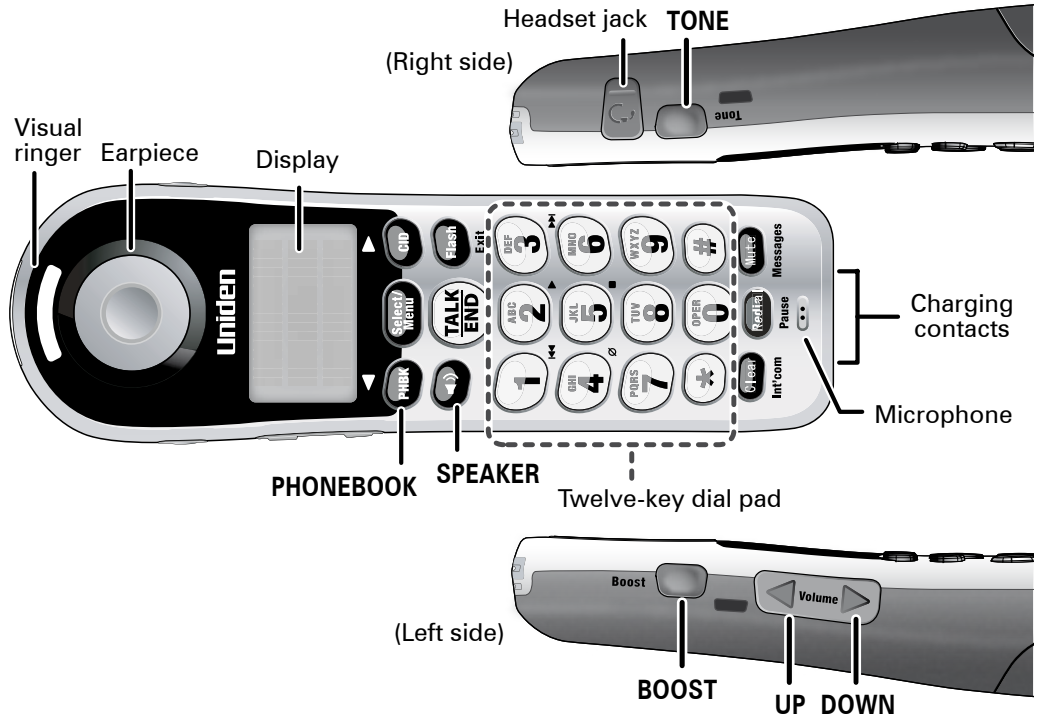

Key (icon)	What it does
<b>TALK/END</b>	
<b>FLASH/EXIT</b>	
<b>MUTE/MESSAGES</b>	
<b>SPEAKER</b>	
<b>CLEAR/INTERCOM</b>	



## Reading the Displays

### On the base

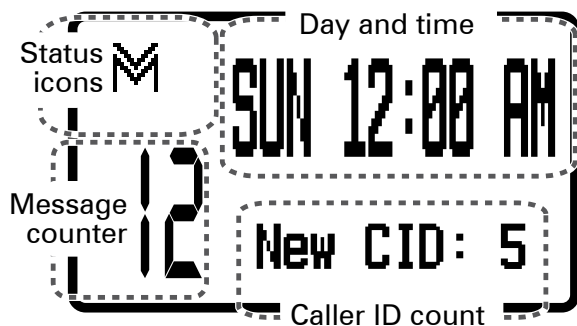

### On the handset

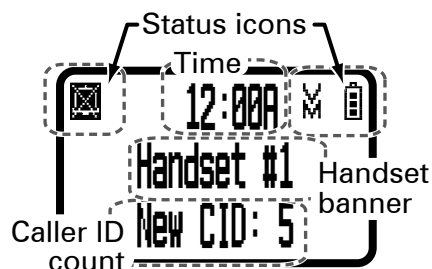

Icon	What it means
	The volume of the earpiece is boosted (see p. 15).
	The ringer is turned off: this station will not ring when a call comes in.
	You have a voice message waiting (see p. 17).
	Privacy Mode is on: no other station can use the line or join your call.
	The speakerphone is on.
	The microphone is muted, and the caller can't hear you.
<b>Icons you might see only on the base</b>	
	The answering system is turned off: the system will not answer the phone or take messages.
	The memory on the answering system is full: you need to delete some messages before the system can record any new ones.
	The answering system is set to Announce Only: the system will answer the phone, but it will not let callers leave a message.
<b>Icons you might see only on the handset</b>	
	T-coil mode is on (see p. 10).
	The battery is 1) fully charged, 2) half charged, 3) getting low, or 4) empty.

# Using the Menu

## Using the handset menus

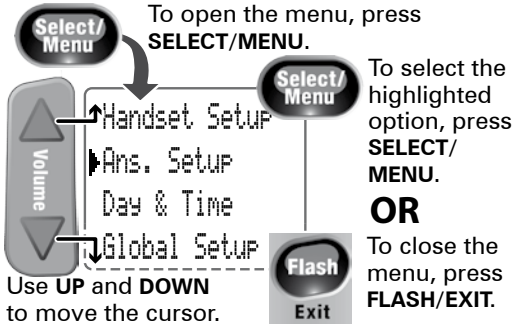

## Using the base menus

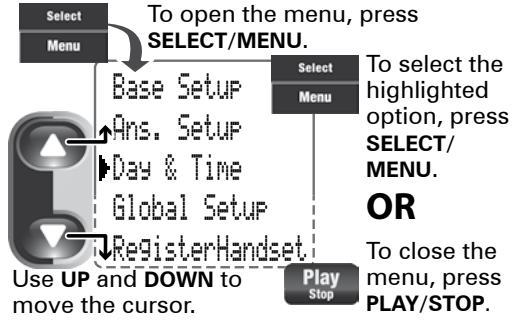

- ◆ The phone exits the menu after 30 seconds if no keys are pressed.
- ◆ Use **PHONEBOOK** during a call to back out of a menu without hanging up.

## Handset Setup / Base Setup Menu

You can change these settings separately for each station. The settings available on the base are *Ringer Tones*, *Base Language*, *Key Touch Tone*, *LCD Contrast*, and *TTS On/Off*.

Menu Option	What it does	Base
<i>T-coil</i>	Turn on T-coil mode to reduce noise on hearing aids equipped with a telecoil (T-coil) feature. T-coil mode shortens talk time, so keep your battery fully charged.	N/A
<i>Ringer Tones</i>	Choose this station's ring tone. As you highlight each ring tone, you hear a sample. To confirm, press <b>SELECT/MENU</b> .	<b>Yes</b>
<i>Personal Ring</i>	Turn on personal ring so you can assign a special ring tone to people in your phonebook. With Caller ID, this handset uses the assigned tone when the person calls.	N/A
<i>AutoTalk</i>	Have this handset answer a call when you pick it up from the cradle (without pressing any keys).	N/A
<i>Any Key Answer</i>	Have this handset answer a call when you press any key on the 12-key dialpad.	N/A
<i>Banner</i>	Change the name used on the handset's display.	N/A
<i>Handset / Base Language</i>	Change the display language.	<b>Yes</b>
<i>Key Touch Tone</i>	Have your keypad sound a tone when you press a key.	<b>Yes</b>
<i>LCD Contrast</i>	Choose the contrast of the display from ten different levels.	<b>Yes</b>
<i>TTS On/Off</i>	Turn on the Text-To-Speech (TTS) feature (see p. 14).	<b>Yes</b>

## Ans. Setup **Menu**

Refer to p. 18 for details on setting up your answering system.

## Day & Time **Menu**

You need to set the clock so messages get the correct time stamp. Select the day of the week, then enter the hour and minutes. Then select *AM* or *PM*. Use **CID** to move the cursor past a digit without changing it. To confirm, press **SELECT/MENU**.

## Global Setup **Menu**

The settings on this menu affect all the handsets and the base. Only one station at a time can change these settings.

Menu Option	What it does
<i>Area Code</i>	Enter, edit, or delete your area code so the phone hides the area code on incoming local calls (see p. 13).
<i>Dial Mode</i>	Choose tone or pulse dialing (see p. 4).
<i>Set Line Mode</i>	Do not change this setting unless instructed to by customer service.
<i>VMWI Reset</i>	(Base only) Reset the Voice Message Waiting Indicator (see p. 17).

## Register Handset **Menu (Base Only)**

This menu puts the base in registration mode (see p. 24).

## Entering Text on Your Phone

- ◆ Use the 12-key dial pad anytime you want to enter text into your phone (a name in the phonebook, the handset banner, etc.).
- ◆ If two letters in a row use the same key, enter the first letter, then use **CID** to move to the next space and enter the second letter.

To...	Press...	To...	Press...
move the cursor left	<b>PHONEBOOK.</b>	move the cursor right	<b>CID.</b>
erase the character at the cursor	<b>CLEAR. *</b>	erase the entire entry	and hold <b>CLEAR. *</b>
switch between upper and lower case letters	<b>*</b> .	enter a blank space	<b>POUND (#).</b>
		enter a symbol	<b>0</b> repeatedly.

\* **CLEAR/INTERCOM** on the handset or **CLEAR/MUTE** on the base.

# USING YOUR PHONE

To...	From the base		From a cordless handset	
	Corded Handset	Speaker	Earpiece	Speaker
make a call, dial the number, then	Pick up the handset.	Press <b>TALK/END.</b>	Press <b>TALK/END.</b>	Press <b>SPEAKER.</b>
answer a call	Pick up the handset.	Press <b>TALK/END.</b>	Press <b>TALK/END.</b>	Press <b>SPEAKER.</b>
hang up	Place the handset in the cradle.	Press <b>TALK/END.</b>	Press <b>TALK/END</b> or place the handset in the cradle.	
ignore the call (mute the ringer)	Press <b>CLEAR/MUTE</b> while the phone is ringing.		Press <b>MUTE/MESSAGES</b> while the phone is ringing.	
switch to/from the speaker	Press <b>TALK/END.</b>	Pick up the handset.	Press <b>SPEAKER.</b>	
mute the microphone	Press <b>CLEAR/MUTE.</b>		Press <b>MUTE/MESSAGES.</b>	
	Press again to turn the microphone back on.			
put a call on hold	Press <b>INTERCOM/HOLD. *</b>		Press <b>CLEAR/INTERCOM. *</b>	
return to a call on hold	Pick up the handset or press <b>TALK/END.</b>	Press <b>TALK/END.</b>	Press <b>TALK/END.</b>	Press <b>SPEAKER.</b>

\* After 5 minutes on hold, the call will be disconnected.

## Changing the Volume

You can adjust each station's volume independently. Press **UP** or **DOWN** to increase or decrease the earpiece or speaker volume when you are on a call. You can adjust the ringer volume only when the phone is in standby. Turning the ringer volume all the way down turns off the ringer.

 **If you want to change the volume of Caller ID announcements, change the ringer volume.**

## Using Caller ID and Call Waiting

Caller ID (CID) is a service available from your telephone provider that shows the phone number (and sometimes the caller's name) of incoming calls; if you turned on Text-To-Speech, it also announces the name. Contact your telephone provider for more information.

Caller ID list	Redial list
<ul style="list-style-type: none"> <li>• The phone saves the information for the last 30 received calls to the <i>CID list</i>. An asterisk ( * ) marks any calls received since the last time you checked the list.</li> <li>• In standby, all stations show how many calls came in since the last time you checked the CID list.</li> </ul>	<ul style="list-style-type: none"> <li>• Each station remembers the last 5 numbers you dialed on it.</li> </ul>

To...	Press...
open the CID list	<b>CID.</b>
open the redial list	<b>REDIAL/PAUSE.</b>
scroll through the lists	<b>DOWN</b> to scroll from newest to oldest. <b>UP</b> to scroll from oldest to newest.
dial the current number	<b>TALK/END</b> or <b>SPEAKER</b> on the handset. Pick up the corded handset on the base.
add other digits or codes at the front of CID number	<b>*</b> to add 1 for a toll call. <b>#</b> to add (or remove) the area code.
delete the current number	<b>SELECT/MENU</b> , then select <i>Delete Entry</i> .
add the current number to this station's phonebook.	<b>SELECT/MENU</b> , then select <i>Store Into Pb</i> . The phone displays the <i>Edit Name</i> screen (see p. 14).
close the lists	<b>PHONEBOOK.</b>

### Deleting All Numbers in the CID List on This Station

With the phone in standby, open the CID list. Press **SELECT/MENU** and select *Delete All*. When the phone prompts you to confirm, select *Yes*.

### Using Call Waiting

If you get a Call Waiting call, the phone can sound a tone and display any CID information received for the waiting call. Press **FLASH (FLASH/EXIT** on a cordless handset) to switch between your current call and the waiting call; remember, each time you switch, there is a short pause before you're connected to the other caller.

### Using the Phonebook

Each station can store up to 70 entries in its phonebook.

To...	Press...
open/close the phonebook	<b>PHONEBOOK.</b>
scroll through the entries	<b>DOWN</b> to scroll through the entries from A to Z. <b>UP</b> to scroll from Z to A.
jump to entries that start with a certain letter	the number key corresponding to the letter you want.
dial the current entry	<b>TALK/END</b> or <b>SPEAKER</b> on the handset. Pick up the corded handset on the base.
edit the current entry	<b>SELECT/MENU</b> , then select <i>Edit</i> .
copy the current entry to another station.	<b>SELECT/MENU</b> , then select <i>Copy</i> . Select the station you want to copy to.
delete the current entry	<b>SELECT/MENU</b> , then select <i>Delete</i> . To confirm, select <i>Yes</i> .

## Adding Phonebook Entries

With the phone in standby, open the phonebook. Press **SELECT/MENU** and select *Create New*. Enter a name and number; cordless handsets also prompt you to choose a personal ring.

- ◆ Enter the phone number (up to 20 digits) exactly as you would dial it.
- ◆ If you need to enter a pause between the numbers, press **REDIAL/PAUSE**; you'll see *P* in the display. (The dialing will pause for about 2 seconds per a digit.)
- ◆ To edit the number, press **CLEAR** to back up the cursor and delete numbers. Re-enter the correct numbers.

## Copying/Deleting All the Phonebook Entries

With the phone in standby, open the phonebook. Press **SELECT/MENU**.

- ◆ To copy all entries, select *Copy All*, and then select the station.
- ◆ To delete all entries, select *Delete All*. To confirm, select *Yes*.

## Chain Dialing

If you often have to enter a series of digits or a code number during a call, you can save that code number as a regular phonebook entry and use the phonebook to send the code number.

1. Make your call normally. When you hear the prompt that asks you to enter your code number, open the phonebook and find the entry.
2. Press **SELECT/MENU** to send the code. If you change your mind, just close the phonebook.

# USING SPECIAL FEATURES

## Using Text-To-Speech

With the Text To Speech (TTS) feature, your phone can announce phone numbers or names in several different situations.

When you... (from standby)	The phone announces...
receive a call	the caller's name (if sent by a CID service)
dial a number	the phone number you dialed
open the phonebook	the name of the entry you are looking at

- ◆ You have to turn on TTS separately for each station (see p. 10).
- ◆ To change the volume of CID announcements, change the ringer volume. To change the volume for all other TTS features, change the speaker volume.
- ◆ To make sure it doesn't interrupt a call or an intercom page, the phone only uses TTS when it starts out in standby.
- ◆ The TTS feature only uses English, regardless of the language for the display or the answering system prompts.

- ◆ It takes at least 2 rings for the phone to receive CID information and announce it. If the phone is answered before the end of the second ring, the phone won't announce the name of the caller.

## Adjusting the Base Visual Ringer

You can change the brightness of the base visual ringer. The **VISUAL RINGER** switch is at the top of the base (above the cradle). Slide the switch to **HIGH**, **LOW**, or **OFF**. (It doesn't affect the audio ringers.)

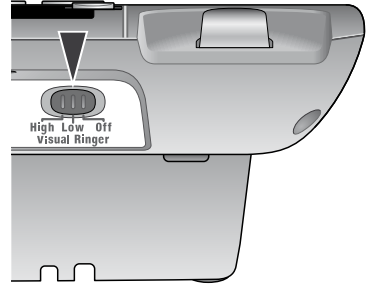

## Using the Audio Boost

You can increase the earpiece volume for normal calls and intercom calls. During a call, press **BOOST**. Press **BOOST** again to turn off.

## Silent Mode

- ◆ You can silence the ringers on the base and all handsets at the same time. It doesn't affect the visual ringers.
- ◆ With the phone in standby, press and hold **SILENT** on the base. The phone automatically turns on the answering system and shows *Do Not Disturb* in the display on each station. (The answering system answers any incoming calls without playing anything through the speaker.)
- ◆ To cancel, press **SILENT** again.
- ✂ **If you turn the answering system off while Silent Mode is on, the phone turns off Silent Mode.**

## Using Multi-Station Features

✂ **To use the features in this section, you need at least 1 cordless handset.**

### Expanding Your Phone

- ◆ Your base supports a total of six cordless handsets, including any that came with your phone.
- ◆ You must register accessory handsets to the base before using them. Handsets that aren't registered display a "not registered" message. For registration instructions, see p. 24, or the accessory handset manual.

### Using Conference Calling

- ◆ When an outside call comes in, the base and two cordless handsets can join in a conference call with the outside caller.
- ◆ To join the call, just pick up the corded handset from the base or press **TALK/END** on a cordless handset. To leave the conference call, hang up normally; the other station remains connected to the call.

## Using Privacy Mode

- ◆ To activate Privacy Mode on a call in progress, press **SELECT/MENU** twice. As long as privacy mode is on, no other handsets can join your call.
- ◆ Privacy Mode turns off automatically when you hang up or put the call on hold; you can also turn it off by pressing **SELECT/MENU** twice again.
- ◆ To use privacy mode during a conference call, wait until all stations have joined the call before turning on Privacy Mode. If a station disconnects, that station cannot rejoin the call as long as Privacy Mode remains on.

## Call Transfer

To...	From the base	From a cordless handset
transfer a call	1. Press <b>INTERCOM/HOLD</b> . 2. The phone puts the call on hold. Select the station you want to page, or <i>All</i> to page all stations. When the other station accepts the call, you'll be disconnected, but you can join the call again.	1. Press <b>CLEAR/INTERCOM</b> .
cancel a transfer	Press <b>TALK/END</b> .	Press <b>TALK/END</b> .
accept a transferred call	1. To answer the page and speak to the transferring station, pick up the corded handset. 2. To accept the call, press <b>TALK/END</b> .	press <b>CLEAR/INTERCOM</b> .

## Intercom

- ◆ Whenever the phone is in standby, you can make an intercom call between stations without using the phone line.
- ◆ You can make an intercom call from any station, but only two stations can be in an intercom call at any time.
- ◆ If an outside call comes in during an intercom page, the phone cancels the page so you can answer the incoming call.
- ◆ If an outside call comes in during an intercom call, press **TALK/END** to hang up the intercom call and answer the outside call.

To...	From the base	From a cordless handset
make an intercom page	1. Press <b>INTERCOM/HOLD</b> . 2. Select the station you want to talk with, or <i>All</i> to page all stations.	1. Press <b>CLEAR/INTERCOM</b> .
cancel a page	Press <b>INTERCOM/HOLD</b> .	Press <b>FLASH/EXIT</b> .
answer an intercom page	Press <b>INTERCOM/HOLD</b> or pick up the handset.	Press <b>CLEAR/INTERCOM</b> or <b>TALK/END</b> .
leave an intercom call	Press <b>INTERCOM/HOLD</b> .	Press <b>FLASH/EXIT</b> .



## Finding a Lost Handset

You can use the intercom page to find a lost handset. When the intercom tone sounds, you can track the tone to the lost handset.

## Using Voice Message Notification

- ◆ If you subscribe to a voice mail service, your phone can notify you when you have a new message. This feature supports Frequency-Shift Keying (FSK) notification. Contact your voice mail provider for information.
- ◆ When you have new messages, the display shows a message icon. After you listen to your messages, the message icon turns off. If it doesn't, you can reset it. From the base, open the menu, and select *Global Setup*. Select *VMWI Reset*, and select *Yes*.

## Using an Optional Headset

You can use a standard 2.5 mm telephone headset with your cordless handsets.

- ◆ To install a headset, remove the headset jack cover and insert the headset plug into the jack.
- ◆ Just make and receive calls as usual, and use your headset to talk to the caller after the call connects.
- ◆ While you connect a headset, the handset automatically mutes the earpiece.

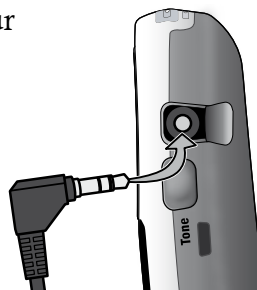

## Using Your Phone During a Power Failure

If there is a power failure, you can still make and receive phone calls using the base corded handset, including Call Waiting calls and changing the earpiece volume. All other features of the base and all cordless handsets will not function.

- 🔇 **While the power is out, the base uses a special ringer; you cannot adjust the volume of this ringer.**

# USING THE ANSWERING SYSTEM

## Answering System Options (*Ans. Setup*)

You can change the answering system options from any station. Just open the menu and select *Ans. Setup*.

Menu Option	What it does
<i>Record Greeting</i>	(Base only) Record an outgoing message (see p. 19)
<i>Greeting Options</i>	(Base only) Switch greetings or delete your greeting (see p. 19).
<i>Security Code</i>	Enter a 2-digit PIN so you can access your answering system from any touch-tone phone (see p. 21).
<i>Ring Time</i>	Set the number of rings (2, 4, or 6) before the system answers (see p. 21 about <i>Toll Saver</i> ).
<i>Record Time</i>	Set the amount of time (1 or 4 minutes) callers can leave a message. Choose <i>Announce Only</i> if you don't want the system to let callers leave a message.
<i>Message Alert</i>	Have the base beep every 15 seconds when you have a new message. The alert stops after you listen to all your new messages or if you press any key on the base.
<i>Ans. Language</i>	Change the language of the system's voice prompts.
<i>Call Screen</i>	Turn on the call screen feature so you can hear callers as they leave messages on the base speaker (see p. 20).
<i>Ans. On/Off</i>	(Handset only) Turn your answering system on or off. (To turn your system on or off from the base, just press <b>ON/OFF</b> .)

## Accessing the Answering System

With the phone in standby, you can access your system from the base or remotely from any handset.

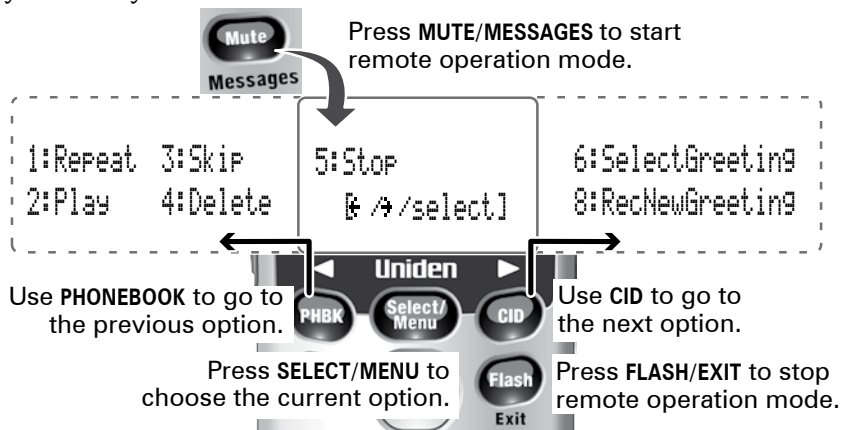

- ◆ Only 1 station can access the system at a time.
- ◆ During remote access:
  - The system beeps so you know it's waiting for your next command.
  - You can press the number key shown next to each command instead of scrolling through the screens.
  - If you do nothing for 30 seconds, the phone returns to standby.

## Recording Your Personal Greeting

Your personal outgoing message or greeting can be between 2 seconds and 30 seconds long. If you don't want to record a greeting, the system uses the pre-recorded greeting: *Hello, no one is available to take your call. Please leave a message after the tone.*

From the base	From a cordless handset
<ol style="list-style-type: none"> <li>1. Open the menu and select <i>Ans. Setup</i>. Then select <i>Record Greeting</i>.</li> <li>2. Press <b>SELECT/MENU</b> again. Wait until the system says "Record greeting" before speaking.</li> <li>3. Press <b>PLAY/STOP</b> to stop recording. The system plays back your new greeting.</li> <li>4. To keep this greeting, press <b>PLAY/STOP</b>. To re-record it, go back to step 2.</li> </ol>	<ol style="list-style-type: none"> <li>1. Access the answering system. Wait until the system finishes its announcements, or press <b>5</b> (number key) to skip them.</li> <li>2. Press <b>8</b>. Wait until the system says "Record greeting" before speaking.</li> <li>3. Press <b>5</b> to stop recording. The system plays back your new greeting.</li> <li>4. To keep this greeting, press <b>FLASH/EXIT</b>. To re-record it, go back to step 2.</li> </ol>

## Switch Between Greetings

From the base	From a cordless handset
<ol style="list-style-type: none"> <li>1. Open the menu and select <i>Ans. Setup</i>. Then select <i>Greeting Options</i>.</li> <li>2. The system plays back the current greeting.</li> <li>3. Press <b>REPEAT</b> or <b>SKIP</b> to switch greetings.</li> </ol>	<ol style="list-style-type: none"> <li>1. Access the answering system. Wait until the system finishes its announcements, or press <b>5</b> (number key) to skip them.</li> <li>2. Press <b>6</b> to play back the current greeting.</li> <li>3. Press <b>6</b> again to switch greetings.</li> </ol>

## Delete Your Greeting

Switch to your personal greeting; press **DELETE** on the base or **4** (number key) on the handset while the greeting is playing.

## Getting Your Messages

To...	From the base	From a handset
play new messages	Press <b>PLAY/STOP</b> . The system announces the number of new and old messages, then plays each new message (followed by the day and time if set) in the order it was received.	Press <b>MUTE/MESSAGES</b> .
restart this message	Wait at least 5 seconds after the message starts playing, press <b>REPEAT</b> .	select <i>1:Repeat</i> .
replay an earlier messages	Within 2 seconds after a message starts playing, press <b>REPEAT</b> .	select <i>1:Repeat</i> .
skip a message	Press <b>SKIP</b> .	Select <i>3:Skip</i> .
slow down message playback	Press <b>SLOW</b> . Press again to return to normal playback speed.	Not available.
delete a message	While the message is playing, press <b>DELETE</b> .	select <i>4&gt;Delete</i>
delete all messages	With the phone in standby, press <b>DELETE</b> ; press <b>DELETE</b> again to confirm.	Not available.
play old messages	After the system plays the new messages, press <b>PLAY/STOP</b> again.	select <i>2:Play</i> .
stop playback	Press <b>PLAY/STOP</b> .	Select <i>5:Stop</i> .

## Screening Your Calls

You can use the answering system for *call screening*. While the system takes a message, you can listen on the base speaker (if you turn on *Call Screen*) or from a handset. Only one handset can screen calls at a time. If another handset tries to screen the call, it beeps and returns to standby.

To...	From the base	From a cordless handset
hear the caller leaving a message	Just listen to the caller over the speaker.	Press <b>MUTE/MESSAGES</b> .
answer the call	Pick up the corded handset.	Press <b>TALK/END</b> .
mute the call screen without answering	Press <b>CLEAR/MUTE</b> .	Press <b>FLASH/EXIT</b> or return the handset to the cradle.

- ◆ If you mute the call screen, the system continues taking the message: it just stops playing through the speaker.

## Using the System While You're Away from Home

You can also operate your answering system from any touch-tone phone. Before you can use this feature, you have to program a security code.

### Programming a Security Code

1. With the phone in standby, open the menu. Select *Ans. Setup*, then select *Security Code*.
2. Use the number keypad to enter a two-digit security code (01 to 99). Press **SELECT/MENU** when you're finished.

📎 **Remember to make a note of your new security code!**

### Dialing in to Your System

1. Call your telephone number and wait for the system to answer.
  - If you have the *Ring Time* set to *Toll Saver*, the system answers after 2 rings if you have new messages and 4 rings if you don't. You can hang up during the third ring.
  - If your answering system is off, it will answer after about 10 rings and sound a series of beeps instead of your greeting.
2. During the greeting (or beeps), press **0** and **immediately** enter your security code. (If you enter it incorrectly 3 times, the system hangs up and returns to standby.)
3. The system announces the time, the number of messages in memory, and a help prompt. It beeps intermittently to let you know it's waiting for a command.

4. When you hear beeping, enter a 2-digit command from the chart:

01	Repeat message	05	Stop playback
02	Play message	06	Turn the system on
03	Skip message	09	Turn the system off
04	Delete message	10	Hear help prompts

📎 **If you don't press any keys for 15 seconds, the phone will hang up and return to standby.**

# IMPORTANT INFORMATION

## Solving Problems

If you have any trouble with your phone, check this section first. If you need help, call our Customer Care Line listed on the front cover.

General problems	Possible solutions
No station can make or receive calls.	<ul style="list-style-type: none"> <li>• Check the telephone cord connection.</li> <li>• Disconnect the base AC adapter for a few minutes; then reconnect it.</li> </ul>
A handset can't make or receive calls.	<ul style="list-style-type: none"> <li>• Move the handset closer to the base.</li> </ul>
The corded handset can make calls but the cordless handset(s) cannot.	<ul style="list-style-type: none"> <li>• Check the power connection to the base. If the base is unplugged or the power goes out, only the corded handset can make and receive calls.</li> </ul>
A station can make calls, but it won't ring.	<ul style="list-style-type: none"> <li>• Make sure the ringer is turned on.</li> <li>• Make sure Silent Mode is turned off (see p. 15).</li> </ul>
A handset is not working.	<ul style="list-style-type: none"> <li>• Charge the battery for 15-20 hours.</li> <li>• Check the battery connection.</li> </ul>
The phone keeps ringing when I answer on an extension.	<ul style="list-style-type: none"> <li>• You may have to change the line mode. Contact Customer Service for instructions.</li> </ul>
Audio issues	Possible solutions
Callers sound weak or soft.	<ul style="list-style-type: none"> <li>• Move the handset closer to the base.</li> <li>• Keep the handset's battery fully charged.</li> <li>• Increase the earpiece volume.</li> </ul>
There's a lot of noise or static on the line	<ul style="list-style-type: none"> <li>• Check for interference from appliances (microwave ovens, TVs, etc.) or wireless devices (baby monitors, WiFi equipment, etc.). Move the handset or base away from the interference source.</li> <li>• Try to adjust the audio tone. During a call, press <b>TONE</b> to cycle through the three audio tone options: <i>Low Tone</i>, <i>Natural Tone</i> (recommended for hearing aid users), or <i>High Tone</i>. (The tone setting appears in the display as you do this.)</li> <li>• If you use a telecoil hearing aid, turn on T-coil mode (see p. 10).</li> <li>• If you have any service that uses the phone line, add a DSL or telephone line filter (see p. 23).</li> </ul>
Caller ID problems	Possible solutions
Caller ID information does not display.	<ul style="list-style-type: none"> <li>• Let calls ring twice before answering.</li> <li>• Make sure your Caller ID service is active.</li> </ul>

Caller ID problems	Possible solutions
Caller ID displays briefly and then clears.	<ul style="list-style-type: none"> <li>• You may have to change the line mode. Contact Customer Service for instructions.</li> </ul>
Caller ID displays, but I can't hear the CID announcements.	<ul style="list-style-type: none"> <li>• Making sure TTS (Text-To-Speech) is turned on.</li> <li>• Increasing the ringer volume so the CID announcements are louder.</li> </ul>
Multi-station problems	Possible solutions
I can't transfer calls.	<ul style="list-style-type: none"> <li>• Reset all the stations (see p. 24).</li> </ul>
Two handsets can't talk to a caller.	<ul style="list-style-type: none"> <li>• See if any station is in Privacy Mode.</li> </ul>
A handset says <i>Unavailable</i> .	<ul style="list-style-type: none"> <li>• Move the handset closer to the base.</li> <li>• See if any station is in Privacy Mode.</li> <li>• Reset the handset (see p. 24).</li> </ul>
I can't register a new handset.	<ul style="list-style-type: none"> <li>• Reset the handset (see p. 24).</li> <li>• See if you have 6 registered handsets.</li> </ul>
Answering system problems	Possible solutions
The answering system does not work.	<ul style="list-style-type: none"> <li>• Make sure the answering system is on.</li> <li>• Make sure the base is plugged in.</li> </ul>
The system won't record messages.	<ul style="list-style-type: none"> <li>• See if <i>Record Time</i> is set to <i>Announce Only</i>.</li> <li>• Delete messages (memory may be full).</li> </ul>
A handset can't access the answering system.	<ul style="list-style-type: none"> <li>• See if another handset is using the system.</li> <li>• Make sure the phone is in standby.</li> </ul>
My outgoing message is gone.	<ul style="list-style-type: none"> <li>• If there was a power failure, re-record your personal outgoing message.</li> </ul>
I can't hear the base speaker.	<ul style="list-style-type: none"> <li>• Make sure call screening is turned on.</li> <li>• Change the base speaker volume.</li> </ul>
Messages are incomplete.	<ul style="list-style-type: none"> <li>• Increase the <i>Record Time</i>.</li> <li>• Delete messages (memory may be full).</li> </ul>
The system keeps recording when I answer on an extension.	<ul style="list-style-type: none"> <li>• You may have to change the line mode. Contact Customer Service for instructions.</li> </ul>

## Installing a Line Filter or DSL Filter

A telephone line filter or DSL filter prevents services that use the phone line from causing interference on your phone. To get a line filter, contact your service provider or look in an electronics store.

Plug the filter into the telephone wall jack and plug the base into the filter. Make a test call to make sure the noise is gone.

## Liquid Damage

**CAUTION: If the base is covered in liquid, disconnect the adapter and phone cord from the wall before touching it.**

If the liquid is only on the exterior housing of the base or handset, wipe it off and use as normal. If you can hear liquid inside the housing:

1. Disconnect all cables and cords and remove all compartment covers.
2. If liquid is leaking from any vent or hole, turn the phone so that vent faces down. If not, place the largest vent face down.
3. Let dry for at least 3 days. Check for liquid inside the phone before replacing compartment covers and reconnecting cords.

## Resetting Stations

If you have problems with the base, unplug the base to reset it. Plug it back in after at least a minute.

If you have trouble with a cordless handset or if you want to replace one, reset it:

1. Press and hold **FLASH/EXIT** and **POUND (#)** at the same time until *System Reset* displays (about 5 seconds).
2. If you still have the base the handset is registered to, select *Deregister HS*, then select the handset you want to reset. If you don't have that base anymore, select *Base Unavailable*.
3. To confirm, select *Yes*. The handset displays *Handset not registered*.

## Registering a Handset

If you see a “not registered” message on a handset, you must register it to a base before using it.

1. On the base, open the menu and select *Register Handset*.
  2. On the handset, press and hold **POUND (#)** until the handset display says *Handset Registering* (about 2 seconds).
  3. Wait until the handset display says *Registration Complete* (about 30 seconds), then pick up the handset and press **TALK/END**.
- 🔇 If you don't hear a dial tone or the display says *Registration Failed*, charge the battery completely, then try again.**



## Adapter and Battery Information

AC adapter	Base	Charger
Part number	PS-0034	PS-0035
Input voltage	120V AC, 60 Hz	
Output voltage	7.8V AC @ 450mA	8V AC @ 300mA

- ◆ Use only the supplied AC adapters.
- ◆ Use the proper adapter for the base and any chargers.
- ◆ Do not place the unit in direct sunlight or subject it to high temperatures.

Battery pack (with normal use)	
Part number / Capacity	BT-1016 / 500mAh, 2.4V DC or BT-1025 / 400mAh, 2.4V DC
Talk time	about 10 hours
Standby time	about 7 days
Battery life	about 1 year

- ◆ Replace the battery when the talk or standby time becomes noticeably reduced. For replacements, call the Parts Department (see the front cover).
- ◆ If you hear a strange beep during a call, check the display. When the battery gets low, the handset shows a low battery alert; recharge the battery.

## Rechargeable Battery Warning

- ◆ This equipment contains a rechargeable Nickel-Metal-Hydride (Ni-MH) battery.
- ◆ Nickel is a chemical known to the state of California to cause cancer.
- ◆ Do not short-circuit the battery.
- ◆ The batteries in this equipment may explode if disposed of in a fire.

◆ Do not charge the batteries in any charger other than the one specified in the owner's manual. Using another charger may damage the battery or cause it to explode.

- ◆ As part of our commitment to protecting our environment and conserving natural resources, Uniden voluntarily participates in an RBRC® industry program to collect and recycle used Ni-MH batteries within the United States. Please call 1-800-8-BATTERY for information on Ni-MH battery recycling in your area. (RBRC® is a registered trademark of the Rechargeable Battery Recycling Corporation.)



**Rechargeable batteries must be recycled or disposed of properly.**

**Uniden works to reduce lead content in PVC coated cords in our products and accessories.**

**Warning! The cords on this product and/or accessories contain lead, a chemical known to the state of California to cause birth defects or other reproductive harm. Wash hands after handling.**

## Compliance Information

### FCC Part 68 Information

This equipment complies with Part 68 of the FCC rules and the requirements adopted by the ACTA. On the bottom of this equipment is a label that contains, among other information, a product identifier in the format US: AAAEQ##TXXXX. If requested, this number must be provided to the phone company.

An applicable Universal Service Order Codes (USOC) certification for the jacks used in this equipment is provided (i.e., RJ11C) in the packaging with each piece of approved terminal equipment. A plug and jack used to connect this equipment to the premises wiring and telephone network must comply with the applicable FCC Part 68 rules and requirements adopted by the ACTA. A compliant telephone cord and modular plug is provided with this product. It is designed to be connected to a compatible modular jack that is also compliant. See installation instructions for details.

The REN is used to determine the number of devices that may be connected to a phone line. Excessive RENs on a phone line may result in devices not ringing in response to an incoming call. In most but not all areas, the sum of RENs should not exceed five (5.0). To be certain of the number of devices that may be connected to a line, as determined by the total RENs, contact the telephone provider. The REN for this product is part of the product identifier that has the format US:AAAEQ##TXXXX. The digits represented by ## are the REN without a decimal point (e.g., 03 is a REN of 0.3).

If this equipment causes harm to the telephone network, the telephone company will notify you in advance that temporary discontinuance of service may be required. But if advance notice isn't practical, the telephone company will notify the customer as soon as possible. Also, you will be advised of your right to file a complaint with the FCC if you believe it is necessary. The telephone company may make changes in its facilities, equipment, operations or procedures that could affect the operation of the equipment. If this happens the telephone company will provide advance notice in order for you to make necessary modifications to maintain uninterrupted service.

Please follow instructions for repairing, if any (e.g. battery replacement section); otherwise do not substitute or repair any parts of the device except as specified in this manual. Connection to party line service is subject to state tariffs. Contact the state public utility

commission, public service commission or corporation commission for information.

This equipment is hearing aid compatible.

If you experience trouble with this equipment, contact the manufacturer (see the cover of this manual for contact information) or an authorized agent. If the equipment is causing harm to the telephone network, the telephone company may request that you disconnect the equipment until the problem is resolved.

If your home has wired alarm equipment connected to a phone line, be sure that installing the system does not disable your alarm equipment. If you have questions about what will disable alarm equipment, contact your telephone company or a qualified installer.

Any changes or modifications to this product not expressly approved by the manufacturer or other party responsible for compliance could void your authority to operate this product.

**NOTICE:** According to telephone company reports, AC electrical surges, typically resulting from lightning strikes, are very destructive to telephone equipment connected to AC power sources. To minimize damage from these types of surges, a surge arrester is recommended.

## FCC Part 15 Information

This device complies with part 15 of the FCC rules. Operation is subject to the following two conditions: (1) This device may not cause harmful interference, and (2) This device must accept any interference received, including interference that may cause undesired operation. Privacy of communications may not be ensured when using this phone.

**FCC PART 15.105(b):** Note: This equipment has been tested and found to comply with the limits for a Class B digital device, pursuant to part 15 of the FCC Rules. These limits are designed to provide reasonable protection against harmful interference in a residential installation. This equipment generates, uses and can radiate radio frequency energy and, if not installed and used in accordance with the instructions, may cause harmful interference to radio communications. However, there is

no guarantee that interference will not occur in a particular installation. If this equipment does cause harmful interference to radio or television reception, which can be determined by turning the equipment off and on, the user is encouraged to try to correct the interference by one or more of the following measures:

- Reorient or relocate the receiving antenna.
- Increase the separation between the equipment and receiver.
- Connect the equipment into an outlet on a circuit different from that to which the receiver is connected.
- Consult the dealer or an experienced radio/TV technician for help.

## RF exposure Information

This product complies with FCC radiation exposure limits under the following conditions:

- The base must be placed to allow a minimum of 20 cm (8 inches) between the antenna and all persons during normal operation.
- The base must not be collocated or operated in conjunction with any other antenna or transmitter.
- The handset is designed for body-worn operation and meets FCC RF exposure guidelines when used with any belt clip, carrying case, or other accessory supplied with this product. (All necessary accessories are included in the package; any additional or optional accessories are not required for compliance with the guidelines.) Third party accessories (unless approved by the manufacturer) should be avoided as these might not comply with FCC RF exposure guidelines.

## Industry Canada (I.C.) Notice

### *Terminal equipment*

NOTICE: This equipment meets the applicable Industry Canada Terminal Equipment Technical Specifications. This is confirmed by the registration number. The abbreviation *IC* before the registration number signifies that registration was performed based on a Declaration of

Conformity indicating that Industry Canada technical specifications were met. It does not imply that Industry Canada approved the equipment.

NOTICE: The Ringer Equivalence Number (REN) for this terminal equipment is marked on the equipment itself. The REN assigned to each terminal equipment provides an indication of the maximum number of terminals allowed to be connected to a telephone interface. The termination on an interface may consist of any combination of devices subject only to the requirement that the sum of the Ringer Equivalence Numbers of all the devices does not exceed 5.

### *Radio equipment*

The term *IC* before the radio certification number only signifies that Industry Canada technical specifications were met. Operation is subject to the following two conditions: (1) this device may not cause interference, and (2) this device must accept any interference, including interference that may cause undesired operation of the device. "Privacy of communications may not be ensured when using this telephone".

## One-year Limited Warranty

**Evidence of original purchase is required for warranty service.**

WARRANTOR: UNIDEN AMERICA CORPORATION ("Uniden")

ELEMENTS OF WARRANTY: Uniden warrants, for one year, to the original retail owner, this Uniden Product to be free from defects in materials and craftsmanship with only the limitations or exclusions set out below.

WARRANTY DURATION: This warranty to the original user shall terminate and be of no further effect 12 months after the date of original retail sale. The warranty is invalid if the Product is (A) damaged or not maintained as reasonable or necessary, (B) modified, altered, or used as part of any conversion kits, subassemblies, or any configurations not sold by Uniden, (C) improperly installed, (D) serviced or repaired by someone other than an authorized Uniden service center

for a defect or malfunction covered by this warranty, (E) used in any conjunction with equipment or parts or as part of any system not manufactured by Uniden, or (F) installed or programmed by anyone other than as detailed by the owner's manual for this product.

**STATEMENT OF REMEDY:** In the event that the product does not conform to this warranty at any time while this warranty is in effect, warrantor will either, at its option, repair or replace the defective unit and return it to you without charge for parts, service, or any other cost (except shipping and handling) incurred by warrantor or its representatives in connection with the performance of this warranty. Warrantor, at its option, may replace the unit with a new or refurbished unit. **THE LIMITED WARRANTY SET FORTH ABOVE IS THE SOLE AND ENTIRE WARRANTY PERTAINING TO THE PRODUCT AND IS IN LIEU OF AND EXCLUDES ALL OTHER WARRANTIES OF ANY NATURE WHATSOEVER, WHETHER EXPRESS, IMPLIED OR ARISING BY OPERATION OF LAW, INCLUDING, BUT NOT LIMITED TO ANY IMPLIED WARRANTIES OF MERCHANTABILITY OR FITNESS FOR A PARTICULAR PURPOSE. THIS WARRANTY DOES NOT COVER OR PROVIDE FOR THE REIMBURSEMENT OR PAYMENT OF INCIDENTAL OR CONSEQUENTIAL DAMAGES.** Some states do not allow this exclusion or limitation of incidental or consequential damages so the above limitation or exclusion may not apply to you.

**LEGAL REMEDIES:** This warranty gives you specific legal rights, and you may also have other rights which vary from state to state. This warranty is void outside the United States of America and Canada.

**PROCEDURE FOR OBTAINING PERFORMANCE OF WARRANTY:** If, after following the instructions in the owner's manual you are certain that the Product is defective, pack the Product carefully (preferably in its original packaging). Disconnect the battery from the Product

and separately secure the battery in its own separate packaging within the shipping carton. The Product should include all parts and accessories originally packaged with the Product. Include evidence of original purchase and a note describing the defect that has caused you to return it. The Product should be shipped freight prepaid, by traceable means, to warrantor at:

Uniden America Service  
4700 Amon Carter Blvd.  
Fort Worth, TX 76155

As an Energy Star<sup>®</sup> Partner, Uniden has determined that this product meets the Energy Star<sup>®</sup> guidelines for energy efficiency. Energy Star<sup>®</sup> is a U.S. registered mark.



- Uniden<sup>®</sup> is a registered trademark of Uniden America Corporation.
- Call waiting, CID, CIDCW, and Voice Mail are telephone line services. Your phone supports these services, but you have to arrange for them through your telephone provider. Contact your provider for details.
- The pictures in this manual are for example only. Your phone may not look exactly like the pictures.

## Free Manuals Download Website

<http://myh66.com>

<http://usermanuals.us>

<http://www.somanuals.com>

<http://www.4manuals.cc>

<http://www.manual-lib.com>

<http://www.404manual.com>

<http://www.luxmanual.com>

<http://aubethermostatmanual.com>

Golf course search by state

<http://golfingnear.com>

Email search by domain

<http://emailbydomain.com>

Auto manuals search

<http://auto.somanuals.com>

TV manuals search

<http://tv.somanuals.com>