



Uniden[®]

**DECT Elite 9035
DECT Elite 9035+1
DECT Elite 9035+2**



OWNER'S MANUAL

Table of Contents

| | | | |
|---------------------------------------------------------------|-----------|---------------------------------------------------------------|-----------|
| Welcome | 4 | Manual Conventions | 16 |
| Installing the Phone | 5 | Parts of the Handset | 17 |
| Choosing the Best Location | 5 | Parts of the Base | 18 |
| Installing the Battery | 6 | Using the Interface | 19 |
| Connecting the AC adapter..... | 7 | Reading the Handset Display | 19 |
| To the base | 7 | Using the Four-way Function Key..... | 20 |
| To the charging cradle (for multi-handset packs only)..... | 7 | Using the Handset Menu | 20 |
| Charging the Handset | 8 | Entering Text from Your Handset | 21 |
| Connecting to the Phone Line..... | 9 | Basic Setup | 22 |
| Testing the Connection | 10 | Setting the Day & Time | 22 |
| Installing the Belt Clip | 11 | Activating Personal Settings | 22 |
| Expanding Your Phone | 12 | Activating the Key Touch Tone | 23 |
| Adding accessory handsets | 12 | Insert 0 | 23 |
| Registering accessory handsets | 12 | Setting Up the Phonebook | 24 |
| Using Multiple Bases | 13 | Creating Phonebook Entries | 24 |
| Registering the handset to another base | 13 | Finding a Phonebook Entry..... | 25 |
| Selecting the base | 14 | Editing an Existing Phonebook Entry | 26 |
| Getting to Know Your New Phone | 15 | Storing Caller ID or Redial Numbers in the Phonebook | 26 |
| Features..... | 15 | Deleting a Single Phonebook Entry | 26 |
| Answering system features | 15 | Deleting all Phonebook Entries..... | 27 |
| Terminology Used in this Manual | 16 | Copying Phonebook Entries to Another Handset.... | 27 |

| | | | |
|--------------------------------------------------------------|-----------|--------------------------------------------------|-----------|
| Customizing Your Handsets | 28 | Adjusting the Earpiece Volume | 36 |
| Changing the Handset Banner..... | 28 | Adjusting the Speaker Volume..... | 37 |
| Selecting a Ringer Tone..... | 28 | Adjusting the Audio Tone | 37 |
| Activating AutoTalk..... | 29 | Finding a Lost Handset | 38 |
| Activating Any Key Answer | 29 | Using Hold, Conference and Transfer | 38 |
| Color Scheme | 29 | Placing a Call on Hold..... | 38 |
| Wallpaper..... | 30 | Conferencing..... | 38 |
| Activating the Handset Keypad Lock | 30 | Transferring a Call..... | 39 |
| Using Your Phone | 31 | Answering a transferred call | 39 |
| Making a Call from the Phonebook..... | 32 | Using Special Features | 40 |
| Chain dialing from the phonebook..... | 32 | Privacy Mode | 40 |
| Switching to the Handset Speakerphone | | Using the Intercom..... | 40 |
| During a Call..... | 32 | Making an intercom page | 40 |
| Using Caller ID, Call Waiting, and Redial Lists | 33 | Answering an intercom page..... | 41 |
| Using the Caller ID List | 33 | Muting the Microphone | 41 |
| Making a Call from a Caller ID Record | 33 | Installing the Optional Headset..... | 42 |
| Deleting Caller ID Numbers | 34 | Setting Up the Answering System | 43 |
| Using Call Waiting | 34 | Recording a Personal Greeting..... | 43 |
| Redialing a Number | 35 | Selecting a Greeting | 43 |
| Deleting a Redial Record | 35 | Deleting Your Personal Greeting..... | 44 |
| Adjusting the Ringer, Earpiece and | | Setting the Number of Rings..... | 45 |
| Speaker Volume | 36 | Setting the Record Time (or Announce only) | 45 |
| Adjusting the Ringer Volume..... | 36 | Activating the Message Alert..... | 46 |
| Muting the Ringer (One call only) | 36 | | |

| | | | |
|----------------------------------------------------|-----------|-------------------------------------------|-----------|
| Activating the Base Call Screen..... | 46 | Traveling Out of Range..... | 57 |
| Using the Answering System | 47 | Liquid Damage..... | 58 |
| Turning Your Answering System On and Off..... | 47 | Precautions! | 59 |
| Reviewing Messages..... | 48 | Rechargeable Nickel-Metal-Hydride Battery | |
| Screening Calls..... | 49 | Warning | 59 |
| Turning Off the Message Alert Tone..... | 49 | Important Safety Instructions | 59 |
| Operating the Answering System While You Are | | Index.. | 60 |
| Away from Home | 49 | Remote Operation Card | 62 |
| Setting a security code or Personal Identification | | One Year Limited Warranty..... | 66 |
| Number (PIN) | 49 | | |
| Dialing in to your answering system..... | 49 | | |
| Maintenance..... | 51 | | |
| Specifications..... | 51 | | |
| Battery Information..... | 51 | | |
| Battery life | 51 | | |
| Low battery alert | 52 | | |
| Cleaning the charging contacts | 52 | | |
| Battery replacement and handling | 52 | | |
| Power Failures | 52 | | |
| Troubleshooting | 53 | | |
| Common Issues | 53 | | |
| Resetting the Handset | 55 | | |
| Resetting the Handset Without the Base | 56 | | |
| Changing the Line Mode for Multiple Extensions.... | 57 | | |

Welcome

Thank you for purchasing a Uniden Multi-Handset phone.

Note: Illustrations in this manual are used for explanation purposes. Some illustrations in this manual may differ from the actual unit.



Installing the Phone

Choosing the Best Location

When choosing a location for your new phone, here are some important guidelines you should consider:

Installing the Phone

PLACE YOUR BASE



TRY TO AVOID

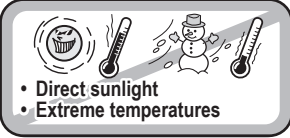
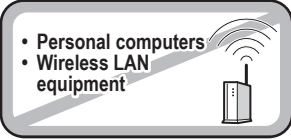
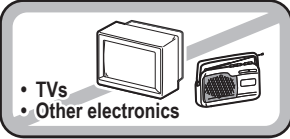
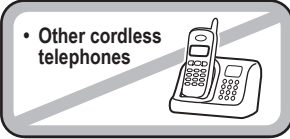
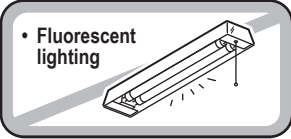
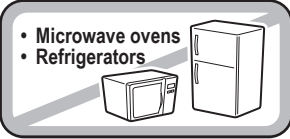

Notes: For maximum range:

- Keep both the base and handset antennas free of obstruction.
- When the handset is not in use, place the handset in an upright position.
- Metal and reinforced concrete may affect cordless telephone performance.



Installing the Battery

Use only the Uniden BT-694 rechargeable battery pack supplied with your cordless telephone.

- ① Locate the battery pack, battery cover and the handset.

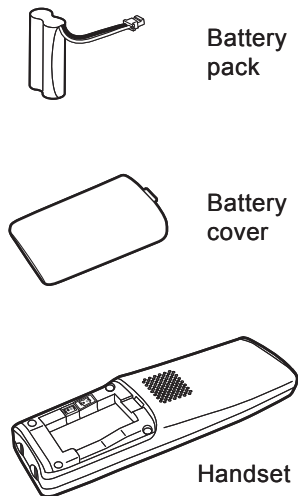

- ② Line up the red and black wires on the battery pack connector with the sticker in the handset's battery compartment.

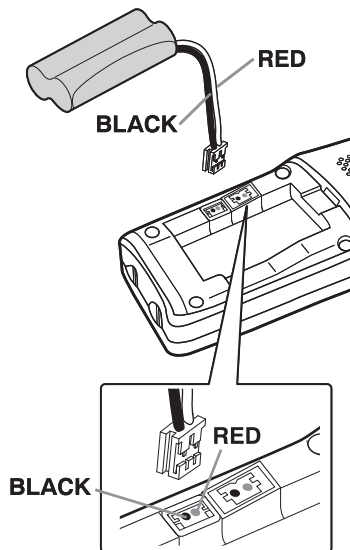

- ③ Push the battery pack connector in firmly. (You should hear it click into place.) Gently tug on the battery wires to make sure the connection is secure.

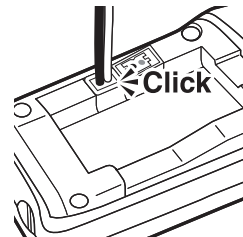

- ④ Place the cover over the battery compartment and slide it up into place.

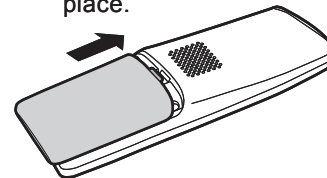



Connecting the AC adapter

To the base

To avoid risk of fire and shock, only use the Uniden AAD-041S AC adapter with the base.

- 1 Connect the AC adapter to the **DC IN 9V** jack on the bottom of the base.

Don't put any power cord where it people might trip over it or step on it. If a power cord becomes chafed or worn out, it can create a fire or electrical hazard.

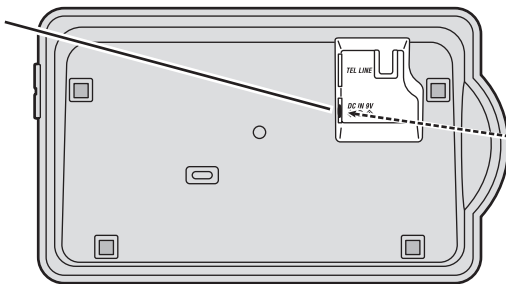

- 2 Connect the AC adapter to a standard 240V AC wall outlet.

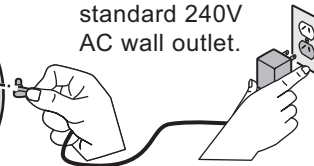

To the charging cradle (for multi-handset packs only)

Use only the Uniden AAD-600S AC adapter with the charging cradle.

- 1 Route the cord through the molded wiring channel.

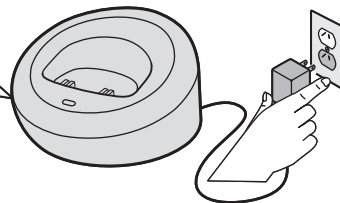
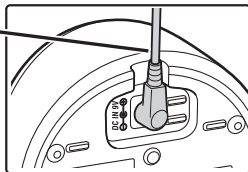

- 2 Connect the AC adapter to a standard 240V AC wall outlet.



Charging the Handset

- 1 Place the handset in the base cradle with the display facing forward.

- 2 If you have an accessory handset, place it in the charging cradle with the display facing forward.

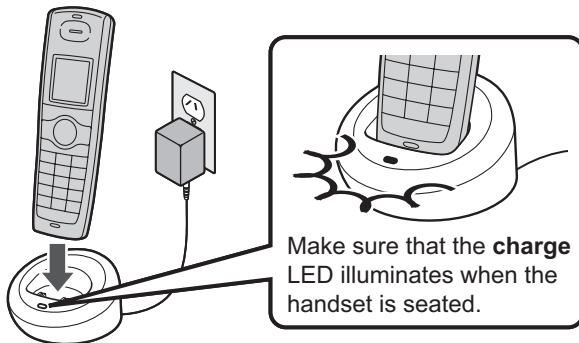
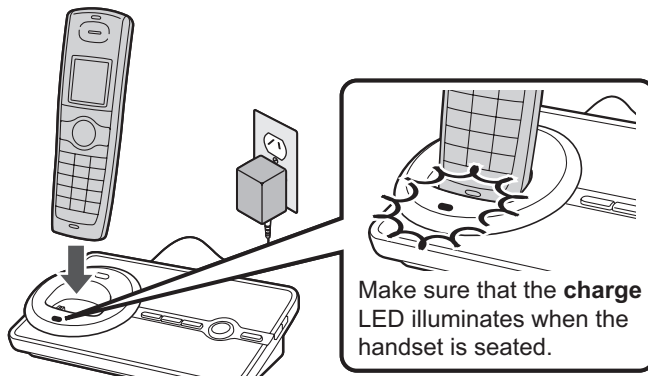

- 3 Charge your handset at least 15 to 20 hours before plugging into the phone line.

? What if the **charge** LED doesn't light up?



- Reseat the handset; make sure the contacts on the bottom of the handset are lined up with the contacts in the cradle.
- Check the AC adapter connection.



Connecting to the Phone Line

Make sure that the battery pack is fully charged.

① Connect the telephone cord to the **TEL LINE** jack on the bottom of the base.

② Route the cord through the molded wiring channel.

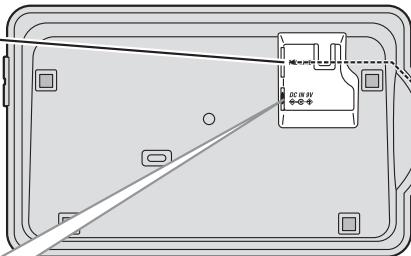
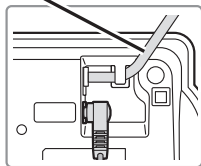

③ Connect the telephone cord to a telephone wall jack.

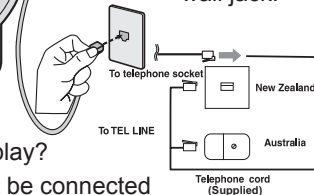

? What if CHECK TEL LINE appears on the handset display?

💡 The telephone cord may not be connected correctly. Check the telephone cord connection.

? Do you have DSL or any high-speed Internet service delivered through your phone line?

💡 Try putting a DSL filter between the base and the wall jack. Without a filter, telephone-line-based Internet services can interfere with standard phones.

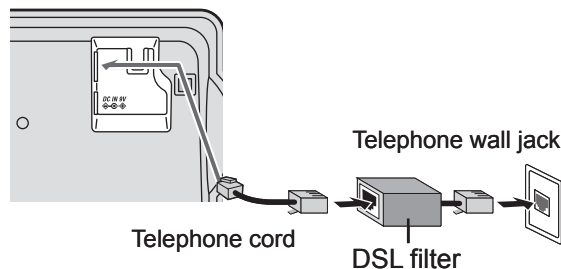

Testing the Connection

① Pick up the handset from the cradle and press **[*/flash]**. You should hear a dial tone, and the display should show TALK.

- ① ? What if I can't hear a dial tone?
- 💡 Check the telephone cord connection on the base.
- ① ? What if the display doesn't show TALK?
- 💡
 - Check the battery pack connection in the handset.
 - Make sure the battery pack is fully charged.
 - Make sure the AC adapter cord is securely connected to the DC IN 9V jack and a standard power outlet.
 - Try resetting the handset (see page 55).

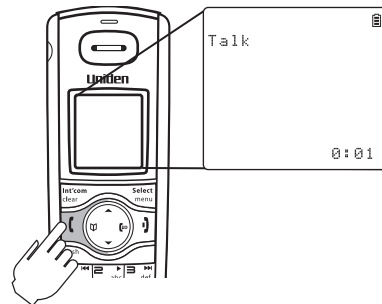

② Make a quick test call, and then press **[*]** to hang up.

- ① ? What if there is a lot of static?
- 💡 Check the sources of interference described in Choosing the Best Location (see page 5): is the base near any of those?

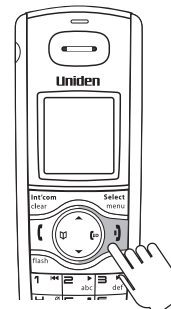

Note: Make sure you can get a dial tone on any accessory handsets that were packaged with your phone.



NOW YOU ARE READY TO USE YOUR PHONE!

Installing the Belt Clip

Insert the tabs on the sides of the belt clip into the holes on either side of the handset. Press the belt clip down until it clicks into place. (Tug on the clip to make sure it's secure.)

To remove the belt clip, gently pull the tabs out of the holes, then slide the belt clip off of the handset.

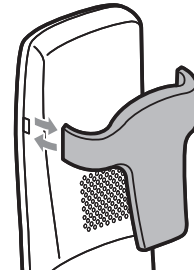



Expanding Your Phone

Adding accessory handsets

Your phone supports a total of six cordless handsets, including any that were supplied with your phone. You can now place a fully-featured cordless handset anywhere AC power is available to connect the charging cradle.

- Your phone is compatible with the following Uniden DECT accessory handsets: DECT Elite 9005 and DECT 6005. (Please visit our website at www.uniden.com.au for Australian models and www.uniden.co.nz for New Zealand models for the most up-to-date list of compatible handsets.)
- For instructions on connecting the charging cradle, see page 7.
- If you purchase any accessory handsets separately, you must register the handsets to the base before you can use them. (Accessory handsets that come packaged with a base are already registered to that base.)

Registering accessory handsets

When charged, registered handsets display a handset ID number. Handsets that have not been registered display as shown.

To register a DECT Elite 9005 accessory handset:

- 1) Charge the handset for 15-20 hours.
- 2) Place the handset in the base cradle for about thirty seconds. **HANDSET REGISTERING** will appear in the LCD.
- 3) When the handset has registered to the base, the LCD will display **REGISTRATION COMPLETE** then show the handset ID number.

If the display shows **REGISTRATION FAILED**, repeat the process again.

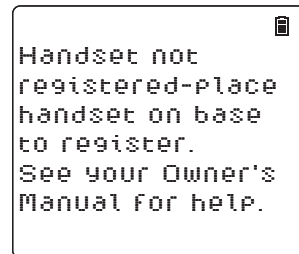

To register a DECT 6005 accessory handset:

- 1) Charge the handset for 15-20 hours.
- 2) Disconnect the base AC adapter. Then press and hold **[find]** while you reconnect the adapter. Keep pressing **[find]** until the charge LED starts to blink.
- 3) On the handset, press and hold **[#]** until the handset beeps and displays **HANDSET REGISTERING**.





- 4) When the handset has registered to the base, the LCD will display REGISTRATION COMPLETE then show the handset ID number.

If the display shows REGISTRATION FAILED, repeat the process again.

Note: If a handset has ever been registered to a base, reset the handset before you register it to a new base (see Resetting the Handset on page 55). Or to use multiple bases, see the next section.

Using Multiple Bases

The handsets supplied with your phone (or any DECT Elite 9005 accessory handsets) can be registered to a total of four different bases. Compatible bases include the DECT Elite 9035 series, DECT 6015 series and DECT 6035 series models. Once your handset is registered to more than one base, you can set the handset to search automatically the available base, or you can select manually which base the handset should connect to (for example, if you have one base with an answering machine, you can tell the handset to connect that base to check messages).

Note: To confirm how many bases the handset is registered to, open the SELECT BASE submenu (follow the step 1 of Selecting the base on page 14). Press **[*]** to close the list and return to standby.

Registering the handset to another base

- 1) Make sure the handset battery is fully charged.
- 2) To register a handset to DECT 6015, DECT 6035 or DECT Elite 9035 base:
 - Disconnect the base AC adapter. Then press and hold **[find hs]** or **[find]** while you reconnect the adapter. Keep pressing **[find hs]** or **[find]** until the charge LED starts to blink.
- 3) On the handset, press **[Select/menu]**. Select the REGISTER BASE menu. HANDSET REGISTERING will appear in the display. (After step 2, you have thirty seconds to complete this step 3 before the system returns to standby.)
- 4) Wait approximately thirty seconds. "REGISTRATION COMPLETE" will be displayed to indicate the handset has been registered to the base and a handset ID will be automatically assigned.

If the display shows REGISTRATION FAILED, repeat the process again.





Selecting the base

When your handset is registered to another base, it will automatically connect to the base. A base ID (that is for the handset only) will be assigned in the order of registration. You can either select a base you want to use manually, or set to AUTO. If you set to AUTO, when the handset comes out of range, it searches automatically the available base in order of base ID.

- 1) With the phone in standby, press **[Select/menu]**. Select the HANDSET SETUP menu, and then the SELECT BASE submenu.
- 2) Move the cursor to select the base you want to connect to, or choose AUTO to have the handset automatically select the base.
- 3) Press **[Select/menu]**. SEARCHING will appear in the display.
- 4) When the base is found, the handset will return to standby. If the base is not found, "SEARCHING" continues to appear. You can repeat the procedure listed above to return back to the original connection or to find the different base.

Note: You cannot change bases during a call.



Getting to Know Your New Phone

Features

- 1.8GHz DECT Elite expandable system
 - Expands up to 6 handsets
 - Integrated digital answering system
 - Advanced phonebook features on each handset:
 - Store 70 phonebook entries
 - Alphabetical search
 - Personalized ring by party
 - Personalized LCD color scheme by party.
 - Transfer single listing or entire phonebook
 - Call transfer
 - Conferencing
 - Intercom
 - Caller ID/Call Waiting*
 - Name Tag (POP ID)*
 - Personal Settings (Distinctive Ring)*
 - Store 30 Caller ID numbers on each handset
 - Speakerphone on handset
 - 10 ringer options (5 tones/ 5 polyphonic melodies)
 - Last 5 number redial
 - Handset Keypad Lock
- * Caller ID, Name Tag, Personal Settings features require subscription to the Caller Display service from your network supplier. A fee normally applies for this. The Caller ID on Call Waiting service is currently unavailable in New Zealand.

Answering system features

- Digital tapeless recording
- Up to 14 minutes of recording time
- Call screening
- Personal or pre-recorded outgoing messages
- Day and time announcement
- Remote message retrieval
- Toll saver
- Message alert
- Records up to 59 messages

Terminology Used in this Manual

| | |
|---------------------------|-----------------------------------------------------------------------------------------------------------------------------------------------------------------------------------------------------------------------------------------------------------------------------------------------------------------------------------------------------------------------------------------------------------------------------------------------------------|
| Accessory Handsets | Additional handsets that can register to the base, allowing you to add handsets without connecting another phone line. This base supports a total of six cordless handsets; see page 12 for compatible handsets. |
| Base | The main part of the phone that connects to your phone line and lets you make and receive calls. |
| Charging cradle | A cradle that comes with an accessory handset and charges the handset battery pack. It connects to power but does not connect to a phone line. |
| CID | Caller ID is available from your telephone provider and is offered to users on a subscription basis. With this service, you will be able to see the incoming caller information such as name and phone number. |
| CID/CW or CIDCW | Caller ID with Call Waiting is available by subscription from your telephone provider. With this service, you will be able to view incoming caller information while on a call with another user. |
| Global Settings | Any settings that apply to all registered handsets and the base. These features are available by selecting "GLOBAL SETUP" or "DAY & TIME" in the handset menu. Only one handset can change global settings at a time, and you have to make sure the phone is not currently being used. If you have multiple bases, the different bases have each global settings; select the base before changing the global setting (see Selecting the Base on page 14). |
| Standby | The handset and the base are not in use. (It doesn't matter whether the handset is in the cradle: the [/flash] or [■▶▶] hasn't been pressed, and there is no dial tone.) |
| Station | Any registered handset or the base. |
| Talk | A dial tone has been enabled, so you can dial and carry on a conversation with an outside party. |

Manual Conventions

This manual uses several different type styles to help you distinguish between different parts of the phone:

- Bold text with "[]" indicates a key or button on the phone
- ALL CAPITALS indicates text on the display, such as menu options, prompts, and confirmation messages
- lower case bold text indicates a status light on the phone
- ALL CAPITALS BOLD indicates a connection jack on the base or charging cradle

Parts of the Base

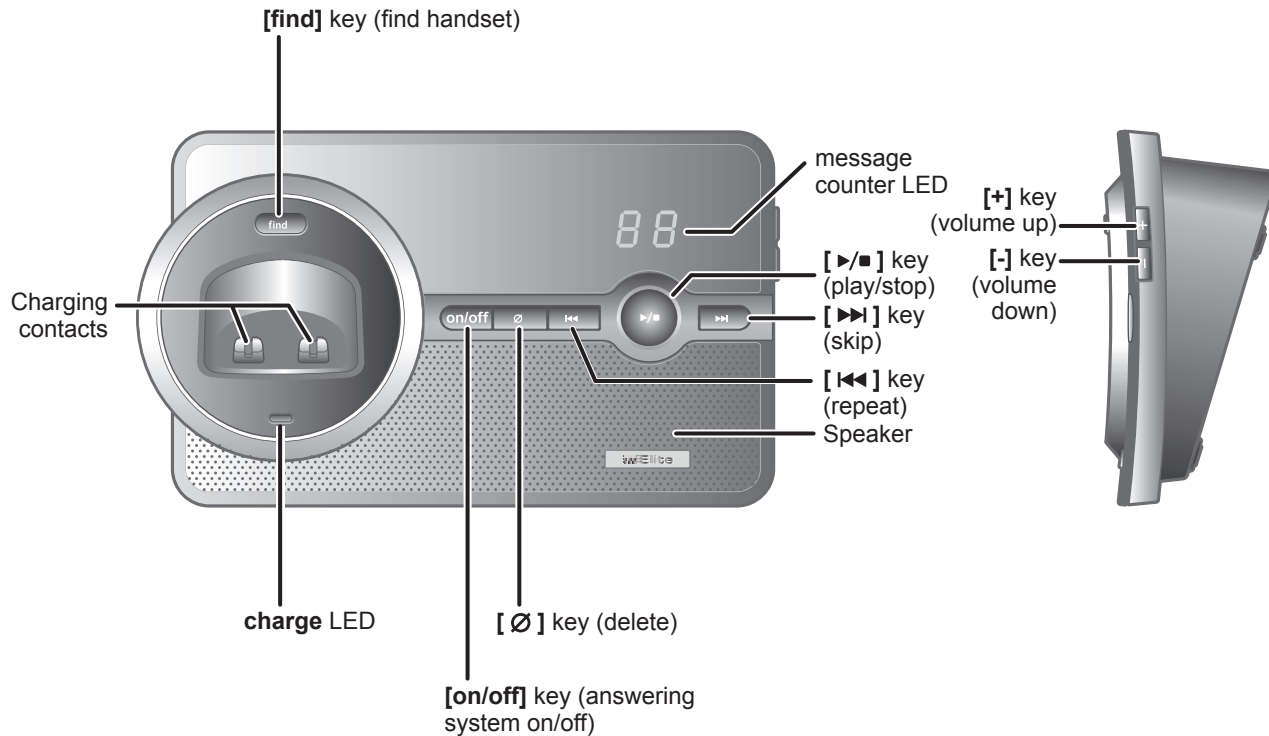

Using the Interface

Reading the Handset Display

In standby

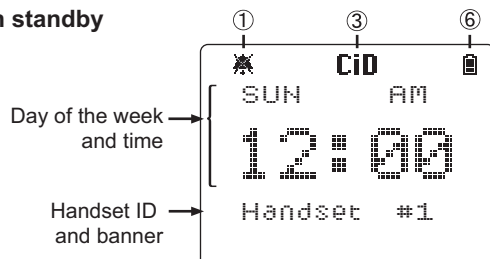

During a call

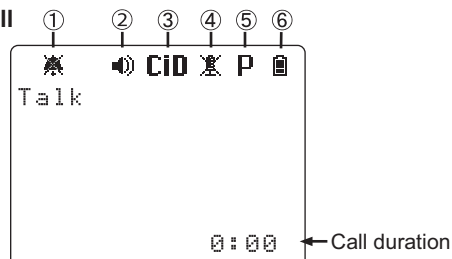

| | | |
|---|------------|---------------------------------------------------------------------------------------------|
| ① | | The ringer off icon indicates that the ringer is turned off. |
| ② | | The speaker icon appears when the speaker phone is in use. |
| ③ | CiD | The CID icon appears when you have new Caller ID records. |
| ④ | | The mute icon appears while the microphone is muted. |
| ⑤ | P | The privacy icon appears when the Privacy Mode is turned on. |
| ⑥ | | The battery icon indicates the handset battery status: full, medium, low, and empty. |

Using the Four-way Function Key

Your handset has a four-way function key that allows you to move the cursor or pointer on the display and access the most commonly used features at the touch of a button. By moving this key to the left, you open the phonebook. Move the key to the right to access Caller ID information. To use this four-way key, place your thumb over the key and move to the four positions to get the feel of how it moves and operates.

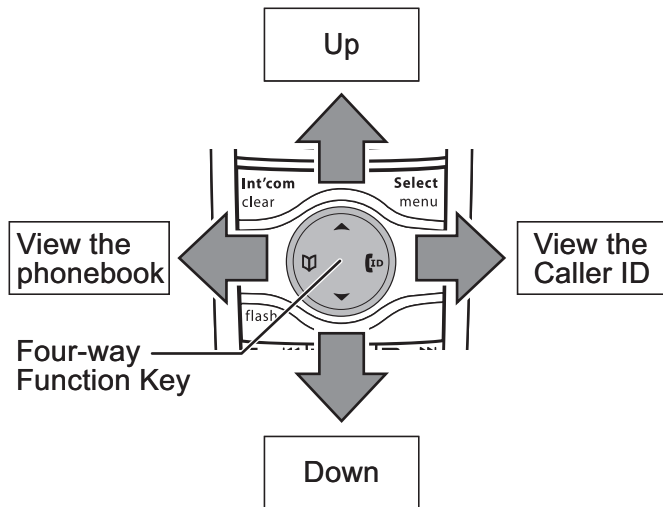

Using the Handset Menu

- To open the menu, press the **[Select/menu]** key.
- The option currently highlighted appears in reversed out text. Use **[▲]** on the four-way function key to highlight the next upper option and **[▼]** to highlight the next lower option.
- To select the highlighted option, press **[Select/menu]**.
- To go back to the previous screen, press **[left]** on the four-way function key.
- To exit the menu, press **[*]**.
- If you don't press any keys for thirty seconds, the phone will time out and exit the menu.
- For ANSW. SETUP, GLOBAL SETUP and DAY & TIME menu options, make sure the line is not in use and the handsets are within range of the base.

Entering Text from Your Handset

You can use the number keypad on your handset to enter text by referring to the letters printed on each number key. When you press the number key in a text entry field, the phone displays the first letter printed on the number key. Press the number key twice to display the second letter and three times to display the third. Capital letters are displayed first, then lower case letters, and then the number on the key.

If two letters in a row use the same number key, enter the first letter, then use **[right]** on the four-way function key to move the cursor to the next position to enter the second letter.

For example, to enter the word “Movies”:

- 1) Press **[6]** once to enter **M**.
- 2) Use **[right]** on the four-way function key to move the cursor to the right.
- 3) Press **[6]** six times to enter **o**.
- 4) Press **[8]** six times to enter **v**.
- 5) Press **[4]** six times to enter **i**.
- 6) Press **[3]** five times to enter **e**.
- 7) Press **[7]** eight times to enter **s**.
- 8) Press **[Select/menu]** to end your text entry.

| | Number of times key is pressed | | | | | | | | |
|---------------|--------------------------------|---|---|---|---|---|---------|----|----|
| keys | 1 | 2 | 3 | 4 | 5 | 6 | 7 | 8 | 9 |
| 1 | 1 | | | | | | | | |
| 2 abc | A | B | C | a | b | c | 2 | | |
| 3 def | D | E | F | d | e | f | 3 | | |
| 4 ghi | G | H | I | g | h | i | 4 | | |
| 5 jkl | J | K | L | j | k | l | 5 | | |
| 6 mno | M | N | O | m | n | o | 6 | | |
| 7 pqrs | P | Q | R | S | P | q | r | s | 7 |
| 8 tuv | T | U | V | t | u | v | 8 | | |
| 9 wxyz | W | X | Y | Z | w | x | y | z | 9 |
| 0 oper | & | < | > | < | > | / | (blank) | -- | -- |
| | . | , | : | ? | ! | @ | ' | " | * |
| | # | 0 | | | | | | | |

If you make a mistake while entering a name, use **[right]** or **[left]** on the four-way function key to move the cursor to the incorrect character. Press **[Int'com/clear]** to erase the wrong character, and then enter the correct character. To delete all characters, press and hold **[Int'com/clear]**.

Note: If you would like to quickly change the case (small/capital) of the letter entered, press **[*/↔]**.



Basic Setup

Setting the Day & Time

If you do not set the clock on your answering system, your messages may not have the correct time and day stamp.

- 1) Press **[Select/menu]**.
- 2) Move the cursor to DAY & TIME and press **[Select/menu]**.
- 3) Use **[▲]** and **[▼]** to select the day of the week, and press **[Select/menu]**.
- 4) Use the number keypad (**[0]** through **[9]**) to enter the hour and minutes.
- 5) Use **[▲]** and **[▼]** to select AM or PM, and press **[Select/menu]**. You hear a confirmation tone.

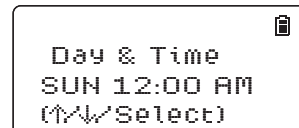

Activating Personal Settings

You can assign special ringer tones to anyone in your phonebook. When your phone gets a call, it looks up the Caller ID information in your phonebook. If you've assigned a personal ring and color to that number, the phone uses it so you know who is calling. To turn the personal ringing on or off, follow these steps:

- 1) Press **[Select/menu]**.
- 2) Select the HANDSET SETUP menu, and then the PERSNL SETTINGS submenu.
- 3) Move the cursor to select ON or OFF.
- 4) Press **[Select/menu]**. You will hear a confirmation tone.





Activating the Key Touch Tone

Key Touch Tone is the tone your keypad makes when keys are pressed. You can turn this tone on or off.

- 1) Press **[Select/menu]**.
- 2) Select the HANDSET SETUP menu, and then the KEY TOUCH TONE submenu.
- 3) Move the cursor to select ON or OFF.
- 4) Press **[Select/menu]**. You will hear a confirmation tone.

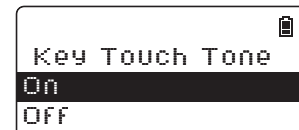

Name Tag

Name Tagging works with the caller display number from Caller ID. You will need to subscribe to the Caller ID feature with your phone company for Name Tagging to work.

When the phone rings, the received caller display number is compared to numbers stored in the phonebook. If there is a match then any name stored with the phonebook number will be displayed. To change the Name Tagging setting, follow the steps listed below.

- 1) Press **[Select/menu]**.
- 2) Select the HANDSET SETUP menu, and then the NAME TAG submenu.
- 3) Move the cursor to select ON or OFF.
- 4) Press **[Select/menu]**. You will hear a confirmation tone.

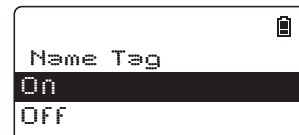

Insert 0

This feature adds “0” or “00” at the beginning of the number received from Caller ID. The default setting for New Zealand is ON. The default setting for Australia is OFF. To change the Insert 0 setting, follow the steps listed below.

- 1) Press **[Select/menu]**. Select the GLOBAL SETUP menu, and then the INSERT 0 submenu.
- 2) Move the cursor to select ON or OFF.
- 3) Press **[Select/menu]**. You will hear a confirmation tone.

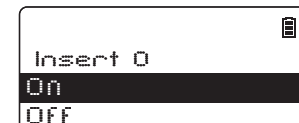

Setting Up the Phonebook

Each handset has its own separate phonebook that holds up to seventy names and numbers. When a handset's phonebook is full, the handset beeps and shows MEMORY FULL on the display. You cannot add any names and numbers in that handset's phonebook until you delete some of the existing ones.

You can also use the phonebook entries to store a group of numbers (up to twenty digits) that you may need to enter once your call connects. This is referred to as chain dialing. (See Chain dialing from the phonebook on page 32.)

Creating Phonebook Entries

To store names and numbers in your phonebook, please follow these steps:

- 1) With the phone in standby, press [] (on the left side of the four-way key).
- 2) To create a new phonebook entry, press [Select/menu]. Select the CREATE NEW menu. EDIT NAME appears.

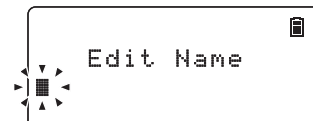

- 3) Enter the name for this entry (EDIT NAME).

Use the keypad to enter a name for this entry; the name can contain up to sixteen characters. (See Entering Text from Your Handset on page 21 for instructions on entering text.) If you do not want to enter a name for this entry, your phone will store this entry as <NO NAME>. Press [Select/menu] when you are finished.

- 4) Enter the number for this entry (EDIT NUMBER).

Once you have stored a name, EDIT NUMBER appears next. Use the number keypad to enter the phone number; the phone number can contain up to twenty digits. If you need the phone to pause between digits when it's dialing (for example, to enter an extension or an access code), press [Redial/pause] to insert a two-second pause. You will see a P in the display. You can also use more than one pause together if two seconds is not long enough. Each pause counts as one digit. Press [Select/menu] when you are finished.

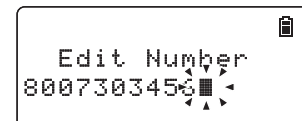



5) Assign a personal ring tone for this entry (PERSONAL RING).

You can attach a special ring tone to each phonebook entry; the phone will use this ring tone when this person calls. Use [▲] and [▼] to select one of the ten different ring tone options (see Selecting a Ringer Tone on page 28 for a complete list of ring tones). As you scroll through the tones, you will hear a sample of each tone (unless the handset ringer volume is set to off). When you hear the ring tone you want to use, press **[Select/menu]**. If you do not want to use a personal ring tone for this phonebook entry, choose NO SELECTION; the phone will use your standard ring tone setting.

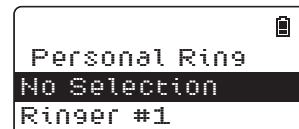

6) Assign a personal display color for this entry (PERSONAL COLOR).

You can attach a color scheme to each phonebook entry; the display will use this color when this person calls. Use [▲] and [▼] to select one of the seven different color scheme options. As you scroll through the options, you will see each color scheme on the display. When you see the color scheme you want to use, press **[Select/menu]**. If you do not want to use a color scheme for this phonebook entry, choose NO SELECTION; the phone will use your standard color scheme setting.

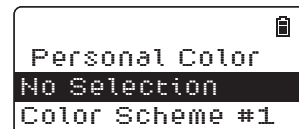

7) You will hear a tone confirming that the new entry has been stored, and DONE! appears in the display.

Finding a Phonebook Entry

Press [☐] to open the phonebook. Phonebook entries are stored in alphabetical order. To scroll through the phonebook from A to Z, press [▼]. To scroll trough the phonebook from Z to A press [▲].

You can also use the letters on the number keys to jump to a name that starts with that letter. For example, to search for an entry beginning with the letter M, press [6] once. The phonebook jumps to the first entry that begins with the letter you entered; you can then use [▲] and [▼] to scroll to other entries.

To close the phonebook and return to standby, press [⏏]. If you are looking up a phonebook entry during a call and want to close the phonebook, press [☐] again instead of [⏏].



Editing an Existing Phonebook Entry

- 1) With the phone in standby, press [**☰**] to open the phonebook.
- 2) Find the entry you want to edit and press [**Select/menu**].
- 3) Select EDIT. Follow the steps for Creating Phonebook Entries on page 24. If you do not wish to change the information at any step, simply press [**Select/menu**] to go to the next step.

Storing Caller ID or Redial Numbers in the Phonebook

You can store Caller ID records or redial numbers in the phonebook so you can use them later. Go to the Caller ID or redial list and select the number you want to store. (If the Caller ID information did not include the number, then you will not be able to store it.)

- 1) With the phone in standby, press [**[ID]**] to open the Caller ID list or [**Redial/pause**] to open the redial list.
- 2) Use [**▲**] and [**▼**] to scroll through the Caller ID records or redial numbers. When you come to the information you want to store, press [**Select/menu**].
- 3) Select STORE INTO PB. EDIT NAME appears. If the phone number is already stored in memory, you will hear a beep, and THIS DATA IS ALREADY SAVED! appears in the display. The number will not be stored.
- 4) Continue by following the steps for Creating Phonebook Entries on page 24.

Deleting a Single Phonebook Entry

- 1) With the phone in standby, press [**☰**].
- 2) Find the entry that you want to delete and press [**Select/menu**].
- 3) Select DELETE. DELETE ENTRY? appears in the display.
- 4) Move the cursor to select YES.
- 5) Press [**Select/menu**]. You will hear a confirmation tone, and DELETED! appears in the display.

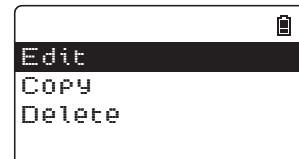



Deleting all Phonebook Entries

- 1) With the phone in standby, press [**⏏**].
- 2) Press [**Select/menu**], and then select DELETE ALL. DELETE ALL? appears in the display.
- 3) Move the cursor to select YES.
- 4) Press [**Select/menu**]. You will hear a confirmation tone, and DELETED! appears in the display.

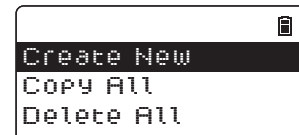

Copying Phonebook Entries to Another Handset

If you have more than one handset, you can transfer phonebook entries from one handset to another without having to re-enter names and numbers. You can transfer one phonebook entry at a time or all phonebook entries at once.

- 1) With the phone in standby, press [**⏏**].
- 2) To copy one entry, find the phonebook entry you want to copy. Press [**Select/menu**], and then select COPY. To copy all entries, press [**Select/menu**], and then select COPY ALL.
- 3) Move the cursor to select the handset which you want to transfer the entries to and then press [**Select/menu**]. If you select COPY ALL, ARE YOU SURE? appears on the display screen. Move the cursor to select YES, and then press [**Select/menu**].
- 4) The phonebook entries will be transferred to the designated handset. During the copy process, the receiving handset shows RECEIVING and the ID of the sending handset.
- 5) When the transfer is completed, DONE! appears on the handset.

Notes: • The handsets must be currently connected to the same base (see page 14).

- If the handset you want to transfer to already has seventy entries in its phonebook, you will hear a beep, and NOT ENOUGH MEMORY IN RECEIVING UNIT appears on the display.
- If the selected handset is out of range or data transfer is cancelled, UNAVAILABLE appears in the display. Phonebook listings will not be transferred.



Customizing Your Handsets

All of the following options are set separately for each handset, so you can customize a handset for each room in your house.

Changing the Handset Banner

Each handset will display a banner name once it is registered to the base. The default banner is Handset #1, Handset #2, etc. You can change the name your phone displays by changing the banner display. If you have more than one handset, the banner name identifies your handset.



1. Press **[Select/menu]**.
2. Select the HANDSET SETUP menu, and then the BANNER submenu.
3. Use the keypad to enter or edit the banner name. (See Entering Text from Your Phone on page 21 for detailed instructions on entering text.)
4. Press **[Select/menu]**. You will hear a confirmation tone.

Note: When you have multiple bases and even if the handset ID is changed when you switch to a different base, the handset will keep the banner name.

Selecting a Ringer Tone

You may choose from five melodies or five tones for your phone's primary ring tone. Each handset can use a different ring tone or melody.

1. Press **[Select/menu]**.
2. Select the HANDSET SETUP menu, and then the RINGER TONES submenu.
3. Move the cursor to select a ringer tone. As each ringer tone is highlighted, you will hear a sample (unless the handset ringer volume is set to off).
4. When you hear the tone you want to use, press **[Select/menu]**. You will hear a confirmation tone.

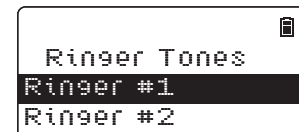

Activating AutoTalk

AutoTalk allows you to answer the phone simply by picking up the handset from the cradle. You do not have to press a button to answer the call.

1. Press **[Select/menu]**.
2. Select the HANDSET SETUP menu, and then the AUTOTALK submenu.
3. Move the cursor to select ON or OFF.
4. Press **[Select/menu]**. You will hear a confirmation tone.



Activating Any Key Answer

Any Key Answer allows you to answer the phone by pressing any key on the twelve-key dial pad.

1. Press **[Select/menu]**.
2. Select the HANDSET SETUP menu, and then the ANY KEY ANSWER submenu.
3. Move the cursor to select ON or OFF.
4. Press **[Select/menu]**. You will hear a confirmation tone.

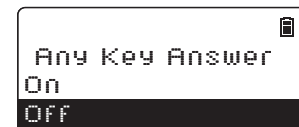

Color Scheme

You can change the color of your phone's display. There are seven different colors to choose from.

1. Press **[Select/menu]**.
2. Select the HANDSET SETUP menu, and then the COLOR SCHEME submenu.
3. Move the cursor to select a color scheme. As you scroll through the options, you will see each color scheme on the display.
4. When you see the color scheme you want to use, press **[Select/menu]**. You will hear a confirmation tone.

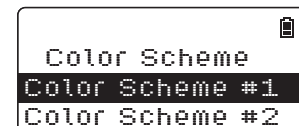

Wallpaper

Your phone has four wallpapers to choose from.

1. Press **[Select/menu]**.
2. Select the HANDSET SETUP menu, and then the WALLPAPER submenu.
3. Move the cursor to select a wall paper. As you scroll through the options, you will see each wallpaper on the display. If you do not want to use a wallpaper, choose NO SELECTION.
4. Press **[Select/menu]**. You will hear a confirmation tone.

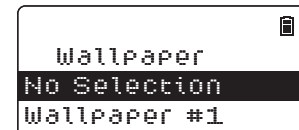

Adjusting the Display (LCD Contrast)

LCD Contrast adjusts the handset display brightness. Choose from one of the ten levels for optimum viewing.

1. Press **[Select/menu]**.
2. Select the HANDSET SETUP, and then the LCD CONTRAST submenu.
3. Use **[▲]** or **[▼]** to adjust the contrast of the display.
4. Press **[Select/menu]**. You will hear a confirmation tone.

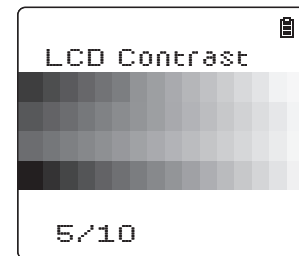







Activating Handset Keypad Lock

Press and hold **[*/☎]** to activate the keypad lock. Repeat the process to deactivate the keypad lock.





Using Your Phone



| | From a cordless handset | From a handset speakerphone |
|-------------------------|------------------------------------------------------------------------------------------------------------------------------------------------------------------------------------------------------------------------------------------------------------------------------------------------------------------------------------------------------------------------------------------------------|------------------------------------------------------------------------------------------------------------------------------------------------------------------------------------------------------------------------------------------------------------------------------------------------------------------------------------------------------------------------------------------|
| Making a call | 1. Pick up the handset from the cradle. 2. Press [/flash] . 3. Listen for the dial tone. 4. Dial the number. OR 1. Pick up the handset from the cradle. 2. Dial the number. 3. Press [/flash] . | 1. Pick up the handset from the cradle. 2. Press [] . 3. Listen for the dial tone. 4. Dial the number. OR 1. Pick up the handset from the cradle. 2. Dial the number. 3. Press [] . |
| Answering a call | 1. Pick up the handset. (If AutoTalk is on, the phone will answer when you pick up the handset from the cradle.) 2. Press [/flash] . (If Any Key Answer is on, you can also press any key on the dial pad.) | 1. Pick up the handset. 2. Press [] . |
| Hanging up | Press [] or return the handset to the cradle. | |







Making a Call from the Phonebook

1. With the phone in standby, press [] to open the phonebook.
2. Find the phonebook entry you want to call (see Finding a Phonebook Entry on page 25).
3. Press [ /flash] or [] to dial the number.

Note: You can also press [ /flash] or [] before you open the phonebook. Find the phone number you want to dial, and then press [**Select/menu**].

Chain dialing from the phonebook

If you often have to enter a series of digits or a code number during a call, you can save that code number to a phonebook entry. When your call connects, just use the phonebook to transmit the saved code number. (This is referred to as chain dialing.)

1. Enter the code number (up to twenty digits) into the phonebook (see Creating Phonebook Entries on page 24). Be sure to enter the code number into the phonebook exactly as you would enter it during a call.
2. During a call, when you hear the prompt that tells you to enter the code number, press [].
3. Use [] or [] to select the phonebook entry that contains the digits you want to send.
4. Press [**Select/menu**]. The phone sends the digits of the code number exactly as you saved them in the phonebook entry.

Switching to the Handset Speakerphone During a Call

To switch a normal call to the speakerphone, press [] on the handset. To switch from a speakerphone call to a normal call, press [].





Using Caller ID, Call Waiting, and Redial Lists

If you subscribe to Caller ID service from your phone company, your phone will show you the caller's phone number and name (if available) whenever a call comes in. If you subscribe to Caller ID on Call Waiting, the phone will also show you the name and the number of any call that comes in while you're on the line.

Using the Caller ID List

You can store up to thirty Caller ID numbers in each handset. Caller ID records are stored from newest to oldest. Once your Caller ID list is full, the oldest record will be automatically deleted when a new call is received. When you have new Caller ID records (that is, records you have not reviewed yet), **CiD** appears on the display. To open the Caller ID list, press **[CID]** (on the right side of the four-way key). The phone will show the latest record. Use **[▲]** and **[▼]** to scroll through the list. (New records have an asterisk next to the received time.)

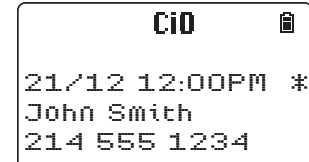

Making a Call from a Caller ID Record

1. With the phone in standby, press **[CID]** to open the Caller ID list.
2. Use **[▲]** and **[▼]** to find the Caller ID record you want to dial.

Press **[/flash]** or **[☎]** to dial the number.

Note: You can also press **[/flash]** or **[☎]** before you open the caller ID list. Find the phone number you want to dial, and then press **[Select/menu]**.



Deleting Caller ID Numbers

To delete only one Caller ID number, press **[CID]** when the phone is in standby, and then find the number you want to delete. Press **[Select/menu]** and select DELETE ENTRY. When the phone asks you to confirm, select YES.

To delete all the Caller ID numbers, press **[CID]** when the phone is in standby. Press **[Select/menu]** and select DELETE ALL. When the phone asks you to confirm, select YES.

- Notes:
- When you delete a Caller ID number, you delete it permanently.
 - Caller ID numbers are stored separately in each handset. Deleting a record from one handset will not delete the record from any other handsets.

Using Call Waiting

If you have Call Waiting service and a second call comes in when you are on the phone, a call waiting tone will sound (If you subscribe to Caller ID on Call Waiting, the handset displays the name and phone number of the waiting call.)

For Australian Model:

Press **[/flash]** and then **[2]** on the handset to accept the waiting call. The first caller is put on hold, and you will hear the new caller after a short pause. To return to the original caller, press **[/flash]** and then **[2]** again.

For New Zealand Model:

Press **[/flash]** on the handset to accept the waiting call. The first caller is put on hold, and you will hear the new caller after a short pause. To return to the original caller, press **[/flash]** again.

Note: You must subscribe to Call Waiting service for this feature to operate. Not all features are available in all areas.

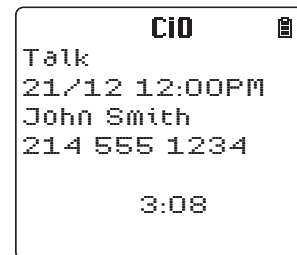



Redialing a Number

You can quickly redial the last five numbers dialed on each handset.

1. With the phone in standby, press the **[Redial/pause]** to open the redial list.
2. Use **[▲]** and **[▼]** or **[Redial/pause]** to scroll through the redial list.
3. When you find the number you want to dial, press **[/flash]** or **[⏏]**.

Notes:

- If the number exceeds 32 digits, only the first 32 digits are retained in redial memory.
- If the redial memory is empty, EMPTY appears in the display and you will hear a beep.
- You can also press **[/flash]** or **[⏏]** before you open the redial list.
Find the phone number you want to dial, and then press **[Select/menu]**.

Deleting a Redial Record

If you want to delete a phone number from the redial list, follow the steps below:

1. With the phone in standby, press **[Redial/pause]** .
2. Use **[▲]** and **[▼]** to scroll through the redial list.
3. When you find the redial number you want to delete, press **[Select/menu]** and select DELETE ENTRY.
4. When the phone asks you to confirm, select YES. The redial number is deleted.



Adjusting the Ringer, Earpiece and Speaker Volume

Adjusting the Ringer Volume

You can choose from four ringer volume settings (off, low, medium, and high) separately on each handset or the base.

1. With the phone in standby, press [▲] or [▼] on the handset or press [+] or [-] on the base. The station sounds the ringer at that level.
2. Use [▲] on the handset or [+] on the base to make the ringer volume louder. Use [▼] on the handset or [-] on the base to make it softer or turn it completely off.
3. When you hear the ringer volume level you want to use, stop pressing keys. The station will use the new ringer volume starting with the next incoming call.

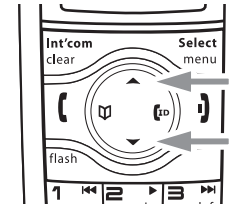

Note: If you set the ringer volume to OFF, the station won't ring. Other stations will ring according to their individual settings.

Muting the Ringer (One call only)

While the phone is ringing, press [ⓧ/mute] or [Ⓜ] on the handset or [▶/■] on the base to mute the ringer for this call. The phone will ring again on the next call. (The handset must be off the cradle to mute the ringer.)

Adjusting the Earpiece Volume

You can choose from six volume levels for the handset earpiece. To adjust the earpiece volume while on a call, press [▲] (to make it louder) or [▼] (to make it softer). The handset display shows the current volume level for the earpiece.

Adjusting the Speaker Volume

Handset Speaker:

You can choose from six volume levels for the handset speaker while on a speakerphone call or when the handset is accessing the answering system. To adjust the handset speaker volume, press [▲] (to make it louder) or [▼] (to make it softer). The handset display shows the current volume level for the handset speaker.

Note: The handset earpiece and the handset speaker have separate volume settings.

Base Speaker:

You can choose from ten volume levels for the base speaker when the answering system announces or plays a message. To adjust the base speaker volume, press [+] (to make it louder) or [-] (to make it softer).

Adjusting the Audio Tone

If you aren't satisfied with the audio quality of your phone, you can adjust the Audio Tone of the earpiece while on a call. Your phone gives you three audio tone options: low, natural and high; the default setting, Natural Tone, is recommended for hearing aid users. Audio tone adjustments only apply to the earpiece, not the speakerphone.

To adjust the audio tone:

1. While on a call, press **[Select/menu]**.
2. Move the cursor to select AUDIO TONE, and then press **[Select/menu]**.
3. Move the cursor to select desired option (HIGH TONE, NATURAL TONE, or LOW TONE), and then press **[Select/menu]**. Selected option appears in the display for two seconds, and then the display returns to normal.



Finding a Lost Handset

To locate a misplaced handset, press **[find]** on the base when the phone is in standby. The handsets connected to the paging base will beep for one minute, and **PAGING** appears on the handset display. To cancel paging, press **[find]** again or any key on the found handset.

Note: Handsets that are not currently connected to this base will not be paged.

Using Hold, Conference and Transfer

Placing a Call on Hold

1. During a call, press **[Int'com/clear]** to place the caller on hold. If you leave a caller on hold for more than ten seconds, the display screen will read, **LINE ON HOLD**.
2. To return to the party on hold, press **[flash]** or **[Mute]**. The phone will return to the holding party.

Notes: • You can only place a caller on hold for five minutes. Once five minutes has passed, that party's line will be disconnected and the phone will return to standby.

- While a call is on hold, Call Waiting and CID on Call Waiting do not work.

Conferencing

If you have more than one handset, up to three people can participate in a conference call. A three-way conference call consists of an outside line and two handsets. You can easily join a call already in progress. The handsets must be currently connected to the same base (see page 14).

1. Press **[flash]** or **[Mute]** to join the call.
2. To hang up, return the handset to the cradle or press **[*]**. The other party will still be connected to the call.

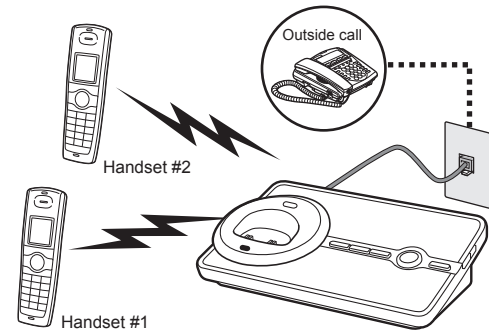



Transferring a Call

You can transfer a call from one handset to another. The handsets must be currently connected to the same base (see page 14).

1. During a call, press **[Int'com/clear]**.
2. Use **[▲]** or **[▼]** to select the handset you want to transfer the call to, and then press **[Select/menu]**. Select ALL to page all other handsets. The call will automatically be placed on hold, and a paging tone sounds. To cancel the transfer, press **[/flash]** or **[▶▶]**.
3. When another handset accepts the transferred call, you will be disconnected. If you want to rejoin the call, press **[/flash]** or **[▶▶]** again.

Answering a transferred call

When a handset receives a call transfer, it sounds a paging tone; handsets also show the ID of the handset that is paging. To accept the call transfer:

1. To answer the page and speak to the transferring handset, press **[/flash]** or **[Int'com/clear]**.

Note: If AutoTalk is on, the handset will automatically answer the page when you pick up the handset from the cradle. If Any Key Answer is on, you can also press any key on the handset's dial pad.

2. To accept the call and speak to the caller, press **[/flash]** on the receiving handset.
3. When you accept the transferred call, the transferring handset will be disconnected.

Only the first handset to answer the transfer page will be connected to the call. If the transfer page is not picked up within one minute, the operation will be canceled.



Using Special Features

Privacy Mode

Privacy mode prevents other handsets from interrupting while you're on a call. As long as your handset is in privacy mode, other handsets can't join your call or make any calls of their own: their displays will show UNAVAILABLE.

1. While on a call, press **[Select/menu]**.
2. Select CALL PRIVACY. PRIVACY MODE ON appears in the display for two seconds; **P** appears and remains in the display until the feature is turned off.

To turn privacy mode off, repeat the procedure listed above. PRIVACY MODE OFF appears.

Using the Intercom

You can use the intercom to talk to another handset without using the phone line. The handsets must be currently connected to the same base (see page 14).

Making an intercom page

1. With the phone in standby, press **[Int'com/clear]**.
2. Use **[▲]** or **[▼]** to select the handset you want to talk with, and then press **[Select/menu]**. Select ALL to page all other handsets.
3. To cancel the intercom page, press **[j]**.

Notes: Intercom paging will be cancelled if any of the following things occur:

- You receive an outside call or an intercom page while selecting the other handset.
- You do not select a handset within thirty seconds.
- Your handset is out of range (OUT OF RANGE appears in the display).
- The party does not answer the page within one minute.
- The party is busy.
- The party is out of range (UNAVAILABLE appears in the display).



Answering an intercom page

When the intercom page tone sounds, the display will show the ID of the handset that is paging.



1. Press **[*/flash]** or **[Int'com/clear]** on the handset.

Note: If AutoTalk is on, the handset will automatically answer the page when you pick up the handset from the cradle. If Any Key Answer is on, you can also press any key on the handset's dial pad.

2. To hang up an intercom call, press **[*]**.

Muting the Microphone

Mute turns off the microphone so the caller can't hear you. This only works while you are on a call.

1. Press **[*/mute]**. MUTE ON and  appear in the display;  remains while muting is on.
2. To cancel muting, press **[*/mute]** again. MUTE OFF appears.



Installing the Optional Headset

Your phone may be used with an optional headset. To use this feature, insert the headset plug into the headset jack. Your phone is ready for hands-free conversations. (Headsets may be purchased by contacting Uniden. See warranty on inside back cover for contact information.)

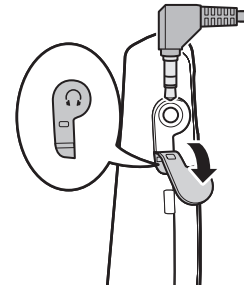

Setting Up the Answering System

You can set up your answering system's features from the handset. Only one handset at a time can access the answering system menus.

Note: If you have multiple bases, select the base with answering system you want to access (see page 14).

Recording a Personal Greeting

Your answering system comes with a pre-recorded outgoing message or greeting that plays when you receive a call: "Hello, no one is available to take your call. Please leave a message after the tone." You can record your own personal outgoing greeting. Your recorded greeting must be between two seconds and thirty seconds long.

1. Press [**✉/mute**]. The system announces the number of new and old messages, then starts to play the messages unless it has no messages.
2. Press [**5**] to stop the announcements or message playback. You will hear intermittent beeps indicating that the system is in the command waiting mode.
3. Press [**8**] to start the recording. The system announces, "Record greeting." Begin recording after the announcement.
4. When you finish recording, press [**8**] again or press [**5**]. You will hear a confirmation tone, and your recorded greeting plays back for you.

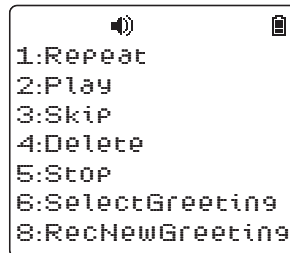

Selecting a Greeting

Once you have recorded a personal greeting, the phone automatically switches to your personal greeting. You can also switch back and forth between the pre-recorded greeting and your own greeting at any time.

1. Press [**✉/mute**]. The system announces the number of new and old messages, then starts to play the messages unless it has no messages.
2. Press [**5**] to stop the announcements or message playback. You will hear intermittent beeps indicating that the system is in the command waiting mode.

3. Press **[6]**. The system plays the current greeting.
4. To keep this greeting: Do nothing.
To switch to the other greeting: Press **[6]** while the system is playing the current greeting.
5. Each time you press **[6]**, the system switches between the pre-recorded and the personal greeting. The last greeting you hear is used as the current greeting.

Deleting Your Personal Greeting

You can delete your personal greeting. You cannot delete the pre-recorded greeting.

1. Press **[M/mute]**. The system announces the number of new and old messages, then starts to play the messages unless it has no messages.
2. Press **[5]** to stop the announcements or message playback. You will hear intermittent beeps indicating that the system is in the command waiting mode.
3. Press **[6]**. The system plays the current greeting. Switch to your personal greeting if necessary. (See the previous section to switch the greeting.)
4. While the personal greeting is playing, press **[4]**.
5. The system announces "Greeting has been deleted," and switches back to the pre-recorded greeting.

Setting the Number of Rings

The ring time setting allows you to set the number of rings the caller hears before your answering system plays the outgoing message. You can set the ring time to answer after six, nine, or twelve rings. If you enable the Toll Saver (TS) setting, the answering system picks up after two rings if you have new messages, and after four rings if there are none. This way, if you make a long distance call to check your messages, you can hang up after the third ring to avoid long distance billing charges.

1. Press **[Select/menu]**.
2. Select the ANSW. SETUP menu, and then the RING TIME submenu.
3. Move the cursor to select a ring time (TOLL SAVER, 6 TIMES, 9 TIMES, or 12 TIMES).
4. Press **[Select/menu]**. You will hear a confirmation tone.

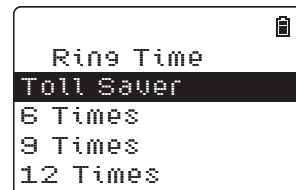

Setting the Record Time (or Announce only)

You can choose how long callers have to record a message. Set the record time to 1 MINUTE or 4 MINUTES to limit the time for incoming messages. If you set the record time to ANNOUNCE ONLY, the answering system answers the call but prevents callers from leaving a message.

1. Press **[Select/menu]**.
2. Select the ANSW. SETUP menu, and then the RECORD TIME submenu.
3. Move the cursor to select a record time (1 MINUTE, 4 MINUTES, or ANNOUNCE ONLY).
4. Press **[Select/menu]**. You will hear a confirmation tone.

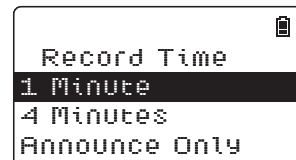

While your answering system is set to ANNOUNCE ONLY, the **message counter** LED on the base displays "A." If you are using the prerecorded greeting, the system automatically switches to the following message: "Hello, no one is available to take your call. Please call again." If you are using a personal greeting, the system continues to use that greeting.

Activating the Message Alert

The message alert feature sounds a short alert tone every fifteen seconds whenever you have a new message.

To turn on the message alert:

1. Press **[Select/menu]**.
2. Select the ANSW. SETUP menu, and then the MESSAGE ALERT submenu.
3. Move the cursor to select ON or OFF.
4. Press **[Select/menu]**. You will hear a confirmation tone.



Activating the Base Call Screen

With the call screen feature, you can listen to callers as they leave a message without answering the call.

1. Press **[Select/menu]**.
2. Select the ANSW. SETUP menu and then the CALL SCREEN submenu.
3. Move the cursor to select ON or OFF.
4. Press **[Select/menu]**. You will hear a confirmation tone.

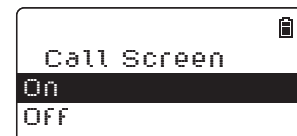



Using the Answering System

Turning Your Answering System On and Off

| | From the base | From the handset |
|-------------|----------------------------------------------------------------------------------------------------------------------------------------------------------------------------------------------------------------------------------------------------------------------------------------------------------------------------------------------------|------------------------------------------------------------------------------------------------------------------------------------------------------------------------------------------------------------------------------------------------------------------------------------|
| Turning On | <ol style="list-style-type: none"> 1. With the phone in standby, press [on/off]. 2. The system announces “Answering System is on” and plays the current greeting. 3. The message counter LED displays the number of messages stored in memory. If the counter flashes, then you have new messages waiting. | <ol style="list-style-type: none"> 1. Press [Select/menu]. 2. Select the ANSW. SETUP menu, and then the ANSWER SETUP submenu. 3. Move the cursor to select ON. 4. Press [Select/menu]. You will hear a confirmation tone. |
| Turning Off | <ol style="list-style-type: none"> 1. With the phone in standby, press [on/off]. 2. The phone announces “Answering System is off.” 3. The message counter LED is no longer illuminated. | <ol style="list-style-type: none"> 1. Press [Select/menu]. 2. Select the ANSW. SETUP menu, and then the ANSWER SETUP submenu. 3. Move the cursor to select OFF. 4. Press [Select/menu]. You will hear a confirmation tone. |

- Notes:
- If the answering system announces “No remaining time” when you turn it on, the memory is full (the **message counter** LED also shows FL). The answering system can’t record any new messages until you delete some of the saved ones.
 - If you do not set the clock, your messages may not have the correct day and time stamp. To set the clock, see page 22.





Reviewing Messages

The **message counter** LED on the base displays the number of messages stored in memory. When you have new messages (that you have not listened to yet), the **message counter** LED on the base and the **new message** LED on the handset flash. The answering system plays your new messages first. If you have no new messages, the system plays your old messages. You can review your messages from the base or from the handset:

| | From the base | From the handset |
|---------------------------|--------------------------------------------------------------------------------------------------------------------------------------------------------------------------------------------------------------------------------------|-----------------------------------------------------------------------------------------------------------------------------------------------------------------------------------------------------------------------------------------|
| Playing new messages | Press [▶/■] . The system announces the number of new and old messages, then plays the first new message followed by the day and time it was received. Then the system plays the new messages in the order they were received. | Press [✉/mute] . The system announces the number of new and old messages, then plays the first new message followed by the day and time it was received. Then the system plays the new messages in the order they were received. |
| Repeating a message | Press [◀◀] once to go to the beginning of the current message. Press [◀◀] repeatedly to go back to a previous message. | Press [1] once to go to the beginning of the current message. Press [1] repeatedly to go back to a previous message. |
| Skipping a message | Press [▶▶] to go to the beginning of the next message. | Press [3] to go to the beginning of the next message. |
| Deleting a message | While a message is playing, press [∅] . The message is permanently deleted. | While a message is playing, press [4] . The message is permanently deleted. |
| Deleting all messages | While the phone is in standby, press [∅] . When the system asks you to confirm, press [∅] again. All messages are permanently deleted. | Not available. |
| Playing old messages | After you listen to your new messages, press [▶/■] again to play your old messages. | After you listen to your new messages, press [✉/mute] again to play your old messages. |
| Ending the message review | Press [▶/■] to stop the message playback and return to standby. | Press [5] to stop the message playback. Press [1] to exit the system and return to standby, or press [2] to restart the message playback. |



Screening Calls

| From the base | From the handset |
|------------------------------------------------------------------------------------------------------------------------------------------------------------------------------------------------------------------------------------------------------------------------------------------------------------------------------------------|--------------------------------------------------------------------------------------------------------------------------------------------------------------------------------------------------------------------------------------------------------------------------------------------------------------------------------------------------------------------------------------------------------------------------------------------------------------|
| <ul style="list-style-type: none"> • While the system is taking the message, simply listen to the caller over the base speaker. (You need to activate the base call screen feature in advance. See page 46.) • To mute the call screen and allow the caller to continue leaving the message, press [▶/■]. | <ul style="list-style-type: none"> • While the systems is recording the message, press [ⓧ/mute]. If another handset is screening a call, you will hear a beep and you will not be able to screen the call. • To answer the call and speak to the caller, press [flash]. • To mute the call screen and allow the caller to continue leaving the message, press [ⓧ] or return the handset to the cradle. |

Turning Off the Message Alert Tone

When all new messages are played back, the message alert tone will automatically deactivate. The tone will not deactivate until all new messages are played back. To quickly turn off the tone, press any key on the base.

Operating the Answering System While You Are Away from Home

When you are away from home, you can operate your answering system with any touch-tone telephone.

Setting a security code or Personal Identification Number (PIN)

To operate your answering system when you are away from home, you will need to enter a two-digit security code or Personal Identification Number (PIN). The default security code is 80.

1. Press **[Select/menu]**.
2. Select the ANSW. SETUP menu, and then the SECURITY CODE submenu.
3. Use the number keypad (**[0]** through **[9]**) to enter a two-digit security code (00-99).
4. Press **[Select/menu]**. You will hear a confirmation tone.

Dialing in to your answering system

Note: If you enter an incorrect security code/PIN three times, you will hear a beep and the answering system will return to standby.





To operate from a remote location, use any touch-tone telephone, and follow these steps:

1. Call your telephone number and wait for the system to answer. If the answering system is off, it will answer after about fifteen rings and sounds a series of beeps.
2. During the greeting or the beeps (if answering system is off), press **[#]** and enter your security code/PIN within two seconds.
3. The answering system announces the current time and the number of messages stored in memory. You hear "To play incoming messages, press pound-two. For help, press pound-zero" followed by a beep.
4. Enter a remote command from the chart below. You have fifteen seconds to enter the first command; after the first command, you have two seconds to enter each command.

| If you want to | Press | If you want to | Press |
|---------------------------------|-----------------------------------------------------------------------------------------------------------------------------------------------------------------------------------------------------|----------------------------------------------------------|----------------------------|
| Play incoming messages | [#] then [2] The answering system plays back messages for four minutes, then waits for another command. To continue playing your messages, press [#] then [2] again. | Stop the current operation to enter a different command. | [#] then [5] |
| Repeat this message | [#] then [1] (after the first four seconds of this message) | Turn the answering system off | [#] then [9] |
| Go back to the previous message | [#] then [1] during the first four seconds of a message | Turn the answering system on | [#] then [6] |
| Skip this message | [#] then [3] | Listen to the help prompts | [#] then [0] |
| Delete this message | [#] then [4] | Exit the system | Hang up. |

5. When you finish, you will hear intermittent beeps indicating that the system is in the command waiting mode. Enter another command from the chart within fifteen seconds.
6. Hang up to exit the system. The answering system automatically returns to its normal standby setting.



Maintenance

Specifications

| | | | |
|------------------------------|---------------------------------|----------------|------------------------|
| Operating temperature | 32° F to 122° F (0° C to 50° C) | | |
| AC adapter | | Base | Charging cradle |
| | Part number | AAD-041S | AAD-600S |
| | Input voltage | 240V AC, 50 Hz | 240V AC, 50 Hz |
| | Output voltage | 9V DC @ 350mA | 9V DC @ 210mA |
| Battery pack | Part number | BT-694 | |

Notes:

- Use only the supplied AC adapters.
- Be sure to use the proper adapter for the base and any chargers.
- Do not place the power cord where it creates a trip hazard or where it could become chafed and create a fire or electrical hazard.
- Do not place the base in direct sunlight or subject it to high temperatures.

Battery Information

Battery life

With average use, your handset battery provides more than ten hours of talk time and approximately seven days of standby time. You can achieve optimum battery life and performance by returning the handset to the base or charging cradle after each use. When your handset is left off of the cradle, the battery will gradually discharge even if the handset is not being used. The actual talk time duration will be reduced in proportion to the amount of time the handset is off of the cradle.

Low battery alert

When the battery pack is very low, the phone is programmed to eliminate functions in order to save power. When LOW BATTERY - CHARGE HANDSET appears in the handset display and the phone is in standby, none of the keys will operate. If you are on a call, complete your conversation as quickly as possible, and return the handset to the cradle.

The battery pack needs to be charged when the empty battery icon appears.

Cleaning the charging contacts

To maintain a good charge, clean the charging contacts on the handset once a month. Dampen a cloth with plain water. Gently rub the damp cloth over the charging contacts until all visible dirt is removed. Dry the contacts thoroughly before returning the handset to the cradle.

Caution: Do not use paint thinner, alcohol, or other chemical products. Doing so may discolor the surface of the telephone and damage the finish.

Battery replacement and handling

With average use, your phone's battery should last approximately two years. To order replacement batteries, please contact Uniden's Parts Department. The contact information is listed on inside the back cover.

Caution:

- Use only battery pack BT-694.
- Do not remove the batteries from the handset to charge them.
- Never throw the battery into a fire, disassemble, or heat them.
- Do not remove or damage the battery casing.

Power Failures

During a power failure, you will not be able to make or receive calls with the phone. To avoid damage from an electrical spike when the power comes back on, we recommend you unplug your phone during power outages.

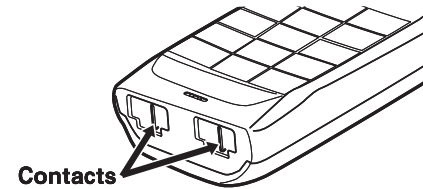
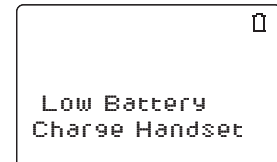

Troubleshooting

Common Issues

If your phone is not performing to your expectations, please try these simple steps first. If these steps do not solve your problem, please contact Uniden. See warranty on inside back cover for contact information.

| When you have this problem... | Try... |
|----------------------------------------------------------------------------------|----------------------------------------------------------------------------------------------------------------------------------------------------------------------------------------------------------------------------------------------------------------------------------------------------------------------------------------------------------------------------------------------------------------|
| The charge LED won't illuminate when the handset is placed in the cradle. | <ul style="list-style-type: none"> • Checking the AC adapter connection (see page 7). • Re-seating the handset in the cradle. • Cleaning the charging contacts on the handsets (see page 52). |
| The audio sounds weak. | <ul style="list-style-type: none"> • Moving the handset closer to the base. • Moving the handset and/or base away from metal objects or appliances and try again. |
| No handsets can make or receive calls. | <ul style="list-style-type: none"> • Checking the telephone cord connection. If CHECK TEL LINE appears on the handset display, the telephone cord may not be connected correctly (see page 9). • Disconnecting the base AC adapter. Wait a few minutes, then reconnect it (see page 7). |
| A single handset can't make or receive calls (but other handsets can). | <ul style="list-style-type: none"> • Checking the battery pack connection (see page 6). • Charging the battery for 15 to 20 hours. • Moving the handset closer to the base. • Making sure the line is not in use. If an outside call is already using a line, you cannot use that line to make another outside call. • Resetting the handset (see page 55). |
| A handset can make calls, but it doesn't ring or receive a page. | <ul style="list-style-type: none"> • Making sure the ringer isn't turned off (see page 36). |

| When you have this problem... | Try... |
|------------------------------------------------------|-----------------------------------------------------------------------------------------------------------------------------------------------------------------------------------------------------------------------------------------------------------------------------------------------------------------------------------------------------------------------------|
| Severe noise interference. | <ul style="list-style-type: none"> • Keeping all handsets away from microwave ovens, computers, wireless LAN station, remote control toys, wireless microphones, alarm systems, intercoms, room monitors, fluorescent lights, and electrical appliances (see page 5). • Moving the base to another location or turn off the source of interference. |
| The Caller ID does not display. | <ul style="list-style-type: none"> • Checking to see if the call was placed through a switchboard. • Asking your telephone company to verify your Caller ID service is current. There may be a problem with your Caller ID service. |
| I can't register the handset at the base. | <ul style="list-style-type: none"> • Charging the battery for 15 to 20 hours. • Resetting the handset (see page 55). |
| The handset doesn't communicate with other handsets. | <ul style="list-style-type: none"> • Register all handsets to the same base, and then select the same base on all handsets (see page 14). |
| I can't join the conversation. | <ul style="list-style-type: none"> • Checking to see that there are not two handsets already using the conference feature (see page 38). • Checking to see that another handset is not in privacy mode (see page 40). • Register all handsets to the same base, and then select the same base on all handsets (see page 14). |
| The answering system does not work. | <ul style="list-style-type: none"> • Checking the AC adapter connection (see page 7). • Checking to see if the answering system is turned on (see page 47). |
| The answering system does not record any messages. | <ul style="list-style-type: none"> • The memory may be full. Delete some or all of the saved messages (see page 48). • Checking to see that the message record time is not set to announce only (see page 45). |

| When you have this problem... | Try... |
|---------------------------------------------------------------------------------|--------------------------------------------------------------------------------------------------------------------------------------------------------------------------------------------------------------------------------------------------------------------------------------------------|
| The answering system doesn't say what time messages were recorded. | <ul style="list-style-type: none"> • Checking to see if you have set the time (see page 22). |
| Messages are incomplete. | <ul style="list-style-type: none"> • The incoming messages may be too long. Ask callers to leave a brief message. • The memory may be full. Delete some or all of the saved messages (see page 48). |
| I can't hear base or handset speaker during call screening or message playback. | <ul style="list-style-type: none"> • Adjusting the speaker volume on the base or handset (see page 37). • Checking to see if the call screen feature is set to on (see page 46). |
| I can't access answering system from a remote phone. | <ul style="list-style-type: none"> • Checking to see if you are using the correct PIN number (see page 49). • Checking to see if the touch-tone phone you're using can transmit the tone for at least two seconds. If it cannot, try using a different touch-tone phone. |

Resetting the Handset

You may need to reset your handset in the following instances:

- You lose a handset and purchase a new one.
- You get the message Registration Failed when you try to register the handset.
- You are unable to register any handsets to the base.
- When you register new handsets to the base, the handset IDs do not match. (For example, the handset registers as "Handset #4" but you only have two handsets.)
- When you are instructed to by one of Uniden's call center representatives.

1. Select the base you want to de-register the handset from (see Selecting the Base on page 14).
2. Press and hold **[*]** and **[#]** for more than five seconds. Select DEREGISTER HS.
3. Select the handset which you are operating, and then press **[Select/menu]**.

4. The phone will ask you to confirm the deregistration. Select YES. The selected handset will clear its registration information only from the base it is currently connected to, and then delete the link to the base from its own memory.
5. When the base information is deleted, the handset displays HANDSET NOT REGISTERED-PLACE HANDSET ON BASE TO REGISTER. SEE YOUR OWNER'S MANUAL FOR HELP.
6. Re-register the handset to the base (see Registering Accessory Handsets on page 12).

If the handset cannot contact the base, it will display OUT OF RANGE. Make sure the handset is in range of the base and the base is connected to power; you can also reset the handset without the base (see the next section).

Resetting the Handset Without the Base

If your original base is not available for some reason, you can still reset the handset and use it with another base.

1. Press and hold **[*]** and **[#]** for at least five seconds.
2. Move the cursor to select BASE UNAVAILABLE and then press **[Select/menu]**.
3. Select the base which you want to de-register from, and then press **[Select/menu]**. BASE UNAVAILABLE appears.
4. Move the cursor to select YES, and then press **[Select/menu]**. You hear a confirmation tone, and the handset deletes its own base information without contacting the base. The handset displays HANDSET NOT REGISTERED-PLACE HANDSET ON BASE TO REGISTER. SEE YOUR OWNER'S MANUAL FOR HELP.
5. Register the handset to the new base (see Registering Accessory Handsets on page 12).

Changing the Line Mode for Multiple Extensions

Line mode refers to the method that telephones use to signal each other that an extension is in use. Customer service may recommend changing the line mode if you have any of the following problems:

- Your phone keeps ringing after someone answers on an extension phone.
 - Your answering system doesn't stop recording when you answer on an extension phone.
 - Caller ID displays briefly and then clears.
1. If you have multiple bases, select the base that is having problems (see page 14).
 2. Press **[Select/menu]**. Select the GLOBAL SETUP menu, and then the SET LINE MODE submenu.
 3. IF INSTRUCTED BY CUSTOMER SERVICE PRESS **[SELECT]** appears. Press **[Select/menu]**.
 4. Move the cursor to select TYPE - A, TYPE - B, or OFF.
 5. Press **[Select/menu]**. You will hear a confirmation tone.

Traveling Out of Range

During a call, if you move your handset too far from your base, noise may increase. If you pass the range limit of the base, the handset will beep, display OUT OF RANGE, and then go to standby. The base will maintain the connection for thirty seconds after the handset goes out of range. If you move the handset back within range of the base within thirty seconds, press **[/flash]** or **[▶▶]** to pick up the call again.

Note: If it is set to automatically select the available base, the handset will begin searching for another base thirty seconds after going out of range. (see Selecting the Base on page 14).

Liquid Damage

Moisture and liquid can damage your cordless phone.

- If the handset or base is exposed to moisture or liquid, but only the exterior plastic housing is affected, wipe off the liquid, and use as normal.
- If moisture or liquid has entered the plastic housing (i.e. liquid can be heard in the phone or liquid has entered the handset battery compartment or vent openings on the base), follow the steps below:

| Handset | Base |
|--------------------------------------------------------------------------------------------------------------------------------------------------------------------------------------------------------------------------------------------------------------------------------------------------------------------------------------------------------------------------------------------------------------------------------|-------------------------------------------------------------------------------------------------------------------------------------------------------------------------------------------------------------------------------|
| <ol style="list-style-type: none"> 1. Remove the battery cover and leave it off for ventilation. 2. Disconnect the battery pack. Leave the battery cover off and the battery pack disconnected for at least 3 days. 3. Once the handset is completely dry, reconnect the battery pack and the battery cover. 4. Recharge the handset's battery pack for 15 to 20 hours before using. | <ol style="list-style-type: none"> 1. Disconnect the AC adapter from the base, cutting off electrical power. 2. Disconnect the telephone cord from the base. 3. Let dry for at least 3 days. |

IMPORTANT: You must unplug the telephone line while recharging the battery packs to avoid charge interruption.

CAUTION: **DO NOT use a microwave oven to speed up the drying process. This will cause permanent damage to the handset, base and the microwave oven. After following these steps, if your cordless telephone does not work, please visit www.uniden.com.au for Australian models and www.uniden.co.nz for New Zealand models for customer support.**

Precautions!

Before you read anything else, please observe the following:

Warning!

Uniden Australia Pty Ltd and Uniden NZ Ltd DO NOT represent this unit to be waterproof. To reduce the risk of fire, electrical shock, or damage to the unit, DO NOT expose this unit to rain or moisture.

Rechargeable Nickel-Metal-Hydride Battery Warning

- This equipment contains a rechargeable Nickel-Metal-Hydride battery.
- The rechargeable batteries contained in this equipment may explode if disposed of in a fire.
- Do not short-circuit the battery.
- Do not charge the rechargeable battery pack used in this equipment with in any charger other than the one designed to charge this battery pack as specified in the owner's manual. Using another charger may damage the battery pack or cause the battery pack to explode.

Rechargeable Batteries Must Be Recycled or Disposed of Properly.

Uniden works to reduce lead content in our PVC coated cords in our products and accessories.

Important Safety Instructions

When using your telephone equipment, basic safety precautions should always be followed to reduce the risk of fire, electric shock and injury to persons, including the following:

1. Do not use this product near water, for example, near a bath tub, wash bowl, kitchen sink or laundry tub, in a wet basement or near a swimming pool.
2. Avoid using a telephone (other than a cordless type) during an electrical storm. There may be a remote risk of electric shock from lightning.
3. Do not use the telephone to report a gas leak in the vicinity of the leak.
4. Use only the power cord and batteries indicated in this manual. Do not dispose of batteries in a fire. They may explode. Check with local authorities for possible battery disposal instructions.
5. Do not disassemble any component of this product.

SAVE THESE INSTRUCTIONS

CAUTION

Risk of explosion if battery is replaced by an incorrect type. Dispose of used batteries according to the instructions. Do not open or mutilate the battery, and disconnect the battery before shipping this product.

Index

- A**
- Accessory handsets 12
 - Answering calls 31
 - Answering system
 - Reviewing messages 48
 - Setting up 43
 - Turning on/off 47
 - When away from home 49
 - Any key answer 29
 - Audio tone 37
 - AutoTalk 29
- B**
- Banner 28
 - Base
 - Installing 7
 - Multiple bases 13
 - Parts of the base 18
 - Battery
 - Battery life 51
 - Installing 6
 - Low battery alert 52
 - Replacement and handling 52
 - Belt clip 11
- C**
- Caller ID 33
 - Deleting Caller ID records 34
 - Making calls from 33
 - Call screening 46, 49
 - Call waiting 35
 - Chain dialing 32
 - Color scheme 29
 - Conferencing 38
- D**
- Day and time 22
- F**
- Finding a handset 38
 - Four-way function key 20
- G**
- Greetings
 - Deleting 44
 - Recording 43
 - Selecting 43
- H**
- Handset
 - Accessory handsets 12
 - Banner 28
 - Choosing a ringer 28
 - Color scheme 29
 - Copying phonebook entries 27
 - Entering text 21
 - Finding 38
 - LCD contrast 30
 - Parts of the handset 17
 - Reading the display 19
 - Registering 12, 13
 - Resetting 55, 56
 - Wallpaper 30
 - Hanging up 31
 - Headset 42
 - Hold 38
- I**
- Installation 5
 - Insert 0 23
 - Intercom 40
- K**
- Key touch tone 23
 - Keypad Lock 30
- L**
- LCD contrast 30
 - Line mode for base 57

Liquid damage 58
Low battery alert 52

M

Maintenance 51
Making calls 31
 Using Caller ID 33
 Using redial 35
 Using the phonebook 32
Message alert 46, 49
Multiple bases 13
Mute
 Microphone 41
 Ringer 36

N

Name Tag 23

O

Out of range 57

P

Personal color 22, 25
Personal identification number
 (PIN) 49
Personal ring 22, 25
Phonebook 24

Copying entries 27
Creating new entries 24
Deleting entries 26, 27
Editing entries 26
Finding entries 25
Making a call from 32
Storing Caller ID or redial
 numbers 26
Privacy mode 40

R

Redial
 Deleting a record 35
 Making a calls with 35
Ringer
 Choosing a handset ringer 28
 Muting 36
 Personal ring 22, 25
 Volume 36

S

Safety notices 59
Screening calls 46, 49
Security code 49
Selecting the base 14

T

Text, entering 21

Transferring a call 39
Troubleshooting 53





V

Volume, adjusting 36

W

Wallpaper 30
Warranty 66

Remote Operation Card

| | | | |
|----------------------------------------------------------------------------------------------------------------------------------------------------------------------------------------------------------------------------------------------------------------------------------------------------------------------------------------------------------|-------------------------------------------------------------------------------------------------------------------------------------------------------------------------------------------------------------------------------------------------------------------------------------------------------------------------------------|----------------------------------------------------------------------------------------------------------------------------------------------------------------------------------------------------------------------------------------------------------------------------------------------------------------------------------------------------------|-------------------------------------------------------------------------------------------------------------------------------------------------------------------------------------------------------------------------------------------------------------------------------------------------------------------------------------|
| CUT | | CUT | |
| REMOTE OPERATION CARD | | REMOTE OPERATION CARD | |
|  | |  | |
| Remote access away from home <ol style="list-style-type: none">1. Call your phone number from a touch-tone phone.2. During the outgoing message, press # and enter your PIN code. The answering system announces the number of messages stored in memory and the voice prompts.3. To quit, hang up the phone. | Turn on the answering system remotely <ol style="list-style-type: none">1. Call your phone and let it ring 15 times until you hear a beep.2. Press # and then enter your PIN code.3. Press # then 5 to stop the announcement.4. Press # then 6 to turn the answering system on. | Remote access away from home <ol style="list-style-type: none">1. Call your phone number from a touch-tone phone.2. During the outgoing message, press # and enter your PIN code. The answering system announces the number of messages stored in memory and the voice prompts.3. To quit, hang up the phone. | Turn on the answering system remotely <ol style="list-style-type: none">1. Call your phone and let it ring 15 times until you hear a beep.2. Press # and then enter your PIN code.3. Press # then 5 to stop the announcement.4. Press # then 6 to turn the answering system on. |
| CUT | | CUT | |
| REMOTE OPERATION CARD | | REMOTE OPERATION CARD | |
|  | |  | |
| Remote access away from home <ol style="list-style-type: none">1. Call your phone number from a touch-tone phone.2. During the outgoing message, press # and enter your PIN code. The answering system announces the number of messages stored in memory and the voice prompts.3. To quit, hang up the phone. | Turn on the answering system remotely <ol style="list-style-type: none">1. Call your phone and let it ring 15 times until you hear a beep.2. Press # and then enter your PIN code.3. Press # then 5 to stop the announcement.4. Press # then 6 to turn the answering system on. | Remote access away from home <ol style="list-style-type: none">1. Call your phone number from a touch-tone phone.2. During the outgoing message, press # and enter your PIN code. The answering system announces the number of messages stored in memory and the voice prompts.3. To quit, hang up the phone. | Turn on the answering system remotely <ol style="list-style-type: none">1. Call your phone and let it ring 15 times until you hear a beep.2. Press # and then enter your PIN code.3. Press # then 5 to stop the announcement.4. Press # then 6 to turn the answering system on. |

CUT

| Task | Key |
|------------------------|--------------|
| Repeat a Message | #oper 1 |
| Play Incoming Messages | #oper 2 abc |
| Skip a Message | #oper 3 def |
| Delete a Message | #oper 4 ghi |
| Stop Operation | #oper 5 jkl |
| Answering System On | #oper 6 mno |
| Answering System Off | #oper 9 wxyz |
| Help | #oper 0 oper |

CUT

| Task | Key |
|------------------------|--------------|
| Repeat a Message | #oper 1 |
| Play Incoming Messages | #oper 2 abc |
| Skip a Message | #oper 3 def |
| Delete a Message | #oper 4 ghi |
| Stop Operation | #oper 5 jkl |
| Answering System On | #oper 6 mno |
| Answering System Off | #oper 9 wxyz |
| Help | #oper 0 oper |

CUT

| Task | Key |
|------------------------|--------------|
| Repeat a Message | #oper 1 |
| Play Incoming Messages | #oper 2 abc |
| Skip a Message | #oper 3 def |
| Delete a Message | #oper 4 ghi |
| Stop Operation | #oper 5 jkl |
| Answering System On | #oper 6 mno |
| Answering System Off | #oper 9 wxyz |
| Help | #oper 0 oper |

CUT

| Task | Key |
|------------------------|--------------|
| Repeat a Message | #oper 1 |
| Play Incoming Messages | #oper 2 abc |
| Skip a Message | #oper 3 def |
| Delete a Message | #oper 4 ghi |
| Stop Operation | #oper 5 jkl |
| Answering System On | #oper 6 mno |
| Answering System Off | #oper 9 wxyz |
| Help | #oper 0 oper |

MEMO

MEMO



ONE YEAR LIMITED WARRANTY

UNIDEN DECT ELITE 9035, 9035+1 and 9035+2 CORDLESS PHONE

IMPORTANT : Evidence of original purchase is required for warranty service.

WARRANTOR : Uniden Australia Pty Limited A.B.N. 58 001 865 498

Uniden New Zealand Limited

Warranty only available in original country of purchase.

ELEMENT OF WARRANTY :

Uniden warrants to the original retail owner for the duration of this warranty, its UNIDEN DECT ELITE 9035, 9035+1 and 9035+2 CORDLESS PHONE (herein after referred to as the Product), to be free from defects in materials and craftsmanship with only the limitations or exclusions set out below.

WARRANTY DURATION:

This warranty to the original retail owner only, shall terminate and be of no further effect ONE (1) year after the date of original retail sale. This warranty will be deemed invalid if the Product is;

- (A) Damaged or not maintained as reasonable and necessary,
- (B) Modified, altered or used as part of any conversion kits, subassemblies, or any configurations not sold by Uniden,
- (C) Improperly installed,
- (D) Repaired by someone other than an authorized Uniden Repair Agent for a defect or malfunction covered by this warranty,
- (E) Used in conjunction with any equipment or parts or as part of a system not manufactured by Uniden, or
- (F) Where the Serial Number label of the product has been removed or damaged beyond recognition.

Warranty only valid in the country of original retail/sale.

PARTS COVERED:

This warranty covers for one (1) year, the Product and included accessories.

STATEMENT OF REMEDY:

In the event that the Product does not conform to this warranty at any time while this warranty is in effect, the warrantor at its discretion, will repair the defect or replace the Product and return it to you without charge for parts or service. This warranty does not provide for reimbursement or payment of incidental or consequential damages.

This EXPRESS WARRANTY is in addition to and does not in any way affect your rights under the TRADE PRACTICES ACT 1974 (Cth) (Australia) or the CONSUMER GUARANTEES ACT (New Zealand).

PROCEDURE FOR OBTAINING PERFORMANCE OR WARRANTY:

In the event that the Product does not conform to this warranty, the Product should be shipped or delivered, freight pre-paid, with evidence of original purchase (e.g. a copy of the sales docket), to the warrantor at:

UNIDEN AUSTRALIA PTY LIMITED

SERVICE DIVISION

345 Princes Highway, Rockdale NSW 2216

Fx(02) 9599 3278

www.uniden.com.au

Customers in other States should ship or deliver the Product freight pre-paid to their nearest Uniden Authorized Repair Centre (Contact Uniden for the nearest Warranty Agent to you).

UNIDEN NEW ZEALAND LIMITED

SERVICE DIVISION

150 Harris Road, East Tamaki, Auckland

Fx(09) 274 4253

www.uniden.co.nz





Uniden[®]

© 2008 Uniden Australia Pty Limited/Uniden New Zealand Limited
Printed in China UCZZ01541BZ(0)

Free Manuals Download Website

<http://myh66.com>

<http://usermanuals.us>

<http://www.somanuals.com>

<http://www.4manuals.cc>

<http://www.manual-lib.com>

<http://www.404manual.com>

<http://www.luxmanual.com>

<http://aubethermostatmanual.com>

Golf course search by state

<http://golfingnear.com>

Email search by domain

<http://emailbydomain.com>

Auto manuals search

<http://auto.somanuals.com>

TV manuals search

<http://tv.somanuals.com>