

THE DGA940 DGMax

OWNER'S MANUAL

Super Digital Spread Spectrum

provides the longest range,

the clearest sound

and the best privacy.

Uniden

CONTROLS & FUNCTIONS

OF YOUR NEW PHONE

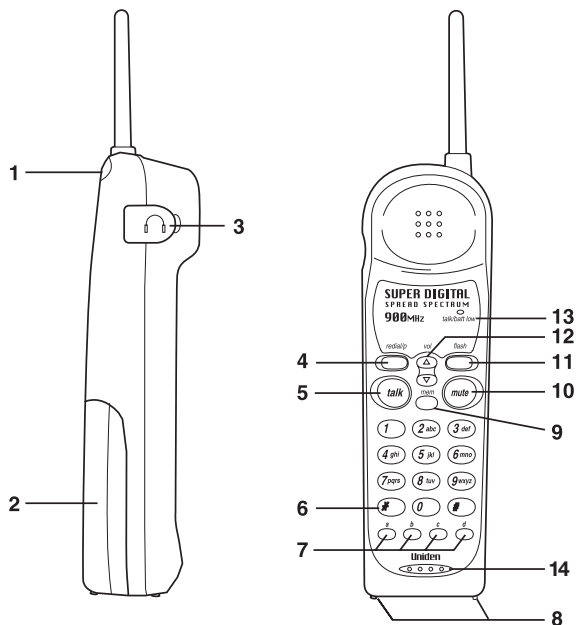

1. Slo
2. Ba
3. He
4. Re
5. Ta
6. ★
7. On
8. Ch
9. Me
10. Mu
11. Fla
12. Vo
13. Ta
14. Ha

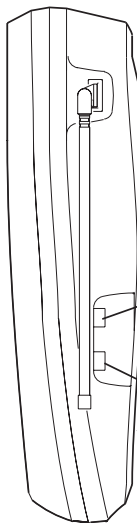
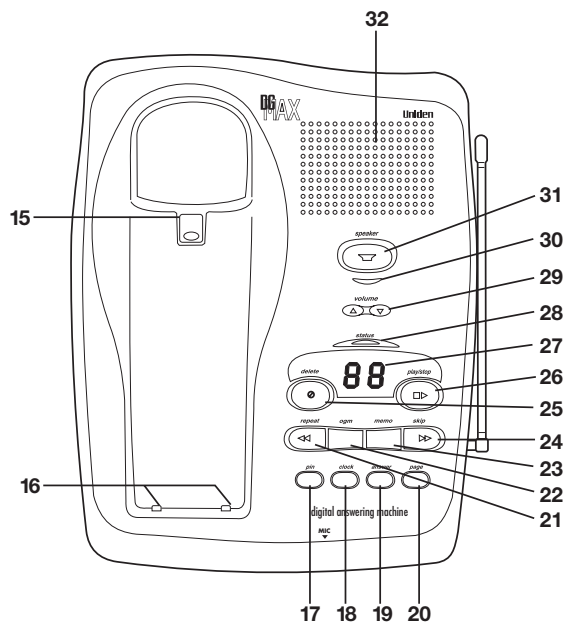

ot Cover
 ttery Compartment
 adset Jack
 dial/Pause
 k
 (Tone)
 ne-Touch Dialing Memory
 arging Contacts
 em
 ate
 sh
 l Up and Down
 k/Batt Low LED
 handset Microphone

15. Handset Retainer Clip
 16. Charging Contacts
 17. Pin
 18. Clock
 19. Answer
 20. Page
 21. Repeat
 22. OGM
 23. Memo
 24. Skip
 25. Delete
 26. Play/Stop
 27. LED Display
 28. Status LED

29. Volume Up and Down
 30. Speaker LED
 31. Speaker Button
 32. Speaker
 33. Ring Time Switch
 34. Rec Time Switch
 35. Beltclip Holder
 36. Base Microphone
 37. Spare Battery Compartment
 38. Reset
 39. Base Ringer Off-On Switch
 40. Pulse-Tone Switch
 41. 10V DC Jack
 42. Tel Line Jack

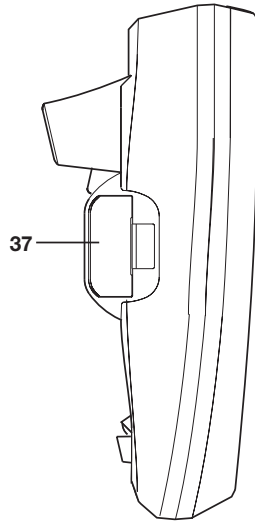
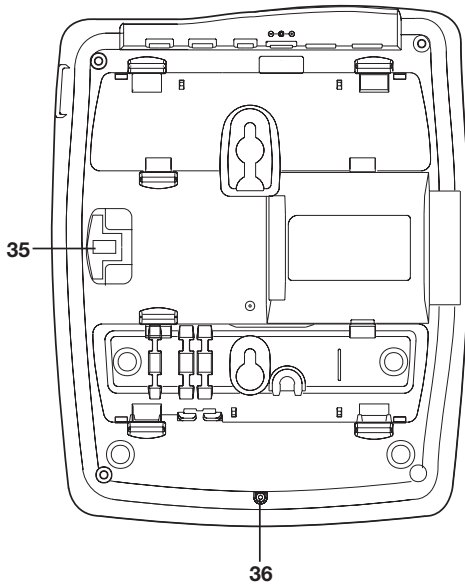
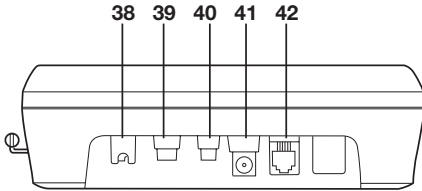

CONTENTS

OF YOUR OWNERS MANUAL

CONTENTS

Controls And Functions	inside front cover
Precautions	2
Important Safety Instructions	3
Important Electrical Considerations	4
Introduction	6
Welcome	6
Features	6
Included In Your Package	7
Installing and Adjusting your Phone	8
Installation Considerations	8
Desk/Tabletop Installation	9
Wall Installation	10
Installing the Handset Battery Pack	14
Charging the Battery Pack	15
Cleaning the Battery Contacts	16
Setting the Pulse/Tone Switch	16
Adjusting the Volume Controls	17
Adjusting the Ringer Tone	17
Installing the Beltclip	18
Headset Installation	19
Automatic Digital Code Security	19
Using Your New Phone	20
Making and Receiving Calls	20
Tone	21
Flash and Call Waiting	21
Page	21
Mute	21
Storing a Phone Number in Memory	22
Dialing a Number In Memory	22
Erasing a Stored Number from Memory	22
Chain Dialing	23
Travelling Out-Of-Range	23
PABX Connection	23
The Integrated Answering Device	24
Features	24
Turning the Answering System On and Off	24
Setting the Clock	25
Recording Your Outgoing Message	26
Selecting the Message Time	27
Setting the Ring Time Switch	27
Selecting a PIN Code	28
Playing Your Messages	29
Repeating a Message	29
Skipping a Message	30
Deleting a Message	30
Recording a Voice Memo	31
Using the Reset Button	31
Remote Room Monitor	32
Remote Access Away from Home	33
Troubleshooting	34
Quick Reference Chart	34
Specifications	36
Warranty	37

Introduction

Installing and
Adjusting

Using Your
New Phone

Setting Up
Answering Device

Using Answering
Device

Troubleshooting

Specifications

PRECAUTIONS

FOR YOUR PHONE

PRECAUTION

Before you read anything else, please observe the following:

Warning!

UNIDEN AUSTRALIA Pty. Ltd. DOES NOT represent this unit to be waterproof. To reduce risk of fire, electrical shock or damage to the unit, DO NOT expose this unit to rain or moisture.

Rechargeable Nickel-Cadmium Battery Warning

- This equipment contains a rechargeable nickel-cadmium battery.
- The rechargeable nickel-cadmium battery contained in this equipment may explode if disposed of in a fire.
- Do not short-circuit the battery.
- Do not charge the rechargeable nickel-cadmium battery used in this equipment in any charger other than the one designed to charge this battery as specified in this the owner's manual. Using another charger may damage the battery or cause the battery to explode.



The exclamation point within an equilateral triangle is intended to alert the user of the presence of important operating and maintenance (servicing) instructions in the literature accompanying the appliance.

IMPORTANT SAFETY INSTRUCTIONS

When using your telephone equipment, these basic safety precautions should always be followed to reduced the risk of fire, electrical shock, and injury to persons:

1. Read and understand all instructions.
2. Follow all warnings and instructions marked on the product.
3. Unplug this product from the wall outlet before cleaning, and use a dry cloth, without liquid or aerosol cleaners.
4. Do not use this product near water; for example, near a bathtub, washbowl, kitchen sink or laundry tub, in a wet basement or near a swimming pool.
5. Do not place this product on an unstable cart, stand or table. The telephone may fall, causing serious damage to the unit.
6. This product should be operated only from the type of power source indicated on the marking label. If you are not sure of the type of power supply to your home, consult your dealer or local power company.
7. Do not allow anything to rest on the power cord. Do not locate this product where the cord will be damaged by persons walking on it.
8. Do not overload wall outlets and extension cords, as this can result in the risk of fire or electrical shock.
9. Never push objects of any kind into this product through cabinet slots, as they may touch dangerous voltage points or short out parts that could result in a risk of fire or electric shock. These slots and openings are provided for ventilation. Never spill liquid of any kind on the product.
10. To reduce the risk of electric shock, do not disassemble this product. Take it to qualified service personnel when service or repair work is required. Opening or removing covers may expose you to dangerous voltages or other risks. Incorrect reassembly can cause electric shock when the appliance is subsequently used.
11. Unplug this product from the wall outlet and refer servicing to qualified service personnel under the following conditions:
 - A. If the power supply cord is damaged or frayed.
 - B. If liquid has been spilled into the product.
 - C. If the product has been exposed to rain or water.
 - D. If the product does not operate normally when following the operating instructions. (Adjust only those controls that are covered by the operating

instructions. Improper adjustment of other controls may result in damage, and will often require extensive repair work by a qualified technician).

- E. If the product has been dropped, or the cabinet has been damaged.
 - F. If the product exhibits a distinct change in performance.
12. Do not use the telephone to report a gas leak in the vicinity of the leak.

Additional Battery Safety Precautions

Caution! To reduce the risk of fire or injury to persons by the battery, read and follow these instructions.

1. Use only the appropriate type and size battery pack specified in the owner's manual.
2. Do not dispose of the battery pack in a fire. The cell may explode.
3. Do not open or mutilate the battery pack. Release electrolyte is corrosive and may cause damage to the eyes or skin. It may be toxic if swallowed.
4. Exercise care in handling the battery in order not to short the battery with conducting materials such as rings, bracelets and keys.
5. Charge the battery pack provided with or identified for use with this product only in accordance with the instructions and limitations.
6. Observe proper polarity orientation between the battery pack and battery charger.

IMPORTANT ELECTRICAL CONSIDERATIONS

Unplug all electrical appliances when you know an electrical storm is approaching. Lighting can pass through your household wiring and damage any device connected to it. This phone is no exception.



Please do not attempt to unplug any appliance during an electrical storm.

Range

Your new phone is designed to achieve the maximum possible range by transmitting and receiving according to the highest specifications. We have rated this phone to operate at a maximum distance with the qualification that the range depends upon the environment in which the telephone is used. Many

factors limit range, and it would be impossible to include all the variables in our rating. The Maximum Range rating of this phone is meant to be used as a means of comparison against other range claims.

Telephone Line Problems

If you are having trouble with your telephone service, you must first disconnect your phone to determine if it is the cause of your problem. If you determine that it is the cause, you must leave it disconnected until the trouble has been corrected.



Under power failure, this telephone may not operate. Please ensure that a separate phone, not dependent on local power is available during emergencies.

Radio Interference

Radio interference may occasionally cause buzzing and humming in your cordless handset, or clicking noises in the base. This interference is caused by external sources such as TV, refrigerator, vacuum cleaner, fluorescent lighting or electrical storm. Your unit is NOT DEFECTIVE. If these noises continue and are too distracting, please check around your home to see what appliances may be causing the problem. In addition, we recommend that the base not be plugged into a circuit that also powers a major appliance because of the potential for interference. Be certain that the antenna on the unit is raised vertically.

In the unlikely event that you consistently hear distracting transmissions on your phone, you may be receiving radio signals from another cordless telephone or other source of interference.

Finally, it should be noted that some cordless telephones operate at frequencies that may cause interference to nearby TV's or VCR's. To minimise or prevent such interference, the base of the cordless telephone should not be placed near or on top of a TV or VCR. If interference is experienced, moving the cordless telephone farther away from the TV or VCR will often reduce or eliminate the interference.

More Than One Phone

Each telephone device that you connect draws power from the phone line. We refer to the power drawn as the device's Ringer Equivalence Number (REN). The REN is shown at the bottom part of your telephone. If you are using more than one phone or other device on the line, add up all the RENs. If the total is more than 3, your phones might not ring.

WELCOME

Congratulations on your purchase of the Uniden **DGA940 DGMax** cordless telephone. This phone is designed for reliability, long life, and outstanding performance utilising the latest in 900 MHz Spread Spectrum Technology.

FEATURES

- 900 MHz Spread Spectrum Technology
- Integrated Telephone Answering Device (ITAD)
- 4 One-Touch Memory Locations
- Any key Answer
- Speakerphone
- Back-up Power Supply using Optional Battery Pack
- Headset Compatible
- Handset Earpiece and Ringer Volume Control
- 15 Channel AutoScan
- 20 Enhanced Memory Dial Locations
- 32 Digit Redial
- Hearing Aid Compatible
- Redial, Flash, Page and Pause
- Pulse/Tone Dialing
- 7-Day Standby Battery Time
- 4-Hour Talk Time

Digital Spread Spectrum Technology utilises a digital transmission and a “wider frequency band” vs. a “single narrow band” 30/39 Standard Analogue transmission. The result is a more secure conversation with the clarity of digital sound, extended range, and minimal interference from other cordless phones.

Random Code™ digital security automatically selects one of over 65,000 codes for the handset and base. This feature prevents unauthorised calls as a result of your phone being activated by other equipment.

INCLUDED IN YOUR PACKAGE



To get the most from your phone, please read this owner's manual thoroughly. Be sure to complete and mail the product registration form.



If any of these items are missing or damaged, contact your place of purchase.



Handset

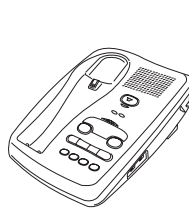

Base

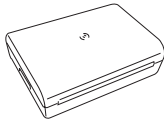

BT-900
Rechargeable Battery

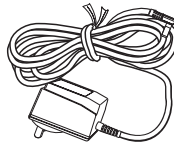

AAD 950U
AC Adaptor

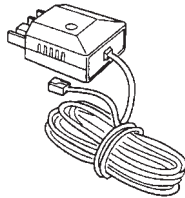

Long Telephone
Cord/Plug

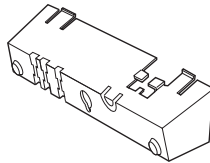

Desktop/Wall
Mount Adaptor



Beltclip

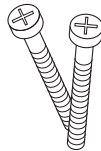

Wall Mounting Screws

- This Owner's Manual
- Registration Card
- Quick Reference Guide and other printed materials

INSTALLATION CONSIDERATIONS

▼ *Selecting a Location*

Before choosing a location for your new phone, here are some important guidelines you should consider:

- The location should be close to both a phone jack and a power outlet.
- Keep the base and handset away from sources of electrical noise such as motors and fluorescent lighting.
- Be sure there is sufficient space to rotate the base antenna fully vertical.
- The base can be placed on a desk, tabletop or mounted on a standard wall plate.
- You should charge the battery in your handset for 15-20 hours before connecting the phone line.
- Most phone equipment available now uses modular jacks. Phone cords are fitted with a molded plastic connector which plugs into this type of jack. If you do not have a modular phone jack, contact your local telephone company for information about their installation.



▼ *Connecting the Telephone Cords*

Consider these safety guidelines before connecting the telephone cord.

Caution!

- Never install telephone wiring during a lightning storm.
- Never touch uninsulated telephone wires or terminals unless the telephone line has been disconnected.
- Use caution when installing or modifying telephone lines.

NOTE

Before connecting your phone line, fully charge the Nickel-Cadmium battery pack for 15-20 hours.

DESK/TABLETOP INSTALLATION

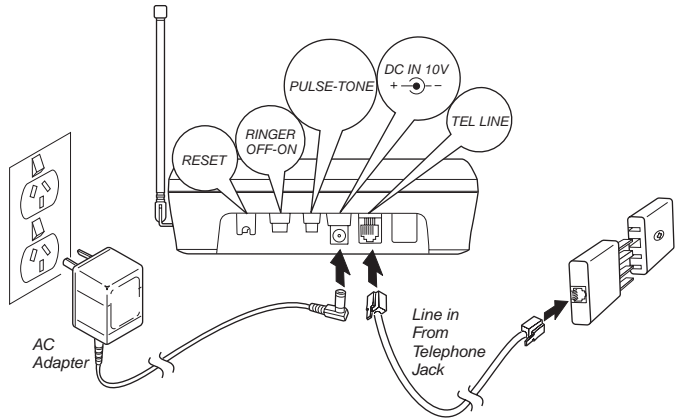

1. Snap the desktop/wall mount adaptor into the top of the base as shown.
2. Plug the AC adaptor cord into the 10V DC input jack on the back of the base.
3. Wrap the AC adaptor cord around the strain relief notch.
4. Plug the AC adaptor into a standard 240V AC wall outlet.
5. Charge the battery (See **CHARGING THE BATTERY PACK**, page 15).
6. Plug one end of the telephone cord into the **TEL LINE** jack on the back of the base.
7. Plug the other end of the cord into the telephone jack on the wall.
8. Set the base on a desk or tabletop with the keypad facing up or down then place the handset into the base. Raise the antenna to a vertical position.

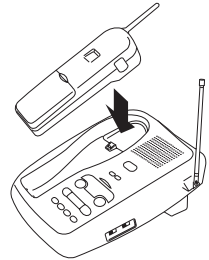
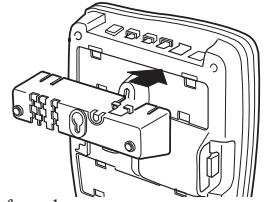

Place the power cord so that it does not create a trip hazard or where it could become chafed and create a fire or electrical hazard.



Use only the Uniden AC adaptor supplied with this phone plugged to uninterrupted power supply.

WALL INSTALLATION

▼ *Standard wall plate mounting*

This phone can be mounted on any standard wall plate.

1. Snap the desktop/wall mount adaptor into the bottom of the base as shown.
2. Plug the AC adaptor into the base.
3. Place the AC adaptor cord inside the molded wiring channel. Wrap the cord around the strain relief notch.
4. Plug the AC adaptor into a standard 240V AC wall outlet.
5. Plug one end of the short telephone cord (not supplied) into the **TEL LINE** jack on the back of the base. Plug the other end into a standard telephone jack.

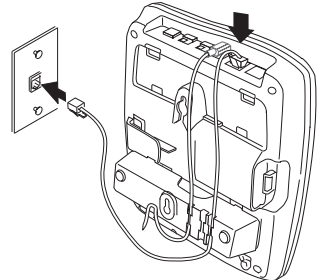
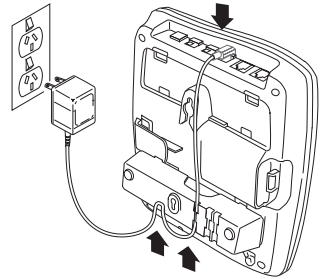
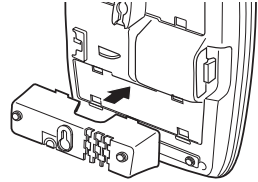

Place the power cord so that it does not create a trip hazard or where it could become chafed and create a fire or electrical hazard.



Use only the Uniden AC adaptor supplied with this phone plugged to uninterrupted power supply.



Before you plug the other end of the telephone cord into the modular jack on the wall, charge the battery (See CHARGING THE BATTERY PACK, page 15).

6. Align the mounting slots on the base with the mounting posts on the wall. Push in and down until the phone is firmly seated.

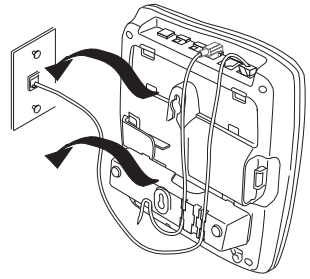

7. On the base, pull the handset retainer out of the slot. Rotate clockwise 180°.

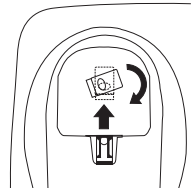

8. Flip the retainer from front to back. Slide it back into the slot so that the lip of the retainer is up and the oval is down. The retainer holds the handset in place.

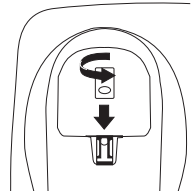

▼ *Direct wall mounting*

If you don't have a standard wall plate, you can mount your phone directly to the wall. Before doing this, consider the following:

- Select a location away from electrical cables, pipes, or other items behind the mounting location that could cause a hazard when inserting the screws into the wall.
- Mount your phone near a working phone jack to avoid excessive cord lengths
- Make sure the wall material is capable of supporting the weight of the base and the handset.



Be careful not to insert the mounting screws into possible electrical hazards such as cables, wiring, or pipes.

1. Insert two mounting screws (with their appropriate anchoring device) into the wall 100mm apart. Allow about 5mm between the wall and screw heads for mounting the phone.

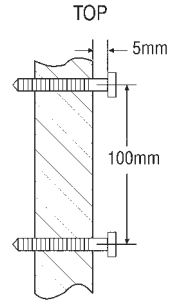

2. Snap the desktop/wall mount adaptor into the bottom of the base as shown.

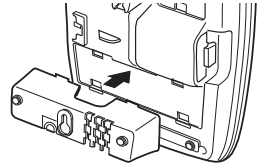

3. Plug the AC adaptor cord into the 10V DC input jack on the back of the base.
4. Put the AC adaptor cord inside the molded wiring channel. Wrap it around the strain relief notch. Plug the AC adaptor into a standard 240V AC wall outlet.
5. Plug one end of the telephone cord into the **TEL LINE** jack on the back of the base. Plug the other end into a telephone jack.

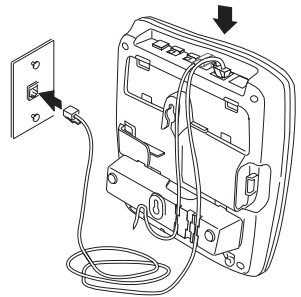
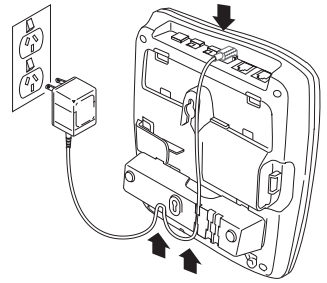

6. Align the mounting slots on the base with the mounting screws on the wall. Push in and down until the phone is firmly seated.

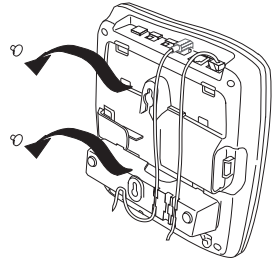

7. On the base, pull the handset retainer out of the slot. Rotate clockwise 180°.

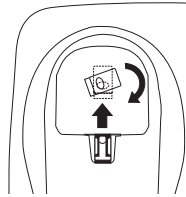

8. Flip the retainer from front to back. Slide it back into the slot so that the lip of the retainer is up and the oval is down. The retainer holds the handset in place.

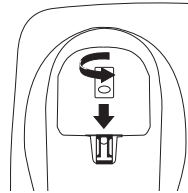

INSTALLING THE HANDSET BATTERY PACK



Use only Uniden Battery (model BT-900) supplied with your phone.

1. Press battery cover release.
Slide cover off.

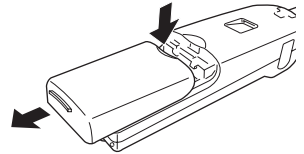

2. Install the nickel-cadmium battery with the label down.

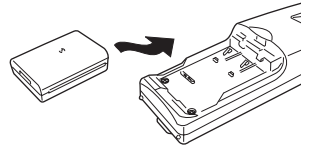

3. Slide the battery cover forward until it snaps into place

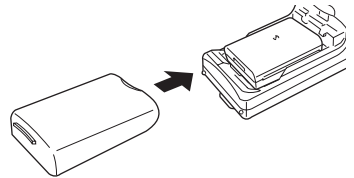

CHARGING THE BATTERY PACK

▼ Initial battery charging

Before connecting your the phone for the first time, fully charge the rechargeable battery pack for 15-20 hours without interruption.

1. Place the handset on the base.
2. Make sure that **status** LED lights. If the LED doesn't light, be sure the AC adaptor is plugged in and the handset makes good contact with the base charging contacts.

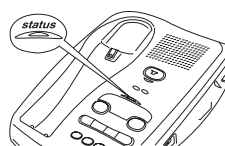

▼ Charging optional battery pack

The base of your phone is equipped with a compartment for charging an extra battery pack for use in your handset. **You can obtain an extra battery pack from your authorised Uniden dealer.**

1. Position the battery pack so the contacts are faced up.
2. Slide the battery pack into the charging compartment until it locks into place. The compartment has a latch that keeps the battery in place.
3. Fully charge the battery for 24 hours. When charging is complete, lift the latch to remove the battery pack. To install the charged battery into the handset, see INSTALLING THE HANDSET BATTERY PACK, page 14.

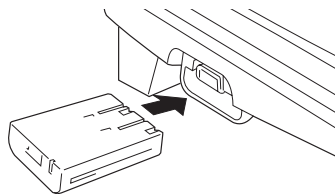

NOTE

Please visit your authorised Uniden dealer to obtain an extra battery pack.



In the event of a power failure, your spare battery pack temporarily provides power for the base so you can still use your phone.

▼ *Low battery indicator*

The low battery indicator shows when the battery pack is very low and needs to be charged. If the phone is not in use, the **talk/batt low** LED flashes every four seconds. If the phone is in use, the **talk/batt low** LED flashes every four seconds and the handset beeps. Complete your conversation as quickly as possible and return the handset to the base for charging.

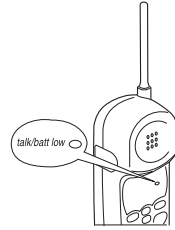

All rechargeable nickel-cadmium batteries develop a “memory effect”. The memory effect gradually reduces your talk and standby time.

▼ *To avoid Memory Effect*

On a monthly basis, use the phone until the **talk/batt low** LED indicator flashes on the handset. Then charge the battery for 15-20 hours. With normal usage, your battery should last about one year.

CLEANING THE BATTERY CONTACTS

To maintain a good charge, clean all charging contacts on the handset and base about once a month. Use a pencil eraser or other contact cleaner. DO NOT use liquids or solvents; you may damage your phone.

SETTING THE PULSE/TONE SWITCH

Be sure the **PULSE/TONE** switch is in the **TONE** position, unless your local phone system uses pulse dialing.

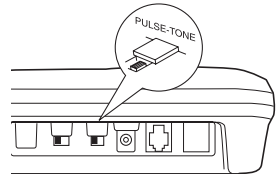

TIP

Most phone systems use tone dialing. Check with your local phone company if you're not sure whether your system is tone or pulse.

ADJUSTING THE VOLUME CONTROLS

▼ Handset ringer volume

Press the **vol ▲** or **▼** key on the handset to set the handset ringer volume. There are two ringer volume settings; high and low.

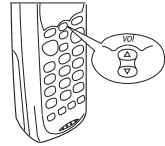

▼ Handset earpiece volume

There are four volume settings for the handset earpiece; max., high, low and min. **The handset earpiece volume can be adjusted only during a call.**

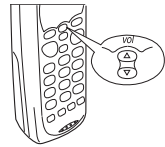

To lower the volume, press **vol ▼**. To raise the volume, press **vol ▲**.

The volume will remain on the same setting when you hang up.

▼ Base ringer volume

The ringer switch on your DGA940 allows you to turn the ringer **OFF** or **ON**.

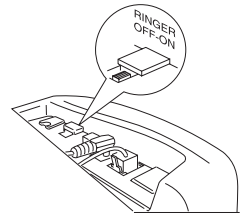

▼ Base speaker volume

To control the speaker volume of the base, press the **▲** or **▼** button.

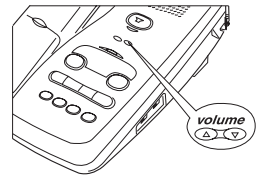

ADJUSTING RINGER TONE

1. Press **flash**. LED flashes.
2. Press **1, 2, 3** or **4** on the keypad to select ringer tone.

INSTALLING THE BELTCLIP

▼ *To attach the beltclip.*

1. Remove the slot cover.

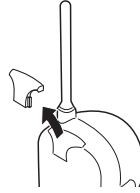

2. Insert the beltclip into the empty slot and press down until it clicks.

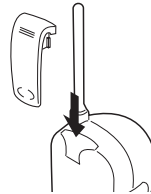

▼ *To remove the beltclip*

1. Pull back on the release tab and lift the beltclip up.

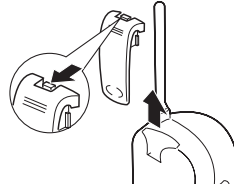

2. Replace the slot cover. You can store either the beltclip or slot cover on the bottom of the base.

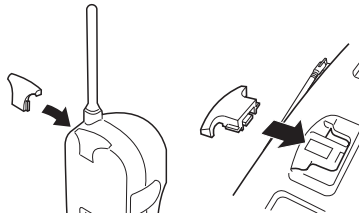

HEADSET INSTALLATION

Your phone may be used with an optional headset, the Uniden HS910 or Uniden CTA 630. To use this feature, simply plug the headset into the headset jack. Your phone is ready for hands-free conversations.

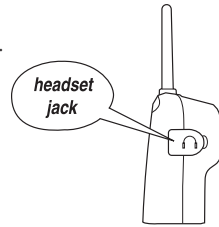

IMPORTANT

Use only the Uniden HS910 headset or Uniden CTA 630 headset.



If you are using an optional headset, you must still use the handset keypad for phone operations.

NOTE

Keep the headset wire away from handset and base antennas.

AUTOMATIC DIGITAL CODE SECURITY

To prevent other parties from making unauthorised calls on your phone line, a digital code was added to the DGA940. Your phone's handset and base share this code. This code is randomly set each time you place the handset in the base. If the phone experiences a power failure, you must reset the digital security code by placing the handset on the base.

▼ *To reset the digital security code*

1. Restore power to the base.
2. Place the handset on the base.
status LED must light up.
The digital security code is reset.

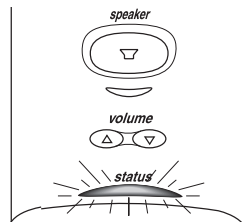

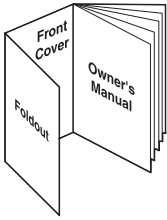



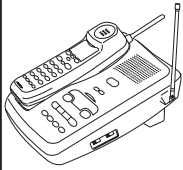

Fold out the front cover of this owner's manual to use the CONTROLS AND FUNCTIONS diagram for reference.

MAKING AND RECEIVING CALLS

▼ Basic phone operation

	Handset On Base	Handset Off Base	Base Only
			
To answer a call	Pick up handset.	Press talk .	Press speaker .
To make a call	<ol style="list-style-type: none"> 1. Pick up the handset. 2. Press talk. 3. Listen for the dial tone. 4. Dial the number. 	<ol style="list-style-type: none"> 1. Press talk. 2. Listen for the dial tone. 3. Dial the number. 	
To hang up	Press talk , or return the handset to the base (AutoStandby).		Press speaker .
To redial	<ol style="list-style-type: none"> 1. Pick up the handset. 2. Press talk. 3. Listen for the dial tone. 4. Press redial. <p>Note: If any key is pressed before redial, the last number dialed will not redial.</p>	<ol style="list-style-type: none"> 1. Press talk. 2. Listen for the dial tone. 3. Press redial. 	



When using the DGA940 on the base unit, an ACA approved headset is required.

NOTE

The tone feature applies only when the base is set to pulse.

NOTE

The **flash + 2** procedure toggles between the incoming and original call (vice versa). The **flash + 1** procedure will drop the current call and pick up the incoming call or call on hold.

TONE

If you are dialing in the pulse mode and need to enter tone digits, press ***** then enter the digits. Once the call has ended, tone mode is cancelled and pulse dialing resumes.

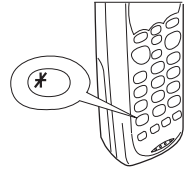

FLASH AND CALL WAITING

If you have Call Waiting service and a call waiting tone sounds, press **flash** then **2** to accept the call. After a short pause you will hear the new caller. To return to the original caller, press **flash** then **1**.

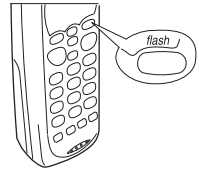

PAGE

To locate the handset when it is off the base, press **page** on the base. The handset beeps for about 15 seconds.

Press **talk** on the handset twice to stop the beeping.

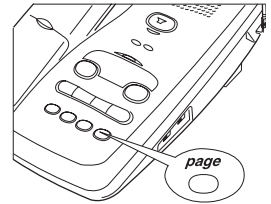

MUTE

To use the mute feature during a conversation, press **mute**. The other party will not be able to hear you although you can hear them. To disable the mute feature, press **mute** again.

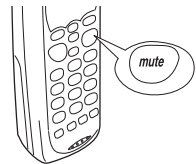

NOTE

The pause button count as one digit. Pressing **redial/p** more than once increases the length of pause between numbers.

STORING A PHONE NUMBER IN MEMORY

1. Remove the handset from the base.
2. Press **mem**. The **talk/batt low** LED blinks.
3. Enter the phone number, up to 16 digits.
If a pause is needed during dialing to access long distance service, press **redial/p** to insert a pause.
4. Press **mem** again.
5. Enter the memory location (01-20) on the keypad or press memory key **a, b, c, or d**. A tone indicates that the number is stored.

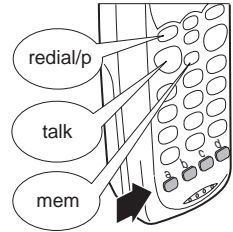

DIALING A NUMBER IN MEMORY

▼ Using the memory location features

1. Press **talk**.
2. Press **mem**.
3. Enter the memory location (01-20). The number automatically dials.

▼ One touch memory dialing

Press memory key **a, b, c, or d**. The number automatically dials.

NOTE

Accidentally pressing memory key **a, b, c, or d** after pressing **mem**, may result in unintentional dialing.

ERASING A STORED NUMBER FROM MEMORY

1. Remove the handset from the base unit.
2. Press **mem** button twice.
3. Press the memory location (01-20) or memory **a, b, c, or d** to be erased.
A tone indicates that the stored number is erased from memory.

CHAIN DIALING

On certain occasions after dialing a number, you may be requested to enter an access code, such as your account number. You can enter this number into a memory location for later use by doing the following.

1. Store the access code into one of the memory locations (01-20) or memory keys **a**, **b**, **c**, or **d** following steps 1-5 above.
2. Dial the party or service main number.
3. When you need to enter the special number, press **mem** followed by the memory location (01-20) or memory keys **a**, **b**, **c**, or **d**.

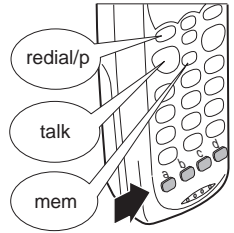

TRAVELLING OUT-OF-RANGE

As you begin to move too far from the base, you will first hear a clicking sound. As you travel further, the noise increases. If you travel out-of-range, your call terminates.

PABX CONNECTION

The DGA940 DGMax telephone may work with a 2-wire Analogue PABX network. However, with the DGA940 hook-flash timing fixed at 100msec, some PABX equipment that uses a different hook flash timing may have its special feature (i.e. placing a call on hold or transferring a call) inaccessible.

NOTE

Check with your PABX supplier if you are not sure whether your PABX network uses Analogue or Digital interface.

THE INTEGRATED ANSWERING DEVICE

The DGA940 has a built-in answering system to answer and record your incoming calls. You can use your answering system to leave a memo message for others who use the phone, or to answer the phone with your personalised message when you are away.

FEATURES

- Digital Tapeless Recording
- 15 minutes Recording Time
- Call Screening
- Selectable Outgoing Messages
- Time and Day Stamp
- Remote Access
- Toll Saver

Digital Tapeless Recording allows you to quickly review, save, or delete messages. You'll never worry about a tape wearing out, jamming, or resetting improperly. The Integrated Answering System is easy and convenient to use. However, ***please read all*** instructions carefully before using your answering system.

TURNING THE ANSWERING SYSTEM ON/OFF

1. To turn the answering system on, press ***answer***. A tone sounds. An outgoing message plays on the base speaker. A second tone sounds after the message plays. The message counter LED turns on to indicate the unit is ready to answer calls.
2. To turn the answering system off, press ***answer*** again. A tone sounds followed by the announcement "Answer off". The message counter LED turns off.

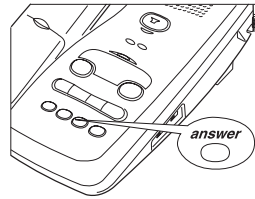







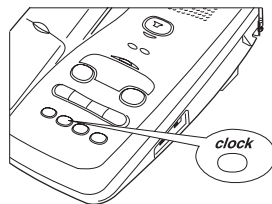

SETTING THE CLOCK

The clock on the DGA940 Answering System starts when power is applied to the base.

To set the correct time:

1. Press and hold **clock** until a tone sounds.



2. Press **skip**  or **repeat**  until the correct day is announced. Numbers **0** through **6** display as each day is announced.
3. Press **clock** again to select the day. The hour setting is announced.
4. Press **skip**  or **repeat**  until you hear the current hour setting. Numbers **1** through **12** display as each hour is announced.
5. Press **clock** again to select the correct hour.
6. Press **skip**  or **repeat**  until you hear the current minute setting. The numbers **0** through **59** display as each minute is announced.
7. Press **clock** again to select the correct minute. The AM/PM setting is announced.
8. The LED displays an **A** or **P**. Press **skip**  or **repeat**  until you hear the correct AM/PM setting.
9. Press **clock** again to complete your settings. The DGA940 Answering System announces the correct time.

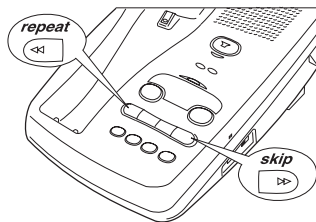

RECORDING YOUR OUTGOING MESSAGE

When you receive a call, the answering system automatically plays either a preset greeting, or your own personal greeting.

▼ *Preset message*

The following message is pre-recorded:

*“Hello, no one is available to take your call.
Please leave a message after the tone.”*

▼ *Recording your personal Outgoing Message (ogm)*

1. Press and hold **ogm** until you hear a long tone. After the message counter LED blinks, release **ogm**. Record your message by speaking within 30 cm of the base microphone.
2. When you finish recording your message, press **ogm** again. A tone sounds. Your message plays back for your review.

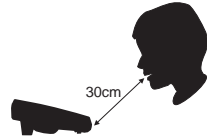
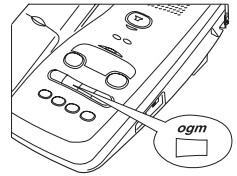

*To choose between the pre-recorded greeting and your personal greeting, press **ogm** during outgoing message playback.*

▼ *Announce Only feature*

The Announce Only feature repeats a pre-recorded ogm - “No one is available to take your call”, or your own personal ogm. **It will not allow the caller to leave a message.**

For Announce Only, move the **REC TIME** switch to the **ANN** position.

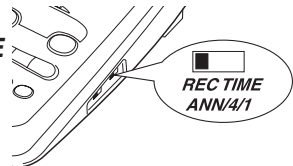

The message counter LED displays **A** when the system is on Standby

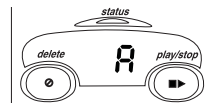

SELECTING THE MESSAGE TIME

You can set your answering system to record messages up to four minutes long.

To record up to one minute, move the **REC TIME** switch to **1**.

To record up to four minutes, move the **REC TIME** switch to **4**.

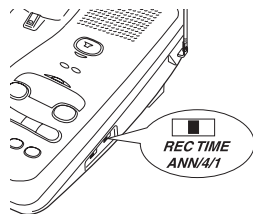

SETTING THE RING TIME

The ring time/toll saver switch sets your answering system to answer after two or four rings.

In the **TS** (Toll Saver) position, if you have new messages, the answering system answers after two rings. If there are no new messages, the system answers after four rings. This way, when you call long distance to check your messages, and have no messages, you can hang up after the second ring to save a charge.

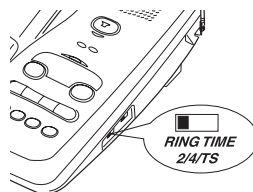



SELECTING A PIN CODE

To listen to your messages from a remote location, you will need to enter a two-digit Personal Identification Number (PIN) code (00-99).

To select a PIN:

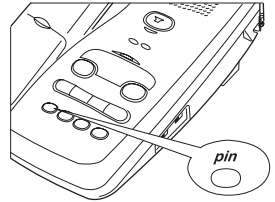
1. Press and hold the **pin** button. A tone sounds, and the LED displays **00**.



2. To set the first number, press **skip**  or **repeat**  to scroll from **0** to **9**. When the desired number appears in the display, press **pin** again. This selects the first number.

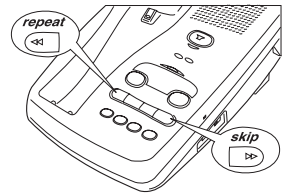

3. To set the second number, press **skip**  or **repeat**  to scroll from **0** to **9**. When the desired number appears in the display, press **pin**. This selects the second number. Your PIN is announced.

HINT

To stop playing your message at any time, press **play/stop** again.

NOTE

The system automatically returns to Standby when all messages have played.

USING THE INTEGRATED ANSWERING DEVICE

PLAYING YOUR MESSAGES

The base LED displays the total number of messages. If the display is blinking, you have new messages. When the message centre is full, the LED displays **FL**. The DGA940 plays your new messages first. After listening to your new messages, you may listen to your old messages.

1. Press **play/stop**.

The system announces the number of new and old messages. After each message is played, the time and day the message was received is announced. The message counter LED displays the number of current messages.

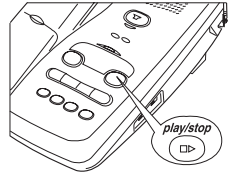

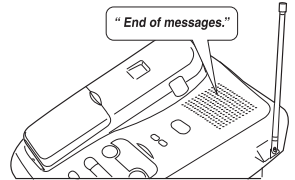

2. When all new messages have played, a long tone is heard. The message counter LED stops flashing to indicate all new messages have been reviewed.
3. After reviewing your new messages, you can review your old messages. Press



play/stop or  and follow the instructions above.

REPEATING A MESSAGE

1. Press **play/stop** or  to review your messages. The number of old messages is announced.
2. After a message plays for a few seconds, press  to replay the message.

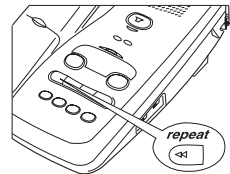
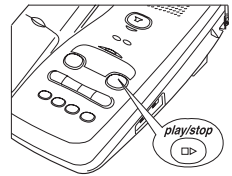

NOTE

Pressing **repeat** before 1-1/2 seconds of the message has played, causes the system to scan back one message. If you have several messages, press **repeat** until you return to the message you want replayed.

HINT



Each time **skip** is pressed, the system scans forward one message. If you have several messages, press **skip** to find the message you want to replay.

NOTE

When you press **delete**, you are permanently deleting the message. Once deleted, the message cannot be replayed.

3. You may press **play/stop**  at any time to stop reviewing and return to Standby. The message counter LED shows the total number of messages still on the system.



SKIPPING A MESSAGE

1. Press **play/stop**  to review your messages. The number of messages is announced.
2. Press  at anytime to skip to the next message.
3. Press **play/stop**  at any time to stop reviewing your messages and return to Standby.

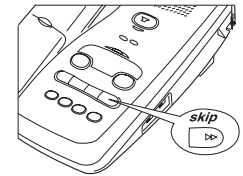
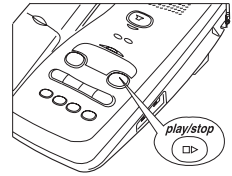
The message counter LED shows the total number of messages still on the system.



DELETING A MESSAGE

1. Press  to review your messages
2. If you decide to delete a message, press and release . The system beeps and goes to the next message.
3. After you have played all of your messages, a long tone sounds.

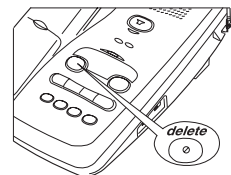
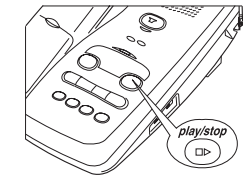

To delete all your messages, press and hold  after reviewing messages. When all messages are deleted, a tone sounds.

TIP

The Voice Memo function is completely independent of the outgoing message. It's handy for leaving other family members quick messages when you are unavailable.

NOTE

A Voice Memo is treated as an incoming recorded message. It will be added to your stored messages.

RECORDING A VOICE MEMO

The Voice Memo function allows the user to record a message on the base for others who use your phone.

1. Press and hold **memo**. A tone sounds and the message counter LED begins to blink.
2. Release **memo**. To record your message, speak within 30 cm of the base microphone.
3. When you have finished your message, press **memo** to stop recording. The system returns to Standby.

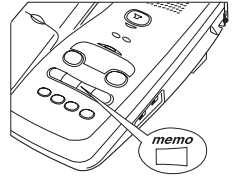

USING THE RESET BUTTON

The **RESET** button is used to initialise the base computer.

The reset button can be used if an AC power line disturbance causes the answering system to malfunction and become inoperative. Pressing **RESET** does not erase any data stored in your system memory.

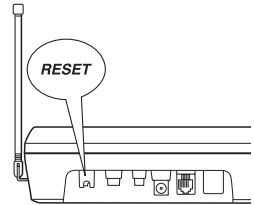

REMOTE ROOM MONITOR

You may call your answering system from any touch tone phone to monitor sounds in the room where the base is installed.

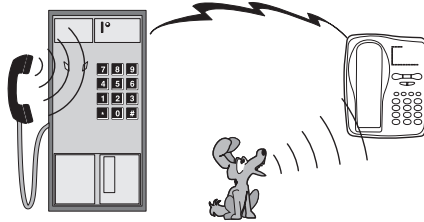

1. Call your telephone number.
2. During the outgoing message playback, press # followed by your PIN code. (See SELECTING A PIN CODE, page 28.)
3. Press # then * while the system announces the time and date.

You will hear sounds in the room where your base unit is installed. After 15 seconds, the answering system returns to the Command Waiting mode.

4. Press # then * to monitor the room for another 15 seconds. Or, select another remote function. Hang up to exit the system. The answering system automatically returns to Standby

REMOTE ACCESS AWAY FROM HOME

▼ Remote Switch On

In the event that you forgot to turn on your answering machine before you leave home, you can switch it on from a remote location using a touch-tone phone.

1. Call your telephone number.
2. Wait for 15 rings.
3. The answering system announces the ogm.
4. Hang up. Your answering machine is ready to receive messages.

NOTE

You must enter a command within 15 seconds of entering Command Waiting mode or the answering system automatically hangs up and returns to Standby.

NOTE

The system will only playback messages for four minutes and then it returns to Command Waiting mode. To continue playing your messages, press **#** then **2** again within 15 seconds.

▼ Other Functions

You can access other functions such as checking recorded messages, playing or deleting messages, etc. remotely using a touch-tone phone.

1. Call your telephone number.
2. While the outgoing message is playing, press **#** followed by your PIN code. (For instructions to set your PIN code see page 28).
3. The answering system announces the time and day followed by the number of messages in memory. Message playback automatically begins.
4. You may listen to your messages, or you may select a command from the following chart:

FUNCTION	PRESS
Repeat	# then 1
Play	# then 2
Skip	# then 3
Delete	# then 4
Stop	# then 5
Answer On	# then 6
Memo Record/Stop	# then 7
Ogm Record/Stop	# then 8
Answer Off	# then 9
Monitor	# then *

5. After all of your messages have played, intermittent beeps indicate that your system is in Command Waiting mode. At this time, you may enter another command from the chart above.
6. When you are finished, hang up to exit the system. The answering system automatically returns to Standby.

QUICK REFERENCE CHART

If your phone is not performing to your expectations, please try these simple steps first before calling Uniden customer service.

PROBLEM	SUGGESTION
The charge light won't come on when the handset is placed on the base.	<ul style="list-style-type: none"> • Make sure the AC adaptor is plugged into the base and wall outlet. • Make sure the handset is properly seated in base. • Make sure the charging contacts on the handset and base are clean.
The audio sounds weak and/or scratchy	<ul style="list-style-type: none"> • Make sure that the base antenna is in a vertical position. • Move the handset and/or base to a different location away from metal objects or appliances and try again.
Can't make or receive calls.	<ul style="list-style-type: none"> • Check both ends of the base telephone line cord. • Make sure the AC adaptor is plugged into the base and wall outlet. • Disconnect the AC adaptor for a few minutes, then reconnect it. • Place the handset back on the charging cradle for a few seconds. The status LED lights indicating that the phone has been reset.
The handset doesn't ring or receive a page.	<ul style="list-style-type: none"> • The Nickel-Cadmium battery pack may be weak. Charge the battery for 15-20 hours. • Be sure the antenna is in a vertical position. • The handset may be too far away from the base. Place the base away from appliances or metal objects. • Place the handset back on the charging cradle for a few seconds. The status LED lights indicating that the phone has been reset. • You may have exceeded the REN limit. See MORE THAN ONE PHONE on page 5.

PROBLEM	SUGGESTION
The answering system does not work.	<ul style="list-style-type: none"> • Make sure the base unit is plugged in. • Make sure the answering system is turned on. • Press RESET after an AC line spike.
The answering system does not answer calls.	<ul style="list-style-type: none"> • Set the REC TIME switch to either the one minute or four minute option. • The memory may be full. Delete some or all of the saved messages.
Messages are incomplete	<ul style="list-style-type: none"> • The incoming messages may be too long. Remind callers to leave a brief message. • The memory may be full. Delete some or all of the saved messages.
After a power failure, the outgoing message is deleted.	<ul style="list-style-type: none"> • Record your personal outgoing message again. The default message should remain.
No sound on the base unit speaker during call monitoring or message playback	<ul style="list-style-type: none"> • Adjust the speaker volume on the base unit.
Cannot access remote call-in features from another touch-tone phone.	<ul style="list-style-type: none"> • Make sure you're using the correct PIN. • Make sure that the touch-tone phone you're using can transmit the tone for at least two seconds. If it cannot, you may have to use another phone to access your messages.

GENERAL

The DGA940 complies with TS001, TS002, TS004, AS/NNZS3260 and FCC Part 15 (as per ACA Radio Communications Class Licensing Requirements).

Frequency control: PLL

Modulation: Direct Sequence Spread Spectrum; DBPSK

Operating temperature: 0° to +50° C

BASE UNIT

Frequency: 917.4 to 925.8 MHz (15 channels)

Power requirements: 10V 500mA (from AC adaptor)

Size: 187mm (W) x 89mm (D) x 222mm (H)

Weight: Approx. 3.2kg (including optional battery)

Battery: BT-900 (as a back-up)

Capacity 600mAH, 3.6V

Talk mode 2 hours

Standby mode 4 hours

HANDSET

Frequency: 917.4 to 925.8 MHz (15 channels)

Power requirements: Rechargeable Nickel-Cadmium battery pack

Size (without antenna): 57mm (W) x 44.5mm (D) x 184mm (H)

Weight: Approx. 264g (including battery)

Battery: BT-900

Capacity 600 mAH, 3.6V

Talk mode 4 hours

Standby mode 7 days

Specifications, features, and availability of optional accessories are all subject to change without prior notice.

WARRANTY

One-Year Limited Warranty

Important: Evidence of original purchase is required for warranty service.

WARRANTOR: Uniden Australia Pty Limited ACN 001 865 498

ELEMENTS OF WARRANTY: Uniden warrants to the original retail owner for the duration of this warranty its DGA940 DGMax (here in after referred to as the Product), to be free from defects in materials and craftsmanship with only the limitations or exclusions set out below.

WARRANTY DURATION: This warranty to the original retail owner only, shall terminate and be of no further effect 12 months after the date of the original retail sale. This warranty will be deemed invalid if the product is: (A) Damaged or not maintained as reasonable or necessary, (B) Modified, altered or used as part of any conversion kits, subassemblies, or any configurations not sold by Uniden, (C) Improperly installed, (D) Repaired by someone other than an authorised Uniden Repair Agent for a defect or malfunction covered by this warranty, (E) Used in conjunction with any equipment or parts or as a part of a system not manufactured by Uniden.

PARTS COVERED: This warranty covers for one (1) year, the Base Unit and Handset only. All accessories (AC Adaptor, Battery, Mount Adaptor, Belt Clip, etc.) are covered for 90 days only.

STATEMENT OF REMEDY: In the event that the product does not conform to this warranty at any time while this warranty is in effect, the warrantor, at its discretion, will repair the defect or replace the product and return it to you without charge for parts and service. THIS WARRANTY DOES NOT COVER OR PROVIDE FOR THE REIMBURSEMENT OR PAYMENT OF INCIDENTAL OR CONSEQUENTIAL DAMAGES. THIS GUARANTEE IS IN ADDITION TO AND DOES NOT IN ANY WAY AFFECT YOUR RIGHTS UNDER THE CONSUMER GUARANTEE ACT.

WARRANTY CARD: If a Warranty Card has been included with this Product, please complete and return to us within 14 days of purchase. Your name and the serial number of the Product will then be registered in our database and this will help us process your claim with greater speed and efficiency should you require warranty service.

PROCEDURE FOR OBTAINING PERFORMANCE OF WARRANTY: In the event that the Product does not conform to this warranty, the Product should be shipped or delivered, freight pre-paid, with evidence of original purchase (e.g. a copy of sales docket) to the warrantor at:

UNIDEN AUSTRALIA PTY LIMITED

SERVICE DIVISION

345 Princes Highway, Rockdale, NSW 2216

Ph: (02) 9599 3577 Fax: (02) 9599 3278

FREE CALL 1800 632 789

Customers in other States should ship or deliver the Product freight pre-paid to their nearest Uniden Authorised Repair Centre, (Contact Uniden for the nearest Warranty Agent to you).

At Uniden, we'll take care of you!

If you need any assistance with this product, please call our Customer Hotline at

1800 632 789

THANK YOU

FOR PURCHASING A UNIDEN PHONE!

Uniden

Uniden Australia Pty Limited
© 1999 Uniden Australia Pty Limited
Part Code UCZZ01655BZ

Free Manuals Download Website

<http://myh66.com>

<http://usermanuals.us>

<http://www.somanuals.com>

<http://www.4manuals.cc>

<http://www.manual-lib.com>

<http://www.404manual.com>

<http://www.luxmanual.com>

<http://aubethermostatmanual.com>

Golf course search by state

<http://golfingnear.com>

Email search by domain

<http://emailbydomain.com>

Auto manuals search

<http://auto.somanuals.com>

TV manuals search

<http://tv.somanuals.com>