

**Uniden®**

**DSS7915**  
**DSS7915+1**  
Series Owner's Manual

**OWNER'S MANUAL**

# Contents

<b>Welcome</b> .....	<b>4</b>
<b>Product Overview</b> .....	<b>6</b>
Features:.....	6
Parts of the Phone.....	7
<b>Using the Interface</b> .....	<b>9</b>
Reading the Handset Display.....	9
Using the Four-way Function Key.....	10
Using the Handset Menus.....	10
Entering Text from your Phone.....	11
<b>Installing the Phone</b> .....	<b>12</b>
Choosing the Best Location.....	12
Installing the Rechargeable Battery.....	13
Connecting the Base and Charging the Handset.....	14
Installing the Belt Clip.....	15
Connecting to the Phone Line.....	15
Testing the connection.....	15
Changing the Dial Mode.....	16
<b>Basic Setup</b> .....	<b>17</b>
Setting the Day & Time.....	17
Activating Caller ID on Call Waiting.....	17
Activating Distinctive Ring.....	18
Name Tag.....	18

Insert 0.....	18
Activating the Key Touch Tone.....	19
Adjusting the LCD Contrast.....	19
Setting the Animation Screen.....	19
<b>Setting up Voice Mail</b> .....	<b>20</b>
Programming One-Touch Voice Mail Access.....	21
Resetting the Voice Message Waiting Indicator.....	21
<b>Adding Accessory Handsets</b> .....	<b>22</b>
Compatible Handsets.....	22
Charge the Accessory Handset.....	22
Registering DSS7905 Accessory Handsets.....	23
Registering the DSS7805WP Compatible Handsets.....	24
<b>Resetting the Handsets</b> .....	<b>24</b>
<b>Setting up the Phonebook</b> .....	<b>25</b>
Creating Phonebook Entries.....	25
Chain Dialing.....	26
Finding a Phonebook Entry.....	27
Editing Phonebook Entries.....	27
Storing Caller ID or Redial Numbers in the Phonebook.....	28
Erasing Phonebook Entries.....	28
Copying Phonebook Entries to another Station.....	29
<b>Customizing Your Phone</b> .....	<b>30</b>
Changing the Handset Banner.....	30

Selecting a Ring Tone .....	31	Transferring a Call .....	41
Activating AutoTalk.....	32	Answering a Transferred Call .....	41
Activating Any Key Answer .....	32	<b>Using Special Features .....</b>	<b>42</b>
<b>Using your Phone.....</b>	<b>33</b>	Muting the Ringer (One Call Only).....	42
Making a call from the Phonebook .....	34	Muting the Microphone .....	42
Making a call with Speed Dial.....	34	Privacy Mode .....	42
Switching to the Handset Speakerphone during a Call.....	34	Using the DirectLink Feature .....	43
<b>Using Caller ID, Call Waiting and Redial Lists .....</b>	<b>35</b>	Intercom .....	44
Using the Caller ID List .....	35	Room Monitor .....	45
Making a call from a Caller ID Record .....	36	Tone Dialing Switch Over.....	46
Deleting Caller ID Numbers .....	36	Installing the Optional Headset.....	46
Using Call Waiting .....	37	<b>Maintenance.....</b>	<b>47</b>
Redialing a Number .....	38	Specifications.....	47
Deleting a Redial Record.....	38	Battery Replacement and Handling .....	48
<b>Adjusting the Ringer, Earpiece and Speaker Volume.....</b>	<b>39</b>	Cleaning the Battery Contacts .....	48
Adjusting the Ringer Volume .....	39	Low Battery Alert .....	49
Adjusting the Speaker Volume .....	39	Talk and Standby Times.....	49
T-coil (Handset only) .....	39	<b>Troubleshooting .....</b>	<b>50</b>
<b>Finding a Lost Handset.....</b>	<b>40</b>	Resetting the Handset .....	50
<b>Using Hold, Conference and Transfer .....</b>	<b>40</b>	Changing the Digital Security Code.....	51
Placing a Call on Hold .....	40	Traveling Out of Range.....	51
Conferencing .....	41	Common Issues.....	52
		<b>Liquid Damage .....</b>	<b>54</b>



**Precautions! ..... 55**  
    Rechargeable Nickel-Metal-Hydride Battery  
    Warning ..... 55

**Index ..... 57**

**One Year Limited Warranty ..... 62**





# Welcome

Thank you for purchasing a Uniden Multi-Handset phone.

**Note:** Illustrations in this manual are used for explanation purposes. Some illustrations in this manual may differ from the actual unit.

## Terminology used in this Manual

<b>Standby</b>	The handset is not in use. If the handset is on the cradle or <b>[[/flash]</b> or <b>[*]]</b> is not pressed, no line has been activated. No dial tone is present.
<b>CID</b>	Caller ID is available from your Telephone provider and is offered to users on a subscription basis. With this service and a display on your cordless phone, you will be able to see the incoming caller information such as name and phone number.
<b>CID/CW or CIDCW</b>	Caller ID with Call Waiting is available by subscription from your Telephone provider. With this service, you will be able to view incoming caller information while on a call with another user. This will allow you the ability to select to talk to this user and put your existing party on hold or make the decision to ring them back.
<b>DirectLink</b>	If you have accessory handsets on your system, you can use two handsets as 2-way radios.
<b>Accessory Handsets</b>	This phone system is expandable and will support a total of ten (10) handsets to one base. The DSS7905 accessory handset is compatible with this model.
<b>Global settings</b>	Global Settings apply to all registered handsets. If you change something under the global menu, you change it for all handsets. Only one handset can change global settings at a time, and you have to make sure the phone is not currently being used.
<b>Station</b>	Any handset or the base.
<b>Talk</b>	A telephone line has been activated on the handset or base, enabling a dial tone.

# Product Overview

## Features:

- 5.8GHz DSS Expandable System
- Expands up to 10 Handsets
- Caller ID\*
  - Caller ID on Call Waiting
  - Name Tag (POP ID)
  - Distinctive Ring
- Advanced Phonebook Features:
  - Store Up to 100 Names for each station
  - Alphabetical Search
  - Distinctive Ring by Party
  - Transfer Single Listing or Entire Phonebook
- DirectLink™
- Room Monitoring
- Speakerphone on Handset
- 20 Ringer Options on Handset (10 Tones/10 Melodies)
- 10 Speed Dial Numbers
- Last 3 Number Redial
- Call Transfer
- Conferencing
- Intercom
- T-coil
- Handset Keypad Lock

\* Caller ID, Name Tag, Distinctive Ring features require subscription to the Caller Display service from your network supplier. A fee normally applies for this. The Caller ID on Call Waiting service is currently unavailable in New Zealand.

## Parts of the Phone

The following illustrations show you all of the different parts of your phone.

### Handset

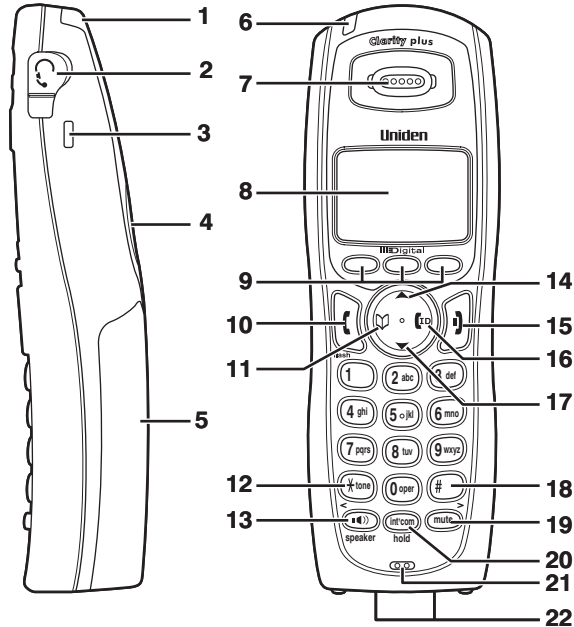

1. Handset Antenna
2. Headset Jack Cover
3. Beltclip Hole
4. Speakerphone Speaker and Ringer
5. Handset Battery Compartment
6. New Message LED
7. Handset Earpiece
8. LCD Display
9. Soft keys
10. [flash] (talk/flash) key
11. [phonebook] key
12. [\*tone/<] key
13. [speaker] key
14. [up] key
15. [end call] key
16. [caller ID] key
17. [down] key
18. [#/>] key
19. [mute] key
20. [int'com/hold] key
21. Handset Microphone
22. Handset Charging Contacts



## Base

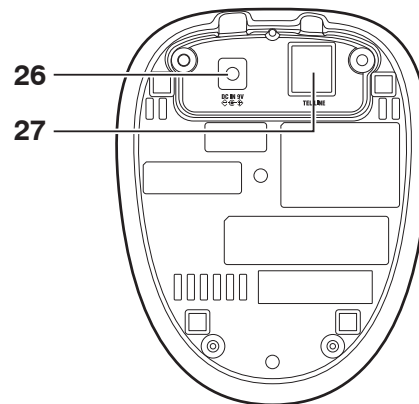
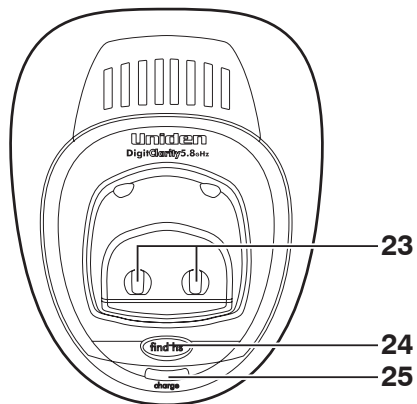







- 23. Base Charging Contacts
- 24. **[find hs]** (find handset) key
- 25. Charge LED
- 26. DC IN 9V Jack
- 27. TEL LINE Jack

# Using the Interface

## Reading the Handset Display

The handset display uses icons to tell you the status of your phone. The table below lists the icons and what they mean.

Icon	Status	Description
	Talk	The privacy icon appears when Privacy mode is turned on.
	Talk	The mute icon appears when you mute the handset.
	Talk	The speaker icon appears when the handset speakerphone is in use.
	Talk	This icon appears when T-coil mode is turned on.
	Standby	The ringer off icon indicates that the ringer is turned off.
	Standby/Talk	The battery icon indicates the handset battery status: empty, low, medium, and full.

## The Standby Screen

When the phone is in standby, the handset display shows the following items:

- Handset

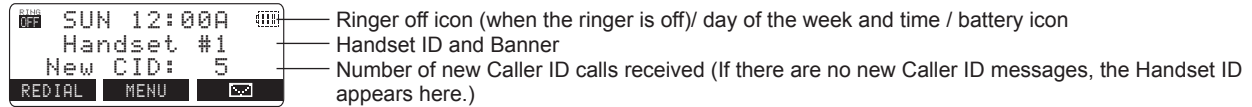

## Using the Four-way Function Key

Your handset has a four-way function key that allows you to move the cursor (or highlighted area) on the display and access the most commonly used features at the touch of a button. By moving this key to the left, you open the Phonebook. Move the key to the right to access Caller ID information. To use this four-way key, place your thumb over the key on the station and move to the four positions to get the feel of how it moves and operates.

## Using the Handset Menus

To open the menu, press the **MENU** soft key. Highlight the option you want by pressing the four-way function key. This will move the cursor; the option currently highlighted appears in reversed out text. Select the highlighted option by pressing the **OK** soft key. To exit the menu and return to standby, press **[\*]**.

If you do not press a key within 30 seconds, the phone will time out and exit the menu. When setting Date and Time, the time-out period is extended to two minutes.

Note: For GLOBAL SETUP and DEREGISTER HS menu options, make sure the line is not in use and the handsets are within range of the base.

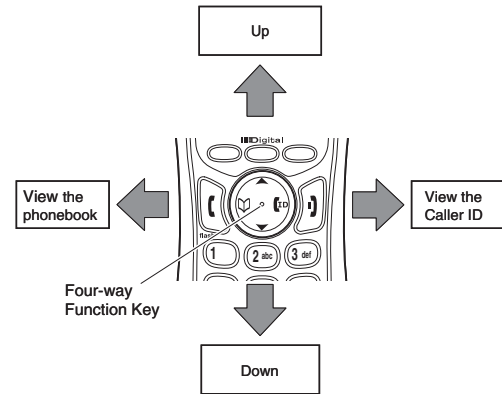

## Entering Text from your Phone

You can use the number keypad on your handset to enter text by referring to the letters printed on each number key. When you press the number key in a text entry field, the phone displays the first letter printed on the number key. Press the number key twice to display the second letter and three times to display the third. Capital letters are displayed first, then lower case letters, then the number on the key.

If two letters in a row use the same number key, enter the first letter, then use **[#/>]** or **[\*tone/<]** to move the cursor to the next position to enter the second letter. For example, to enter Movies:

- 1) Press 6 once to enter M.
- 2) Use **[#/>]** to move the cursor to the right.
- 3) Press 6 six times to enter o.
- 4) Press 8 six times to enter v.
- 5) Press 4 six times to enter i.
- 6) Press 3 five times to enter e.
- 7) Press 7 eight times to enter s.
- 8) Press the **OK** soft key to end your text entry.

If you make a mistake while entering a name, use **[#/>]** or **[\*tone/<]** to move the cursor to the incorrect character. Press the **DELETE** soft key to erase the wrong character, and then enter the correct character. To delete all characters, press and hold the **DELETE** soft key.

	Number of times key is pressed								
keys	1	2	3	4	5	6	7	8	9
1	1								
2 abc	A	B	C	a	b	c	2		
3 def	D	E	F	d	e	f	3		
4 ghi	G	H	I	g	h	i	4		
5 jkl	J	K	L	j	k	l	5		
6 mno	M	N	O	m	n	o	6		
7 pqrs	P	Q	R	S	p	q	r	s	7
8 tuv	T	U	V	t	u	v	8		
9 wxyz	W	X	Y	Z	w	x	y	z	9
0 oper	&	<	>	<	>	/	(blank)	-	-
	.	,	:	?	!	@	'	"	*
	#	0							

# Installing the Phone

## Choosing the Best Location

When choosing a location for your new phone, here are some important guidelines you should consider:

- The location should be close to both a phone jack and a continuous power outlet (one which is not connected to a switch).
- The base and handset should be kept away from sources of electrical noise such as motors, microwave ovens, and fluorescent lighting.
- For better reception, place the base as high as possible.
- The base should be placed in an open area for optimum range and reception.
- If your home has wired alarm equipment connected to a phone line, be sure that installing the system does not disable your alarm equipment. If you have questions about what will disable alarm equipment, contact your telephone company or a qualified installer.

Note: For maximum range:

- Keep the antenna free of obstruction.
- When the handset is not in use, place the handset in an upright position.
- Do not hold the handset where you would block the signal.
- Metal and reinforced concrete may affect cordless telephone performance.

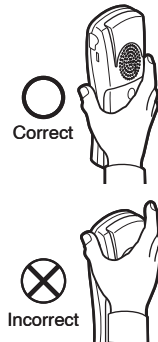

## Installing the Rechargeable Battery

Use only the Uniden BT-446 or BT-750 rechargeable battery pack supplied with your cordless telephone.

Follow the steps below to install a battery:

- 1) Press in on the handset battery case cover (use the finger indentation for a better grip) and slide the cover downward to remove.
- 2) Plug the battery cable into the battery jack. Be sure to match the red and black wires to the label near the jack. The cable should snap into place. Gently pull on the battery cable. If the battery connector comes loose, try connecting again until the battery snaps into place.
- 3) Place the battery case cover back on the handset and slide it upwards until it clicks into place.

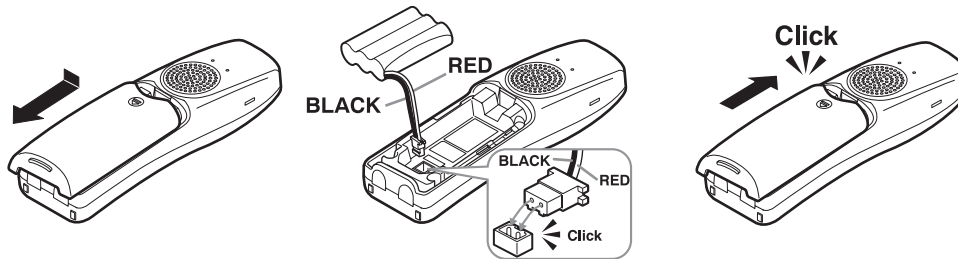

## Connecting the Base and Charging the Handset

- 1) Connect the AC adaptor to the DC IN 9V jack.
- 2) Connect the AC adaptor to a continuous power supply (i.e., an outlet that is not controlled by a switch).
- 3) Place the handset in the base with the LCD screen facing forward.
- 4) Make sure that the charge LED illuminates. If the LED does not illuminate, check to see that the AC adaptor is plugged in and the handset makes good contact with the base charging contacts.
- 5) Charge your handset at least 15-20 hours before plugging into the phone line.

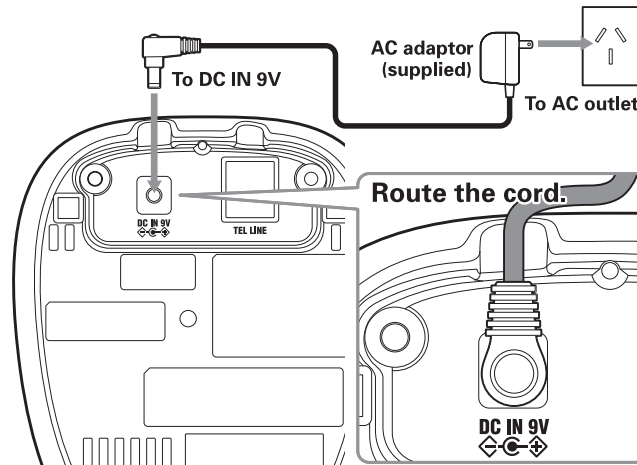

## Installing the Belt Clip

- 1) Line up the holes on each side of the handset. To attach the belt clip, insert into the holes on each side of the handset. Press down until it clicks.
- 2) To remove the belt clip, pull either side of the belt clip to release the tabs from the holes.

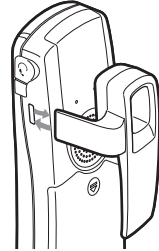

## Connecting to the Phone Line

Once the handset battery pack is fully charged, connect the telephone line cord to the TEL LINE jack and to a telephone outlet.

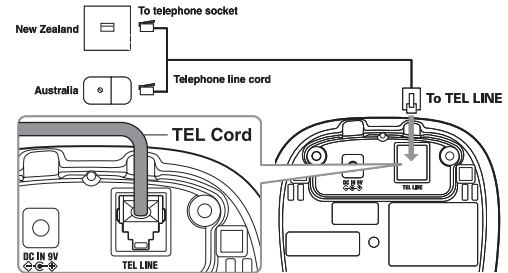

## Testing the connection

To test your connection, try making a call. If your call connects, the settings are fine. If your call does not connect, check the following:

- 1) Check the AC adaptor cord. Make sure it is securely connected to the DC IN connector and to a standard AC power outlet.
- 2) Check to make sure the battery is fully charged. (If you don't see the "battery full" icon, check to make sure the battery is properly connected.)
- 3) Change dial mode (instructions on page 16).



## Changing the Dial Mode (Australian Model Only)

Your phone can communicate with the telephone network in two different ways: tone dialing or pulse dialing. These days, most phone networks use a method called tone dialing, so your phone comes programmed for tone dialing. If your phone company uses pulse dialing, you will need to change your phone's dial mode. If you cannot connect to the telephone network, please follow the steps below to modify your phone's settings:

- 1) Press the **MENU** soft key. Select the GLOBAL SETUP menu, and then the DIAL MODE submenu.
- 2) Press [**▼**] on the four-way function key to select PULSE. (The initial setting is Tone).
- 3) Press the **OK** soft key. You will hear a confirmation tone.

If you ever need to change the dial mode back to Tone, follow the same procedure, but select **TONE** in step 2.



## Setting the Day & Time

To change the day and time shown in the display, follow the steps listed below.

Note: If you don't press any keys for two minutes when setting the date and time, the phone will exit the menu.

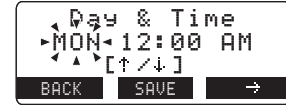

- 1) Press the **MENU** soft key. Select the GLOBAL SETUP menu, and then the DAY & TIME submenu.
- 2) Press [▲] or [▼] to select the day of the week, and then the → soft key.
- 3) Press [▲] or [▼] to select hour, and then the → soft key.
- 4) Press [▲] or [▼] to select minute, and then the → soft key.
- 5) Press [▲] or [▼] to select AM or PM, then press the **SAVE** soft key. You will hear a confirmation tone.

## Activating Caller ID on Call Waiting

Your phone supports Caller ID on Call Waiting (CIDCW), so you can see the name and number of someone who calls when you're already on the line. You'll need to subscribe to these features with your phone company before you can use them. To let your phone support these features, follow the steps below:



- 1) Press the **MENU** soft key. Select the GLOBAL SETUP menu, and then the CIDCW submenu.
- 2) Move the cursor to select ON or OFF.
- 3) Press the **OK** soft key. You will hear a confirmation tone.

## Activating Distinctive Ring

You can assign special ring tones to anyone in your phonebook. When your phone gets a call, it looks up the Caller ID information in your phonebook. If you've assigned a Distinctive ring to that number, the phone uses it so you know who is calling. To turn on Distinctive ring, follow these steps:

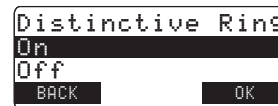

- 1) Press the **MENU** soft key. Select the HANDSET SETUP menu, and then the DISTINCTIVE RING submenu.
- 2) Move the cursor to select ON or OFF.
- 3) Press the **OK** soft key. You will hear a confirmation tone.

## Name Tag

Name Tagging works with the caller display number from Caller ID. You will need to subscribe to the Caller ID feature with your phone company for Name Tagging to work.

When the phone rings, the received caller display number is compared to numbers stored in the phonebook. If there is a match then any name stored with the phonebook number will be displayed. To change the Name Tagging setting, follow the steps listed below.

- 1) Press the MENU soft key. Select the GLOBAL SETUP menu, and then the NAME TAG submenu.
- 2) Move the cursor to select ON or OFF.
- 3) Press the OK soft key. You will hear a confirmation tone.

## Insert 0

This feature adds "0" or "00" at the beginning of the number received from Caller ID. The default setting for New Zealand is ON. The default setting for Australia is OFF. To change the Name Tagging setting, follow the steps listed below.

- 1) Press the MENU soft key. Select the GLOBAL SETUP menu, and then the INSERT 0 submenu.
- 2) Move the cursor to select ON or OFF.
- 3) Press the OK soft key. You will hear a confirmation tone.

## Activating the Key Touch Tone

Key Touch Tone is the tone your keypad makes when keys are pressed. You can turn this tone on or off.

- 1) Press the **MENU** soft key. Select the HANDSET SETUP menu, and then the KEY TOUCH TONE submenu.
- 2) Move the cursor to select ON or OFF.
- 3) Press the **OK** soft key. You will hear a confirmation tone.



## Adjusting the LCD Contrast

Contrast adjusts the handset LCD brightness. Choose one from the 10 levels for optimum viewing.

- 1) Press the **MENU** soft key. Select the HANDSET SETUP menu, and then the CONTRAST submenu.
- 2) Press [**▲**] or [**▼**] on the four-way function key to adjust the contrast of the LCD.
- 3) Press the **OK** soft key. You will hear a confirmation tone.



## Setting the Animation Screen

The Animation screen displays animation on the handset LCD. The animations will be displayed on the LCD screen during a call, ringer volume setting, when you hang up, and so on.

- 1) Press the **MENU** soft key. Select the HANDSET SETUP menu and then the ANIMATION SCREEN submenu.
- 2) Press [**▲**] or [**▼**] to select ON or OFF.
- 3) Press the **OK** soft key. You will hear a confirmation tone.



## Setting up Voice Mail

If you subscribe to a voice mail service, you can use your phone to access your voice mailbox. The new message LED flashes whenever you have messages waiting in your voice mailbox. If you have programmed your access number into your phone, you can simply press the [vz] soft key to access your voice mail. When you subscribe to the service, your voice mail provider provides you with the access number and the required voice mail signaling tone.

## Programming One-Touch Voice Mail Access

You can program your voice mail access number to the [☒] soft key on a station so you can get your messages at the touch of a button. Your voice mail service provider will supply you with the access number. This number may be simply a phone number.

To edit the voice mail number, follow the steps below:

- 1) Press the **MENU** soft key. Select HANDSET SETUP menu, then EDIT VOICE MAIL submenu.
- 2) Enter your personal access number (up to 20 digits).
- 3) If you need to have the phone wait before sending the next digits, press the **PAUSE** soft key to insert a two-second pause in the dialing sequence. For a longer pause, press the key multiple times. A P appears in the display each time you press the key and each pause counts as one digit.
- 4) Press the **OK** soft key when you are finished.



## Resetting the Voice Message Waiting Indicator

When you receive a new voice mail message, the LED on the top of the handset flashes. In the event your message alert tone gets out of sync with your phone company's voice messaging system, you can reset back to its original "no messages waiting" state. To reset, with the phone in standby mode, press and hold [**find hs**] on the base until the paging sound stops (about 5 seconds).

## Adding Accessory Handsets

Your phone supports up to a total of ten (10) cordless handsets. (Model DSS7905 accessory handset sold separately.) Accessory handsets do not need to be connected to a phone jack. You can now place a fully-featured cordless handset anywhere AC power is available to connect the handset charger.

## Compatible Handsets

Your phone is compatible with the DSS7905 and DSS7805WP. If you purchase an accessory handset, you must register the handset to the original or main base before use. Accessory handsets will not operate until they are registered.

## Charge the Accessory Handset

The handset is powered by a rechargeable battery pack. The battery recharges automatically when the handset is placed in the charger.

- 1) Connect the AC adaptor to the **DC IN 9V** jack and to a standard 240V AC wall outlet.
- 2) Set the charger on a desk or tabletop, and place the handset in the charger with the keypad facing forward.
- 3) Make sure that the **charge** LED illuminates. If the LED does not illuminate, check to see that the AC adapter is plugged in and the handset makes good contact with the charger charging contacts.
- 4) Charge the handset battery pack for at least 15-20 hours before using your new cordless telephone for the first time.

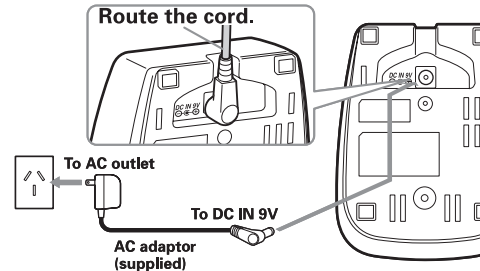

## Registering DSS7905 Accessory Handsets

Your phone supports a total of ten (10) cordless handsets. Handset(s) supplied in the box with the phone base are pre-registered at the factory. If you purchase an accessory handset, you need to register the handset before use. Only one handset can be registered at a time. When charged, pre-registered handsets display a handset ID number. Handsets that have not been registered display.

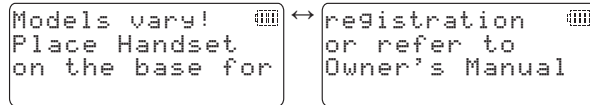

- 1) Before registering the **DSS7905** accessory handset, the battery pack **MUST** be charged for 15-20 hours.
- 2) To register the DSS7905 handset:
  - Place the handset in the telephone base charging cradle to begin registration.
- 3) During the registration process, **HANDSET REGISTERING** will appear in the LCD. When **REGISTRATION COMPLETE.** is displayed; the handset has been registered to the base. If **REGISTRATION FAILED.** appears, please try these steps again. When you register an accessory handset to the base, the handset ID will be assigned.

### Note:

- If an accessory handset has ever been registered to a base, you must reset the handset before you can register it to a new base. See **Resetting the Handsets** on page 24.



## Registering DSS7805WP Compatible Handsets

- 1) Disconnect the base AC adapter.
- 2) While holding the [find hs], reconnect the AC adapter until the charge LED starts blinking.
- 3) On the handset, press and hold [#] until you hear a beep.
- 4) While the handset is registering, HANDSET REGISTERING will appear in the LCD. When REGISTRATION COMPLETE is displayed; the handset has been registered to the base. If REGISTRATION FAILED appears, please try these steps again.

## Resetting the Handsets

If you want to register a handset to a different base or replace a handset with another one, you must first clear the existing registration data. To clear, please follow these steps:

- 1) Press the **MENU** soft key. Select the DEREGISTER HS submenu.
- 2) DEREGISTER HS? appears. Move the cursor to select YES. Press the **OK** soft key.



Or

- 1) From the handset, press and hold [h] and [#>] for more than 5 seconds. You will hear a confirmation tone, and DEREGISTRATION COMPLETE appears.

After resetting the handset, place the handset to the base to register. You must re-register the handset before you can use it. (See Registering DSS7905 Accessory Handset section on page 23 for registration instructions.)

## Setting up the Phonebook

Your phone allows you to store up to 100 names in your handset phonebook. Your phone shares memory between your phonebook and CID with a total of 100 entries. Once you store 100 phonebook entries, CID information will not be stored and will only display at time of new incoming calls. When Phonebook entries are full, you will hear a beep and MEMORY FULL appears. You cannot store additional names and numbers unless you delete some of the existing ones.

You can also use the Phonebook or speed dial locations to store a group of numbers (up to 20 digits) that you may need to enter once your call connects. This is referred to as Chain Dialing.

## Creating Phonebook Entries

To store names and numbers in your Phonebook, please follow these steps:

- 1) When the phone is in standby mode, press **[M]** (on the left side of the four-way key).
- 2) To create a new phonebook entry, press the **STORE** soft key. STORE/EDIT NAME appears.



- 3) **Enter the name for this entry (Edit Name).**

Use the keypad to enter a name for this entry; the name can contain up to 16 characters. (See page 11 for instructions on entering text.) If you do not want to enter a name for this entry, your phone will store this entry as No Name. Press the **OK** soft key when you are finished.



- 4) **Enter the number for this entry.**

Once you have stored a name, STORE/EDIT NO. appears next. Use the number keypad, **[#/>]**, **[\*tone/<]**, or the **DELETE** soft key to enter the phone number, the phone number can contain up to 20 digits. If you need the phone to pause between digits when it's dialing (for example, to enter an extension or an access code), press the **PAUSE** soft key to insert a two-second pause. You will see a P in the display. You can also use more than one pause together if two seconds is not long enough. Each pause counts as one digit. Press the **OK** soft key when you are finished.



5) **Assign a distinctive ring tone for this entry (Distinctive Ring).**

You can attach a personalized ring tone to each phonebook entry; the phone will use this ring tone when this person calls. Move the cursor to highlight one of the 20 different ring tone options. As you highlight each ring tone, you will hear a sample of that tone. When you hear the ring tone you want to use, press the **OK** soft key. If you do not want to use a distinctive ring tone for this phonebook entry, select the NO SELECTION option, and the phone will use your standard ring tone setting.

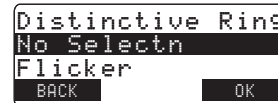

6) **Assign this entry to a Speed Dial number (Speed Dial).**

Your phone has 10 speed dial numbers, 0 to 9. Move the cursor to select the speed dial number you want to assign to this phonebook entry, and press the **OK** soft key. Select NO SELECTN if you do not want to assign this entry to a speed dial number. Press the **OK** soft key.



7) You will hear a tone confirming that the new phonebook entry has been stored, and DONE! appears in the display.

Note: When the shared memory is full, the oldest Caller ID message is overwritten.

## Chain Dialing

The speed dial numbers are not limited to just phone numbers. You can also store a group of numbers (up to 20 digits) that you need to enter once your call connects. This is referred to as Chain Dialing.

An example is a frequently refilled prescription number. Store your pharmacy phone number in one speed dial and your most frequently refilled prescription number as another speed dial. To use, once you ring your pharmacy's automated prescription line, you simply scroll through your phonebook until you find your stored prescription number and press the **DIAL** soft key.

Instructions for Chain Dialing are:

- 1) Press **[M]**.
- 2) Use **[▲]** or **[▼]** on the four-way function key to select the desired entry.
- 3) Press **[/flash]**.

Once the call has connected you will then do the following.

- 1) Press **[M]**.
- 2) Use **[▲]** or **[▼]** on the four-way function key to select the desired entry.
- 3) Press the **Dial** soft key.

## Finding a Phonebook Entry

Phonebook entries are stored in alphabetical order. To scroll through the phonebook, press **[M]** and then press **[▲]** or **[▼]** on the four-way function key. Press and hold **[▲]** or **[▼]** on the four-way function key to scroll through the display quickly.

You can also use the letters on the number keys to jump to a name that starts with that letter. Press **[M]** and a number key (**0, 2-9**) once for the first letter, twice for the second letter, and so on. The phonebook jumps to the first entry that begins with the letter you entered; you can then use **[▲]** or **[▼]** on the four-way function key to scroll to other entries. For example, to search for an entry beginning with the letter M, press **6** once.

To close the phonebook, press **[END]** on the handset. If you are looking up a phonebook entry during a call and want to close the phonebook, press the **BACK** soft key instead of **[END]**.

## Editing Phonebook Entries

- 1) Press **[M]** to open.
- 2) Use **[▲]** or **[▼]** on the four-way function key to scroll through the phonebook entries. When you come to the entry you want to edit, press the **EDIT** soft key.
- 3) Follow the steps for Creating Phonebook Entries on page 25. If you do not wish to change the information at any step, simply press the **OK** soft key to go to the next step.

## Storing Caller ID or Redial Numbers in the Phonebook

You can store Caller ID records or redial numbers in the phonebook so you can use them later. Go to the Caller ID or redial list and select the number you want to store. (If the Caller ID information did not include the number, then you will not be able to store it.)

- 1) When the phone is in standby, press **[☎]** (on the right side of the four-way key) to open the Caller ID list, or press the **REDIAL** soft key to open the redial list.
- 2) Use **[▲]** or **[▼]** on the four-way function key to scroll through the Caller ID records or redial numbers. When you come to the information you want to store, press the **STORE** soft key. STORE/EDIT NAME appears.
- 3) Follow the steps for Creating Phonebook Entries on page 25.

Note:

If the Caller ID message was received as a private or unknown number, or the message does not have the number, you cannot store the message in the phonebook. If it was received as private or unknown name, the message will be stored as <NO NAME>.

## Erasing Phonebook Entries

You can erase individual phonebook entries.

- 1) When the phone is in standby, press **[M]**.
- 2) Use **[▲]** or **[▼]** on the four-way function key or the number keypad to select desired phonebook entry, then press the **DELETE** soft key.
- 3) DELETE MEMORY? appears in the display. Select YES, and then press the **OK** soft key.
- 4) You will hear a confirmation tone, and DELETED! appears in the display.



## Copying Phonebook Entries to another Station

You can transfer stored phonebook entries from one handset to another without having to re-enter names and numbers. You can transfer one phonebook entry at a time or all phonebook entries at once.

- 1) When the phone is in standby, press [M].
- 2) Press the **COPY** soft key.
- 3) Use [▲] or [▼] on the four-way function key to select the handset to which you want transfer the phonebook entry and then press the **OK** soft key.
- 4) Use [▲] or [▼] on the four-way function key to select ONE MEMORY or ALL MEMORIES. Press the **OK** soft key.

If you select ALL MEMORIES, ARE YOU SURE? appears on the display screen.

Select YES or NO. Press the **OK** soft key.

If you select ONE MEMORY, use [▲] or [▼] on the four-way function key or the number key (0, 2-9) to select desired phonebook entry, then press the **COPY** soft key.

The phonebook entries will be transferred to the designated handset. During the copy process, the receiving handset shows RECEIVING and the Banner name of the sending handset. When the transfer is completed, DONE! appears.

Note:

- If your Phonebook contains 100 entries, you cannot store any new phonebook entries. You will hear a beep, and NOT ENOUGH MEMORY IN RECEIVING UNIT appears on the display.
- If the selected handset is out of range or data transfer is canceled, UNAVAILABLE appears in the display. Phonebook listings will not be transferred.

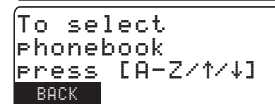
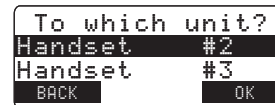

# Customizing Your Phone

## Changing the Handset Banner

Each handset will display a banner name once it is registered to the base.

The default banner is Handset #1, Handset #2, etc. You can change the name your phone displays by changing the banner display. If you have more than one handset, you can use the banner name to identify your handset during handset-to-handset functions like intercom. The banner lets you customize the name your handset displays. The name will be displayed on the LCD screen during Standby, Intercom, Intercom Hold, Room Monitor, and Copy Phonebook operations. The banner name will be displayed on the receiving handset as well.



- 1) Press the **MENU** soft key.
- 2) Select the **HANDSET SETUP** menu, and then the **BANNER** submenu.
- 3) Use the keypad or the **DELETE** soft key to enter or edit the banner name. (See page 11 for detailed instructions on entering text.)
- 4) Press the **OK** soft key. You will hear a confirmation tone.

## Selecting a Ring Tone

You may choose from 10 melodies or 10 tones for your phone's primary ring tone. Each station can use a different ring tone or melody. The available ring tones are listed below:

Melodies	Ringers
Beethoven's Symphony #9 [Beethoven9]	Flicker
For Elise [Elise]	Clatter
We Wish You A Merry Christmas [Merry- Xmas]	Soft Alert
Home Sweet Home [Hm Swt Hm]	Wake Up
Lorri Song #6 [Lorri Song]	Light Bug
When the Irish Eyes Are Smiling [Irish Eyes]	Beep Boop
Aura Lee	Tone Board
Let Me Call You Sweet Heart [Sweetheart]	Chip Chop
Waltzing Matilda [W Matilda]	Party Clap
Old MacDonald [Old MacDId]	Reminder

- 1) Press the **MENU** soft key. Select the HANDSET SETUP menu, and then the RINGER TONES submenu.
- 2) Move the cursor to highlight a ring tone. As each ring tone is highlighted, you will hear a sample of the ring tone.
- 3) When you hear the tone you want to use, press the **OK** soft key. You will hear a confirmation tone.

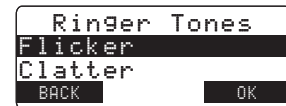



## Activating AutoTalk

AutoTalk allows you to answer the phone simply by removing the handset from the cradle. You do not have to press any keys to answer the call.

- 1) Press the **MENU** soft key
- 2) Select the HANDSET SETUP menu, and then the AUTO TALK submenu.
- 3) Select ON or OFF, and press the **OK** soft key. You will hear a confirmation tone.



## Activating Any Key Answer

Any Key Answer allows you to answer the phone by pressing any key in the number keypad.

- 1) Press the **MENU** soft key.
- 2) Select the HANDSET SETUP menu, and then the ANYKEY ANSWER submenu.
- 3) Select ON or OFF, and then press the **OK** soft key. You will hear a confirmation tone.



## Using your Phone

	From a cordless handset	From a handset speakerphone
<b>Making a call</b>	<ol style="list-style-type: none"> <li>1) Remove the handset from the charging cradle.</li> <li>2) Press <b>[*/flash]</b>.</li> <li>3) Listen for the dial tone.</li> <li>4) Dial the number.</li> </ol> <p style="text-align: center;">OR</p> <ol style="list-style-type: none"> <li>1) Remove the handset from the charging cradle.</li> <li>2) Dial the number.</li> <li>3) Press <b>[*/flash]</b>.</li> </ol>	<ol style="list-style-type: none"> <li>1) Remove the handset from the charging cradle.</li> <li>2) Press <b>[*☎]</b>.</li> <li>3) Listen for the dial tone.</li> <li>4) Dial the number.</li> </ol> <p style="text-align: center;">OR</p> <ol style="list-style-type: none"> <li>1) Remove the handset from the charging cradle.</li> <li>2) Dial the number.</li> <li>3) Press <b>[*☎]</b>.</li> </ol>
<b>Answering a call</b>	<ol style="list-style-type: none"> <li>1) Pick up the handset. (If AutoTalk is on, the phone will answer when you remove the handset from the charging cradle.)</li> <li>2) Press <b>[*/flash]</b>. (If Any Key Answer is on, you can also press any number keypad.)</li> </ol>	<ol style="list-style-type: none"> <li>1) Pick up the handset.</li> <li>2) Press <b>[*☎]</b>.</li> </ol>
<b>Hanging up</b>	<ol style="list-style-type: none"> <li>1) Press <b>[*]</b>.</li> </ol>	<ol style="list-style-type: none"> <li>1) Press <b>[*]</b>.</li> </ol>

## Making a call from the Phonebook

- 1) When the phone is in standby, press **[M]** to open the phonebook.
- 2) Scroll through the list with the **[▲]** or **[▼]** on the four-way function keys until you find the phonebook entry you want to call. (See Finding a Phonebook Entry on page 27).
- 3) Press **[\*/flash]** or **[\*☎]** on the handset.

Or

- 1) Press **[\*/flash]** or **[\*☎]** on the handset.
- 2) Press **[M]** to open the phonebook.
- 3) Scroll through the list with the **[▲]** or **[▼]** on the four-way function keys until you find the phonebook entry you want to call. (See Finding a Phonebook Entry on page 27).
- 4) Press the **DIAL** soft key to dial the number.

## Making a call with Speed Dial

- 1) When the phone is in standby, press and hold the number key **[0]-[9]** until the assigned phonebook entry appears in the display.
- 2) Press **[\*/flash]** or **[\*☎]** on the handset to dial the number.

## Switching to the Handset Speakerphone during a Call

To switch a normal call to the speakerphone, press **[\*☎]** on the handset. To switch from a speakerphone call to a normal call, press **[\*☎]**.

## Using Caller ID, Call Waiting and Redial Lists

If you subscribe to Caller ID from your phone company, your phone will show you the caller's phone number and name (if available) whenever a call comes in. If you subscribe to both Call Waiting and Caller ID, the phone also shows you the name and the number of any call that comes in while you are on the line.

Note:

- If you answer a call before the Caller ID message is received (for example, before the second ring), the Caller ID message may not appear.
- When the call is received via a Telephone Company that does not offer Caller ID service, the caller's phone number and name will not appear. (This includes some international calls.)
- When the Call is from a PBX (private branch exchange), the caller's phone number and name may not appear.

### Using the Caller ID List

You can store up to 100 Caller ID numbers in each handset. Your phone shares memory between your Phonebook and Caller ID. When the shared memory is full and when you store a new phonebook entry, the oldest Caller ID message is overwritten. Once you reach your maximum phonebook entries of 100, Caller ID information will not be stored (but it will still display when the call comes in).

To open the Caller ID list, press **[F10]** (on the right side of the four-way key). The phone will show the total number of stored Caller ID records. Use **[▲]** or **[▼]** to scroll through the list, or enter a letter on the keypad to jump to the first caller ID name that starts with that letter. To scroll quickly through the list, press and hold **[▲]** or **[▼]** on the four-way function key.

Note: The number of calls from the same Caller ID will appear next to the time to indicate that this is an unread message. Once you view the new message, the number will disappear.

## Making a call from a Caller ID Record

- 1) When the phone is in standby, press **[CID]** (on the right side of the four-way key) to open the Caller ID list.
- 2) Use **[▲]** or **[▼]** to find the Caller ID record you want to dial.
- 3) Press **[/flash]** or **[\*☎]** on the handset to dial the number.

Or

- 1) Press **[/flash]** on the handset or **[\*☎]** on the handset.
- 2) Press **[CID]** to open the Caller ID list.
- 3) Use **[▲]** or **[▼]** to find the Caller ID you want to dial.
- 4) Press the **DIAL** soft key to dial the number.

## Deleting Caller ID Numbers

To delete only one Caller ID number, go to the Caller ID list and select the number you want to delete. Press the **DELETE** soft key. When the phone asks you to confirm, select YES.

To delete all the Caller ID numbers, go to the Caller ID list and press the **DELETE** soft key. Select YES when asked if you want to DELETE ALL.

Note: When you delete a Caller ID number, you delete it permanently.

## Using Call Waiting

If you have Call Waiting service and a second call comes in when you are on the phone, a call waiting tone will sound. (If you subscribe to Caller ID on Call Waiting, the handset displays the name and phone number of the waiting call.)

### **For Australian Model:**

Press **[\*/flash]** and then **[2]** on the handset to accept the waiting call. The first caller is put on hold, and you will hear the new caller after a short pause. To return to the original caller, press **[\*/flash]** and then **[2]** again.

### **For New Zealand Model:**

Press **[\*/flash]** on the handset to accept the waiting call. The first caller is put on hold, and you will hear the new caller after a short pause. To return to the original caller, press **[\*/flash]** again.

Note: You must subscribe through your telephone provider to receive Call Waiting services.

## Redialing a Number

You can quickly redial the last 3 numbers dialed on each handset.

- 1) With the phone in standby, press the **REDIAL** soft key to open the redial list.
- 2) Use [**▲/▼**] to scroll through the redial list.
- 3) When you find the number you want to dial, press [**flash**] or [**☎**] on the handset to dial the number.

Note:

- If the number exceeds 32 digits, only the first 32 digits are retained in redial memory.
- If the redial memory is empty, you will hear a beep.

## Deleting a Redial Record

If you want to delete a phone number from the redial list, follow the steps below:

- 1) With the phone in standby, press the **REDIAL** soft key.
- 2) Use [**▲/▼**] to scroll through the redial list.
- 3) When you find the redial number you want to delete, press the **DELETE** soft key.
- 4) Select YES, and press the **OK** soft key. The redialed number is deleted.

## Adjusting the Ringer, Earpiece and Speaker Volume

### Adjusting the Ringer Volume

You can choose from three ringer volume settings on the handset (off, low, high). With the phone in standby, use [▲/▼] on the four-way function key to adjust the ringer volume.

### Adjusting the Speaker Volume

**Ear speaker:** You can choose from six volume levels for the earpiece speaker. To adjust the earpiece volume while on a call, press [▲] (to make it louder) or [▼] (to make it softer).

**Speaker:** You can choose from six volume levels for the handset speakerphone. To adjust the speaker volume while on a call, press [▲] (to make it louder) or [▼] (to make it softer).

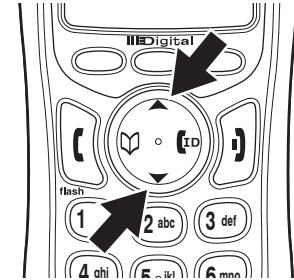

### T-coil (Handset only)

Digital spread spectrum cordless phones generate magnetic signals that could cause noise to be heard by users wearing hearing aids set to “T” mode. (The “T” mode is only found on hearing aids equipped with a telecoil (“T” coil) feature). This phone includes a special “T-coil” mode that, when activated, reduces the magnetic noise generated by the handset.

To activate the “T-coil” mode perform the following steps on your handset:

While on a call:

- 1) Press and hold [mute] for at least 5 seconds or until a beep tone is heard.
- 2) The “T-coil” mode icon  will appear on the handset LCD display.



**The handset will remain in “T-coil” mode for all future calls or until the “T-coil” mode is turned off.**

To turn off the “T-coil” mode perform the following steps on your handset:

While on a call:

- 1) Press and hold **[mute]** for at least 5 seconds or until a beep tone is heard.
- 2) The “T-coil” mode icon will no longer appear on the handset LCD display.

Note: Using the T-coil mode may shorten the amount of time you can talk on your handset between battery charges. Therefore it is recommended that the handset be returned to the charging cradle when not in use. If this feature is not required, the “T-coil” mode should not be turned on.

## Finding a Lost Handset

To locate a misplaced handset, press **[find hs]** on the base when the phone is in standby. All registered handsets will beep for 60 seconds, and PAGING appears on the handset display. To cancel paging, press **[find hs]** on the base.

Note: If the battery pack is completely drained, the handset will not beep when paging.

## Using Hold, Conference and Transfer

### Placing a Call on Hold

- 1) During a call, press **[int'com/hold]** on the handset to place the caller on hold. If you leave a caller on hold for more than ten seconds, the display screen will read, LINE ON HOLD.
- 2) To return to the party on hold, press **[/flash]** or **[\*⏏]** on a handset. The phone will return to the holding party.

Note:

- You can only place a caller on hold for 5 minutes. Once 5 minutes has passed, that party's line will be disconnected and the phone will return to standby.
- While a call is on hold, Caller ID and Call Waiting cannot be received.

## Conferencing

If you have more than one handset, up to three people can participate in a conference call. A three-way conference call consists of an outside line, and two handsets. You can easily join a call already in progress.

- 1) Press **[\*/flash]** or **[\*4#]** on the handset to join the call.
- 2) To hang up, return the handset to the cradle or press **[#]** on the handset. The other party will still be connected to the call.

## Transferring a Call

You can transfer a call from one station to another.

- 1) During a call, press **[int'com/hold]** on the handset.
- 2) Use **[▲]** or **[▼]** to select the station you want to transfer the call to, then press the **OK** soft key.

The call will automatically be placed on hold, and a paging tone sounds. To cancel the transfer, press **[\*/flash]** or **[\*4#]** on the initiating handset.

- 3) When another station accepts the transferred call, your call will be disconnected. If you want to rejoin the call, press **[\*/flash]** or **[\*4#]** on the handset.

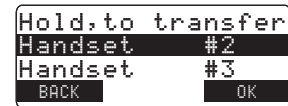

## Answering a Transferred Call

When a station receives a call transfer, it sounds a paging tone and shows the ID of the station that is paging. To accept the call transfer:

- 1) Press **[\*/flash]**, **[int'com/hold]**, or the **ANSWER** soft key from the handset.
- 2) To speak to the caller, press **[\*/flash]** on the receiving handset.

If you have multiple handsets, only the first handset to answer the transfer page will be connected to the call. If the transfer page is not picked up within one minute, the operation will be canceled.

## Using Special Features

### Muting the Ringer (One Call Only)

While the phone is ringing, press the **MUTE** soft key on the handset to mute the ringer for this call. The phone will ring again normally on the next call. (The handset must be off the cradle to mute the ringer.)

### Muting the Microphone

Mute turns off the microphone so the caller cannot hear you. The display shows the MUTE ON icon while the microphone is muted.

- 1) While you are on a call, press the **MUTE** soft key or **[mute]**.
- 2) MUTE ON will appear in the display for 2 seconds, but the  icon will appear and remain in the display until the feature is turned off.
- 3) To cancel muting, press the **MUTE** soft key or **[mute]**. MUTE OFF appears.

### Privacy Mode

If you don't want another station to interrupt you while on a call, you can turn on privacy mode. As long as your station is in privacy mode, other stations won't be able to join your call or make any calls of their own.

- 1) While on a call, press the **PRIVACY** soft key.
- 2) PRIVACY MODE ON will appear in the display for 2 seconds, but the  icon will appear and remain in the display until the feature is turned off. Other stations will not be able to make a call and their display will list SYSTEM BUSY PLEASE TRY LATER.

To turn Privacy off, repeat above steps. PRIVACY MODE OFF appears.

## Using the DirectLink Feature

A pair of handsets (or two pairs of handsets at one time) can function as two-way radios. This feature is called DirectLink and will not interfere with the base's ability to make or receive telephone calls while in use. To activate, you must set both handsets to the DirectLink feature. While using this feature, these two handsets will not be able to make or receive normal phone calls until this operation is canceled; however, other handsets will function normally.

Note: If the party is out of range, OUT OF RANGE appears in the display and the operation will be canceled.

- 1) Press the **MENU** soft key. Select DIRECTLINK MODE menu.
- 2) Press the **OK** soft key. The display shows TO ENTER DIRECTLINK MODE PRESS [ENTER].
- 3) Press the **ENTER** soft key. You will hear a confirmation tone, and DIRECTLINK MODE COMPLETE appears in the display.

Note: Speaker mode is unavailable while in Direct Link mode.

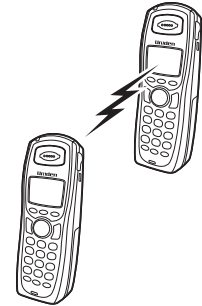

## Making a DirectLink Call

- 1) To call another handset with DirectLink, press the **DirectLink** soft key.
- 2) Select the handset you want to call by pressing the number key (**0-9**). If the handset is out of range or not in DirectLink operation, the display shows OUT OF RANGE. To exit DirectLink, press the **CANCEL** soft key.
- 3) On the receiving handset, press the **ANSWER** soft key or **[/flash]**.

## Exiting a DirectLink Call

To exit the DirectLink feature and return to standby, press the **CANCEL** soft key and then press the **OK** soft key. DIRECTLINK MODE CANCEL appears in the display.

## Intercom

### Making an Intercom Page

You can use the intercom to talk to another station without using the phone line.

- 1) With the phone in standby, press **[int'com/hold]**.
- 2) Use **[▲]** or **[▼]** to select the handset you want to talk with, and then press the **OK** soft key. If you select ALL, all other registered handsets will be paged. An intercom tone sounds. To cancel intercom, press **[\*]** on either handset.

### Answering an Intercom Page

When the intercom page tone sounds, the display will show the ID of the station that is paging.

- 1) Press **[\*/flash]**, **[int'com/hold]**, or the **ANSWER** soft key. Or press a number key, **[\*tone/<]**, or **[#/>]** (when Any Key Answer is enabled), or pick up the handset from the cradle (when AutoTalk is on).
- 2) To hang up an intercom page, press the **END** soft key or **[\*]** on either handset.

Note:

- If the party is busy, the handset returns to standby.
- If the party is out of range, UNAVAILABLE appears in the display and the operation will be canceled.
- If you receive an outside or intercom call or page while selecting the other handset, the operation is canceled.
- If you do not select a handset within 30 seconds, the operation will be canceled.
- If the party does not answer within one minute, the operation is canceled.



## Room Monitor

This feature allows you to monitor sounds in another room. Place a handset in the room you wish to monitor; it will function as a microphone. Another handset can be set to function as a remote speaker, allowing you to monitor sounds in the room.

- 1) Press the **MENU** soft key and enter ROOM MONITOR menu. TO ROOM MONITOR appears.
- 2) Select the handset you want to monitor by using [**▲**] or [**▼**].
- 3) Press the **OK** soft key. ROOMMONITOR appears, and you hear sounds in the room where the handset is installed.
- 4) To turn off the Room Monitor, press the **END** soft key or [**⏏**] on either handset or return the handset to the cradle.



### Note:

- Warning! The Room monitor function is not a replacement for regularly checking the safety and security of children. The operating time is limited to the remaining charge of the battery and is not suitable for continuous overnight use.
- This feature only works when both handsets are within range of the base.
- If the party is out of range, UNAVAILABLE appears in the display and the operation will be canceled.
- While a pair of handsets is in Room Monitoring mode, only the Handsets in monitoring mode can receive incoming calls. To resume normal telephone operation, you should terminate the monitoring session by pressing the **END** soft key on either handset.

## Tone Dialing Switch Over

If your telephone company requires pulse dialing, you can switch to tone dialing after the call connects. This feature is useful when you need tone dialing to use automated menu systems, such as telephone bank tellers, telephone prescription refills, customer support menus, etc. If your phone is set to pulse dialing, make your call normally. Once your call connects, press [**\*tone/◀**] on the handset. Any digits you enter from then on will be sent as tone dialing. When this call ends, the phone automatically returns to pulse dialing.

## Installing the Optional Headset

Your phone may be used with an optional headset. To use this feature, insert the headset plug into the headset jack. Your phone is ready for hands-free conversations. Headsets may be purchased by calling the Uniden Parts Department. See back cover page for contact information.

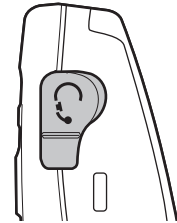

# Maintenance

## Specifications

Operating Temperature	32° F to 122° F (0° C to 50° C)
AC Adapter Part Number	Base: AAD-041S(M) or AAD-041S Charging Cradle: AAD-600S(M) or AAD-600S
Input Voltage	Base: 240V AC, 50Hz Charging Cradle: 240V AC, 50Hz
Output Voltage	Base: 9V DC @ 350mA Charging Cradle: 9V DC @ 210mA
Battery Part Number Capacity	BT-446    or    BT-750 3.6V DC @ 800mAh    3.6V DC @ 750mAh

### Notes:

- Use only the supplied AAD-041S(M) or AAD-041S and AAD-600S(M) or AAD-600S AC adapters.
- Do not use any other AC adapter.
- Do not place the power cord where it creates a trip hazard or where it could become chafed and create a fire or electrical hazard.
- Do not place the base in direct sunlight or subject it to high temperatures.



## Battery Replacement and Handling

With average use, your phone's battery should last approximately one year. To order replacement batteries, please contact Uniden's Parts Department. The contact information is listed on the back cover page.

## Cleaning the Battery Contacts

To maintain a good charge, clean the charging contacts on the handset once a month. Dampen a cloth with plain water. Gently rub the damp cloth over the charging contacts until all visible dirt is removed. Dry the contacts thoroughly before returning the handset to the charging cradle.

**Caution:** Do not use paint thinner, alcohol, or other chemical products. Doing so may discolor the surface of the telephone and damage the finish.

## Warning

To avoid the risk of personal injury or property damage from fire or electrical shock, use only Uniden AAD-041S(M) or AAD-041S (9V 350mA) and AAD-600S(M) or AAD-600S AC adapters and Uniden BT-446 or BT-750 battery pack with your phone.

Caution:

- Use only the specified Uniden battery pack BT-446 or BT-750.
- Do not remove the batteries from the handset to charge them.
- Never throw the battery into a fire, disassemble, or heat them.
- Do not remove or damage the battery casing.
- A replacement Uniden adapter or battery may be purchased by calling Uniden's Parts department. See back cover page for contact information.

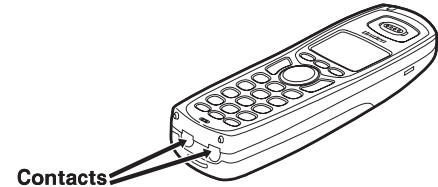

## Low Battery Alert

When the battery pack is very low, the phone is programmed to eliminate functions in order to save power. When LOW BATTERY appears in the display and the phone is in standby, none of the keys will operate. If you are on a call, complete your conversation as quickly as possible, and return the handset to the charging cradle.

The battery pack needs to be charged when the empty battery icon appears.

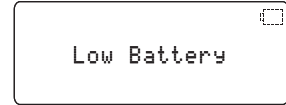

## Talk and Standby Times

With average use, your handset battery provides approximately 5 hours of talk time and approximately 7 days of standby time. When your handsets are not being used and are left off of their charging cradles, the battery will gradually discharge. You can achieve optimum battery life and performance by returning the handset to the charging cradle after each use. If the handset is left off of the charging cradle, the actual talk time duration will be reduced respective to the amount of time the handset is off of the charging cradle.

# Troubleshooting

## Resetting the Handset

You may need to reset your handset in the following instances:

- You lose a handset and purchase a new one. When you try and register to your existing base you get registration failure.
- You are unable to register any handsets to the base.
- You had a base which needed to be exchanged by the manufacturer. When you register your existing handsets to the base, the handsets say #3 and #4, but you only have 2 handsets.
- When you are instructed to by the one of the manufacturer's call center representatives.

To reset:

Press and hold **[\*]** and **[#>]** for more than 5 seconds.

You will hear a confirmation tone. The handset will clear its registration information from the base, and then delete its own base information.

PLACE HANDSET ON MAIN BASE TO REGISTER. To re-register the handset to the base (see page 23).

If the handset cannot contact the base, it will display OUT OF RANGE. Make sure the handset is in range of the base and the base is connected to power.

Note: It is also possible to reset the handset back to its original factory settings. All changes including Caller ID information will be erased. For more information on resetting the handset back to factory settings and when you need to do this, see [www.uniden.com.au](http://www.uniden.com.au) (for Australian model) or [www.uniden.co.nz](http://www.uniden.co.nz) (for New Zealand model).



## Changing the Digital Security Code

The digital security code is an identification code used to connect the handset and the base. Your unit ships from the manufacturer with a preset security code. Resetting this code is not normally necessary. In the rare situation that you suspect another cordless telephone is using the same security code or if you are instructed to change this code by a manufacturer's Call Center Representative, you can change the code by:

1. Perform "Resetting the Handset" for all of your handsets.
2. Re-register each handset by following the steps on page 23.

## Traveling Out of Range

During a call, if you move your handset too far away from your base, noise may increase. If you pass the range limits of the base, you will hear a beep and see OUT OF RANGE on the display, and then the handset returns to standby.

## Common Issues

If your phone is not performing to your expectations, please try these simple steps first. If these steps do not solve your problem, please call our Customer Hotline. See back cover page for contact information.

Symptom	Suggestion
The charge LED won't illuminate when the handset is placed in the cradle.	<ul style="list-style-type: none"><li>• Make sure the AC adaptor is plugged into the base or the charger (if you have more than one handset) and wall outlet.</li><li>• Make sure the handset is properly seated in the cradle.</li><li>• Make sure the charging contacts on the handset are clean.</li></ul>
The audio sounds weak.	<ul style="list-style-type: none"><li>• Move the handset and/or base away from metal objects or appliances and try again.</li><li>• Make sure that you are not too far from the base.</li></ul>
Can't make or receive calls.	<ul style="list-style-type: none"><li>• Make sure that you are not too far from the base.</li><li>• Make sure the line is not in use. If an outside call is already using a line, you cannot use that line to make another outside call.</li><li>• Check both ends of the base telephone line cord.</li><li>• Make sure the AC adaptor is plugged into the base and wall outlet.</li><li>• Disconnect the AC adaptor and reconnect.</li><li>• Change the Digital Security Code (see page 51).</li></ul>
The handset doesn't ring or receive a page.	<ul style="list-style-type: none"><li>• Make sure that you are not too far from the base.</li><li>• Charge the battery in the handset for at least 15-20 hours by placing the handset on the base or charging cradle.</li><li>• Change the Digital Security Code (see page 51).</li></ul>
Severe noise interference.	<ul style="list-style-type: none"><li>• Keep the handset away from microwave ovens, computers, remote control toys, wireless microphones, alarm systems, intercoms, room monitors, fluorescent lights, and electrical appliances.</li><li>• Move to another location or turn off the source of interference.</li></ul>

<b>Symptom</b>	<b>Suggestion</b>
The Caller ID does not display.	<ul style="list-style-type: none"> <li>• The call was placed through a switchboard.</li> <li>• Call your telephone provider to verify your Caller ID service is current. There may be a problem with your Caller ID service.</li> </ul>
You cannot register the handset at the base.	<ul style="list-style-type: none"> <li>• Charge the battery pack in the handset for 15-20 hours.</li> <li>• Change the Digital Security Code (see page 51).</li> <li>• Make sure you have not stored 10 handsets already.</li> </ul>
The handset doesn't communicate with other handsets.	<ul style="list-style-type: none"> <li>• Change the Digital Security Code (see page 51).</li> <li>• Make sure that you have registered all handsets.</li> </ul>
An accessory handset can't join the conversation.	<ul style="list-style-type: none"> <li>• Make sure there are not 2 handsets already using the conference feature.</li> <li>• Make sure that another station is not in privacy mode.</li> </ul>
The Room Monitor feature does not work.	<ul style="list-style-type: none"> <li>• Make sure to place the handset(s) within range of the base.</li> </ul>

## Liquid Damage

Moisture and liquid can damage your cordless phone. Follow the suggestions below if your phone gets wet.

### Exterior

If the handset or base is exposed to moisture or liquid, but only the exterior plastic housing is affected, wipe off the liquid, and use as normal.

### Interior

If moisture or liquid has entered the plastic housing (i.e. liquid can be heard in the phone or liquid has entered the handset battery compartment or vent openings on the base):

#### Handset:

1. Remove the battery cover and leave it off for ventilation.
2. Disconnect the battery pack. Leave the battery cover off and the battery pack disconnected for at least 3 days.
3. Once the handset is completely dry, reconnect the battery pack and the battery cover.
4. Recharge the handset's battery pack for 15 to 20 hours before using.

**IMPORTANT:** You must unplug the telephone line while recharging the battery packs to avoid charge interruption.

#### Base:

1. Disconnect the AC adaptor from the base, cutting off electrical power.
2. Disconnect the telephone cord from the base.
3. Let dry for at least 3 days.

**CAUTION: DO NOT** use a microwave oven to speed up the drying process. This will cause permanent damage to the handset, base and the microwave oven. After following these steps, if your cordless telephone does not work, please call our Customer Service Hotline. See back cover page for contact information.

## Precautions!

Before you read anything else, please observe the following:

### Warning!

Uniden DOES NOT represent this unit to be waterproof. To reduce the risk of fire, electrical shock, or damage to the unit, DO NOT expose this unit to rain or moisture.

### Rechargeable Nickel-Metal-Hydride Battery Warning

- This equipment contains a rechargeable Nickel-Metal-Hydride battery.
- The rechargeable batteries contained in this equipment may explode if disposed of in a fire.
- Do not short-circuit the battery.
- Do not charge the rechargeable battery used in this equipment in any charger other than the one specified in the owner's manual. Using another charger may damage the battery or cause the battery to explode.

### Rechargeable Batteries Must Be Recycled or Disposed of Properly.



The exclamation point within an equilateral triangle is intended to alert the user to the presence of important operating and maintenance (servicing) instructions in the literature accompanying the appliance.



Uniden works to reduce lead content in our PVC coated cords in our products and accessories.

### **Important Safety Instructions**

When using your telephone equipment, basic safety precautions should always be followed to reduce the risk of fire, electric shock and injury to persons, including the following:

1. Do not use this product near water, for example, near a bath tub, wash bowl, kitchen sink or laundry tub, in a wet basement or near a swimming pool.
2. Avoid using a telephone (other than a cordless type) during an electrical storm. There may be a remote risk of electric shock from lightning.
3. Do not use the telephone to report a gas leak in the vicinity of the leak.
4. Use only the power cord and batteries indicated in this manual. Do not dispose of batteries in a fire. They may explode. Check with local authorities for possible battery disposal instructions.
5. Do not disassemble any component of this product.

### **SAVE THESE INSTRUCTIONS**

### **CAUTION**

Risk of explosion if battery is replaced by an incorrect type. Dispose of used batteries according to the instructions. Do not open or mutilate the battery, and disconnect the battery before shipping this product.

# Index

## A

Adding Accessory	
Handsets .....	22, 23
Animation screen .....	19
Answering a Call .....	33
Any Key Answer .....	32
AutoTalk .....	32

## B

Battery Contacts Maintenance ...	48
Battery Replacement and Handling .....	48

## C

Caller ID on Call Waiting .....	17
Chain Dialing .....	26
Conferencing .....	41
Controls Parts of the Phone .....	7

## D

Day & Time .....	17
Deleting a Redial Record .....	38
Deleting Caller ID Numbers .....	36
Deregistration .....	24
Dial Mode .....	16

Digital Security Code .....	51
DirectLink .....	43
Distinctive Ring .....	18

## E

Earpiece Volume .....	39
Entering Text from the Phone .....	11

## H

Handset Banner .....	30
Hanging up .....	33

## I

Important Safety Instructions .....	56
Installing the Belt Clip .....	15
Installing the Phone .....	12
Installing the Rechargeable Battery .....	13

## K

Key Touch Tone .....	19
----------------------	----

## L

LCD contrast .....	19
Liquid Damage .....	54
Low Battery Alert .....	49

## M

Maintenance .....	47
Making a call .....	33
Making a call from a Caller ID Record .....	36
Making a call with Speed Dial .....	34
Muting the Microphone .....	42
Muting the Ringer .....	42

## O

Optional Headset .....	46
Out of Range .....	51

## P

Phonebook .....	25
Placing a Call on Hold .....	40
Privacy Mode .....	42
Product Overview .....	6

## R

Redialing a Number .....	38
Registering DSS7905 Accessory Handsets .....	23
Resetting the Handset .....	24, 50
Ringer Tones .....	31
Ringer Volume .....	39
Room Monitor .....	45

## **S**

Speaker Volume .....	39
Speed Dial .....	26, 34

## **T**

T-coil.....	39
Talk and Standby Times .....	49

## **V**

Voice Mail .....	20
Voice Mail Programming.....	21
Voice Mail Tone .....	20
Voice Message Waiting Indicator Reset.....	21

# Memo

# Memo

# Memo

# One Year Limited Warranty

## DSS7915, DSS7915+1 Corded Phone

**Important:** Evidence of original purchase is required for warranty service.

**Warrantor:** Uniden Australia Pty Limited A.B.N. 58 001 865 498  
Uniden New Zealand Limited **Warranty is only valid in the original country of purchase.**

**ELEMENT OF WARRANTY:** Uniden warrants to the original retail owner for the duration of this warranty, its DSS7915, DSS7915+1 cordless phone (herein after referred to as the Product), to be free from defects in materials and craftsmanship with only the limitations or exclusions set out below.

**WARRANTY DURATION:** This warranty to the original retail owner only, shall terminate and be of no further effect ONE (1) year after the date of original retail sale. This warranty will be deemed invalid if the Product is;

- (A) Damaged or not maintained as reasonable and necessary,
- (B) Modified, altered or used as part of any conversion kits, subassemblies, or any configurations not sold by Uniden,
- (C) Improperly installed,
- (D) Repaired by someone other than an authorized Uniden Repair Agent for a defect or malfunction covered by this warranty,
- (E) Used in conjunction with any equipment or parts or as part of a system not manufactured by Uniden, or
- (F) Where the Serial Number label of the product has been removed or damaged beyond recognition.

Warranty only valid in the country of original retail/sale.

**PARTS COVERED:** This warranty covers for one (1) year, the Product and included accessories.

**STATEMENT OF REMEDY:** In the event that the Product does not conform to this warranty at any time while this warranty is in effect, the warrantor at its discretion, will repair the defect or replace the Product and return it to you without charge for parts or service. This warranty does not provide for reimbursement or payment of incidental or consequential damages.

This EXPRESS WARRANTY is in addition to and does not in any way affect your rights under the TRADE PRACTICES ACT 1974 (Cth) (Australia) or the CONSUMER GUARANTEES ACT (New Zealand).

**PROCEDURE FOR OBTAINING PERFORMANCE OR WARRANTY:** In the event that the product does not conform to this warranty, the Product should be shipped or delivered, freight pre-paid, with evidence of original purchase (eg. a copy of the sales docket), to the warrantor at:

## UNIDEN AUSTRALIA PTY LIMITED

SERVICE DIVISION  
345 Princes Highway,  
Rockdale,  
NSW 2216,  
AUSTRALIA  
Fax: (02) 9599 3278  
[www.uniden.com.au](http://www.uniden.com.au)

## UNIDEN NEW ZEALAND LIMITED

SERVICE DIVISION  
150 Harris Road,  
East Tamaki,  
Auckland,  
NEW ZEALAND  
Fax: (09) 274 4253  
[www.uniden.co.nz](http://www.uniden.co.nz)



**Uniden®**

©2007 Uniden Australia Pty Limited/Uniden New Zealand Limited  
Part Code UPZZ01856BZ(0) Printed in China



## Free Manuals Download Website

<http://myh66.com>

<http://usermanuals.us>

<http://www.somanuals.com>

<http://www.4manuals.cc>

<http://www.manual-lib.com>

<http://www.404manual.com>

<http://www.luxmanual.com>

<http://aubethermostatmanual.com>

Golf course search by state

<http://golfingnear.com>

Email search by domain

<http://emailbydomain.com>

Auto manuals search

<http://auto.somanuals.com>

TV manuals search

<http://tv.somanuals.com>