

Uniden®

DSS7955
DSS7955+1
DSS7955+2
Series Owner's Manual

OWNER'S MANUAL

Contents

Welcome	4
Terminology used in this Manual	5
Product Overview	6
Features.....	6
Answering Machine Features	6
Parts of the Phone	7
Using the Interface	9
Reading the Handset Display	9
Reading the Base Display	10
Using the Four-way Function Key.....	12
Using the Handset and Base Menus	12
Entering Text from your Phone	13
Installing the Phone	14
Choosing the Best Location.....	14
Wall Mounting the Base.....	15
Direct Wall Mounting.....	16
Installing the Rechargeable Battery.....	17
Connecting the Base and Charging the Handset .	18
Installing the Belt Clip	19
Connecting to the Phone Line	19
Testing the connection	19
Changing the Dial Mode	20

Basic Setup	21
Setting the Day & Time	21
Activating Caller ID on Call Waiting	22
Activating Distinctive Ring (Handset only)	22
Name Tag.....	22
Insert 0.....	22
Activating the Key Touch Tone (Handset only)	23
Adjusting the LCD Contrast	23
Setting the Animation Screen (Handset only)	23
Adding Accessory Handsets	24
Compatible Handsets	24
Charge the Accessory Handset	24
Registering DSS7905 Accessory Handsets.....	25
Registering DSS7805WP Compatible Handsets	26
Resetting the Handsets	26
Setting up the Phonebook	27
Creating Phonebook Entries.....	27
Finding a Phonebook Entry	29
Editing Phonebook Entries	29
Storing Caller ID or Redial Numbers (Handset only) in the Phonebook	30
Erasing Phonebook Entries	30
Copying Phonebook Entries to another Station.....	31

Customizing Your Phone	32	Finding a Lost Handset	42
Changing the Handset Banner (Handset only)	32	Using Hold, Conference and Transfer	42
Selecting a Ring Tone (Handset only).....	33	Placing a Call on Hold	42
Activating AutoTalk (Handset only)	34	Conferencing	42
Activating Any Key Answer (Handset only).....	34	Transferring a Call	43
Using your Phone	35	Answering a Transferred Call	43
Making a call from the Phonebook	36	Using Special Features	44
Chain Dialing from the Phonebook	36	Do Not Disturb (All calls).....	44
Making a call with Speed Dial.....	36	Muting the Ringer (One call only)	44
Switching to the Handset Speakerphone		Muting the Microphone	44
during a Call.....	36	Privacy Mode	45
Using Caller ID, Call Waiting and Redial Lists	37	Using the DirectLink Feature	45
Using the Caller ID List	37	Intercom	46
Making a call from a Caller ID Record	38	Room Monitor	47
Deleting Caller ID Numbers	38	Tone Dialing Switch Over.....	48
Using Call Waiting.....	39	Installing the Optional Headset.....	49
Redialing a Number	40	Setting Up the Answering Machine	50
Deleting a Redial Record (Handset only)	40	Features.....	50
Adjusting the Ringer, Earpiece and		Using the Answering Machine Interface	51
Speaker Volume	41	Your Greeting.....	52
Adjusting the Ringer Volume	41	Setting the Number of Rings.....	54
Adjusting the Speaker Volume	41	Setting the Record Time (or Announce only).....	54
T-coil (Handset only)	41	Activating the Message Alert	55
		Activating Call Screening.....	55

Setting a Security Code or Personal Identification Number (PIN)	55	Liquid Damage	72
Using the Answering Machine	56	Precautions!	73
Turning your Answering Machine On and Off	56	Rechargeable Nickel-Metal-Hydride Battery Warning	73
Reviewing Messages	57	Index	75
Screening Calls	59	Remote Operation Card	80
Recording a Conversation	60	One Year Limited Warranty	82
Recording a Voice Memo	61		
Message Alert	61		
Remotely Operating Your Answering Machine	62		
Maintenance	65		
Specifications	65		
Battery Replacement and Handling	66		
Cleaning the Battery Contacts	66		
Low Battery Alert	67		
Talk and Standby Times	67		
Troubleshooting	68		
Resetting the Handset	68		
Changing the Digital Security Code	69		
Traveling Out of Range	69		
Common Issues	69		

Welcome

Thank you for purchasing a Uniden Multi-Handset phone.

Note: Illustrations in this manual are used for explanation purposes. Some illustrations in this manual may differ from the actual unit.

Terminology used in this Manual

Standby	The handset and the base are not in use. If the handset is on the cradle or [/flash] or [••] on the handset or [••] on the base is not pressed, no line has been activated. No dial tone is present.
CID	Caller ID is available from your Telephone provider and is offered to users on a subscription basis. With this service and a display on your cordless phone, you will be able to see the incoming caller information such as name and phone number.
CID/CW or CIDCW	Caller ID with Call Waiting is available by subscription from your Telephone provider. With this service, you will be able to view incoming caller information while on a call with another user. This will allow you the ability to select to talk to this user and put your existing party on hold or make the decision to ring them back.
DirectLink	If you have accessory handsets on your system, you can use two handsets as 2-way radios.
Accessory Handsets	This phone system is expandable and will support a total of ten (10) handsets to one base. The DSS7905 accessory handset is compatible with this model.
Global settings	Global Settings apply to all registered handsets and the base. If you change something under the global menu, you change it for all handsets and the base. Only one handset or the base can change global settings at a time, and you have to make sure the phone is not currently being used.
Station	Any handset or the base.
Talk	A telephone line has been activated on the handset or base, enabling a dial tone.

Product Overview

Features:

- 5.8GHz DSS Expandable System
- Expands up to 10 Handsets
- Integrated Digital Answering Machine
- Caller ID*
 - Caller ID on Call Waiting
 - Name Tag (POP ID)
 - Distinctive Ring
- Base Keypad
- Advanced Phonebook Features:
 - Store Up to 100 Names for each station
 - Alphabetical Search
 - Distinctive Ring by Party
 - Transfer Single Listing or Entire Phonebook
- DirectLink™
- Room Monitoring
- Speakerphones on Base & Handset
- 20 Ringer Options on Handset (10 Tones/10 Melodies)
- 10 Speed Dial Numbers
- Last 3 Number Redial
- Call Transfer
- Conferencing
- Intercom
- T-coil
- Handset Keypad Lock

Answering Machine Features:

- Digital Tapeless Recording
- Up to 12 Minutes of Recording Time
- Call Screening
- Personal or Pre-recorded Outgoing Messages
- Day and Time Announcement
- Remote Message Retrieval
- Toll Saver
- Conversation Recording
- Voice Memo
- Message Alert
- Records Up to 59 messages

* Caller ID, Name Tag, Distinctive Ring features require subscription to the Caller Display service from your network supplier. A fee normally applies for this. The Caller ID on Call Waiting service is currently unavailable in New Zealand.

Parts of the Phone

The following illustrations show you all of the different parts of your phone.

Handset

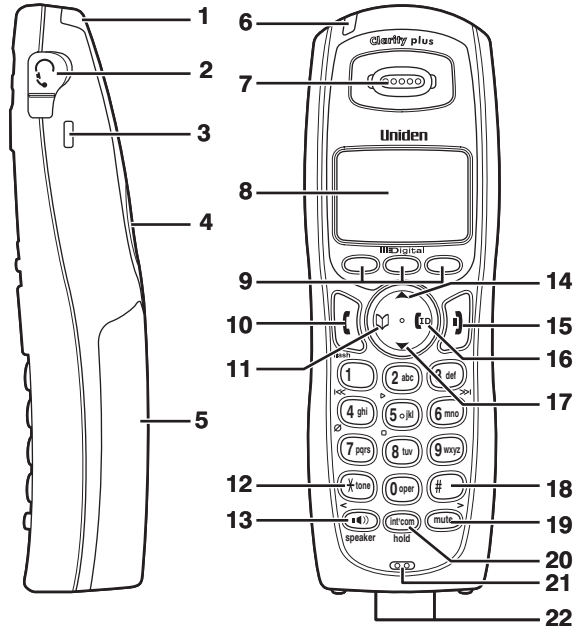

1. Handset Antenna
2. Headset Jack Cover
3. Beltclip Hole
4. Speakerphone Speaker and Ringer
5. Handset Battery Compartment
6. New Message LED
7. Handset Earpiece
8. LCD Display
9. Soft keys
10. [flash] (talk/flash) key
11. [phonebook] (phonebook) key
12. [tone/lt] key
13. [speaker] (speaker) key
14. [up] (up) key
15. [end call] (end call) key
16. [caller ID] (caller ID) key
17. [down] (down) key
18. [*/>] key
19. [mute] key
20. [int'com/hold] (intercom/hold) key
21. Handset Microphone
22. Handset Charging Contacts

Base

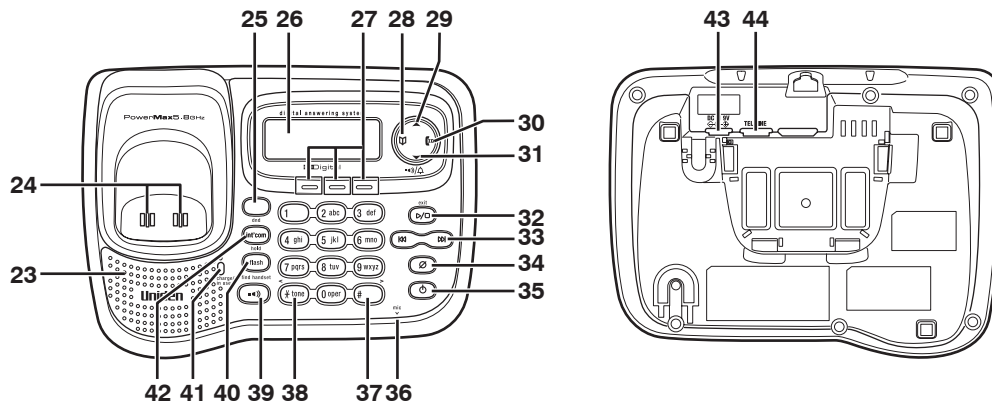







- 23. Base Speaker
- 24. Base Charging Contacts
- 25. **[dnd]** (do not disturb) key and LED
- 26. Base LCD
- 27. Soft Keys
- 28. **[☎]** (phonebook) key
- 29. **[▲]** (up) key
- 30. **[CID]** (caller ID) key
- 31. **[▼]** (down) key
- 32. **[▶/□/exit]** (play/stop/exit) key
- 33. **[⏮ / ⏭]** (repeat/skip) key
- 34. **[⌫]** (delete) key
- 35. **[📞]** (answering machine on/off) key
- 36. Base Microphone
- 37. **[#/>]** key
- 38. **[*tone/<]** key
- 39. **[•••]** (speaker) key and speaker LED
- 40. **[flash/find handset]** key
- 41. charge/in use LED
- 42. **[int'com/hold]** (intercom/hold) key
- 43. DC IN 9V Jack
- 44. TEL LINE Jack

Using the Interface









Reading the Handset Display

The handset display uses icons to tell you the status of your phone. The table below lists the icons and what they mean.

Icon	Status	Description
	Talk	The privacy icon appears when Privacy mode is turned on.
	Talk	The call record icon appears while recording a conversation.
	Talk	The mute icon appears when you mute the handset.
	Talk	The speaker icon appears when the handset speakerphone is in use.
	Talk	This icon appears when T-coil mode is turned on.
	Standby	The ringer off icon indicates that the ringer is turned off.
	Standby/Talk	The battery icon indicates the handset battery status: empty, low, medium, and full.

Reading the Base Display

The base display uses icons to tell you the status of your phone. The table below lists the icons and what they mean.

Icon	Status	Description
	Talk	The privacy icon appears when Privacy mode is turned on.
	Talk	The call record icon appears while recording a conversation.
	Talk	The mute icon appears when you mute the base.
	Standby	The new message icon appears when a new messages is received.
	Standby/Talk	The answering machine off icon appears when the answering machine is turned off.
	Standby/Talk	The answering machine full icon appears when the memory on the answering machine is full.
	Standby/Talk	The answering machine announce only icon appears when the answering machine is set to announce only greeting.
	Standby	The ringer off icon indicates that the ringer is turned off.

The Standby Screen

When the phone is in standby, the handset and base display shows the following items:

- Handset

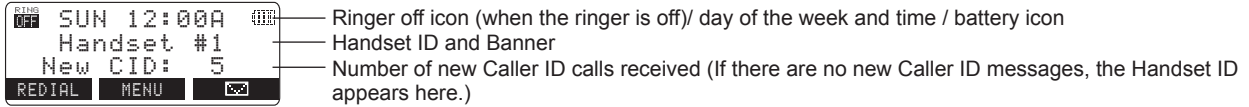

- Base



Using the Four-way Function Key

Your handset and the base have a four-way function key that allows you to move the cursor (or highlighted area) on the display and access the most commonly used features at the touch of a button. By moving this key to the left, you open the Phonebook. Move the key to the right to access Caller ID information. To use this four-way key, place your thumb over the key on the station and move to the four positions to get the feel of how it moves and operates.

Using the Handset and Base Menus

To open the menu, press the **MENU** soft key. Highlight the option you want by pressing the four-way function key. This will move the cursor; the option currently highlighted appears in reversed out text. Select the highlighted option by pressing the **OK** soft key. To exit the menu and return to standby, press **[*]]** on the handset and **[>/□/exit]** on the base.

If you do not press a key within 30 seconds, the phone will time out and exit the menu. When setting Day and Time, the time-out period is extended to two minutes.

Note: For ANSW. SETUP, GLOBAL SETUP and DEREGISTER HS, make sure the line is not in use and the handsets are within range of the base.

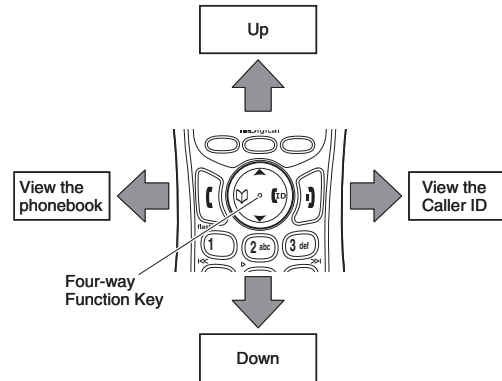

Entering Text from your Phone

You can use the number keypad on your handset or base to enter text by referring to the letters printed on each number key. When you press the number key in a text entry field, the phone displays the first letter printed on the number key. Press the number key twice to display the second letter and three times to display the third. Capital letters are displayed first, then lower case letters, then the number on the key.

If two letters in a row use the same number key, enter the first letter, then use **[#/>]** or **[*tone/<]** to move the cursor to the next position to enter the second letter. For example, to enter Movies:

- 1) Press 6 once to enter M.
- 2) Use **[#/>]** to move the cursor to the right.
- 3) Press 6 six times to enter o.
- 4) Press 8 six times to enter v.
- 5) Press 4 six times to enter i.
- 6) Press 3 five times to enter e.
- 7) Press 7 eight times to enter s.
- 8) Press the **OK** soft key to end your text entry.

If you make a mistake while entering a name, use **[#/>]** or **[*tone/<]** to move the cursor to the incorrect character. Press the **DELETE** soft key to erase the wrong character, and then enter the correct character. To delete all characters, press and hold the **DELETE** soft key.

	Number of times key is pressed								
keys	1	2	3	4	5	6	7	8	9
1	1								
2 abc	A	B	C	a	b	c	2		
3 def	D	E	F	d	e	f	3		
4 ghi	G	H	I	g	h	i	4		
5 jkl	J	K	L	j	k	l	5		
6 mno	M	N	O	m	n	o	6		
7 pqrs	P	Q	R	S	p	q	r	s	7
8 tuv	T	U	V	t	u	v	8		
9 wxyz	W	X	Y	Z	w	x	y	z	9
	&	<	>	<	>	/	(blank)	-	-
0 oper	.	,	:	?	!	@	'	"	*
	#	0							

Installing the Phone

Choosing the Best Location

When choosing a location for your new phone, here are some important guidelines you should consider:

- The location should be close to both a phone jack and a continuous power outlet (one which is not connected to a switch).
- The base and handset should be kept away from sources of electrical noise such as motors, microwave ovens, and fluorescent lighting.
- For better reception, place the base as high as possible.
- The base should be placed in an open area for optimum range and reception.
- If your home has wired alarm equipment connected to a phone line, be sure that installing the system does not disable your alarm equipment. If you have questions about what will disable alarm equipment, contact your telephone company or a qualified installer.

Note: For maximum range:

- Keep the antenna free of obstruction.
- When the handset is not in use, place the handset in an upright position.
- Do not hold the handset where you would block the signal.
- Metal and reinforced concrete may affect cordless telephone performance.

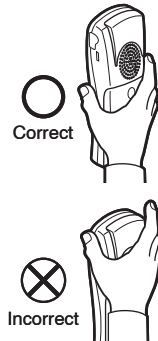

Wall Mounting the Base

This phone can be mounted on any standard wall plate.

- 1) Snap the wall mount adaptor into the notches on the base top.
- 2) Plug the AC adaptor into the DC IN 9V jack.
- 3) Wrap the AC adaptor cord inside the molded wiring channel as shown.
- 4) Plug the AC adapter into a standard 240V AC wall outlet.
- 5) Plug the telephone line cord into the TEL LINE jack.
- 6) Plug the telephone line cord into the telephone outlet.
- 7) Align the mounting slots on the base with the mounting posts on the wall. Then push in and down until the phone is firmly seated.

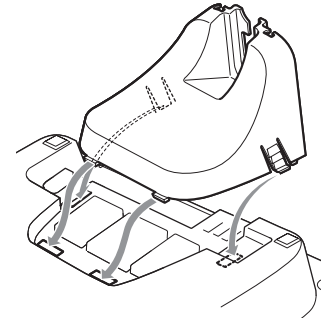

Note: DO NOT use an AC outlet controlled by a wall switch.

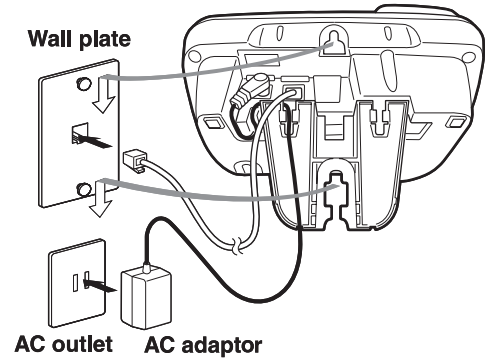

Direct Wall Mounting

If you don't have a standard wall plate, you can mount your phone directly to the wall. Before doing this, consider the following:

- Avoid electrical cables, pipes, or other items behind the mounting location that could cause a hazard when inserting screws into the wall.
 - Try to mount your phone within 1.5m of a working phone jack to avoid excessive wire lengths.
 - Make sure the wall material is capable of supporting the weight of the base and handset.
 - Use #10 screws with a minimum length of 35mm, with anchoring devices suitable for the wall material where the base unit will be placed.
- 1) Insert two mounting screws into the wall, using the appropriate anchoring device, 100mm apart. Allow about 3mm between the wall and screw heads for mounting the phone.
 - 2) Refer to the steps on page 15 to complete the mounting process.

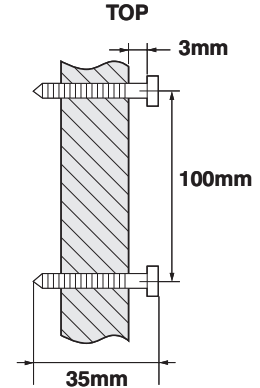

Installing the Rechargeable Battery

Use only the Uniden BT-446 or BT-750 rechargeable battery pack supplied with your cordless telephone.

Follow the steps below to install a battery:

- 1) Press in on the handset battery case cover (use the finger indentation for a better grip) and slide the cover downward to remove.
- 2) Plug the battery cable into the battery jack. Be sure to match the red and black wires to the label near the jack. The cable should snap into place. Gently pull on the battery cable. If the battery connector comes loose, try connecting again until the battery snaps into place.
- 3) Place the battery case cover back on the handset and slide it upwards until it clicks into place.

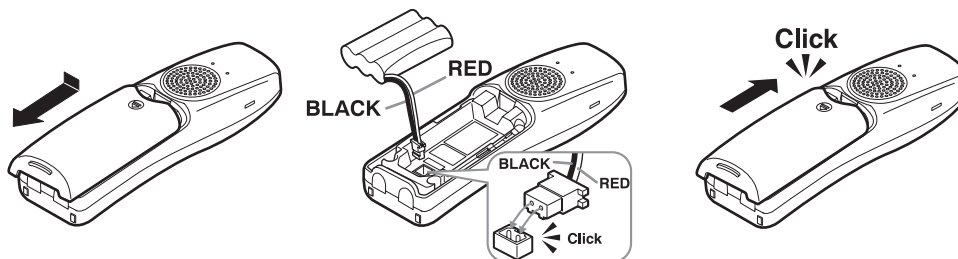

Connecting the Base and Charging the Handset

- 1) Connect the AC adaptor to the DC IN 9V jack.
- 2) Connect the AC adaptor to a continuous power supply (i.e., an outlet that is not controlled by a switch).
- 3) Place the handset in the base with the LCD screen facing forward.
- 4) Make sure that the charge/in use LED illuminates. If the LED does not illuminate, check to see that the AC adaptor is plugged in and the handset makes good contact with the base charging contacts.
- 5) Charge your handset at least 15-20 hours before plugging into the phone line.

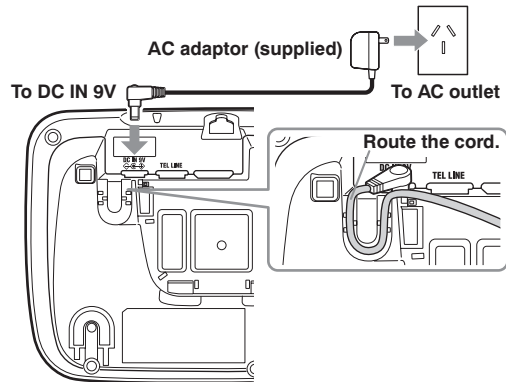

Installing the Belt Clip

- 1) Line up the holes on each side of the handset. To attach the belt clip, insert into the holes on each side of the handset. Press down until it clicks.
- 2) To remove the belt clip, pull either side of the belt clip to release the tabs from the holes.

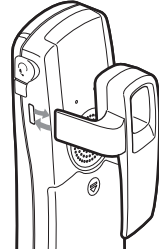

Connecting to the Phone Line

Once the handset battery pack is fully charged, connect the telephone cord to the TEL LINE jack and to a telephone outlet.

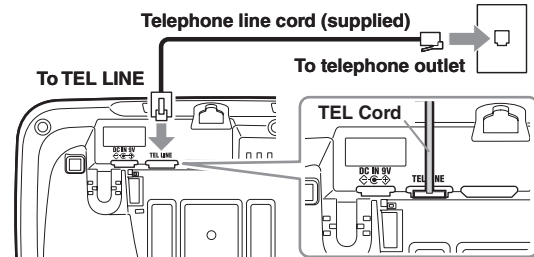

Testing the connection

To test your connection, try making a call. If your call connects, the settings are fine. If your call does not connect, check the following:

- 1) Check to see that the AC adaptor cord is securely connected to the DC IN 9V jack and to a standard AC power outlet.
- 2) Check to make sure the battery is fully charged. (If you don't see the "battery full" icon, check to make sure the battery is properly connected.)
- 3) Change dial mode (instructions on page 20).

Changing the Dial Mode (Australian Model Only)

Your phone can communicate with the telephone network in two different ways: tone dialing or pulse dialing. These days, most phone networks use a method called tone dialing, so your phone comes programmed for tone dialing. If your phone company uses pulse dialing, you will need to change your phone's dial mode. If you cannot connect to the telephone network, please follow the steps below to modify your phone's settings:

- 1) Press the **MENU** soft key. Select the GLOBAL SETUP menu, and then the DIAL MODE submenu.
- 2) Press [**▼**] on the four-way function key to select PULSE. (The initial setting is Tone).
- 3) Press the **OK** soft key. You will hear a confirmation tone.

If you ever need to change the dial mode back to Tone, follow the same procedure, but select **TONE** in step 2.

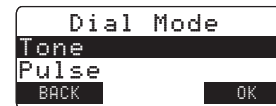

Basic Setup

Setting the Day & Time

To change the day and time shown in the display, follow the steps listed below.

Note: If you don't press any keys for two minutes when setting the date and time, the phone will exit the menu.



- 1) Press the **MENU** soft key. Select the GLOBAL SETUP menu, and then the DAY & TIME submenu.
- 2) Press [▲] or [▼] to select the day of the week, and then the → soft key.
- 3) Press [▲] or [▼] to select hour, and then the → soft key.
- 4) Press [▲] or [▼] to select minute, and then the → soft key.
- 5) Press [▲] or [▼] to select AM or PM, then press the **SAVE** soft key. You will hear a confirmation tone

Activating Caller ID on Call Waiting

Your phone supports Caller ID on Call Waiting (CIDCW), so you can see the name and number of someone who calls when you're already on the line. You'll need to subscribe to these features with your phone company before you can use them. To let your phone support these features, follow the steps below:



- 1) Press the **MENU** soft key. Select the GLOBAL SETUP menu, and then the CIDCW submenu.
- 2) Move the cursor to select ON or OFF.
- 3) Press the **OK** soft key. You will hear a confirmation tone.

Activating Distinctive Ring (Handset only)

You can assign special ring tones to anyone in your phonebook. When your phone gets a call, it looks up the Caller ID information in your phonebook. If you've assigned a Distinctive ring to that number, the phone uses it so you know who is calling. To turn on Distinctive ring, follow these steps:

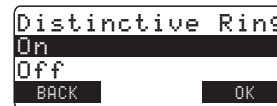

- 1) Press the **MENU** soft key. Select the HANDSET SETUP menu, and then the DISTINCTIVE RING submenu.
- 2) Move the cursor to select ON or OFF.
- 3) Press the **OK** soft key. You will hear a confirmation tone.

Name Tag

Name Tagging works with the caller display number from Caller ID. You will need to subscribe to the Caller ID feature with your phone company for Name Tagging to work.

When the phone rings, the received caller display number is compared to numbers stored in the phonebook. If there is a match then any name stored with the phonebook number will be displayed. To change the Name Tagging setting, follow the steps listed below.

- 1) Press the MENU soft key. Select the GLOBAL SETUP menu, and then the NAME TAG submenu.
- 2) Move the cursor to select ON or OFF.
- 3) Press the OK soft key. You will hear a confirmation tone.

Insert 0

This feature adds "0" or "00" at the beginning of the number received from Caller ID. The default setting for New Zealand is ON. The default setting for Australia is OFF. To change the Name Tagging setting, follow the steps listed below.

- 1) Press the MENU soft key. Select the GLOBAL SETUP menu, and then the INSERT 0 submenu.
- 2) Move the cursor to select ON or OFF.
- 3) Press the OK soft key. You will hear a confirmation tone.

Activating the Key Touch Tone (Handset only)

Key Touch Tone is the tone your keypad makes when keys are pressed. You can turn this tone on or off.

- 1) Press the **MENU** soft key. Select the HANDSET SETUP menu, and then the KEY TOUCH TONE submenu.
- 2) Move the cursor to select ON or OFF.
- 3) Press the **OK** soft key. You will hear a confirmation tone.



Adjusting the LCD Contrast

Contrast adjusts the handset and base LCD brightness. Choose one from the 10 levels for optimum viewing.

- 1) Press the **MENU** soft key. Select the HANDSET SETUP menu, and then the CONTRAST submenu or BASE CONTRAST menu.
- 2) Press [**▲**] or [**▼**] on the four-way function key to adjust the contrast of the LCD.
- 3) Press the **OK** soft key. You will hear a confirmation tone.



Setting the Animation Screen (Handset only)

The Animation screen displays animation on the handset LCD. The animations will be displayed on the LCD screen during a call, ringer volume setting, when you hang up, and so on.

- 1) Press the **MENU** soft key. Select the HANDSET SETUP menu and then the ANIMATION SCREEN submenu.
- 2) Press [**▲**] or [**▼**] to select ON or OFF.
- 3) Press the **OK** soft key. You will hear a confirmation tone.

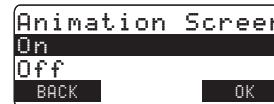
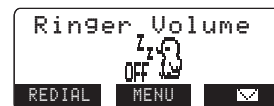

Adding Accessory Handsets

Your phone supports up to ten (10) handsets, including any handsets supplied with your phone. Accessory handsets do not need to be connected to a phone jack. You can now place a fully-featured cordless handset anywhere AC power is available to connect the handset charger.

Compatible Handsets

Your phone is compatible with the DSS7905 and DSS7805WP. If you purchase an accessory handset, you must register the handset to the original or main base before use. Accessory handsets will not operate until they are registered.

Charge the Accessory Handset

The handset is powered by a rechargeable battery pack. The battery recharges automatically when the handset is placed in the charger.

- 1) Connect the AC adaptor to the DC IN 9V jack and to a standard 240V AC wall outlet.
- 2) Set the charger on a desk or tabletop, and place the handset in the charger with the keypad facing forward.
- 3) Make sure that the charge LED illuminates. If the LED does not illuminate, check to see that the AC adaptor is plugged in and the handset makes good contact with the charging contacts.
- 4) Charge the handset battery pack for at least 15-20 hours before using your new cordless telephone for the first time.

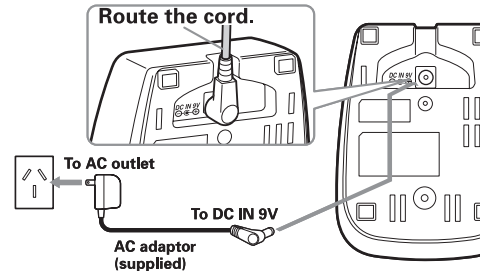

Registering DSS7905 Accessory Handsets

Your phone supports a total of ten (10) cordless handsets. Handset(s) supplied in the box with the phone base are pre-registered at the factory. If you purchase an accessory handset, you need to register the handset before use. Only one handset can be registered at a time. When charged, pre-registered handsets display a handset ID number. Handsets that have not been registered display.

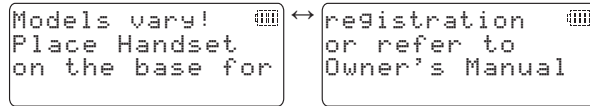

- 1) Before registering the **DSS7905** accessory handset, the battery pack **MUST** be charged for 15-20 hours.
- 2) To register the DSS7905 handset:
 - Place the handset in the base charging cradle to begin registration.
- 3) During the registration process, **HANDSET REGISTERING** will appear in the LCD. When **REGISTRATION COMPLETE** is displayed, the handset has been registered to the base. If **REGISTRATION FAILED** appears, please try these steps again. A handset ID and banner will be automatically assigned when registration is complete.

Note: If an accessory handset has ever been registered to a base, you must reset the handset before you can register it to a new base. For the instruction on resetting the accessory handset, please refer to the manual supplied with DSS7905.

Registering DSS7805WP Compatible Handsets

- 1) Disconnect the base AC adapter.
- 2) While holding the [flash/find handset], reconnect the AC adapter until the charge/in use LED starts blinking.
- 3) On the handset, press and hold [#] until you hear a beep.
- 4) While the handset is registering, HANDSET REGISTERING will appear in the LCD. When REGISTRATION COMPLETE is displayed; the handset has been registered to the base. If REGISTRATION FAILED appears, please try these steps again.

Resetting the Handsets

If you want to register a handset to a different base or replace a handset with another one, you must first clear the existing registration data. To clear, please follow these steps:

- 1) Press the **MENU** soft key. Select the DEREGISTER HS submenu.
- 2) DEREGISTER HS? appears. Move the cursor to select YES. Press the **OK** soft key.



Or

- 1) From the handset, press and hold [P] and [#>] for more than 5 seconds. You will hear a confirmation tone, and DEREGISTRATION COMPLETE appears.

After resetting the handset, place the handset to the base to register. You must re-register the handset before you can use it.

Setting up the Phonebook

Your phone allows you to store up to 100 names in your handset and base phonebook. Your phone shares memory between your phonebook and CID with a total of 100 entries. Once you store 100 phonebook entries, CID information will not be stored and will only display at time of new incoming calls. When Phonebook entries are full, you will hear a beep and MEMORY FULL appears. You cannot store additional names and numbers unless you delete some of the existing ones.

You can also use the Phonebook or speed dial locations to store a group of numbers (up to 20 digits) that you may need to enter once your call connects. This is referred to as Chain Dialing. See Chain Dialing from the Phonebook on page 36.

Creating Phonebook Entries

To store names and numbers in your Phonebook, please follow these steps:

- 1) When the phone is in standby mode, press [M] (on the left side of the four-way key).
- 2) To create a new phonebook entry, press the **STORE** soft key. STORE/EDIT NAME appears.
- 3) **Enter the name for this entry (Edit Name).**
Use the keypad to enter a name for this entry; the name can contain up to 16 characters. (See page 13 for instructions on entering text.) If you do not want to enter a name for this entry, your phone will store this entry as No Name. Press the **OK** soft key when you are finished.



4) **Enter the number for this entry.**

Once you have stored a name, STORE/EDIT NO. appears next. Use the number keypad, [#>], [*tone/<], or the **DELETE** soft key to enter the phone number ; the phone number can contain up to 20 digits. If you need the phone to pause between digits when it's dialing (for example, to enter an extension or an access code), press the **PAUSE** soft key to insert a two-second pause. You will see a P in the display. You can also use more than one pause together if two seconds is not long enough. Each pause counts as one digit. Press the **OK** soft key when you are finished.



5) **Assign a distinctive ring tone for this entry (Distinctive Ring) (Handset only).**

You can attach a personalized ring tone to each phonebook entry; the phone will use this ring tone when this person calls. Move the cursor to highlight one of the 20 different ring tone options. As you highlight each ring tone, you will hear a sample of that tone. When you hear the ring tone you want to use, press the **OK** soft key. If you do not want to use a distinctive ring tone for this phonebook entry, select the NO SELECTN option, and the phone will use your standard ring tone setting.



6) **Assign this entry to a Speed Dial number (Speed Dial).**

Your phone has 10 speed dial numbers, 0 to 9. Move the cursor to select the speed dial number you want to assign to this phonebook entry, and press the **OK** soft key. Select NO SELECTN if you do not want to assign this entry to a speed dial number. Press the **OK** soft key.



7) You will hear a tone confirming that the new phonebook entry has been stored, and DONE! appears in the display.

Note: When the shared memory is full, the oldest Caller ID message is overwritten.

Finding a Phonebook Entry

Phonebook entries are stored in alphabetical order. To scroll through the phonebook, press **[M]** and then press **[▲]** or **[▼]** on the four-way function key. Press and hold **[▲]** or **[▼]** on the four-way function key to scroll through the display quickly.

You can also use the letters on the number keys to jump to a name that starts with that letter. Press **[M]** and a number key (**0, 2-9**) once for the first letter, twice for the second letter, and so on. The phonebook jumps to the first entry that begins with the letter you entered; you can then use **[▲]** or **[▼]** on the four-way function key to scroll to other entries. For example, to search for an entry beginning with the letter M, press **6** once.

To close the phonebook, press **[*]** on the handset or **[>/□/exit]** on the base. If you are looking up a phonebook entry during a call and want to close the phonebook, press the **BACK** soft key instead of **[*]**.

Editing Phonebook Entries

- 1) Press **[M]** to open.
- 2) Use **[▲]** or **[▼]** on the four-way function key to scroll through the phonebook entries. When you come to the entry you want to edit, press the **EDIT** soft key.
- 3) Follow the steps for Creating Phonebook Entries on page 27. If you do not wish to change the information at any step, simply press the **OK** soft key to go to the next step.

Storing Caller ID or Redial Numbers (Handset only) in the Phonebook

You can store Caller ID records or redial numbers in the phonebook so you can use them later. Go to the Caller ID or redial list and select the number you want to store. (If the Caller ID information did not include the number, then you will not be able to store it.)

- 1) When the phone is in standby, press **[*]** (on the right side of the four-way key) to open the Caller ID list, or press the **REDIAL** soft key on the handset to open the redial list.
- 2) Use **[▲]** or **[▼]** on the four-way function key to scroll through the Caller ID records or redial numbers. When you come to the information you want to store, press the **STORE** soft key. STORE/EDIT NAME appears.
- 3) Follow the steps for Creating Phonebook Entries on page 27.

Note:

If the Caller ID message was received as a private or unknown number, or the message does not have the number, you cannot store the message in the phonebook. If it was received as private or unknown name, the message will be stored as <NO NAME>.

Erasing Phonebook Entries

You can erase individual phonebook entries.

- 1) When the phone is in standby, press **[M]**.
- 2) Use **[▲]** or **[▼]** on the four-way function key or the number keypad to select desired phonebook entry, then press the **DELETE** soft key.
- 3) DELETE MEMORY? appears in the display. Select YES, and then press the **OK** soft key.
- 4) You will hear a confirmation tone, and DELETED! appears in the display.



Copying Phonebook Entries to another Station

You can transfer stored phonebook entries from one station to another without having to re-enter names and numbers. You can transfer one phonebook entry at a time or all phonebook entries at once.

- 1) When the phone is in standby, press [M].
- 2) Press the **COPY** soft key.
- 3) Use [▲] or [▼] on the four-way function key to select the station to which you want transfer the phonebook entry and then press the **OK** soft key.
- 4) Use [▲] or [▼] on the four-way function key to select ONE MEMORY or ALL MEMORIES. Press the **OK** soft key.

If you select ALL MEMORIES, ARE YOU SURE? appears on the display screen.

Select YES or NO. Press the **OK** soft key.

If you select ONE MEMORY, use [▲] or [▼] on the four-way function key or the number key (0, 2-9) to select desired phonebook entry, then press the **COPY** soft key.

The phonebook entries will be transferred to the designated station. During the copy process, the receiving station shows RECEIVING and the Banner name of the sending handset. When the transfer is completed, DONE! appears.

Note:

- If your Phonebook contains 100 entries, you cannot store any new phonebook entries. You will hear a beep, and NOT ENOUGH MEMORY IN RECEIVING UNIT appears on the display.
- If the selected handset is out of range or data transfer is canceled, UNAVAILABLE appears in the display. Phonebook listings will not be transferred.

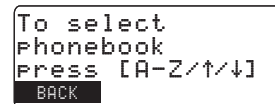
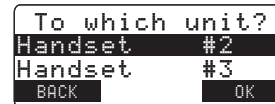

Customizing Your Phone

Changing the Handset Banner (Handset only)

Each handset will display a banner name once it is registered to the base.

The default banner is Handset #1, Handset #2, etc. You can change the name your phone displays by changing the banner display. If you have more than one handset, you can use the banner name to identify your handset during handset-to-handset functions like intercom and DirectLink. The banner lets you customize the name your handset displays. The name will be displayed on the LCD screen during Standby, Intercom, Intercom Hold, Room Monitor, and Copy Phonebook operations. The banner name will be displayed on the receiving handset as well.



- 1) Press the **MENU** soft key.
- 2) Select the HANDSET SETUP menu, and then the BANNER submenu.
- 3) Use the keypad or the **DELETE** soft key to enter or edit the banner name. (See page 13 for detailed instructions on entering text.)
- 4) Press the **OK** soft key. You will hear a confirmation tone.

Selecting a Ring Tone (Handset only)

You may choose from 10 melodies or 10 tones for your phone's primary ring tone. Each station can use a different ring tone or melody. The available ring tones are listed below:

Melodies	Ringers
Beethoven's Symphony #9 [Beethoven9]	Flicker
Fur Elise [Elise]	Clatter
We Wish You A Merry Christmas [Merry- Xmas]	Soft Alert
Home Sweet Home [Hm Swt Hm]	Wake Up
Lorri Song #6 [Lorri Song]	Light Bug
When the Irish Eyes Are Smiling [Irish Eyes]	Beep Boop
Aura Lee	Tone Board
Let Me Call You Sweet Heart [Sweetheart]	Chip Chop
Waltzing Matilda [W Matilda]	Party Clap
Old MacDonald [Old MacDId]	Reminder

- 1) Press the **MENU** soft key. Select the HANDSET SETUP menu, and then the RINGER TONES submenu.
- 2) Move the cursor to highlight a ring tone. As each ring tone is highlighted, you will hear a sample of the ring tone.
- 3) When you hear the tone you want to use, press the **OK** soft key. You will hear a confirmation tone.



Activating AutoTalk (Handset only)

AutoTalk allows you to answer the phone simply by removing the handset from the cradle. You do not have to press any keys to answer the call.

- 1) Press the **MENU** soft key
- 2) Select the HANDSET SETUP menu, and then the AUTO TALK submenu.
- 3) Select ON or OFF, and press the **OK** soft key. You will hear a confirmation tone.



Activating Any Key Answer (Handset only)

Any Key Answer allows you to answer the phone by pressing any key in the number keypad.

- 1) Press the **MENU** soft key.
- 2) Select the HANDSET SETUP menu, and then the ANYKEY ANSWER submenu.
- 3) Select ON or OFF, and then press the **OK** soft key. You will hear a confirmation tone.

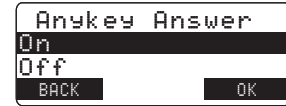

Using your Phone

	From the base speakerphone	From a cordless handset	From a handset speakerphone
Making a call	1) Press [*0] . 2) Listen for the dial tone. 3) Dial the number. OR 1) Dial the Number. 2) Press [*0] .	1) Remove the handset from the charging cradle. 2) Press [*/flash] . 3) Listen for the dial tone. 4) Dial the number. OR 1) Remove the handset from the charging cradle. 2) Dial the number. 3) Press [*/flash] .	1) Remove the handset from the charging cradle. 2) Press [*0] . 3) Listen for the dial tone. 4) Dial the number. OR 1) Remove the handset from the charging cradle. 2) Dial the number. 3) Press [*0] .
Answering a call	1) Press [*0] .	1) Pick up the handset. (If AutoTalk is on, the phone will answer when you remove the handset from the charging cradle.) 2) Press [*/flash] . (If Any Key Answer is on, you can also press any number keypad.)	1) Pick up the handset. 2) Press [*0] .
Hanging up	1) Press [*0] .	1) Press [*] .	1) Press [*] .

Making a call from the Phonebook

- 1) When the phone is in standby, press **[M]** to open the phonebook.
- 2) Scroll through the list with the **[▲]** or **[▼]** on the four-way function keys until you find the phonebook entry you want to call. (See Finding a Phonebook Entry on page 29).
- 3) Press **[*/flash]** or **[*☎]** on the handset or **[*☎]** on the base to dial the number.

Or

- 1) Press **[*/flash]** or **[*☎]** on the handset or **[*☎]** on the base.
- 2) Press **[M]** to open the phonebook.
- 3) Scroll through the list with the **[▲]** or **[▼]** on the four-way function keys until you find the phonebook entry you want to call. (See Finding a Phonebook Entry on page 29).
- 4) Press the **DIAL** soft key to dial the number.

Chain Dialing from the Phonebook

You can use the phonebook entries to store a group of numbers (up to 20 digits) that you may need to enter once your call connects. Once the call has connected you will then do the following.

- 1) Press **[M]**.
- 2) Use **[▲]** and **[▼]** to select the phonebook entry you want to dial.
- 3) Press the **DIAL** soft key.

Making a call with Speed Dial

- 1) When the phone is in standby, press and hold the number key **[0]-[9]** until the assigned phonebook entry appears in the display.
- 2) Press **[*/flash]** or **[*☎]** on the handset or **[*☎]** on the base to dial the number.

Switching to the Handset Speakerphone during a Call

To switch a normal call to the speakerphone, press **[*☎]** on the handset. To switch from a speakerphone call to a normal call, press **[*☎]**.

Using Caller ID, Call Waiting and Redial Lists

If you subscribe to Caller ID from your phone company, your phone will show you the caller's phone number and name (if available) whenever a call comes in. If you subscribe to both Call Waiting and Caller ID, the phone also shows you the name and the number of any call that comes in while you are on the line.

Note:

- If you answer a call before the Caller ID message is received (for example, before the second ring), the Caller ID message may not appear.
- When the call is received via a Telephone Company that does not offer Caller ID service, the caller's phone number and name will not appear. (This includes some international calls.)
- When the Call is from a PBX (private branch exchange), the caller's phone number and name may not appear.

Using the Caller ID List

You can store up to 100 Caller ID numbers in each station. Your phone shares up to 100 memory entries between your Phonebook and Caller ID. When the shared memory is full and when you store a new phonebook entry, the oldest Caller ID message is overwritten. Once you reach your maximum phonebook entries of 100, Caller ID information will not be stored (but it will still display when the call comes in).

To open the Caller ID list, press **[F10]** (on the right side of the four-way key). The phone will show the total number of stored Caller ID records. Use **[▲]** or **[▼]** to scroll through the list, or enter a letter on the keypad to jump to the first caller ID name that starts with that letter. To scroll quickly through the list, press and hold **[▲]** or **[▼]** on the four-way function key.

Note: The number of calls from the same Caller ID will appear next to the time to indicate that this is an unread message. Once you view the new message, the number will disappear.

Making a call from a Caller ID Record

- 1) When the phone is in standby, press **[CID]** (on the right side of the four-way key) to open the Caller ID list.
- 2) Use **[▲]** or **[▼]** to find the Caller ID record you want to dial.
- 3) Press **[/flash]** or **[*0]** on the handset or **[*0]** on the base to dial the number.

Or

- 1) Press **[/flash]** or **[*0]** on the handset or **[*0]** on the base.
- 2) Press **[CID]** to open the Caller ID list.
- 3) Use **[▲]** or **[▼]** to find the Caller ID you want to dial.
- 4) Press the **DIAL** soft key to dial the number.

Deleting Caller ID Numbers

To delete only one Caller ID number, go to the Caller ID list and select the number you want to delete. Press the **DELETE** soft key. When the phone asks you to confirm, select YES.

To delete all the Caller ID numbers, go to the Caller ID list and press the **DELETE** soft key. Select YES when asked if you want to DELETE ALL.

Note: When you delete a Caller ID number, you delete it permanently.

Using Call Waiting

If you have Call Waiting service and a second call comes in when you are on the phone, a call waiting tone will sound. (If you subscribe to Caller ID on Call Waiting, the handset displays the name and phone number of the waiting call.)

For Australian Model:

Press **[*/flash]** and then **[2]** on the handset to accept the waiting call. The first caller is put on hold, and you will hear the new caller after a short pause. To return to the original caller, press **[*/flash]** and then **[2]** again.

For New Zealand Model:

Press **[*/flash]** on the handset to accept the waiting call. The first caller is put on hold, and you will hear the new caller after a short pause. To return to the original caller, press **[*/flash]** again.

Note: You must subscribe through your telephone provider to receive Call Waiting services.

Redialing a Number

You can quickly redial the last 3 numbers dialed on each station.

- 1) With the phone in standby, press the **REDIAL** soft key to open the redial list.
- 2) Use [**▲**] or [**▼**] to scroll through the redial list.
- 3) When you find the number you want to dial, press [**/flash**] or [**⏏**] on the handset or [**⏏**] on the base to dial the number.

Note:

- If the number exceeds 32 digits, only the first 32 digits are retained in redial memory.
- If the redial memory is empty, you will hear a beep.

Deleting a Redial Record (Handset only)

If you want to delete a phone number from the redial list, follow the steps below:

- 1) With the phone in standby, press the **REDIAL** soft key.
- 2) Use [**▲**] or [**▼**] to scroll through the redial list.
- 3) When you find the redial number you want to delete, press the **DELETE** soft key.
- 4) Select YES, and press the **OK** soft key. The redialed number is deleted.

Adjusting the Ringer, Earpiece and Speaker Volume

Adjusting the Ringer Volume

You can choose from three ringer volume settings on the handset and the base (off, low, high). With the phone in standby, use [▲] or [▼] on the four-way function key to adjust the ringer volume.

Adjusting the Speaker Volume

Ear speaker: You can choose from six volume levels for the earpiece speaker. To adjust the earpiece volume while on a call, press [▲] (to make it louder) or [▼] (to make it softer).

Speaker: You can choose from six volume levels for the handset speakerphone and ten volume levels for the base speakerphone. To adjust the speaker volume while on a call, press [▲] (to make it louder) or [▼] (to make it softer).

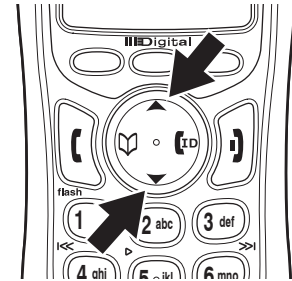

T-coil (Handset only)

Digital spread spectrum cordless phones generate magnetic signals that could cause noise to be heard by users wearing hearing aids set to "T" mode. (The "T" mode is only found on hearing aids equipped with a telecoil ("T" coil) feature). This phone includes a special "T-coil" mode that, when activated, reduces the magnetic noise generated by the handset.

To activate the "T-coil" mode perform the following steps on your handset:

While on a call:

- 1) Press and hold [**mute**] for at least 5 seconds or until a beep tone is heard.
- 2) The "T-coil" mode icon  will appear on the handset LCD display.

The handset will remain in "T-coil" mode for all future calls or until the "T-coil" mode is turned off.

To turn off the "T-coil" mode perform the following steps on your handset:

While on a call:

- 1) Press and hold [**mute**] for at least 5 seconds or until a beep tone is heard.

- 2) The “T-coil” mode icon will no longer appear on the handset LCD display.

Note: Using the T-coil mode may shorten the amount of time you can talk on your handset between battery charges. Therefore it is recommended that the handset be returned to the charging cradle when not in use. If this feature is not required, the “T-coil” mode should not be turned on.

Finding a Lost Handset

To locate a misplaced handset, press **[flash/find handset]** on the base when the phone is in standby. All registered handsets will beep for 60 seconds, and PAGING appears on the handset display. To cancel paging, press **[flash/find handset]** on the base.

Note: If the battery pack is completely drained, the handset will not beep when paging.

Using Hold, Conference and Transfer

Placing a Call on Hold

- 1) During a call, press **[int'com/hold]** on the station to place the caller on hold. If you leave a caller on hold for more than ten seconds, the display screen will read, LINE ON HOLD.
- 2) To return to the party on hold, press **[/flash]** or **[*4#]** on a handset or **[*4#]** on the base. The phone will return to the holding party.

Note:

- You can only place a caller on hold for 5 minutes. Once 5 minutes has passed, that party's line will be disconnected and the phone will return to standby.
- While a call is on hold, Caller ID and Call Waiting cannot be received.

Conferencing

If you have more than one handset, up to four people can participate in a conference call. A four-way conference call consists of an outside line, two handsets, and the base speakerphone. You can easily join a call already in progress.

- 1) Press **[/flash]** or **[*4#]** on the handset or **[*4#]** on the base to join the call.
- 2) To hang up, return the handset to the cradle or press **[#]** on the handset or **[*4#]** on the base. The other party will still be connected to the call.

Transferring a Call

You can transfer a call from one station to another.

- 1) During a call, press **[int'com/hold]**.
- 2) Use **[▲]** or **[▼]** to select the station you want to transfer the call to, then press the **OK** soft key.
The call will automatically be placed on hold, and a paging tone sounds. To cancel the transfer, press **[/flash]** or **[⏏]** on the initiating handset or **[⏏]** on the base.
- 3) When another station accepts the transferred call, your call will be disconnected.
If you want to rejoin the call, press **[/flash]** or **[⏏]** on the handset or **[⏏]** on the base.

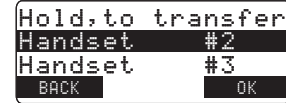

Answering a Transferred Call

When a station receives a call transfer, it sounds a paging tone and shows the ID of the station that is paging. To accept the call transfer:

- 1) Press **[/flash]**, **[int'com/hold]**, or the **ANSWER** soft key from the handset (or **[int'com/hold]**, **[⏏]**) or the **ANSWER** soft key on the base).
- 2) To speak to the caller, press **[/flash]** on the receiving handset or **[⏏]** on the base.

If you have multiple handsets, only the first handset to answer the transfer page will be connected to the call. If the transfer page is not picked up within one minute, the operation will be canceled.

Using Special Features

Do Not Disturb (All calls)

DND allows you to mute the ringer of all registered handsets and the base. With the phone in standby, press and hold **[dnd]** on the base. You will hear a confirmation tone and the **[dnd]** LED illuminates. To cancel, press **[dnd]** again. You can also mute the ringer tone while the phone is ringing by pressing **[dnd]** on the base.

Note: If the answering machine is off, it will automatically turn on when you activate DND. If you turn the answering machine off while DND is on, DND automatically turns off along with the answering machine.

Muting the Ringer (One call only)

While the phone is ringing, press the **MUTE** soft key on the handset or **[P/□]** on the base to mute the ringer for this call. The phone will ring again normally on the next call. (The handset must be off the cradle to mute the ringer.)

Muting the Microphone

Mute turns off the microphone so the caller cannot hear you. The display shows the MUTE ON icon while the microphone is muted.

From the handset

- 1) While you are on a call, press the **MUTE** soft key or **[mute]**.
- 2) MUTE ON will appear in the display for 2 seconds, but the  icon will appear and remain in the display until the feature is turned off.
- 3) To cancel muting, press the **MUTE** soft key or **[mute]**. MUTE OFF appears.

From the base

- 1) While you are on a call, press the **MUTE** soft key.
- 2) To cancel muting, press the **MUTE** soft key again.

Privacy Mode

If you don't want another station to interrupt you while on a call, you can turn on privacy mode. As long as your station is in privacy mode, other stations won't be able to join your call or make any calls of their own.

- 1) While on a call, press the **MENU** soft key. Select the PRIVACY MODE submenu.
- 2) PRIVACY MODE ON will appear in the display for 2 seconds, but the  icon will appear and remain in the display until the feature is turned off. Other stations will not be able to make a call and their display will list SYSTEM BUSY PLEASE TRY LATER.

To turn Privacy off, repeat above steps. PRIVACY MODE OFF appears.

Using the DirectLink Feature

A pair of handsets (or two pairs of handsets at one time) can function as two-way radios. This feature is called DirectLink and will not interfere with the base's ability to make or receive telephone calls while in use. To activate, you must set both handsets to the DirectLink feature. While using this feature, these two handsets will not be able to make or receive normal phone calls until this operation is canceled; however, other handsets will function normally.

Note:

- If the party is out of range, OUT OF RANGE appears in the display and the operation will be canceled.
 - The Speaker mode will be unavailable while in DirectLink mode.
- 1) Press the **MENU** soft key. Select DIRECTLINK MODE menu.
 - 2) Press the **OK** soft key. The display shows TO ENTER DIRECTLINK MODE PRESS [ENTER].
 - 3) Press the **ENTER** soft key. You will hear a confirmation tone, and DIRECTLINK MODE COMPLETE appears in the display.

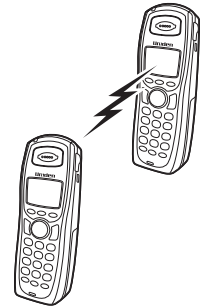

To enter DirectLink mode press [ENTER]	
BACK	ENTER

Making a DirectLink Call

- 1) To call another handset with DirectLink, press the **DirectLink** soft key.
- 2) Select the handset you want to call by pressing the number key (**0-9**). If the handset is out of range or not in DirectLink operation, the display shows OUT OF RANGE.
To exit DirectLink, press the **CANCEL** soft key.
- 3) On the receiving handset, press the **ANSWER** soft key or **[/flash]**.

Exiting a DirectLink Call

To exit the DirectLink feature and return to standby, press the **CANCEL** soft key and then press the **OK** soft key. DIRECTLINK MODE CANCEL appears in the display.

Intercom

Making an Intercom Page

You can use the intercom to talk to another station without using the phone line.

- 1) With the phone in standby, press **[int'com/hold]**.
- 2) Use **[▲]** or **[▼]** to select the station you want to talk with, and then press the **OK** soft key. If you select ALL, all other registered handsets and base will be paged. An intercom tone sounds. To cancel intercom, press **[*]** or the **CANCEL** soft key on either handset (or **[int'com/hold]** or the **CANCEL** soft key on the base).

Answering an Intercom Page

When the intercom page tone sounds, the display will show the ID of the station that is paging.

- 1) Press **[[/flash]**, **[int'com/hold]**, or the **ANSWER** soft key on the handset (or **[int'com/hold]**, **[*<]**), or the **ANSWER** softkey on the base). Or press a number key, **[*tone/<]**, or **[#/>]** (when Any Key Answer is enabled), or pick up the handset from the cradle (when AutoTalk is on).
- 2) To hang up an intercom page, press the **END** soft key or **[#]** on either handset (or **[int'com/hold]** on the base).

Note:

- If the party is busy, the handset returns to standby.
- If the party is out of range, UNAVAILABLE appears in the display and the operation will be canceled.
- If you receive an outside or intercom call or page while selecting the other handset, the operation is canceled.
- If you do not select a handset within 30 seconds, the operation will be canceled.
- If the party does not answer within one minute, the operation is canceled.



Room Monitor

This feature allows you to monitor sounds in another room. Place a station in the room you wish to monitor; it will function as a microphone. Another station can be set to function as a remote speaker, allowing you to monitor sounds in the room.

- 1) Press the **MENU** soft key and enter ROOM MONITOR menu. TO ROOM MONITOR appears.
- 2) Select the handset or base you want to monitor by using **[▲]** or **[▼]**.
- 3) Press the **OK** soft key. ROOM MONITOR appears on the handset, and you hear sounds in the room where the handset or base is installed.
- 4) To turn off the Room Monitor, press the **END** soft key or **[#]** on either handset or return the handset to the cradle.



Note:

- Warning! The Room monitor function is not a replacement for regularly checking the safety and security of children. The operating time is limited to the remaining charge of the battery and is not suitable for continuous overnight use.
- This telephone system is not intended to replace an AC powered room monitoring system. The length of time that a handset can monitor a room is limited to the talk time remaining on the handset battery (5 hours or less). For more information, see “Talk and Standby Times” on page 67.
- This feature only works when both handsets are within range of the base.
- If the party is out of range, UNAVAILABLE appears in the display and the operation will be canceled.
- While a pair of handsets is in Room Monitoring mode, only the Handsets in monitoring mode can receive incoming calls. To resume normal telephone operation, you should terminate the monitoring session by pressing the **END** soft key on either handset.

Tone Dialing Switch Over

If your telephone company requires pulse dialing, you can switch to tone dialing after the call connects. This feature is useful when you need tone dialing to use automated menu systems, such as telephone bank tellers, telephone prescription refills, customer support menus, etc. If your phone is set to pulse dialing, make your call normally. Once your call connects, press [***tone/←**] on the handset. Any digits you enter from then on will be sent as tone dialing. When this call ends, the phone automatically returns to pulse dialing.

Installing the Optional Headset

Your phone may be used with an optional headset. To use this feature, insert the headset plug into the headset jack. Your phone is ready for hands-free conversations. Headsets may be purchased by calling the Uniden Parts Department. See back cover page for contact information.

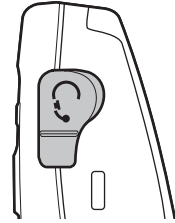

Setting Up the Answering Machine

Your phone has a built-in answering machine that answers and records incoming calls. You can also use your answering machine to record a conversation or leave a voice memo.

Features

- Digital Tapeless Recording
- Up to 12 Minutes of Recording Time
- Call Screening
- Personal or Pre-recorded Outgoing Messages
- Day and Time Announcement
- Remote Message Retrieval
- Toll Saver
- Conversation Recording
- Voice Memo
- Message Alert
- Hands Free Speakerphone at Base
- Records Up to 59 messages

Digital Tapeless Recording allows you to quickly review, save, or delete the messages you choose. You will never have to worry about a tape wearing out, jamming, or resetting improperly.

Using the Answering Machine Interface

Using Handset and Base Menus

You can set up your answering machine's primary features from the base or handset. The menu options of the base have voice prompt.

When the phone is in standby, press the **MENU** soft key and then scroll down and select **ANSW. SETUP**. Press the **OK** soft key. Use **[▲]** or **[▼]** to scroll through the answering machine setup menu options. Select the option by pressing the **OK** soft key.

To exit the menu and return to standby, press **[*]** on the handset and **[>/□/exit]** on the base.

Handset operation

You can use your handset to operate your answering machine from anywhere in your home. When the phone is in standby, press the **☒** soft key on the handset to access the answering machine. **REMOTE ANSWERING MACHINE OPERATION** appears on the handset display, and the answering machine announces the time, and number of new and old messages. Keep the following things in mind when you use your handset to access your answering machine:

- You can enter a command at any time during the announcements.
- After the first announcement, you have 30 seconds to enter your first command before the answering machine returns to standby.
- If you receive a call, the remote operation is cancelled.
- During the remote operation **REMOTE ANSWERING MACHINE OPERATION** appears on the base.

Your Greeting

Your answering machine comes with a pre-recorded outgoing message or greeting that plays when you receive a call:

"Hello, no one is available to take your call. Please leave a message after the tone."

Or you can record your own personal outgoing greeting. Your recorded greeting must be between 2 seconds and 30 seconds long. Once you have recorded a personal greeting, you can switch back and forth between the pre-recorded greeting and your own greeting.

	From the base	From the handset
To record a personal greeting	<ol style="list-style-type: none">1) Press the MENU soft key. Select the ANSW. SETUP menu option, then the RECORD GREETING submenu and press the OK soft key.2) Press the START soft key.3) The answering machine announces, "Record Greeting", begin recording after the announcement.4) The message counter on the base displays "30", and then begins to count down.5) When you finish recording, press the STOP soft key, [▶/□ /exit]. You will hear a beep, and the answering machine plays back your greeting for confirmation.	<ol style="list-style-type: none">1) With the phone in standby, press the ☒ soft key. REMOTE ANSWERING MACHINE OPERATION appears on the display. The answering machine announces the time, and the number of new and old messages.2) Press [8].3) The machine announces, "Record greeting", begin recording after the announcement.4) When you finish recording, press the STOP soft key or [5]. You will hear a beep, and the answering machine plays back your greeting for confirmation.

Selecting a Greeting (Base only)

Once you have recorded a personal greeting, the phone automatically switches to your personal greeting. You can also switch back and forth between the pre-recorded greeting and your own greeting at any time.

- 1) With the phone in standby, press the **MENU** soft key. Select ANSW. SETUP menu option, then the SELECT GREETING submenu and press the **OK** soft key. The answering machine plays the current greeting.
- 2) To keep this greeting, do nothing.
- 3) To switch to the other greeting, press the **CHANGE** soft key while the answering machine is playing the current greeting.
- 4) Each time you press the **CHANGE** soft key, the answering machine switches between the pre-recorded and the personal greeting. The last greeting you hear is used as the current greeting.

Deleting your Personal Greeting (Base only)

You can delete your personal greeting from the base. You cannot delete the pre-recorded greeting.

- 1) When the phone is in standby, press the **MENU** soft key. Select ANSW. SETUP menu option, then the SELECT GREETING submenu and press the **OK** soft key. The answering machine plays the current greeting.
- 2) While the personal greeting is playing, press the **DELETE** soft key.
- 3) The answering machine announces "Greeting has been deleted" and automatically switches back to the pre-recorded greeting.

Setting the Number of Rings

The ring time setting allows you to set the number of rings the caller hears before your answering machine plays the outgoing message. You can set the ring time to answer after six, nine, or twelve rings. If you enable the Toll Saver (TS setting), the answering machine picks up after two rings if you have new messages, and after four rings if there are none. This way, if you make a long distance call to check your messages, you can hang up after the third ring to avoid long distance billing charges.

- 1) Press the **MENU** soft key. Select the ANSW. SETUP menu, and then the RING TIME submenu.
- 2) Move the cursor to select a Ring Time (6 TIMES, 9 TIMES , 12 TIMES or TOLL SAVER).
- 3) Press the **OK** soft key. You will hear a confirmation tone.

Setting the Record Time (or Announce only)

You can choose how long callers have to record a message. Set the record time to 1 MINUTE or 4 MINUTES to limit the record time for incoming messages. If you set the record time to ANNOUNCE ONLY, the answering machine answers the call but prevents callers from leaving a message.

- 1) Press the **MENU** soft key. Select the ANSW. SETUP menu, and then the RECORD TIME submenu.
- 2) Move the cursor to select Record Time (1 MINUTE, 4 MINUTES, or ANNOUNCE ONLY).
- 3) Press the **OK** soft key. You will hear a confirmation tone.

While your answering machine is set to ANNOUNCE ONLY, the base screen will display ANNOUNCE ONLY. If you are using the prerecorded greeting, the answering machine automatically switches to the following message: "Hello, no one is available to take your call. Please call again." If you are using a personal greeting, the answering machine continues to use that greeting.

Activating the Message Alert

The Message Alert feature sounds a short alert tone every 15 seconds whenever you have a new message. To turn on the message alert:

- 1) Press the **MENU** soft key. Select the ANSW. SETUP menu, and then the MESSAGE ALERT submenu.
- 2) Move the cursor to select ON or OFF.
- 3) Press the **OK** soft key. You will hear a confirmation tone.

Activating Call Screening

Your phone allows you to listen to callers leaving you a message. This Call Screen feature can be turned on or off.

- 1) Press the **MENU** soft key. Select the ANSW. SETUP menu and then the CALL SCREEN submenu.
- 2) Move the cursor to select ON or OFF.
- 3) Press the **OK** soft. You will hear a confirmation tone.

Setting a Security Code or Personal Identification Number (PIN)

To play your messages from a remote location, you will need to enter a two-digit Personal Identification Number (PIN) or PIN Code.

- 1) Press the **MENU** soft key. Select the ANSW. SETUP menu, and then the SECURITY CODE submenu.
- 2) Enter a two-digit security code (00-99) using the number keypad **[0-9]**.
- 3) Press the **OK** soft. You will hear a confirmation tone.



Using the Answering Machine

The message counter on the LCD displays the number of messages stored in memory. If the display flashes, then there are new messages waiting for you that you have not yet listened to. The answering machine plays your new messages first. After you listen to all of your new messages, you can then play your old messages.

Note: Time stamp will not be heard until you have set the time.

Turning your Answering Machine On and Off

	From the base	From the handset
Turning On	<ol style="list-style-type: none">1) With the phone in standby, press [∅].2) The answering machine announces "Answering System is on" and plays the current greeting.3) The message counter displays the number of messages stored in memory. If the counter flashes, then you have new messages waiting.	<ol style="list-style-type: none">1) With the phone in standby, press the  soft key on the handset. REMOTE ANSWERINGMACHINE OPERATION appears on the handset display, and the answering machine announces the time, and the number of new and old messages.2) Press [6] at any time during the announcement.3) The answering machine announces "Answering System is on" and plays the current greeting message.

	From the base	From the handset
Turning Off	<ol style="list-style-type: none"> 1) With the phone in standby, press [∅]. 2) The phone announces "Answering System is off." 3)  appears. 	<ol style="list-style-type: none"> 1) With the phone in standby, press the  soft key on the handset. REMOTE ANSWERING MACHINE OPERATION appears on the handset display, and the answering machine announces the time, and the number of new and old messages. 2) Press [9] at any time during the announcement. The answering machine announces "Answering System is off."

Reviewing Messages

When you have a new message, the new message LED on the handset blinks. The LED stops blinking when you listen to all of your new messages. The answering machine will play your new messages first. After you play all of your new messages, you can then play your old messages.

You can review your messages from the base or from the handset:

	From the base	From the handset
Playing your messages	Press [▶/∅/exit]. The answering machine announces the number of new and old messages. It announces the message number, plays the message, and then announces the time and date that message was received.	Press the  soft key. REMOTE ANSWERING MACHINE OPERATION appears on the handset display, and the answering machine announces the time, and the number of new and old messages. Press [▶/2] to play your messages. After playing the message, the answering machine announces the time and date that message was received.

	From the base	From the handset
Repeating a message	Press [⏮] or the ⏮ soft key once to go to the beginning of the current message. Press [⏮] or the ⏮ soft key repeatedly to go back to a previous message. Press and hold to rewind through the current message.	Press [⏮/1] once to go to the beginning of the current message. Press [⏮/1] repeatedly to go back to a previous message.
Skipping a message	Press [⏭] or the ⏭ soft key to go to the beginning of the next message. Press and hold to fast forward through the current message.	Press [⏭/3] to go to the beginning of the next message.
Deleting a message	While a message is playing, press [⏻] or the DELETE soft key to delete it. The message is permanently deleted.	While a message is playing, press [⏻/4] to delete it. The message is permanently deleted.
Deleting all messages	With the phone in standby, press [⏻] to delete all messages. When the answering machine asks you to confirm, press [⏻] again. All messages are permanently deleted.	Not available
Stopping a message review	Press [⏻/exit] to stop a message playback and return to standby.	Press [⏻/5] or the STOP soft key to stop a message playback. Press [⏻] to exit the answering machine and return to standby.

Note:

- You cannot delete unheard messages. If you try to delete messages before listening to them, the answering machine will beep and say "Please playback all messages."
- If you press **[⏮]** or the **⏮** soft key on the base during the first two seconds (or press **[⏮/1]** on the handset during the first four seconds) of a message, the answering machine goes back to the previous message.

Screening Calls

Your phone allows you to listen to callers leaving a message without answering the phone. You can always hear callers from the base speaker. To screen an incoming call from the handset and base:

From the base	From the handset
<ol style="list-style-type: none">1) After the answering machine answers, the base speaker will let you hear the calls at the machine records the messages.2) To answer the call, press [☎].3) To mute the call screen, press the MUTE soft key, or [⏏/exit]. To cancel muting, press the SCREEN soft key.	<ol style="list-style-type: none">1) Press the SCREEN soft key when the answering machine is answering. If another station is screening a call, you will hear a beep and you will not be able to screen the call.2) To answer the call, press [/flash].3) To mute the call screen, press the MUTE soft key. To cancel muting press the SCREEN soft key.

Recording a Conversation

You can record a conversation between 2 seconds and 10 minutes long from the handset or the base. These recorded conversations are treated just like regular messages. When the answering machine is full,  will appear on the base LCD and recording will be terminated. You can not record intercom conversations with this feature.

	From the base	From the handset
Starting a recording	<ol style="list-style-type: none"> 1) During a conversation, press the MENU soft key then select CALL RECORD. Press the OK soft key. 2) The LCD will display RECORDING A CALL. A confirmation tone that can be heard by both parties sounds during recording. 	<ol style="list-style-type: none"> 1) During a conversation, press the MENU soft key, and then [▼] or [▲] key to select CALL RECORD. Press the OK soft key. 2) RECORDING A CALL appears on the display. A confirmation tone that can be heard by both parties sounds during recording.
Stopping a recording	<ol style="list-style-type: none"> 1) Press the MENU soft key then select CALL RECORD. Press the OK soft key. 2) The LCD will display STOP RECORDING. You will hear a confirmation tone. 	<ol style="list-style-type: none"> 1) Press the MENU soft key, and then [▼] or [▲] key to select CALL RECORD. Press the OK soft key. 2) STOP RECORDING appears on the display, and you will hear a confirmation tone.

Note:

- Every state has different regulations governing the recording of conversations over the telephone. Make sure to check your local, state and federal laws before using this product to record any telephone conversation in order to determine that your use is in compliance with such laws or guidelines.
- If the recording memory is full, UNAVAILABLE appears in the display. You cannot record a conversation until you clear some messages from the memory.

Recording a Voice Memo

The voice memo feature allows you to record messages that are between 2 seconds and 4 minutes long. You might want to use this feature to leave messages for other members of your household instead of written notes.

	From the base	From the handset
Starting a memo	<ol style="list-style-type: none">1) With the phone in standby, press the RECORD soft key, and then the START soft key.2) The answering machine announces "Record memo message." Begin your message after this announcement and a beep.	<ol style="list-style-type: none">1) With the phone in standby, press the  soft key.2) REMOTE ANSWERING MACHINE OPERATION appears on the display, and the answering machine announces the time, and the number of new and old messages.3) Press [7]. The answering machine announces "Record memo message." Begin your message after this announcement.
Stopping a memo	<ol style="list-style-type: none">1) Press the STOP soft key.2) You hear a confirmation tone, and the answering machine returns to standby.	<ol style="list-style-type: none">1) Press [7].2) You hear a confirmation tone, and the answering machine waits for your next command.3) Press [▶/2] to hear the message you just recorded or [9] to exit and return to standby.

Message Alert

The Message Alert feature sounds a short alert tone whenever you have a new message. When a new message is received and Message Alert is on, the alert tone will sound every 15 seconds. Set the Message Alert to on or off by using **MENU**. To activate the message alert, see page 55 for details.

When all new messages are played back (see page 57), the Message Alert tone will automatically deactivate. The tone will not deactivate until all new messages are played back. To quickly turn off the Message Alert tone, press any key on the base.

Remotely Operating Your Answering Machine

You can access your answering machine while you are away from home to check, play, delete messages, or even record a new greeting message or to turn your answering machine on and off.

Note:

- The answering machine will only playback messages for four minutes and then it returns to the command-waiting mode. To continue playing your messages, press **[#]** then **[2]** again within 15 seconds.
- If you enter an incorrect security code three times, you will hear a beep and the answering machine will return to standby.

To operate from a remote location, use any touch-tone telephone and follow these steps:

- 1) Call your telephone number and wait for the answering machine to answer. If the answering machine is off, it will answer after about 15 rings and series of beeping sounds.
- 2) During the greeting message (or a series of beeps when the answering machine is off), press **[#]** and enter your PIN code within 2 seconds (see "Setting a Security Code or Personal Identification Number (PIN)" on page 55).
- 3) The answering machine announces the current time and the number of messages stored in memory. You hear "To play incoming messages, press pound-two. For help, press pound-zero." You will hear a beep.
- 4) Enter a remote command within 15 seconds, each command there after must be entered within 2 seconds. You may select a command from the following chart:

Remote Commands

Command	Function	Command	Function
# then 1	Repeat a Message*	# then 6	Answering Machine On
# then 2	Playback Messages	# then 7	Memo Record/Stop**
# then 3	Skipping a Message	# then 8	Greeting Record/Stop**
# then 4	Deleting a Message	# then 9	Answer Machine Off
# then 5	Stop Operation	# then 0	Help Guidance

* To Repeat a Message, press [#] then [1] within four seconds to repeat the previous message, or press [#] then [1] after four seconds to repeat the current message.

** For the Memo Record and Greeting Record/Stop, the first time you enter the corresponding command, it starts the Recording. If you want to stop the recording, press [#] then [7], [8], or [5].

- 5) When you finish, you will hear intermittent beeps indicating that the answering machine is in the command waiting mode. You can enter another command from the chart, or you can hang up to exit the answering machine.
- 6) When you hang up, the answering machine automatically returns to its normal standby setting.



Battery Replacement and Handling

With average use, your phone's battery should last approximately one year. To order replacement batteries, please contact Uniden's Parts Department. The contact information is listed on the back cover page.

Cleaning the Battery Contacts

To maintain a good charge, clean the charging contacts on the handset once a month. Dampen a cloth with plain water. Gently rub the damp cloth over the charging contacts until all visible dirt is removed. Dry the contacts thoroughly before returning the handset to the charging cradle.

Caution: Do not use paint thinner, alcohol, or other chemical products. Doing so may discolor the surface of the telephone and damage the finish.

Warning

To avoid the risk of personal injury or property damage from fire or electrical shock, use only Uniden AAD-041S(M) or AAD-041S (9V 350mA) and AAD-600S(M) or AAD-600S AC adaptors and Uniden BT-446 or BT-750 battery pack with your phone.

Caution:

- Use only the specified Uniden battery pack BT-446 or BT-750.
- Do not remove the batteries from the handset to charge them.
- Never throw the battery into a fire, disassemble, or heat them.
- Do not remove or damage the battery casing.
- A replacement Uniden adaptor or battery may be purchased by calling Uniden's Parts department. See back cover page for contact information.

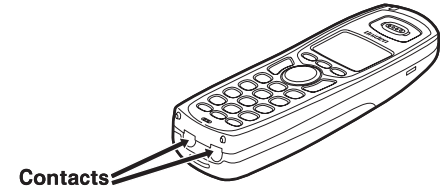

Low Battery Alert

When the battery pack is very low, the phone is programmed to eliminate functions in order to save power. When LOW BATTERY appears in the display and the phone is in standby, none of the keys will operate. If you are on a call, complete your conversation as quickly as possible, and return the handset to the charging cradle.

The battery pack needs to be charged when the empty battery icon appears.

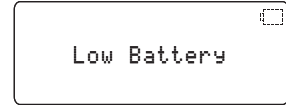

Talk and Standby Times

With average use, your handset battery provides approximately 5 hours of talk time and approximately 7 days of standby time. When your handsets are not being used and are left off of their charging cradles, the battery will gradually discharge. You can achieve optimum battery life and performance by returning the handset to the charging cradle after each use. If the handset is left off of the charging cradle, the actual talk time duration will be reduced respective to the amount of time the handset is off of the charging cradle.

Troubleshooting

Resetting the Handset

You may need to reset your handset in the following instances:

- You lose a handset and purchase a new one. When you try and register to your existing base you get registration failure.
- You are unable to register any handsets to the base.
- You had a base which needed to be exchanged by the manufacturer. When you register your existing handsets to the base, the handsets say #3 and #4, but you only have 2 handsets.
- When you are instructed to by the one of the manufacturer's call center representatives.

To reset:

Press and hold **[*]** and **[#>]** for more than 5 seconds.

You will hear a confirmation tone. The handset will clear its registration information from the base, and then delete its own base information.

PLACE HANDSET ON MAIN BASE TO REGISTER appears in the display. To re-register the handset to the base, place the handset in the base charging cradle.

If the handset cannot contact the base, it will display OUT OF RANGE. Make sure the handset is in range of the base and the base is connected to power.

Note: It is also possible to reset the handset back to its original factory settings. All changes including Caller ID information will be erased. After following these steps, if your cordless telephone does not work, please visit Uniden's customer support page at www.uniden.com.au (Australian model) or www.uniden.co.nz (New Zealand model).

Changing the Digital Security Code

The digital security code is an identification code used to connect the handset and the base. Your unit ships from the manufacturer with a preset security code. Resetting this code is not normally necessary. In the rare situation that you suspect another cordless telephone is using the same security code or if you are instructed to change this code by a manufacturer's Call Center Representative, you can change the code by:

1. Perform "Resetting the Handset" for all of your handsets by following the steps on page 26.
2. Re-register each handset by placing in the base charging cradle.

Traveling Out of Range

During a call, if you move your handset too far away from your base, noise may increase. If you pass the range limits of the base, you will hear a beep and see OUT OF RANGE on the display, and then the handset returns to standby.

Common Issues

If your phone is not performing to your expectations, please try these simple steps first. If these steps do not solve your problem, please call our Customer Hotline. See back cover page for contact information.

Symptom	Suggestion
The charge/in use LED won't illuminate when the handset is placed in the cradle.	<ul style="list-style-type: none">• Make sure the AC adaptor is plugged into the base or the charger (if you have more than one handset) and wall outlet.• Make sure the handset is properly seated in the cradle.• Make sure the charging contacts on the handset are clean.
The audio sounds weak.	<ul style="list-style-type: none">• Move the handset and/or base away from metal objects or appliances and try again.• Make sure that you are not too far from the base.

Symptom	Suggestion
Can't make or receive calls.	<ul style="list-style-type: none"> • Make sure that you are not too far from the base. • Make sure the line is not in use. If an outside call is already using a line, you cannot use that line to make another outside call. • Check both ends of the base telephone line cord. • Make sure the AC adaptor is plugged into the base and wall outlet. • Disconnect the AC adaptor and reconnect. • Change the Digital Security Code (see page 69).
The handset doesn't ring or receive a page.	<ul style="list-style-type: none"> • Make sure that you are not too far from the base. • Charge the battery in the handset for at least 15-20 hours by placing the handset on the base or charging cradle. • Change the Digital Security Code (see page 69).
Severe noise interference.	<ul style="list-style-type: none"> • Keep the handset away from microwave ovens, computers, remote control toys, wireless microphones, alarm systems, intercoms, room monitors, fluorescent lights, and electrical appliances. • Move to another location or turn off the source of interference.
The Caller ID does not display.	<ul style="list-style-type: none"> • The call was placed through a switchboard. • Call your telephone provider to verify your Caller ID service is current. There may be a problem with your Caller ID service.
You cannot register the handset at the base.	<ul style="list-style-type: none"> • Charge the battery pack in the handset for 15-20 hours. • Change the Digital Security Code (see page 69). • Make sure you have not stored 10 handsets already.
The handset doesn't communicate with other handsets.	<ul style="list-style-type: none"> • Change the Digital Security Code (see page 69). • Make sure that you have registered all handsets.

Symptom	Suggestion
An extra handset can't join the conversation.	<ul style="list-style-type: none"> • Make sure there are not 2 handsets already using the conference feature. • Make sure that another station is not in privacy mode.
The Room Monitor feature does not work.	<ul style="list-style-type: none"> • Make sure to place the handset(s) within the range of the base.
The answering machine does not work.	<ul style="list-style-type: none"> • Make sure the AC Adaptor is plugged in. • Make sure that the answering machine is turned on. • Make sure that the message record time is not set to Announce only (see page 54).
Messages are incomplete.	<ul style="list-style-type: none"> • The incoming messages may be too long. Remind callers to leave a brief message. • The memory may be full. Delete some or all of the saved messages.
There is no sound on the base or handset speaker during call monitoring or message playback.	<ul style="list-style-type: none"> • Adjust the speaker volume on the base or handset. • Make sure the call screen feature is set to on.
Cannot access remote features from another touchtone phone.	<ul style="list-style-type: none"> • Make sure you are using the correct PIN number. • Make sure that the touch-tone phone you are using can transmit the tone for at least two seconds. If it cannot, you may have to use another phone to access your phone.
Time stamp cannot be heard.	<ul style="list-style-type: none"> • Make sure you have set the time (see "Setting the Day and Time" on page 21).

Liquid Damage

Moisture and liquid can damage your cordless phone. Follow the suggestions below if your phone gets wet.

Exterior

If the handset or base is exposed to moisture or liquid, but only the exterior plastic housing is affected, wipe off the liquid, and use as normal.

Interior

If moisture or liquid has entered the plastic housing (i.e. liquid can be heard in the phone or liquid has entered the handset battery compartment or vent openings on the base):

Handset:

1. Remove the battery cover and leave it off for ventilation.
2. Disconnect the battery pack. Leave the battery cover off and the battery pack disconnected for at least 3 days.
3. Once the handset is completely dry, reconnect the battery pack and the battery cover.
4. Recharge the handset's battery pack for 15 to 20 hours before using.

IMPORTANT: You must unplug the telephone line while recharging the battery packs to avoid charge interruption.

Base:

1. Disconnect the AC adaptor from the base, cutting off electrical power.
2. Disconnect the telephone cord from the base.
3. Let dry for at least 3 days.

CAUTION: DO NOT use a microwave oven to speed up the drying process. This will cause permanent damage to the handset, base and the microwave oven. After following these steps, if your cordless telephone does not work, please call our Customer Service Hotline. See back cover page for contact information.



Precautions!

Before you read anything else, please observe the following:

Warning!

Uniden DOES NOT represent this unit to be waterproof. To reduce the risk of fire, electrical shock, or damage to the unit, DO NOT expose this unit to rain or moisture.

Rechargeable Nickel-Metal-Hydride Battery Warning

- This equipment contains a rechargeable Nickel-Metal-Hydride battery.
- The rechargeable batteries contained in this equipment may explode if disposed of in a fire.
- Do not short-circuit the battery.
- Do not charge the rechargeable battery used in this equipment in any charger other than the one specified in the owner's manual. Using another charger may damage the battery or cause the battery to explode.

Rechargeable Batteries Must Be Recycled or Disposed of Properly.





Uniden works to reduce lead content in our PVC coated cords in our products and accessories.

Important Safety Instructions

When using your telephone equipment, basic safety precautions should always be followed to reduce the risk of fire, electric shock and injury to persons, including the following:

1. Do not use this product near water, for example, near a bath tub, wash bowl, kitchen sink or laundry tub, in a wet basement or near a swimming pool.
2. Avoid using a telephone (other than a cordless type) during an electrical storm. There may be a remote risk of electric shock from lightning.
3. Do not use the telephone to report a gas leak in the vicinity of the leak.
4. Use only the power cord and batteries indicated in this manual. Do not dispose of batteries in a fire. They may explode. Check with local authorities for possible battery disposal instructions.
5. Do not disassemble any component of this product.

SAVE THESE INSTRUCTIONS

CAUTION



Risk of explosion if battery is replaced by an incorrect type. Dispose of used batteries according to the instructions. Do not open or mutilate the battery, and disconnect the battery before shipping this product.



Index

A

Adding Accessory Handsets.....	24
Animation screen.....	23
Answering a Call.....	35
Answering Machine	
Handset operation	51
Using the handset & base menu	51
When away from home.....	62
Any Key Answer	34
AutoTalk.....	34

B

Base Unavailable.....	69
Battery Contacts Maintenance	66
Battery Replacement and Handling	66

C

Caller ID on Call Waiting	21
Call screen.....	55, 59
Chain Dialing	36
Conferencing	42
Controls Parts of the Phone	7

D

Day and Time	21
Deleting a Redial Record.....	40
Deleting Caller ID Numbers.....	38
Deregistration	26
Dial Mode	20
Digital Security Code.....	69
DirectLink.....	45
Distinctive Ring.....	22
Do Not Disturb.....	44

E

Earpiece Volume	41
Entering Text from the Phone	13

G

Greetings	
Deleting.....	53
Recording	52
Selecting	53

H

Handset Banner.....	32
Hanging up	35

I

Important Safety Instructions.....	74
Installing the Belt Clip.....	19
Installing the Phone	14
Installing the Rechargeable Battery.....	17

K

Key Touch Tone	23
----------------------	----

L

LCD contrast.....	23
Liquid Damage	72
Low Battery Alert	67

M

Maintenance	65
Making a call.....	35
Making a call from a Caller ID Record.....	38
Making a call with Speed Dial.....	36
Muting the Microphone	44
Muting the Ringer	44

O

Optional Headset.....	49
Out of Range	69

P

Personal identification number (PIN).....	55
Phonebook	27
Placing a Call on Hold	42
Privacy Mode.....	45
Product Overview	6

R

Recording a call.....	60
Redialing a Number.....	40
Registering DSS7905 Accessory Handsets	25
Resetting the Handset.....	68
Ringer Tones	33
Ringer Volume	41
Room Monitor	47

S

Screening calls	55, 59
Security code Answering system.....	56
Speaker Volume	41
Speed Dial	36

T

T-coil.....	41
Talk and Standby Times	67

V

Voice Memo.....	61
-----------------	----

W

Wall Mounting the Base.....	15
-----------------------------	----

Memo

Memo

Memo

Remote Operation Card

<p style="text-align: center;">CUT</p> <p style="text-align: center;">REMOTE OPERATION CARD</p> <p style="text-align: right;">Unlden®</p> <hr/> <table border="0"><tr><td data-bbox="223 314 476 529"><p>Remote access away from home</p><ol style="list-style-type: none">1. Call your phone number from a touch-tone phone.2. During the outgoing message, press # and enter your PIN code. The answering machine announces the number of messages stored in memory and the voice prompts.3. To quit, hang up the phone.</td><td data-bbox="495 314 733 529"><p>Turn on the answering machine remotely</p><ol style="list-style-type: none">1. Call your phone and let it ring 15 times until you hear a beep.2. Press # and then enter your PIN code.3. Press # then 5 to stop the announcement.4. Press # then 6 to turn the answering machine on.</td></tr></table>	<p>Remote access away from home</p> <ol style="list-style-type: none">1. Call your phone number from a touch-tone phone.2. During the outgoing message, press # and enter your PIN code. The answering machine announces the number of messages stored in memory and the voice prompts.3. To quit, hang up the phone.	<p>Turn on the answering machine remotely</p> <ol style="list-style-type: none">1. Call your phone and let it ring 15 times until you hear a beep.2. Press # and then enter your PIN code.3. Press # then 5 to stop the announcement.4. Press # then 6 to turn the answering machine on.	<p style="text-align: center;">CUT</p> <p style="text-align: center;">REMOTE OPERATION CARD</p> <p style="text-align: right;">Unlden®</p> <hr/> <table border="0"><tr><td data-bbox="778 314 1031 529"><p>Remote access away from home</p><ol style="list-style-type: none">1. Call your phone number from a touch-tone phone.2. During the outgoing message, press # and enter your PIN code. The answering machine announces the number of messages stored in memory and the voice prompts.3. To quit, hang up the phone.</td><td data-bbox="1050 314 1288 529"><p>Turn on the answering machine remotely</p><ol style="list-style-type: none">1. Call your phone and let it ring 15 times until you hear a beep.2. Press # and then enter your PIN code.3. Press # then 5 to stop the announcement.4. Press # then 6 to turn the answering machine on.</td></tr></table>	<p>Remote access away from home</p> <ol style="list-style-type: none">1. Call your phone number from a touch-tone phone.2. During the outgoing message, press # and enter your PIN code. The answering machine announces the number of messages stored in memory and the voice prompts.3. To quit, hang up the phone.	<p>Turn on the answering machine remotely</p> <ol style="list-style-type: none">1. Call your phone and let it ring 15 times until you hear a beep.2. Press # and then enter your PIN code.3. Press # then 5 to stop the announcement.4. Press # then 6 to turn the answering machine on.
<p>Remote access away from home</p> <ol style="list-style-type: none">1. Call your phone number from a touch-tone phone.2. During the outgoing message, press # and enter your PIN code. The answering machine announces the number of messages stored in memory and the voice prompts.3. To quit, hang up the phone.	<p>Turn on the answering machine remotely</p> <ol style="list-style-type: none">1. Call your phone and let it ring 15 times until you hear a beep.2. Press # and then enter your PIN code.3. Press # then 5 to stop the announcement.4. Press # then 6 to turn the answering machine on.				
<p>Remote access away from home</p> <ol style="list-style-type: none">1. Call your phone number from a touch-tone phone.2. During the outgoing message, press # and enter your PIN code. The answering machine announces the number of messages stored in memory and the voice prompts.3. To quit, hang up the phone.	<p>Turn on the answering machine remotely</p> <ol style="list-style-type: none">1. Call your phone and let it ring 15 times until you hear a beep.2. Press # and then enter your PIN code.3. Press # then 5 to stop the announcement.4. Press # then 6 to turn the answering machine on.				
<p style="text-align: center;">CUT</p> <p style="text-align: center;">REMOTE OPERATION CARD</p> <p style="text-align: right;">Unlden®</p> <hr/> <table border="0"><tr><td data-bbox="223 685 476 900"><p>Remote access away from home</p><ol style="list-style-type: none">1. Call your phone number from a touch-tone phone.2. During the outgoing message, press # and enter your PIN code. The answering machine announces the number of messages stored in memory and the voice prompts.3. To quit, hang up the phone.</td><td data-bbox="495 685 733 900"><p>Turn on the answering machine remotely</p><ol style="list-style-type: none">1. Call your phone and let it ring 15 times until you hear a beep.2. Press # and then enter your PIN code.3. Press # then 5 to stop the announcement.4. Press # then 6 to turn the answering machine on.</td></tr></table>	<p>Remote access away from home</p> <ol style="list-style-type: none">1. Call your phone number from a touch-tone phone.2. During the outgoing message, press # and enter your PIN code. The answering machine announces the number of messages stored in memory and the voice prompts.3. To quit, hang up the phone.	<p>Turn on the answering machine remotely</p> <ol style="list-style-type: none">1. Call your phone and let it ring 15 times until you hear a beep.2. Press # and then enter your PIN code.3. Press # then 5 to stop the announcement.4. Press # then 6 to turn the answering machine on.	<p style="text-align: center;">CUT</p> <p style="text-align: center;">REMOTE OPERATION CARD</p> <p style="text-align: right;">Unlden®</p> <hr/> <table border="0"><tr><td data-bbox="778 685 1031 900"><p>Remote access away from home</p><ol style="list-style-type: none">1. Call your phone number from a touch-tone phone.2. During the outgoing message, press # and enter your PIN code. The answering machine announces the number of messages stored in memory and the voice prompts.3. To quit, hang up the phone.</td><td data-bbox="1050 685 1288 900"><p>Turn on the answering machine remotely</p><ol style="list-style-type: none">1. Call your phone and let it ring 15 times until you hear a beep.2. Press # and then enter your PIN code.3. Press # then 5 to stop the announcement.4. Press # then 6 to turn the answering machine on.</td></tr></table>	<p>Remote access away from home</p> <ol style="list-style-type: none">1. Call your phone number from a touch-tone phone.2. During the outgoing message, press # and enter your PIN code. The answering machine announces the number of messages stored in memory and the voice prompts.3. To quit, hang up the phone.	<p>Turn on the answering machine remotely</p> <ol style="list-style-type: none">1. Call your phone and let it ring 15 times until you hear a beep.2. Press # and then enter your PIN code.3. Press # then 5 to stop the announcement.4. Press # then 6 to turn the answering machine on.
<p>Remote access away from home</p> <ol style="list-style-type: none">1. Call your phone number from a touch-tone phone.2. During the outgoing message, press # and enter your PIN code. The answering machine announces the number of messages stored in memory and the voice prompts.3. To quit, hang up the phone.	<p>Turn on the answering machine remotely</p> <ol style="list-style-type: none">1. Call your phone and let it ring 15 times until you hear a beep.2. Press # and then enter your PIN code.3. Press # then 5 to stop the announcement.4. Press # then 6 to turn the answering machine on.				
<p>Remote access away from home</p> <ol style="list-style-type: none">1. Call your phone number from a touch-tone phone.2. During the outgoing message, press # and enter your PIN code. The answering machine announces the number of messages stored in memory and the voice prompts.3. To quit, hang up the phone.	<p>Turn on the answering machine remotely</p> <ol style="list-style-type: none">1. Call your phone and let it ring 15 times until you hear a beep.2. Press # and then enter your PIN code.3. Press # then 5 to stop the announcement.4. Press # then 6 to turn the answering machine on.				

CUT

Task	Key
Repeat a Message	# 1
Playing incoming Messages	# 2.abc
Skipping a Message	# 3.def
Deleting a Message	# 4.ghi
Stop Operation	# 5.jkl
Answering Machine On	# 6.mnop
Memo Record/Stop	# 7.pqrs
Greeting Message Record/Stop	# 8.tuvw
Answering Machine Off	# 9.xyz
Help	# 0.opqr

CUT

Task	Key
Repeat a Message	# 1
Playing incoming Messages	# 2.abc
Skipping a Message	# 3.def
Deleting a Message	# 4.ghi
Stop Operation	# 5.jkl
Answering Machine On	# 6.mnop
Memo Record/Stop	# 7.pqrs
Greeting Message Record/Stop	# 8.tuvw
Answering Machine Off	# 9.xyz
Help	# 0.opqr

CUT

Task	Key
Repeat a Message	# 1
Playing incoming Messages	# 2.abc
Skipping a Message	# 3.def
Deleting a Message	# 4.ghi
Stop Operation	# 5.jkl
Answering Machine On	# 6.mnop
Memo Record/Stop	# 7.pqrs
Greeting Message Record/Stop	# 8.tuvw
Answering Machine Off	# 9.xyz
Help	# 0.opqr

CUT

Task	Key
Repeat a Message	# 1
Playing incoming Messages	# 2.abc
Skipping a Message	# 3.def
Deleting a Message	# 4.ghi
Stop Operation	# 5.jkl
Answering Machine On	# 6.mnop
Memo Record/Stop	# 7.pqrs
Greeting Message Record/Stop	# 8.tuvw
Answering Machine Off	# 9.xyz
Help	# 0.opqr

One Year Limited Warranty

Important: Evidence of original purchase is required for warranty service.

Warrantor: Uniden Australia Pty Limited A.B.N. 58 001 865 498
Uniden New Zealand Limited **Warranty is only valid in the original country of purchase.**

ELEMENT OF WARRANTY: Uniden warrants to the original retail owner for the duration of this warranty, its DSS7955, DSS7955+1, DSS7955+2 (herein after referred to as the Product), to be free from defects in materials and craftsmanship with only the limitations or exclusions set out below.

WARRANTY DURATION: This warranty to the original retail owner only, shall terminate and be of no further effect ONE (1) year after the date of original retail sale. This warranty will be deemed invalid if the Product is;

- (A) Damaged or not maintained as reasonable and necessary,
- (B) Modified, altered or used as part of any conversion kits, subassemblies, or any configurations not sold by Uniden,
- (C) Improperly installed,
- (D) Repaired by someone other than an authorized Uniden Repair Agent for a defect or malfunction covered by this warranty,
- (E) Used in conjunction with any equipment or parts or as part of a system not manufactured by Uniden, or
- (F) Where the Serial Number label of the product has been removed or damaged beyond recognition.

Warranty only valid in the country of original retail/sale.

PARTS COVERED: This warranty covers for one (1) year, the Product and included accessories

STATEMENT OF REMEDY: In the event that the Product does not conform to this warranty at any time while this warranty is in effect, the warrantor at its discretion, will repair the defect or replace the Product and return it to you without charge for parts or service. This warranty does not provide for reimbursement or payment of incidental or consequential damages.

This EXPRESS WARRANTY is in addition to and does not in any way affect your rights under the TRADE PRACTICES ACT 1974 (Cth) (Australia) or the CONSUMER GUARANTEES ACT (New Zealand).

PROCEDURE FOR OBTAINING PERFORMANCE OR WARRANTY: In the event that the product does not conform to this warranty, the Product should be shipped or delivered, freight pre-paid, with evidence of original purchase (eg. a copy of the sales docket), to the warrantor at:

UNIDEN AUSTRALIA PTY LIMITED

SERVICE DIVISION
345 Princes Highway,
Rockdale,
NSW 2216,
AUSTRALIA
Fax: (02) 9599 3278
www.uniden.com.au

UNIDEN NEW ZEALAND LIMITED

SERVICE DIVISION
150 Harris Road,
East Tamaki,
Auckland,
NEW ZEALAND
Fax: (09) 274 4253
www.uniden.co.nz



Uniden®

©2007 Uniden Australia Pty Limited/Uniden New Zealand Limited
Part Code UPZZ01857BZ(0) Printed in China

Free Manuals Download Website

<http://myh66.com>

<http://usermanuals.us>

<http://www.somanuals.com>

<http://www.4manuals.cc>

<http://www.manual-lib.com>

<http://www.404manual.com>

<http://www.luxmanual.com>

<http://aubethermostatmanual.com>

Golf course search by state

<http://golfingnear.com>

Email search by domain

<http://emailbydomain.com>

Auto manuals search

<http://auto.somanuals.com>

TV manuals search

<http://tv.somanuals.com>