

Uniden®

DSS8955
DSS8955+1
DSS8955+2
DSS8955+3

OWNER'S MANUAL

Table of Contents

Welcome	4	Using the Interface	19
Installing the Phone	5	Reading the Display	19
Choosing the Best Location	5	Using the Four-way Function Key	20
Installing the Battery	6	Using the Menus	20
Connecting the AC adapter	7	Entering Text from Your Phone	21
To the base.....	7	Basic Setup	22
To the charging cradle (for multi-handset packs only)	7	Activating Personal Ring (Handset only)	22
Charging the Handset	8	Activating the Key Touch Tone	22
Connecting to the Phone Line	9	Name Tag	23
Testing the Connection	10	Insert 0	23
Installing the Belt Clip	11	Setting Up the Phonebook	24
Expanding Your Phone	12	Creating Phonebook Entries	24
Adding accessory handsets	12	Finding a Phonebook Entry	25
Registering accessory handsets	12	Editing an Existing Phonebook Entry	25
Wall Mounting the Base	13	Storing Caller ID or Redial Numbers in the Phonebook	26
Getting to Know Your New Phone	15	Deleting a Single Phonebook Entry	26
Features	15	Deleting all Phonebook Entries	26
Answering system features	15	Copying Phonebook Entries to Another Station	27
Terminology Used in this Manual	16	Customizing Your Handsets	28
Manual Conventions	16	Changing the Handset Banner	28
Parts of the Handset	17	Selecting a Ring Tone	28
Parts of the Base	18	Activating AutoTalk	29
		Activating Any Key Answer	29

Activate Handset Keypad Lock	29	Answering a transferred call.....	38
Using Your Phone.....	30	Using Special Features	39
Making a Call from the Phonebook.....	31	Privacy Mode.....	39
Chain dialing from the phonebook	31	Using the Intercom	39
Switching to the Handset Speakerphone		Making an intercom page.....	39
During a Call	31	Answering an intercom page.....	40
Using Caller ID, Call Waiting, and Redial Lists.....	32	Muting the Microphone	40
Using the Caller ID List	32	Installing the Optional Headset.....	41
Making a Call from a Caller ID Record.....	32	Setting Up the Answering System	42
Deleting Caller ID Numbers	33	Recording a Personal Greeting	42
Using Call Waiting	33	Selecting a Greeting	42
Redialing a Number	34	Deleting Your Personal Greeting.....	43
Deleting a Redial Record	34	Setting the Number of Rings	43
Adjusting the Ringer, Earpiece and		Setting the Day & Time.....	44
Speaker Volume.....	35	Setting the Record Time (or Announce only)....	44
Adjusting the Ringer Volume.....	35	Activating the Message Alert.....	45
Muting the Ringer (One call only)	35	Activating the Base Call Screen.....	45
Adjusting the Earpiece Volume	35	Using the Answering System	46
Adjusting the Speaker Volume	36	Turning Your Answering System On and Off	46
Adjusting the Audio Tone (Handset only)	36	Reviewing Messages	47
Finding a Lost Handset.....	37	Screening Calls.....	48
Using Hold, Conference and Transfer	37	Turning Off the Message Alert Tone.....	48
Placing a Call on Hold	37	Operating the Answering System	
Conferencing.....	37	While You Are Away from Home	48
Transferring a Call	38	Setting a security code or	
		Personal Identification Number (PIN).....	48

Dialing in to your answering system.....	48	Troubleshooting	52
Maintenance	50	Common Issues	52
Specifications	50	Resetting the Handset.....	54
Battery Information.....	50	Resetting the Handset Without the Base.....	55
Battery life	50	Changing the Handset to Base Code.....	56
Low battery alert	51	Changing the Line Mode for Multiple	
Cleaning the charging contacts.....	51	Extensions	56
Battery replacement and handling	51	Traveling Out of Range	56
Power Failures	51	Liquid Damage	57
		Precautions!	58
		Rechargeable Nickel-Metal-Hydride	
		Battery Warning	58
		Important Safety Instructions	58
		Index	62
		Remote Operation Card	64
		Warranty	66

Welcome

Thank you for purchasing a Uniden Multi-Handset phone.

Note: Illustrations in this manual are used for explanation purposes. Some illustrations in this manual may differ from the actual unit.



Installing the Phone

Choosing the Best Location

When choosing a location for your new phone, here are some important guidelines you should consider:

Installing the Phone

PLACE YOUR BASE



TRY TO AVOID

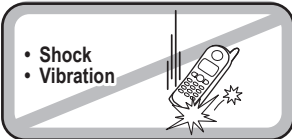
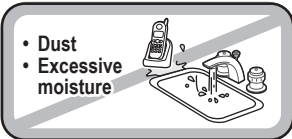
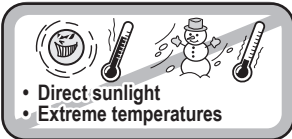
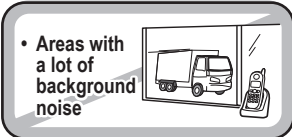
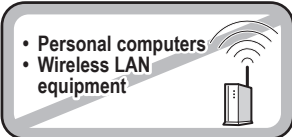
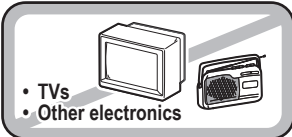
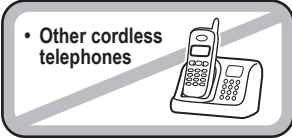
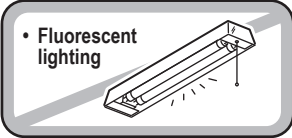
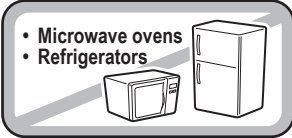

Note: For maximum range:

- Keep both the base and handset antennas free of obstruction.
- When the handset is not in use, place the handset in an upright position.
- Metal and reinforced concrete may affect cordless telephone performance.



Installing the Battery

Use only the Uniden BT-446 rechargeable battery pack supplied with your cordless telephone.

- ① Locate the battery pack, battery cover and the handset.

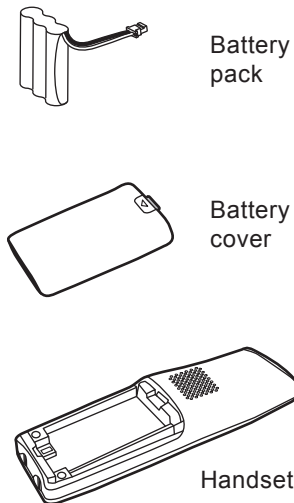

- ② Line up the red and black wires on the battery pack connector with the sticker in the handset's battery compartment.

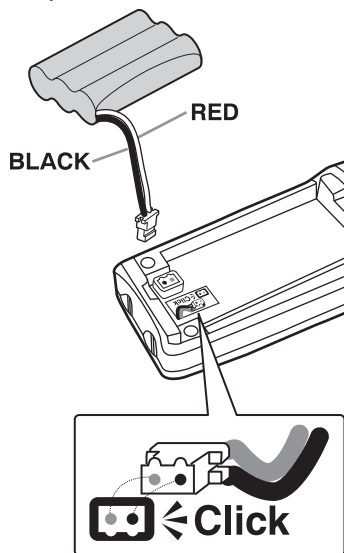

- ③ Push the battery pack connector in firmly. (You should hear it click into place.) Gently tug on the battery wires to make sure the connection is secure.

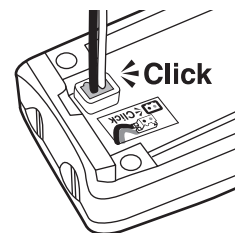

- ④ Place the cover over the battery compartment and slide it up into place.

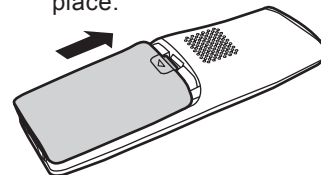

Installing the Phone



Connecting the AC adapter

To the base

To avoid risk of fire and shock, only use the Uniden AAD-041S(M) AC adapter with the base.

- 1 Connect the AC adapter to the **DC IN 9V** jack on the bottom of the base.

- 2 Route the cord through the molded wiring channel.

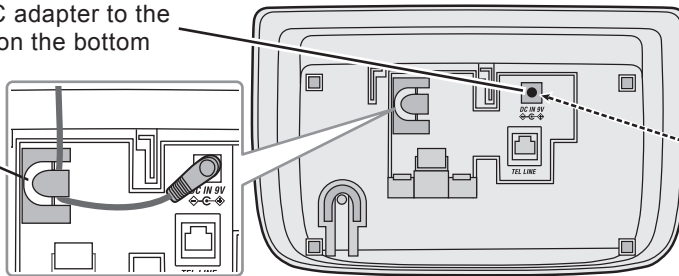

- 3 Connect the AC adapter to a standard 240V AC wall outlet.

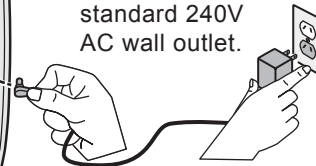

Don't put any power cord where it people might trip over it or step on it. If a power cord becomes chafed or worn out, it can create a fire or electrical hazard.

To the charging cradle (for multi-handset packs only)

Use only the Uniden AAD-600S(M) AC adapter with the charging cradle.

- 1 Place the cord through the molded wiring channel.

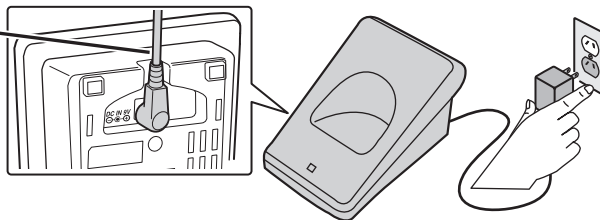

- 2 Connect the AC adapter to a standard 240V AC wall outlet.

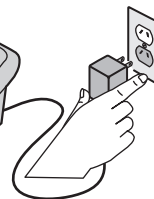

Charging the Handset

- 1 Place the handset in the base cradle with the display facing forward.

- 2 If you have an accessory handset, place it in the charging cradle with the display facing forward.

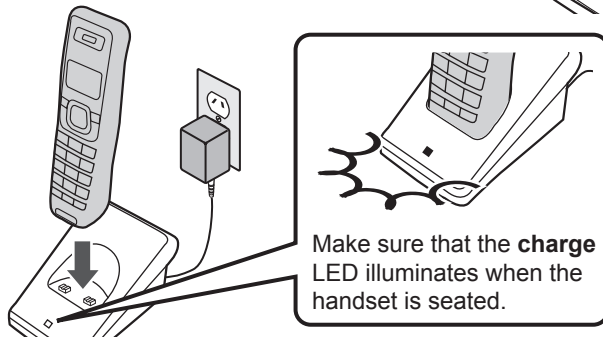
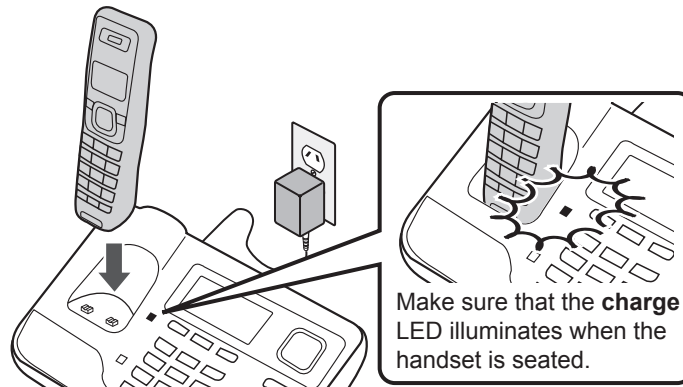

- 3 Charge your handset at least 15 to 20 hours before plugging into the phone line.

? What if the **charge** LED doesn't light up?



- Reseat the handset; make sure the contacts on the bottom of the handset are lined up with the contacts in the charging cradle.
- Check the AC adapter connection.
- Make sure you are not using an outlet that's controlled by a wall switch.



Connecting to the Phone Line

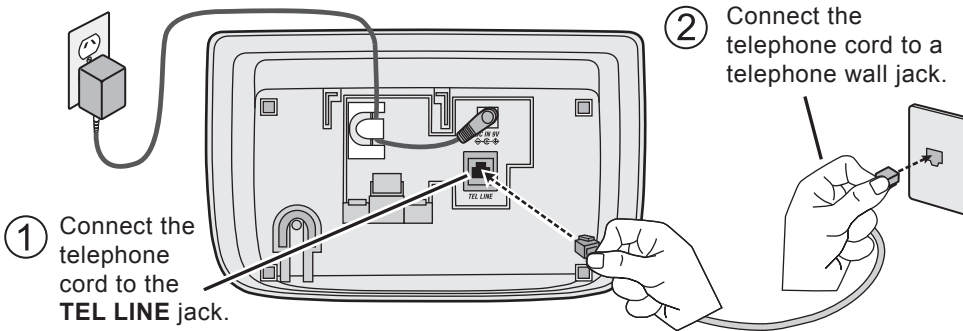

? What if **CHECK TEL LINE** appears on the base or handset display?

💡 The telephone cord may not be connected correctly. Check the telephone cord connection.

? Do you have DSL or any high-speed Internet service delivered through your phone line?

💡 Try putting a DSL filter between the base and the wall jack. Without a filter, telephone-line-based Internet services can interfere with standard phones.

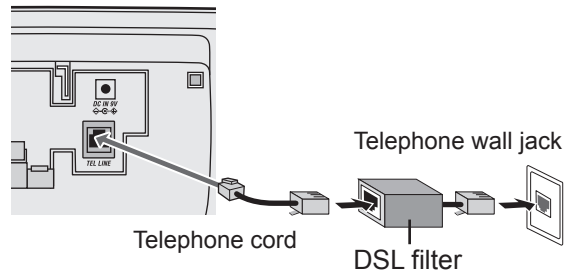

Testing the Connection

① Pick up the handset from the base and press **[*/flash]**. You should hear a dial tone, and the display should show TALK.

? What if I can't hear a dial tone?

💡 Check the telephone cord connection on the base.

? What if the display doesn't show TALK?

- 💡 • Check the battery pack connection in the handset.
- Make sure the battery pack is fully charged.
- Make sure the AC adapter cord is securely connected to the DC IN 9V jack and a standard power outlet.
- Try resetting the handset (see page 55).

② Make a quick test call, and then press **[*]** to hang up.

? What if there is a lot of static?

💡 Check the sources of interference described in Choosing the Best Location (see page 5): is the base near any of those?

Note: Make sure you can get a dial tone on any accessory handsets that were packaged with your phone.

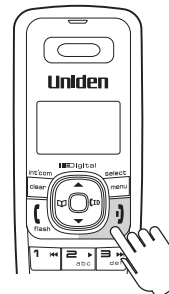
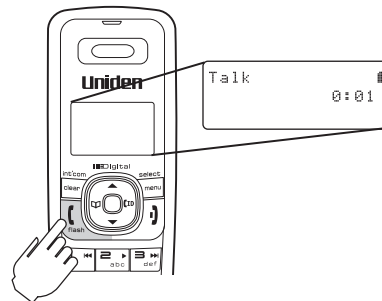



NOW YOU ARE READY TO USE YOUR PHONE!



Installing the Belt Clip

Insert the tabs on the sides of the belt clip into the holes on either side of the handset. Press the belt clip down until it clicks into place. (Tug on the clip to make sure it's secure.)

To remove the belt clip, gently pull the tabs out of the holes, then slide the belt clip off of the handset.

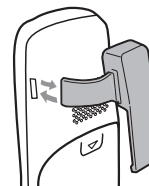



Expanding Your Phone

Adding accessory handsets

Your phone supports a total of ten cordless handsets, including any that were supplied with your phone. You can now place a fully-featured cordless handset anywhere AC power is available to connect the charging cradle.

- Your phone is compatible with the DSS8905 and DSS8905WP accessory handset.
- For instructions on connecting the charging cradle, see page 7.
- If you purchase any accessory handsets separately, you must register the handsets to the base before you can use them. (Accessory handsets that come packaged with a base are already registered to that base.)

Registering accessory handsets

When charged, registered handsets display a handset ID number. Handsets that have not been registered display:



To register a DSS8905 accessory handset:

- 1) Charge the handset for 15-20 hours.
- 2) Place the handset in the base cradle for about thirty seconds. HANDSET REGISTERING will appear in the LCD.
- 3) When the handset has registered to the base, the LCD will display REGISTRATION COMPLETE then show the handset ID number.

If REGISTRATION FAILED appears in the LCD, please try these steps again.

Note: If a handset has ever been registered to a base, you must reset the handset before you can register it to a new base. See Resetting the Handset on page 55.

To register a DSS8905WP accessory handset see page 5 of the owner's manual which comes with the DSS8905WP.





Wall Mounting the Base

This phone can be mounted on any standard telephone wall plate.

- 1 Route the AC adapter and the telephone cord through the hole of the wall mount bracket.

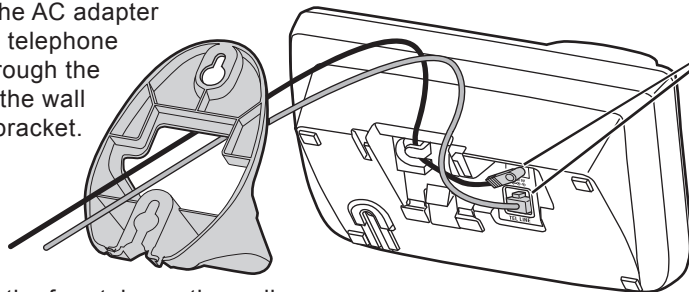

- 2 Connect the AC adapter and the telephone cords as shown on pages 7 and 9. Remember to route the AC adapter cord through the channel.

- 3 Line up the four tabs on the wall mount bracket (two at the top and two at the bottom) with the four notches on the bottom of the base. Slide the bracket into place.

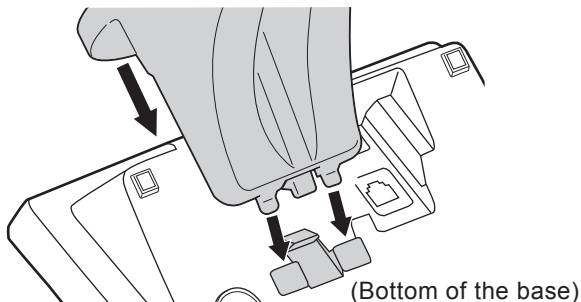

- 4 Hook the AC adapter cord into the smaller notch at the bottom of the bracket, and let the cord hang below the bracket.

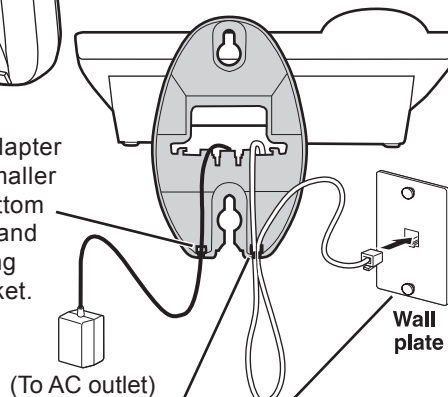

- 5 Plug the telephone cord into the wall jack. Hook both sides of the telephone cord into the larger notch OR tuck the excess cord into the open space in the bracket.



- ⑥ Place the mounting slots over the pins on the wall plate.

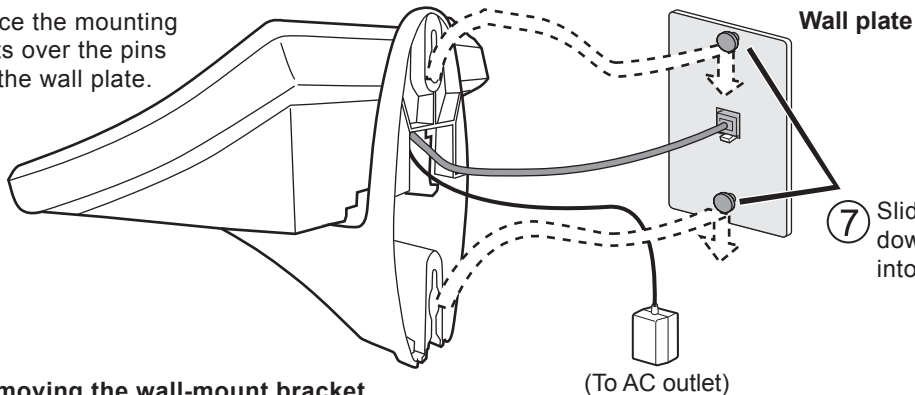

- ⑦ Slide the base down to lock it into place.

⑧ Removing the wall-mount bracket

At the bottom of the base, lift up on the release latch between the two bottom tabs and push the bracket up.

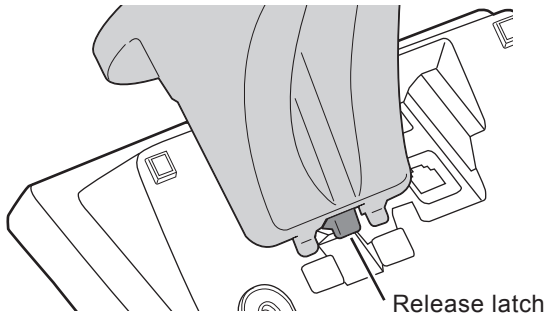

Note: Mounting the phone directly on the wall

- Be sure the wall is capable of supporting the weight of the phone, and use the proper type of anchoring device for the wall material.
- Insert two #10 screws (minimum length of 35mm, not supplied) into the wall, 100mm apart.
- Leave the screw heads 3mm away from the wall to allow room for mounting the phone.
- Align the mounting slots over the screws and slide the base down into place as shown above.

Getting to Know Your New Phone

Features

- 5.8GHz FHSS expandable system
- Expands up to 10 handsets
- Integrated digital answering system
- Caller ID/Call Waiting
- Base keypad
- Advanced phonebook features:
 - Store 70 phonebook entries on base & each handset
 - Alphabetical search
 - Personalized ring by party (on handset)
 - Transfer single listing or entire phonebook
- Store 30 Caller ID numbers on base & each handset
- Speakerphone on base & handset
- 7 ringer options on handset (3 tones/4 melodies)
- Last 5 number redial
- Call transfer
- Conferencing
- Intercom

Answering system features

- Digital tapeless recording
- Up to 14 minutes of recording time
- Call screening
- Personal or pre-recorded outgoing messages
- Day and time announcement
- Remote message retrieval
- Toll saver
- Message alert
- Records up to 59 messages

Terminology Used in this Manual

Accessory Handsets	Additional handsets that can register to the base, allowing you to add handsets without connecting another phone line. This base supports a total of ten cordless handsets; see page 12 for compatible handsets.
Base	The main part of the phone that connects to your phone line and lets you make and receive calls.
Charging cradle	A cradle that comes with an accessory handset and charges the handset battery pack. It connects to power but does not connect to a phone line.
CID	Caller ID is available from your telephone provider and is offered to users on a subscription basis. With this service, you will be able to see the incoming caller information such as name and phone number.
CID/CW or CIDCW	Caller ID with Call Waiting is available by subscription from your telephone provider. With this service, you will be able to view incoming caller information while on a call with another user.
Global Settings	Any settings that apply to all registered handsets and the base. These features are available by selecting “GLOBAL SETUP” in the handset or the base menu. Only one handset or the base can change global settings at a time, and you have to make sure the phone is not currently being used.
Standby	The handset and the base are not in use. (It doesn't matter whether the handset is in the cradle: the [/flash] or [■(■)] on the handset or [■(■)] on the base hasn't been pressed, and there is no dial tone.)
Station	Any registered handset or the base.
Talk	A dial tone has been enabled, so you can dial and carry on a conversation with an outside party.

Manual Conventions

This manual uses several different type styles to help you distinguish between different parts of the phone:

- **BOLD** text with “[]” indicates a key or button on the phone
- ALL CAPITALS indicates text on the display, such as menu options, prompts, and confirmation messages
- **lower case bold** text indicates a status light on the phone
- **ALL CAPITALS BOLD** indicates a connection jack on the base or charging cradle

Parts of the Handset

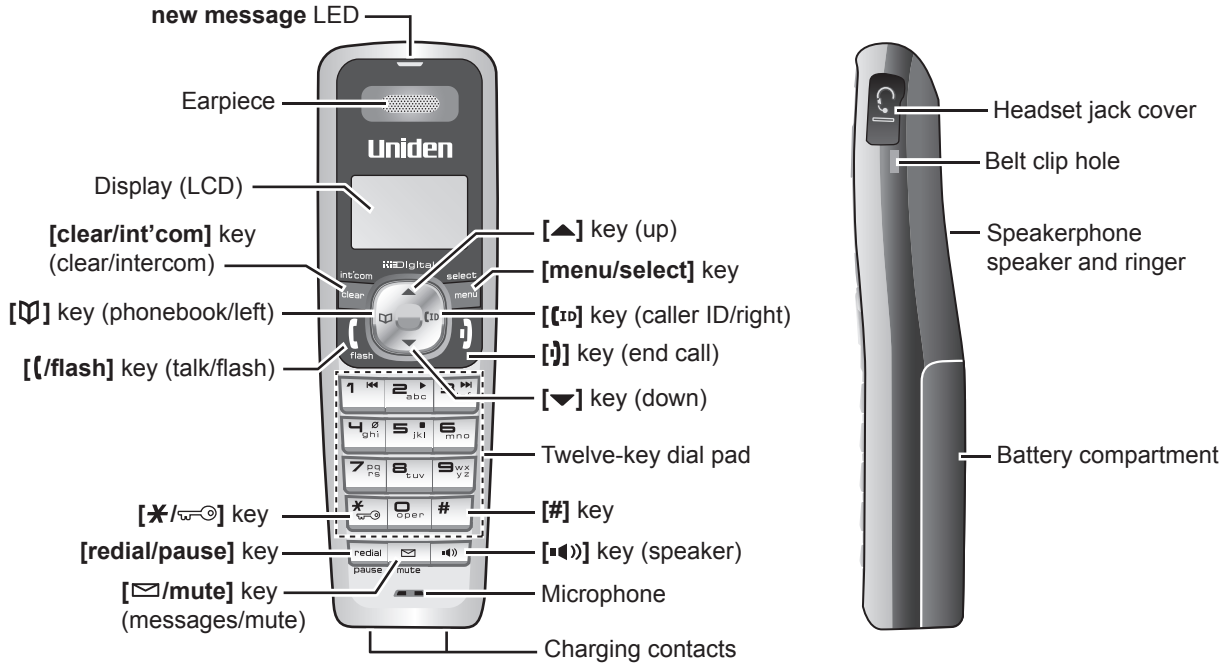

Parts of the Base

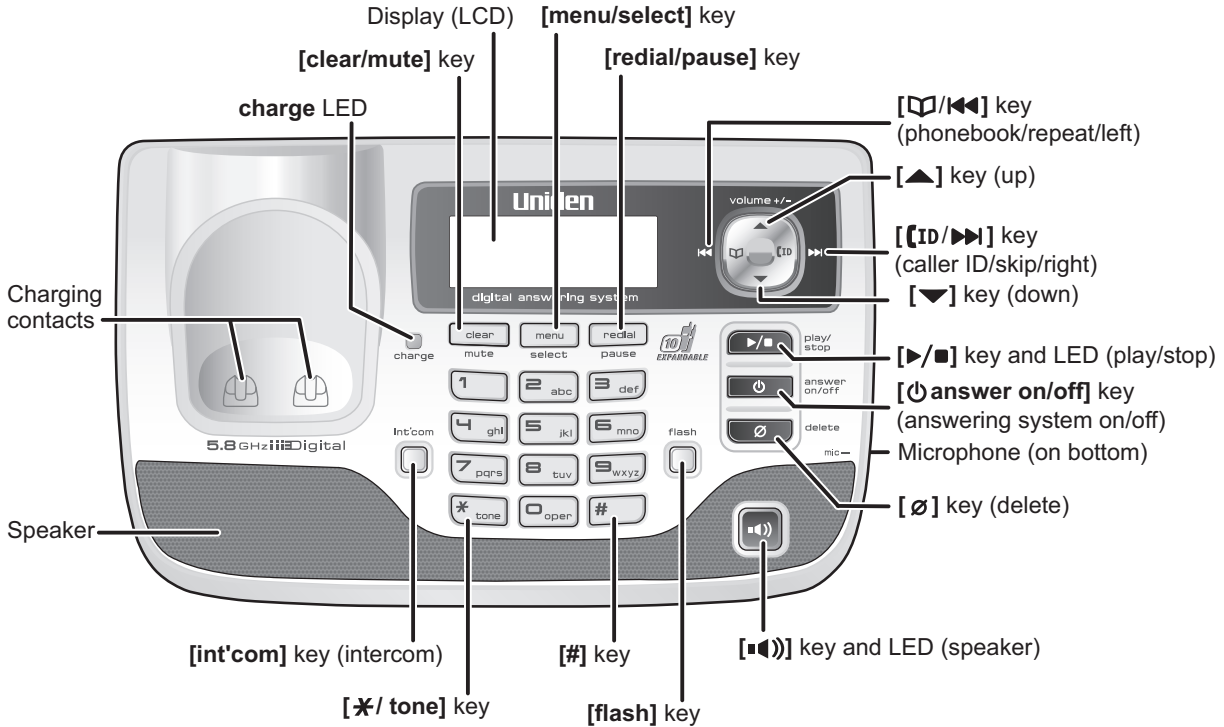

Using the Interface

Reading the Display

Handset

In standby

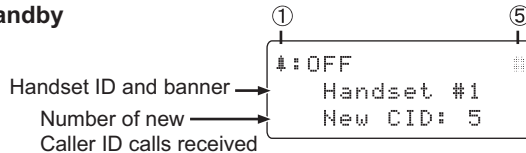

Note: The handset does not display the day and time.

During a call

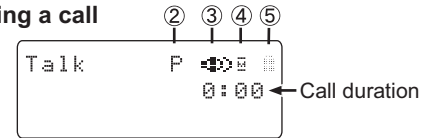

Base

In standby

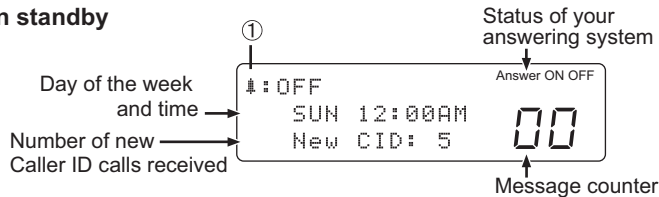

During a call

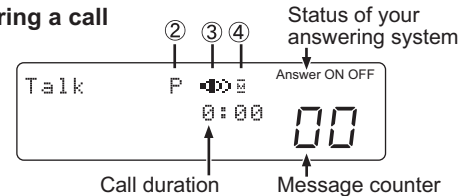

①	#: OFF	The ringer off icon indicates that the ringer is turned off.
②	P	The privacy icon appears when the Privacy Mode is turned on.
③	Speaker icon	The speaker icon appears when the speaker phone is in use.
④	Mute icon	The mute icon appears while the microphone is muted.
⑤	Battery icon	The battery icon indicates the handset battery status: full, medium, low, and empty.

Using the Four-way Function Key

Your handset and base have a four-way function key that allows you to move the cursor or pointer on the display and access the most commonly used features at the touch of a button. By moving this key to the left, you open the phonebook. Move the key to the right to access Caller ID information. To use this four-way key, place your thumb over the key and move to the four positions to get the feel of how it moves and operates.

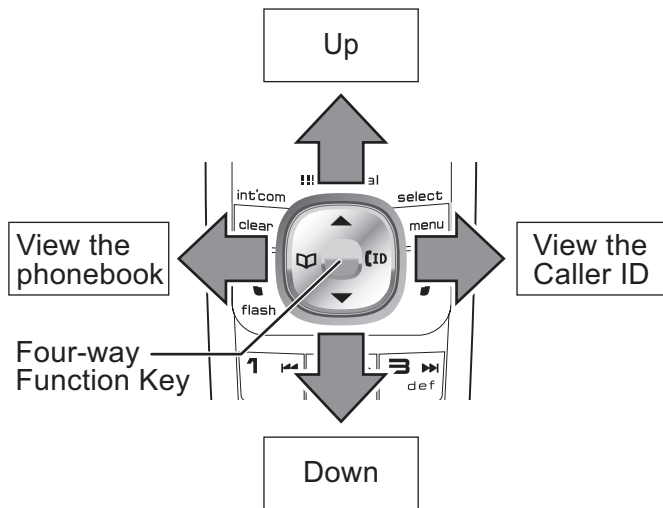

Using the Menu

The menus for the handset and the base work in the same way:

- To open the menu, press the [menu/select] key.
- The arrow pointer on the left side of the line shows which menu item is currently highlighted. Use [▲] on the four-way function key to move the pointer up and [▼] to move the pointer down.
- To select the highlighted option, press [menu/select].
- To go back to the previous screen, press [left] on the four-way function key.
- To exit the menu on the handset, press [1].
- To exit the menu on the base, press [▶/■].
- If you don't press any keys for thirty seconds, the phone will time out and exit the menu. (When setting the day and time, the time-out period is extended to two minutes.)
- For ANSW. SETUP, GLOBAL SETUP, DAY & TIME and REGISTER HANDSET (base only) menu options, make sure the line is not in use and the handsets are within range of the base.

Entering Text from Your Phone

You can use the number keypad on your handset or base to enter text by referring to the letters printed on each number key. When you press the number key in a text entry field, the phone displays the first letter printed on the number key. Press the number key twice to display the second letter and three times to display the third. Capital letters are displayed first, then lower case letters, and then the number on the key.

If two letters in a row use the same number key, enter the first letter, then use **[right]** on the four-way function key to move the cursor to the next position to enter the second letter.

For example, to enter the word “Movies”:

- 1) Press [6] once to enter M.
- 2) Use **[right]** on the four-way function key to move the cursor to the right.
- 3) Press [6] six times to enter o.
- 4) Press [8] six times to enter v.
- 5) Press [4] six times to enter i.
- 6) Press [3] five times to enter e.
- 7) Press [7] eight times to enter s.
- 8) Press **[menu/select]** to end your text entry.

If you make a mistake while entering a name, use **[right]** or **[left]** on the four-way function key to move the cursor to the incorrect character. Press **[clear/int'com]** on the handset or **[clear/mute]** on the base to erase the wrong character, and then enter the correct character. To delete all characters, press and hold **[clear/int'com]** on the handset or **[clear/mute]** on the base.

	Number of times key is pressed								
keys	1	2	3	4	5	6	7	8	9
1	1								
2 abc	A	B	C	a	b	c	2		
3 def	D	E	F	d	e	f	3		
4 ghi	G	H	I	g	h	i	4		
5 jkl	J	K	L	j	k	l	5		
6 mno	M	N	O	m	n	o	6		
7 pqrs	P	Q	R	p	q	r	s	7	
8 tuv	T	U	V	t	u	v	8		
9 wxyz	W	X	Y	Z	w	x	y	z	9
0 oper	&	<	>	<	>	/	(blank)	--	--
	.	,	:	?	!	@	'	"	*
	#	0							



Basic Setup

Activating Personal Ring (Handset only)

You can assign special ringer tones to anyone in your phonebook. When your phone gets a call, it looks up the Caller ID information in your phonebook. If you've assigned a personal ringer to that number, the phone uses it so you know who is calling. To turn the personal ringing on or off, follow these steps:

- 1) Press **[menu/select]**.
- 2) Select the HANDSET SETUP menu, and then the PERSONAL RING submenu.
- 3) Move the cursor to select ON or OFF.
- 4) Press **[menu/select]**. You will hear a confirmation tone.

```
Personal Ring
▶ On
  Off
```



Activating the Key Touch Tone

Key Touch Tone is the tone your keypad makes when keys are pressed. You can turn this tone on or off.

- 1) Press **[menu/select]**.
- 2) Select the HANDSET SETUP or BASE SETUP menu, and then the KEY TOUCH TONE submenu.
- 3) Move the cursor to select ON or OFF.
- 4) Press **[menu/select]**. You will hear a confirmation tone.

```
Key Touch Tone
▶ On
  Off
```





Name Tag

Name Tagging works with the caller display number from Caller ID. You will need to subscribe to the Caller ID feature with your phone company for Name Tagging to work.

When the phone rings, the received caller display number is compared to numbers stored in the phonebook. If there is a match then any name stored with the phonebook number will be displayed. To change the Name Tagging setting, follow the steps listed below.:

- 1) Press **[menu/select]**.
- 2) Select the HANDSET SETUP menu, and then the NAME TAG submenu.
- 3) Move the cursor to select ON or OFF.
- 4) Press **[menu/select]**. You will hear a confirmation tone.

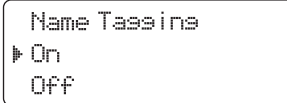

Name Tagging
▶ On
Off

Insert 0

This feature adds “0” or “00” at the beginning of the number received from Caller ID. The default setting for New Zealand is ON. The default setting for Australia is OFF. To change the Insert 0 setting, follow the steps listed below..

- 1) Press **[menu/select]**.
- 2) Select the GLOBAL SETUP menu, and then the INSERT 0 submenu.
- 3) Move the cursor to select ON or OFF.
- 4) Press **[menu/select]**. You will hear a confirmation tone.

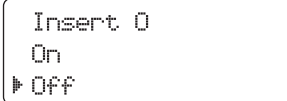

Insert 0
On
▶ Off



Setting Up the Phonebook

Each station has its own separate phonebook that holds up to seventy names and numbers. When a station's phonebook is full, the station beeps and shows MEMORY FULL on the display. You cannot add any names and numbers in that station's phonebook until you delete some of the existing ones.

You can also use the phonebook entries to store a group of numbers (up to twenty digits) that you may need to enter once your call connects. This is referred to as chain dialing. (See Chain dialing from the phonebook on page 31.)

Creating Phonebook Entries

To store names and numbers in your phonebook, please follow these steps:

- 1) With the phone in standby, press [] (on the left side of the four-way key).
- 2) To create a new phonebook entry, press [menu/select]. Select the CREATE NEW menu. EDIT NAME appears.

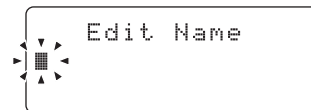

- 3) Enter the name for this entry (EDIT NAME).

Use the keypad to enter a name for this entry; the name can contain up to sixteen characters. (See Entering Text from Your Phone on page 21 for instructions on entering text.) If you do not want to enter a name for this entry, your phone will store this entry as <NO NAME>. Press [menu/select] when you are finished.

- 4) Enter the number for this entry (EDIT NUMBER).

Once you have stored a name, EDIT NUMBER appears next. Use the number keypad to enter the phone number; the phone number can contain up to twenty digits. If you need the phone to pause between digits when it's dialing (for example, to enter an extension or an access code), press [redial/pause] to insert a two-second pause. You will see a P in the display. You can also use more than one pause together if two seconds is not long enough. Each pause counts as one digit. Press [menu/select] when you are finished.

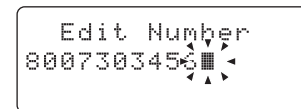



5) Assign a personal ring tone for this entry (PERSONAL RING) (Handset only).

You can attach a special ring tone to each phonebook entry on the handsets; the phone will use this ring tone when this person calls. Use [▲] and [▼] to select one of the seven different ring tone options (see Selecting a Ring Tone on page 28 for a complete list of ring tones). As you scroll through the tones, you will hear a sample of each tone (unless the handset ringer volume is set to off). When you hear the ring tone you want to use, press [menu/select]. If you do not want to use a personal ring tone for this phonebook entry, choose NO SELECTION; the phone will use your standard ring tone setting.

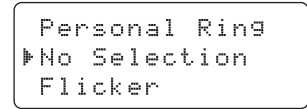

6) You will hear a tone confirming that the new entry has been stored, and DONE! appears in the display.

Finding a Phonebook Entry

Press [Ⓜ] to open the phonebook. Phonebook entries are stored in alphabetical order. To scroll through the phonebook from A to Z, press [▼]. To scroll trough the phonebook from Z to A press [▲].

You can also use the letters on the number keys to jump to a name that starts with that letter. For example, to search for an entry beginning with the letter M, press [6] once. The phonebook jumps to the first entry that begins with the letter you entered; you can then use [▲] and [▼] to scroll to other entries.

To close the phonebook and return to standby, press [Ⓜ] on the handset or [▶/■] on the base. If you are looking up a phonebook entry during a call and want to close the phonebook, press [Ⓜ] again instead of [Ⓜ] or [▶/■].

Editing an Existing Phonebook Entry

- 1) With the phone in standby, press [Ⓜ] to open the phonebook.
- 2) Find the entry you want to edit and press [menu/select].
- 3) Select EDIT. Follow the steps for Creating Phonebook Entries on page 24. If you do not wish to change the information at any step, simply press [menu/select] to go to the next step.



Storing Caller ID or Redial Numbers in the Phonebook

You can store Caller ID records or redial numbers in the phonebook so you can use them later. Go to the Caller ID or redial list and select the number you want to store. (If the Caller ID information did not include the number, then you will not be able to store it.)

- 1) With the phone in standby, press **[[*]]** to open the Caller ID list or **[redial/pause]** to open the redial list.
- 2) Use **[▲]** and **[▼]** to scroll through the Caller ID records or redial numbers. When you come to the information you want to store, press **[menu/select]**.
- 3) Select STORE INTO PB. EDIT NAME appears. If the phone number is already stored in memory, you will hear a beep, and THIS DATA IS ALREADY SAVED! appears in the display. The number will not be stored.
- 4) Continue by following the steps for Creating Phonebook Entries on page 24.

Deleting a Single Phonebook Entry

- 1) With the phone in standby, press **[*]**.
- 2) Find the entry that you want to delete and press **[menu/select]**.
- 3) Select DELETE. DELETE ENTRY? appears in the display.
- 4) Move the cursor to select YES.
- 5) Press **[menu/select]**. You will hear a confirmation tone, and DELETED! appears in the display.

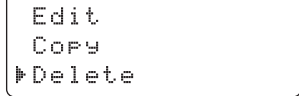

```
Edit
Copy
▶Delete
```

Deleting all Phonebook Entries

- 1) With the phone in standby, press **[*]**.
- 2) Press **[menu/select]**, and then select DELETE ALL. DELETE ALL? appears in the display.
- 3) Move the cursor to select YES.
- 4) Press **[menu/select]**. You will hear a confirmation tone, and DELETED! appears in the display.

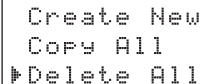

```
Create New
Copy All
▶Delete All
```



Copying Phonebook Entries to Another Station

You can transfer phonebook entries from one station to another without having to re-enter names and numbers. You can transfer one phonebook entry at a time or all phonebook entries at once.

- 1) With the phone in standby, press [**⏏**].
- 2) To copy one entry, find the phonebook entry you want to copy. Press **[menu/select]**, and then select COPY. To copy all entries, press **[menu/select]**, and then select COPY ALL.
- 3) Move the cursor to select the station which you want to transfer the entries to and then press **[menu/select]**. If you select COPY ALL, ARE YOU SURE? appears on the display screen. Move the cursor to select YES, and then press **[menu/select]**.
- 4) The phonebook entries will be transferred to the designated station. During the copy process, the receiving station shows RECEIVING and the ID of the sending station.
- 5) When the transfer is completed, DONE! appears on the station.

Notes:

- If the station you want to transfer to already has seventy entries in its phonebook, you will hear a beep, and NOT ENOUGH MEMORY IN RECEIVING UNIT appears on the display.
- If the selected station is out of range or data transfer is cancelled, UNAVAILABLE appears in the display. Phonebook listings will not be transferred.



Customizing Your Handsets

All of the following options are set separately for each handset, so you can customize a handset for each room in your house.

Changing the Handset Banner

Each handset will display a banner name once it is registered to the base. The default banner is Handset #1, Handset #2, etc. You can change the name your phone displays by changing the banner display. If you have more than one handset, the banner name identifies your handset.



- 1) Press **[menu/select]**.
- 2) Select the HANDSET SETUP menu, and then the BANNER submenu.
- 3) Use the keypad to enter or edit the banner name. (See Entering Text from Your Phone on page 21 for detailed instructions on entering text.)
- 4) Press **[menu/select]**. You will hear a confirmation tone.

Selecting a Ring Tone

You may choose from four melodies or three tones for your phone's primary ring tone. Each handset can use a different ring tone or melody. The available ring tones are as listed:

Melodies	Fur Elise (ELISE)	Tones	Flicker
	We Wish You A Merry Christmas (MERRY-XMAS)		Clatter
	Aura Lee (AURA LEE)		Wake Up
	Waltzing Matilda (WMatilda)		

- 1) Press **[menu/select]**.
- 2) Select the HANDSET SETUP menu, and then the RINGER TONES submenu.
- 3) Move the cursor to select a ring tone. As each ring tone is highlighted, you will hear a sample (unless the handset ringer volume is set to off).
- 4) When you hear the tone you want to use, press **[menu/select]**. You will hear a confirmation tone.

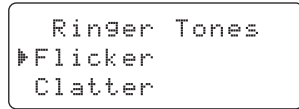

Activating AutoTalk

AutoTalk allows you to answer the phone simply by picking up the handset from the cradle. You do not have to press a button to answer the call.

- 1) Press **[menu/select]**. Select the HANDSET SETUP menu, and then the AUTOTALK submenu.
- 2) Move the cursor to select ON or OFF.
- 3) Press **[menu/select]**. You will hear a confirmation tone.

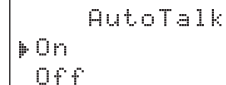

```
AutoTalk
▶ On
  Off
```

Activating Any Key Answer

Any Key Answer allows you to answer the phone by pressing any key on the twelve-key dial pad.

- 1) Press **[menu/select]**. Select the HANDSET SETUP menu, and then the ANY KEY ANSWER submenu.
- 2) Move the cursor to select ON or OFF.
- 3) Press **[menu/select]**. You will hear a confirmation tone.

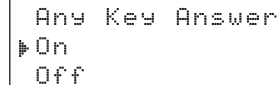

```
Any Key Answer
▶ On
  Off
```

Activating Handset Keypad Lock





Press and hold **[*/]** to activate the keypad lock. Repeat the process to deactivate the keypad lock.



Using Your Phone

	From the base speakerphone	From a cordless handset	From a handset speakerphone
Making a call	1) Press [*#00] . 2) Listen for the dial tone. 3) Dial the number. OR 1) Dial the Number. 2) Press [*#00] .	1) Pick up the handset from the cradle. 2) Press [#/flash] . 3) Listen for the dial tone. 4) Dial the number. OR 1) Pick up the handset from the cradle. 2) Dial the number. 3) Press [#/flash] .	1) Pick up the handset from the cradle. 2) Press [*#00] . 3) Listen for the dial tone. 4) Dial the number. OR 1) Pick up the handset from the cradle. 2) Dial the number. 3) Press [*#00] .
Answering a call	Press [*#00] .	1) Pick up the handset. (If AutoTalk is on, the phone will answer when you pick up the handset from the cradle.) 2) Press [#/flash] . (If Any Key Answer is on, you can also press any key on the dial pad.)	1) Pick up the handset. 2) Press [*#00] .
Hanging up	Press [*#00] .	Press [*] or return the handset to the cradle.	





Making a Call from the Phonebook

- 1) With the phone in standby, press [] to open the phonebook.
- 2) Find the phonebook entry you want to call (see Finding a Phonebook Entry on page 25).
- 3) Press [ /flash] or [] on the handset or [] on the base to dial the number.



Note: You can also press [ /flash] or [] on the handset or [] on the base before you open the phonebook. Find the phone number you want to dial, and then press [**menu/select**].

Chain dialing from the phonebook

If you often have to enter a series of digits or a code number during a call, you can save that code number to a phonebook entry. When your call connects, just use the phonebook to transmit the saved code number. (This is referred to as chain dialing.)

- 1) Enter the code number (up to twenty digits) into the phonebook (see Creating Phonebook Entries on page 24). Be sure to enter the code number into the phonebook exactly as you would enter it during a call.
- 2) During a call, when you hear the prompt that tells you to enter the code number, press [].
- 3) Use [] or [] to select the phonebook entry that contains the digits you want to send.
- 4) Press [**menu/select**]. The phone sends the digits of the code number exactly as you saved them in the phonebook entry.

Switching to the Handset Speakerphone During a Call

To switch a normal call to the speakerphone, press [] on the handset. To switch from a speakerphone call to a normal call, press [].

Using Caller ID, Call Waiting, and Redial Lists

If you subscribe to Caller ID service from your phone company, your phone will show you the caller's phone number and name (if available) whenever a call comes in. If you subscribe to Caller ID on Call Waiting, the phone will also show you the name and the number of any call that comes in while you're on the line.

Using the Caller ID List

You can store up to thirty Caller ID numbers in each station. Caller ID records are stored from newest to oldest. Once your Caller ID list is full, the oldest record will be automatically deleted when a new call is received.

To open the Caller ID list, press **[CID]** (on the right side of the four-way key). The phone will show the number of new Caller ID records (that is, records you have not reviewed yet) and the total number of stored records. Use **[▲]** and **[▼]** to scroll through the list. (New records have an asterisk next to the received time.)

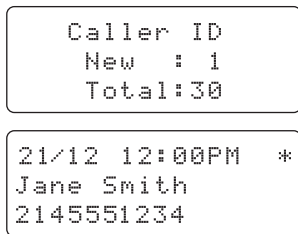

Making a Call from a Caller ID Record

- 1) With the phone in standby, press **[CID]** to open the Caller ID list.
- 2) Use **[▲]** and **[▼]** to find the Caller ID record you want to dial.
- 3) Press **[/flash]** or **[☎]** on the handset or **[☎]** on the base to dial the number.

Note: You can also press **[/flash]** or **[☎]** on the handset or **[☎]** on the base before you open the caller ID list. Find the phone number you want to dial, and then press **[menu/select]**.



Deleting Caller ID Numbers

To delete only one Caller ID number, press **[[*]ID]** when the phone is in standby, and then find the number you want to delete. Press **[menu/select]** and select DELETE ENTRY. When the phone asks you to confirm, select YES.

To delete all the Caller ID numbers, press **[[*]ID]** when the phone is in standby, and then press **[menu/select]**. When the phone asks you to confirm, select YES.

- Notes:
- When you delete a Caller ID number, you delete it permanently.
 - Caller ID numbers are stored separately in each station. Deleting a record from one station will not delete the record from any other stations.

Using Call Waiting

If you have Call Waiting service and a second call comes in when you are on the phone, a call waiting tone will sound.

For Australian Model:

Press **[[/flash]** and then **[2]** on the handset to accept the waiting call. The first caller is put on hold, and you will hear the new caller after a short pause. To return to the original caller, press **[[/flash]** and then **[2]** again.

For New Zealand Model:

Press **[[/flash]** on the handset to accept the waiting call. The first caller is put on hold, and you will hear the new caller after a short pause. To return to the original caller, press **[[/flash]** again.

Note: You must subscribe to Call Waiting service for this feature to operate. Not all features are available in all areas.



Redialing a Number

You can quickly redial the last five numbers dialed on each station.

- 1) With the phone in standby, press the **[redial/pause]** to open the redial list.
- 2) Use **[▲]** and **[▼]** or **[redial/pause]** to scroll through the redial list.
- 3) When you find the number you want to dial, press **[/flash]** or **[▶▶]** on the handset or **[▶▶]** on the base.

Notes:

- If the number exceeds 32 digits, only the first 32 digits are retained in redial memory.
- If the redial memory is empty, EMPTY appears in the display and you will hear a beep.
- You can also press **[/flash]** or **[▶▶]** on the handset or **[▶▶]** on the base before you open the redial list. Find the phone number you want to dial, and then press **[menu/select]**.

Deleting a Redial Record

If you want to delete a phone number from the redial list, follow the steps below:

- 1) With the phone in standby, press **[redial/pause]**.
- 2) Use **[▲]** and **[▼]** to scroll through the redial list.
- 3) When you find the redial number you want to delete, press **[menu/select]** and select DELETE ENTRY.
- 4) When the phone asks you to confirm, select YES. The redial number is deleted.

Adjusting the Ringer, Earpiece and Speaker Volume

Adjusting the Ringer Volume

You can choose from four ringer volume settings (off, low, medium, and high) separately on each handset or the base.

- 1) With the phone in standby, press [▲] or [▼]. The display shows the current volume level and the station sounds the ringer at that level.
- 2) Use [▲] to make the ringer volume louder or [▼] to make it softer or turn it completely off.
- 3) When you hear the ringer volume level you want to use, stop pressing keys. The station will use the new ringer volume starting with the next incoming call.

Note: If you set the ringer volume to OFF, the station won't ring. The other stations will ring according to their individual settings.

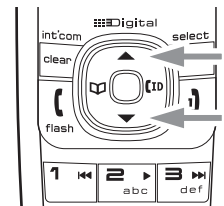

Muting the Ringer (One call only)

While the phone is ringing, press [✉/mute] or [1] on the handset, or [clear/mute] or [▶/■] on the base to mute the ringer for this call. The phone will ring again on the next call. (The handset must be off the cradle to mute the ringer.)

Adjusting the Earpiece Volume

You can choose from six volume levels for the handset earpiece. To adjust the earpiece volume while on a call, press [▲] (to make it louder) or [▼] (to make it softer). The handset display shows the current volume level for the earpiece.

Adjusting the Speaker Volume

Handset Speaker: You can choose from six volume levels for the handset speaker while on a speakerphone call or when the handset is accessing the answering system. To adjust the handset speaker volume, press [▲] (to make it louder) or [▼] (to make it softer). The handset display shows the current volume level for the handset speaker.

Note: The handset earpiece and the handset speaker have separate volume settings.

Base Speaker: You can choose from ten volume levels for the base speaker while on a speakerphone call or when the answering system announces or plays a message. To adjust the base speaker volume, press [▲] (to make it louder) or [▼] (to make it softer). The base display shows the current volume level for the base speaker.

Adjusting the Audio Tone (Handset only)

If you aren't satisfied with the audio quality of your phone, you can adjust the Audio Tone of the earpiece while on a call. Your phone gives you three audio tone options: low, natural and high; the default setting, Natural Tone, is recommended for hearing aid users. Audio tone adjustments only apply to the earpiece, not the speakerphone.

To adjust the audio tone:

- 1) While on a call, press [menu/select].
- 2) Move the cursor to select AUDIO TONE, and then press [menu/select].
- 3) Move the cursor to select desired option (HIGH TONE, NATURAL TONE, or LOW TONE), and then press [menu/select]. Selected option appears in the display for two seconds, and then the display returns to normal.



Finding a Lost Handset

To locate a misplaced handset, press **[int'com]** on the base when the phone is in standby. Use **[▲]** or **[▼]** to select the handset you want to page, and then press **[menu/select]**. Select ALL to page all registered handsets. To cancel paging, press **[int'com]** on the base again.

Using Hold, Conference and Transfer

Placing a Call on Hold

- 1) During a call, press **[clear/int'com]** on the handset or **[int'com]** on the base to place the caller on hold. If you leave a caller on hold for more than ten seconds, the display screen will read, Line On Hold.
- 2) To return to the party on hold, press **[[/flash]** or **[■▶▶]** on the handset or **[■▶▶]** on the base. The phone will return to the holding party.

Notes:

- You can only place a caller on hold for five minutes. Once five minutes has passed, that party's line will be disconnected and the phone will return to standby.
- While a call is on hold, Caller ID and Call Waiting cannot be received.

Conferencing

If you have more than one handset, up to four people can participate in a conference call. A four-way conference call consists of an outside line, two handsets, and the base speakerphone. You can easily join a call already in progress.

- 1) Press **[[/flash]** or **[■▶▶]** on the handset or **[■▶▶]** on the base to join the call.
- 2) To hang up, return the handset to the cradle or press **[■]** on the handset or **[■▶▶]** on the base. The other party will still be connected to the call.

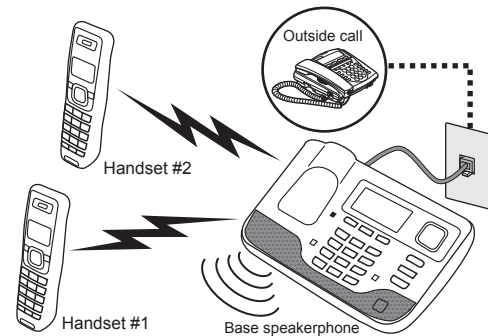



Transferring a Call

You can transfer a call from one station to another.

- 1) During a call, press [clear/int'com] on the handset or **[int'com]** on the base.
- 2) Use [▲] or [▼] to select the station you want to transfer the call to, and then press **[menu/select]**. Select ALL to page all other stations. The call will automatically be placed on hold, and a paging tone sounds. To cancel the transfer, press **[/flash]** or **[*]]]** on the handset or **[*]]]** on the base.
- 3) When another station accepts the transferred call, you will be disconnected. If you want to rejoin the call, press **[/flash]** or **[*]]]** on the handset or **[*]]]** on the base again.

Answering a transferred call

When a station receives a call transfer, it sounds a paging tone; stations also show the ID of the station that is paging. To accept the call transfer:

- 1) To answer the page and speak to the transferring station, press **[/flash]** or **[clear/int'com]** on the handset, or **[*]]]** or **[int'com]** on the base.

Note: If AutoTalk is on, the handset will automatically answer the page when you pick up the handset from the cradle. If Any Key Answer is on, you can also press any key on the handset's dial pad.

- 2) To accept the call and speak to the caller, press **[/flash]** on the receiving handset, or **[*]]]** on the receiving base.
- 3) When you accept the transferred call, the transferring station will be disconnected.

Only the first station to answer the transfer page will be connected to the call. If the transfer page is not picked up within one minute, the operation will be canceled.





Using Special Features

Privacy Mode

Privacy mode prevents other stations from interrupting while you're on a call. As long as your station is in privacy mode, other stations can't join your call or make any calls of their own: their displays will show UNAVAILABLE.

- 1) While on a call, press **[menu/select]**.
- 2) Select CALL PRIVACY. PRIVACY MODE ON appears in the display for two seconds;  appears and remains in the display until the feature is turned off.

To turn privacy mode off, repeat the procedure listed above. PRIVACY MODE OFF appears.

Using the Intercom

You can use the intercom to talk to another station without using the phone line.

Making an intercom page

- 1) With the phone in standby, press **[clear/int'com]** on the handset or **[int'com]** on the base.
- 2) Use **[▲]** or **[▼]** to select the station you want to talk with, and then press **[menu/select]**. Select ALL to page all other stations.
- 3) To cancel the intercom page, press **[i]** on the handset or **[int'com]** on the base.

Note: Intercom paging will be cancelled if any of the following things occur:

- You receive an outside call or an intercom page while selecting the other station.
- You do not select a station within thirty seconds.
- Your handset is out of range (OUT OF RANGE appears in the display).
- The party does not answer the page within one minute.
- The party is busy.
- The party is out of range (UNAVAILABLE appears in the display).





Answering an intercom page

When the intercom page tone sounds, the display will show the ID of the station that is paging.



- 1) Press **[flash]** or **[clear/int'com]** on the handset, or **[MUTE]** or **[int'com]** on the base.

Note: If AutoTalk is on, the handset will automatically answer the page when you pick up the handset from the cradle. If Any Key Answer is on, you can also press any key on the handset's dial pad.

- 2) To hang up an intercom call, press **[END]** on the handset or **[int'com]** on the base.

Muting the Microphone

Mute turns off the microphone so the caller can't hear you. This only works while you are on a call.

- 1) Press **[MUTE]** on the handset or **[clear/mute]** on the base. MUTE ON and  appear in the display;  remains while muting is on.
- 2) To cancel muting, press **[MUTE]** on the handset or **[clear/mute]** on the base again. MUTE OFF appears.



Installing the Optional Headset

Your phone may be used with an optional headset. To use this feature, insert the headset plug into the headset jack. Your phone is ready for hands-free conversations. (Headsets may be purchased by calling the Uniden Parts Department. See the back cover page for contact information.)

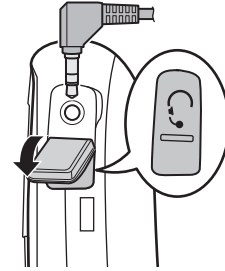

Setting Up the Answering System

You can set up your answering system's features from the base or handset with the exception of changing the outgoing message or greeting; you can only change the greeting or record a new greeting from the base. Only one station at a time can access the answering system menus.

Recording a Personal Greeting

Your answering system comes with a pre-recorded outgoing message or greeting that plays when you receive a call: "Hello, no one is available to take your call. Please leave a message after the tone." You can record your own personal outgoing greeting. Your recorded greeting must be between two seconds and thirty seconds long.

- 1) On the base, press **[menu/select]**.
- 2) Select the ANSW. SETUP menu, and then the RECORD GREETING submenu.
- 3) RECORD GREETING, START [SELECT] appears. Press **[menu/select]** to start the recording. Begin recording after the announcement. The message counter on the base LCD displays "30", and then begins to count down.
- 4) When you finish recording, press **[menu/select]** again or press **[▶/■]**. You will hear a confirmation tone, and your recorded greeting plays back for you.

Selecting a Greeting

Once you have recorded a personal greeting, the phone automatically switches to your personal greeting. You can also switch back and forth between the pre-recorded greeting and your own greeting at any time.

- 1) On the base, press **[menu/select]**.
- 2) Select the ANSW. SETUP menu, and then the GREETING OPTIONS submenu.
The system plays the current greeting.
- 3) To keep this greeting, do nothing.
- 4) To switch to the other greeting, press **[◀◀]** or **[▶▶]** on the four-way function key while the system is playing the current greeting.
- 5) Each time you press **[◀◀]** or **[▶▶]**, the system switches between the pre-recorded and the personal greeting.
The last greeting you hear is used as the current greeting.

Deleting Your Personal Greeting

You can delete your personal greeting from the base. You cannot delete the pre-recorded greeting.

- 1) On the base, press **[menu/select]**.
- 2) Select the ANSW. SETUP menu, and then the GREETING OPTIONS submenu.
The system plays the current greeting.
- 3) While the personal greeting is playing, press **[Ø]**.
- 4) The system announces “Greeting has been deleted,” and switches back to the pre-recorded greeting.

Setting the Number of Rings

The ring time setting allows you to set the number of rings the caller hears before your answering system plays the outgoing message. You can set the ring time to answer after six, nine, or twelve rings. If you enable the Toll Saver (TS) setting, the answering system picks up after two rings if you have new messages, and after four rings if there are none. This way, if you make a long distance call to check your messages, you can hang up after the third ring to avoid long distance billing charges.

- 1) Press **[menu/select]**.
- 2) Select the ANSW. SETUP menu, and then the RING TIME submenu.
- 3) Move the cursor to select a ring time (TOLL SAVER, 6 TIMES, 9 TIMES, or 12 TIMES).
- 4) Press **[menu/select]**. You will hear a confirmation tone.

Setting the Day & Time

If you do not set the clock on your answering system, your messages may not have the correct time and day stamp.

- 1) Press **[menu/select]**.
- 2) Move the cursor to DAY & TIME and press **[menu/select]**.
- 3) Use **[▲]** and **[▼]** to select the day of the week, and press **[menu/select]**.
- 4) Use the number keypad (**[0]** through **[9]**) to enter the hour and minutes.
- 5) Use **[▲]** and **[▼]** to select AM or PM, and press **[menu/select]**. You hear a confirmation tone.

Notes:

- You can set the day and time from the handset, but the day and time do not appear on the handset display.
- If the power goes out on the base, you might have set the day and time again.

Setting the Record Time (or Announce only)

You can choose how long callers have to record a message. Set the record time to 1 MINUTE or 4 MINUTES to limit the time for incoming messages. If you set the record time to ANNOUNCE ONLY, the answering system answers the call but prevents callers from leaving a message.

- 1) Press **[menu/select]**.
- 2) Select the ANSW. SETUP menu, and then the RECORD TIME submenu.
- 3) Move the cursor to select a record time (1 MINUTE, 4 MINUTES, or ANNOUNCE ONLY).
- 4) Press **[menu/select]**. You will hear a confirmation tone.

While your answering system is set to ANNOUNCE ONLY, the **message counter** on the base LCD displays "A." If you are using the prerecorded greeting, the system automatically switches to the following message: "Hello, no one is available to take your call. Please call again." If you are using a personal greeting, the system continues to use that greeting.

Activating the Message Alert

The message alert feature sounds a short alert tone every fifteen seconds whenever you have a new message. To turn on the message alert:

- 1) Press **[menu/select]**.
- 2) Select the ANSW. SETUP menu, and then the MESSAGE ALERT submenu.
- 3) Move the cursor to select ON or OFF.
- 4) Press **[menu/select]**. You will hear a confirmation tone.

Activating the Base Call Screen

With the call screen feature, you can listen to callers as they leave a message without answering the call.

- 1) Press **[menu/select]**.
- 2) Select the ANSW. SETUP menu and then the CALL SCREEN submenu.
- 3) Move the cursor to select ON or OFF.
- 4) Press **[menu/select]**. You will hear a confirmation tone.

Using the Answering System

Turning Your Answering System On and Off

	From the base	From the handset
Turning On	<ol style="list-style-type: none">1) With the phone in standby, press [⏻ answer on/off].2) The system announces “Answering System is on” and plays the current greeting.3) ANSWER ON appears on the base display.	<ol style="list-style-type: none">1) Press [menu/select].2) Select the ANSW. SETUP menu, and then the ANSWER SETUP submenu.3) Move the cursor to select ON.4) Press [menu/select]. You will hear a confirmation tone.
Turning Off	<ol style="list-style-type: none">1) With the phone in standby, press [⏻ answer on/off].2) The phone announces “Answering System is off.”3) ANSWER OFF appears on the base display.	<ol style="list-style-type: none">1) Press [menu/select].2) Select the ANSW. SETUP menu, and then the ANSWER SETUP submenu.3) Move the cursor to select OFF.4) Press [menu/select]. You will hear a confirmation tone.

Note: If the answering system announces “No remaining time” when you turn it on, the memory is full (the message counter also shows FL). The answering system can’t record any new messages until you delete some of the saved ones.



Reviewing Messages

The **message counter** on the base LCD displays the number of messages stored in memory. When you have new messages (that you have not listened to yet), **[▶/■]** on the base and the **new message** LED on the handset flash. The answering system plays your new messages first. If you have no new messages, the system plays your old messages. You can review your messages from the base or from the handset:

	From the base	From the handset
Playing new messages	Press [▶/■] . The system announces the number of new and old messages, then plays the first new message followed by the day and time it was received. Then the system plays the new messages in the order they were received.	Press [☒/mute] . The system announces the number of new and old messages, then plays the first new message followed by the day and time it was received. Then the system plays the new messages in the order they were received.
Repeating a message	Press [⏮] once to go to the beginning of the current message. Press [⏮] repeatedly to go back to a previous message.	Press [1] once to go to the beginning of the current message. Press [1] repeatedly to go back to a previous message.
Skipping a message	Press [▶▶] to go to the beginning of the next message.	Press [3] to go to the beginning of the next message.
Deleting a message	While a message is playing, press [∅] . The message is permanently deleted.	While a message is playing, press [4] . The message is permanently deleted.
Deleting all messages	While the phone is in standby, press [∅] . When the system asks you to confirm, press [∅] again. All messages are permanently deleted.	Not available.
Playing old messages	After you listen to your new messages, press [▶/■] again to play your old messages.	After you listen to your new messages, press [☒/mute] again to play your old messages.
Ending the message review	Press [▶/■] to stop the message playback and return to standby.	Press [5] to stop the message playback. Press [1] to exit the system and return to standby, or press [2] to restart the message playback.





Screening Calls

From the base	From the handset
<ul style="list-style-type: none"> • While the system is taking the message, simply listen to the caller over the base speaker. • To answer the call and speak to the caller, press [MUTE]. • To mute the call screen and allow the caller to continue leaving the message, press [MUTE]. 	<ul style="list-style-type: none"> • While the systems is recording the message, press [MUTE]. If another handset is screening a call, you will hear a beep and you will not be able to screen the call. • To answer the call and speak to the caller, press [FLASH]. • To mute the call screen and allow the caller to continue leaving the message, press [MUTE] or return the handset to the cradle.

Turning Off the Message Alert Tone

When all new messages are played back, the message alert tone will automatically deactivate. The tone will not deactivate until all new messages are played back. To quickly turn off the tone, press any key on the base.

Operating the Answering System While You Are Away from Home

When you are away from home, you can operate your answering system with any touch-tone telephone.

Setting a security code or Personal Identification Number (PIN)

To operate your answering system when you are away from home, you will need to enter a two-digit security code or Personal Identification Number (PIN). The default security code is 80.

- 1) Press [MENU/SELECT].
- 2) Select the ANSW. SETUP menu, and then the SECURITY CODE submenu.
- 3) Use the number keypad ([0] through [9]) to enter a two-digit security code (00-99).
- 4) Press [MENU/SELECT]. You will hear a confirmation tone.

Dialing in to your answering system

Note: If you enter an incorrect security code/PIN three times, you will hear a beep and the answering system will return to standby.





To operate from a remote location, use any touch-tone telephone, and follow these steps:

- 1) Call your telephone number and wait for the system to answer. If the answering system is off, it will answer after about fifteen rings and sounds a series of beeps.
- 2) During the greeting or the beeps (if answering system is off), press **[#]** and enter your security code/PIN within two seconds.
- 3) The answering system announces the current time and the number of messages stored in memory. You hear "To play incoming messages, press pound-two. For help, press pound-zero" followed by a beep.
- 4) Enter a remote command from the chart below. You have fifteen seconds to enter the first command; after the first command, you have two seconds to enter each command.

If you want to	Press	If you want to	Press
Play incoming messages	[#] then [2] The answering system plays back messages for four minutes, then waits for another command. To continue playing your messages, press [#] then [2] again.	Stop the current operation to enter a different command.	[#] then [5]
Repeat this message	[#] then [1] after the first four seconds of this message	Turn the answering system off	[#] then [9]
Go back to the previous message	[#] then [1] during the first four seconds of a message	Turn the answering system on	[#] then [6]
Skip this message	[#] then [3]	Listen to the help prompts	[#] then [0]
Delete this message	[#] then [4]	Exit the system	Hang up.

- 5) When you finish, you will hear intermittent beeps indicating that the system is in the command waiting mode. Enter another command from the chart within fifteen seconds.
- 6) Hang up to exit the system. The answering system automatically returns to its normal standby setting.



Maintenance

Specifications

Operating temperature	32° F to 122° F (0° C to 50° C)		
AC adapter		Base	Charging cradle
	Part number	AAD-041S(M)	AAD-600S(M)
	Input voltage	240V AC, 50Hz	240V AC, 50Hz
	Output voltage	9V DC @ 350mA	9V DC @ 210mA
Battery pack	Part number	BT-446	
	Capacity	800mAh, 3.6V DC	

Notes:

- Use only the supplied AC adapters.
- Be sure to use the proper adapter for the base and any chargers.
- Do not place the power cord where it creates a trip hazard or where it could become chafed and create a fire or electrical hazard.
- Do not place the base in direct sunlight or subject it to high temperatures.

Battery Information

Battery life

With average use, your handset battery provides approximately six hours of talk time and approximately ten days of standby time. You can achieve optimum battery life and performance by returning the handset to the base or charging cradle after each use. When your handset is left off of the cradle, the battery will gradually discharge even if the handset is not being used. The actual talk time duration will be reduced in proportion to the amount of time the handset is off of the cradle.



Low battery alert

When the battery pack is very low, the phone is programmed to eliminate functions in order to save power. When LOW BATTERY CHARGE HANDSET appears in the handset display and the phone is in standby, none of the keys will operate. If you are on a call, complete your conversation as quickly as possible, and return the handset to the cradle.

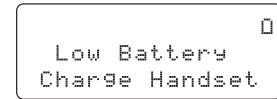

The battery pack needs to be charged when the empty battery icon appears.

Cleaning the charging contacts

To maintain a good charge, clean the charging contacts on the handset once a month. Dampen a cloth with plain water. Gently rub the damp cloth over the charging contacts until all visible dirt is removed. Dry the contacts thoroughly before returning the handset to the cradle.

Caution: Do not use paint thinner, alcohol, or other chemical products. Doing so may discolor the surface of the telephone and damage the finish.

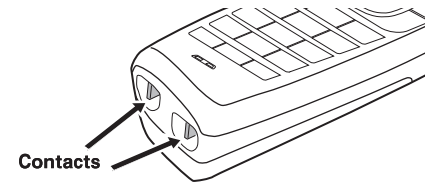

Battery replacement and handling

With average use, your phone's battery should last approximately one year. To order replacement batteries, please contact Uniden's Parts Department. The contact information is listed on the back cover page.

Caution:

- Use only battery pack BT-446.
- Do not remove the batteries from the handset to charge them.
- Never throw the battery into a fire, disassemble, or heat them.
- Do not remove or damage the battery casing.

Power Failures

During a power failure, you will not be able to make or receive calls with the phone. To avoid damage from an electrical spike when the power comes back on, we recommend you unplug your phone during power outages.



Troubleshooting

Common Issues

If your phone is not performing to your expectations, please try these simple steps first. If these steps do not solve your problem, please visit www.uniden.com.au for Australian models and www.uniden.co.nz for New Zealand models for customer support.

When you have this problem...	Try...
The charge LED won't illuminate when the handset is placed in the cradle.	<ul style="list-style-type: none"> • Checking the AC adapter connection (see page 7). • Re-seating the handset in the cradle. • Cleaning the charging contacts on the handsets (see page 51).
The audio sounds weak.	<ul style="list-style-type: none"> • Moving the handset closer to the base. • Moving the handset and/or base away from metal objects or appliances and try again.
No handsets can make or receive calls.	<ul style="list-style-type: none"> • Checking the telephone cord connection. If CHECK TEL LINE appears on the base or handset display, the telephone cord may not be connected correctly (see page 9). • Disconnecting the base AC adapter. Wait a few minutes, then reconnect it (see page 7).

When you have this problem...	Try...
<p>A single handset can't make or receive calls (but other handsets can).</p>	<ul style="list-style-type: none"> • Checking the battery pack connection (see page 6). • Charging the battery for 15 to 20 hours. • Moving the handset closer to the base. • Making sure the line is not in use. If an outside call is already using a line, you cannot use that line to make another outside call. • Resetting the handset (see page 55). • Changing the handset to base code (see page 57).
<p>A handset can make calls, but it doesn't ring or receive a page.</p>	<ul style="list-style-type: none"> • Making sure the ringer isn't turned off (see page 35).
<p>Severe noise interference.</p>	<ul style="list-style-type: none"> • Keeping all handsets away from microwave ovens, computers, wireless LAN station, remote control toys, wireless microphones, alarm systems, intercoms, room monitors, fluorescent lights, and electrical appliances (see page 5). • Moving the base to another location or turn off the source of interference.
<p>The Caller ID does not display.</p>	<ul style="list-style-type: none"> • Checking to see if the call was placed through a switchboard. • Asking your telephone company to verify your Caller ID service is current. There may be a problem with your Caller ID service.
<p>I can't register the handset at the base.</p>	<ul style="list-style-type: none"> • Charging the battery for 15 to 20 hours. • Resetting the handset (see page 55). • Changing the handset to base code (see page 57).
<p>The handset doesn't communicate with other handsets.</p>	<ul style="list-style-type: none"> • Making sure that you have registered all handsets (see page 12). • Changing the handset to base code (see page 57).

When you have this problem...	Try...
I can't join the conversation.	<ul style="list-style-type: none"> • Checking to see that there are not two handsets already using the conference feature (see page 37). • Checking to see that another handset is not in privacy mode (see page 39). • Making sure that you have registered all handsets (see page 12). • Changing the handset to base code (see page 57).
The answering system does not work.	<ul style="list-style-type: none"> • Checking the AC adapter connection (see page 7). • Checking to see if the answering system is turned on (see page 46).
The answering system does not record any messages.	<ul style="list-style-type: none"> • The memory may be full. Delete some or all of the saved messages (see page 47). • Checking to see that the message record time is not set to announce only (see page 44).
The answering system doesn't say what time messages were recorded.	<ul style="list-style-type: none"> • Checking to see if you have set the time (see page 44).
Messages are incomplete.	<ul style="list-style-type: none"> • The incoming messages may be too long. Ask callers to leave a brief message. • The memory may be full. Delete some or all of the saved messages (see page 47).
I can't hear base or handset speaker during call screening or message playback.	<ul style="list-style-type: none"> • Adjusting the speaker volume on the base or handset (see page 36). • Checking to see if the call screen feature is set to on (see page 45).
I can't access answering system from a remote phone.	<ul style="list-style-type: none"> • Checking to see if you are using the correct PIN number (see page 48). • Checking to see if the touch-tone phone you're using can transmit the tone for at least two seconds. If it cannot, try using a different touch-tone phone.

Resetting the Handset

You may need to reset your handset in the following instances:

- You lose a handset and purchase a new one.
- You get the message Registration Failed when you try to register the handset.
- You are unable to register any handsets to the base.
- When you register new handsets to the base, the handset IDs do not match. (For example, the handset registers as “Handset #4” but you only have two handsets.)
- When you are instructed to by one of Uniden’s call center representatives.

- 1) Press and hold **[*]]** and **[#]** for more than five seconds. Select DEREGISTER HS.
- 2) Select the handset which you are operating, and then press **[menu/select]**.
- 3) The phone will ask you to confirm the deregistration. Select YES. The selected handset will clear its registration information only from the base it is currently connected to, and then delete the link to the base from its own memory.
- 4) When the base information is deleted, the handset displays HANDSET NOT REGISTERED-PLACE HANDSET ON BASE TO REGISTER. SEE YOUR OWNER'S MANUAL FOR HELP.
- 5) Re-register the handset to the base (see Registering accessory handsets on page 12).

If the handset cannot contact the base, it will display OUT OF RANGE. Make sure the handset is in range of the base and the base is connected to power; you can also reset the handset without the base (see the next section).

Resetting the Handset Without the Base

If your original base is not available for some reason, you can still reset the handset and use it with another base.

- 1) Press and hold **[*]** and **[#]** for at least five seconds.
- 2) Move the cursor to select **BASE UNAVAILABLE** and then press **[menu/select]**. **BASE UNAVAILABLE** appears.
- 3) Move the cursor to select **YES**, and then press **[menu/select]**. You hear a confirmation tone, and the handset deletes its own base information without contacting the base. The handset displays **HANDSET NOT REGISTERED-PLACE HANDSET ON BASE TO REGISTER. SEE YOUR OWNER'S MANUAL FOR HELP.**
- 4) Register the handset to the new base (see Registering accessory handsets on page 12).

Changing the Handset to Base Code

Your phone ships with a special identification code to connect any registered handsets to this particular base. Normally, you will never have to change this handset to base code, but in the rare situation that you suspect another cordless telephone is using the same code or if you are instructed to change this code by a manufacturer's Call Center Representative, you can change the code. To change the handset to base code:

- 1) Reset all of your handsets (see Resetting the Handset on page 55).
- 2) Re-register each handset (see Registering accessory handsets on page 12).

Changing the Line Mode for Multiple Extensions

Line mode refers to the method that telephones use to signal each other that an extension is in use. Customer service may recommend changing the line mode if you have any of the following problems:

- Your phone keeps ringing after someone answers on an extension phone.
- Your answering system doesn't stop recording when you answer on an extension phone.
- Caller ID displays briefly and then clears.

- 1) Press **[menu/select]**.
- 2) Select the GLOBAL SETUP menu, and then the SET LINE MODE submenu.
- 3) IF INSTRUCTED BY CUSTOMER SERVICE PRESS [SELECT] appears. Press **[menu/select]**.
- 4) Move the cursor to select TYPE - A, TYPE - B, or OFF.
- 5) Press **[menu/select]**. You will hear a confirmation tone.

Traveling Out of Range

When the handset is in standby, the handset will display OUT OF RANGE.

During a call, if you move your handset too far from your base, noise may increase. If you pass the range limit of the base, the handset will beep, display OUT OF RANGE, and then go to standby. The base will maintain the connection for thirty seconds after the handset goes out of range. If you move the handset back within range of the base within thirty seconds, press **[flash]** or **[mute]** to pick up the call again.

Precautions!

Before you read anything else, please observe the following:

Warning!

Uniden Australia Pty Ltd and Uniden NZ Ltd DO NOT represent this unit to be waterproof. To reduce the risk of fire, electrical shock, or damage to the unit, DO NOT expose this unit to rain or moisture.

Rechargeable Nickel-Metal-Hydride Battery Warning

- This equipment contains a rechargeable Nickel-Metal-Hydride battery.
- The rechargeable batteries contained in this equipment may explode if disposed of in a fire.
- Do not short-circuit the battery.
- Do not charge the rechargeable battery pack used in this equipment with in any charger other than the one designed to charge this battery pack as specified in the owner's manual. Using another charger may damage the battery pack or cause the battery pack to explode.

Rechargeable Batteries Must Be Recycled or Disposed of Properly.

Uniden works to reduce lead content in our PVC coated cords in our products and accessories.

Important Safety Instructions

When using your telephone equipment, basic safety precautions should always be followed to reduce the risk of fire, electric shock and injury to persons, including the following:

1. Do not use this product near water, for example, near a bath tub, wash bowl, kitchen sink or laundry tub, in a wet basement or near a swimming pool.
2. Avoid using a telephone (other than a cordless type) during an electrical storm. There may be a remote risk of electric shock from lightning.
3. Do not use the telephone to report a gas leak in the vicinity of the leak.
4. Use only the power cord and batteries indicated in this manual. Do not dispose of batteries in a fire. They may explode. Check with local authorities for possible battery disposal instructions.
5. Do not disassemble any component of this product.

SAVE THESE INSTRUCTIONS

CAUTION

Risk of explosion if battery is replaced by an incorrect type. Dispose of used batteries according to the instructions. Do not open or mutilate the battery, and disconnect the battery before shipping this product.

Memo

Memo

Memo

Index

A

Accessory handsets	12
Answering calls	30
Answering system	
Reviewing messages	47
Setting up	42
Turning on/off	46
When away from home	48
Any key answer	29
Audio tone	36
AutoTalk	29

B

Banner	28
Base	
Installing	7
Parts of the base	18
Reading the display	19
Wall mounting	13
Battery	
Battery life	50
Installing	6
Low battery alert	51
Replacement and handling	51
Belt clip	11

C

Caller ID	32
Deleting Caller ID records	33
Making calls from	32
Call screening	45, 48
Call waiting	33
Chain dialing	31
Conferencing	37

D

Day and time	44
--------------------	----

F

Finding a handset	37
Four-way function key	20

G

Greetings	
Deleting	43
Recording	42
Selecting	42

H

Handset	
Accessory handsets	12
Banner	28
Choosing a ringer	28
Copying phonebook entries	27

Entering text	21
Finding	37
Keylock	29
Parts of the handset	17
Reading the display	19
Registering	12
Resetting	55, 56
Handset to base code	57
Hanging up	30
Headset	41
Hold	37

I

Installation	5
Intercom	39

K

Key touch tone	22
----------------------	----

L

Line mode for base	57
Low battery alert	51

M

Maintenance	50
Making calls	30
Using Caller ID	32
Using redial	34

- Using the phonebook..... 31
 - Message alert..... 45, 48
 - Mute
 - Microphone..... 40
 - Ringer..... 35
- O**
- Out of range..... 57
- P**
- Personal identification
 - number (PIN)..... 48
 - Personal ring 22, 25
 - Phonebook 24
 - Copying entries..... 27
 - Creating new entries..... 24
 - Deleting entries..... 26
 - Editing entries..... 25
 - Finding entries..... 25
 - Making a call from 31
 - Storing Caller ID or redial numbers..... 26
 - Privacy mode..... 39
- R**
- Redial
 - Deleting a record 34
 - Making a calls with 34
- Ringer
 - Choosing a handset ringer 28
 - Muting..... 35
 - Personal ring 22, 25
 - Volume..... 35
- S**
- Screening calls 45, 48
 - Security code..... 48
- T**
- Text, entering..... 21
 - Transferring a call 38
 - Troubleshooting 52
- V**
- Volume, adjusting 35
- W**
- Wall mounting the base 13
 - Warranty 66

Remote Operation Card

<p style="text-align: center;">CUT</p> <p style="text-align: center;">REMOTE OPERATION CARD</p> <p style="text-align: right;">Uniden®</p> <hr/> <table><tr><td data-bbox="200 281 467 502"><p>Remote access away from home</p><ol style="list-style-type: none">1. Call your phone number from a touch-tone phone.2. During the outgoing message, press # and enter your PIN code. The answering system announces the number of messages stored in memory and the voice prompts.3. To quit, hang up the phone.</td><td data-bbox="482 281 719 480"><p>Turn on the answering system remotely</p><ol style="list-style-type: none">1. Call your phone and let it ring 15 times until you hear a beep.2. Press # and then enter your PIN code.3. Press # then 5 to stop the announcement.4. Press # then 6 to turn the answering system on.</td></tr></table>	<p>Remote access away from home</p> <ol style="list-style-type: none">1. Call your phone number from a touch-tone phone.2. During the outgoing message, press # and enter your PIN code. The answering system announces the number of messages stored in memory and the voice prompts.3. To quit, hang up the phone.	<p>Turn on the answering system remotely</p> <ol style="list-style-type: none">1. Call your phone and let it ring 15 times until you hear a beep.2. Press # and then enter your PIN code.3. Press # then 5 to stop the announcement.4. Press # then 6 to turn the answering system on.	<p style="text-align: center;">CUT</p> <p style="text-align: center;">REMOTE OPERATION CARD</p> <p style="text-align: right;">Uniden®</p> <hr/> <table><tr><td data-bbox="768 281 1035 502"><p>Remote access away from home</p><ol style="list-style-type: none">1. Call your phone number from a touch-tone phone.2. During the outgoing message, press # and enter your PIN code. The answering system announces the number of messages stored in memory and the voice prompts.3. To quit, hang up the phone.</td><td data-bbox="1050 281 1288 480"><p>Turn on the answering system remotely</p><ol style="list-style-type: none">1. Call your phone and let it ring 15 times until you hear a beep.2. Press # and then enter your PIN code.3. Press # then 5 to stop the announcement.4. Press # then 6 to turn the answering system on.</td></tr></table>	<p>Remote access away from home</p> <ol style="list-style-type: none">1. Call your phone number from a touch-tone phone.2. During the outgoing message, press # and enter your PIN code. The answering system announces the number of messages stored in memory and the voice prompts.3. To quit, hang up the phone.	<p>Turn on the answering system remotely</p> <ol style="list-style-type: none">1. Call your phone and let it ring 15 times until you hear a beep.2. Press # and then enter your PIN code.3. Press # then 5 to stop the announcement.4. Press # then 6 to turn the answering system on.
<p>Remote access away from home</p> <ol style="list-style-type: none">1. Call your phone number from a touch-tone phone.2. During the outgoing message, press # and enter your PIN code. The answering system announces the number of messages stored in memory and the voice prompts.3. To quit, hang up the phone.	<p>Turn on the answering system remotely</p> <ol style="list-style-type: none">1. Call your phone and let it ring 15 times until you hear a beep.2. Press # and then enter your PIN code.3. Press # then 5 to stop the announcement.4. Press # then 6 to turn the answering system on.				
<p>Remote access away from home</p> <ol style="list-style-type: none">1. Call your phone number from a touch-tone phone.2. During the outgoing message, press # and enter your PIN code. The answering system announces the number of messages stored in memory and the voice prompts.3. To quit, hang up the phone.	<p>Turn on the answering system remotely</p> <ol style="list-style-type: none">1. Call your phone and let it ring 15 times until you hear a beep.2. Press # and then enter your PIN code.3. Press # then 5 to stop the announcement.4. Press # then 6 to turn the answering system on.				
<p style="text-align: center;">CUT</p> <p style="text-align: center;">REMOTE OPERATION CARD</p> <p style="text-align: right;">Uniden®</p> <hr/> <table><tr><td data-bbox="200 669 467 889"><p>Remote access away from home</p><ol style="list-style-type: none">1. Call your phone number from a touch-tone phone.2. During the outgoing message, press # and enter your PIN code. The answering system announces the number of messages stored in memory and the voice prompts.3. To quit, hang up the phone.</td><td data-bbox="482 669 719 868"><p>Turn on the answering system remotely</p><ol style="list-style-type: none">1. Call your phone and let it ring 15 times until you hear a beep.2. Press # and then enter your PIN code.3. Press # then 5 to stop the announcement.4. Press # then 6 to turn the answering system on.</td></tr></table>	<p>Remote access away from home</p> <ol style="list-style-type: none">1. Call your phone number from a touch-tone phone.2. During the outgoing message, press # and enter your PIN code. The answering system announces the number of messages stored in memory and the voice prompts.3. To quit, hang up the phone.	<p>Turn on the answering system remotely</p> <ol style="list-style-type: none">1. Call your phone and let it ring 15 times until you hear a beep.2. Press # and then enter your PIN code.3. Press # then 5 to stop the announcement.4. Press # then 6 to turn the answering system on.	<p style="text-align: center;">CUT</p> <p style="text-align: center;">REMOTE OPERATION CARD</p> <p style="text-align: right;">Uniden®</p> <hr/> <table><tr><td data-bbox="768 669 1035 889"><p>Remote access away from home</p><ol style="list-style-type: none">1. Call your phone number from a touch-tone phone.2. During the outgoing message, press # and enter your PIN code. The answering system announces the number of messages stored in memory and the voice prompts.3. To quit, hang up the phone.</td><td data-bbox="1050 669 1288 868"><p>Turn on the answering system remotely</p><ol style="list-style-type: none">1. Call your phone and let it ring 15 times until you hear a beep.2. Press # and then enter your PIN code.3. Press # then 5 to stop the announcement.4. Press # then 6 to turn the answering system on.</td></tr></table>	<p>Remote access away from home</p> <ol style="list-style-type: none">1. Call your phone number from a touch-tone phone.2. During the outgoing message, press # and enter your PIN code. The answering system announces the number of messages stored in memory and the voice prompts.3. To quit, hang up the phone.	<p>Turn on the answering system remotely</p> <ol style="list-style-type: none">1. Call your phone and let it ring 15 times until you hear a beep.2. Press # and then enter your PIN code.3. Press # then 5 to stop the announcement.4. Press # then 6 to turn the answering system on.
<p>Remote access away from home</p> <ol style="list-style-type: none">1. Call your phone number from a touch-tone phone.2. During the outgoing message, press # and enter your PIN code. The answering system announces the number of messages stored in memory and the voice prompts.3. To quit, hang up the phone.	<p>Turn on the answering system remotely</p> <ol style="list-style-type: none">1. Call your phone and let it ring 15 times until you hear a beep.2. Press # and then enter your PIN code.3. Press # then 5 to stop the announcement.4. Press # then 6 to turn the answering system on.				
<p>Remote access away from home</p> <ol style="list-style-type: none">1. Call your phone number from a touch-tone phone.2. During the outgoing message, press # and enter your PIN code. The answering system announces the number of messages stored in memory and the voice prompts.3. To quit, hang up the phone.	<p>Turn on the answering system remotely</p> <ol style="list-style-type: none">1. Call your phone and let it ring 15 times until you hear a beep.2. Press # and then enter your PIN code.3. Press # then 5 to stop the announcement.4. Press # then 6 to turn the answering system on.				



CUT

Task	Key
Repeat a Message	#oper 1
Play Incoming Messages	#oper 2 abc
Skip a Message	#oper 3 def
Delete a Message	#oper 4 ghi
Stop Operation	#oper 5 jkl
Answering System On	#oper 6 mno
Answering System Off	#oper 9 wxyz
Help	#oper 0 oper

CUT

Task	Key
Repeat a Message	#oper 1
Play Incoming Messages	#oper 2 abc
Skip a Message	#oper 3 def
Delete a Message	#oper 4 ghi
Stop Operation	#oper 5 jkl
Answering System On	#oper 6 mno
Answering System Off	#oper 9 wxyz
Help	#oper 0 oper

CUT

Task	Key
Repeat a Message	#oper 1
Play Incoming Messages	#oper 2 abc
Skip a Message	#oper 3 def
Delete a Message	#oper 4 ghi
Stop Operation	#oper 5 jkl
Answering System On	#oper 6 mno
Answering System Off	#oper 9 wxyz
Help	#oper 0 oper

CUT

Task	Key
Repeat a Message	#oper 1
Play Incoming Messages	#oper 2 abc
Skip a Message	#oper 3 def
Delete a Message	#oper 4 ghi
Stop Operation	#oper 5 jkl
Answering System On	#oper 6 mno
Answering System Off	#oper 9 wxyz
Help	#oper 0 oper

ONE YEAR LIMITED WARRANTY

UNIDEN DSS8955, DSS8955+1, DSS8955+2 and DSS8955+3

IMPORTANT : Evidence of original purchase is required for warranty service.

WARRANTOR : Uniden Australia Pty Limited
A.B.N. 58 001 865 498
Uniden New Zealand Limited

Warranty only available in original country of purchase.

ELEMENT OF WARRANTY :

Uniden warrants to the original retail owner for the duration of this warranty, its DSS8955, DSS8955+1, DSS8955+2 or DSS8955+3 (herein after referred to as the Product), to be free from defects in materials and craftsmanship with only the limitations or exclusions set out below.

WARRANTY DURATION:

This warranty to the original retail owner only, shall terminate and be of no further effect ONE (1) year after the date of original retail sale. This warranty will be deemed invalid if the Product is;

- (A) Damaged or not maintained as reasonable and necessary,
- (B) Modified, altered or used as part of any conversion kits, subassemblies, or any configurations not sold by Uniden,
- (C) Improperly installed,
- (D) Repaired by someone other than an authorized Uniden Repair Agent for a defect or malfunction covered by this warranty,
- (E) Used in conjunction with any equipment or parts or as part of a system not manufactured by Uniden, or
- (F) Where the Serial Number label of the product has been removed or damaged beyond recognition.

Warranty only valid in the country of original retail/sale.

PARTS COVERED:

This warranty covers for one (1) year, the Product and included accessories.

STATEMENT OF REMEDY:

In the event that the Product does not conform to this warranty at any time while this warranty is in effect, the warrantor at its discretion, will repair the defect or replace the Product and return it to you without charge for parts or service. This warranty does not provide for reimbursement or payment of incidental or consequential damages.

This EXPRESS WARRANTY is in addition to and does not in any way affect your rights under the TRADE PRACTICES ACT 1974 (Cth) (Australia) or the CONSUMER GUARANTEES ACT (New Zealand).

PROCEDURE FOR OBTAINING PERFORMANCE OR WARRANTY:

In the event that the Product does not conform to this warranty, the Product should be shipped or delivered, freight pre-paid, with evidence of original purchase (e.g. a copy of the sales docket), to the warrantor at:

UNIDEN AUSTRALIA PTY LIMITED

SERVICE DIVISION

345 Princes Highway, Rockdale NSW 2216

Fx(02) 9599 3278

www.uniden.com.au

UNIDEN NEW ZEALAND LIMITED

SERVICE DIVISION

150 Harris Road, East Tamaki, Auckland

Fx(09) 274 4253

www.uniden.co.nz

Customers in other States should ship or deliver the Product freight pre-paid to their nearest Uniden Authorized Repair Centre (Contact Uniden for the nearest Warranty Agent to you).



Uniden[®]

© 2008 Uniden Australia Pty Limited/Uniden New Zealand Limited
Printed in China UPZZ01906BZ(0)

Free Manuals Download Website

<http://myh66.com>

<http://usermanuals.us>

<http://www.somanuals.com>

<http://www.4manuals.cc>

<http://www.manual-lib.com>

<http://www.404manual.com>

<http://www.luxmanual.com>

<http://aubethermostatmanual.com>

Golf course search by state

<http://golfingnear.com>

Email search by domain

<http://emailbydomain.com>

Auto manuals search

<http://auto.somanuals.com>

TV manuals search

<http://tv.somanuals.com>