

uniden®

UHF CB TRANSCEIVER

OWNER'S MANUAL

SUNDOWNER UH-099 SCANNING

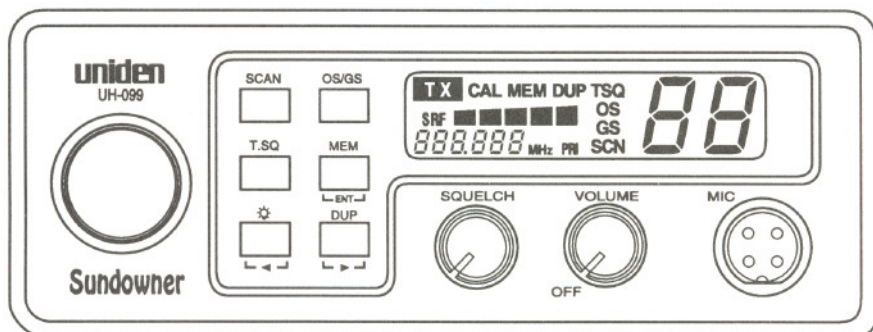

With Built-in SELCALL

Contents

| | |
|--|-----------|
| Controls/Indicators/Connections | 2 |
| Front Panel Controls | 2 |
| Front Panel Indicators | 3 |
| Microphone | 4 |
| Back Panel | 5 |
| Getting Started | 6 |
| Mobile Station Installation | 6 |
| Choosing an Antenna | 6 |
| Ground System | 6 |
| Operation | 7 |
| How to Receive | 7 |
| How to Transmit | 7 |
| Scanning | 8 |
| Programming Scan Channels | 8 |
| Removing Group Scan Channels | 9 |
| Open Scanning | 9 |
| Group Scanning | 10 |
| Receiving a Signal on a Group Scan Channel | 10 |
| Removing Open Scan Channels | 11 |
| Reinstalling Channels into the Scan Group | 12 |
| Selective Calling | 13 |
| Outline | 13 |
| Receiver Quieting | 14 |
| Call Receiving | 14 |
| Tone Squelch Scanning | 14 |
| Tone Calling | 15 |
| 5/6 Tone TX SELCALL Programming | 16 |
| Group Calling | 17 |
| 5/6 Tone SELCALL Programming | 19 |
| Receiver SELCALL ID | 20 |
| Tone Period | 22 |
| Lead-in Delay | 24 |
| Lead-in Tone | 25 |
| Alarm Mode | 27 |
| Care and Maintenance | 29 |
| Notice | 29 |
| Preventive Maintenance | 29 |
| Troubleshooting | 29 |
| Memory Backup | 29 |
| UHF Channel Information | 30 |
| Specifications | 32 |
| Warranty | 35 |

Controls/Indicators/Connections

Front Panel Controls

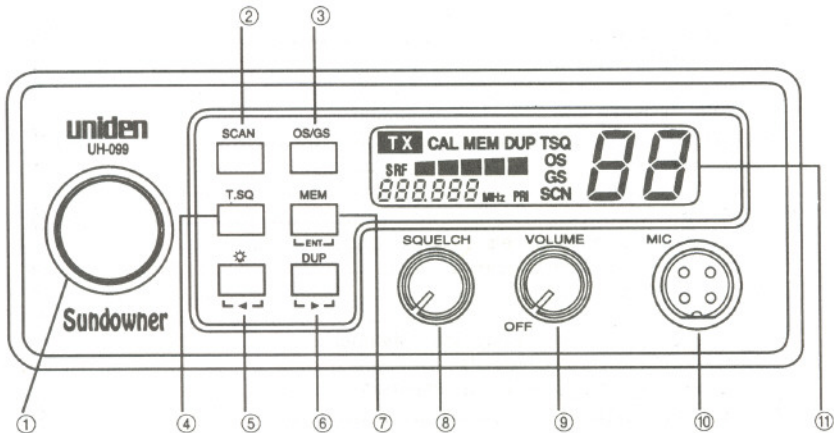

- 1. CHANNEL SELECTOR**
Selects the desired channel for transmission and reception.
- 2. SCAN CONTROL (SCAN)**
Scans channels programmed in the selected **SCAN** mode.
NOTE: The radio will not scan if the selected Scan Memory has not been programmed.
- 3. OPEN SCAN/GROUP SCAN CONTROL (OS/GS)**
Selects the desired **SCAN** mode. Press the button once to toggle between OPEN SCAN and GROUP SCAN modes.
- 4. TONE SQUELCH CONTROL (T.SQ)**
Turns on or off the T.SQ channel memory when the button is pressed for 1.5 seconds. (Any channel can be set.)
- 5. BACKLIGHT CONTROL (☀/☾)**
Changes the backlight intensity to BRIGHT, MEDIUM or OFF when the button is momentarily pressed. Changes the backlight color to either green or amber when the ☾ button is pressed for 1.5 seconds.
- 6. DUPLEX CONTROL**
Programs semi-duplex operations for channels 1 through 8.
- 7. MEMORY CONTROL (MEM)**
Places channel numbers into the memory scan list (OS or GS), when pressed for 1.5 seconds while in the **NORMAL** mode, and removes channel numbers from the memory list when pressed again for 1.5 seconds.

8. **SQUELCH CONTROL**
Eliminates received background noise in the absence of an incoming signal. Turn the control knob fully counter-clockwise and then slowly rotate clockwise until the received noise is eliminated.
9. **VOLUME CONTROL**
Turns the radio on and increases the volume level when turned clockwise. Decreases the volume level and turns the radio off when turned counterclockwise.
10. **MICROPHONE SOCKET**
The microphone plug is inserted into this socket.
11. **LIQUID CRYSTAL DISPLAY (LCD)**
Uses several indicators to show the current operational mode. The two digits at the right indicate the selected channel. The smaller two and three letter displays indicate which feature is currently active.

FRONT PANEL INDICATORS



TX INDICATOR (TX)

The "TX" and "RF" icons appear during transmission.

CAL INDICATOR (CAL)

The "CAL" icon appears when an incoming tone code successfully opened the Tone Squelch, or when TX SELCALL codes are being transmitted.

MEMORY INDICATOR (MEM)

In the normal mode (Scan Mode Off) the "MEM" icon appears when the channel indicated by the CHANNEL INDICATOR is programmed in the selected scan memory.

DUPLEX INDICATOR (DUP)

The "DUP" icon appears when the Duplex Channel Operation is selected.

SIGNAL/RF LEVEL INDICATOR

Indicates the relative signal strength level (S) when receiving, or the relative TX power (RF) level when transmitting.

TOPE SQUELCH INDICATOR (TSQ)

The "TSQ" icon appears when the Tone Squelch has been activated.

OPEN SCAN INDICATOR (OS)

The "OS" icon appears when the Open Scan Mode is selected.

GROUP SCAN INDICATOR (GS)

The "GS" icon appears when the Group Scan Mode is selected.

SCAN INDICATOR (SCAN)

The "SCN" icon appears when Scan is activated.

PRIORITY INDICATOR (PRI)

The "PRI" icon appears only when in the GS Mode and Scanning, either when the PRI channel becomes active or when the channel knob is rotated to select a new PRI channel.

Microphone

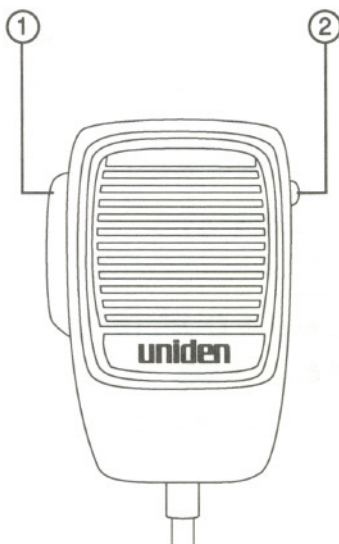

1. **PRESS-TO-TALK Button**

Use the **PRESS-TO-TALK** button on the microphone to receive and transmit. Press the button to activate the transmitter and release the button to receive. When transmitting, hold the microphone about two inches from your mouth and speak clearly in a normal voice.

2. **TONE CALL CONTROL (CALL) Button**

Use the **TONE CALL CONTROL (Call)** button to check, edit, or transmit the TX Selcall ID. Press the button once and the Selcall ID will be displayed. Under this condition you can change the Selcall ID (See page 16 for TX SELCALL ID Programming). To abort, momentarily press the Call button again. If you want to transmit the existing code, press and hold the Call button for more than 1.5 seconds.

Back Panel

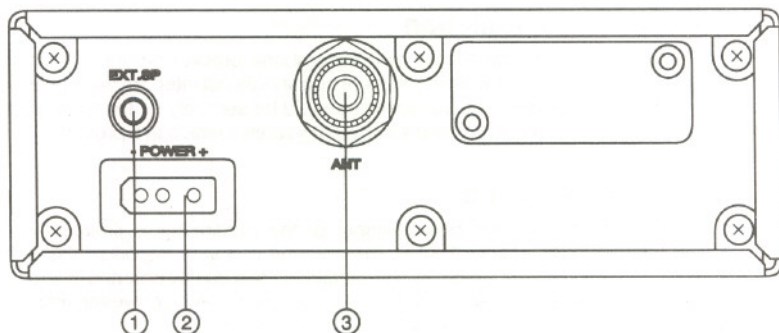

- 1. EXTERNAL SPEAKER JACK (EXT.SP)**
Used for remote receiver monitoring. When the external speaker is connected the internal speaker is automatically disconnected.
- 2. POWER**
DC power is connected to the transceiver through this jack. A power cord is supplied with the transceiver.
- 3. ANTENNA CONNECTOR (ANT)**
The transmission line cable plug connector (M-type) is connected to the transceiver through this antenna connector socket.

Getting Started

Mobile Station Installation

Select the location of the transceiver and microphone bracket before starting the installation. The location should be convenient and should not interfere with the driver or passenger in the vehicle. The transceiver should be securely fastened to a solid face, using the mounting bracket and self-tapping screws which are provided.

Choosing an Antenna

Since the maximum allowable power output of the transmitter is limited by the Spectrum Management Agency (SMA), the antenna is a very important factor for transmission distance. For this reason, the installation of a quality antenna is strongly recommended. The Sundowner UH-099 is a superior transceiver, however, installing an inferior antenna may cause a reduction in performance.

Only a properly matched antenna system will allow maximum power transfer from the 50-ohm transmission line to the radiating element. Your Uniden dealer is qualified to assist you in the selection of a compatible antenna to meet your application requirements.

For automobile installation, the whip antenna is recommended. The most efficient and practical installation is a full quarter wave whip antenna mounted on the rear deck midway between the rear window and bumper.

A short "loaded" whip antenna is easier to install on an automobile. However it is not as efficient as a full quarter wave whip antenna.

For marine installation, consult your dealer for information regarding an adequate grounding system and prevention of electrolysis between fittings in the hull and the water.

Ground System

Connect the red DC power cord from the transceiver to the positive (+) battery terminal or another convenient point and connect the black power lead to the vehicle frame, or the negative (-) battery terminal.

Operation

How to Receive

1. Confirm that the power source, antenna, and microphone are connected properly before proceeding to the following steps.
2. Turn the unit **ON** by rotating the **VOLUME** control clockwise.
3. Set the **CHANNEL CONTROL** knob to the desired channel.
4. Set the **VOLUME** control to a comfortable listening level.
5. Listen to the background noise from the speaker. Turn the **SQUELCH** control slowly clockwise just until the noise is eliminated (no signal should be present). Leave the control at this setting. The **Squelch** is now properly adjusted. The receiver will remain quiet until a signal is actually received. Do not advance the control too far, or some of the weaker signals will not be heard.

How to Transmit

1. Carefully read the SMA Rules and Regulations prior to operating the transmitter.
2. Select the desired channel.
3. To transmit, press the **PRESS-TO-TALK** button on the microphone. Hold the microphone 2-4 inches from your mouth and slightly to one side so that your voice does not project directly into the microphone (this provides the best results). Speak at a normal level. Never raise your voice or shout into the microphone. Whenever the **PRESS-TO-TALK** button is pressed, the **TX** indicator will light.



The Transceiver Voltage Standing Wave Ratio (V.S.W.R.) measurement must be performed prior to the use of the transmitter. A V.S.W.R. ratio in excess of 2:1 may damage the transmitter.

Scanning

Pressing the **SCAN** button one time will initiate scanning, and scanning is stopped either by pressing the button a second time or pressing the Press-to-Talk button.

Programming Scan Channels

When the radio is initially turned on, there will not be any channels programmed in the Group Scan Memory.

To **Program** scan channels into the Group Scan Memory, use the following procedure:

1. Select the **NORMAL** mode (or when scanning, cancel scanning by pressing the **SCAN** button.)
2. Select the **GROUP SCAN** mode by pressing the **OS/GS** button. The **GS** indicator should appear.
3. Rotate the **CHANNEL SELECTOR** knob until the channel you wish to scan is displayed. Note that the **MEM** indicator should not appear, indicating that this channel is not currently programmed in the **GROUP SCAN** memory.
4. Press and hold the **MEM** button for about 1.5 seconds until a beep is heard. The **MEM** indicator should now appear indicating that the channel is now programmed in memory.
5. Continue steps 3 and 4 to program all the channels you wish to scan.

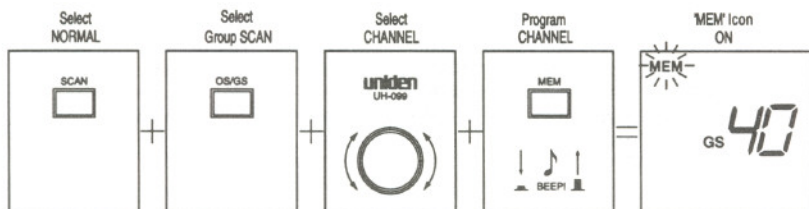

Removing Group Scan Channels

To **Delete** a programmed channel from the Group Scan Memory, use the following procedure:

1. Rotate the **CHANNEL SELECTOR** knob until the channel you wish to remove is displayed. Note that the **MEM** indicator should appear, indicating that this channel is currently programmed in memory.
2. Press and hold the **MEM** button for about 1.5 seconds until a beep is heard twice. The **MEM** indicator should now be off.

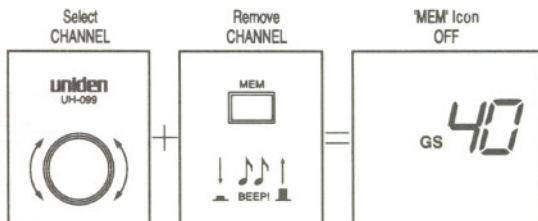

Open Scanning

To commence open scanning, select the **OPEN SCAN** mode by pressing the **OS/GS** button when in GS mode. Then press the **SCAN** button.

The SUNDOWNER UH-099 will commence scanning the programmed channels, and will indicate each channel on the **CHANNEL** indicator as it is scanned.

When a busy channel is found, the radio will 'lock' onto it, and will remain there for as long as the signal is present, and for 3 seconds after the transmission ceases. This allows the SUNDOWNER UH-099 to hold the channel during short breaks in the conversation. Once the channel has remained clear for 3 seconds, the radio will resume scanning.

If you do not wish to listen to a busy channel, you can **SKIP** over it by pressing the **MEM** button on the radio. The receiver will immediately resume scanning.

The **SCAN MODE** will be cleared when the **PRESS-TO-TALK BUTTON** is pressed.

- NOTE:**
1. During the **OPEN SCAN** mode, the **CHANNEL SELECTOR** knob is ignored.
 2. The scan rate in this mode is 0.1 second per channel. In other words, all 40 channels can be scanned in 4 seconds.

Group Scanning

To commence **GROUP SCANNING**, select the **GROUP SCAN** mode by pressing the **OS/GS** button when in the OS mode, and select the **SCAN** mode by momentarily pressing the **SCAN** button.

The SUNDOWNER UH-099 will now scan the programmed channels, displaying each channel number and the **PRIORITY** channel number. Before it scans each channel, it quickly "checks" the **PRIORITY** channel (set by the **CHANNEL SELECTOR**).

- NOTE:**
1. In the GS mode, the starting channel prior to GS Memory Scanning is always set as the Initial PRI Channel.
 2. If the **GROUP SCAN** memory has not been programmed when the **GROUP SCAN** mode is selected and the **SCAN** button has been pressed, the SUNDOWNER UH-099 will emit an error tone.
 3. The **PRIORITY** channel number can easily be read when necessary by:
 - (a) Simply turning the **Squelch** knob counter-clockwise until the squelch opens. After checking, return the **Squelch** knob to the previous position.
 - (b) Pressing the **PRESS-TO-TALK** button, the unit will transmit on the PRI channel and scanning will be cancelled. Press the **SCAN** button to resume scanning.

Receiving a Signal on a Group Scan Channel

If a signal is received on a programmed scan channel, the radio will 'lock' onto that channel **provided there is no signal on the PRIORITY channel**.

When the receiver is 'locked' onto the scan channel, the **LCD** Channel Indicator will switch between the scan channel and the **PRIORITY** channel. This is because the receiver is still 'listening' for signals on the **PRIORITY** channel.

When the scan channel becomes quiet again, the radio will continue to hold the channel for another 3 seconds in order to allow for a natural pause in the conversation before resuming the Group Scanning mode.

If there is a transmission on the **PRIORITY** channel while you are listening to a scan channel, the receiver will immediately transfer to the **PRIORITY** channel and the **PRIORITY** channel number will be displayed.

To **RESUME** scanning, while receiving a signal, momentarily press the **MEM** button on the front panel. The receiver will resume scanning.

To stay on the current active channel, momentarily press the PTT button. The Scan Mode will be cleared.

Removing Open Scan Channels

When the radio is initially turned on, all 40 channels are programmed in the **OPEN SCAN MEMORY**.

If you do not wish to scan some particular channels (e.g. if one or more channels are continually busy and always causing the scanning function to pause), you can remove these channels from the scan group by using the following procedure:

1. Cancel scanning (if active).
2. Select the **OPEN SCAN** mode by pressing the **OS/GS** button when in the **GS** mode. The **OS** indicator should appear. The **GS** indicator should not appear.
3. Rotate the **CHANNEL SELECTOR** knob until the channel you wish to remove is displayed on the **CHANNEL INDICATOR**.

Note that the **MEM** indicator is lit, indicating that this channel is currently included in the scan group.

4. Press and hold the **MEM** button for about 1.5 seconds until a beep is heard twice.

NOTE: The **MEM** indicator is now off.

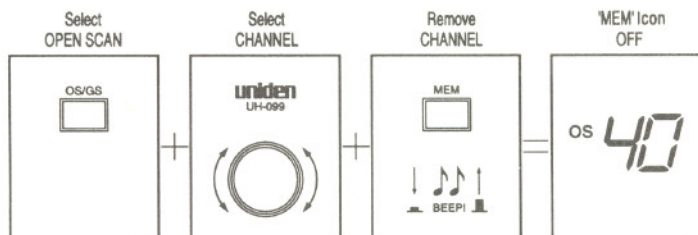

The selected channel has now been removed from the scan group and will not be included when scanning has commenced and the **MEM** indicator will not be displayed on that channel.

Continue steps 3 and 4 to remove any other channels you do not wish to scan.

Reinstalling Channels into the Scan Group

To reinstall previously deleted channels into the scan group, simply repeat steps 3 and 4. However, this time note that a beep will be heard when the **MEM** button is pressed, and the **MEM** indicator will light, indicating that the selected channel is now included in the scan group.

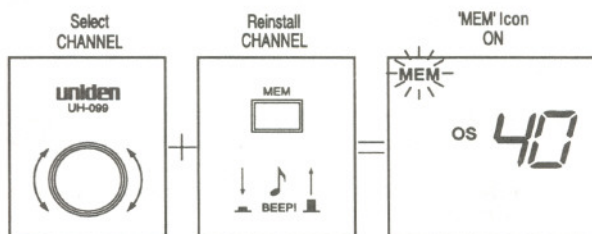

When finished, rotate the **CHANNEL SELECTOR** dial and notice that the **MEM** icon is indicating which channels are programmed and which have been removed.

Selective Calling

Outline

Selective Calling (SELCALL) is a special Sequential Tone Squelch System that allows the user to receive/transmit calls selectively from/to an individual or a group, on a shared busy channel.

The SUNDOWNER UH-099 has a specially built-in Selective Calling (SELCALL) system. Exceptional features like Receiver Quieting, Tone Squelch Scanning, Tone and Group Calling make the SUNDOWNER UH-099 superior to any transceivers in its class.

Receiver Quieting (Tone Squelch)

When activated, automatically mutes the receiver audio circuit of the radio. It will stay in this "Quiet" mode as long as the SELCALL tone code (SELCALL ID) required to open the muting circuit is not received.

Call Alarm

When a received code matches to your Selcall ID, an alarm will be emitted informing you that a caller is on the channel.

Tone Squelch Scanning

Scans only Tone Squelched Channels.

Tone Calling

Allows you to selectively call other radios.

Group Calling Capability

Transmits and Responds to Group Calls.

Receiver Quieting

Puts the receiver in the "Quiet" mode (also known as the "Tone Squelch" mode). When activated, the transceiver prevents any unwanted conversations in the channel from being heard unless the call is specifically directed to you and the SELCALL ID required to open the "Quiet" condition has been received.

To activate:

1. Select the channel you want to put in Quiet mode using the Channel Selector knob.
2. Press the T.SQ button for about 1.5 seconds. One beep is heard and the T.SQ indicator appears on the LCD display. Under this condition, the **PRESS-TO-TALK** button is temporarily disabled. If you wish to use the same channel for normal communication simply remove the channel from Quiet mode.

Note: Channels that are stored in either OS or GS (MEM), when put in the Quiet condition, will be skipped during OS/GS Memory Scanning

If GS Scanning is used and the starting channel is a T.SQ Channel, the PRI Channel will not be set. Rotate the channel knob to set a new PRI channel.

To deactivate the Quiet Condition:

1. Manually select the Tone Squelched Channel.
2. Press the T.SQ button for about 1.5 seconds. Two beeps are heard and the T.SQ indicator disappears from the LCD display.

Call Receiving

While in the T.SQ condition, when UH-099 receives a code matching your SELCALL ID, it will perform the following operations:

1. Automatically responds to the caller by transmitting Acknowledge Tones.
2. Informs you that a caller is on the channel by emitting a CALL ALARM (Default Alarm Setting: four successive beeps in a regular interval for 10 seconds. Refer to "Programming Method" for other alarm settings) and displays the CAL indicator.
3. Flashes the T.SQ indicator for about 20 seconds allowing you to use the **PRESS-TO-TALK** button. If you are not be able to respond within the 20 second period, T.SQ stops flashing and Quiet mode resumes.

Tone Squelch Scanning

If you are using two or more channels in the T.SQ mode, you can monitor all of these channels for selective calls by using the T.SQ Scanning feature.

To use this feature:

Start the T.SQ Scan by pressing the T.SQ button during Open Scan or Group Scan.

Unlike Normal Scanning, T.SQ Scanning checks the detected carrier for SELCALL information. If this information is not found, T.SQ scanning resumes.

When a call is received during T.SQ Scanning, UH-099 follows the same response as when receiving a call on a Tone Squelch Channel. It differs only in the following ways.

1. If the call is not answered within the 20 second period, T.SQ Scanning resumes. The CAL indicator remains on the LCD.

To look for the channel where CALL is received:

- a. Cancel T.SQ Scanning by pressing the Scan button.
- b. Using the Rotary button, browse through the T.SQ Channels.

The CAL indicator marks the channel where the call is received.

2. When answered, T.SQ scanning is automatically deactivated. The channel is removed from the Quiet Operating mode.

To deactivate T.SQ Scanning:

1. Press the T.SQ button. The unit returns to the Normal Scanning Mode, or
2. Press the Scan button. The whole scanning operation is cleared.
3. When a SELCALL is received, press the **PRESS-TO-TALK** button.

Note: The chance of receiving and decoding SELCALLs effectively during T.SQ Scanning can be increased in many different ways. You can either decrease the number of channels to be scanned thus increasing the scanning speed, or change some of the SELCALL parameters (refer to "Other SELCALL Parameters" on page 21).

Be sure that each member of your group uses the same configuration, otherwise, the chance of selectively calling each other will be decreased.

Tone Calling

Tone Calling allows you to selectively call other radios.

To do this, the SELCALL ID of the radio you are going to call should be in the Transmitter's SELCALL ID memory (refer to "5/6 Tone TX SELCALL Programming" on page 16).

To Call:

1. Select the channel that you and your group agreed to use for Selective Calling.
2. Press and hold the Tone Call Button for about 1.5 seconds. One long beep will be heard and the CAL indicator will appear on the LCD display while the SELCALL ID is being transmitted automatically.

An Acknowledge Tone coming from the called radio will be received if you had successfully made contact.

The Acknowledge Tone for the SUNDOWNER UH-099 is a succession of three Low Tone Beeps.

5/6 Tone TX SELCALL Programming

- 1.1 Press the TC Button on the Microphone.

The TX SELCALL Code will be displayed. (Factory default : 00000)

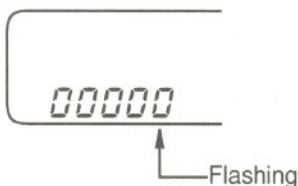

Use the ◀ or ▶ to select the digit position. The selected digit will flash.

Rotate the  to change the active digit value.

Channel Knob

When finished, transmit the TX Selcall Code or press  to store the code onto memory.

- 1.2 Selecting 5 or 6 Tone Format

- 1.21 From 5 to 6 Tone Format Setting

While the 5th digit is flashing, Press the ▶ .

A space bar [_] will appear and flash.

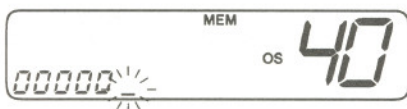

Assign a SELCALL number on this position. Follow procedure 1.1 for further TX SELCALL ID editing. When finished, press  or transmit the code to save the new setting onto memory.

1.22 From 6 to 5 Tone Format Setting

Select the 6th digit position, change the setting from the assigned SELCALL number to a space bar [_].

Example

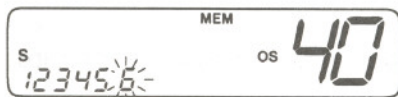

To

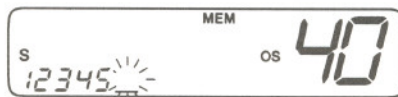

Follow procedure 1.1 for further TX SELCALL editing. When finished, press  or transmit the code to save the new setting onto memory.

Group Calling

The SUNDOWNER UH-099 has the capability to respond to Group Calling and to transmit Group Calling Codes.

Group Calling allows you to call members of your group simultaneously. However, to do this, you need to follow a certain format when programming your TX SELCALL ID.

TX SELCALL ID Format

| To call | Transmitter SELCALL ID | | | | |
|--------------|------------------------|-----|-----|-----|-----|
| 10 radios | [x] | [x] | [x] | [x] | [A] |
| 100 radios | [x] | [x] | [x] | [A] | [A] |
| 1000 radios | [x] | [x] | [A] | [A] | [A] |
| 10000 radios | [x] | [A] | [A] | [A] | [A] |

where: [x] is a common SELCALL ID prefix of your group and,
[A] is the CCIR Assigned Group Tone Code

example:

If one group comprises 10 members with SELCALL IDs.

ranging from

[1] [2] [3] [4] [0],
[1] [2] [3] [4] [1],
[1] [2] [3] [4] [2],
[1] [2] [3] [4] [3],
.
.
.

to [1] [2] [3] [4] [9],

All in T.SQ mode at CH20.

If someone transmits [1] [2] [3] [4] [A] on CH20, all of the above units will open their Tone Squelched Receiver.

Group Calls and ordinary SELCALLs can be differentiated in the following manner.

Group Call - Low tone beeps
Ordinary Selcall - High tone beeps

Note: Acknowledge tones will not be received when a Group Call code is transmitted. If all radios respond, acknowledge tones would only "litter" the channel with crisscrossing signals.

To use the Group Calling Feature effectively, your RX SELCALL ID should be well arranged and assigned.

5/6 TONE SELCALL PROGRAMMING

Since UH-099 can support either a 5 or 6 tone signalling format, you and your group must decide which format to use. The following is a basic outline of SELCALL Programming.

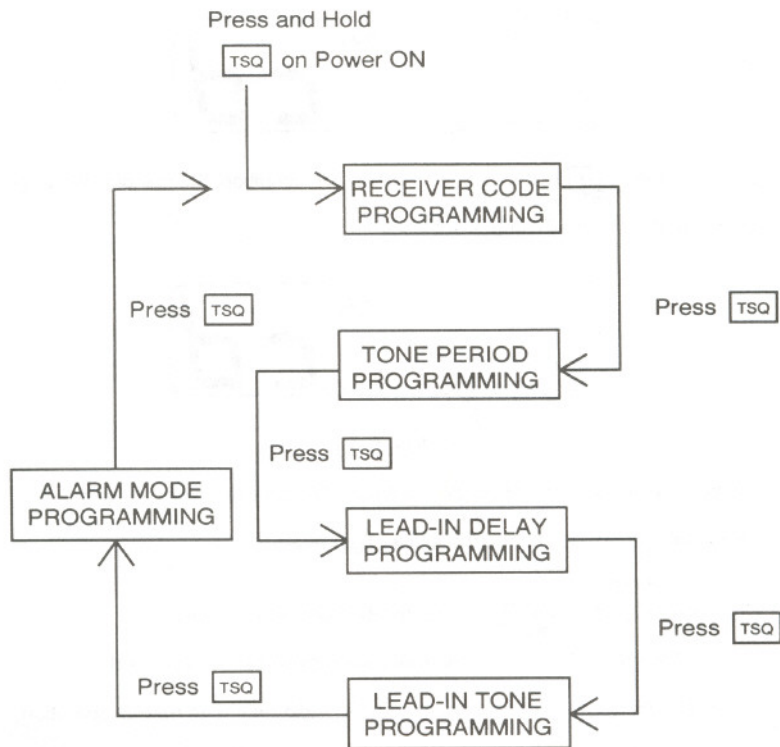

To select, press **[MEM ENT]**

To save new a setting after programming, press **[MEM ENT]**

To deselect, momentarily, press **[TSQ]**

The unit goes to the next programmable parameter.

To exit, press and hold **[TSQ]** for more than 1.5seconds.

The unit goes to Normal Operating mode.

Receiver SELCALL ID

To program your own receiver SELCALL ID, perform the following procedure.

Press and Hold **TSQ**, then turn on the Power.

1.1 Initial Display and Status (factory default: 00000)

RX SELCALL Code Programming



1.2 When the **MEM** key is pressed while in this condition, the last digit will begin to flash and RX Tone Editing is possible.

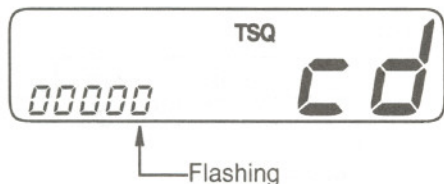

Use the **◀** or **▶** to select the digit position. The selected digit will flash.

Rotate the  to change the active digit value.

Channel Knob

When finished, press **MEM** to store the RX Code into memory.

The programmed code flashes and three successive beeps are heard.

Press **TSQ** for about 1.5 seconds to exit. The radio returns to normal operation.

Or press **TSQ** momentarily to go to the next programmable parameter.

1.3 Selecting 5 or 6 Tone Format

1.31 From 5 to 6 Tone Format Setting

While the 5th digit is flashing, press **▶**. A space bar [_] will appear and flash.



Assign a SELCALL number on this position. Follow procedure 1.2 for further RX SELCALL ID editing. When finished, press  to save the new setting.

1.32 From 6 to 5 Tone Format Setting

Select the 6th digit position, change its setting from the assigned SELCALL number to a space bar [_].

Example



To



Follow procedure 1.2 for further RX SELCALL ID editing. When finished press  to save the new setting.

Other SELCALL Parameters

Aside from the Transmitter and Receiver IDs, you should also be familiar with some of the other SELCALL Parameters. This section outlines the following programming modes.

- Tone Period
- Lead-in Delay
- Lead-in Tone
- Alarm

RX Selcall ID, Tone Period, Lead-in Delay, Lead-in Tone, and Alarm Programming are mentioned separately from the TX SELCALL Programming because they are not frequently changed. Special procedures have been designed to prevent accidental programming.

Tone Period

Tone Period is the duration of one tone in a SELCALL ID sequence. The setting of this parameter depends on the type of application. On long distance communications for example, where the signal strength of the transmitted information is greatly reduced and affected by noise, it is advisable to use a longer Tone Period. A long Tone Period gives the decoder more time and information to check and evaluate the code.

However, be sure that all radios in your group use the same tone period setting. Otherwise you will not be able to selectively call one another.

The Sundowner UH-099 allows you to select which tone period is best for you. The four most commonly used tone settings (20, 40, 70, or 100 mSec) are available. With the freedom to change this parameter, you can easily adapt to the existing system in your group without the inconvenience of having the unit serviced by the dealer.

2.1 From the Initial Display Status (1.1), press **TSQ** and the following mode will appear.

Tone Period Programming

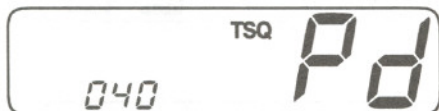



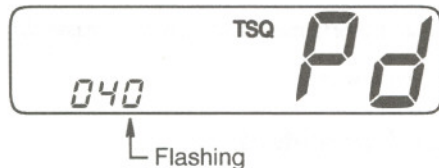

2.2 Next press **MEM** and 040 (factory default setting) will flash and Tone Period

Editing is possible.

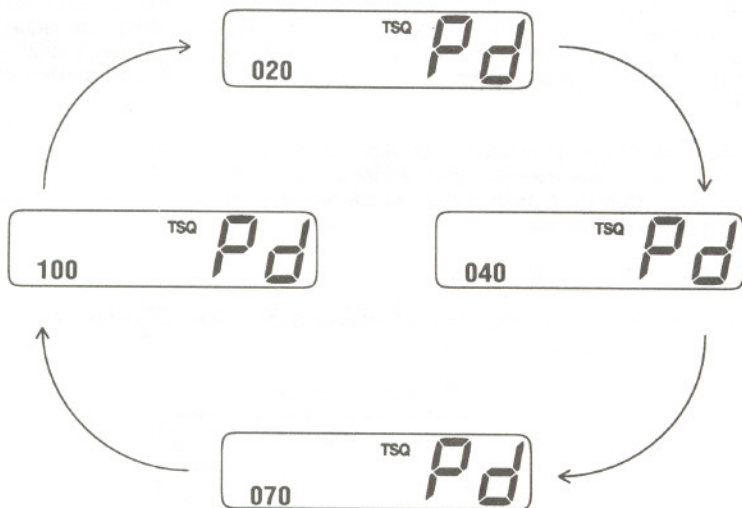

Rotate the  to change the Tone Period value.
Channel Knob



When finished, press  to store onto memory. The displayed Tone Period stops flashing and three successive beeps will be heard. Press  for about 1.5 seconds to exit. The radio returns to normal operation. Or press  momentarily to go to the next programmable parameter.

Lead-in Delay

Lead-in Delay is a SELCALL transmission parameter that “wakes-up” and helps the receiver of the other radio to lock onto the incoming signal. Each time a SELCALL ID is transmitted, the Lead-in Delay attaches itself to the beginning of the code sequence and cause the transmitter to be on for a longer period prior to the code transmission. This makes for a stronger communication link between the transmitter and the other receiver.

One major advantage to having the longer Lead-in Delay is when selectively calling another radio via a repeater station. A long Lead-in Delay helps to stabilize both the communication link from your radio to the repeater station and from the repeater station to the other radio.

3.1 Lead-in Delay Programming

From the Tone Period Programming Status (2.1), press the **TSQ** button and the following mode appears.

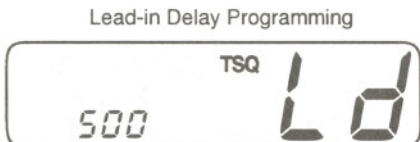

Note: 500 mSec is the factory default setting of UH-099 for Lead-in Delay.

3.2 Next press **MEM ENT** and Lead-in Delay Editing is possible.

Use the  to change the Lead-in Delay value.

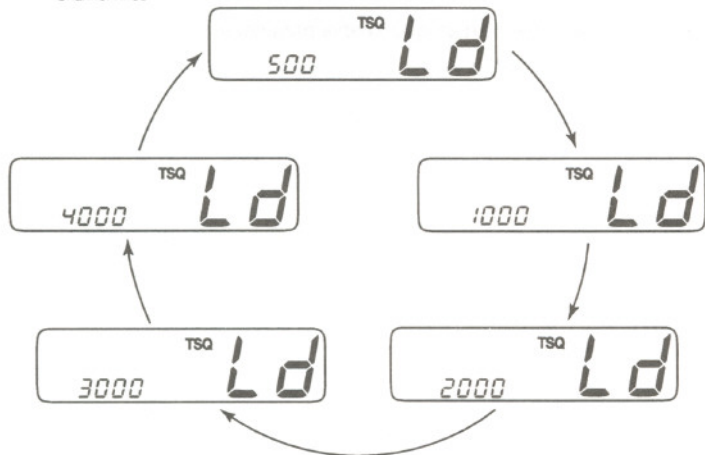

500, 1000, 2000, 3000, 4000 mSec

When finished, press **MEM** to store onto memory. The displayed Lead-in Delay stops flashing and three successive beeps will be heard. Press **TSQ** for about 1.5 seconds to exit. The radio returns to normal operation. Or press **TSQ** momentarily to go to the next programmable parameter.

Lead-in Tone

The Lead-in Tone, when programmed, “rides” on the Lead-in Delay. Hence, when transmitting a SELCALL ID, a continuous tone will be heard for the duration of the Lead-in Delay.

The main purpose of the Lead-in Tone is to increase the probability of contact between your unit and another radio **when TSQ Scanning**.

Normally during TSQ Scanning, if a carrier is detected and the unit does not notice SELCALL information on its first “glance” of the particular signal, scanning resumes.

But if a Lead-in Tone is present, the unit continues to wait until the SELCALL ID is received.

4.1 From the Lead-in Delay Status (3.1), press **TSQ** and the following mode appears.



Note: Tone_1 is the factory default setting of the UH-099 for Lead-in Tone.

4.2 Next press **MEM** and Lead-in Tone Editing is possible.

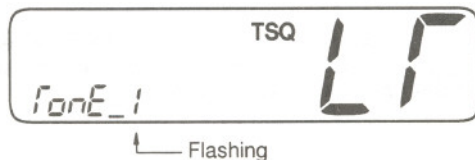

Use the  to change the Lead-in Tone value.
Channel Knob

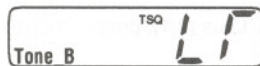
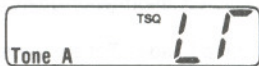
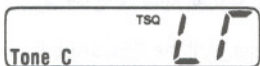
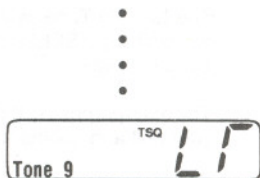
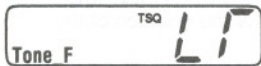
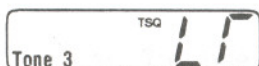
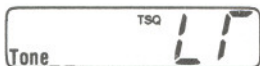
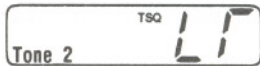
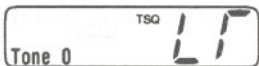
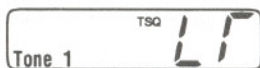

Note: If you want to remove the Lead-in Tone, choose the Space [_] Bar.

When finished press **MEM** to store onto memory. The selected Lead-in Tone stops flashing and three successive beeps will be heard. Press **TSQ** for about 1.5 seconds to exit. The radio returns to normal operation. Or press **TSQ** momentarily to go to the next programmable parameter.

Note: Make sure that all members of your group use the same Lead-in Tone. Otherwise, you will lessen the probability of receiving and successfully decoding a SELCALL call while TSQ Scanning

Alarm Mode

5.1 From the Lead-in Tone condition (4.1) press **TSQ** and the following mode appears.



5.2 Next press **MEM** and Alarm Mode Editing is possible.

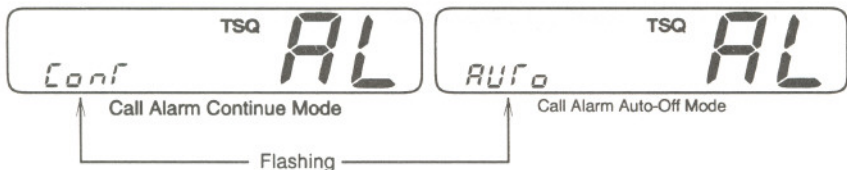
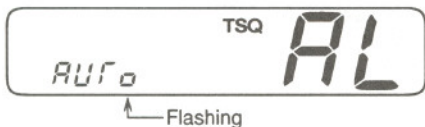

Use the  to change the Alarm Mode.

Channel Knob

When finished, press the **MEM** to store onto memory. The selected Alarm mode stops flashing and three successive beeps will be heard. Press **TSQ** for about 1.5 seconds to exit. The radio returns to normal operation.

When a received code matches to your Receiver SELCALL ID and you selected the:

Call Alarm Auto Mode

1. The unit will transmit an Acknowledge Tone to the Caller.
2. Emits CALL Alarm for 10 seconds only.
3. Resumes Quiet condition automatically after 20 seconds if the call is not answered.
4. The unit will start decoding again when the 20 second period elapsed and the call remained unanswered.

Call Alarm Continue Mode

1. The unit will transmit an Acknowledge Tone to the Caller.
2. Initially emits an alarm of four successive beeps for 20 seconds and then two successive beeps every four seconds continuously unless answered.
3. Never resumes the Quiet Condition.
4. Continues to check if incoming codes have your Receiver Selcall ID even though the Quiet Condition is already opened. When detected, it will send an Acknowledge Tone to the caller and then resets the Call Alarm.

* : For both of the above mentioned modes, transmission by using the **Press-to-Talk** button is possible when the "TSQ" icon is flashing.

Default Setting (Factory Default)

- | | |
|-------------------|----------|
| A. RX SELCALL ID: | 00000 |
| B. TX SELCALL ID: | 00000 |
| C. Tone Period: | 40msec |
| D. Lead-in Delay: | 500msec |
| E. Lead-in Tone: | Tone "1" |
| F. Alarm: | Auto |

IMPORTANT

Be sure that the Tone Format (5 Tone or 6 Tone), Tone Period Setting and the Lead-in Tone for all of the radios in your group are all the same. Otherwise you will not be able to selectively call one another effectively.

Care and Maintenance

Notice

If the UH-099 has been subjected to extreme high temperature (above 60°C) for a prolonged period of time, blackening of the Liquid Crystal Display (LCD) may occur. This is not a fault. Normal LCD operation resumes when the temperature stabilises back to proper operating conditions (0 to 55°C).

Preventive Maintenance

The following system checks should be made every six to twelve months:

1. Check the Standing Wave Ratio (SWR).
2. Inspect the tightness of all electrical connections.
3. Inspect the antenna coaxial cable for wear or breaks on the shielding.
4. Inspect the tightness of all screws and other mounting hardware.

Troubleshooting

Should the unit malfunction or perform poorly, follow the procedures indicated below:

1. If the transceiver is completely inoperative ...
 - * Check the power cord and fuse.
2. If there is trouble with receiving ...
 - * Check the **VOLUME** control setting.
 - * Be sure the **SQUELCH** is adjusted properly. Possibly the radio is over-squelched.
 - * Check that the radio is in an operational mode.
3. If there is trouble with transmitting ...
 - * Check that the transmission line (coaxial cable) is securely connected to the **ANTENNA** connector.
 - * Check that the antenna is fully extended for proper operation.
 - * Check that all transmission line (coaxial cable) connections are secure and free of corrosion.

Memory Backup

A built-in capacitor protects the channels stored in the SUNDOWNER UH-099 memory for up to 2 weeks after the DC power cable is disconnected.

UHF CB Channel Information

This radio has been designed to provide a high level of performance in the Citizens Band Radio Service, which is comprised of the following frequency assignments:

SIMPLEX Operating Mode

| Channel | Channel Frequency in MHz |
|---------|--------------------------|
| 1 | 476.425 |
| 2 | 476.450 |
| 3 | 476.475 |
| 4 | 476.500 |
| 5 | 476.525 |
| 6 | 476.550 |
| 7 | 476.575 |
| 8 | 476.600 |
| 9 | 476.625 |
| 10 | 476.650 |
| 11 | 476.675 |
| 12 | 476.700 |
| 13 | 476.725 |
| 14 | 476.750 |
| 15 | 476.775 |
| 16 | 476.800 |
| 17 | 476.825 |
| 18 | 476.850 |
| 19 | 476.875 |
| 20 | 476.900 |
| 21 | 476.925 |
| 22 | 476.950 |
| 23 | 476.975 |
| 24 | 477.000 |
| 25 | 477.025 |
| 26 | 477.050 |
| 27 | 477.075 |
| 28 | 477.100 |
| 29 | 477.125 |
| 30 | 477.150 |
| 31 | 477.175 |
| 32 | 477.200 |
| 33 | 477.225 |
| 34 | 477.250 |
| 35 | 477.275 |
| 36 | 477.300 |
| 37 | 477.325 |
| 38 | 477.350 |
| 39 | 477.375 |
| 40 | 477.400 |

DUPLEX Operating Frequencies

| Channel Assignment | Receive Frequency (MHz) | Transmit Frequency (MHz) |
|---------------------------|--------------------------------|---------------------------------|
| CH1 | 476.425 | 477.175 (CH31) |
| CH2 | 476.450 | 477.200 (CH32) |
| CH3 | 476.475 | 477.225 (CH33) |
| CH4 | 476.500 | 477.250 (CH34) |
| CH5 | 476.525 | 477.275 (CH35) |
| CH6 | 476.550 | 477.300 (CH36) |
| CH7 | 476.575 | 477.325 (CH37) |
| CH8 | 476.600 | 477.350 (CH38) |

Specifications

General

| | |
|-----------------------|---|
| Channels | : 40 |
| Frequency Range | : 476.425MHz to 477.40MHz |
| Crystal Oscillator | : 3 |
| Microphone | : 600 ohm, Dynamic Type |
| Speaker | : 8 ohm, 3W |
| Antenna Connector | : M-Type |
| Jacks & Connectors | : Mic4P Metal EXT SP 3.5ø DC Power 3P Type |
| Controls | : PRESS-TO-TALK Button (Microphone) TONE CALL Button (Microphone) SCAN/SEEK Button OPEN SCAN/GROUP Button BACK LIGHT CONTROL Button OFF/VOLUME Control SQUELCH Control DUPLEX Button TONE SQUELCH Button CHANNEL SELECTOR Knob |
| Indicators | : DUPLEX Indicator TX Indicator CALL Indicator TSQ Indicator GROUP SCAN Indicator MEMORY Indicator OPEN SCAN Indicator CHANNEL Indicator PRI Indicator S/RF Level Indicator SCAN Indicator TX/RX FREQUENCY, 5/6 Digit SELCALL ID Indicator |
| Cabinet Size | : W: 154.5 mm H: 52.5 mm D: 173 mm |
| Weight | : 1.2 kg |
| Operating Temperature | : 0° to +55°C |
| Power Requirements | : 13.8 VDC Nominal |
| SMA Approval | : Type accepted under SMAS250 |
| Accessories | : DC power cable with built-in-fuse, microphone, microphone hanger mounting bracket screw (2), washer (2) for microphone hanger screw (2), washer (2) for mounting bracket |

Measurement Conditions

| | |
|--------------------------------|-------------------------|
| Power Source | : 13.8V (DC) |
| Antenna Impedance | : 50 ohm |
| Test Temperature | : 25°C |
| Modulation Frequency | : 1 kHz (RX/TX) |
| Mean Signal Input Level | : 1000 μ V |
| Reference Audio Output Power | : 500mW |
| Reference Modulation Deviation | : \pm 3 kHz deviation |
| Audio Output Load | : 8 ohms resistive |

Transmitter Section

Frequency Tolerance at 25°C

(5 minutes after turning on)

: \pm 0.5 kHz

Carrier Power : 5W (max)

Spurious Emission : -30dBm

Current Drain : 1700mA

Modulation Frequency Response (1 kHz, 0 dB reference, at 1kHz deviation)

Lower at 500 Hz : -6 dB

Upper at 2.0 kHz : +6 dB

Microphone Sensitivity

for 3 kHz Deviation : 1mV

Maximum Deviation

at 1 kHz : \pm 4.75

at 6 kHz : \pm 1.5 kHz (max)

Receiver Section

Sensitivity at 12 dB SINAD: 0.25 μ V or better

Overall Audio Fidelity :

(1 kHz, 0 dB reference)

Lower at 500 Hz : +3 dB

Upper at 2 kHz : -6 dB

Adjacent Channel

Selectivity (\pm 25 kHz) : 65 dB

Maximum Audio Output

Power : 3W

Audio Output Power at

10% THD : 2W

Hum & Noise Ratio at

Input 1mV : 40 dB

Squelch Sensitivity at

Threshold : 0.1 μ V

Squelch Sensitivity at

Tight : 1 μ V

Image Rejection Ratio : 60 dB

IF Rejection Ratio : 70 dB

Oscillator Dropout

Voltage : 9V

Current Drain at No
Signal : 300mA
Current Drain at
Maximum Output : 600mA

SELCALL

Standard : CCIR International
Encode/Decode Format : 5 or 6 Tones
Transmit Tones : 0~9, A~D, F
Receive Tones : 0~9
Tone Periods : 20, 40, 70, 100mSec
Lead-In Delay : 500mSec, 1, 2, 3, 4Sec
Lead-In Tone : 0~9, A~F

Warranty

Uniden Sundowner UH-099 UHF CB Radio Australian One Year Warranty

Note: Please keep your sales docket as it provides evidence of warranty.

WARRANTOR: UNIDEN Australia Pty. Limited ACN 001 865 498

ELEMENTS OF WARRANTY: UNIDEN warrants to the original retail owner for the duration of this warranty, its Sundowner UH-099 UHF CB Transceiver Radio (hereinafter referred to as the Product) to be free from defects in materials and craftsmanship with only the limitations or exclusions set out below.

WARRANTY DURATION: This warranty to the original retail owner only, shall terminate and be of no further effect ONE (1) Year after the date of original retail sale. This warranty will be deemed invalid if the product is; (A) Damaged or not maintained as reasonable and necessary, (B) Modified, altered or used as part of any conversion kits, subassemblies, or any configurations not sold by Uniden, (C) Improperly installed, (D) Repaired by someone other than an authorized Uniden Repair Agent for a defect or malfunction covered by this warranty, (E) Used in conjunction with any equipment or parts or as part of a system not manufactured by Uniden, (F) Installed, programmed or serviced by anyone other than an authorized Uniden Repair Agent, or (G) Where the Serial Number label of the product has been removed or damaged beyond recognition.

PARTS COVERED: This warranty covers for 1 year, the Sundowner UH-099 UHF CB Transceiver Unit only. All accessories, mounting bracket, DC cable, fuse, and microphone are covered for 90 days.

STATEMENT OF REMEDY: In the event that the product does not conform to this warranty at any time while this warranty is in effect, the warrantor at its discretion, will repair the defect or replace the product and return it to you without charge for parts and service. THIS WARRANTY DOES NOT COVER OR PROVIDE FOR THE REIMBURSEMENT OR PAYMENT OF INCIDENTAL OR CONSEQUENTIAL DAMAGES.

WARRANTY CARD: If a warranty card has been included with this product, please fill it in and return it to us within 14 days of purchase. Your name and serial number of the product will then be registered in our database and this will help us process your claim with greater speed and efficiency should you require warranty service.

PROCEDURE FOR OBTAINING PERFORMANCE OR WARRANTY: In the event that the Product does not conform to this warranty, the Product should be shipped or delivered, freight prepaid, with evidence of original purchase, (eg/ a copy of the sales docket), to the warrantor at:

UNIDEN AUSTRALIA PTY. LIMITED
SERVICE DIVISION
345 Princes Highway, Rockdale, NSW 2216
Ph (02) 599 3100 FAX (02) 599 3278

Customers in other states should ship or deliver the Product freight pre-paid to the nearest Uniden Authorized Repair Centre.
(Contact Uniden for the Warranty Agent nearest you.)

uniden®

Australia Pty. Ltd.

345 Princess Highway, Rockdale, N.S.W. 2216

Phone: (02) 599 3100

Fax: (02) 599 3278

Uniden® is a registered trademark of **Uniden Corporation**.
Features, specifications, and availability of optional accessories are all
subject to change without notice.

Free Manuals Download Website

<http://myh66.com>

<http://usermanuals.us>

<http://www.somanuals.com>

<http://www.4manuals.cc>

<http://www.manual-lib.com>

<http://www.404manual.com>

<http://www.luxmanual.com>

<http://aubethermostatmanual.com>

Golf course search by state

<http://golfingnear.com>

Email search by domain

<http://emailbydomain.com>

Auto manuals search

<http://auto.somanuals.com>

TV manuals search

<http://tv.somanuals.com>