

**uniden**

***UH-054A/***

***UH-054L***

***Ultra Light Weight  
Two Way Radio***

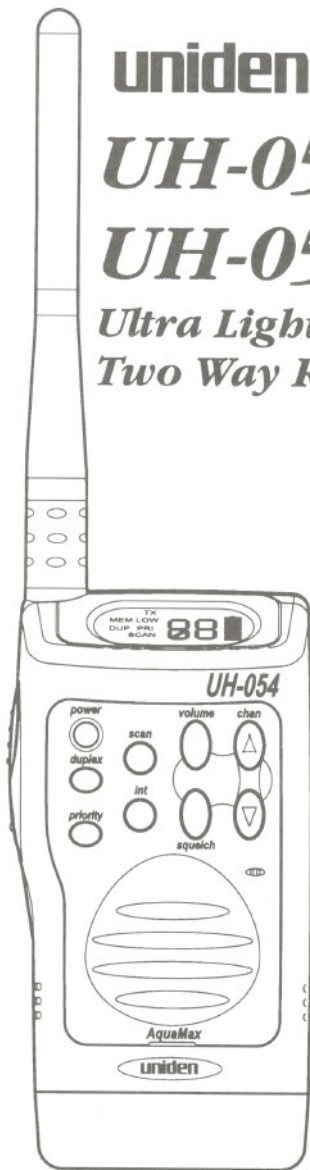

***Operating Guide***

UTZZ01870ZA

## Warning!

---

- ⚠ The **UH054A** is waterproof only when both the antenna and the battery are properly attached.
- ⚠ The **UH054L** is a standard NON water proof wearable radio only.
- ⚠ Do not operate the transmitter of any radio equipment unless all the Radio Frequency (RF) connectors are secure and any open connectors are properly terminated.
- ⚠ Do not operate the transmitter of any radio equipment near electrical blasting caps or in an explosive atmosphere.
- ⚠ Do not let children operate any transmitter-equipped radio equipment.
- ⚠ Have your radio equipment serviced by a qualified technician.
- ⚠ Do not operate the transmitter of any radio equipment with the antenna touching or close to the eyes, face, or exposed body parts.

### Nickel-Cadmium Battery Pack Warning

- ⚠ This equipment contains a Nickel-Cadmium Battery Pack.
- ⚠ The Nickel-Cadmium Battery Pack contained in this equipment may explode if disposed of in a fire.
- ⚠ Do not short-circuit the Battery Pack.
- ⚠ Do not charge the Nickel-Cadmium Battery Pack used in this equipment in any charger other than the one designed to charge this Battery Pack. Using another charger may damage the Battery Pack or cause the Battery Pack to explode.
- ⚠ Nickel-Cadmium batteries must be disposed of properly.



The exclamation point within an equilateral triangle is intended to alert the user to the presence of important operating and maintenance(servicing) instructions in the literature accompanying the appliance.

## Controls and Indicators

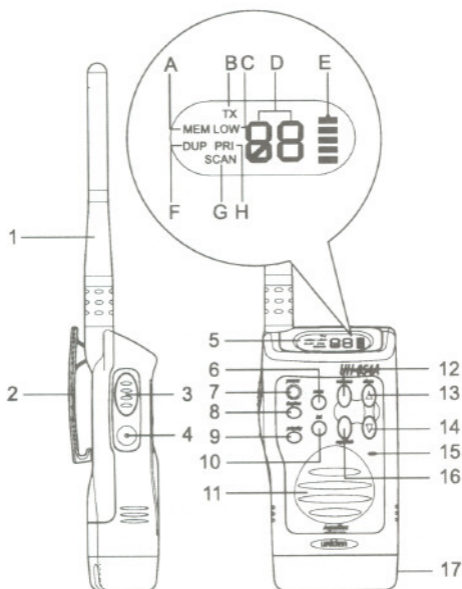

- |    |                        |    |                          |
|----|------------------------|----|--------------------------|
| 1  | Antenna                | 14 | Channel Down button ▼    |
| 2  | Belt Clip              | 15 | Microphone               |
| 3  | PTT (Push to Talk) Key | 16 | Squelch button           |
| 4  | HI/LO/LOCK Key         | 17 | Battery                  |
| 5  | LCD Display            | A  | MEM Indicator            |
| 6  | Scan button            | B  | Transmit Indicator       |
| 7  | Power button           | C  | RF Power Level Indicator |
| 8  | Duplex button          | D  | Channel Number Display   |
| 9  | Priority button        | E  | Battery Level Indicator  |
| 10 | Memory button          | F  | Duplex Indicator         |
| 11 | Speaker                | G  | Scan Indicator           |
| 12 | Volume button          | H  | Priority Indicator       |
| 13 | Channel Up button ▲    |    |                          |

# CONTENTS

---

Introduction . . . . .	2
Features . . . . .	2
Technical Support and Service . . . . .	2
Included with Your UH-054 . . . . .	4
Getting Started . . . . .	5
Mounting the Drop-in Charger . . . . .	5
Attaching the Antenna . . . . .	5
Attaching the Battery Pack. . . . .	6
Charging the Battery Pack. . . . .	6
Operation . . . . .	8
Setting the Squelch . . . . .	8
Selecting a Channel . . . . .	10
Transmitting . . . . .	10
Using Repeater Channels . . . . .	11
To Operate UH-054 in Duplex Mode	12
Dual Watch . . . . .	13
Scan . . . . .	14
Drop Out delay . . . . .	16
Lighted Display . . . . .	16
Key Lock . . . . .	16
Battery Level Detection. . . . .	17
UHF CB Channel Information . . . . .	18
SIMPLEX Operating Mode . . . . .	18
DUPLEX Operating Mode . . . . .	19
Parts and Accessories . . . . .	20
Specifications . . . . .	21
Warranty . . . . .	23

## Introduction

---

The **UH-054** is a portable two-way UHF transceiver. It is compact, lightweight, and rugged and fits easily in your hand. This hand held UHF CB Radio will give you the consistent, outstanding performance in virtually all conditions and situations.

The **UH-054** radio is available in two versions:

1. A Wearable and Waterproof **UH-054A\*** *AquaMax* Radio.

Or

2. A Wearable **UH-054L** *LandMax* Radio (non-waterproof)

To ensure that you get the most from the **UH-054** features, please read this operating guide carefully before using the unit.

\*Up to a depth of 30 cm for 30 minutes.

### Features

- Dual Watch Mode
- Two level selectable RF power output
- Priority Channel Scanning
- Memory Channel Scan
- Drop-in Charger
- Rechargeable nickel-cadmium battery pack
- Key pad lock
- Back-lit display
- Duplex Capable
- Wrist strap

### Technical Support and Service

Should you find it desirable or necessary to service your UH-054, we suggest you contact the Uniden dealer where your purchase was made. Your dealer will be able to assist you with complete service information.

If you require service that is within the terms of your warranty, you should present a copy of your receipt to your dealer to authenticate your claim.

If you find it inconvenient to obtain service assistance from a dealer, please pack your radio in a suitable container that will provide adequate protection. Enclose a note describing the problem and a copy of your receipt, and send the radio transportation prepaid to:

Uniden Australia Pty Limited  
Customer Service Division  
345 Princes Highway  
Rockdale NSW2216

Ph. (02) 9599-3355  
Fax. (02) 9599-3278

Or

Uniden New Zealand Limited  
Customer Service Division  
150 Harris Road  
East Tamaki  
Auckland

Ph. (9) 273-8383  
Fax. (9) 274-0009

## Included with Your UH-054

---



UH-054

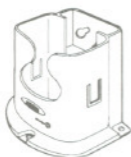

Charger



AC Adapter



Antenna



Battery



Wrist Strap



Operating Guide



Product Registration Card

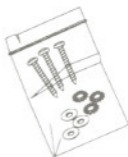

Mounting Screws

If any of these items are missing from the box, contact your Uniden Dealer.

---

## Getting Started

---

### Mounting the Drop-in Charger

1. Mount the drop-in charger to either a counter or wall.



2. Plug one end of the AC adapter into the wall outlet, and the other end into the Drop-in Charger.

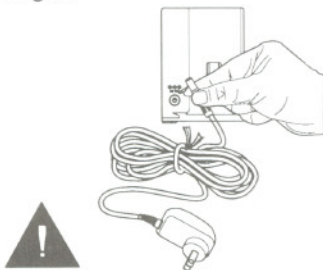

### Attaching the Antenna

Attach the antenna to the UH-054. Be sure the antenna is firmly seated.





## Attaching the Battery Pack

1. Slide the battery pack onto the bottom of the radio.



2. Use a coin to turn the screw that connects the battery pack to the UH-054. Be sure the battery pack fits tightly against the UH-054's body.

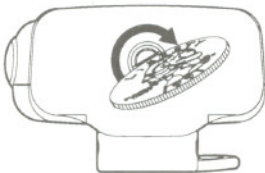

## Charging the Battery Pack

Your UHF CB radio is powered by a specially-designed nickel-cadmium battery pack.

- ☛ Before operating the UH-054, charge the battery pack for 15 hours in the drop-in charger.

1. Place the UH-054 in the drop-in charger.



2. The red LED lights and stays on.



- ☞ The battery pack will not be overcharged by the charger even if the battery pack is not removed from the charger.
- ☞ Do not transmit when the UH-054 is in the drop-in charger!
- ☞ You can monitor incoming calls while the UH-054 is in the drop-in charger.
- ☞ You can charge the battery pack alone or connected to the UH-054.

## Operation

- When you press any key (except PTT), a short tone sounds.
- See the front of the operating guide for button and key positions.

### Setting the Squelch

- To turn the unit on, press and hold the **power** button for 1 second.



- Use the **volume** and **chan** buttons to adjust the volume to a comfortable level!

- Press the **volume** button.



Press ▲ on the **chan** button to adjust the volume up.



Press ▼ on the **chan** button to adjust the volume down.



Press **volume** to finish.

- Before setting the squelch control on your UHF CB radio, you must select a channel that is not in use.

- Use the **squelch** and **chan** buttons to adjust the squelch to the desired level. Think of the squelch control as a gate.

Press the **squelch** button.



Press and hold ▲ on the *chan* button to adjust the “squelch gate” so high that no signals get through.

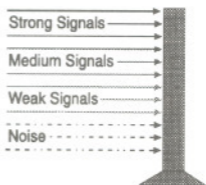

5. Press and hold ▼ on the *chan* button to adjust the “squelch gate” so everything gets through – noise, weak signals, and strong signals.

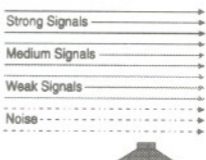

6. To set the “squelch gate” to the desired level, press ▲ on the *chan* button until the gate is all the way shut.

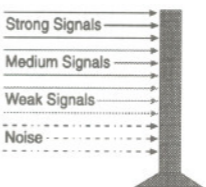

Press ▼ repeatedly until you just hear noise. Then press ▲ on the *chan* button repeatedly until the noise just stops. Now only strong signals get through.

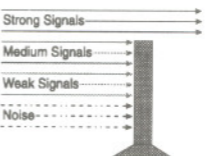

Press the *squelch* button when finished.

## Selecting a Channel

1. When you turn on the UH-054, the last channel will appear on the LCD display. (e.g. CH01)



2. To select a higher channel, press ▲ on the channel button.



3. To select a lower channel, press ▼ on the channel button.



To quickly change channels, press and hold ▲ or ▼ . This will change the channel rapidly.

## Transmitting

The **UH-054** uses the 40 UHF CB Channels. For your reference, a listing of all the available channels is printed at the end of this manual.

1. The maximum RF transmit power of **UH-054** is 1 watt.

To switch to low power, press the HI/LO switch. LOW appears on the LCD and the transmit power output level is changed to 0.2 Watt.



To switch back to high power, press the HI/LO switch again. The TX power returns to high and the LOW indicator disappears from the LCD.



2. Before you transmit, listen for activity on the selected channel.

3. When the channel is clear, press the PTT switch to transmit. TX appears on the LCD when you transmit. Hold the radio with the microphone approximately two inches in front of your mouth with the antenna at approximately a 45-degree angle away from your head. Speak in a clear, normal conversational voice.
4. When you are finished speaking, release the PTT switch and listen for an answer.

## Using a Repeater Channel

UHF CB Repeaters are used to retransmit or relay your signal. Repeaters will extend the range of your radio and overcome the shielding effect caused by solid obstructions.

In normal Simplex operation, your radio transmits on one particular frequency and receives on that same frequency. If there is a barrier (i.e. Valley) that partially blocks your transmitted signal, the probability of another radio receiving the signal is very slim. Valleys, tall buildings, metallic structures, ... etc., tend to act as a screen between radios

Standard operation without the help of a Repeater Station

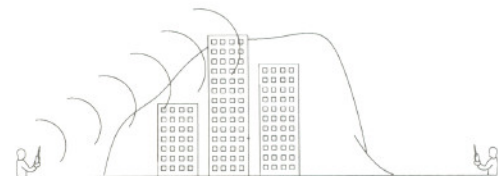

Operation with the aid of a Repeater Station

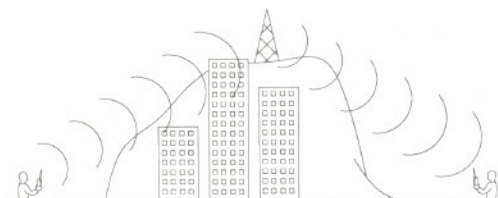

The signal coming from your radio is received by the Repeater station and then retransmitted at the same time on another channel. This operation is called "duplexing".

Your UH-054 is designed with the capability to access and use repeater stations.

Channels 01 through 08 have the option to operate in Duplex Mode. When any of these channels are set to operate in duplex mode during transmission, the UH-054 automatically sends the signal at a frequency 30 channels above the original. After transmitting, the radio reverts back to its original operating frequency.

For example,

- (1) CH01 on Duplex Mode will Receive on CH 01 but Transmit on CH31
- (2) CH02 on Duplex Mode will Receive on CH 02 but Transmit on CH32 etc....

If you transmit on CH01 Duplex mode, you are actually transmitting on CH31, the repeater station down-converts your signal and retransmits on CH01.

## TO operate UH-054 in Duplex Mode

eg. CH01 is being used in your area for repeater use.



Press **DUPLEX** momentarily. The **DUP** icon appears.



Press **DUPLEX** again to deactivate the duplex operation. UH-054 will return to simplex operation.



## Dual Watch

Dual Watch mode monitors a priority channel and the currently selected channel for a signal. The UH-054 checks the priority channel for activity every 1.5 seconds.

### Selecting a Priority Channel

The UH-054 is pre-programmed with CH01 as the priority channel.



However, you can change the priority channel to be any other channel.

**Note:** When you select a new priority channel, the old priority channel automatically becomes a regular channel.

1. The radio should be in Stand-by mode.

2. Select the new channel (e.g. CH04)



3. Press and hold the **priority** button to change the new channel to priority.



You hear a beep and **P** appears on the LCD.

### Dual Watching

Select a channel other than your priority channel. (e.g. CH01)



You can begin dual watching by simply pressing **priority** button momentarily.



Notice that the display toggles between the selected and the priority channel and **PRI** appears every time the priority channel is checked.



While in Dual Watch Mode, you can use the ▲ or ▼ to change to a new selected channel while monitoring the priority channel.

To cancel dual watch, momentarily press **priority** button or the PTT.

## Scan

Your UH-054 has a scanning feature that allows you to search for active channels automatically.

### Memory Scanning

Memory Scanning scans only the channels stored in the scan memory.

1. To begin scanning, momentarily press the scan button.



2. The **SCAN** icon flashes as the UH-054 looks for a transmission.



3. When it finds (receives) an active channel, the UH-054 stops and monitors that channel.



4. When the transmission stops, the radio continues scanning.

To stop scanning, press **scan** or the PTT switch.

### Priority Channel Scanning

Priority Channel Scanning allows you monitor the priority channel while scanning.

There are two ways to begin priority Scanning.

- ◆ Start memory scanning (as described on the previous section) then momentarily press the priority button.



- or -

- ◆ While dual watching, press the scan button.

### ***Deleting and Storing Channels in the Scan Memory***

You may have certain channels that you do not want to hear every time you scan. These are channels that are busy in a major portion of time, and the scanning stops at that channel(s) often enough to interrupt the scan cycle. You can remove those channels from the scan memory so that they are not scanned.

1. Using ▲ or ▼ button manually select the unwanted channel.



2. Then press and hold the **mem** button. You will hear a two-confirmation tone and **MEM** icon disappears from the display.



To return the deleted channel in the scan memory.

1. Using ▲ or ▼ button manually select the desired channel.



2. Then press and hold the *mem* button. You will hear a single-confirmation tone and **MEM** icon appears on the display.



## Drop Out delay

While scanning, the UH-054 stops at a busy channel and receives a transmission. When the received signal is over, the unit will wait for three seconds for the return of the signal, otherwise the radio resumes scanning.

## Lighted Display

The LCD back light automatically switch-on every time a key is pressed.

## Key Lock

To prevent accidental entries, you can lock the keypad.

Press and hold the HI/LO button until it beeps to activate Key Lock.

To unlock the keypad, press and hold the HI/LO button again.

**Note:** When the Key Lock is active, a two-tone warning beep will be heard if you attempt to use it.

## Battery Level Detection

1. At Power On, the level indicator is always the current battery level when not in Squelch or Volume Adjust Mode.



2. The battery level indicator indicates the current battery voltage level.

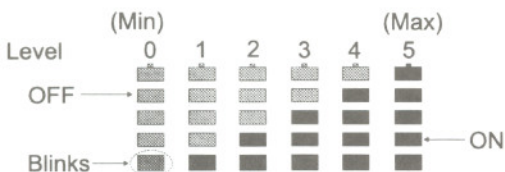

3. If level 1 is detected when [PTT] SW is pressed, transmit mode will fail, PTT Error Tone will sound and TX icon will blink. On the other hand, if Level 0 is detected, transmit mode will fail causing PTT Error Tone to sound while TX icon remains Off.

Once the battery level dips below Level 0, Power will be turned off automatically.

Once any of the above conditions occur, recharge your battery immediately.

## **UHF CB Channel Information**

This radio has been designed to provide a high level of performance in the Citizens Band Radio Service, which is comprised of the following frequency assignments;

### **SIMPLEX Operating Mode**

Channel	Channel Frequency in MHz
1	476.425
2	476.450
3	476.475
4	476.500
5	476.525
6	476.550
7	476.575
8	476.600
9	476.625
10	476.650
11	476.675
12	476.700
13	476.725
14	476.750
15	476.775
16	476.800
17	476.825
18	476.850
19	476.875
20	476.900
21	476.925
22	476.950
23	476.975
24	477.000
25	477.025
26	477.050
27	477.075
28	477.100
29	477.125
30	477.150
31	477.175
32	477.200
33	477.225
34	477.250
35	477.275
36	477.300
37	477.325
38	477.350
39	477.375
40	477.400

## DUPLEX Operating Mode

Channel Assignment	Receive Frequency (MHz)	Transmit Frequency (MHz)
CH1	476.425	477.175 (CH31)
CH2	476.450	477.200 (CH32)
CH3	476.475	477.225 (CH33)
CH4	476.500	477.250 (CH34)
CH5	476.525	477.275 (CH35)
CH6	476.550	477.300 (CH36)
CH7	476.575	477.325 (CH37)
CH8	476.600	477.350 (CH38)

## Parts and Accessories

---



Antenna



Standard Battery Pack BP940



Operating Guide



Wrist Strap



AC Adapter

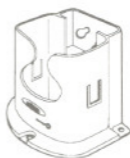

Drop-in Charger HH9485



Cigarette Adapter HH9804



High Capacity Battery Pack BP054

# Specifications

---

## General

Channels	Transmit	40
	Receive	40
Freq. Control		PLL
Freq. Tol.	Transmit	±6 ppm
	Receive	±6 ppm
Oper. Temp.		0°C ~ +55°C
Antenna		Flexible Whip
Microphone		Built-in Electret type
Display		Liquid Crystal Display
Speaker		8Ω 1 Watt
Power Source		Rechargeable Nickel-cadmium Battery Pack 4.8V 400 mAh
Size	(without antenna)	122 (H) 63 (W) 32 (D) mm
Weight	(with battery & antenna)	238 g

## Water Proof (UH-054 AquaMax only)

Standard	Designed to meet Japanese Industry Standard Class 4
Depth & Duration	up to 30 cm for 30 minutes
Water Impact Resistance	72 kph (max)
Temperature Shock	< 22°C (Ref 25°C)

## Transmitter

Frequency Range	476.425 to 477.4MHz
Frequency Stability	±6 ppm
Power Output	1.0W(HIGH)/0.2W(LOW)
Spurious Emissions	-65 dBc
Current Drain	550 mA at HI Power 250 mA at LOW Power

## Receiver

Receiver Type	Dual Conversion Super Heterodyne Phase Locked Loop System for Local Oscillator
Frequency Range	476.425 to 477.4MHz
Sensitivity	0.18 μV (12dB SINAD)
Squelch Sensitivity	Threshold 0.15μV
Audio Frequency Response	±6dB 500 to 2000Hz
Adjacent Channel Selectivity	62 dB @ ± 25 kHz



Hum & Noise Ratio	45 dB
Audio Output Power	0.6 W @ 10% THD
Current Drain	
Squelched	45 mA
Max.Audio	280 mA

**Charger**

Input Voltage	9 V ~ 12 V DC
Std. Power Supply	AAD-050S N/13809 Input=230~240V AC, 50Hz Output = 9 V DC, 210 mA

Specifications shown are typical and subject to change without notice.

# Warranty

---

## Uniden UH-054 UHF CB Radio One Year Warranty

**Note:** Please keep your sales docket as it provides evidence of warranty.

**WARRANTOR:** Uniden Australia Pty. Limited ACN 001 865 498 Uniden New Zealand Limited

**ELEMENTS OF WARRANTY:** UNIDEN warrants to the original retail owner for the duration of this warranty. Its UH-054 UHF CB Transceiver Radio (hereinafter referred to as the Product) to be free from defects in materials and craftsmanship with only the limitations or exclusions set out below.

**WARRANTY DURATION:** This warranty to the original retail owner only, shall terminate and be of no further effect ONE(1) Year after the date of original retail sale. This warranty will be deemed invalid if the product is;  
(A) Damaged or not maintained as reasonable and necessary, (B) modified, altered, or used as part of any conversion kits, subassemblies, or any configurations not sold by Uniden, (C) improperly installed, (D) Repaired by someone other than an authorized Uniden Repair Agent for a defect or malfunction covered by this warranty, (E) Used in conjunction with any equipment or parts or as part of a system not manufactured by Uniden. (F) Installed, programmed or serviced by anyone other than an authorized Uniden Repair Agent, or (G) Where the Serial Number label of the product has been removed or damaged beyond recognition.

**PARTS COVERED:** This warranty covers for 1 year, the UH-054 UHF CB Transceiver Unit only. All accessories, AC adapter, Charger, Battery Pack, Antenna are covered for 90 days.

**STATEMENT OF REMEDY:** In the event that the product does not conform to this warranty at any time while this warranty is in effect, warrantor at its discretion, will repair the defect or replace the product and return it to you without charge for parts and service. THIS WARRANTY DOES NOT COVER OR PROVIDE FOR THE REIMBURSEMENT OR PAYMENT OF INCIDENTAL OR CONSEQUENTIAL DAMAGES.

**WARRANTY CARD:** If a warranty card has been included with this product, please fill it in and return it to us within 14 days of purchase. Your name and serial number of the product will then be registered in our database and this will help us process your claim with greater speed and efficiency should you require warranty service.

**PROCEDURE FOR OBTAINING PERFORMANCE OR WARRANTY:** In the event that the product does not conform to this warranty, the product should be shipped or delivered freight prepaid, with evidence of original purchase, eg/ a copy of the sales docket, to the warrantor at:

UNIDEN AUSTRALIA PTY. LIMITED  
SERVICE DIVISION  
345 Princes Highway, Rockdale, NSW 2216  
Ph (02) 9599 3355 FAX (02) 9599 3278

or  
UNIDEN NEW ZEALAND LTD.  
CUSTOMER SERVICE DIVISION  
150 Harris Road East Tamaki Auckland  
Ph (9) 273 8383 FAX (9) 274 0009

Customers in other states should ship or deliver the Product freight pre-paid to the nearest Uniden Authorized Repair Centre.  
(Contact Uniden for the Warranty Agent nearest you.)

**uniden®**

©1997 Uniden Australia Pty Ltd.  
All Rights Reserved.  
Printed in the Philippines

## Free Manuals Download Website

<http://myh66.com>

<http://usermanuals.us>

<http://www.somanuals.com>

<http://www.4manuals.cc>

<http://www.manual-lib.com>

<http://www.404manual.com>

<http://www.luxmanual.com>

<http://aubethermostatmanual.com>

Golf course search by state

<http://golfingnear.com>

Email search by domain

<http://emailbydomain.com>

Auto manuals search

<http://auto.somanuals.com>

TV manuals search

<http://tv.somanuals.com>