

UH060SX-2

Operating Guide



Uniden[®]

To bring outstanding wireless communication products
to people's lives throughout the world.

CONTROL & INDICATORS

INCLUDED IN YOUR PACKAGE:

- UH060SX Radio (2)
- Operating Guide
- Belt Clip (2)
- Charging Cradle with AC Adaptor
- NiMH Battery Pack (2)
- VOX Headset (2)

OPTIONAL ACCESSORIES

- VOX Earset
- Carry Case

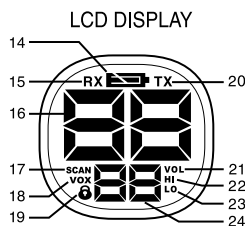
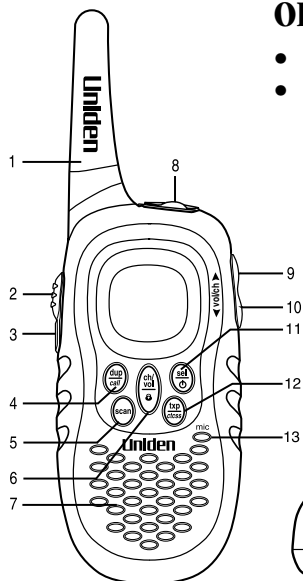

Charging Cradle

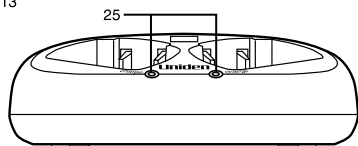

- | | |
|------------------------------|-----------------------------|
| 1 Antenna | 14 Battery Level Meter |
| 2 PTT (Push-To-Talk) Button | 15 Receive Indicator |
| 3 Monitor Button | 16 Channel Indicator |
| 4 Duplex/Call Key | 17 Scan Indicator |
| 5 Scan Key | 18 VOX Indicator |
| 6 Channel/Volume/Keylock Key | 19 Keypad Lock Indicator |
| 7 Speaker | 20 Transmit Indicator |
| 8 Headset Jack | 21 Volume Setting Indicator |
| 9 Volume/Channel up Key | 22 HI Indicator |
| 10 Volume/Channel down Key | 23 LO Indicator |
| 11 Power On/Off/Select Key | 24 CTCSS Indicator |
| 12 Txp/CTCSS Key | 25 Charging LED's |
| 13 Microphone | |

GETTING STARTED



Uniden does not represent this product to be waterproof. Do not expose this product to Rain or Moisture.

BATTERY INSTALLATION

Your UH060SX-2 unit uses the included NiMH battery pack for power. The unit can be powered with optional 4 AAA ALKALINE batteries.



If you don't use the UH060SX-2 for long periods, Uniden recommend removing the batteries. The UH060SX-2 is designed to retain the previous user settings. This feature will continue to use a small amount of battery power while the unit is switched off.



To avoid damage to the unit do not mix old and new batteries.

To install the batteries:

1. Make sure your radio is off.
 2. Release the battery cover clip, then remove the battery cover.
 3. Insert NiMH battery pack according to the orientation on the battery pack.
- OR
4. Insert 4 AAA ALKALINE batteries (not included) according to the polarity symbols inside the battery compartment.
 4. Align the battery cover tabs with the UH060SX-2 tab holes then replace the cover clip.



Do not charge alkaline or non rechargeable batteries.

INSTALLING THE CHARGE CRADLE

- Plug the AC adaptor into the rear of the charge cradle and into the mains power.

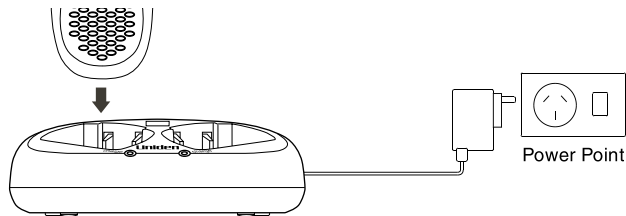

Place the UH060SX-2 into the charge cradle. The charge light will come on to indicate the unit is charging. Before operating the UH060SX-2, charge the battery pack for 16 hours.



Do not charge alkaline or non rechargeable batteries.

BELT CLIP

To attach the belt clip:

Slide the belt clip until it snaps into place.

To remove the belt clip:

To remove the belt clip, press and hold belt clip locker, slide the belt clip at the same time until released.

LOW BATTERY ALERT

If the battery level becomes low, the battery indicator icon on the display begins flashing.

When the batteries in the unit are low, the unit will go into a Battery Low mode. The Transmit mode is disabled. Replace the alkaline batteries immediately or if you are using the NiMH battery pack, place the radio on the charge cradle to recharge. Full charge will take up to 16 Hrs.

OPERATION

POWER ON/OFF

Press and hold ***select/power*** key to turn the radio on. A channel number will appear on the display. Press and hold ***select/power*** key to turn the radio off.

VOLUME

Press ***volume/channel*** ▲ or ▼ key to increase or decrease the volume level.

'VOL' icon appears on the display while volume is being adjusted.

There are 8 volume levels. Level 0 (No Audio) to Level 7 (Maximum Volume).

ADJUSTING THE KEY BEEPS

Your radio emits a beep each time one of the keys (except for the PTT button) is pressed.

To turn OFF this beep: Press and hold ***dup/call*** key while turning on the radio.

To turn ON this beep: Press and hold ***dup/call*** key while turning on the radio.

ROGER BEEP

Roger Beep is a BEEP that is sent to notify the end of transmission (both PTT and VOX transmission.) Roger Beep can be heard through the speaker when Key Beep is on. Roger Beep is transmitted even if Key Beep is turned off. However, Roger Beep will not be heard from the speaker.

To turn OFF Roger Beep: Press and hold ***volume/channel*** ▲ key while turning on the radio.

To turn ON Roger Beep: Press and hold ***volume/channel*** ▲ key while turning on the radio.

SELECTING A CHANNEL

- Press **ch/vol/keylock** key momentarily to activate channel select mode. The displayed channel will flash.
- Press **volume/channel ▲** or **▼** key to select the desired channel.
- Press **ch/vol/keylock** key momentarily to exit channel select mode.
- If no button is pressed within 4 sec the UH060SX-2 will exit from the channel select mode.

TO TRANSMIT AND RECEIVE

The UH060SX-2 uses the 40 UHF-CB Channels. For your reference a list of the available channels and corresponding frequencies is printed on page 11.

1. Before you transmit, listen for activity on the selected channel.
2. When the channel is clear, press and hold the PTT button to transmit. **'TX'** icon appears on the display.

Hold the radio with microphone approximately 5 cm in front of your mouth with the antenna at approximately 45° angle away from your head. Speak in a clear, normal conversational voice.

3. When you have finished speaking, release the PTT and listen for a response. **'TX'** icon then disappears on the display. While receiving, the **'RX'** icon is displayed.

TRANSMIT Hi/Lo POWER SELECT

- Press ***txp/ctcss*** key momentarily to select desired transmit level.
- **'HI'** icon will appear on the display for maximum transmit level.
- **'LO'** icon will appear on the display for minimum transmit level.
- No transmit level appears for the middle transmit level
- The RF transmit power of the UH060SX-2 is selectable between 0.1/0.5/1.5 W.

AUTOMATIC SQUELCH FEATURE

The UH060SX-2 is equipped with an Automatic Squelch System which shuts off weak transmissions and unwanted noise.

MONITOR

This feature enables users to listen for weak signals on the current channel at the press of a button.

To use monitor:

- Press ***moni*** button. The **'RX'** icon will flash.
- Release within 1.5 seconds and the unit exits Monitor mode.
- Press and hold ***moni*** button for 2 seconds for continuous listening.

The receiver circuit will stay open, letting in both the noise & weak signals. The **'RX'** icon flashes in this status.

- To return to normal Receive mode press ***moni*** button. The **'RX'** icon disappears or stops flashing in this status.

TO OPERATE IN DUPLEX MODE (REPEATERS)

The Duplex function enables you to access local repeater stations. You can only activate Duplex from CH01-CH08.

UHF CB Repeaters are used to retransmit or relay your signal. Repeaters will extend the range of your radio and overcome the shielding effect caused by solid obstructions.



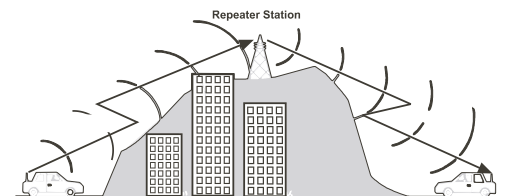

Contact your retailer for a list of repeaters available in your area.

Operation with the aid of a Repeater



Operation with the aid of Repeater Station (Duplex)

Press **dup/call** key momentarily. The  changes to .

Press **dup/call** key again to deactivate the duplex operation. UH060SX-2 will return to normal operation.



*If **dup/call** key is pressed when the channel is not from CH01 - CH08, an error tone sounds.*

SCANNING

The scan function scans all channels and stops at an active channel. When the signal stops, the UH060SX-2 waits 2 seconds (Reply Delay) before scanning resumes.

To initiate scanning,

1. Press **scan** key momentarily to begin scanning. The '**SCAN**' icon is displayed.
2. Press **select/power** key or **scan** key to cancel.

REPLY DELAY

While scanning, the UH060SX-2 stops at a busy channel and receives a transmission. When the received signal is over, the unit will wait for 2 seconds for the return of the signal, otherwise, the radio resumes scanning.

CTCSS (Continuous Tone Coded Squelch System)

CTCSS is a feature that allows a group to talk to each other without hearing other users on the same channel.

Press and hold **txp/ctcss** key for 3 seconds in Standby mode to enter CTCSS mode.

The current selected CTCSS tone flashes.

Press **volume/channel** ▲ or ▼ key to select the required CTCSS tone (OFF or 1-38).

For channels with a CTCSS tone setting, the CTCSS tone is displayed below the channel indicator. For channels with the setting of CTCSS OFF, there will be no display below the channel indicator.

Press **txp/ctcss** key to confirm the selected setting.



Channels 5 and 35 are used for emergency channels. CTCSS will not operate on these channels.

VOX

VOX is the automatic transmitting function by inputting voice into the VOX headset mic without pressing the PTT button.

Press **select/power** key momentarily while in standby mode to enter VOX Sensitivity mode.

The current selected VOX setting will flash on the display.

Press **volume/channel** ▲ or ▼ key to adjust the VOX sensitivity. 1 is the highest sensitivity and 4 is the lowest sensitivity. VOX can be turned off by selecting 'OF' icon.

The 'VOX' icon is shown on the display when VOX is selected to on and VOX Headset is plugged into VOX Headset Jack. The 'TX' icon blinks when the voice level is possible to transmit at the current selected VOX sensitivity level.

Press **select/power** key twice to confirm the setting and exit to standby mode.

TRANSMITTING A CALL TONE

Your UH060SX-2 radio is equipped with 5 selectable call tones that will be transmitted when the **dup/call** key is pressed and held for 3 seconds.

To select a call tone:

1. Press **select/power** key momentarily twice while in standby mode to enter Call Tone mode. The current call tone number (C1-C5) will be indicated.
2. Press the **volume/channel** ▲ or ▼ key to increase or decrease the number to the desired call tone. Each tone will be heard through the speaker.
3. Press **select/power** key to confirm and exit to standby mode.

To transmit the selected call tone, press and hold the **dup/call** key. The selected tone will automatically be transmitted for a fixed length of time. Call Tone will be cancelled when the PTT button is pressed.

KEYLOCK ON/OFF

Press **ch/vol/keylock** key for 3 seconds to enter keylock on mode.

Press **ch/vol/keylock** key for 3 seconds while in Keylock mode to exit the Keylock mode.



While in Keylock on mode, the UH060SX-2 can still receive and transmit.

UHF CHANNELS & FREQUENCIES

CH No.	Simplex Mode Transmit / Receive Frequency (MHz)	Duplex Mode Transmit Frequency (MHz)	CH No.	Simplex Mode Transmit / Receive Frequency (MHz)
1	476.425	477.175 CH31	21	476.925
2	476.450	477.200 CH32	22	476.950
3	476.475	477.225 CH33	23	476.975
4	476.500	477.250 CH34	24	477.000
5	476.525	477.275 CH35	25	477.025
6	476.550	477.300 CH36	26	477.050
7	476.575	477.325 CH37	27	477.075
8	476.600	477.350 CH38	28	477.100
9	476.625		29	477.125
10	476.650		30	477.150
11	476.675		31	477.175
12	476.700		32	477.200
13	476.725		33	477.225
14	476.750		34	477.250
15	476.775		35	477.275
16	476.800		36	477.300
17	476.825		37	477.325
18	476.850		38	477.350
19	476.875		39	477.375
20	476.900		40	477.400



Channels 05 and 35 are Emergency Channels and channel 11 is a Calling Channel. Channels 22 and 23 are used for telemetry and telecommand applications, voice communications are not permitted on these channels.

WARRANTY

UNIDEN UH060SX-2 UHF CB RADIO

Limited One Year Warranty



Please keep your sales docket as it provides evidence of warranty.

Warrantor: Uniden Australia Pty Limited ABN58 001 865 498 Uniden New Zealand Limited. Warranty only available in original country of purchase

Elements of Warranty: Uniden warrants to the original retail owner for the duration of this warranty, its UH060SX-2 UHF CB Transceiver Radio (hereinafter referred to as the Product) to be free from defects in materials and craftsmanship with only the limitations or exclusions set out below.

Warranty Duration: This warranty to the original retail owner only, shall terminate and be of no further effect ONE (1) Year after the date of original retail sale. This warranty will be deemed invalid if the Product is; (A) Damaged or not maintained as reasonable and necessary, (B) Modified, altered or used as part of any conversion kits, subassemblies, or any configurations not sold by Uniden, (C) Improperly installed, (D) Repaired by someone other than an authorised Uniden Repair Agent for a defect or malfunction covered by this warranty, (E) Used in conjunction with any equipment or parts or as part of a system not manufactured by Uniden, (F) Installed, programmed or serviced by anyone other than an authorised Uniden Repair Agent, or (G) Where the Serial Number label of the product has been removed or damaged beyond recognition.

Parts Covered: This warranty covers for 1 year, the UHF CB Transceiver Unit only. Accessories: Belt Clip and Wrist Strap are covered for 90 days.

Statement of Remedy: In the event that the product does not conform to this warranty at any time while this warranty is in effect, the warrantor at its discretion, will repair the defect or replace the product and return it to you without charge for parts and service. This warranty does not cover provide for the reimbursement or payment of incidental or consequential damages.

Procedure for Obtaining Performance or Warranty: In the event that the Product does not conform to this warranty, the Product should be shipped or delivered, freight prepaid with evidence of original purchase, (eg. a copy of the sales docket), to the warrantor at:

UNIDEN AUSTRALIA PTY LIMITED
Service Division
345 Princes Highway, Rockdale, NSW 2216
Fax (02) 9599 3278
www.uniden.com.au

UNIDEN NEW ZEALAND LIMITED
Service Division
150 Harris Road, East Tamaki, Auckland
Fax (09) 274 4253
www.uniden.co.nz

Customers in other states should ship or deliver the Product freight pre-paid to the nearest Uniden Authorised Repair Centre. (Contact Uniden for the Warranty Agent nearest you.)

Uniden®

© 2004 Uniden Australia Pty Limited/
Uniden New Zealand Limited
Printed in China
UTZZ01928ZZ

Free Manuals Download Website

<http://myh66.com>

<http://usermanuals.us>

<http://www.somanuals.com>

<http://www.4manuals.cc>

<http://www.manual-lib.com>

<http://www.404manual.com>

<http://www.luxmanual.com>

<http://aubethermostatmanual.com>

Golf course search by state

<http://golfingnear.com>

Email search by domain

<http://emailbydomain.com>

Auto manuals search

<http://auto.somanuals.com>

TV manuals search

<http://tv.somanuals.com>