

Document Centre 460/470 ST

Network Installation and Troubleshooting Guide

May, 2000

701P34128

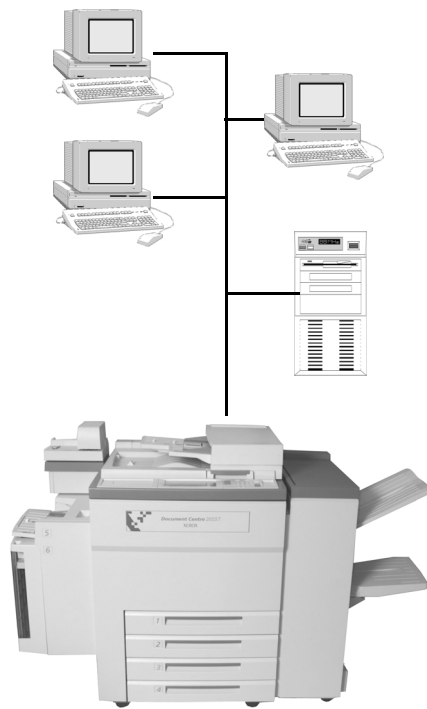

0300107A-LKS

THE DOCUMENT COMPANY
XEROX



Document Centre
470/460 ST
Network Installation and Troubleshooting Guide

May 2000

701P34128

Xerox Document Centre Model _____

Serial Number _____

If you have a problem or need supplies:

In the USA

Calling for Service and ordering Replaceable Units 1-800-821-2797 (USA)

Ordering Supplies 1-800 822-2200 (USA)

In Canada

Calling for Service 1-800-939-3769 (Canada)

Ordering Supplies and Replaceable Units 1-800-668-0199 (Canada)

Xerox Corporation
Global Knowledge & Language Services
800 Phillips Road - Bldg 845-17S
Webster, New York 14580
USA

©2000 by Xerox Corporation. All rights reserved.

Printed in the United States of America

Copyright protection claimed includes all forms and matters of copyrighted material and information now allowed by statutory or judicial law or hereinafter granted, including without limitation material generated from the software programs that are displayed on the screen such as icons, screen display looks, etc.

XEROX®, The Document Company® and the stylized X and identifying product names and numbers are registered trademarks of XEROX CORPORATION and Xerox Canada Ltd. is a licensee of all the trademarks.

Xerox^{md}, Les Gens De Documents^{md}, le X stylisé et Document Centre sont des marques de commerce de Xerox Corporation pour lesquelles Xerox Canada ltée détient des permis d'utilisation.

The Document Centre ST model includes an implementation of LZW licensed under U.S. Patent 4,558,302.

Product names used in this guide may be trademarks or registered trademarks of their respective companies and are hereby acknowledged.

This document contains images of screens that were created using Zinc Application Framework software version 3.5
© January 1997 Zinc Software Inc.



As an ENERGY STAR® partner, Xerox Corporation has determined that this product meets the ENERGY STAR® guidelines for energy efficiency.



Terra Choice Environmental Services Inc. of Canada has verified that this Xerox product conforms to all applicable Environmental Choice EcoLogo requirements for minimized impact to the environment.

While the information in this Guide is correct at the time of first publication, Xerox reserves the right at any time to change the information without notice. Changes are made periodically to this document. Changes and technical updates will be added in subsequent editions.

The Document Centre ST model includes software provided by the Internet Software Consortium.

Copyright (c) 1995, 1996, 1997, 1998, 1999

The Internet Software Consortium - DHCP. All rights reserved.

Redistribution and use in source and binary forms, with or without modification, are permitted provided that the following conditions are met:

Redistributions of source code must retain the above copyright notice, this list of conditions and the following disclaimer.

Redistributions in binary form must reproduce the above copyright notice, this list of conditions and the following disclaimer in the documentation and/or other materials provided with the distribution.

Neither the name of The Internet Software Consortium - DHCP nor the names of its contributors may be used to endorse or promote products derived from this software without specific prior written permission.

This Software Is Provided By The Internet Software Consortium And Contributors "As Is" And Any Express Or Implied Warranties, Including, But Not Limited To, The Implied Warranties Of Merchantability And Fitness For A Particular Purpose Are Disclaimed. In No Event Shall The Internet Software Consortium Or Contributors Be Liable For Any Direct, Indirect, Incidental, Special, Exemplary, Or Consequential Damages (Including, But Not Limited To, Procurement Of Substitute Goods Or Services; Loss Of Use, Data, Or Profits; Or Business Interruption) However Caused And On Any Theory Of Liability, Whether In Contract, Strict Liability, Or Tort (Including Negligence Or Otherwise) Arising In Any Way Out Of The Use Of This Software, Even If Advised Of The Possibility Of Such Damage.

Radio Frequency Notice

US Federal Communications Commission

This equipment has been tested and found to comply with the Class B digital device, pursuant to part 15 of the FCC Rules. These limits are designed to provide reasonable protection against harmful interference in a residential installation. This equipment generates, uses and can radiate radio frequency energy and, if not installed and used in accordance with the instructions, may cause harmful interference to radio communications. However, there is no guarantee that interference will not occur in a particular installation. If this equipment does cause harmful interference to radio or television reception, which can be determined by turning the equipment off and on, the user is encouraged to try to correct the interference by one or more of the following measures:

- 1 Reorient or relocate the receiving antenna
- 1 Increase the separation between the equipment and receiver
- 1 Connect the equipment into an outlet on a circuit different from that to which the receiver is connected
- 1 Consult the dealer or an experienced radio/TV technician for help

Changes or modifications to this equipment not specifically approved by the Xerox Corporation may void the authority granted by the FCC to operate this equipment.

Canadian EME

This Class B digital apparatus complies with Canadian ICES-003.

Cet appareil numérique de la classe B est conforme la norme NMB-003 du Canada.

Telephone Requirements Notice

US Federal Communications Commission

1. The FCC has established rules that permit this device to be directly connected to the telephone network. Standardized jacks are used for these connections. This equipment should not be used on party lines or coin lines.
2. If this device is malfunctioning, it may also be causing harm to the telephone network; this device should be disconnected until repair has been made. If this is not done, the telephone company may temporarily disconnect service.
3. The telephone company may make changes in its technical operations and procedures; if such changes affect the compatibility or use of this device, the telephone company is required to give adequate notice of the changes. You will be advised of your right to file a complaint with the FCC.
4. If the telephone company requests information on what equipment is connected to their lines, inform them of:
 - A. the telephone number this unit is connected to.
 - B. the ringer equivalence number.
 - C. the USOC jack required.
 - D. the FCC Registration number.

Items 'B' and 'D' are indicated on the label.

The Ringer Equivalence Number (REN) is used to determine how many devices can be connected to your telephone line. In most areas, the sum of the RENs of all devices on any one line should not exceed five (5.0). If too many devices are attached, they may not ring correctly.

Service Requirements

In the event of equipment malfunction, all repairs should be performed by Xerox or authorized agent. It is the responsibility of users requiring service to report the need for service to Xerox or to an authorized agent. Service can be obtained at:

Xerox Customer Support
1301 Ridgeview Drive, Bldg. 301
Lewisville, TX 75067
Telephone: (800) 821-2797

Canadian Industry Requirements

Notice: The Canadian Industry Canada label identifies certified equipment. This certification means that the equipment meets certain telecommunications network protective, operational and safety requirements. The Department does not guarantee the equipment will operate to the user's satisfaction.

Before installing this equipment, users should ensure that it is permissible to be connected to the facilities of the local telecommunications company. The equipment must also be installed using an acceptable method of connection. In some cases, the company's inside wiring associated with a single line individual service may be extended by means of a certified connector assembly (telephone extension cord). The customer should be aware that compliance with the above conditions may not prevent degradation of service in some situations.

Repairs to certified equipment should be made by an authorized Canadian maintenance facility designated by the supplier. Any repairs or alterations made by the user to this equipment, or equipment malfunctions, may give the telecommunications company cause to request the user to disconnect the equipment.

Users should ensure for their own protection that the electrical ground connections of the power utility, telephone lines and internal metallic water pipe system, if present, are connected together. This precaution may be particularly important in rural areas.

Caution: Users should not attempt to make such connections themselves, but should contact the electric inspection authority, or electrician, as appropriate.

The Load Number (LN) assigned to each terminal device denotes the percentage of the total load to be connected to a telephone loop that is used by the device, to prevent overloading. The termination on a loop may consist of any combination of devices subject only to the requirement that the total of the Load Numbers of all the devices does not exceed 100.

For service in Canada call (800) 939-3769

In the USA, it's Illegal to copy the following

Congress, by statute, has forbidden the copying of the following items. Penalties of fine or imprisonment may be imposed on those guilty of making such copies. This list is not all-inclusive. In case of doubt, consult your attorney.

1. Copyrighted material, unless permission of the copyright owner has been obtained or the copying falls within the "fair use" or library reproduction provisions of the copyright law. Further information of these provisions may be obtained from the Copyright Office, Library of Congress, Washington, DC 20559 (circular R21).
2. United States Government obligations or securities such as:
 - 1 Certificates of Indebtedness
 - 1 Coupons from Bonds
 - 1 Gold and Silver Certificates
 - 1 Treasury Notes and United States Bonds
 - 1 Federal Reserve and Federal Reserve Bank Notes
 - 1 Certificates of Deposit
 - 1 National Bank currency
 - 1 Fractional Notes
 - 1 Paper money and Postal Money Orders
 - 1 Bonds and obligations of certain agencies of the government, such as FHA
 - 1 Bonds. (US Savings Bonds may be photographed only for publicity purposes in connection with the campaign for the sale of such bonds)
 - 1 Internal Revenue Stamps. (If it is necessary to copy a legal document on which there is a cancelled revenue stamp, this may be done provided the reproduction of the document is performed for lawful purposes)
 - 1 Postage Stamps, cancelled or uncanceled. (For philatelic purposes, postage stamps may be photographed provided the reproduction is black and white and less than 3/4 or more than 1 1/2 times the linear dimensions of the original)
 - 1 Bills, checks, or drafts for money drawn by or on authorized offices of the United States

- 1 Stamps and other representatives of value, of whatever denomination, which may be or have been issued under any Act of Congress
3. Adjusted compensation Certificates for veterans of the World Wars.
4. Obligations or Securities of any foreign government, bank, or corporation.
5. Certificates of Citizenship or Naturalization. (Foreign naturalization certificates may be photographed).
6. Passports. (Foreign passports may be photographed).
7. Immigration papers.
8. Badges, identification cards, passes or insignias carried by military or Naval personnel, or by members of the various Federal Departments and Bureaus, such as the FBI and Treasury (unless the photograph is ordered by the head of such Department or Bureau).
9. Copying of the following is also prohibited in certain states: automobile licences, driver's licenses, and automobile Certificates of Title.
10. Draft Registration cards and Selective Service Induction papers which bear any of the following information:
 - 1 Registrant's earnings or income
 - 1 Registrant's dependency status
 - 1 Registrant's court record
 - 1 Registrant's previous military service
 - 1 Registrant's physical or mental condition

Exception: US Army and Navy discharge certificates may be photographed.

Table of Contents

Introduction	1-1
How to Use this Document	1-2
Document Centre Options	1-3
Conventions used in this document	1-4
Other Sources of Information	1-5
ST Model Features	1-7
How to Connect to Ethernet or Token Ring Networks	2-1
Before You Connect to a 100BaseT Ethernet Network	2-1
How to set the Ethernet Speed	2-2
Before You Connect to a Token Ring Network	2-3
How to set the Ring Speed and Source Routing	2-4
How to set the Hardware (MAC) Address	2-5
Dynamic IP Address Assignment & WINS	3-1
Before you start	3-1
Dynamic Addressing (DHCP or BOOTP)	3-2
Dynamic Addressing (RARP)	3-6
Windows Internet Name Service (WINS) Installation	3-10
CentreWare Device Admin Wizard	4-1
Before you start	4-1
Go to the printer and... ..	4-2
Go to the workstation and... ..	4-3

Go to the printer and...	4-4
Go to a workstation and...	4-5
Novell NetWare 4.X and 5.X (NDS) Networks	5-1
Before You Start	5-1
Go to the printer and...	5-2
Go to a workstation and...	5-5
Novell NetWare 3.1x or 4.x/5.x in Bindery Mode	6-1
Before you start	6-1
Go to the printer and...	6-2
Go to a workstation and...	6-6
UNIX Networks	7-1
Before You Start	7-1
Go to the printer and...	7-2
Go to a workstation and...	7-5
Microsoft (NetBEUI) Networks	8-1
Before You Start	8-1
Go to the printer and...	8-2
Go to the workstations and...	8-5
Microsoft (TCP/IP) Networks	9-1
Before You Start	9-1
Go to the printer and...	9-2
Go to the workstation and...	9-6
Windows 2000 LPR and IPP Printing	10-1
Before you Start	10-1
Go to the printer and...	10-2
Go to the Server/Workstation and...	10-5
Microsoft Windows NT 4.X Server Network (TCP/IP)	11-1
Before you Start	11-1
Go to the printer and...	11-2

Go to the server and...	11-5
Go to the workstation and...	11-7
OS/2 (TCP/IP) Networks	12-1
Before You Start	12-1
Go to the printer and...	12-2
Go to a workstation and...	12-5
OS/2 (NetBEUI) Networks	13-1
Before You Start	13-1
Go to the printer and...	13-2
Go to the workstations and...	13-5
Macintosh Networks (AppleTalk)	14-1
Before you start	14-1
Go to the printer and...	14-2
Go to the workstation and...	14-4
Banyan VINES Network	15-1
Go to the printer and...	15-1
Go to the server and...	15-3
Internet Services	16-1
Overview	16-1
Before You Start	16-2
Configure your printer	16-3
Configure your Web Browser	16-4
Troubleshooting	17-1
Overview	17-1
TCP/IP Troubleshooting	17-2
NetWare Troubleshooting	17-5
Microsoft (NetBIOS/NetBEUI) Troubleshooting	17-7
OS/2 Troubleshooting (TCP/IP)	17-9
AppleTalk Troubleshooting	17-11

Banyan VINES Troubleshooting	17-13
OfficeTrac Network Accounting	18-1
OfficeTrac Troubleshooting	18-8
Faxing with RightFAX	19-1
RightFAX Installation for FTP	19-2
RightFAX Installation for IPX/SPX	19-6
RightFAX Troubleshooting	19-10
Scan Setup without CentreWare	20-1
Terminology used in this Chapter	20-2
Who Should Use This Guide	20-3
What to Do Next	20-4
Scanning Overview	20-5
The Scanning Process	20-8
Overview of Repositories	20-11
Before You Start	20-17
Set Up Options	20-18
General Installation Requirements	20-20
Test scanning	20-26
Before You Start	20-29
Set Up Options	20-30
General Installation Requirements	20-32
Set Up Scanning	20-33
Test scanning	20-37
Hints and Tips	20-40
Installation Considerations	20-41
Problem Solving	20-43
Error Messages	20-44
Port 9100 Printing	21-1
Glossary	22-1

Introduction

This document provides an experienced Systems Administrator with information for setting up and troubleshooting the Document Centre family of products on the various networks indicated.

Requirements

This document assumes you have purchased your printer with the integrated network interface or have purchased a Token Ring network interface upgrade kit separately and it has been installed using the instructions provided.

In general, the requirements needed for connection and setup include:

- A working knowledge of your network.
- Appropriate cabling to connect your printer to your network.
- A workstation with the appropriate operating system software installed for that station connected to the same network as the printer.
- CentreWare Admin Services CD-ROM to install CentreWare applications.
- CentreWare Network Services CD-ROM to install print drivers.

How to Use this Document

This document has been arranged to get the printer set up on your network quickly and with minimum reading.

1. Before connecting network cabling to the Document Centre device, perform the procedure contained in this document entitled **How to Connect to Ethernet / Token Ring Networks**.
2. For Dynamic TCP/IP addressing use either the **DHCP/BOOTP Dynamic IP Address Assignment Quick Install Card** or the **RARP Dynamic IP Address Assignment Quick Install Card**.
3. Review the Table of Contents. Find the network operating system (NOS) or protocol, which pertains to your network.
4. Go to the page indicated and perform the procedure(s).
5. Once you are finished it is recommended you print a test page.
6. Check the print job for print quality. If print quality problems exist, use the **Problem Solving** section of the **Reference Guide** to correct the problem.
7. If your print job **DID NOT** print, see the Troubleshooting section for your operating system in this document to correct the problem.
8. Once your Document Centre is installed and printing, you can repeat these steps to enable your printer to print with additional protocols or network operating systems.

NOTE

For detailed safety information about this product refer to the **Document Centre Reference Guide**.

Document Centre Options

The Document Centre can be used as a high speed scan device. If you have a workstation on your network that has a 32 bit version of Windows, you can use Xerox CentreWare Scanning Admin Wizard to configure your Document Centre as a network scanner. Details on this are available in the document supplied with your Document Centre entitled **CentreWare Network Scanning Services Guide**.

For installation instructions on connecting your Document Centre as a scanner without the use of CentreWare, refer to the section in this document entitled **Scan Setup without CentreWare**.

The Document Centre also supports the EquiTrac OfficeTrac network accounting software. For installation instructions on connecting to an OfficeTrac server, refer to the **EquiTrac OfficeTrac Quick Install Card** or the section in this document entitled **OfficeTrac Network Accounting**.

The Document Centre supports RightFAX to allow it to be used as a high speed fax device. For installation instructions on connecting to a RightFAX server, refer to the **RightFAX Quick Install Cards** or the section in this document entitled **Faxing with RightFAX**.

Conventions used in this document

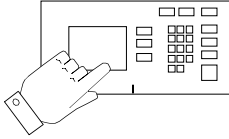

This symbol indicates that entries will be made on the printer's keypad or Touch Screen.

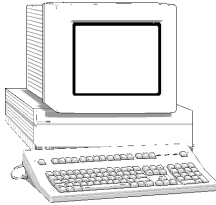

This symbol indicates that entries will be made at a workstation or fileserver.

NOTE:

When you see this text in the left margin, it indicates the text to the right is of special importance and should be read before proceeding.

Other Sources of Information

Setup and Copy / Scan / Fax features information:

- The **Reference Guide** provides detailed information about all features and settings as well as maintenance.
- The **User Guide** provides information and instructions about using the features of the machine to perform copy/scan/fax tasks.
- The **Help** system provides you point-of-need information.

CentreWare information:

- **CentreWare Network Services Guide** (hard copy). This document contains information about installation procedures for Xerox CentreWare print and fax drivers and installation and use of the features of the Xerox CentreWare Network Services software.
- **CentreWare Internet Services Guide** (hard copy). This document contains information about installation and use of the features of Xerox CentreWare Internet Services.
- **CentreWare Help Centre and Context-Sensitive Help Systems** (Electronic Help). This electronic documentation is supplied with the CentreWare software and can be viewed on the client workstation.

Xerox on the Web

- Use the Document Centre web site to get the latest information about the Xerox Document Centre:

<http://www.documentcentre.xerox.com>

- Download the latest CentreWare drivers at

<http://www.centroware.com>

- For more information about other Xerox products visit the Xerox Corporation main page at:

<http://www.xerox.com>

ST Model Features

What is the ST?

The ST model is simply the ability to make copies as well as print. ST models have full copy (and optional Scan/Fax) capability .

Document Feeder and Scanner

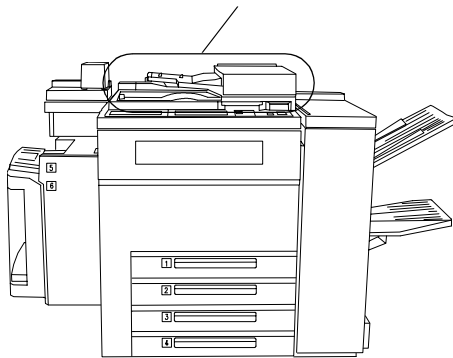

User Interface

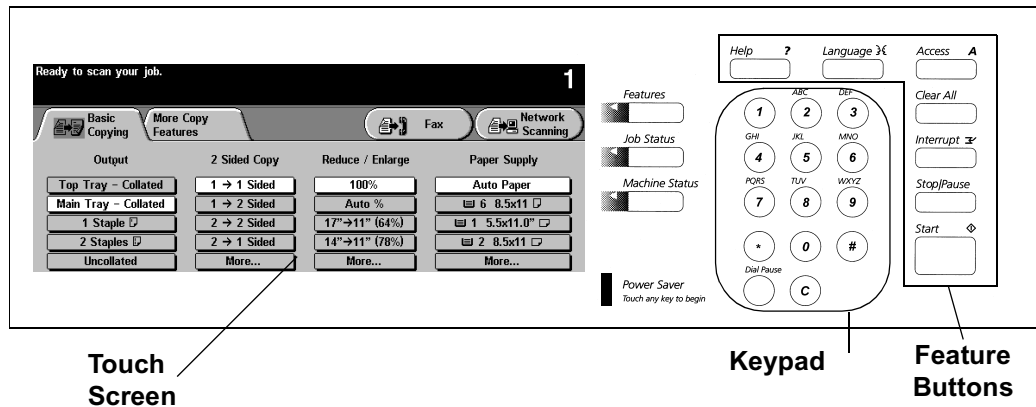

Network Connections

Use UTP/STP (Category 3 or 5 for 10Mbps Ethernet, Category 5 for Token Ring or 100Mbps Fast Ethernet) type of cable to connect to the network as indicated below.

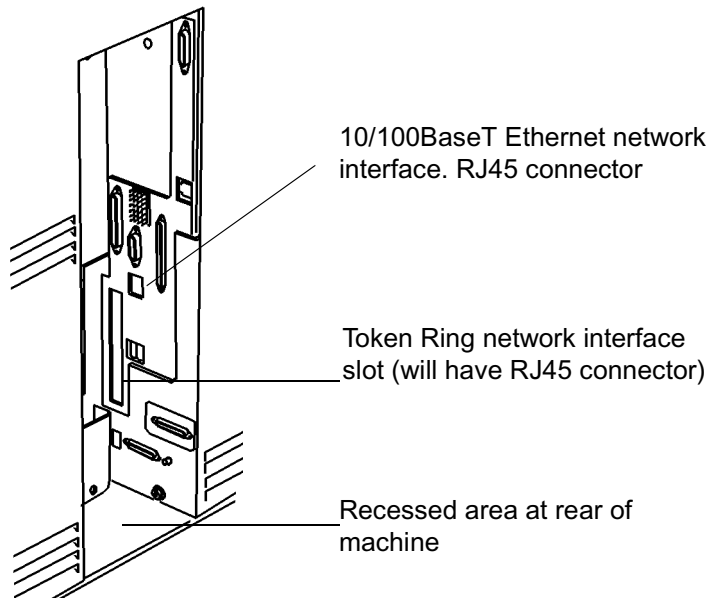

How to Connect to Ethernet or Token Ring Networks

*How to Connect to
Ethernet or Token Ring*

Before You Connect to a 100BaseT Ethernet Network

The Document Centre Ethernet Interface has speed settings of **10MBPS (10 Megabits per second)**, **100MBPS (100 Megabits per second)** and **Auto (AutoSensing)**. If your network has hubs or concentrators that have Auto-Sensing enabled, it is possible that if the Document Centre is set to **Auto**, the hub/concentrator will not arbitrate to the correct speed.

Before you connect the printer to your network, perform the procedure on the next page entitled **How to set the Ethernet Speed**.

How to set the Ethernet Speed

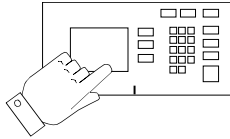

1. Enter the **Tools** pathway
 - a) Press the **Access (A)** button.
 - b) On the keypad enter **1111** or the current password. Press the **Enter** button when finished. Press the **Go to Tools** button.
 - c) The Touch Screen will be used for the remainder of the data entry.
2. Set or Change the Network Connection Speed.
 - a) Press the **Connectivity and Network Setup** button.
 - b) Press the **Physical Media** button.
 - c) Press the **Ethernet** button.

NOTE

Auto-Sensing hubs may not arbitrate correctly with the Document Centre when **Auto** is selected. If your hubs/concentrators support the 100BaseT speed it is recommended you select **100MBPS** in Step d below. (Be sure your Ethernet cable is Category 5)

- d) Select the desired network Speed **10MBPS (10 Megabits per second)**, **100MBPS (100 Megabits per second)** or **Auto (AutoSensing)**.
 - e) When finished with your changes press **Save**.
3. Press the **Exit Tools** button.
4. **Wait a MINIMUM of 7 minutes** for the printer to reset.
 - a) Obtain a **Configuration Report** page from your printer and verify that your settings have been retained.
5. Connect your Document Centre to the network with the appropriate cabling.

Before You Connect to a Token Ring Network

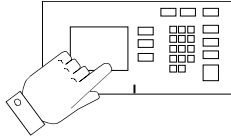

If your printer is equipped with a Token Ring interface, to avoid problems with your network you must configure the correct Ring Speed and Source Routing settings for your environment prior to connecting the printer to your network.

The default settings for the Ring speed and Source Routing are **16Mbps** and **None** respectively. If you do not need to change these then you do not need to read any further in this chapter.

NOTE

As with any other Token Ring device, connecting the Document Centre Token Ring card to your network while it is set at the incorrect Ring Speed can cause severe problems on your network.

Before you connect the printer to your network, perform the procedure on the next page entitled **How to set the Ring Speed and Source Routing**.

*How to Connect to
Ethernet or Token Ring*

How to set the Ring Speed and Source Routing

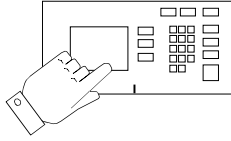

1. Enter the **Tools** pathway
 - a) Press the **Access (A)** button.
 - b) On the keypad enter **1111** or the current password. Press the **Enter** button when finished. Press the **Go to Tools** button.
 - c) The Touch Screen will be used for the remainder of the data entry.
2. Set or Change the Ring Speed or Source Routing.
 - a) Press the **Connectivity and Network Setup** button.
 - b) Press the **Physical Media** button.
 - c) Press the **Token Ring** button.
 - d) Press the **Token Ring Settings** button.
 - e) Select the desired Ring Speed (**4 Megabits** or **16 Megabits** per second).
 - f) Select the desired method of Source Routing (**Single Route Broadcast** or **All Route Broadcast**).
 - g) When finished with your changes press **Save**.
3. Press the **Exit Tools** button.
4. **Wait a MINIMUM of 7 minutes** for the printer to reset.
 - a) Obtain a **Configuration Report** page from your printer and verify that your Token Ring Settings have been retained.
5. Connect your Document Centre to the network with the appropriate cabling.

How to set the Hardware (MAC) Address

All Document Centre printers equipped with a Token Ring interface have a default MAC address which will enable communication on a Token Ring network. It is **STRONGLY** recommended that you use caution when changing the MAC Address of the network interface.

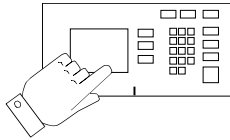

1. Access the **Tools** pathway.
 - a) Press the **Access (A)** button.
 - b) Enter **1111** (or the current password) then press the **Enter** button on the Touch Screen. Press the **Go to Tools** button.
 - c) The Touch Screen will be used for the remainder of the data entry.
2. Set or Change the MAC address.
 - a) Press the **Connectivity and Network Setup** button.
 - b) Press the **Physical Media** button.
 - c) Press the **Token Ring** button.
 - d) Press the **Token Ring Settings** button.
 - e) Press the **MAC Address** button.
 - f) Enter the six (6) hexadecimal pairs on the touch keypad separated by colons.
 - g) When finished press **Save**.
 - h) Press the **Exit Tools** button.
3. **Wait a MINIMUM of 7 minutes** for the printer to reset.
 - a) Obtain a **Configuration Report** page from your printer and verify that your Token Ring Settings have been retained.
4. Connect your Document Centre to the network with the appropriate cabling.

*How to Connect to
Ethernet or Token Ring*

Dynamic IP Address Assignment & WINS

Before you start

NOTE:

Your Document Centre now has DHCP, LPR, and NetBIOS over the IP protocol enabled by default. If your DHCP server will provide host name, IP address, Gateway address, and Subnet Mask, the Document Centre TCP/IP information will be configured on initial boot.

Your Document Centre printer can be connected to a variety of networks that use the TCP/IP protocol. The Document Centre supports two methods of Dynamic Addressing:

DHCP (Dynamic Host Configuration Protocol) or BOOTP

RARP (Reverse Address Resolution Protocol)

This section contains procedures for each of these methods. Determine which method will be used for your network and follow the steps of the appropriate procedure.

Dynamic Addressing (DHCP or BOOTP)

The TCP/IP address is assigned automatically by a DHCP server. Follow the steps below:

NOTE

By default, DHCP is enabled on the Document Centre. This procedure will show you how to disable DHCP (or enable it if it was disabled) and set your TCP/IP information using BOOTP.

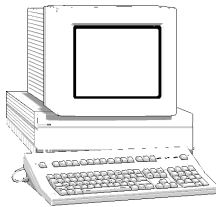

Go to the DHCP or BOOTP server and...

1. Configure the server with the TCP/IP information you want assigned to your printer. Use the documentation supplied with your server software for this task.

Go to the printer and...

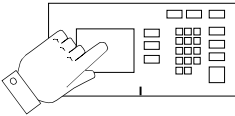

2. Connect your Document Centre to the network with the appropriate cabling.
3. Enter the **Tools** pathway
 - a) Press the **Access (A)** button.
 - b) On the keypad enter **1111** or the current password. Press the **Enter** button when finished. Press the **Go to Tools** button.
 - c) The Touch Screen will be used for the remainder of the data entry.

4. Enter the Network Setup menus.
 - a) Wait for the screen to refresh and press the **Connectivity and Network Setup** button.
 - b) Wait for the screen to refresh and press the **Network Setup** button.
 - c) Press the **TCP/IP Options** button.
5. Enable TCP/IP printing.
 - a) Press the **TCP/IP Settings** button.
 - b) Press the **Protocol and Media** button.
 - c) Press the **Enable** button. If Physical Media buttons appear, select either **Ethernet** or **Token Ring**. Press **Save**.
6. Set the Host Name (skip steps 6a-6c if your DHCP or BOOTP server supplies this information).
 - a) Press the **Name/Address** button.
 - b) Press the **Host Name** button.
 - c) When the soft keypad appears, type the host name EXACTLY as you want it to appear with correct case. When finished press the **Save** button to record the changes and exit to the **TCP/IP Settings** screen.
7. Set the Subnet Mask and Gateway (Skip steps 7a-7b if your DHCP or BOOTP server supplies this information). The Document Centre will only accept one Gateway address from the DHCP or BOOTP server.
 - a) Press the **Subnet and Gateway** button.
 - b) Press the soft buttons on the Touch Screen one at a time for each octet of the Subnet Mask and enter the numbers from the keypad. Repeat this process for the IP Gateway address. When finished press **Save** to record the changes and exit to the **TCP/IP Settings** screen.

NOTE:

The Broadcast address will be calculated automatically

8. Press the **Close** button.
 - a) Press the **Dynamic Addressing** button. At the next screen select **DHCP or BOOTP** and press **Save**.
9. Enable **lp** and **lpr** printing (skip steps 9a-9b if you **DO NOT** wish to print to your Document Centre using lp or lpr.
 - a) Press the **TCP/IP - Line Printer** button. At the next screen press the **Enable** button.

NOTE:

While you can change the port number at which your Document Centre will accept lpr print jobs it is recommended that you do this **ONLY** with extreme caution as most lpr spoolers are set to send print jobs to the default port.

- b) If you wish to change the lpr port for your printer press the port soft button and enter the desired port number at the keypad. Press **Save**.
 - c) Press the **Close** button.
10. Press the **Exit Tools** button.
 - a) Obtain a **Configuration Report** page from your printer. Verify the TCP/IP information was assigned correctly.
 - b) Update the lease time (if necessary) at the DHCP or BOOTP server depending on your printer usage patterns. Consult your server documentation for details.

Where to go from here

After you have verified that the TCP/IP information you have assigned to your Document Centre is correct, go to the section of this document that applies to your network operating system or protocol and perform the procedures indicated.

*Dynamic IP Address
Assignment & WINS*

Dynamic Addressing (RARP)

If your printer is equipped with a Token Ring interface, prior to connecting your printer to your network, use the section of this document entitled **Token Ring Interface Network Connection** to set the Ring Speed and Source Routing settings for your environment. Then return to this procedure and follow the instructions.

RARP servers vary in the information that they return to the host computer requesting service. Your Document Centre can retrieve the following values from a RARP server:

TCP/IP Address
Subnet Mask

Consult the documentation supplied with your RARP server software to verify what TCP/IP information it is capable of supplying.

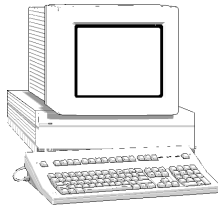

Go to the RARP or BOOTP server and...

1. Configure the server with the TCP/IP information you want assigned to your printer.

Go to the printer and...

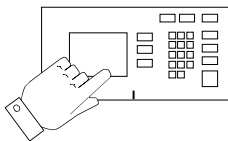

2. Connect your Document Centre to the network with the appropriate cabling.
3. Enter the *Tools* pathway
 - a) Press the **Access (A)** button.
 - b) On the keypad enter **1111** or the current password. Press the **Enter** button when finished. Press the **Go to Tools** button.
 - c) The Touch Screen will be used for the remainder of the data entry.

4. Enter the Network Setup menus.
 - a) Wait for the screen to refresh and press the **Connectivity and Network Setup** button.
 - b) Wait for the screen to refresh and press the **Network Setup** button.
 - c) Press the **TCP/IP Options** button.
5. Enable TCP/IP printing.
 - a) Press the **TCP/IP Settings** button.
 - b) Press the **Protocol and Media** button.
 - c) Press the **Enable** button. If Physical Media buttons appear, select either **Ethernet** or **Token Ring**. Press **Save**.
 - d) Press the **Automatic Addressing** button. At the next screen select **RARP** and press **Save**.
6. Press the **Exit Tools** button.
7. Wait approximately 2 minutes for the printer to receive the TCP/IP information from the RARP server.
 - a) Obtain the **Configuration Report** page from your printer. Verify the Document Centre printer TCP/IP information was assigned correctly by the server.
 - b) Repeat Steps 3a-5a then go to step 8.

NOTE:

The Broadcast address will be calculated automatically

8. Set the Host Name (skip steps 8a-8c if your server supplies this information).
 - a) Press the **Name/Address** button.
 - b) Press the **Host Name** button.
 - c) When the soft keypad appears, type the host name EXACTLY as you want it to appear with proper case. When finished press the **Save** button to record the changes and exit to the **TCP/IP Settings** screen.

9. Set the Subnet Mask and Gateway (skip steps 9a-9b if your server supplies this information).
 - a) Press the **Subnet and Gateway** button.
 - b) One at a time press the soft buttons on the touch screen for each octet of the Subnet Mask and enter the numbers from the keypad. Repeat this process for the IP Gateway address. When finished press **Save** to record the changes and exit to the **TCP/IP Settings** screen.
 - c) Press the **Close** button.
10. Enable **lp** and **lpr** printing (skip steps 10a-10b if you **DO NOT** wish to print to your Document Centre using lp or lpr).
 - a) Press the **TCP/IP - Line Printer** button. At the next screen press the **Enable** button.

NOTE:

While you can change the port number at which your Document Centre will accept lpr print jobs it is recommended that you do this **ONLY** with extreme caution as most lpr spoolers are set to send print jobs to the default port.

- b) If you wish to change the lpr port for your printer press the port soft button and enter the desired port number at the keypad. Press **Save**.
 - c) Press the **Close** button.
 - d) Press the **Exit Tools** button.
11. **Wait a MINIMUM of 7 minutes** for the printer to reset.
 - a) Review the **Configuration Report** page.
 - b) Obtain the Document Centre printer MAC address and TCP/IP address information from the **Configuration Report** page.
 - c) If your server does not dynamically update the **/etc/ethers** and **/etc/hosts** files with a host name, you will need to do this manually. Consult your server documentation for details.

Where to go from here

After you have verified that the TCP/IP information you have assigned to your Document Centre is correct, go to the section of this document that applies to your network operating system or protocol and perform the procedures indicated.

If you are configuring your Document Centre to register with a WINS server, proceed to the next section of this chapter entitled **Windows Internet Name Service (WINS) Installation**. If you prefer there is also a Quick Install Card for this process supplied with your Document Centre. Look for a card entitled **WINS (Windows Internet Name Service) Quick Install Card**.

Windows Internet Name Service (WINS) Installation

Before You Start

If your printer is equipped with a Token Ring interface, use the **100BaseT Ethernet or Token Ring Quick Install Card** supplied in this Quick Install Card set to configure the Ring Speed and Source Routing settings for your environment.

Your Document Centre now has DHCP, LPR, and NetBIOS over the IP protocol enabled by default. If your DHCP server will provide the IP address, Gateway address, Subnet Mask for the Document Centre, and WINS server address(es), the TCP/IP information will be configured on initial boot. This means that if you have configured your DHCP server with the desired information, you may connect your Document Centre to your network and it will boot and register with the WINS server automatically.

NOTE:

Your DHCP server must return at least one (1) WINS server address to the Document Centre in order to enable WINS registration.

In this mode the default NetBIOS host name, SMB host name and the DNS host name for the device will be the letters **XXR** followed by the MAC address of the network interface.

Example:
XXR08003E313E0A

If this NetBIOS host name is acceptable you can go right to the section in the next section entitled **Go to the Workstation and....** and complete those steps.

To change the **NetBIOS host name** for your printer follow Steps 1,2, and 3 then skip to Step 5 and finish the **Go to the Printer...** portion. When you finish that section, go to the section entitled **Go to the Workstation and....** and complete those steps.

Go to the printer and...

1. Connect your Document Centre to the network with the appropriate cabling
2. Enter the Tools pathway
 - a) Press the **Access (A)** button.
 - b) On the keypad enter **1111** or the current password. Press the **Enter** button when finished. Press the **Go to Tools** button.
 - c) The Touch Screen will be used for the remainder of the data entry.
3. Enter the Network Setup menus
 - a) Wait for the screen to refresh and press the **Connectivity and Network Setup** button.
 - b) Wait for the screen to refresh and press the **Network Setup** button.
 - c) Press the **Microsoft Networks** button.
4. Enable the Transport and Media
 - a) Press the **Transport and Media** button.
 - b) Press the **Enable** button. If Physical Media buttons appear, select either **IP/Ethernet** or **IP/Token Ring**. Press **Save**.

5. Set the NetBIOS Host Name
 - a) Press the **Workgroup and Host** button.
 - b) Press the **SMB Host Name** (this is the same as the NetBIOS host name) button.
 - c) When the soft keypad appears, type the host name EXACTLY as you want it to appear with correct case. When finished press the **Save** button to record the changes and exit to the Workgroup and Host Screen.
 - d) Press the **Close** button.
6. Exit the Tools Menu
 - a) Press the **Exit Tools** button.
 - b) The Document Centre will reconfigure itself with the new settings and automatically register its TCP/IP address and NetBIOS host name with your WINS server.

Go to the workstation and...

1. Create a new lpr printer on the NT workstation
 - a) With an LPR port as the desired destination, enter the Microsoft Networking host name.
 - b) Enter a queue name to identify the printer.
 - c) When prompted, select the desired PostScript or PCL driver from the **Xerox CentreWare Network Services CD** or directory where drivers are stored.

CentreWare Device Admin Wizard

Before you start

This procedure assumes you have already installed CentreWare applications on a Windows 95/98 or Windows NT workstation. If you have not done so, detailed instructions for installation are contained in the **CentreWare Network Services Guide**. This document was supplied with your printer.

In order to use the CentreWare Device Admin Wizard for installation, you must login to the fileserver or Tree with Supervisor or Administrator privileges. Additionally, You will need the following NetWare information:

NDS Tree (NetWare 4.X and 5.X environment)

NDS Context (NetWare 4.X and 5.X environment)

Primary Fileserver (NetWare 3.X environment)

Frame Type

Additionally, you must set **NCP packet signature** option to **0,1**, or **2** (3 is not supported), AND set **Reply to get nearest server** to **ON** for at least one file server that is on the same segment as the printer.

*CentreWare Device
Admin Wizard*

Go to the printer and...

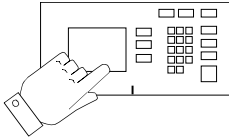

1. Connect your Document Centre to the network with the appropriate cabling.
2. Enter the Tools Menu.
 - a) On the printer keypad, press the **Access (A)** button.
 - b) A password entry field will appear. On the keypad enter **1111** or your current password then touch the **Enter** button on the Touch Screen. The Touch Screen will be used for the remainder of the data entry.
 - c) Press the **Go to Tools** button.
3. Enable the Network Protocol.
 - a) Press the **Connectivity and Network Setup** button.
 - b) Wait for the screen to refresh and press the **Network Setup** button.
 - c) Press the **NetWare** button.
 - d) Wait for the screen to refresh and press the **Protocol and Media** button.
 - e) Press the **Enable** button. If Physical Media buttons appear, select either **Ethernet** or **Token Ring**. Press **Save**.
4. Set the Frame Type.
 - a) Press the **Frame Type** button.
 - b) Select the frame type desired then press **Save** to retain your changes and exit to the NetWare Options screen.
5. Exit the Tools Menu.
 - a) Press the **Exit Tools** button. The printer will store the settings you have made.

Go to the workstation and...

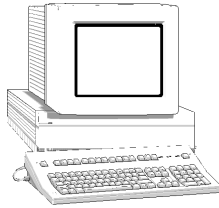

1. From the desktop click the **Start** button on the Task Bar.
2. Select the **Programs** entry in the menu.
3. From the cascade menu select the **Xerox CentreWare** entry.
4. On the next cascade menu select the **Admin Services** entry.
5. On the next cascade menu select the **Device Admin Wizard**.
6. The Device Admin Wizard will start.
7. Follow the instructions on each Device Admin Wizard Screen to setup the Document Centre on your network. Context sensitive help is available for each step.

NOTE:

You will be asked for a password, enter “**1111**” (or the current Admin password for your printer that you would enter from the keypad), then click OK.

8. The Device Admin Wizard will complete the installation by writing the settings to the Document Centre and the Novell Server.

*CentreWare Device
Admin Wizard*

Go to the printer and...

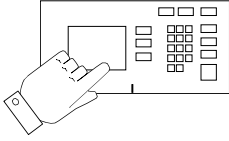

1. Power off and power on the Document Centre so the setup selections will take effect.
2. **Wait a MINIMUM of 7 minutes** for the printer to reset.
3. From the documentation package supplied with your printer, retrieve the **CentreWare Network Services CD-ROM** and the document entitled **Network Services Guide**. Proceed to the next section of this procedure called **Go to a Workstation and...**

Go to a workstation and...

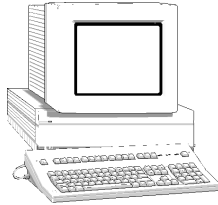

1. Use the **CentreWare Network Services CD-ROM** to install print drivers on a Windows-based workstation. Details for this are found in the document supplied with your printer entitled **Network Services Guide**.
2. Connect the print driver you loaded above to the queue you created on the NetWare server.
3. Open an application and print a test job.
4. Check your test job for quality and use the problem solving section of the **Document Centre Reference Guide** for resolving print defects.
5. If your test job does not print, refer to the troubleshooting section in this document to correct the problem.
6. Repeat this **Go to a workstation and...** procedure at each workstation that will print to this printer.

Novell NetWare 4.X and 5.X (NDS) Networks

*Novell NetWare 4.X and
5.X (NDS) Networks*

Before You Start

NOTE:

Your Document Centre may be installed on your network using Novell NDPS. The Xerox NDPS Agent, Documentation, and Print drivers are available from the Xerox Web Site www.xerox.com

To enable 100BaseT or a Token Ring interface, refer to Chapter 2 **How to Connect to Ethernet or Token Ring Networks** to configure the Speed and Source Routing settings for your environment.

The CentreWare software supplied with your printer can be used to set up your printer on your Novell network. For details refer to the document entitled **CentreWare Network Services Guide**.

This procedure assumes you ran NWADMIN or PCONSOLE to set up a print server object. Please refer to the documentation supplied by Novell to complete those tasks.

Record precisely (observe upper and lower case, dot notation etc.) the following: the **NDS Tree**, **NDS Context Name**, **frame type**, **Print Server Name**, and the **Print Server password**, that was assigned.

Additionally, you must set **NCP packet signature** option to **0,1**, or **2** (3 is not supported), AND set **Reply to get nearest server** to **ON** for at least one file server that is on the same segment as the printer.

NOTE

ALL Print Servers you create must have a password. When your printer will service queues on multiple file servers, the Print Server name must be the same on all file servers and the Print Server password must be the same on all file servers.

Go to the printer and...

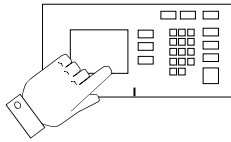

1. Connect your Document Centre to your network with the appropriate cabling.
2. Enter the **Tools** pathway
 - a) Press the **Access (A)** button.
 - b) On the keypad enter **1111** or the current password. Press the **Enter** button when finished. Press the **Go to Tools** button.
 - c) The Touch Screen will be used for the remainder of the data entry.
3. Enable the Network Protocol.
 - a) Press the **Connectivity and Network Setup** button.
 - b) Wait for the screen to refresh and press the **Network Setup** button.
 - c) Press the **NetWare** button.
 - d) Wait for the screen to refresh and press the **Protocol and Media** button.
 - e) Press the **Enable** button. If Physical Media buttons appear, select either **Ethernet** or **Token Ring**. Press **Save**.
4. Set the Frame Type
 - a) Press the **Frame Type** button.
 - b) Select the frame type desired then press **Save** to retain your changes and exit to the NetWare Options screen.
5. Set the NDS Settings

- a) Press the **NDS Settings** button.

Novell suggests using typeful names when entering Name Context and Directory Service Tree information.

TYPEFUL NAME EXAMPLE:

cn=contextname.ou=organization.o=company.c=country

- b) At this screen press the **Name Context** button and use the touch panel keyboard to enter the context in which this printer resides. To access numeric characters and punctuation, press the **More Characters** button. When finished press **Save**.
 - c) Press the **Directory Service Tree** button and enter the NDS tree name where the Context chosen in the previous step resides. Be sure to press **Save** when you have finished.
6. Set the Print Server Name and Password.
 - a) Press the **Print Server** button.
 - b) Press the **Print Server Name** button and use the Touch Screen keyboard to enter the name you assigned to your print server (it is recommended you use all UPPER CASE characters). A default name will appear. Use the backspace key (it looks like an arrow pointing to the left) to clear out the default name prior to entering your new name. When finished press **Save** to retain the changes and return to the Print Server Screen.
 - c) Press the **Print Server Password** button. Use the Touch Screen keyboard to enter the print server password you recorded when you set up your print server and press **Save**.
 - d) Press **Save** to exit the Print Server Screen and save your changes.

7. OPTIONAL STEP: To change the desired SAP rate or Poll Interval for your printer, press the **Rates** button.
 - a) Press the box under **SAP Rate** or **Poll Interval** and enter the desired number from the keypad. The default values are recommended. When finished, press **Save** to retain your changes and return to the NetWare Options screen.
8. Exit the Tools Menu.
 - a) Press the **Exit Tools** button. The printer will store the settings you have made.
9. Prepare for print driver installation
 - a) From the documentation package supplied with your printer, retrieve the **CentreWare Network Services CD-ROM** and the document entitled **CentreWare Network Services Guide**. Proceed to the next section of this procedure called **Go to a Workstation and...**

Go to a workstation and...

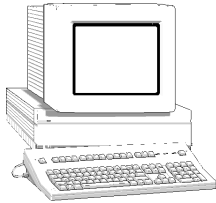

1. Use the **CentreWare Network Services CD-ROM** to install print drivers on a Windows-based workstation. Details for this are found in the document supplied with your printer entitled **CentreWare Network Services Guide**.
2. Connect the print driver you loaded above to the queue you created on the NetWare server.
3. Open an application and print a test job.
4. Check your test job for quality and use the problem solving section of the **Document Centre Reference Guide** for resolving print defects.
5. If your test job does not print, refer to the Troubleshooting section in this document to correct the problem.
6. Repeat this **Go to a workstation and...** procedure at each workstation that will print to this printer.

Novell NetWare 3.1x or 4.x/5.x in Bindery Mode

Before you start

To enable 100BaseT or a Token Ring interface, refer to Chapter 2 **How to Connect to Ethernet or Token Ring Networks** section to configure the Ring Speed and Source Routing settings for your environment.

The CentreWare software supplied with your printer can be used to set up your printer on your Novell network. For details refer to the document entitled **CentreWare Network Services Guide**. This procedure assumes you ran PCONSOLE to set up a print server. Please refer to the documentation supplied by Novell to complete this task. Record precisely (observe upper and lower case, punctuation etc.) the following: the **Primary Server name**, **Frame type** used, **Print Server name**, **Print Server password**, and the **Queue name** assigned.

Additionally, you must set **NCP packet signature** option to **0,1**, or **2** (3 is not supported), AND set **Reply to get nearest server** to **ON** for at least one file server that is on the same segment as the printer.

NOTE

ALL Print Servers you create must have a password. When your printer will service queues on multiple file servers, the Print Server name must be the same on all file servers and the Print Server password must be the same on all file servers.

Go to the printer and...

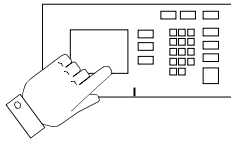

1. Connect your Document Centre to the network with the appropriate cabling.
2. Enter the **Tools** pathway
 - a) Press the **Access (A)** button.
 - b) On the keypad enter **1111** or the current password. Press the **Enter** button when finished. Press the **Go to Tools** button.
 - c) The Touch Screen will be used for the remainder of the data entry.
3. Enable the Network Protocol.
 - a) Press the **Connectivity and Network Setup** button.
 - b) Wait for the screen to refresh and press the **Network Setup** button.
 - c) Press the **NetWare** button.
 - d) Wait for the screen to refresh and press the **Protocol and Media** button.
 - e) Press the **Enable** button. If Physical Media buttons appear, select either **Ethernet** or **Token Ring**. Press **Save**.

4. Set the Primary File Server.
 - a) Press the **Primary File Server** button.
 - b) Press the upper-left keyboard icon button on the touch screen to set the first Primary File Server.
 - c) Use the touch panel keyboard and enter the name of the first Primary File Server to which you want the printer to connect. To access numeric characters and punctuation, press the **More Characters** button. When finished press the **Save** button.
 - d) You will be returned to the **NetWare Options** screen.
5. Set the Frame Type
 - a) Press the **Frame Type** button.
 - b) Select the frame type desired then press **Save** to retain your changes and exit to the **NetWare Options** screen.

*Novell NetWare 3.1x or
4.x/5.x in Bindery Mode*

6. Set the Print Server Name and Password.
 - a) Press the **Print Server** button.
 - b) Press the **Print Server Name** button and use the touch panel keyboard to enter the name you assigned to your print server (it is recommended you use all UPPER CASE characters). A default name will appear. Use the backspace key (it looks like an arrow pointing to the left) to clear out the default name prior to entering your new name. When finished press **Save** to retain the changes and return to the **Print Server** screen.
 - c) Press the **Print Server Password** button and use the Touch Screen keyboard to enter the print server password you recorded when you set up your print server and press **Save**.
 - d) Press **Save** to exit the Print Server screen and save your changes.
 - e) To change the desired SAP rate or its Poll Interval for your printer, press the **Rates** button.
 - f) Press the box under **SAP Rate** or **Poll Interval** and enter the desired number from the keypad. The default values are recommended. When finished, press **Save** to retain your changes and return to the NetWare Options screen.

7. Exit the Tools Menu.
 - a) Press the **Exit Tools** button. The printer will store the settings you have made.
8. Prepare for print driver installation
 - a) From the documentation package supplied with your printer, retrieve the **CentreWare Network Services CD-ROM** and the document entitled **CentreWare Network Services Guide**. Proceed to the next section of this procedure called **Go to a Workstation and...**

*Novell NetWare 3.1x or
4.x/5.x in Bindery Mode*

Go to a workstation and...

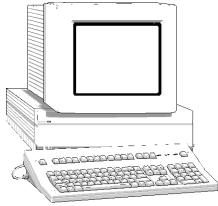

1. Use the **CentreWare Network Services CD-ROM** to install print drivers on a Windows-based workstation. Details for this are found in the document supplied with your printer entitled **CentreWare Network Services Guide**.
2. Connect the print driver you loaded above to the queue you created on the NetWare server.
3. Open an application and print a test job.
4. Check your test job for quality and use the Problem Solving section of the **Document Centre Reference Guide** for resolving print defects.
5. If your test job does not print, refer to the troubleshooting section in this document to correct the problem.
6. Repeat this **Go to a workstation and...** procedure at each workstation that will print to this printer.

UNIX Networks

Before You Start

To enable 100BaseT or a Token Ring interface, refer to Chapter 2 **How to Connect to Ethernet or Token Ring Networks** to configure the Ring Speed and Source Routing settings for your environment.

NOTE:

Your Document Centre now has DHCP, LPR, and NetBIOS over the IP protocol enabled by default. If your DHCP server will provide host name, IP address, Gateway address, and Subnet Mask, the Document Centre TCP/IP information will be configured on initial boot. This means that if you have configured your DHCP server with the desired information, you may go right to the section in this chapter entitled **Go to a Workstation and....**

This procedure assumes you are going to manually set your TCP/IP information and have recorded the IP Address, Subnet Mask, and Default Gateway IP address that is to be assigned to your printer. If it is necessary for your network, you will compute your Broadcast Address as part of this procedure.

For information on how your printer can connect to a BOOTP server, or a RARP server to be assigned an IP address dynamically, refer to the chapter in this document entitled **Dynamic IP Address Assignment & WINS**.

Your Document Centre printer supports printing from a variety of UNIX platforms. The procedure contained in this document will enable you to connect your printer in many of these environments.

Go to the printer and...

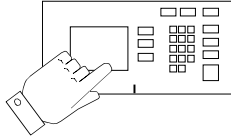

1. Connect your Document Centre to the network with the appropriate cabling.
2. Enter the **Tools** pathway
 - a) Press the **Access (A)** button.
 - b) On the keypad enter **1111** or the current password. Press the **Enter** button when finished. Press the **Go to Tools** button.
 - c) The Touch Screen will be used for the remainder of the data entry.
3. Enter the Network Setup menus.
 - a) Wait for the screen to refresh and press the **Connectivity and Network Setup** button.
 - b) Wait for the screen to refresh and press the **Network Setup** button.
 - c) Press the **TCP/IP Options** button.
4. Enable the network interface and protocol.
 - a) Press the **TCP/IP Settings** button.
 - b) Press **Dynamic Addressing**.
 - c) Press **Disabled** then press **Save**.
 - d) Press the **Protocol and Media** button.
 - e) Press the **Enable** button. If Physical Media buttons appear, select either **Ethernet** or **Token Ring**. Press **Save**.

5. Set the Host Name.
 - a) Press the **Name/Address** button.
 - b) One at a time press the soft buttons on the Touch Screen for each Octet of the IP address and enter the numbers from the keypad.
 - c) Press the **Host Name** button.
 - d) When the soft keypad appears, type the host name EXACTLY as you want it to appear with proper case. When finished press the **Save** button to record the changes and exit to the **TCP/IP Settings** screen.
6. Set the Subnet Mask and Gateway.
 - a) Press the **Subnet and Gateway** button.
 - b) Press the soft buttons on the touch screen one at a time for each octet of the Subnet Mask address and enter the numbers from the keypad. Repeat this process for the IP Gateway address. When finished press **Save** to record the changes and exit to the **TCP/IP Settings** screen.

NOTE:

The Broadcast Address will be calculated automatically.

- c) Press the **TCP/IP - Line Printer** button. At the next screen press the **Enable** button.

NOTE:

While you can change the port number at which your Document Centre will accept lpr print jobs it is recommended that you do this **ONLY** with extreme caution as most lpr spoolers are set to send print jobs to the default port.

- d) If you wish to change the lpr port for your printer press the port soft button and enter the desired port number at the keypad. Press **Save**.
 - e) Press the **Close** button.
 - f) Press the **Exit Tools** button.
7. Prepare for print driver installation
- a) From the documentation package supplied with your printer, retrieve the **CentreWare Network Services CD-ROM** and the document entitled **CentreWare Network Services Guide**. Proceed to the next section of this procedure called **Go to a Workstation and...**

Go to a workstation and...

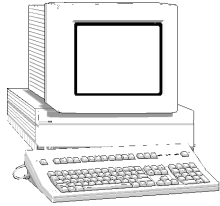

1. Add the printers host name, TCP/IP address, hardware address to your **/etc/hosts** file or **NIS database** depending on your UNIX version.
2. Create a queue using the CentreWare tool OR by using the native tools available in your operating system version.
3. Mount the **CentreWare Network Services** CD-ROM . Solaris/SunOS, HP-UX, and AIX users can load the CentreWare Print DCPR Tool. Details are contained in the document entitled **CentreWare Network Services Guide**.
4. Create a print job and send it to the printer.
5. Check your test job for quality and use the Problem Solving section of the **Document Centre Reference Guide** for resolving print defects.
6. If your print job does not print, refer to the Troubleshooting section in this document to correct the problem.
7. Repeat this **Go to a workstation and...** procedure at each workstation that will print to this printer.

Microsoft (NetBEUI) Networks

Before You Start

To enable 100BaseT or a Token Ring interface, refer to Chapter 2 **How to Connect to Ethernet or Token Ring Networks** to configure the Speed and Source Routing settings for your environment.

Go to the printer and...

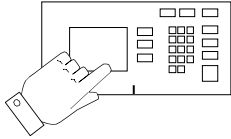

1. Connect your Document Centre to the network with the appropriate cabling.
2. Enter the **Tools** pathway
 - a) Press the **Access (A)** button.
 - b) On the keypad enter **1111** or the current password. Press the **Enter** button when finished. Press the **Go to Tools** button.
 - c) The Touch Screen will be used for the remainder of the data entry.
3. Enable Microsoft Network printing
 - a) Press the **Connectivity and Network Setup** button.
 - b) At the next screen, press the **Network Setup** button.
4. Enable the Protocol and Media
 - a) At the next screen, press the **Microsoft Networks** button.
 - b) At the next screen, press the **Transport and Media** button.
 - c) At the next screen, press the **Enable** button to enable the Microsoft Network protocols.
 - d) If Physical Media buttons appear. Press the corresponding button to select either **NetBEUI/Ethernet** or **NetBEUI/Token Ring**. After making your selection press **Save**.

5. Assign the Workgroup and Host names
 - a) You will be returned to the previous screen. Press the **Workgroup and Host** button.
 - b) At the next screen, press the **Workgroup Name** button, using the touch panel keys. Enter the name of the workgroup in which you want the printer to appear then press **Save**.
 - c) You will be returned to the previous screen. Press the **SMB Host Name** button. Using the Touch Screen, enter the desired text for this item then press **Save**.
 - d) OPTIONAL STEP: Press the **SMB Host Description** button, enter the desired text then press **Save**. You will be returned to the previous screen.
 - e) Press **Save** again to return to the previous screen.
6. Assign a Printer Name and Description
 - a) Press the **Printer Description** button.
 - b) Press the **Printer Name** button. Using the touch panel keys, enter the desired text for this item then press **Save**. Press **Save** again to return to the previous screen.
 - c) OPTIONAL STEP: Press the **Printer Description** button, using the touch panel keys, enter the desired text for this item then press **Save**.
 - d) Press the **Connections** button.

7. Set Maximum Connections and Timeout
 - a) Touch the **Maximum Connections** soft button on the Touch Screen and on the keypad enter the desired maximum connection number between 1 and 30. It is recommended that this value should be set at the default.
 - b) Touch the **Connection Timeout** soft button on the Touch Screen. On the keypad enter the desired number of seconds between 0 and 9999. Press **Save** to exit the connections screen.
8. Exit the Tools Menu.
 - a) Press the **Exit Tools** button. The printer will store the settings you have made.
9. Prepare for print driver installation
 - a) From the documentation package supplied with your printer, retrieve the **CentreWare Network Services CD-ROM** and the document entitled **CentreWare Network Services Guide**. Proceed to the next section of this procedure called **Go to a Workstation and...**
10. Obtain a **Configuration Report** from the printer to use in the remainder of the installation

Go to the workstations and...

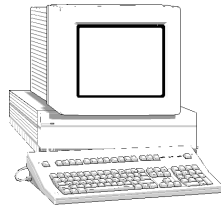

1. Verify that the **NetBEUI** protocol is loaded (ALL Windows 3.11 or greater versions).
2. Use the **CentreWare Network Services CD-ROM** to install print drivers on a Windows-based workstation. Details for this are found in the document supplied with your printer entitled **CentreWare Network Services Guide**.
3. On the Configuration Report review the **NetBIOS:** area and note the **Workgroup, Host Name, and Printer Name**.

Windows for Workgroups Users

- Open the **Control Panel** and double-click the **Printers** icon.
- Select the printer driver you just installed and click **Connect**.
- Select an available port and click **Network**.
- Double-click the name of the WorkGroup for the printer.
- Double-click the Host Name of the printer.
- Click once on the Printer Name then click **OK**.

Windows 95/98, Windows NT 4.0 WorkStation and Windows 2000 Users

- Click the **Start** button and select **Settings**.
 - From the cascade menu select **Printers**.
 - Select a printer with the right mouse button.
 - Select the **Properties** entry in the cascade menu.
 - Select the **Details** tab on the Properties dialog.
 - Click the **Add Port** button and browse to the Workgroup.
 - Double click the name of the WorkGroup for the printer as shown on the Configuration Report. Double click the Host Name of the printer as shown on the Configuration Report.
 - Click once on the Printer Name then click **OK**.
4. Open an application and print a test page to verify operation
 5. If your print job does not print, refer to the Troubleshooting section of this document to solve the problem

Microsoft (TCP/IP) Networks

Before You Start

NOTE:

Your Document Centre now has DHCP, LPR, and NetBIOS over the IP protocol enabled by default. If you have a DHCP server and it is set to provide host name, IP address, Gateway address, and Subnet Mask, the Document Centre TCP/IP information will be configured on initial boot. This procedure assumes you will set the IP information manually.

To enable 100BaseT or a Token Ring interface, refer to Chapter 2 **How to Connect to Ethernet or Token Ring Networks** to configure the Speed and Source Routing settings for your environment.

For information on how your printer can connect to a DHCP, BOOTP, or a RARP server to be assigned an IP address dynamically, refer to the section in this document entitled **Dynamic IP Address Assignment**.

Go to the printer and...

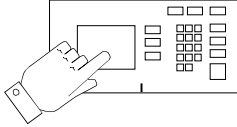

1. Connect your Document Centre to the network with the appropriate cabling
2. Enter the **Tools** pathway
 - a) Press the **Access (A)** button.
 - b) On the keypad enter **1111** or the current password. Press the **Enter** button when finished. Press the **Go to Tools** button.
 - c) The Touch Screen will be used for the remainder of the data entry.
3. Enter the Network Setup menus
 - a) Press the **Connectivity and Network Setup** button.
 - b) Press the **Network Setup** button.
4. Enable TCP/IP protocol
 - a) Press the **TCP/IP Options** button.
 - b) Press the **TCP/IP Settings** button.
 - c) Press the **Protocol and Media** button.
 - d) Press the **Enable** button. If Physical Media buttons appear, select either **Ethernet** or **Token Ring**. Press **Save**.

5. Set the LPR Host Name. (OPTIONAL: If you will not be printing to the Document Centre device with an LPR tool, Skip to Step 6.)
 - a) Press the **Name/Address** button.
 - b) Press the soft buttons one at a time on the touch screen for each Octet of the IP address and enter the numbers from the keypad.
 - c) Press the **Host Name** button.
 - d) When the soft keypad appears, type the SMB host name EXACTLY as you want it to appear with proper case. When finished press the **Save** button to record the changes and exit to the **TCP/IP Settings** screen.
6. Set the Subnet Mask and Gateway.
 - a) Press the **Subnet and Gateway** button.
 - b) Press the soft buttons one at a time on the Touch Screen for each Octet of the Subnet Mask and enter the numbers from the keypad. Repeat this process for the IP Gateway address. When finished press **Save** to record the changes and exit to the **TCP/IP Settings** screen.
 - c) Press the **Close** button.

NOTE:

The Broadcast Address will be calculated automatically.

7. Enable Microsoft Networking
 - a) Press the **Microsoft Networks** button.
 - b) At the next screen, press the **Transport and Media** button.
 - c) Press the **Enable** button to enable the Microsoft Network protocols.
 - d) If Physical Media buttons appear, press the corresponding button to select either **IP/Ethernet**, or **IP/Token Ring**. After making your selection press **Save**.
 - e) You will be returned to the previous screen. Press the **Workgroup and Host** button.
 - f) At the next screen, press the **Workgroup Name** button, using the touch panel keys. Enter the name of the workgroup in which you want the printer to appear then press **Save**.
 - g) Press the **SMB Host Name** (this will set the NetBIOS name) button, using the Touch Screen keys, enter the desired text then press **Save**.
 - h) OPTIONAL STEP: Press the **SMB Host Description** button and enter the desired text for this item, then press **Save**.
 - i) Press **Save** again to return to the previous screen.
 - j) Press the **Printer Description** button.
 - k) Press the **Printer Name** button, using the Touch Screen keys, enter the desired text for this item then press **Save**.
 - l) OPTIONAL STEP: Press the **Printer Description** button, using the touch panel keys and enter the desired text for this item, then press **Save**.
 - m) Press **Save** again to return to the previous screen.
 - n) Press the **Connections** button.

- o) Touch the **Maximum Connections** soft button on the Touch Screen and on the keypad enter the desired maximum connection number between 1 and 30. This number should be set to equal or greater than the number of workstations on your Peer to Peer network.
 - p) Touch the **Connection Timeout** soft button on the Touch Screen. On the keypad enter the desired number of seconds between 0 and 9999.
 - q) Press **Save** to exit the Connections Screen.
 8. Exit the Tools Menu.
 - a) Press the **Exit Tools** button. The printer will store the settings you have made.
 9. Prepare for print driver installation
 - a) From the documentation package supplied with your printer, retrieve the **CentreWare Network Services CD-ROM** and the document entitled **CentreWare Network Services Guide**. Proceed to the next section of this procedure called **Go to a Workstation and...**
 10. Obtain a **Configuration Report** from the printer to use in the remainder of the installation

Go to the workstation and...

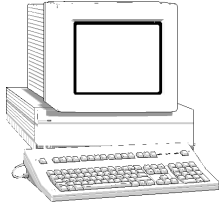

1. Verify that the TCP/IP protocol stack is loaded.
2. Use the **CentreWare Network Services CD-ROM** to install print drivers. Details for this are found in the document supplied with your printer entitled **CentreWare Network Services Guide**.

Windows 95/98, Windows NT 4.X Workstation and Windows 2000 Users

- Add a network printer as you normally would.
 - Browse for and Double-click the name of the **WorkGroup** for the printer as shown on the **Configuration Report**.
 - Double-click the **NetBIOS Host Name** of the printer as shown on the **Configuration Report**.
 - Click once on the **Printer Name** as shown on the **Configuration Report** then click **OK**.
 - For a new printer you will be prompted for a print driver. Select **Have Disk** and browse to the directory with the Document Centre driver, select it then click **OK**.
3. Open an application and print a test page to verify operation.
 4. If your print job does not print, refer to the Troubleshooting section of this document to solve the problem.
 5. Check your test job for quality and use the Problem Solving section of the **Document Centre Reference Guide** for resolving print defects.
 6. Repeat this **Go to the workstation and...** procedure for each workstation on the network that will print to the printer.

Windows 2000 LPR and IPP Printing

Before you Start

NOTE:

Your Document Centre now has DHCP, LPR, and NetBIOS over the IP protocol enabled by default. If your DHCP server will provide host name, IP address, Gateway address, and Subnet Mask, the Document Centre TCP/IP information will be configured on initial boot. This means that if you have configured your DHCP server with the desired information, you may connect your Document Centre to your network and go right to the section entitled **Go to the Server/Workstation and....**

You can use BOOTP or RARP servers to assign TCP/IP information to your Document Centre. Refer to the section in this document entitled **Dynamic IP Address Assignment**.

To enable 100BaseT or a Token Ring interface, refer to Chapter 2 **How to Connect to Ethernet or Token Ring Networks** to configure the Speed and Source Routing settings for your environment.

Go to the printer and...

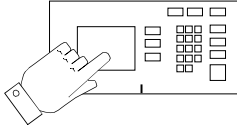

1. Connect your Document Centre to the network with the appropriate cabling
2. Enter the **Tools** pathway
 - a) Press the **Access (A)** button.
 - b) On the keypad enter **1111** or the current password. Press the **Enter** button when finished. Press the **Go to Tools** button.
 - c) The Touch Screen will be used for the remainder of the data entry.
3. Enter the Network Setup menus
 - a) Wait for the screen to refresh and press the **Connectivity and Network Setup** button.
 - b) Wait for the screen to refresh and press the **Network Setup** button.
 - c) Press the **TCP/IP Options** button.
4. Enable the Protocol and Media
 - a) Press the **TCP/IP Settings** button.
 - b) Press the **Protocol and Media** button.
 - c) Press the **Enable** button. If Physical Media buttons appear, select either **Ethernet** or **Token Ring**. Press **Save**.

5. Set the Host Name
 - a) Press the **Name/Address** button.
 - b) One at a time press the soft buttons on the Touch Screen for each Octet of the IP address and enter the numbers from the keypad.
 - c) Press the **Host Name** button.
 - d) When the soft keypad appears, type the host name EXACTLY as you want it to appear with proper case. When finished press the **Save** button to record the changes and exit to the TCP/IP Settings Screen.
6. Set the Subnet Mask and Gateway
 - a) Press the **Subnet and Gateway** button.
 - b) One at a time press the soft buttons on the Touch Screen for each octet of the Subnet Mask and enter the numbers from the keypad. Repeat this process for the IP Gateway address. When finished press **Save** to record the changes and exit to the TCP/IP Settings Screen.

NOTE:

The Broadcast Address will be calculated automatically.

- c) Press the **TCP/IP - Line Printer** button. At the next screen press the **Enable** button.

NOTE:

While you can change the port number at which your Document Centre will accept lpr print jobs, it is recommended that you do this ONLY with extreme caution as most lpr spoolers are set to send print jobs to the default port.

- d) If you wish to change the lpr port for your printer press the port soft button and enter the desired port number at the keypad. Press **Save**.
- e) Press the **Close** button.

7. Exit the Tools Menu.
 - a) Press the **Exit Tools** button. The printer will store the settings you have made.
 - b) Proceed to the next section of this procedure called **Go to a Server/Workstation and...**

Go to the Server/Workstation and...

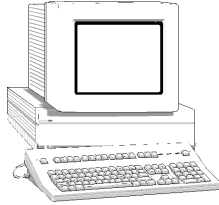

1. Verify the correct software is loaded
 - a) At the Desktop, right mouse click the **My Network Places** icon and select **Properties**. Right mouse click on the **Local Area Connection** icon and verify that the **Internet Protocol (TCP/IP)** protocol has been loaded.
2. Add the printer
 - a) Open **Control Panel** and double click the **Printers** icon.
 - b) Double-click **Add Printer**. The Add Printer Wizard starts. Click **Next**. (Follow the instructions below for LPR printing OR to print with IPP follow the instructions on the next page entitled **To Create an IPP Printer**)

To create a LPR Printer

- a) Select **Local Printer**; deselect **Automatically detect and install my Plug and Play printer**. Click **Next**.
- b) Select **Create a new port** and choose **Standard TCP/IP port** from the pull-down menu. Click **Next** twice.
- c) Enter the **Printer Name** or its **IP address**. The Printer Name can be either the Host Name or the SMB Host Name as shown on the configuration report, depending on the name resolution used by your network (WINS or DNS). The **Port Name** is automatically filled in for you but you can change it if you want to. Click **Next**.
- d) The Wizard will automatically detect the Printer Model for you. If that does not happen select **Standard** and choose the your Printer Model from the pull-down menu.
- e) Click **Finish**. Go to Step 3.

To Create an IPP printer

- a) Select **Network Printer**. Click **Next**.
 - b) Select **Connect to a printer on the Internet or on your intranet**. Type **HTTP://** followed by the printer's name or IP address in the URL field. The Printer Name can be either the Host Name or the SMB Host Name as shown on the configuration report, depending on the name resolution used by your network (WINS or DNS). Click **Next**.
 - c) Click **OK** to install the printer driver. Go to Step 3.
3. Select the driver to be used (Document Centre drivers are included on the Windows 2000 CD-ROM)
- a) A driver list will be displayed. Select Xerox from the **Manufacturers:** area. Then select the desired print driver from the **Printers:** and click **OK**. The driver will be installed.
 - b) The **Default Printer** window will open. Select **Yes** to make this the default printer, otherwise click the **Next>** button.
 - c) At the **Completing the Add Printer Wizard** screen, click the **Finish** button.
 - d) Test the installation. Open the Printers dialog and right-mouse click the printer just created then select **Properties**. At the General tab for the printer, click the **Print Test Page** button. Verify that it prints.
 - e) Repeat this **Go to the server/workstation and...** procedure for each workstation or server on the network that will print to the printer.

Microsoft Windows NT 4.X Server Network (TCP/IP)

Before you Start

NOTE:

Your Document Centre has DHCP enabled by default. If you have configured a DHCP server with TCP/IP information, you can connect your Document Centre to your network and it will retrieve its TCP/IP information from the DHCP server when it is turned on.

To enable 100BaseT or a Token Ring interface, refer to Chapter 2 **How to Connect to Ethernet or Token Ring Networks** to configure the Speed and Source Routing settings for your environment.

You can manually assign or use BOOTP or RARP servers to assign TCP/IP information to your Document Centre. Refer to the section in this document entitled **Dynamic IP Address Assignment**.

If you are using DHCP, perform **Steps 1 through 6c** but **DO NOT** change any values. Then read the note before step 6d and determine if you wish to change the lpr port number. After choosing, complete the remainder of the procedure.

Go to the printer and...

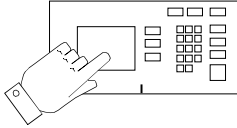

1. Connect your Document Centre to the network with the appropriate cabling
2. Enter the *Tools* pathway
 - a) Press the **Access (A)** button.
 - b) On the keypad enter **1111** or the current password. Press the **Enter** button when finished. Press the **Go to Tools** button.
 - c) The Touch Screen will be used for the remainder of the data entry.
3. Enter the Network Setup menus
 - a) Wait for the screen to refresh and press the **Connectivity and Network Setup** button.
 - b) Wait for the screen to refresh and press the **Network Setup** button.
 - c) Press the **TCP/IP Options** button.
4. Enable the Protocol and Media
 - a) Press the **TCP/IP Settings** button.
 - b) Press the **Protocol and Media** button.
 - c) Press the **Enable** button. If Physical Media buttons appear, select either **Ethernet** or **Token Ring**. Press **Save**.

5. Set the Host Name
 - a) Press the **Name/Address** button.
 - b) One at a time press the soft buttons on the Touch Screen for each Octet of the IP address and enter the numbers from the keypad.
 - c) Press the **Host Name** button.
 - d) When the soft keypad appears, type the host name EXACTLY as you want it to appear with proper case. When finished press the **Save** button to record the changes and exit to the TCP/IP Settings Screen.
6. Set the Subnet Mask and Gateway
 - a) Press the **Subnet and Gateway** button.
 - b) One at a time press the soft buttons on the Touch Screen for each octet of the Subnet Mask and enter the numbers from the keypad. Repeat this process for the IP Gateway address. When finished press **Save** to record the changes and exit to the TCP/IP Settings Screen.

NOTE:

The Broadcast Address will be calculated automatically.

- c) Press the **TCP/IP - Line Printer** button. At the next screen press **Enable** then press **Save**.

NOTE:

While you can change the port number at which your Document Centre will accept lpr print jobs it is recommended that you do this ONLY with extreme caution as most lpr spoolers are set to send print jobs to the default port.

- d) If you wish to change the lpr port for your printer press the port soft button and enter the desired port number at the keypad. Press **Save**.

7. Exit the Tools Menu.
 - a) Press the **Exit Tools** button. The printer will store the settings you have made.
8. Prepare for print driver installation
 - a) From the documentation package supplied with your printer, retrieve the **CentreWare Network Services CD-ROM** and the document entitled **CentreWare Network Services Guide**. Proceed to the next section of this procedure called **Go to a server and...**

Go to the server and...

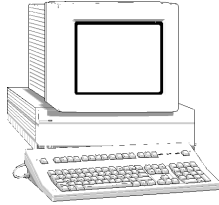

1. Verify the correct software is loaded
 - a) At the Desktop, right mouse click the **Network Neighborhood** icon and select **Properties**. Click on the **Protocols** TAB and verify that the **TCP/IP** protocol has been loaded.
 - b) Select the **Services TAB** and verify that **Microsoft TCP/IP Printing** is loaded. If this software is not present, install it using the documentation provided by Microsoft. Then return to the next step in this document.
2. Add the printer
 - a) Open the **Control Panel** and double-click **Printers** icon. Double-click **Add Printer**. The Add printer Wizard starts.
 - b) Verify that **My Computer** is selected and click **Next>**.
 - c) Click **Add Port**. From the list that appears select **LPR Port**. Click **New Port**.
 - d) This will open up the **Add LPR compatible printer** window. Type in the IP address of the Document Centre printer and the printer name and select **OK**. Note that the printer name is case sensitive
 - e) The Wizard will return you to the previous dialog. Verify the new IP address you entered is in the list and correct. The check box to the left of the address must be checked; if it is not, check it then select **Next>**.

- f) Insert **CentreWare Networks Services CD-ROM** and click **Have Disk**.
 - g) Click the **Browse** button and select the directory containing the Windows NT drivers. Details for this are contained in the document entitled **Network Services Guide**. Select the **PRINTER.INF** file then click **Open**.
 - h) The Wizard will return you to the previous dialog. Verify the path and file name are correct and click **OK**.
 - i) At the next dialog, enter a name for the printer and select whether you want that printer to be the default then click **Next>**.
 - j) If the printer will not be shared, click **Next>**. To share the printer, check the **share** checkbox, enter a Share Name, then click **Next>**.
 - k) At the next dialog it is recommended that you print a test page. Click **Finish**.
 - l) Wait for the Test Print to print. A new dialog will ask for confirmation of the test print; if the page printed, click **Yes**. If it did not print, run the Printing Troubleshooter in NT.
3. Send a test job to the printer
- a) Check your test job for quality and use the problem solving section of the **Document Centre Reference Guide** for resolving print defects.
 - b) If your print job does not print, refer to the Troubleshooting section in this document to correct the problem.

Go to the workstation and...

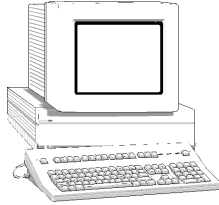

1. Verify that the TCP/IP protocol stack is loaded.
2. Use the **CentreWare Network Services CD-ROM** to install print drivers. Details for this are found in the document supplied with your printer entitled **CentreWare Network Services Guide**.
3. Connect the printer that you just created to the shared resource on the server.
4. Open an application on the workstation and print a test page to verify operation.
5. Check your test job for quality and use the problem solving section of the **Document Centre 460/470 Reference Guide** for resolving print defects.
6. Repeat this **Go to the workstation and...** procedure for each workstation on the network that will print to the printer.

*Microsoft Windows NT
4.X Server Network*

OS/2 (TCP/IP) Networks

Before You Start

To enable 100BaseT or a Token Ring interface, refer to Chapter 2 **How to Connect to Ethernet or Token Ring Networks** to configure the Speed and Source Routing settings for your environment.

NOTE:

Your Document Centre now has DHCP, LPR, and NetBIOS over the IP protocol enabled by default. If your DHCP server will provide host name, IP address, Gateway address, and Subnet Mask, the Document Centre TCP/IP information will be configured on initial boot. This means that if you have configured your DHCP server with the desired information, you may go right to the section in this chapter entitled **Go to a Workstation and....**

This procedure assumes you are going to manually set your TCP/IP information and have recorded the IP Address, Subnet Mask, and Default Gateway IP address that is to be assigned to your printer. The Document Centre will compute your Broadcast Address automatically.

For information on how your printer can connect to a DHCP, BOOTP, or RARP server to be assigned an IP address dynamically, refer to the section in this document entitled **Dynamic IP Address Assignment**.

Go to the printer and...

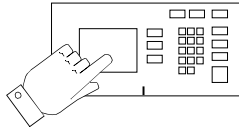

1. Connect your Document Centre to the network with the appropriate cabling.
2. Enter the **Tools** pathway
 - a) Press the **Access (A)** button.
 - b) On the keypad enter **1111** or the current password. Press the **Enter** button when finished. Press the **Go to Tools** button.
 - c) The Touch Screen will be used for the remainder of the data entry.
3. Enter the Network Setup menus
 - a) Wait for the screen to refresh and press the **Connectivity and Network Setup** button.
 - b) Wait for the screen to refresh and press the **Network Setup** button.
 - c) Press the **TCP/IP Options** button.
4. Enable the network interface and protocol
 - a) Press the **TCP/IP Settings** button.
 - b) Press the **Protocol and Media** button.
 - c) Press the **Enable** button. If Physical Media buttons appear, select either **Ethernet** or **Token Ring**. Press **Save**.

5. Set the Host Name
 - a) Press the **Name/Address** button.
 - b) One at a time press the soft buttons on the Touch Screen for each Octet of the IP address and enter the numbers from the keypad.
 - c) Press the **Host Name** button
 - d) When the soft keypad appears, type the host name EXACTLY as you want it to appear with proper case. When finished press the **Save** button to record the changes and exit to the TCP/IP Settings Screen.
6. Set the Subnet Mask and Gateway
 - a) Press the **Subnet and Gateway** button.
 - b) One at a time press the soft buttons on the Touch Screen for each Octet of the Subnet Mask and enter the numbers from the keypad. Repeat this process for the IP Gateway address. When finished press **Save** to record the changes and exit to the TCP/IP Settings Screen.

NOTE:

The Broadcast Address will be calculated automatically.

- c) Press the **TCP/IP - Line Printer** button. At the next screen press the **Enable** button.

NOTE:

While you can change the port number at which your Document Centre will accept lpr print jobs it is recommended that you do this **ONLY** with extreme caution as most lpr spoolers are set to send print jobs to the default port.

- d) If you wish to change the lpr port for your printer press the port soft button and enter the desired port number at the keypad. Press **Save**.
- e) Press the **Close** button.
- 7. Exit the Tools Menu.
 - a) Press the **Exit Tools** button. The printer will store the settings you have made.
- 8. Prepare for print driver installation
 - a) From the documentation package supplied with your printer, retrieve the **CentreWare Network Services CD-ROM** and the document entitled **CentreWare Network Services Guide**. Proceed to the next section of this procedure called **Go to a Workstation and...**

Go to a workstation and...

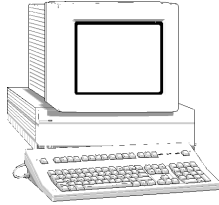

1. Create a new printer and load print drivers from the CD-ROM.
2. Create a printer share and its access permissions (sharing and connecting).
3. Start **LPRPORTD/LPRMON**, ping printer, open EPM and send a print job to the printer.
4. Check your test job for quality and use the problem solving section of the **Document Centre Reference Guide** for resolving print defects.
5. If your print job does not print, refer to the Troubleshooting section in this document to correct the problem.
6. Repeat this **Go to a workstation and...** procedure at each workstation that will print to this printer.

OS/2 (NetBEUI) Networks

Before You Start

To enable 100BaseT or a Token Ring interface, refer to Chapter 2 **How to Connect to Ethernet or Token Ring Networks** to configure the Speed and Source Routing settings for your environment.

Go to the printer and...

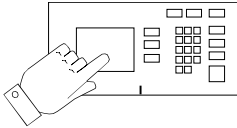

1. Connect your Document Centre to the network with the appropriate cabling
2. Enter the **Tools** pathway
 - a) Press the **Access (A)** button.
 - b) On the keypad enter **1111** or the current password. Press the **Enter** button when finished. Press the **Go to Tools** button.
 - c) The Touch Screen will be used for the remainder of the data entry.
3. Enable Microsoft Network printing
 - a) Press the **Connectivity and Network Setup** button.
 - b) At the next screen, press the **Network Setup** button.
4. Enable the Protocol and Media
 - a) At the next screen, press the **Microsoft Networks** button.
 - b) At the next screen, press the **Transport and Media** button.
 - c) At the next screen, press the **Enable** button to enable the Microsoft Network protocols.
 - d) If Physical Media buttons appear, press the corresponding button to select either **NetBEUI/Ethernet** or **NetBEUI/Token Ring**. Press **Save**.

5. Assign the Workgroup and Host names
 - a) You will be returned to the previous screen; press the **Workgroup and Host** button.
 - b) At the next screen, press the **Workgroup Name** button. Using the touch panel keys, enter the name of the workgroup in which you want the printer to appear, then press **Save**.
 - c) You will be returned to the previous screen. Press the **SMB Host Name** button, using the touch panel keys and enter the desired text for this item, then press **Save**.
 - d) OPTIONAL STEP: Press the **SMB Host Description** button, enter the desired text then press **Save**. You will be returned to the previous screen.
 - e) Press **Save** again to return to the previous screen.
6. Assign a Printer Name and Description
 - a) Press the **Printer Description** button.
 - b) Press the **Printer Name** button. Using the touch panel keys, enter the desired text for this item then press **Save**. Press **Save** again to return to the previous screen.
 - c) OPTIONAL STEP: Press the **Printer Description** button, using the touch panel keys, enter the desired text for this item then press **Save**.
 - d) Press the **Connections** button.

- e) Set Maximum Connections and Timeout.
 - f) Touch the **Maximum Connections** soft button on the touch screen and on the keypad enter the desired maximum connection number between 1 and 30. It is recommended that this value should be set at the default.
 - g) Touch the **Connection Timeout** soft button on the Touch Screen. On the keypad enter the desired number of seconds between 0 and 9999. Press **Save** to exit the connections screen.
7. Exit the Tools Menu.
- a) Press the **Exit Tools** button. The printer will store the settings you have made.
8. Prepare for print driver installation
- a) From the documentation package supplied with your printer, retrieve the **CentreWare Network Services CD-ROM** and the document entitled **CentreWare Network Services Guide**. Proceed to the next section of this procedure called **Go to a Workstation and...**

Go to the workstations and...

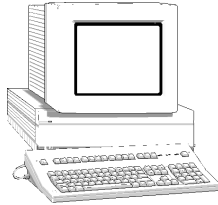

1. Perform an OS2 Warp (4.0) **Selective Install**
 - a) Install Both **NetBIOS (NetBEUI)** and **NetBIOS for IP** during the install process.
 - b) Select and Enable all of the file and print sharing options during the **Selective Install** process.
2. Create a shared resource and connect it to the network device
 - a) Double-click on the **Connections** Icon.
 - b) Click on the + symbol next to **Network**.
 - c) Click on the + symbol next to **Network Services**.
 - d) Double-click on **Start File and Print Client**.
 - e) Close the **Logons** window.
 - f) Double Click on **Shared Resources and Network Connections**
 - g) Close the **Connections** Window.
 - h) Enter a valid user/password (the one entered at the client installation).
 - i) Select the **Connections** tab of these property pages.
 - j) Select the **Create connection** button.
 - k) Set the resource type to **Printer**.

- l) Enter the machine's hostname in the **Server** field
- m) Select the desired lpt port.
- n) Verify that the **Connect to resource at logon** button is selected.
- o) Place the cursor in the server field and press the **Enter** key on the keyboard.
- p) Click the **OK** button after the share name appears in the **Resource** window.
- q) Close the **Shared Resources and Network Connections - Properties** window.
- r) Double-click on the **Connections** Icon.
- s) Double-click on **Printers**.
- t) Close the **Connections** window.
- u) Double-click on **Printer** in the Printers window. **DO NOT CHOOSE THE NETWORK PRINTER OPTION.**
- v) Enter a name for the local queue in the **Printer** window. (Overwrite the printer that already appears with something unique - this does not have to be the share or hostname of the printer)
- w) Make sure the cursor is still in the printer window and press the **Enter** key on the keyboard.
- x) Select **familiar w/ OS/2** if prompted.
- y) Highlight the correct lpt port (assigned in step **2m**).

3. Install a new printer driver
 - a) Insert CentreWare CD into your CD-ROM drive.
 - b) Make a /desktop/drivers directory from an OS/2 Window
 - c) Copy the driver files from the CD-ROM disk to the /desktop/drivers directory.
 - d) Click the **Install new printer driver...** button.
 - e) Select **Other OS/2 printer driver**.
 - f) Enter the correct directory in the appropriate field.
 - g) Click the **Refresh** button.
 - h) Click the **Install** button after you see the driver description appear.
 - i) Click the **OK** button to confirm that the driver has been installed
4. Highlight the OS/2 driver in the **Default printer driver** window and click the **Create** button
5. Close the **Printers** window
6. You are now ready to print to the local queue created in step **2v**
7. Print a test job
8. Check your test job for quality and use the problem solving section of the **Document Centre Reference Guide** for resolving print defects
9. If your print job does not print, refer to the Troubleshooting section in this document to correct the problem

Macintosh Networks (AppleTalk)

Before you start

To enable 100BaseT or a Token Ring interface, refer to Chapter 2 **How to Connect to Ethernet or Token Ring Networks** to configure the Speed and Source Routing settings for your environment.

This procedure assumes you have Macintosh computers equipped with an Ethernet card or Token Ring card that is connected to the network and you are currently printing using the AppleTalk protocol.

As part of the procedure in this section you will need to know the following information, the AppleTalk Name you wish to assign to your printer, and the AppleTalk Zone (if used) in which your printer will reside.

Go to the printer and...

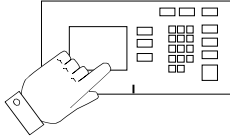

1. Connect your Document Centre to the network with the appropriate cabling
2. Access the **Tools** pathway
 - a) Press the **Access (A)** button.
 - b) On the keypad enter **1111** or the current password. Press the **Enter** button when finished. Press the **Go to Tools** button.
 - c) The Touch Screen will be used for the remainder of the data entry.
3. Enable the AppleTalk protocol
 - a) Press the **Connectivity and Network Setup** button.
 - b) At the next screen, press the **Network Setup** button.
 - c) At the next screen, press the **AppleTalk** button.
 - d) At the next screen, press the **Protocol and Media** button.
 - e) Press the **Enable** button. If Physical Media buttons appear, select either **Ethernet** or **Token Ring**. Press **Save**.

4. Assign a Name and Zone to your printer
 - a) You will be returned to the previous screen. Press the **Name and Zone** button.
 - b) At the next screen, press the **Printer Name** button, enter the name you want for the printer (this is the name that will appear in the Chooser on your workstations) using the touch panel keys.
 - c) Press the **Zone Name** button, enter the desired text for this item using the touch panel keys, then press **Save** (the printer default is * which means the printer will appear in ALL zones).
5. Exit the Tools Menu.
 - a) Press the **Exit Tools** button. The printer will store the settings you have made.
6. Prepare for print driver installation
 - a) Obtain a **Configuration Report** page from your printer.
 - b) Review the **AppleTalk Settings:** area of the **Configuration Report** page and verify that **AppleTalk** is enabled, the **AppleTalk Name** is correct, the **AppleTalk Zone** is correct (if used).
 - c) From the documentation package supplied with your printer, retrieve the **CentreWare Network Services CD-ROM** and the document entitled **CentreWare Network Services Guide**. Proceed to the next section of this procedure called **Go to a Workstation and...**

Go to the workstation and...

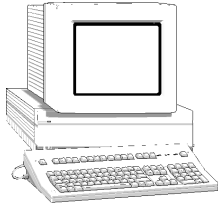

1. Use the **CentreWare Network Services CD-ROM** to install print drivers and the Macintosh **PUtility** on the workstation. Details for this are found in the document supplied with your printer entitled **CentreWare Network Services Guide**
2. Send a test job to the printer from an application program
3. Check your test job for quality and use the Problem Solving section of the **Document Centre Reference Guide** for resolving print defects
4. If your job did not print see the Troubleshooting section in this document to correct the problem

Banyan VINES Network

To enable 100BaseT or a Token Ring interface, refer to Chapter 2 **How to Connect to Ethernet or Token Ring Networks** to configure the Speed and Source Routing settings for your environment.

Go to the printer and...

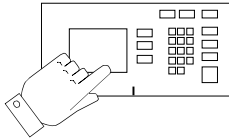

1. Connect your Document Centre to the network with the appropriate cabling
2. Enter the **Tools** pathway
 - a) Press the **Access (A)** button.
 - b) On the keypad enter **1111** or the current password. Press the **Enter** button when finished. Press the **Go to Tools** button.
 - c) The Touch Screen will be used for the remainder of the data entry.

3. Enable Banyan VINES printing
 - a) Press the **Connectivity and Network Setup** button.
 - b) At the next screen, press the **Network Setup** button.
 - c) At the next screen, press the **Banyan VINES** button.
 - d) At the next screen, press the **Protocol** button.
 - e) At the next screen, press the **Enable** button to start the Banyan Vines protocol and press **Save**.
4. Configure User Name settings and Password
 - a) At the next screen, press the **Settings** button.
 - b) At the next screen, press the **User Name/PC Print Destination** button, enter the desired text for this item using the touch panel keys, then press **Save**.
 - c) Press the **User Password** button. Enter the desired text for this item using the touch panel keys, then press **Save**.
 - d) Press the **Print Service Name** button. Enter the desired text for this item using the touch panel keys, then press **Save**.
5. Exit the Tools Menu.
 - a) Press the **Exit Tools** button. The printer will store the settings you have made.
6. Prepare for print driver installation
 - a) Obtain a **Configuration Report** page from your printer.
 - b) Check the **Configuration Report** page and verify that **Banyan VINES** is enabled and the other Banyan Settings are correct.
 - c) From the documentation package supplied with your printer, retrieve the **CentreWare Network Services CD-ROM** and the document entitled **CentreWare Network Services Guide**. Proceed to the next section of this procedure called **Go to the server and...**

Go to the server and...

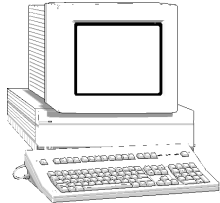

1. Configure the Service and Queue
 - a) Using the **MUSER** utility, create a user name and assign a password for the printer. The user name and password must be the same that were entered at the Document Centre.
 - b) Using the **MSERVICE** utility, highlight and select **ADD a server-based service**.
 - c) At the **Add A Service** Screen, enter the **StreetTalk name** and **description** when prompted.
 - d) Select the server on which you want to create the service.
 - e) Select **Banyan Print Service**.
 - f) Select an appropriate disk location when prompted.
 - g) A message will be displayed stating that the service is running, but is not yet available to users.
 - h) Press the **F10** key to continue.
 - i) The **Configure Queue** Screen will be displayed.
 - j) Press the **F10** key to accept the defaults.
2. Configure the Paper Formats
 - a) The **Configure Paper Formats** Screen will be displayed.
 - b) Press the **Escape** key to continue without making any changes.

3. Configure Access Lists and Print Destination
 - a) The **Access Lists** screen will be displayed.
 - b) Press the **F10** key to accept the defaults.
 - c) The **Add a Destination** screen will be displayed.
 - d) Select **PCPrint** and press **Enter**.
 - e) From the **Destination Attributes** Screen, enter the Document Centre user name as the PCPRINT ST name and Description, and then press the **F10** key.

NOTE

The PCPrint ST name must be the same as the user name created and must also match the Street Talk (user) Name entered at the printer.

- f) The **Output Strings** Screen will be displayed. Press the **F10** key to accept the defaults displayed on the screen.
 - g) The **Enable Strings** Screen will be displayed. Press the **F10** key to accept the defaults displayed on the screen.
 - h) Select **No** and press **Enter** when you are prompted to add another destination.
4. Enable the Print Queue
 - a) The **Print Queue Status** Screen will be displayed.
 - b) Change the **Printing jobs** and the **Accepting jobs** fields to **Yes** and then press the **F10** key.
 - c) A message will be displayed stating that the printer is ready to accept and print jobs. Press the **F10** key to continue.
 - d) The **Manage A Service** screen will be displayed.
 - e) Press the **Escape** Key to return to the **Manage Services** main menu.
5. Power off and power on the Document Centre for these setup options to take effect

Internet Services

Overview

NOTE:

Your Document Centre now has DHCP, LPR, and NetBIOS over the IP protocol enabled by default. This means that if you have configured your Document Centre with the desired TCP/IP information using Dynamic Addressing (DHCP, RARP, or BOOTP), you may go directly to the procedure in this chapter entitled **Configure your Web Browser**. Otherwise, you may start at the section entitled **Configure your printer**.

Your Document Centre printer includes an integrated Web Server.

This means you can now print to, and check up on your printer status using your favorite Web Browser software.

With the scan or fax options installed, you may also use Internet Services to create, modify and delete scan or fax templates. Details for this are found in the document supplied with your Document Centre entitled **CentreWare Internet Services Guide**.

This chapter will show you how to enable this feature.

Before You Start

It is mandatory that you install a Java enabled browser on the workstation(s) which will use the Internet Services Tool. For best performance and compatibility use Netscape Navigator 4.0 or Microsoft Internet Explorer 4.0 or later.

Your printer and workstation(s) must be connected to a network which has the TCP/IP protocol enabled.

This procedure assumes you have a general knowledge of your network type and the operation of your Web Browser software, and that your Document Centre printer has been assigned all TCP/IP information.

Configure your printer

1. Connect your Document Centre to the network with the appropriate cabling.
2. Enter the Tools pathway.
3. Press the **Access (A)** button.
4. On the keypad enter **1111** or the current password. Press the **Enter** button when finished. Press the **Go to Tools** button.
5. Press the **Connectivity and Network Setup** button.
6. Press the **Network Setup** button.
7. Press the **TCP/IP Options** button.
8. Press the **HTTP/IPP** button. Then press the **Enable** button.
9. Press the **Exit Tools** button.
10. Print a **Configuration Report** and retain the page for the steps below.
11. Review the Configuration Report and verify the following in the **TCP/IP Settings** area are set correctly for your network:
 - TCP/IP Address**
 - Default Gateway**
 - Subnet Mask**
 - Broadcast Address (if used)**
12. Review the **HTTP:** area of the **Configuration Report** and verify that HTTP/IPP enabled is set to **ENABLED**.
13. Proceed to the next section of this procedure called **Configure your Web Browser**.

Configure your Web Browser

This procedure will configure your web browser software to connect to your printer on the network.

1. Print a **Configuration Report** from your printer and retain the page for the steps below.
2. Launch your Web Browser software.
3. Enter your printer's TCP/IP address from your **Configuration Report** into the **Address** or **Location** field on your browser (this name is browser dependent) and press RETURN.
4. Your browser should connect to the imbedded web server on your printer and display the printer's "Home Page". If your network is connected to the Internet through a proxy server, it may be necessary to exclude your printers TCP/IP address in your browser to speed access and also eliminate proxy server traffic.
5. Once you have established communication with your printer, be sure to save the URL in your Favorites, or Bookmarks (this name is also browser dependent), so you can quickly reconnect when necessary.
6. To make it easier for browser software on other workstations to find the printer, be sure to update your DNS or NIS (depending on your network) to include the printer.
7. For instructions on how to use Internet Services, consult the document entitled **Internet Services Guide** supplied with your printer.

Troubleshooting

Overview

This section of the **Network Installation and Troubleshooting Guide** contains individual procedures for troubleshooting problems on each major network operating system or protocol.

These procedures will help you solve the common mistakes that are made during installation and repair problems that can occur later.

Because the Document Centre supports a wide variety of networks, each of the procedures is self contained. If your Document Centre is configured to print using multiple protocols it is recommended you follow one troubleshooting procedure at a time. This should save confusion and time.

Consult the procedure (or procedures) in this section that apply to your environment.

TCP/IP Troubleshooting

Basic TCP/IP Communication Problems

This procedure assumes that the printer is turned on and connected to a functioning network port with the correct cabling.

NOTE:

Your Document Centre now has DHCP, LPR, and NetBIOS over the IP protocol enabled by default. If your DHCP server will provide host name, IP address, Gateway address, and Subnet Mask, the Document Centre TCP/IP information will be configured on initial boot. This means that if you have configured your DHCP server with the desired information, you should verify that the information is correct before you follow any of the procedures in this **TCP/IP Troubleshooting** section.

1. Obtain a **Configuration Report** page from your printer.
2. Press the **Access (A)** button above the keypad.
3. A password entry field will appear. On the keypad enter **1111** or the current password then touch the **Enter** button on the Touch Screen. The Touch Screen will be used for the remainder of the data entry.
4. Press the **Go to Tools** button.
5. Press the **Systems Settings** button, then at the next screen, press the **Configuration Report** button and wait for the next screen.
6. Press the **Print Configuration Report Now** button.
7. Allow a minute for the Report to print.

8. Verify the following **TCP/IP Settings**: on the Configuration Report page:

Host Name (REMEMBER if you are connected to a UNIX network, it is CASE SENSITIVE!)

IP address

Subnet Mask

Default Gateway

Broadcast Address (if used)

NOTE:

The Broadcast Address is calculated automatically.

9. To verify the Broadcast Address is correct the following calculation may be used:

Perform a logical OR of the complement of the subnet mask and the IP address.

Example of logical OR method:

IP Address = 13.175.109.146

Subnet Mask = 255.255.252.0

IP Address

00001101.10101111.01101101.10010010

Complement of Subnet Mask

00000000.00000000.00000011.11111111

The result of the logical OR

00001101.10101111.01101111.11111111

Broadcast Address = 13 . 175 . 111 . 255

10. Any one of these important TCP/IP parameters (if set incorrectly) can cause TCP/IP communication problems. Subnet Mask and Default Gateway are critical on multi-network segment LANs or WAN's. If you make any TCP/IP configuration changes, then the printer will reset for those changes to take effect.
11. Go to a workstation on the same subnet as the printer. And at a command line prompt TYPE ping xxxx.xxxx.xxxx.xxxx (xxx.xxxx.xxxx.xxxx is the IP address of the printer). Try to "ping" the printer using its hostname. If ping is successful with the printer's TCP/IP address but not with its hostname, then you may have a local workstation or NIS configuration problem. Check the Default Gateway settings of the printer.
12. Add the printer host name to your local hosts file or NIS database (whichever applies) and try the ping tests again.
13. Try to ping other TCP/IP nodes on your network. This will verify the operation of your workstation's network card. Try to "ping" the printer from another workstation. If all of the above fails, you have a configuration problem at your local workstation, or a network problem.
14. If Dynamic IP Addressing is enabled try "hard coding" the printer IP address at the User Interface. Reset the printer, and check for connectivity again with the "ping" command.

NOTE:

When using **lpr** to print jobs it is possible to set the lpr port to a port other than the default of 515. If this occurs, it will halt all lpr printing but printing using other protocols would still work.

15. If all of the above troubleshooting fails, you may have a malfunctioning Network Interface.

NetWare Troubleshooting

NetWare troubleshooting steps

This procedure assumes that the printer is turned on and, connected to a functioning network port with the correct cabling.

1. Obtain a **Configuration Report** page from your printer.
2. Press the **Access (A)** button above the keypad.
3. A password entry field will appear. On the keypad enter **1111** or the current password then touch the **Enter** button on the Touch Screen. The Touch Screen will be used for the remainder of the data entry.
4. Press the **Go to Tools** button.
5. Press the **Systems Settings** button, then at the next screen, press the **Configuration Report** button and wait for the next screen.
6. Press the **Print Configuration Report Now** button.
7. Allow a minute for the Report to print.

8. Review the **NetWare Settings:** area of the page and verify at the User Interface these items:

Ethernet or **Token Ring** (depending on which is being used) is **ENABLED**.

Frame Type matches the frame type of the Primary fileserver.

Primary File Server (for NetWare 3.1X only) is set to the name of the server that serves the print queue you have assigned to the printer. Setting the Primary Server is extremely important on large networks.

NDS Tree (for NetWare 4.X and 5.X NDS only) is set for the correct **NDS tree name**.

NDS Context (for NetWare 4.X and 5.X NDS only) is set for the correct **NDS Context**.

Print Server Name is set for the name selected for this printer to act as a print server.

Print Server Password is set correctly for this print server.

9. Print out another **Configuration Report** page to verify the items you modified were set and retained.
10. **VERIFY** that the NetWare print queue assigned to the printer exists, is accepting jobs, and has a Print Server attached. If the printer has not logged in, reboot the printer.

Microsoft (NetBIOS/NetBEUI) Troubleshooting

NetBEUI Troubleshooting Steps

1. Obtain a **Configuration Report** page from your printer.
2. Press the **Access (A)** button above the keypad.
3. A password entry field will appear. On the keypad enter **1111** or the current password then touch the **Enter** button on the Touch Screen. The Touch Screen will be used for the remainder of the data entry.
4. Press the **Go to Tools** button.
5. Press the **Systems Settings** button, then at the next screen, press the **Configuration Report** button and wait for the next screen.
6. Press the **Print Configuration Report Now** button.
7. Allow a minute for the report to print.

8. Review the **NetBIOS:** area of the page and verify at the User Interface these items:

NetBEUI Protocol is Enabled.

Interface is set to **Ethernet / NetBEUI** or **Token Ring / NetBEUI** (depending on which is being used).

Host Name is set for the NetBEUI name selected for this printer.

Printer Name is set for the name selected for this printer to act as a print server.

WorkGroup: is set for the name of the desired NetBEUI workgroup for this printer.

Number Connections is **8** or greater.

Connection Timeout is between **100** and **9999**.

9. If any changes are made at the User Interface, exit the Tools menu to reset the printer.
10. Print out another **Configuration Report** page to verify the items you modified were set and retained.

OS/2 Troubleshooting (TCP/IP)

OS/2 Troubleshooting Steps

1. Obtain a **Configuration Report** page from your printer.
2. Press the **Access (A)** button above the keypad.
3. A password entry field will appear. On the keypad enter **1111** or the current password then touch the **Enter** button on the Touch Screen. The Touch Screen will be used for the remainder of the data entry.
4. Press the **Go to Tools** button.
5. Press the **Systems Settings** button, then at the next screen, press the **Configuration Report** button and wait for the next screen.
6. Press the **Print Configuration Report Now** button.
7. Allow a minute for the report to print.
8. For OS/2 printing only, **VERIFY** that LPRPORTD.EXE is running.
9. For OS/2 and WIN-OS/2 printing, **VERIFY** that LPRMON.EXE is running.
10. Verify you have applied all appropriate IBM Fixpacks, APARs (see compatibility for required Fixpacks). If not, the proper Fixpack must be applied.
11. Check ALL IP addresses and verify that you have set the printers address correctly at the User Interface.
12. Go to a workstation and use the “ping” command to see if your server responds. If the server does not respond, you may have an addressing or network problem.

13. Use the “ping” command to see if your printer responds. If the printer does not respond, you may have an addressing or network problem. Correct these conditions by checking and resetting IP addresses or cabling and retry.
14. Use the “ping” command to see if your gateway responds. If the gateway does not respond, you may have an addressing or network problem. Correct these conditions by checking and resetting IP addresses or cabling and retry.
15. Check your router, subnet (if applicable), and gateway addresses. (Incorrect addressing can render your lpr/lpd printing system unusable.)

AppleTalk Troubleshooting

AppleTalk Troubleshooting Steps

This procedure assumes that the printer is turned on, and, connected to a functioning network port with the correct cabling.

1. Obtain a **Configuration Report** page from your printer.
2. Press the **Access (A)** button above the keypad.
3. A password entry field will appear. On the keypad enter **1111** or the current password then touch the **Enter** button on the Touch Screen. The Touch Screen will be used for the remainder of the data entry.
4. Press the **Go to Tools** button.
5. Press the **Systems Settings** button, then at the next screen, press the **Configuration Report** button and wait for the next screen.
6. Press the **Print Configuration Report Now** button.
7. Allow a minute for the Report to print.

8. Review the **AppleTalk Settings:** area of the report and verify at the these items through the Tools menu:

AppleTalk Protocol is **Enabled**.

AppleTalk Interface is set to **Ethernet**.

AppleTalk Name is set for the name selected for this printer to act as a print server and that the entry is spelled correctly.

AppleTalk Zone is set for the zone selected for this printer and that the entry is spelled correctly.

9. Go to a workstation and **VERIFY** that the printer is visible in the Chooser.

Banyan VINES Troubleshooting

This procedure assumes that the printer is turned on and connected to a functioning network port with the correct cabling.

1. Obtain a Configuration Report page from your printer.
2. Press the **Access (A)** button above the keypad.
3. A password entry field will appear. On the keypad enter **1111** or the current password then touch the **Enter** button on the Touch Screen. The Touch Screen will be used for the remainder of the data entry.
4. Press the **Go to Tools** button.
5. Press the **Systems Settings** button, then at the next screen, press the **Configuration Report** button and wait for the next screen.
6. Press the **Print Configuration Report Now** button.
7. Allow a minute for the report to print.
8. Review the **Banyan VINES** settings.
9. **User Name/PCPRINT** Destination entered at the UI should match the User Name and the PCPRINT Streetalk (ST) name created at the Server.
10. The **User Password** entered at the UI should match the Password entered for the User created at the Server.

11. The **Print Service** name entered at the UI should match the name of the Print Service created at the Server.
12. **PCPRINT** is the Destination configured for the Print Service at the Server.
13. If any changes are made at the User Interface the printer will reset.
14. Allow the printer approximately seven minutes to reboot.
15. Print out another **Configuration Report** page to verify the items you modified were set and retained.
16. Consult the table below for troubleshooting suggestions.

Printer busy Job reached the top of the queue and cannot print.	Check steps 3,4,5 above are Correct. Check the PC port setup with the SETPRINT command.
Paper Format NA	Job reached the top of the queue and an attempt to match the job format failed. Change either the jobs format or the format of the destination printer to print the job.
Rejected	Job is corrupted, or an internal occurred. Check or reinstall print drivers.
Cancelled	Job was removed from the queue. The queue configured timeout expired. Check queue configuration.

OfficeTrac Network Accounting

Overview

Equitrac Corporations OfficeTrac software provides the ability to control access to, and monitor up to twenty (20) networked Document Centres for the following functions:

Copying

Printing

Faxing

Scanning

With OfficeTrac you may set up user accounts, keep data on usage patterns, and track office expenses effectively using a single tool. Feature-rich standard reports and available custom reports, are combined with powerful data export to make OfficeTrac a complete asset management solution.

The Equitrac OfficeTrac application communicates with the Document Centre Web Server (Internet Services) to configure, and retrieve information from your Document Centre.

This procedure assumes that your OfficeTrac server has already been installed, your Document Centre has had the required upgrade installed, and is properly connected to your network. It also assumes that the administrator has performed a site setup in OfficeTrac for the Document Centre. Details for performing a Site Setup are contained in your OfficeTrac documentation.

Before You Start

NOTE:

Your Document Centre now has DHCP, LPR, and NetBIOS over the IP protocol enabled by default. If your DHCP server will provide host name, IP address, Gateway address, and Subnet Mask, the Document Centre TCP/IP information will be configured on initial boot.

Your printer and your OfficeTrac server must be connected to a network which has the TCP/IP protocol enabled and all TCP/IP information such as hostname, Default Gateway and Broadcast address have been set.

Your Document Centre and OfficeTrac server should be assigned TCP/IP addresses and the HTTP protocol must have been enabled at your Document Centre. If necessary, refer to the **Internet Services Quick Install Card** to configure your Document Centre in this manner.

If Dynamic TCP/IP addressing must be used, be sure to set lease times long enough to allow for normal maintenance shutdowns. If your Document Centre appears to have stopped communicating with the OfficeTrac server when Dynamic Addressing is in use, check the TCP/IP settings to be sure they have not changed.

As a quick test to verify all the requirements have been met, start the Web Browser from your OfficeTrac server and enter the IP address of the Document Centre to see if you can communicate with it using the HTTP protocol. If the Browser connects and you can see the "Home Page" proceed to the next section entitled **Go to the printer and...**

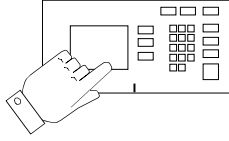

Go to the printer and...

1. Enter the Tools pathway

- a) Press the **Access (A)** button.
- b) On the keypad enter **1111** or the current password. Press the **Enter** button when finished.
- c) Press the **Go to Tools** button.
- d) The Touch Screen will be used for the remainder of the data entry.

2. Enter the Access and Accounting menus

- a) Press the **Access and Accounting** button.
- b) Press the **Authentication Mode** button.

3. Enable Network Accounting

- a) Press the **Network Accounting** button.
- b) Press **Save** to retain the settings and continue.

4. Perform the Network Accounting Setup

- a) Press the **Network Accounting Setup** button.
- b) Press the **Enabled** button.
- c) Press the **Save** button to retain the settings.
- d) Press the **Exit Tools** button.

5. Verify Accounting is enabled

- a) Press the **Job Status** button on the front panel then press the **Features** button.
- b) The Touch Panel should display a screen with two buttons. One is the **User ID** button and the other is the **Account ID** button. This indicates the system has enabled accounting successfully.

Go to the OfficeTrac server and...

1. Activate the Document Centre Site Setup

- a) Open the **Terminal Status** screen. Verify that the Document Centre is displayed as **dcsonline**. Troubleshooting information is contained in the OfficeTrac Administrators documentation.
2. Proceed to the next section of this procedure called **Go to the workstations and...**

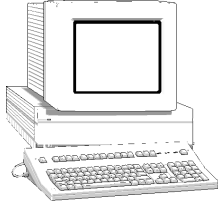

Go to the workstation and...

1. **Install Print drivers** (If print drivers have not already been installed, use the **CentreWare Network Services CD-ROM** to install print drivers. Details for this are found in the document supplied with your printer entitled **CentreWare Network Services Guide**) Workstations with existing Document Centre drivers must be upgraded to the new drivers to allow for printing when Network Accounting is enabled.
2. **Enable Accounting in the print driver**
 - a) At your Windows 95/98/NT 4.0 desktop, click the **Start** button and select **Settings**.
 - b) From the cascade menu select **Printers**.
 - c) Select a printer with the right mouse button.
 - d) Select the **Properties** entry in the cascade menu.
 - e) Select the **User Preferences** tab on the Properties dialog.
 - f) Click the **Enable Accounting** checkbox.
 - g) If you do not want users to have to enter their User and Account ID each time they print, select the **Save Accounting Codes** checkbox.
 - h) If desired you may also select the **Conceal User ID** and **Conceal Account ID** checkboxes to have the asterisk (*) character echoed when this information is entered.
 - i) When finished making selections, click **OK** to close the driver and save the settings.

3. Test the accounting function of the driver

- a) Open an application and print a job. Verify that you are presented with the User ID and Accounting ID screen.
- b) Enter a valid User and Accounting ID and click **OK** (If you selected **Save Accounting Codes** it will only necessary to enter this information the first time the driver is used).
- c) If your print job does not print, try to copy a job at the Document Centre using the same Account and User ID. If the copy job completes then the Account and User ID are valid.
- d) It may be necessary to check the OfficeTrac server configuration to verify the proper User ID and Account ID.
- e) Repeat this **Go to the workstation and...** procedure for each workstation on the network that will print to the printer.

OfficeTrac Troubleshooting

To be sure the Document Centre has had the Network Accounting option installed and enabled, start a Web Browser from your OfficeTrac server and enter the IP address of the Document Centre.

NOTE:

If you are not able to reach the printer, verify all TCP/IP information by printing a configuration sheet.

At the Document Centre "Home Page" select the **Services** button.

Verify that on the **Job Submission** screen, there are entries for **Login ID** and **Account ID**. This will indicate that accounting has been enabled.

The OfficeTrac server software contains some troubleshooting tools that are useful to diagnose problems that may be present at the OfficeTrac server. These tools can be used to correct configuration or communication problems that will prevent your document Centre from reporting accounting data.

For detailed information on these tools, consult your OfficeTrac documentation.

For general product and feature information visit their website at:

www.equitrac.com

Faxing with RightFAX

Overview

The RightFax Fax Server provides the ability to fax paper documents from your Document Centre as well as modify, forward, and distribute electronic copies of documents to other Fax devices or to user workstations. Feature-rich client utilities combined with powerful enterprise management applications make RightFax and the Xerox Document Centre a complete paper to digital document solution for fax communication.

This procedure assumes the following:

- Your RightFax server has already been installed.
- Your Document Centre is installed on your network as a printer, and your Document Centre has the fax option installed that will allow it to send fax documents to a fax repository (destination directory).
- You want to send faxes by FTP (File Transfer Protocol) using the TCP/IP protocol or by NCP(IPX) to the repository.

If you want your Document Centre to send fax documents to a Novell NetWare server Fax Repository, refer to the next section of this document entitled **RightFax Installation for IPX/SPX**.

RightFAX Installation for FTP

Before You Start

NOTE:

Your Document Centre now has DHCP, LPR, and NetBIOS over the IP protocol enabled by default. If your DHCP server will provide host name, IP address, Gateway address, and Subnet Mask, the Document Centre TCP/IP information will be configured on initial boot.

Your Document Centre and your RightFax server must be connected to a network which has the TCP/IP protocol enabled. Additionally, record TCP/IP information such as Hostname, TCP/IP Address, and Default Gateway for both the RightFax server and your Document Centre.

It is strongly recommended your RightFax server is assigned a static IP address. If necessary, refer to the **Static (Manual) TCP/IP Addressing Quick Install Card** contained in this card set to configure your Document Centre in this manner.

Dynamic IP Addressing may be used for the RightFax server provided the DHCP server has been configured with sufficient lease time so that the RightFax server normal maintenance and service down times will not result in a change in TCP/IP address.

An account must be created on the server to which the Document Centre will FTP the fax documents that has sufficient rights or permissions to allow the Document Centre to read files, write files, delete files, and create new directories. Anonymous FTP logins will not allow these rights. Record the login name, home directory, and password of this account for use during this procedure.

Proceed to the next section entitled **Go to the Document Centre and...**

Go to the Document Centre and...

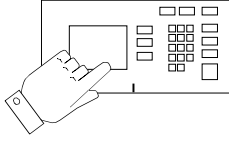

4. Enter the Tools pathway

- a) Press the **Access (A)** button on the front panel.
- b) On the keypad enter **1111** or the current password. Press the **Enter** button when finished. The Touch Screen will be used for the remainder of the data entry.
- c) Press the **Go to Tools** button.

5. Enter the Fax Repository Settings menu

- a) Press the **More** button until you see the **Fax Repository Settings** button appear on the touch screen (the number of times required to press the More button changes depending on which options are installed on your Document Centre).
- b) Press the **Fax Repository Settings** button.
- c) Select the **FTP** button.

6. Set the login name used by your Document Centre to connect to the fax repository

- a) Press the **Login** button and the Login Name screen will appear.
- b) Press the **Login Name** button.

- c) Use the touch screen keyboard to enter the login name for the account created for the Document Centre. (observe case sensitivity)
 - d) Press **Save** to retain the settings.
- 7. Set the password used by your Document Centre to connect to the Fax Repository**
- a) Press the **Password** button and the Password screen will appear.
 - b) Press the **Password** button.
 - c) Use the Touch Screen keyboard to enter the password for the account created for the Document Centre. (observe case sensitivity)
 - d) Press **Save** to retain the settings.
 - e) Press **Save** again to be returned to the Fax Repository Settings screen.
- 8. Set the path for the Fax Repository**
- a) Press the **Path** button.
 - b) The Path screen will appear. Press the **Path** button.
 - c) Use the Touch Screen keyboard to enter the path to the Fax Repository created for the Document Centre (observe case sensitivity).
 - d) Press **Save** again to be returned to the Fax Repository Settings screen.
- 9. Set the server address to which fax documents will be sent**
- a) Press the **Server** button.
 - b) Press the soft buttons on the Touch Screen one at a time for each octet of the server TCP/IP address and enter the numbers from the keypad. When finished press the **Save** button. You will be returned to the Fax Repository Settings screen.
 - c) Press the **Exit Tools** button.

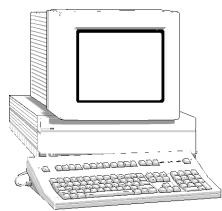

Go to the RightFAX server and...

1. **Set the RightFax server options for receiving Document Centre fax documents** (Refer to the documentation provided with your RightFAX server).
 - a) Open the **WorkServer** Control Panel.
 - b) Select the appropriate WorkServer then select **Xerox Configuration**.
 - c) Enable the **Xerox DCS Interface**.
 - d) Add the path and home directory of the Fax Repository that will be monitored by the RightFax server.
 - e) Close the WorkServer Control Panel.
 - f) Open **Enterprise Fax Manager**.
 - g) Create a Mailbox for the Document Centre (Walkup, Anonymous or Default).
2. Prepare for print driver installation
 - a) From the documentation package supplied with your printer, retrieve the **CentreWare Network Services CD-ROM** and the document entitled **CentreWare Network Services Guide**. Proceed to the next section of this procedure called **Go to a Workstation and...**

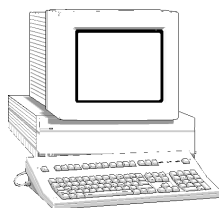

Go to the workstation and...

1. **Install the new upgraded CentreWare print drivers**
 - a) Use the **CentreWare Network Services CD-ROM** and the the instructions in the document entitled **CentreWare Network Services Guide** to install the print driver for your operating system.
 - b) Test your installation by opening an application and print a test fax document and verify its receipt.

If your fax document does not reach its destination refer to the troubleshooting information in the RightFax documentation.

RightFAX Installation for IPX/SPX

Before You Start

Your Document Centre and your RightFax server must be connected to a network which has the Novell NetWare server which contains the Fax Repository.

An account must be created on the NetWare server to which the Document Centre will send the fax documents. This account must have sufficient rights or permissions to allow the Document Centre to read files, write files, delete files, and create new directories. Record the NDS Tree (if applicable), Context (if applicable) login name, Server Volume, home directory, and password of this account for use during this procedure.

Proceed to the next section entitled **Go to the Document Centre and...**

Go to the Document Centre and...

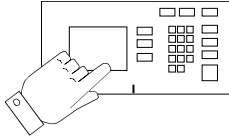

1. **Enter the Tools pathway**
 - a) Press the **Access (A)** button on the front panel.
 - b) On the keypad enter **1111** or the current password. Press the **Enter** button when finished. The Touch Screen will be used for the remainder of the data entry.
 - c) Press the **Go to Tools** button.
2. **Enter the Fax Repository Settings menu**
 - a) Press the **More** button until you see the **Fax Repository Settings** button appear on the touch screen (the number of times required to press the **More** button changes depending on which options are installed on your Document Centre).
 - b) Press the **Fax Repository Settings** button.
 - c) Select the **NetWare** button.
3. **Set the login name used by your Document Centre to connect to the Fax Repository**
 - a) Press the **Login** button and the Login Name screen will appear.
 - b) Press the **Login Name** button and use the touch screen keyboard to enter the login name for the account created.
 - c) Press **Save** to retain the settings and continue.
4. **Set the password used by your Document Centre to connect to the fax repository**
 - a) Press the **Password** button and the Password screen will appear.
 - b) Press the **Password** button and use the touch screen keyboard to enter the password for the account created for the Document Centre. (observe case sensitivity)
 - c) Press **Save** to retain the settings and continue.
 - d) Press **Save** again to be returned to the Fax Repository Settings screen.

5. Set the path for the Fax Repository

- a) Press the **Path** button.
- b) The Path screen will appear. Press the **Path** button and use the touch screen keyboard to enter the path to the fax repository created for the Document Centre. (observe case sensitivity)
- c) Press **Save** again to be returned to the Fax Repository Settings screen.

6. Set the server name and volume to which fax documents will be sent

- a) Press the **Server and Volume** button.
- b) Press the **Server Name** button and use the touch screen keyboard to enter the server name for the account created for the Document Centre. (observe case sensitivity). When finished press the **Save** button.
- c) Press the **Server Volume** button and use the touch screen keyboard to enter the volume name for the account created for the Document Centre. (observe case sensitivity). When finished press the **Save** button.
- d) You will be returned to the **Fax Repository Settings** screen.

7. Configure the NDS settings for the fax repository (skip this step if you are not connecting to an NDS server)

- a) Press the **NDS Settings** button.
- b) Press the **NDS Context** button and use the touch screen keyboard to enter the NDS Context for the account created for the Document Centre (observe case sensitivity). When finished press the **Save** button.
- c) Press the **NDS Tree** button and use the touch screen keyboard to enter the NDS Tree for the account created for the Document Centre (observe case sensitivity). When finished press the **Save** button.
- d) Press the **Exit Tools** button.

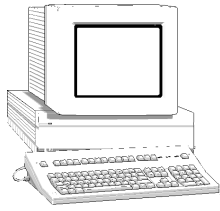

Go to the RightFax server and...

1. **Set the RightFax server options for receiving Document Centre fax documents** (details for these procedures are available in the documentation provided with your RightFax server)
 - a) Enable Xerox DCS transactions.
 - b) Add the path and home directory of the Fax Repository that will be monitored by the RightFax server.
 - c) From the documentation package supplied with your printer, retrieve the **CentreWare Network Services CD-ROM** and the document entitled **CentreWare Network Services Guide**. Proceed to the next section of this procedure called **Go to a Workstation and...**

Go to the workstation and...

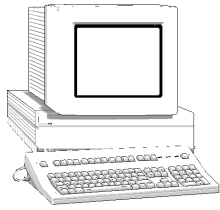

1. **Install the new upgraded CentreWare print drivers**
 - a) Use the **CentreWare Network Services CD-ROM** and the instructions in the document entitled **CentreWare Network Services Guide** to install the print driver for your operating system.
 - b) Test your installation by opening an application and print a test fax document and verify its receipt.

If your fax document does not reach its destination refer to the troubleshooting information in the RightFax documentation.

RightFAX Troubleshooting

TCP/IP (FTP) Troubleshooting

1. Fax a document from the Document Centre. Observe the fax repository directory to watch for documents that have been faxed. If documents are able to reach this directory, the RightFAX server should be checked to make sure the Workserver is configured to Enable DCS Interface and the path for the repository is set correctly. Consult the RightFAX documentation for details on how to configure the Workserver.
2. Verify that the TCP/IP information configured at the Document Centre is correct.
3. Verify that **FTP** is configured as the filing protocol in the **Fax Repository Settings** screen of the Document Centre Tools pathway.
4. Verify that the **Login** and **Password** shown in the **Fax Repository Settings** screen of the Document Centre Tools pathway are correct (these are CASE SENSITIVE).
5. Verify that the **Path** entry is correct in the **Fax Repository Settings** screen of the Document Centre Tools pathway.
6. At the RightFAX server, verify that the user Login name and password created for the Document Centre are correct and have sufficient rights (permissions) to write files, and create directories in the fax repository. Be aware that the default settings for the (IIS) Internet Information Server FTP server do not allow write permission. You may check this in the FTP server Properties dialog.
7. Test the server settings with an FTP program. Connect to the server TCP/IP address and login with the Login Name and Password that was set for the Document Centre. Verify that you are in the path directory that was configured.
8. Create a directory. If you can create a directory, then the account has sufficient permissions to fax documents to that directory. If you cannot create a directory, adjust the permissions for the account.

NetWare (IPX/SPX) Troubleshooting

1. Fax a document from the Document Centre. Observe the fax repository directory to watch for documents that have been faxed. If documents are able to reach this directory, the RightFAX server should be checked to make sure the Workserver is configured to Enable DCS Interface and the path for the repository is set correctly. Consult the RightFAX documentation for details on how to configure the Workserver.
2. Verify that **NetWare** is set in the **Fax Repository Settings** screen of the Document Centre Tools pathway.
3. Verify that the **Login** and **Password** shown in the **Fax Repository Settings** screen of the Document Centre Tools pathway are correct (these are CASE SENSITIVE).
4. Verify that the **Path** entry is correct in the **Fax Repository Settings** screen of the Document Centre Tools pathway.
5. Verify that the **Server Name** entry is correct in the **Server and Volume** screen of the Document Centre Tools pathway.
6. Verify that the **Server Volume** entry is correct in the **Server and Volume** screen of the Document Centre Tools pathway.
7. For NetWare 4.X, 5.X ONLY, verify that the **NDS Context** entry is correct in the **NDS Settings** screen of the Document Centre Tools pathway.
8. For NetWare 4.X, 5.X ONLY, verify that the **NDS Tree** entry is correct in the **NDS Settings** screen of the Document Centre Tools pathway.
9. From a workstation on the network, login to the fax repository server with the Login Name and Password specified for your Document Centre. Verify that you are in the correct directory and if not, modify the user settings with SYSCON or NWADMIN to include the correct volume, path, and directory.
10. Create a directory in the path. If you cannot create a directory, modify the user settings with SYSCON or NWADMIN to grant rights to the correct volume, path, and directory.

Scan Setup without CentreWare

Introduction

Xerox brings the versatility of network scanning to your workstation. By combining the power of the Xerox Document Centre, CentreWare Internet Services, and third-party applications, Xerox provides a network scanning solution for all scanning users.

After the optional Scanning Services kit is installed on the Xerox Document Centre, you can select scanning features, scan documents, and transfer them to a file server. The document can then be accessed from your workstation or shared with other users connected to the network, if desired. The document can be opened by any software application that can view or edit TIFF files. For example, Visioneer PaperPort, which is included on a CD ROM with your Document Centre when you purchase the Scanning Services option can view and edit TIFF files.

The scanned images can also be imported into TextBridge Pro for Optical Character Recognition (OCR) processing.

*Scan Setup without
CentreWare*

Terminology used in this Chapter

Document Repository	A Document Repository is a filing directory where TIFF files are stored. Typically, this will be located on a NetWare server or FTP (File Transfer Protocol) server.
Scan Template	A Scan Template controls the features applied to the scanned document as well as the Filing Policy and repository location.
Template Pool	The Template Pool is the central location on a server where scan templates created with Xerox's CentreWare Scanning Services are stored.
Filing Policy	The Filing Policy specifies the method used to store the TIFF images in the document repository. There are several options: <ul style="list-style-type: none">• Overwrite• Append• New Exact• New Auto Generate
Output Image Format	<ul style="list-style-type: none">• TIFF• Multi-Page TIFF

Who Should Use This Guide

This chapter is a companion to the **Network Scanning Services Guide** and is intended to be used by System Administrators who are setting up network scanning without using CentreWare Network Scanning Services. CentreWare Network Scanning Services is intended for use on Windows based workstations.

There are two other options for setting up scanning services:

- Setting up Native Scanning
- Setting up Scanning Using CentreWare Internet Services

Both of these set up options require the use of procedures in this guide. For Setting up Scanning Using CentreWare Internet Services, you will need to complete some processes here, and then refer to the **Internet Services Guide** to complete the set up. All of the procedures for setting up Native Scanning are included here.

Whether you are setting up Native Scanning or Scanning Using CentreWare Internet Services, there are two options for file transfer. They are:

- Setting Up Scanning - NetWare (NCP)
- Setting Up Scanning - FTP (File Transfer Protocol)

Procedures for both of these file transfer options are contained in this guide.

NOTE

If you will be using Xerox's CentreWare Network Scanning Services to set up scanning on the Document Centre, refer to the **Network Scanning Services Guide** guide now.

To use the procedures in this guide effectively, you must have experience working in a network environment. You must also have access to the network and possess Supervisor (Administrator) rights. You may also require documentation provided by network and client workstation vendors.

*Scan Setup without
CentreWare*

What to Do Next

To complete the setup of the Document Centre and your network to enable scanning, perform the following steps.

1. Review the information in the **Scanning Overview** section of this chapter. Read the entire overview, including the **Overview of Repositories**.
2. Refer to the appropriate section of this guide. Choose from:
 - **Set Up Scanning - NetWare**. NCP (NetWare Core Protocol) is available for Ethernet and Token Ring filing to a NetWare server.
 - **Set Up Scanning - FTP (File Transfer Protocol)**. FTP is available for Ethernet and Token Ring (if installed) and requires an FTP server running on a server or a workstation.
3. **OPTIONAL**: If you are using Xerox CentreWare Internet Services to perform network scanning, refer to the **Internet Services Guide**.

Scanning Overview

Scanning a document has traditionally involved a dedicated scanner attached to a single PC. In this environment, a single user at the PC has access to the scanner. Other users cannot scan documents without interrupting the person using the scanner and PC. This is inconvenient and inefficient.

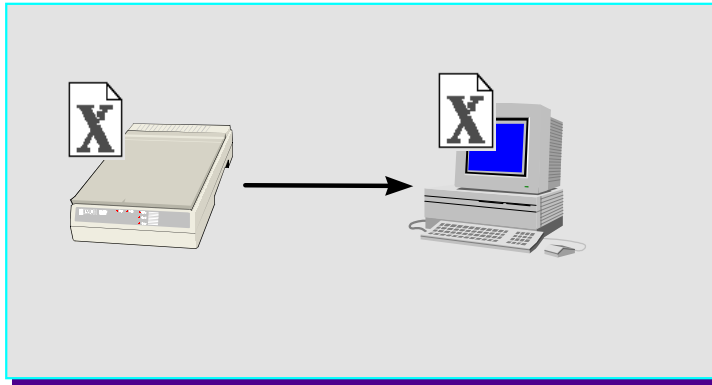

Traditional Scanning

*Scan Setup without
CentreWare*

Scanning with the Document Centre

Using the Document Centre, multiple users can scan and store documents without multiple scanning devices. Using the power of the local area network, multiple users can access the scanner and use it to scan their documents.

Scanning with the Document Centre is accomplished through the use of a *file server*. The file server is used as a temporary storage location for the scanned document file. After scanning and storage on the file server, the file can be manually retrieved by a user at a network workstation.

NOTE

Automatic retrieval of the scanned document to a workstation is possible using Xerox's CentreWare Network Scanning Services. Refer to the **Network Scanning Services Guide** for more information.

A "dedicated file server" is not required. The Document Centre can store documents on an existing file server.

To perform network scanning, the Document Centre is installed on a local area network. The protocol of the local area network must be NetWare SPX/IPX or TCP/IP. For the user to retrieve the scanned document file, it must be transferred to a file server. The scanning and filing of the document are controlled by a scanning component called a *scan template*.

Scan Templates

The scan template is essentially a job ticket for the scanned job. The template is user-programmable, and contains parameters for the scanned document. The user can program parameters such as one-sided or two-sided scanning, scanned image size, and the location on the file server where the file will be stored.

The Default Template

A default scan template (*default.xst*) is created during the installation of the scanning option and is stored on the Document Centre. It is available for all scanning installations.

It is selected at the Document Centre Control Panel Touch Screen to begin the scanning process.

NOTE

The Native scanning installations described in this guide provide only the *default.xst* template for all scanning users.

In this environment, additional scan templates can easily be created using only Xerox's CentreWare Internet Services, or the CentreWare Template Utility. You **MUST** refer to the **Internet Services Guide** to create templates with Internet Services, or the **Network Scanning Services Guide** to use the CentreWare Template Utility.

The Scanning Process

Under the control of the instructions in the scan template, the Xerox Document Centre can scan hard copy documents and create electronic Tagged Image File Format (TIFF) files.

Using the filing information that is contained in the template, the TIFF file or files are transferred to a *document repository* on the file server. The document repository is simply a directory on the file server.

All pages of a multi-page document are scanned prior to the job being sent to the document repository.

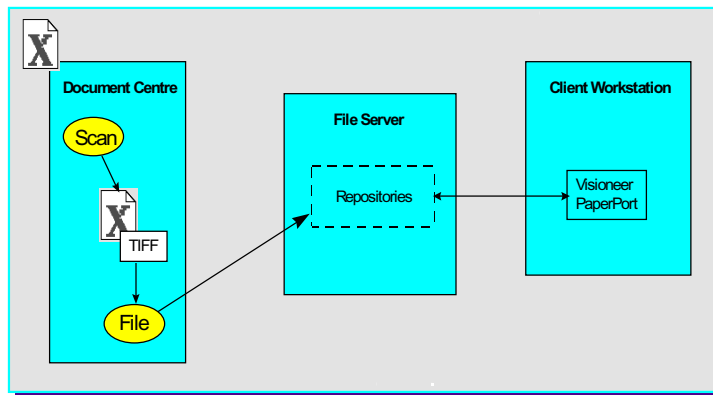

Scanning Process

After the scanned document files are sent to the file server, the user can retrieve the files from a network workstation.

The three main steps involved in scanning a job are:

1. **Scan a hard copy document at the Document Centre.**
Select a scan template from the Control Panel Touch Screen and scan the hard copy document at the Document Centre. Scan templates define the Directory and the Document Folder on the server where the scanned file will be stored.
2. **The scanned files are sent to a specified location on the file server.**

After pages have been scanned and converted to TIFF 6.0 files, the Document Centre logs into an account on the file server and stores the TIFF files in a specific directory (the document repository) on the file server. As with any user account, access to the file server is controlled by a user name and password.

To name and store the TIFF files, a numbering scheme (such as 00000001.TIF, 00000002.TIF, 00000003.TIF) is applied to each file. The Document Centre then logs out of the server.

NOTE

During the transfer of the TIFF file in a NetWare environment, the Document Centre will be already logged in under one license as a printer, and will log in again to transfer the file. After transfer occurs, the Document Centre logs out, making the second user license available again. While available to other users, the second connection is maintained at the NetWare file server as “Not logged in”. This happens during every scan job. If a license is not available, the file transfer will fail and the Document Centre will not retry the operation. If this occurs, the scan job will have to be run again when a license becomes available.

NOTE

The method used at a workstation to access the document repository and the method used at the Document Centre to send the documents are independent. For instance, the Document Centre may file the TIFF images using FTP (File Transfer Protocol) to an NT Server; while the workstation may retrieve the images using NetBIOS/NetBEUI.

*Scan Setup without
CentreWare*

3. **A user retrieves the TIFF files.**

The user manually retrieves the TIFF files and can then manipulate the electronic file as desired. For example, Visioneer PaperPort, which is included on the Scanning Services option can view and edit TIFF files.

PaperPort has an intuitive interface that enables you to annotate, organise, file, and locate scanned documents. Using PaperPort links, you can transfer documents from the PaperPort desktop to other applications and devices installed on your workstation.

Overview of Repositories

NOTE:

Repositories may only be created with CentreWare Internet Services through your Web Browser. For details on how to use Internet Services to create Templates and Repositories, refer to the document supplied with your Document Centre entitled **Internet Services Guide**.

As explained below, there are two different types of repositories available on the file server, Public Repositories and Private Repositories.

Public Repositories

Public repositories can be selected by all users as the destination for their scanned files.

The scan template for a public repository includes the name and the password required for access to the repository.

When this scan template is selected at the Document Centre, the name and password will not have to be entered because the name and password are already contained in the scan template. Be sure to read the *Repository Filing Policy* information on the next page. The **Overwrite** Filing Policy allows previously scanned jobs in the directory to be overwritten. This might be an inappropriate Filing Policy choice for a public repository.

*Scan Setup without
CentreWare*

Private Repositories

Private repositories require a name and password that is different from the name and password that the Document Centre uses to access the public repositories. The appropriate name and password must be entered at the Document Centre when the scan template is selected, or the scanning operation will fail. This prevents unauthorised use of private repositories as the destination for scanned files.

NOTE

The appropriate name may also be preset in the scan template when it is originally created. When a scan template is selected that already has the appropriate name, only the correct password must be entered at the Document Centre.

Repository Filing Policy

NOTE:

Filing Policies are only supported when scan templates are created with CentreWare Internet Services through your Web Browser. For details on how to use Internet Services to create Templates and filing policies, refer to the document supplied with your Document Centre entitled **Internet Services Guide**.

The *Filing Policy* specifies the method used to store the TIFF images in the document repository. There are several options:

- The **Overwrite** Filing Policy deletes any TIFF files stored in the document repository before sending the newly scanned files for storage. All overwritten files are lost, but since the files are overwritten, disk space is conserved.
- The **Append** Filing Policy does not delete existing files. Newly scanned files are added to existing files in the document repository. It is recommended that you delete old files on a regular basis in order to conserve server space.
- The **New Exact** Filing Policy checks to see if any files already exist in the document repository. If there are no files in the repository, the newly scanned files are sent to it. If there are files stored in the repository, the scan job is aborted.
- The **New Auto Generate** Filing Policy creates a new directory structure, based on the time and date of creation, into which the TIFF images are filed. While this may seem like the safest Filing Policy choice, keep in mind that it also requires more disk space than the Overwrite Filing policy.

Output Image Quality

- **Multi-Page TIFF** can be enabled using Xerox CentreWare Internet Services. When Multi-Page TIFF is enabled, a single TIFF file will be created for a multi-page document. This single TIFF file will contain all the pages of the document. An .XSM folder is not created when scanning in the Multi-Page TIFF mode. A single TIFF file and a log file (.xst) are stored in the repository for each multi-page document that is scanned.

CAUTION

Not all applications will accept the Multi-Page TIFF format. Applications that do not support Multi-Page TIFFs will typically import and display only the first page of the document.

Repository Locking

More than one Document Centre can log into a file server and transfer a file to the same document repository, but *not at the same time*.

When one Document Centre logs in to transfer a file, the document repository is locked. Another Document Centre cannot transfer a file to the repository. This prevents possible corruption of the files.

Multiple Logins

More than one Document Centre can transfer files to *different repositories* in the same file server at the same time. This is similar to more than one user logging into a file server at the same time to transfer files to different directories.

Existing Accounts

A Document Centre can use an existing user account if the account is enabled for multiple logins. The account for the scanner is no different from a user account. *It is a user account!*

Logging in to Multiple File Servers

The same Document Centre can log into more than one file server and transfer a file to a document repository, *but not at the same time.*

This is similar to a user logging into more than one file server. The scanner requires accounts in all file servers that it needs to access.

*Scan Setup without
CentreWare*

Set Up Scanning - NetWare

Before You Start

Prior to starting the installation procedure, perform the following steps:

1. Ensure that the Document Centre is connected, configured, and operating correctly as a printer.
2. Use the SYSCON utility for NetWare 3.x, or NWADMIN for NetWare 4.x to create a user account on the file server for the scanner.
3. Create a directory on the file server to be used as a repository for scanned files. Give the scanner user account all access rights to this directory, except supervisor. The repository name cannot exceed 8 characters.

NOTE

Refer to the NetWare documentation for additional information, if needed.

When a document is scanned, the Document Centre logs into the scanner user account with the user name and password, transfers the file to the repository in the server, and then logs out.

NOTE

The Document Centre supports TIFF File Formats.

*Scan Setup without
CentreWare*

Set Up Options

There are two procedures that can be used to successfully set up scanning. Read the information below and choose the procedure that you will use to complete the installation:

- **Set Up Scanning**
To complete the native implementation of scanning for your NetWare environment, go to the section of this chapter titled *Set Up Scanning* now.
- **Use Xerox CentreWare Internet Services**

Xerox's CentreWare Internet Services is accessed through the embedded HTTP server on the Document Centre that allows System Administrators and users to configure scan settings. This is accomplished by using an Internet browser such as NetScape (version 3.x or later) or Microsoft Internet Explorer (version 4.x or later).

Using Internet Services, you can:

- Create new scan templates
- Update existing scan templates
- Modify scan configurations (including document repository locations), enable and disable Confirmation Sheets, and change Filing Protocols.
- Enable Multi-Page TIFF, which will create a single TIFF file for a multi-page document, instead of one TIFF file for each page

Output Image Quality

- *Multi-Page TIFF* can be enabled using Xerox CentreWare Internet Services. When Multi-Page TIFF is enabled, a single TIFF file will be created for a multi-page document. This single TIFF file will contain all the pages of the document. An .XSM folder is not created when scanning in the Multi-Page TIFF mode. A single TIFF file and a log file (.xst) are stored in the repository for each multi-page document that is scanned.

CAUTION

Not all applications will accept the Multi-Page TIFF format. Applications that do not support Multi-Page TIFFs will typically import and display only the first page of the document.

If you will be using CentreWare Internet Services to complete the installation, perform these steps.

- A. Refer to the chapter entitled **Internet Services** in this document.
- B. Follow the instructions located in the section of this chapter entitled **Set up Scanning**.
- C. Finally, refer to the section entitled **Scanning Documents** of the **Internet Services Guide**, and follow the instructions there.

*Scan Setup without
CentreWare*

General Installation Requirements

Item	Purpose	Provided by
Document Centre Scanning Services kit	This kit must be installed before proceeding with the installation steps in this chapter.	Xerox
Scan User Name	When a document is scanned, the Document Centre logs in to the user account with the user name and password, transfers the file to the server, and then logs out.	Customer
Scan User Password	When a document is scanned, the Document Centre logs in to the user account with the user name and password, transfers the file to the server, and then logs out.	Customer
File Repository Server	The hard copy document is scanned by the Document Centre and saved electronically in a designated file server repository.	Customer
Repository Directory	Repositories are directories or filing destinations where documents are stored and held in .XSM (Xerox document storage) format folders. The default folder name is DOC.XSM. A repository name cannot exceed 8 characters.	Customer
NDS Tree	<ul style="list-style-type: none">• For an NDS installation, assign the Document Centre to an NDS Tree.• For a Bindery installation, set the NDS Tree to a dash - to disable NDS.	Customer
NDS Context	<ul style="list-style-type: none">• For an NDS installation, assign the Document Centre to an NDS Name Context.• For a Bindery installation, set the NDS Context to a dash - to disable NDS.	Customer

Set Up Scanning

1. Enter the Tools pathway

- a) Press the **Access (A)** button on the front panel.
- b) On the keypad enter **1111** or the current password. Press the **Enter** button when finished. The Touch Screen will be used for the remainder of the data entry.

2. Enter the Network Scanning Setups menu

- a) Press the **More** button until you see the **Network Scanning Setups** button appear on the touch screen (the number of times required to press the More button changes depending on which options are installed on your Document Centre).
- b) Press the **Scan Repository Settings** button.
- c) Select the **NetWare** button.

3. Set the login name used by your Document Centre to connect to the Scan Repository server

- a) Press the **Login** button and the Login Name screen will appear.

CAUTION

The Login Name is the name of the Scan User account. It should be entered exactly as you entered it when you created the account with SYSCON or NWADMIN. If the names do not match exactly, the Document Centre will not log into the file server.

- b) Press the **Login Name** button and use the touch screen keyboard to enter the login name for the account created.
- c) Press **Save** to retain the settings and continue.

*Scan Setup without
CentreWare*

4. Set the password used by your Document Centre to connect to the Scan Repository server

- a) Press the **Password** button and the Password screen will appear.

CAUTION

This is the Password for the Scan User account. It should be entered exactly as you entered it when you created the account with SYSCON or NWADMIN. If the passwords do not match exactly, the Document Centre will not log into the file server.

- b) Press the **Password** button and use the touch screen keyboard to enter the password for the account created for the Document Centre. (observe case sensitivity)
- c) Press **Save** to retain the settings and continue.
- d) Press **Save** again to be returned to the Fax Repository Settings screen.

5. Set the path for the Scan Repository

- a) Press the **Path** button.
- b) The Path screen will appear. Press the **Path** button and use the touch screen keyboard to enter the path to the scan repository created for the Document Centre. (observe case sensitivity)
- c) Press **Save** again to be returned to the Scan Repository Settings screen.

6. Set the server name and volume to which fax documents will be sent

- a) Press the **Server and Volume** button.
- b) Press the **Server Name** button and use the touch screen keyboard to enter the server name for the account created for the Document Centre. (observe case sensitivity). When finished press the **Save** button.
- c) Press the **Server Volume** button and use the touch screen keyboard to enter the volume name for the account created for the Document Centre. (observe case sensitivity). When finished press the **Save** button.

NOTE

It is strongly recommended that you do not use a directory in the SYS volume, since it could quickly fill up with scanned files.

- d) You will be returned to the **Scan Repository Settings** screen.

7. Configure the NDS settings for the Scan repository (skip this step if you are not connecting to an NDS server)

NOTE

Refer to the information displayed by NWADMIN and the NetWare documentation for help in determining the name of the NDS Tree and Context.

- a) Press the **NDS Settings** button.

An example of the NDS Context information required in this field is:

OU=AAAAA . O=BBBBB . C=CCCC

where:

AAAAA represents the name of an organisational unit. There can be more than one organisational unit in the NDS Context.

BBBBB is the name of the organisation.

CCCC represents the name of the country you are in.

An example of a complete NDS Context is:

OU=SHIPPING . OU=MANUFACTURING . O=XEROX . C=US

In this example, SHIPPING is an organisational unit within MANUFACTURING, which is an organisational unit within XEROX. The US (United States) is the country in which these organisations exist.

- b) Press the **NDS Context** button and use the touch screen keyboard to enter the NDS Context for the account created for the Document Centre (observe case sensitivity). When finished press the **Save** button.
- c) Press the **NDS Tree** button and use the touch screen keyboard to enter the NDS Tree for the account created for the Document Centre (observe case sensitivity). When finished press the **Save** button.
- d) Press the **Exit Tools** button.

8. It is recommended that you install the Visioneer PaperPort software, which is shipped on a CD ROM and included with your Document Centre when you purchase Scanning Services. This software should be installed at each client workstation.

PaperPort allows you to annotate, organise, file and locate scanned TIFF documents. After you scan a document at the Document Centre, you can access PaperPort and retrieve the scanned file within the PaperPort application. With PaperPort links, you can transfer documents between the PaperPort desktop and other applications and devices on your workstation.

PaperPort contains links to several types of applications and devices, including:

- electronic fax applications
- electronic mail (“E-Mail”) applications
- optical character recognition (“OCR”) applications
- printers
- personal information managers (“PIM”)
- document control systems.

*Scan Setup without
CentreWare*

Test scanning

- A. Place the document that you want to scan in the Document Feeder, or place the first page on the Document Glass.
- B. Select the **Scan** feature on the Document Centre Touch Screen.
- C. Scan jobs are based on templates that contain programming selections for your job. Verify that **default.xst** is highlighted in the scan template list. This is the default template.
- D. If desired, select **More Scanning Features** and modify the template by selecting options from the *Scan Setups* tab on the Document Centre Touch Screen. Note that any changes you make from the Touch Screen apply only to the current job. The template settings will be restored after the completion of the scan job.
- E. Press the **Start** button. After the job is scanned, the Document Centre files, faxes, and prints the job as specified in the default.xst scan template. At completion, a Confirmation Sheet (if enabled) is printed that describes the results of the job.
- F. Allow approximately one minute for the process to complete a one-page job. It will take longer if you have scanned multiple pages. Then check to make sure that the scanned file has been stored in the designated repository on the file server.
- G. The Document Centre creates a separate TIFF file for each page it scans. (Unless the Enable Multi-Page TIFF option is selected, which will create a single TIFF file for a multi-page document, instead of one TIFF file for each page.) Pages are numbered sequentially. Files are stored on the file server, and the directory path is specified within the job template.

NOTE

If the scanning operation is not successful, check the Confirmation Sheet for a message or other information that may be helpful in identifying the cause of the problem.

- H. The scanned file is transferred to a folder in the scanner account on the file server. The *.XSM* extension on the folder represents a Xerox document storage format that is designed to simplify integration with third-party software applications.
- I. At your workstation, view or list the directory path for the scanner account on the file server. The scanning operation created a folder named *DOC.XSM*.
- J. Open the *DOC.XSM* folder. You should see several files in this folder:

0000001.TIF ...0000002.TIF for example, are the individual TIFF images of the pages that were scanned. There can be several TIFF files if the document has more than one page, or if **Append** was selected for the *Filing Policy* and more than one document has been scanned.

Each page of the document is represented by a different TIFF file. (Unless the Enable Multi-Page TIFF option is selected, which will create a single TIFF file for a multi-page document, instead of one TIFF file for each page.)

NOTE

The Document Centre supports TIFF File Formats.

NETSCAN.DAT is an ASCII file which contains the names of the TIFF files scanned with the last scanning operation. This file is updated after every successful storage of a .TIF file.

NEXTNAME.DAT is an ASCII file which contains the name of the next available .TIF file. This name is controlled and incremented based on the Filing Policy specified in the job template.

NETSCAN.XST contains the template information for the last file that was scanned. It is also used as a job log for status and a source for the post-processing of information.

XSMDESC.DAT is an ASCII file containing the document name (0-50 characters).

*Scan Setup without
CentreWare*

- K. At this point, the TIFF file can be imported into any software application that can accept TIFF files.
- L. Scanning is now ready to operate. Subsequent scanning operations can be modified by changing the selections in the Default Template using the Document Centre Touch Screen.
- M. The installation process is now complete.

Set Up Scanning - FTP (File Transfer Protocol)

Before You Start

Prior to starting the installation procedure, perform the following:

1. Ensure that the Document Centre is connected, configured, and operating correctly as a network printer.
2. Ensure that FTP Services are running on a platform on the network.

If FTP Services is running on a Windows NT server, ensure that **Allow Only Anonymous Connections** is NOT selected.

3. Create a user account for the scanner.

If the account is created on a Windows NT server, select **User Cannot Change Password** and **Password Never Expires** when the password is set, and select **Logon Locally** under User Rights.

4. Create a directory to be used as a repository for scanned files.

If the directory is created on a Windows NT server, enter the scan user name in the Alias box and select **Access Read and Write**.

*Scan Setup without
CentreWare*

Set Up Options

There are two procedures that can be used to successfully set up scanning. Read the information below and choose the procedure that you will use to complete the installation:

- **Set Up Scanning**
To complete the native implementation of scanning for your network environment, go to the section of this chapter titled *Set Up Scanning* now.
- **Use Xerox CentreWare Internet Services**

Xerox's CentreWare Internet Services is accessed through the embedded HTTP server on the Document Centre that allows System Administrators and users to configure scan settings. This is accomplished by using an Internet browser such as NetScape (version 3.x or later) or Microsoft Internet Explorer (version 4.x or later).

Using Internet Services, you can:

- Create new scan templates
- Update existing scan templates
- Modify scan configurations (including document repository locations) enable and disable Confirmation Sheets, and change Filing Protocols.
- Enable Multi-Page TIFF, which will create a single TIFF file for a multi-page document, instead of one TIFF file for each page.

Output Image Quality

- *Multi-Page TIFF* can be enabled using Xerox CentreWare Internet Services. When Multi-Page TIFF is enabled, a single TIFF file will be created for a multi-page document. This single TIFF file will contain all the pages of the document. An .XSM folder is not created when scanning in the Multi-Page TIFF mode. A single TIFF file and a log file (.xst) are stored in the repository for each multi-page document that is scanned.

CAUTION

Not all applications will accept the Multi-Page TIFF format. Applications that do not support Multi-Page TIFFs will typically import and display only the first page of the document.

If you will be using CentreWare Internet Services to complete the installation, perform these steps.

- A. Refer to the chapter entitled **Internet Services** in this document.
- B. Follow the instructions located in the section of the chapter entitled **Configure your printer**.
- C. Finally, refer to the section entitled **Scanning Documents** of the **Internet Services Guide**, and follow the instructions there.

*Scan Setup without
CentreWare*

General Installation Requirements

Item	Purpose	Provided by
Document Centre Scanning Services kit	This kit must be installed before proceeding with the installation steps in this chapter.	Xerox
Scan User Name	When a document is scanned, the Document Centre logs in to the user account with the user name and password, transfers the file to the server, and then logs out.	Customer
Scan User Password	When a document is scanned, the Document Centre logs in to the user account with the user name and password, transfers the file to the server, and then logs out.	Customer
File Repository Server	The hard copy document is scanned by the Document Centre and saved electronically in a designated file server repository.	Customer
Repository Directory	Repositories are directories or filing destinations where documents are stored and held in .XSM (Xerox document storage) format folders.	Customer

Set Up Scanning

1. **Enter the Tools pathway**
 - a) Press the **Access (A)** button on the front panel.
 - b) On the keypad enter **1111** or the current password. Press the **Enter** button when finished. The Touch Screen will be used for the remainder of the data entry.
2. **Enter the Network Scanning Setups menu**
 - a) Press the **More** button until you see the **Network Scanning Setups** button appear on the touch screen (the number of times required to press the More button changes depending on which options are installed on your Document Centre).
 - b) Press the **Scan Repository Settings** button.
 - c) Select the **FTP** button.
3. **Set the login name used by your Document Centre to connect to the scan repository**

CAUTION

The Login Name is the name of the Scan User account. It should be entered exactly as you entered it when you created the account. If the names do not match exactly, the Document Centre will not log into FTP Services. Remember that some FTP Services are case-sensitive.

- a) Press the **Login** button and the Login Name screen will appear.
- b) Press the **Login Name** button.

*Scan Setup without
CentreWare*

- c) Use the touch screen keyboard to enter the login name for the account created for the Document Centre. (observe case sensitivity)
- d) Press **Save** to retain the settings.

4. Set the password used by your Document Centre to connect to the Scan Repository

CAUTION

This is the Password for the Scan User account. It should be entered exactly as you entered it when you created the account. If the passwords do not match exactly, the Document Centre will not log into FTP Services. Remember that some FTP Services are case-sensitive.

- a) Press the **Password** button and the Password screen will appear.
- b) Press the **Password** button.
- c) Use the Touch Screen keyboard to enter the password for the account created for the Document Centre. (observe case sensitivity)
- d) Press **Save** to retain the settings.
- e) Enter password again at the confirmation screen.
- f) Press **Save** again to be returned to the Scan Repository Settings screen.

5. Set the path for the Scan Repository

- a) Press the **Path** button.
- b) The Path screen will appear. Press the **Path** button.
- c) Use the Touch Screen keyboard to enter the path to the Scan Repository created for the Document Centre (observe case sensitivity).
- d) Press **Save** again to be returned to the Scan Repository Settings screen.

6. Set the server address to which the scanned documents will be sent

- a) Press the **Server** button.

- b) Press the soft buttons on the Touch Screen one at a time for each octet of the server TCP/IP address and enter the numbers from the keypad. When finished press the **Save** button. You will be returned to the Scan Repository Settings screen.
 - c) Press the **Exit Tools** button.
7. It is recommended that you install the Visioneer PaperPort software, which is shipped on a CD ROM, and included with your Document Centre when you purchase Scanning Services. This software should be installed at each client workstation.

*Scan Setup without
CentreWare*

PaperPort allows you to annotate, organise, file and locate scanned TIFF documents. After you scan a document at the Document Centre, you can access PaperPort and retrieve the scanned file within the PaperPort application. With PaperPort links, you can transfer documents between the PaperPort desktop and other applications and devices on your workstation.

PaperPort contains links to several types of applications and devices, including:

- electronic fax applications
- electronic mail (“E-Mail”) applications
- optical character recognition (“OCR”) applications
- printers
- personal information managers (“PIM”)
- document control systems.

Test scanning

- A. Place the document that you want to scan in the Document Feeder, or place the first page on the Document Glass.
- B. Select the **Scan** feature on the Document Centre Touch Screen.
- C. Scan jobs are based on templates that contain programming selections for your job. Verify that **default.xst** is highlighted in the scan template list. This is the default template.
- D. If desired, select **More Scanning Features** and modify the template by selecting options from the *Scan Setups* tab on the Document Centre Touch Screen. Note that any changes you make from the Touch Screen apply only to the current job. The template settings will be restored after the completion of the scan job.

*Scan Setup without
CentreWare*

- E. Press the **Start** button. After the job is scanned, the Document Centre files, faxes, and prints the job as specified in the default.xst scan template. At completion, a Confirmation Sheet (if enabled) is printed that describes the results of the job.
- F. Allow approximately one minute for the process to complete a one-page job. It will take longer if you have scanned multiple pages. Then check to make sure that the scanned file has been stored in the repository on the file server.
- G. The Document Centre creates a separate TIFF file for each page it scans. (Unless the Enable Multi-Page TIFF option is selected, which will create a single TIFF file for a multi-page document, instead of one TIFF file for each page.) Pages are numbered sequentially. Files are stored on the file server, and the directory path is specified within the job template.

NOTE

If the scanning operation is not successful, check the Confirmation Sheet for a message or other information that may be helpful in identifying the cause of the problem.

- H. The scanned file is transferred to a folder in the scanner account on the file server. The *.XSM* extension on the folder represents a Xerox document storage format that is designed to simplify integration with third-party software applications.
- I. At your workstation, view or list the directory path for the scanner account on the file server. The scanning operation created a folder named *DOC.XSM*.
- J. Open the *DOC.XSM* folder. You should see several files in this folder:
 - 0000001.TIF ...0000002.TIF** for example, are the individual TIFF images of the pages that were scanned. There can be several TIFF files if the document has more than one page, or if **Append** was selected for the *Filing Policy* and more than one document has been scanned. Each page of the document is represented by a different TIFF file. (Unless the Enable Multi-Page TIFF option is selected, which will create a single TIFF file for a multi-page document, instead of one TIFF file for each page.)
 - NETSCAN.DAT** is an ASCII file which contains the

names of the TIFF files scanned with the last scanning operation. This file is updated after every successful storage of a .TIF file.

NEXTNAME.DAT is an ASCII file which contains the name of the next available .TIF file. This name is controlled and incremented based on the Filing Policy specified in the job template.

NETSCAN.XST contains the template information for the last file that was scanned. It is also used as a job log for status and a source for the post-processing of information.

XSMDESC.DAT is an ASCII file containing the document name (0-50 characters).

- K. At this point, the TIFF file can be imported into any software application that can accept TIFF files.
- L. Scanning is now ready to operate. Subsequent scanning operations can be modified by changing the selections in the Default Template using the Document Centre Touch Screen.

The installation process is now complete.

*Scan Setup without
CentreWare*

Hints and Tips / Problem Solving

Hints and Tips

1. Prior to performing the initial scan job, verify the following from a workstation on the network by logging into the scan account and copying a file into the scan repository:
 - The Document Centre user account and password are correct.
 - The correct rights to the document repository have been assigned to the Document Centre.

Also, make sure that the Confirmation Sheet option is enabled. This provides details of each scan job, including status, filing location, Filing Policy and scan settings. Enabling the Confirmation Sheet is part of the set up procedure detailed in the *Set Up Scanning - NetWare* and *Set Up Scanning - FTP (File Transfer Protocol)* chapters of this guide.

2. You can confirm that a scan job was successfully completed by verifying that the number of pages scanned is the same as the number of files stored in the document repository for that job. (Unless the Enable Multi-Page TIFF option is selected, which will create a single TIFF file for a multi-page document, instead of one TIFF file for each page.)
3. The default directory created for each scan job is DOC.XSM.

Installation Considerations

Filing Policy

- An **advantage** of the *Overwrite* policy is that minimal disk space is required since files are deleted and recreated for each scan job. This makes it ideal for users with their own file space allocation.
- A **disadvantage** of the *Overwrite* policy is that with a shared document repository, users will overwrite other users' files, possibly before the file is retrieved by the user.
- An **advantage** of the *Append* policy is that no data is lost because users share a document repository.
- A **disadvantage** of the *Append* policy is that disk space may quickly be consumed if not managed properly. This is especially true when each user has his or her own file space.
- An **advantage** of the *New Exact* policy is that it checks to see if any files already exist in the document repository. If there are no files in the repository, the newly scanned files are sent to it.
- A **disadvantage** of the *New Exact* policy is that if there are files stored in the repository, the scan job is aborted.
- An **advantage** of the *New Auto Generate* policy is that it creates a new directory structure, based on the time and date of creation, into which the TIFF images are filed.
- A disadvantage of the *New Auto Generate* policy is that while this may seem like the safest policy choice, it also requires more disk space than the *Overwrite* policy.

Optical Character Recognition (OCR)

- If you are using the OCR capabilities of Visioneer PaperPort and TextBridge, it is recommended that you use the *Text* image quality selection and the highest resolution possible. This will ensure optimum OCR capabilities.

Scan Setup without
CentreWare

Scan Templates

- Use Xerox CentreWare Internet Services to create additional scan templates, so users do not need to manually modify the default scan template for each scan job.

Sharing One Document Repository Among Multiple Document Centres

- More than one Document Centre may use a document repository. Simply configure each Document Centre in a similar manner and create additional scan templates on each Document Centre as needed.

Problem Solving

You are here because a problem has been identified with the network scanning functions of the Document Centre.

Resolve any copier problems first. Perform the corrective action that is recommended by the **Document Centre User Guide**. Do not attempt to resolve a network scanning problem if the copier functions are not operating correctly.

A. The image quality of the scanned image is not acceptable.

Be sure to select the appropriate image quality setting in the template you are using to scan the image. Use the Image Quality *Text* setting for text documents and the *Photo* setting for grayscale images.

Also, try selecting a scanner resolution of 1.2 to 2.0 times the screen frequency of the device that the file will be displayed or printed on.

B. The optical character recognition (“OCR”) application you are using with the scanned image does not recognise text accurately.

Make sure that you have selected the Image Quality *Text* setting when scanning the document(s).

C. The size of the scanned image file is too large.

Select a scanner resolution of 1.2 to 2.0 times the screen frequency of the device that the file will be displayed or printed on.

*Scan Setup without
CentreWare*

Error Messages

Problem	Corrective Action
File delete, replace failed	<ul style="list-style-type: none">• During an Overwrite operation (a Filing Policy option), an attempt to remove files from the remote directory failed. This can be caused by insufficient access rights or by file attributes that are read-only.
Filing directory already exists	<ul style="list-style-type: none">• During a scanning operation, this error can occur when the New Exact Filing Policy is used (set through Internet Services) and the (folder name).XSM directory already exists on the specified path. This is in accordance with the New Exact option.
File transfer failed	<ul style="list-style-type: none">• During a scanning operation, the network or destination server happens to go down when the file transfer is occurring.• Another possibility is that the destination disk is full.
Login failure. Check user, password, and/or setups	<p>A scanning operation failed.</p> <p>Verify the following from a workstation on the network by logging into the scan account and copying a file into the scan repository:</p> <ul style="list-style-type: none">• The user name is invalid or incorrect.• The password is invalid or incorrect. <p>Also check the following:</p> <ul style="list-style-type: none">• The server name is invalid.• The NDS Tree name (NetWare 4.x only) is invalid.• The NDS Context name (NetWare 4.x only) is invalid.

Problem	Corrective Action
Protocol not running	<p>A user tried a scanning operation with a destination on the NetWare server.</p> <ul style="list-style-type: none"> • The NetWare protocol is not currently enabled. Enable it.
Remote directory lock failed	<p>The repository that you are attempting to send a job into with a scanning operation is in use by another Document Centre.</p> <p>Check the following:</p> <ul style="list-style-type: none"> • The specified volume name is invalid. • The specified filing destination (path) is invalid. • The destination disk is full, preventing the creation of the remote directory.

Port 9100 Printing

Introduction

Your Document Centre supports printing from a variety of operating systems that support TCP/IP and now supports Port 9100 (RAW) printing.

NOTE:

Your Document Centre now has DHCP, LPR, and NetBIOS over the IP protocol enabled by default. If your DHCP server will provide host name, IP address, Gateway address, and Subnet Mask, the Document Centre TCP/IP information will be configured on initial boot.

Your Document Centre has DHCP enabled by default. If your DHCP server is configured with the TCP/IP information for the Document Centre, you should Skip Steps 5 and 6 in this procedure and go to Step 7 to enable Port 9100 printing. If you wish to configure your TCP/IP information statically, complete ALL Steps on this card.

Before You Start

To enable 100BaseT or a Token Ring interface, refer to Chapter 2 **How to Connect to Ethernet or Token Ring Networks** to configure the Speed and Source Routing settings for your environment. Then return here and perform this procedure.

For Dynamic TCP/IP Addressing, use the DHCP, BOOTP, or RARP Instructions found in this document in a section entitled **Dynamic TCP/IP Addressing** to connect it to the appropriate server then return here to complete the setup.

Record the following information assigned to your Document Centre:

IP Address _____

Subnet Mask _____

Default Gateway _____

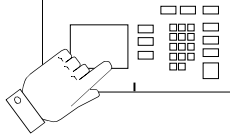

Go to the printer and...

1. Connect your Document Centre to the network with the appropriate cabling.
2. Enter the **Tools** pathway.
 - a) Press the **Access (A)** button.
 - b) On the keypad enter **1111** or the current password. Press the **Enter** button when finished. If your printer is an ST model press the **Go to Tools** button, otherwise skip to the next step.
 - c) The Touch Screen will be used for the remainder of the data entry.
3. Enter the Network Setup menus
 - a) Wait for the screen to refresh and press the **Connectivity and Network Setup** button.
 - b) Wait for the screen to refresh and press the **Network Setup** button.
 - c) Press the **TCP/IP Options** button.

4. Enable the network interface and protocol.
 - a) Press the **TCP/IP Settings** button.
 - b) Press the **Protocol and Media** button.
 - c) Press the **Enable** button. If Physical Media buttons appear, select either **Ethernet** or **Token Ring**. Press **Save**.
5. Set the Host Name.
 - a) Press the **Name/Address** button.
 - b) One at a time press the soft buttons on the Touch Screen for each octet of the IP address and enter the numbers using the keypad.
 - c) Press the **Host Name** button.
 - d) When the soft keypad appears, type the host name EXACTLY as you want it to appear with correct case. When finished press the **Save** button to record the changes and exit to the **TCP/IP Settings** Screen.

6. Set the Subnet Mask and Gateway.
 - a) Press the **Subnet and Gateway** button.
 - b) Press the soft buttons on the Touch Screen one at a time for each octet of the Subnet Mask and enter the numbers using the keypad. Repeat this process for the IP Gateway address. When finished press **Save** to record the changes and exit to the **TCP/IP Settings** screen.

NOTE:

The Broadcast Address will be calculated automatically.

7. Enable **Port 9100** printing .
 - a) Press the **Port 9100 printing** button.
 - b) At the next screen press **Enable** then press **Save**.
8. Enable HTTP/IPP protocol.
 - a) Press the **HTTP/IPP** button.
 - b) At the next screen press **Enable**.
 - c) Press **Save**.
9. Exit the Tools Menu
 - a) Press the **Exit Tools** button.

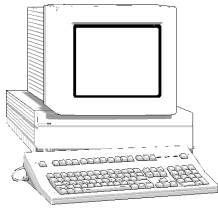

Go to a workstation and...

1. Create a test job and send it to the printer with a workstation utility, or through a queue on your operating system that supports Port 9100 printing.
2. Check your test job for quality and use the problem solving section of the **Document Centre 460/470 Reference Guide** for resolving print defects.
3. If your print job does not print, refer to the troubleshooting section in this document entitled **TCP/IP Troubleshooting** to correct the problem.
4. Repeat this **Go to a workstation and...** procedure at each workstation that will print to this printer, or at other servers where the queue was created.

Glossary

10BASE-T	An implementation of the Ethernet IEEE standard on 24 gauge unshielded twisted-pair wiring, a baseband medium, at 10 megabits per second.
802.3	Defined by the IEEE, these standards govern the use of the CSMA/CD (Carrier Sense Multiple Access/Collision Detection) network access method used by Ethernet networks.
802.5	Defined by the IEEE, these standards govern the use of the Token Ring network access method.
ALAP (AppleTalk Link Access Protocol)	In an AppleTalk network, this link access- (or data link-layer) protocol governs packet transmission on LocalTalk.
ANSI (American National Standards Institute)	This is the principal group in the U.S. for determining standards. ANSI represents the U.S. in the ISO.
AppleShare	A network system implementing the AppleTalk protocol.

AppleTalk	Protocol suite defined by Apple Computer for connecting computers and peripherals using shielded twisted-pair wiring and transfer rates of about 230.4 kilobytes per second. The network- and transport-level protocols include Datagram Delivery Protocol (DDP), AppleTalk Transaction Protocol (ATP), AppleTalk Session Protocol (ASP), and the Name Binding Protocol (NBP).
ARP (Address Resolution Protocol)	TCP/IP protocol for determining a DLC (Data-Link Control) address from an IP (Internet Protocol) address.
ASCII (American Standard Code for Information Interchange)	A seven-bit binary code standardized by ANSI for use by personal computers and some mainframes to represent alphanumeric and graphical characters. An additional bit is included to form an eight-bit character byte.
AUI (Attachment Unit Interface)	Connector used with thick Ethernet that often includes a drop cable.
Bindery	NetWare database of user names, passwords, groups, and accounting information.
BNC	A standardized connector used with Thinnet and coaxial cable.
Bus Topology	A network topology in which nodes are connected to a single cable with terminators at each end.
Client	A network node that requests network services from a server.
Coaxial cable	Data transmission medium with a single-wire conductor insulated EMI/RFI (Electromagnetic Interference/Radio Frequency Interference).
CPU (Central Processing Unit)	A personal computer's primary microprocessor chip.
CSMA/CA (Carrier Sense Multiple Access With Collision Avoidance)	Network access method using contention similar to CSMA/CD used by LocalTalk networks. Unlike CSMA/CD, in this method the sending node requests permission to send from the intended receiving node. If the receiving node responds with a clear to send signal, transmission begins.

CSMA/CD (Carrier Sense Multiple Access/Collision Detection)	Network access method in which nodes contend for the right to send data. If two or more nodes attempt to transmit at the same time, they abort their transmission until a random time period of microseconds has transpired and then attempt to re-send.
DB-9	A standardized connector with 9 pins for Token Ring and serial connections.
DNS (Domain Name Service)	A TCP/IP protocol for discovering and maintaining network resource information distributed among different servers.
DOS (Disk Operating System)	The operating system developed by Microsoft and often ported by computer manufacturers such as IBM to run specifically on their computers.
EMI/RFI (Electromagnetic Interface/Radio Frequency)	A form of “noise” on data transmission mediums that can reduce data integrity and increase transmission errors.
Ethernet	A 10 megabits per second baseband, CSMA/CD network originally designed by Xerox Corporation.
EtherTalk	AppleTalk protocol governing Ethernet transmissions. Also the Apple Computer Ethernet adapter and drivers. The first implementation, Phase 1, was replaced by Phase 2 in 1989.
FTP (File Transfer Protocol)	A TCP/IP application protocol governing file transfer.
GUI (Graphical User Interface)	Icon oriented style of screen display designed by Xerox and the PARC project.
Half Duplex	Method of communication where each character sent is echoed back to its origin.
IEEE (Institute of Electrical and Electronics Engineers)	A professional organization within the ISO that assists with the creation of networking standards.
Internet	Connected networks including those of the National Science Foundation the Advanced Projects Research Agency.

Internetwork	A collection of two or more connected networks that may be dissimilar.
IP (Internet Protocol)	TCP/IP protocol governing packet forwarding.
IPX (Internetwork Packet exchange)	Novell NetWare protocol similar to IP (Internet Protocol).
ISO (International Standards Organization)	A committee of industry leaders who develop telecommunication and application standards.
LAN (Local Area Network)	A system of software and hardware connected by a common data transmission medium and limited to a geographical area less than about 10 kilometers.
LLC (Logical link control)	A layer 2 protocol governing transmission, also known the IEEE 802.2 standard.
LocalTalk	A 230 kilobits per second baseband network using the CSMA/CA access method.
MAC (Medium Access Control)	A layer 2 protocol governing access to transmission media.
MAU (Multi-station Access Unit)	A concentrator or transceiver for attracting nodes to a transmission medium.
MIB (Management Information Base)	A database of network management information used by CMIP (Common Management Information Protocol) and SNMP (Simple Network Management Protocol).
NetWare	Novell's network operating system using IPX (Internetwork Packet Exchange) and SPX (Sequential Packet Exchange) protocols.
NFS (Network File System)	The network operating system based on TCP/IP protocols.
OS/2	A multithreaded, multitasking, single-user operating system.

Packet	A collection of bits comprising data and control information formatted for transmission from one node to another.
Peer to Peer network	A system in which two or more nodes or processes can initiate communications with each other. Usually describes a network in which all nodes have the ability to share resources with other nodes so that a dedicated server can be implemented but is not required.
protocol stack	A representation of the hierarchical nature of a protocol suite.
protocol suite	A hierarchical set of related protocols.
RAM (Random Access Memory)	Memory in which data is temporarily stored for processing.
RARP (Reverse Address Resolution Protocol)	A TCP/IP protocol governing the translation of a DLC (Data-Link Control) address to an IP (Internet Protocol) address.
Repeater	A device that regenerates and often amplifies signals to extend transmission distance. It is independent of protocol and media.
RG-58	Coaxial cable with 50-ohm impedance used by Thinnet.
RJ-45	Eight-wire modular connectors for Ethernet, Token Ring, StarLAN networks, and some phone lines.
SNMP (Simple Network Management Protocol)	TCP/IP protocol governing network monitoring.
SPX (Sequential Packet Exchange)	The implementation of SPP (Sequential Packet Protocol) by Novell.
TCP (Transmission Control Protocol)	TCP/IP protocol governing sequenced data.
TCP/IP (Transmission Control Protocol/Internet Protocol)	A protocol suite developed by ARPA (Advanced Research Projects Agency).

Telnet	TCP/IP protocol governing character-oriented terminal data.
Thicknet	Cabling scheme using twin axial cable.
Thinnet	Cabling scheme using 50 ohm coaxial cable.
Token	The character sequence passed among nodes in sequence to indicate which one has permission to transmit.
Token passing	Network access method that requires nodes to wait for their turn before transmitting data. Turns are indicated by a character sequence that passes from one node to the next.
Token Ring	A 4 megabit per second or 16 megabit per second network using a ring topology and a token passing access method.
Transceiver	An AUI (Attachment Unit Interface) device for receiving and transmitting data that often provides collision detection as well.
twisted pair cable	A wiring scheme with one or more pairs of 18 to 24 gauge copper strands are twisted to improve protection against electromagnetic and radio frequency interference. Cable may be either shielded or unshielded.
type 1 cable	Shielded two-pair cable.
type 3 cable	Unshielded twisted-pair cable.
type 5 cable	Shielded twisted-pair cable.
WAN (Wide Area Network)	A network capable of transmissions over large geographic areas that uses transmission lines provided by a common-carrier.
workstation	A networked computer typically reserved for end-user applications.
Zone	One or more connected AppleTalk networks grouped according to network usage.

Free Manuals Download Website

<http://myh66.com>

<http://usermanuals.us>

<http://www.somanuals.com>

<http://www.4manuals.cc>

<http://www.manual-lib.com>

<http://www.404manual.com>

<http://www.luxmanual.com>

<http://aubethermostatmanual.com>

Golf course search by state

<http://golfingnear.com>

Email search by domain

<http://emailbydomain.com>

Auto manuals search

<http://auto.somanuals.com>

TV manuals search

<http://tv.somanuals.com>