Xerox DocuPrint 180 Laser Printing System Operator Guide

**THE DOCUMENT COMPANY
XEROX**

April 1998
721P85490

Xerox Corporation
701 S. Aviation Boulevard
El Segundo, CA 90245

©1998 by Xerox Corporation. All rights reserved.

Copyright protection claimed includes all forms and matters of copyrightable material and information now allowed by statutory or judicial law or hereinafter granted, including without limitation, material generated from the software programs which are displayed on the screen, such as icons, screen displays, looks, etc.

Printed in the United States of America.

Publication number: 721P85490

Xerox® and all Xerox products mentioned in this publication are trademarks of Xerox Corporation. Products and trademarks of other companies are also acknowledged.

Changes are periodically made to this document. Changes, technical inaccuracies, and typographic errors will be corrected in subsequent editions.

This document was created on a PC using Frame software. The typeface used is Helvetica.

Related publications

The *Xerox DocuPrint 180 Laser Printing System Operator Guide* is part of the ten manual reference set for your laser printing system. The entire reference set is listed in the table below. Several other related documents are also listed for your convenience. For a complete list and description of available Xerox documentation, refer to the Xerox Documentation Catalog (Publication number 610P17417) or call the Xerox Documentation and Software Services (XDSS) at 1-800-327-9753.

Table 1. **Related Publications**

Publication	Number
<i>Xerox DocuPrint 180 Laser Printing System Operator Guide</i>	721P85490
<i>Xerox DocuPrint 180 Laser Printing System Operations Reference</i>	721P85500
<i>Xerox DocuPrint 180 Laser Printing System Message Guide</i>	721P85550
<i>Xerox DocuPrint 180 Laser Printing System PDL Reference</i>	721P85530
<i>Xerox DocuPrint 180 Laser Printing System Forms Creation Guide</i>	721P85520
<i>Xerox DocuPrint 180 Laser Printing System System Generation Guide</i>	721P85510
<i>Xerox DocuPrint 180 Laser Printing System Installation Planning Guide</i>	721P85480
<i>Xerox DocuPrint 180 Laser Printing System Operator Command Summary Card</i>	721P85560
<i>Xerox DocuPrint 180 Laser Printing System PC User Interface Reference</i>	721P85540
<i>Xerox DocuPrint 180 Laser Printing System Product Guide</i>	721P85570
<i>Xerox Laser Printing Systems Tape Formats Manual</i>	600P86175
<i>Xerox Laser Printing Systems Standard Font Library Font User Guide</i>	600P86174
<i>Helpful Facts About Paper</i>	721P82492

Notice

This publication may contain descriptions of concepts and features not currently available for your Xerox Laser Printing System. Consult your Xerox sales representative or your operating system software program description for additional information.



Table of Contents

Related publications	iii
Notice	iii
Introduction	xiii
About the reference set	xiii
Xerox DocuPrint 180 Laser Printing System document set	xiii
Document conventions	xvi
1. System overview of the Xerox DocuPrint 180 LPS	1-1
Base components	1-2
System controller components	1-3
System user interface	1-4
Operator control panel	1-4
1/4 inch cartridge tape drive	1-5
Printer components	1-5
Feeder trays	1-6
High-capacity stacker bins	1-8
Inverter	1-9
Sample tray	1-9
Purge tray	1-9
Printer control console	1-10
Attention light	1-12
Registration transport levers	1-12
Optional components	1-13
Optional system controller components	1-13
Peripheral cabinet	1-13
Open-reel tape drive	1-13
18/36 track cartridge tape drive	1-15
Floppy disk drive	1-16
Optional printer components	1-16
Feeder/stacker	1-16
Bypass Transport Module	1-17
Input enablement device	1-17
7 X 10 enablement kit	1-17
Printer configurations	1-18

2. Using the PC UI	2-1
PC UI	2-1
Powering on the PC UI	2-2
Adjusting the PC UI monitor	2-3
Components of the PC UI	2-4
PC UI keyboard	2-4
Special function keys	2-5
Cursor	2-6
Types of cursors	2-6
Moving the cursor	2-6
PC UI mouse	2-7
Selecting options with the mouse	2-7
PC UI desktop	2-8
Desktop icons	2-9
Windows	2-12
Additional types of windows	2-17
Working with windows	2-18
Moving and resizing the window	2-18
Using the scroll bars	2-20
Activating an open window	2-21
Performing operator tasks through the PC UI	2-21
Performing tasks through windows	2-21
Entering commands through the Messages window	2-22
Key-in conventions	2-22
Guide command conventions	2-23
Terminal emulation mode (TEM)	2-23
3. Paper facts	3-1
Important facts about paper	3-1
Paper storage	3-1
Paper specifications	3-2
Paper sizes	3-2
Paper weights	3-2
Types of paper	3-3
Paper performance guides	3-4
Paper sizing and print jobs	3-9
Feeder trays	3-10
Feeder tray features	3-10
Loading a feeder tray	3-11
Stacker bins	3-19
Unloading a stacker bin	3-20

Sample tray and purge tray	3-24
Sample tray	3-24
Purge tray	3-24
4. System control tasks	4-1
System control tasks through windows of PC UI	4-2
System control tasks through command line	4-2
System control tasks	4-3
Power on the LPS	4-3
Power off the LPS	4-4
Boot the LPS	4-6
System rollover	4-8
System version	4-11
Attention Light/Alarm	4-12
Turn off Attention light or alarm	4-14
Energy saver	4-14
Set date/time	4-16
Console log	4-18
Displaying a console log	4-20
Printing a console log	4-22
Stopping the printing of a console log	4-23
Saving the current console log	4-23
Emptying the current console log	4-24
Deleting a saved console log	4-24
Requesting log debug information	4-24
Converting a console log	4-25
Problem	4-26
Audit log	4-28
Selecting a header option	4-28
Selecting a device	4-29
Selecting an Audit option	4-29
Sorting reports and jobs	4-29
Listing logs	4-29
Remote Terminal	4-30
Exit to DOS	4-30
5. Job control tasks	5-1
Job control tasks through windows of PC UI	5-2
Job control tasks through command line	5-3

Job control tasks	5-4
Abort	5-4
Reset	5-6
Align	5-7
Print Darkness	5-10
Lead edge screen	5-11
Fonts/forms/graphics	5-13
Sample files	5-15
Stop input/output	5-19
Continue input/output	5-20
Sample	5-21
6. Online printing tasks	6-1
Online printing tasks through windows of PC UI	6-2
Online printing tasks through command line	6-3
Place the LPS online to the host computer	6-3
Online printing tasks	6-3
Start an online print job	6-4
Space	6-6
Endjob	6-7
Drain	6-7
Disk saturation	6-8
7. Offline printing tasks	7-1
Open-reel tape drive procedures	7-2
Power on the open-reel tape drive	7-2
Load an open-reel tape	7-4
Load an open-reel tape by hand	7-5
Unload an open-reel tape	7-9
Unload an open-reel tape during a power failure	7-10
Power off the open-reel tape drive	7-14
Handle open-reel tapes	7-15
1/2 inch cartridge tape drive procedures	7-16
Power on the 18/36 track 1/2 inch cartridge tape drive	7-16
Load a 1/2 inch cartridge	7-18
Unload a 1/2 inch cartridge	7-20
Power off the 18/36 track 1/2 inch tape drive	7-21
Handle cartridge tapes	7-22
File protection	7-23

1/4 inch cartridge tape drive procedures	7-24
Load a 1/4 inch cartridge tape	7-25
Unload a 1/4 inch cartridge tape	7-25
Handle 1/4 inch cartridge tapes	7-26
File protection	7-26
Load a floppy disk	7-26
Unload a floppy disk	7-26
Handle floppy disks	7-26
Offline printing tasks through windows of PC UI	7-27
Offline printing tasks through command line	7-28
Offline printing tasks	7-28
Start an offline print job	7-28
Rewind/unload tape	7-31
Space	7-32
Move	7-34

8. HIP printing tasks 8-1

HIP printing tasks through windows of PC UI	8-2
HIP printing tasks through command line	8-3
HIP printing tasks	8-3
Enter HIP communication mode	8-4
Select a communication mode	8-5
Place HIP online	8-5
Take HIP offline	8-6
Start a HIP print job	8-6
Stop HIP print jobs	8-8
Abort a HIP print job	8-9
HIP jobs status	8-10
End HIP	8-15

9. Status and print tasks 9-1

Status and print tasks through windows of PC UI	9-2
Status and print tasks through command line	9-2
Understanding clusters	9-3
Status and print tasks	9-4
Printer status	9-4
Select feeder trays	9-8
Select stacker bins	9-10
Tray loading	9-12
Clusters	9-14
Ordered stock	9-18
Transparencies	9-19

Select units	9-21
Purge feed	9-22
Lower trays and bins	9-23
Set tray size	9-24
Set container size	9-26
Bin full criteria and setting bin limits	9-28
Separate	9-31
Job status	9-32
Configure feeding or finishing device	9-34
Configure task through windows	9-34
Configuring task through command line	9-36
Notepad	9-38
10. File control tasks	10-1
File control tasks through windows of PC UI	10-2
File control tasks through command line	10-2
File control tasks	10-3
Display/Print	10-3
Type	10-4
Copy	10-4
Copy labeled tapes	10-5
Copy unlabeled tapes	10-10
Copy to/from floppy	10-12
Delete	10-15
Review	10-15
Rename	10-16
Fix	10-16
Scale	10-17
11. Maintenance tasks	11-1
Precautions you should take	11-1
Cleaning supplies	11-1
Maintaining the printer	11-2
Replacing the dry ink cartridge	11-2
Replacing the dry ink waste container	11-5
Adding fuser agent	11-7
Cleaning the sensors and the reflecting surfaces	11-10
Cleaning the Q850 sensor	11-11
Cleaning the Q1011 sensor and mirror	11-13
Cleaning additional sensors	11-14
Cleaning the terminal and the exterior surfaces of the system	11-16

Cleaning the open-reel tape drive	11-16
Tape drive cleaning schedule	11-16
Cleaning precautions—READ BEFORE CLEANING	11-18
Cleaning procedures	11-18
Access to the tape path	11-18
Cleaning the tape path	11-19
Cleaning the exterior of the tape drive	11-19
Cleaning the 18/36 track cartridge tape drive	11-20
When to clean the tape drive	11-20
Cleaning procedures	11-20
Cleaning the tape path	11-20
Cleaning a cartridge	11-20
Cleaning the quarter inch cartridge (QIC) tape drive	11-21
Using the custom transfer assist blade	11-22
When not to use the custom transfer assist blade	11-22
Installing the custom transfer assist blade	11-22
Setting tray size with the custom transfer assist blades	11-23

12. Problem solving tasks

12. Problem solving tasks	12-1
LPS problems	12-1
Fault masking and the printer control console	12-1
Printing problems	12-3
Prints are skewed or damaged	12-3
Paper jams	12-5
Paper curl and paper jams	12-6
Aids to paper jam clearance	12-8
Clearing area paper jams	12-8
Checking job integrity following a paper jam	12-9
Printer areas	12-10
Clearing a misfeed (feeder tray fault)	12-20
Frequent misfeeds (processor feeder trays)	12-22
Faults are cleared but the Attention light is still on	12-24
Printing does not continue when the Continue button is pressed	12-24
Incorrect paper size message	12-24
Stacker bin problems	12-25
Papers are being thrown around the stacker	12-25
Paper stack is falling over or sliding around the bin	12-25
System controller problems	12-26
LPS does not boot (system controller terminal)	12-26
Printer does not respond to system controller	12-26

	Blank display (system controller terminal)	12-27
	Rasterization messages	12-27
	Power failure	12-28
	Status file nearly full message	12-28
	Open-reel tape drive problems	12-29
	Tape drive does not perform self-load routine	12-29
	“OK” appears on the tape drive message display, but the loading door is closed	12-30
	“LID OPEN” appears on the tape drive message display	12-30
	1/2 inch cartridge tape drive problems	12-31
	Basic recovery procedure	12-31
	Initial program load (IPL) procedure fails	12-31
	You cannot insert a cartridge	12-32
	Tape does not unload	12-33
	Unloading a cartridge after a power failure	12-33
	Tape winds completely out of cartridge	12-33
	Message display is blank	12-34
	Tape drive does not become ready	12-35
	Calling for service	12-36

A. Meter reading and reporting A-1

	Meter reading and billing report	A-1
	Billing report through command line	A-1
	Billing report through windows of the PC UI	A-2
	Reporting meter reads	A-4
	Touchtone Telephone Direct Meter Read Entry System	A-4
	Understanding the system	A-6
	Entering meter read information	A-8
	Reviewing and changing data	A-10

B. Supplies B-1

	How to order supplies (in U.S.A.)	B-1
	Consumable supplies table	B-2

Glossary GLOSSARY-1

The *Xerox DocuPrint 180 Laser Printing System Operator Guide* is one of ten manuals that make up the Xerox DocuPrint 180 Reference Set. The guide is divided into twelve chapters, an appendix, and a glossary.

About the reference set

This document is part of a reference set designed to help you receive maximum benefit from your Xerox DocuPrint 180 Laser Printing System (LPS)

To help you select the appropriate document for your needs, the following section identifies the documents in the set and describes the information contained in each.

Xerox DocuPrint 180 Laser Printing System document set

The Xerox DocuPrint 180 LPS document set includes the following:

Xerox DocuPrint 180 LPS Operator Guide

This reference contains the following information:

- System overview
- Paper facts and procedures
- Operating procedures
- Maintenance
- Problem solving
- Supplies
- Meter reading and reporting

Xerox DocuPrint 180 LPS PDL Reference

This reference contains the following information:



- Print Description Language components and processes
- Input processing functions
- Output processing functions
- PDL command summary
- Page formatting guidelines
- Character code assignment tables
- PDL programming information with step-by-step instructions

- Xerox DocuPrint 180 LPS System Generation Guide** This reference contains the following information:
- Configuration options
 - Commands
 - OSS software installation, upgrade, and modification
- Xerox DocuPrint 180 LPS Operations Reference** This reference contains the following information:
- Command syntax for operator and system administrator procedures
 - LPS defaults
 - LPS resources
 - Command summaries
 - Communication and graphics on the LPS
 - Command files
- Xerox DocuPrint 180 LPS Forms Creation Guide** This reference contains the following information:
- Basic concepts for creating forms
 - Coding and compiling for LPS Forms Description Language
 - Sample form setup command sets
 - Tips for successful forms creation
- Xerox DocuPrint 180 LPS Operator Command Summary Card** This reference provides a quick reference of commonly-used commands.
- Xerox DocuPrint 180 LPS Message Guide** This reference contains the following information:
- OSS and other messages
 - Meaning and recovery procedures
- Xerox DocuPrint 180 LPS Installation Planning Guide** This reference contains the following information:
- LPS basic components and options
 - Tasks that must be accomplished before installation
 - Preinstallation requirements
 - Installation process
 - Postinstallation activities
- DocuPrint 180 LPS PC UI Reference** This reference contains the following information:
- PC UI procedures
 - Hierarchy of PC UI windows

-
- DocuPrint 180 LPS Product Reference** This reference contains the following information:
- Product overview
 - Hardware and software
 - LPS connections
 - User considerations
 - LPS comparisons
- Tape Formats Manual** This reference contains the following information:
- Characteristics of different formats
 - File organization
 - Data formats
 - Carriage control conventions
- Xerox DocuPrint 180 LPS Standard Font Library Font User Guide** This reference contains the following information:
- Font naming conventions
 - Listing of standard fonts
 - Data Sheets
 - Glossary to typography terminology
- Helpful Facts About Paper** This reference contains the following information:
- Selection and guidelines
 - Storage
 - Specifications for different printers

Document conventions

This guide uses the following conventions:

- < > Angle brackets are used for keys on the system controller keyboard.
- { } Curly brackets are used for required characters.
- ... Ellipses indicate that you may repeat a parameter or list a series of parameters.
- [] Square brackets are used for optional command characters.
- | Vertical bars are used to separate parameters in a series. The vertical bar stands for “or.”
- Bold** Bold is used for characters you enter at the command line.
- Italics* Italics are used for variable information.
- Monospace font The monospace font is used to display system responses.
- Underline System default parameters are underlined.
- UPPERCASE Uppercase letters are used for command names. You may key in entire words for each command, or the first three characters of each word. In this manual the entire word of each command is spelled out.
-  **Note:** A note indicates an operation, practice or condition that should be taken into consideration to efficiently accomplish a task.
-  **Caution:** Cautions alert you to an action that could damage hardware or software.
-  **Warning:** Warnings alert you to conditions that may affect the safety of people.

1. System overview of the Xerox DocuPrint 180 LPS

This chapter explains in detail the base components and the optional components of the Xerox DocuPrint 180 Laser Printing System (LPS).

The Xerox DocuPrint 180 LPS is a versatile, high-performance printing system that processes and prints data from a variety of sources. It enables host mainframe computers and network-connected devices (such as workstations and graphic scanners) to produce publications and other documents, incorporating graphics, forms, logos, signatures, and a variety of fonts. With the Xerox DocuPrint 180, management information systems (MIS) and data processing (DP) environments have a high-performance printer in which built-in intelligence eliminates the need for the host computer to store and manage forms, fonts, and other document resources.

Data is printed at a rate of up to 180 pages per minute, or up to 206 pages per minute with the optional 7 by 10 input enablement kit. A variety of fonts ranging in size from 3 points to 36 points, in all four orientations (portrait, inverse portrait, landscape, inverse landscape), and many publishing typefaces are available to meet your printing requirements. In addition to the standard set of fonts that is delivered with the LPS, special or customized fonts can be developed by the Xerox Font Center or by Xerox Limited.

Base components

The base components of the Xerox DocuPrint 180 LPS are the system controller and the printer, shown in figure 1-1.

Figure 1-1. **Base components**

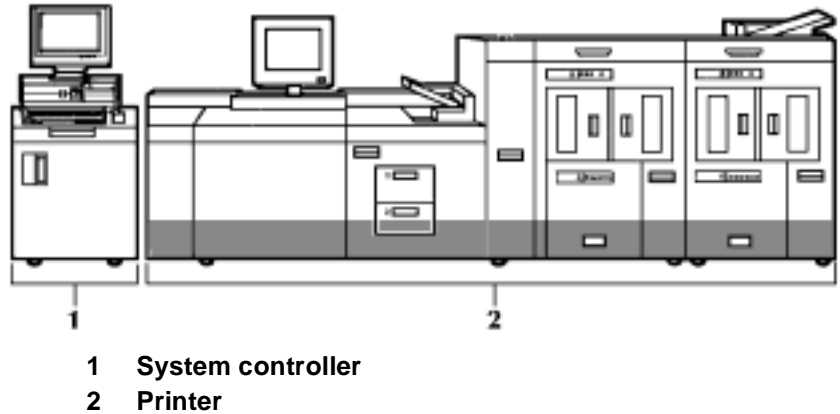

Note: Figure 1-1 shows one of the Xerox DocuPrint 180 configuration options. For information on the various Xerox DocuPrint 180 configurations, refer to the “Optional components” section later in this chapter.

System controller components

The system controller, shown in figure 1-2, is the part of the LPS that allows you to interact with the printer. Use the personal computer user interface (PC UI) to enter commands and select options which control the operation of the printer.

Figure 1-2. **Xerox DocuPrint 180 system controller**

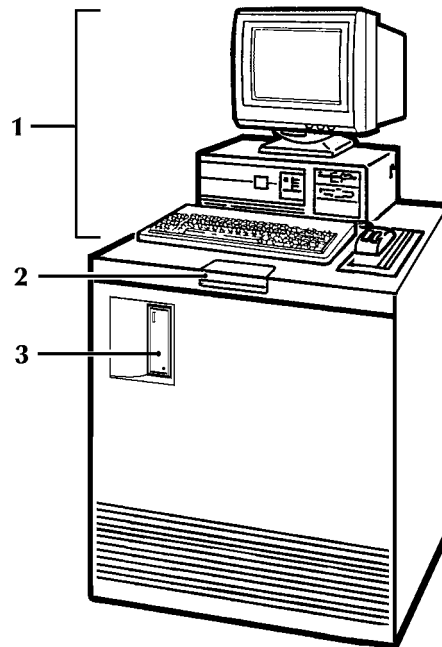

- 1 System user interface
- 2 Operator control panel
- 3 1/4 inch cartridge tape drive.

System user interface

The system user interface consists of a PC containing a screen, a keyboard, a mouse, a mouse pad, and an optional mouse tray. Figure 1-3 shows the PC User Interface (UI).

Figure 1-3. PC UI

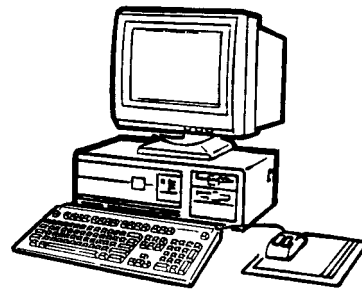

PC UI



Note: Several PC UI types are available. Your PC UI may look different from the one illustrated in figure 1-3.

For detailed information on the system user interface, refer to the "Using the PC UI" chapter.

Operator control panel

The operator control panel allows you to power the printer on and off, boot the operating system software, and switch the LPS between remote and local operation. Figure 1-4 shows the operator control panel.

Figure 1-4. Operator control panel

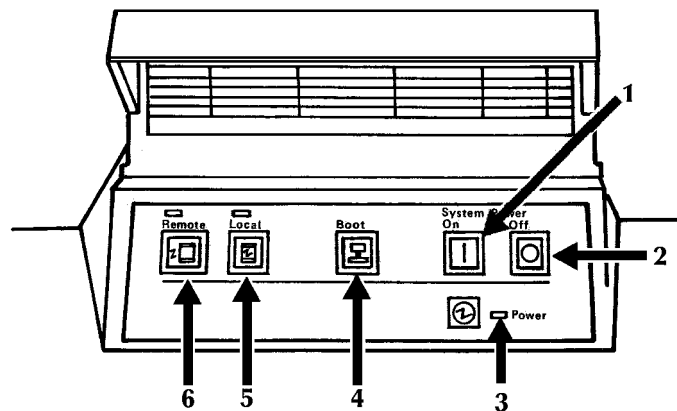

- 1 Power On switch
- 2 Power Off switch
- 3 Power On indicator
- 4 Boot switch
- 5 Local switch and indicator
- 6 Remote switch and indicator

1/4 inch cartridge tape drive

The 1/4 inch cartridge tape drive, also referred to as QIC (quarter inch cartridge), is used for performing sysgen, disk save and restore (DSR), and file loading/backup for online system configuration. (Refer to the "1/4 inch cartridge tape drive procedures" section of the "Offline printing tasks" chapter for instructions on loading and unloading cartridge tapes.)

Printer components

The printer is the part of the LPS that processes the electronic images and produces the printed report. Figure 1-5 shows the printer and its various components.

Figure 1-5. Xerox DocuPrint 180 printer

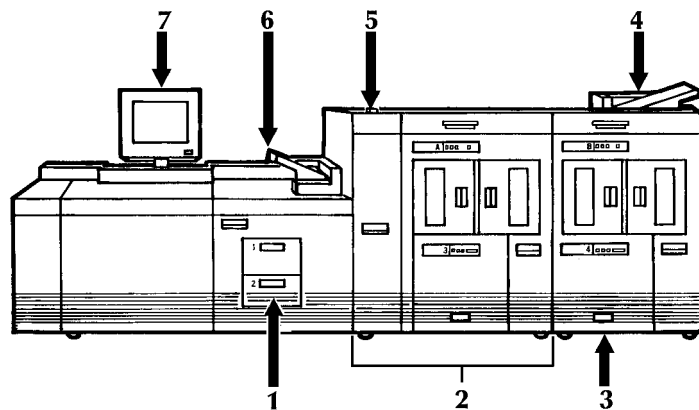

- 1 Processor feeder trays
- 2 Inverter feeder/stacker module (containing inverter, high-capacity feeder, and high-capacity stacker)
- 3 Feeder/stacker module (containing additional high-capacity feeders and high-capacity stackers)
- 4 Purge tray
- 5 Attention light
- 6 Sample tray
- 7 Printer control console

Feeder trays

The feeder trays hold and convey paper and other materials (for example, transparencies) used to produce printed output.

Figure 1-6. **Xerox DocuPrint 180 feeder trays and inverter feeder/stacker modules**

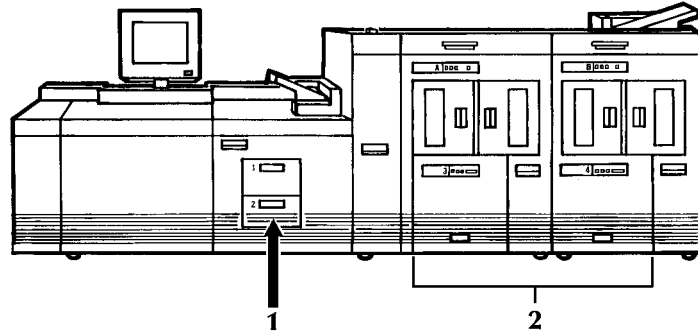

- 1 Processor feeder trays**
- 2 Inverter feeder/stacker modules**

Two processor feeder trays are located in the main part of the printer.

- The main tray (tray 1) holds 1100 sheets of 20 pound/75 gsm paper.
- The auxiliary tray (tray 2) holds 600 sheets of 20 pound/75 gsm paper.
- If configured, trays 1 and 2 can handle paper sized from 7 by 10 inches/178 by 254 mm to 9.05 by 14.02 inches/230 by 356 mm.

There is one high-capacity feeder (HCF) tray in each of the feeder/stacker modules (trays 3, 4, 5 and 6). The HCF trays are the primary paper supply for the printer. If configured, each tray can handle paper sized from 7 by 10 inches/178 by 254 mm to 14.33 by 17 inches/364 by 432 mm.



Note: In order to print on paper sized 7 by 10 inches/178 by 254 mm, you must have the 7 X 10 enablement kit. Refer to the section “Optional printer components” later in this chapter for more information.

The input and output page numbers vary for each HCF tray as shown in table 1-1.

Table 1-1. **Input and output page numbers for each HCF tray**

Configuration	Input (pages)	Output (pages)
First F/S	4000	2500
Second F/S	6500	5000
Third F/S	9000	7500
Fourth F/S	11,500	10,000

An elevator moves the tray up or down when it is in use. The HCF trays have Paper Level switches which detect the position of the elevator to determine the fullness of the tray. Paper Size switches detect the size of the paper loaded in the trays.

Each processor feeder tray and HCF tray has a control panel consisting of a button, indicators, and paper level displays, as shown in figure 1-7.

Figure 1-7. Feeder tray control panel

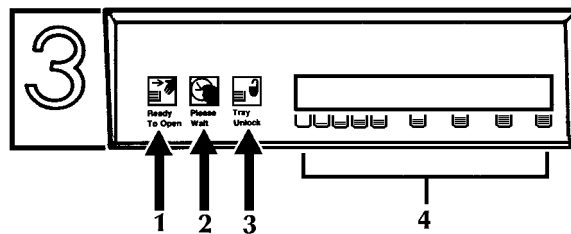

- 1 Ready to Open indicator
- 2 Please Wait indicator
- 3 Tray Unlock button
- 4 Paper Level indicators

Ready to Open indicator. This indicator is lit when paper can be added to the tray.

Please Wait indicator. This indicator shows that the tray is in motion. It is lit when the Tray Unlock button is pressed, when the tray is being lowered, or when the tray is being raised. The indicator goes off when the tray elevator reaches its destination.

Tray Unlock button. This button can be used any time the Please Wait indicator is off.

- If the tray is in use when this button is pressed, the feed selection changes to the backup tray if one exists. Otherwise, printing stops.
- If the tray is in use and selected as a backup tray, pressing this button causes the tray elevator to lower and the tray is no longer available for auto switching.
- If the tray elevator is in the raised position and the tray is not in use or selected as a backup tray, pressing this button causes the elevator to lower with no effect on printing operations.

Paper Level indicators. These indicators display the approximate quantity of paper within the tray. The display shows paper by quarter reams up to one ream, and then by full reams. The green indicator light appears above the Paper Level indicator which shows the amount of paper in the tray.

High-capacity stacker bins

The Xerox DocuPrint 180 LPS contains up to four high-capacity stacker (HCS) bins as part of the feeder/stacker modules (stacker bins A, B, C and D). Figure 1-8 shows two HCS bins. Refer to the section “Optional printer components” for more information on the optional feeder/stacker modules.

Figure 1-8. HCS bins

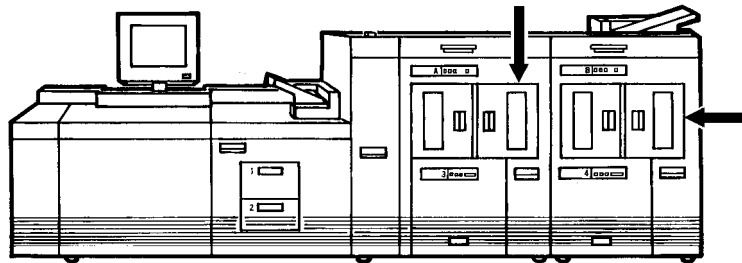

Each HCS can hold 2500 sheets of 20 pound/75 gsm paper. The paper can be stacked onto the bin platform, a container on top of the bin platform, or a pallet without its container (for container sizes 11 by 17 inches or A3 only). The stacking capacity is approximately 100-150 sheets less when stacking into a container.

It is also possible to select the level to which paper will be stacked in the HCS. Refer to the “Status and print tasks” chapter for additional information.

A stacking elevator maintains the paper at the proper level for stacking and lowers the stack for unloading. There is an offset mechanism that offsets printed sets toward the front or back of the HCS bin. Each HCS bin has unlinked double doors to provide you with easy, yet safe, access for unloading paper from the printer.

Each HCS bin has a control panel consisting of buttons and indicators, as shown in figure 1-9.

Figure 1-9. HCS bin control panel

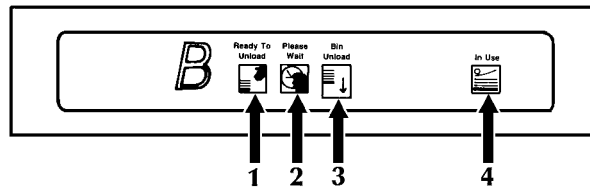

- 1 Ready to Unload indicator
- 2 Please Wait indicator
- 3 Bin Unload button
- 4 In Use indicator

Ready to Unload indicator. When this indicator is lit, you can remove printed sheets from the stacker bin.

Please Wait indicator. When this indicator is lit, the elevator is in motion. This indicator goes off when the platform reaches its destination.

Bin Unload button. Pressing this button causes the bin elevator to lower. If the bin is in use and part of a SELECT AUTO combination, the printed pages begin stacking in the other stacker bin. If the bin is not in use, there is no effect on printing operations.

In Use indicator. When this indicator is lit, the bin is selected to receive the next printed sheet.

Inverter

The inverter is part of the inverter feeder/stacker module. (Refer to figure 1-5.) It allows for proper collation of the print job. It also directs printed output to the sample tray, when required.

Sample tray

The sample tray is located on top of the printer. (Refer to figure 1-5.) It can hold up to 100 sheets of paper. Certain types of output (for example, transparencies) and requested sample prints of system files (for example, fonts or forms) or the print job in progress are sent to the sample tray. The sample tray also receives waste sheets that cannot be sent to the purge tray.

Purge tray

The purge tray is located on top of the last feeder/stacker module. (Refer to figure 1-5.) Aborted sheets (for example, sheets cleared after a paper jam) are sent to this tray. It can hold up to 100 sheets of paper.

Printer control console

The printer control console, shown in figure 1-10, is a color monitor located on top of the printer. It contains message areas and graphic displays that alert you to paper jams and other fault and status conditions (such as low dry ink). It also contains buttons which allow you to control certain functions of the printer (for example, continuing an interrupted job) without returning to the PC UI. The printer control console has the following features:

- Local controls and displays for jam clearance, paper loading/unloading, and diagnostics/service (used by the service representative). Two types of messages are displayed on the printer control console: fault messages, which relate to printer malfunctions, and information messages, which relate to printer conditions such as low dry ink.
- Touch-sensitive areas that allow you to select options by touching the printer control console screen. A tone sounds when you touch one of these areas.
- Printer alarm consisting of sets of three beeps, for a duration of ten seconds. This tone is generated by any event that stops printer operation (for example, a paper jam).

You can deactivate the alarm through the PC UI (refer to the “System control tasks” chapter for instructions). The tone stops after three cycles, or when the fault condition is cleared or clearing has started (for example, doors or covers specified in the clearance instructions are opened). You can also stop the tone by pressing one of the printer control console buttons or by selecting a function through the touch screen.

- To prevent monitor burnout on the PC UI, a screen saver feature automatically blanks the screen.

To return to the normal desktop once the PC UI is in screen saver mode, simply move the mouse, click a mouse button, or press any key.

Figure 1-10. Printer control console

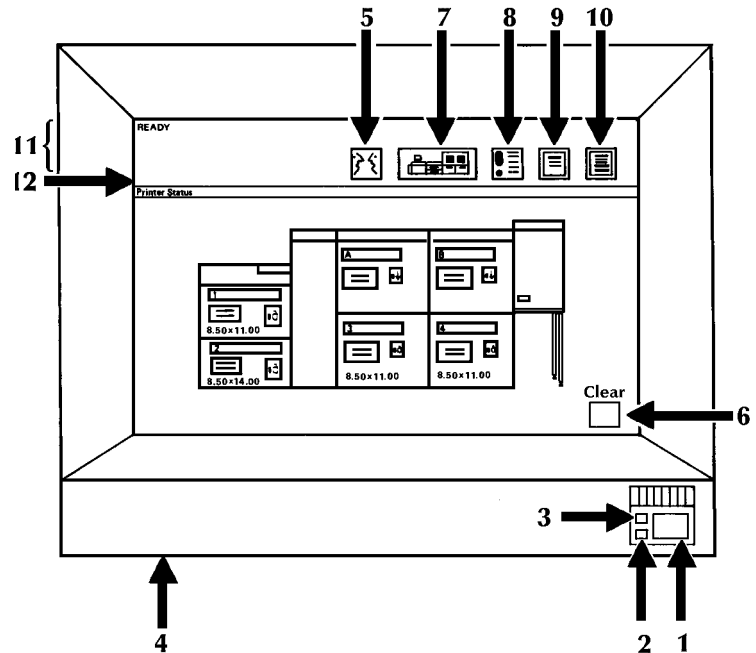

- 1 Continue button
- 2 Stop button
- 3 Sample button
- 4 Brightness control thumbwheel
- 5 Language icon
- 6 Clear button
- 7 Printer icon
- 8 Fault List icon
- 9 Tools icon
- 10 Guarded Tools icon
- 11 Message area
- 12 Icons area

Continue button. Press this button to resume printing.

Stop button. Press this button to stop printing.

Sample button. Press this button to cause a sample of the current print job to be sent to the sample tray.

Brightness control thumbwheel. Use this thumbwheel to adjust the brightness of the printer control console display.

Language icon. If two languages are available for your printer control console, selecting this icon allows you to choose the language for the printer control console messages.

Clear button. Select this button to clear fault messages.

Printer icon. Select this icon to display the printer mimic. (This is the default display on the printer control console.)

Tools icon. Select this icon to display call for service information and to adjust display features of the printer control console (for example, alarm loudness).

Fault List icon. Select this icon to display the Fault List screen. Refer to the “Fault masking and the printer control console” section of the “Problem solving tasks” chapter for additional information on this screen.

Guarded Tools icon. This icon is reserved for the service representative and operators who have completed Advanced Customer Training (ACT).

Message area. This area is used as follows:

- Lines 1 and 2. These lines display the current status of the printer, for example, READY.
- Line 3. This line displays messages concerning masked conditions, such as low dry ink. These messages are preceded by an asterisk.
- Line 4. This line displays messages that originate at the system controller.

Icons area. The following icons appear in this area:



Hint icon. This icon appears when a masked fault MT038 or condition exists in the printer. (Refer to the “Fault masking and the printer control console” section of chapter 12, “Problem solving tasks,” for additional information.) The icon also appears on the PC UI.



Fault icon. This icon appears when a fault exists in the system that stops the printer or prevents it from printing. The icon also appears on the PC UI.



Guarded tools icon. This icon appears when a maintenance task requiring a Customer Productivity Workshop (CPW) trained operator must be done. If you have successfully completed CPW, either check the PC UI for messages concerning the maintenance task or touch the Guarded Tools icon to display the Guarded Tools screen. If you are not a CPW trained operator, notify your lead operator or a CPW trained operator at your site.

Attention light

An Attention light is mounted on top of the inverter feeder/stacker module. (Refer to figure 1-5.) The Attention light can be enabled or disabled (refer to chapter 4, “System control tasks,” for instructions). When enabled, the light has three states:

- **Off.** No printer problems exist that require your attention.
- **Steady light.** A situation exists that needs your attention (such as low dry ink condition).
- **Flashing.** The printer has stopped and your attention is required immediately.

Registration transport levers

The heavy paper levers are used to optimize performance when running heavy weight or oversized papers. Refer to the “Printing problems” section in the “Problem solving tasks” chapter for more information on these levers.

Optional components

Optional components are available for both the system controller and the printer.

Optional system controller components

The optional components for the system controller are as follows:

- Peripheral cabinet
- Open-reel tape drive
- 18/36 track cartridge tape drive
- Floppy disk drive.

Peripheral cabinet

The peripheral cabinet houses the open-reel and 18/36 track tape drives. Both drives are shown in figure 1-11.

Figure 1-11. **Peripheral cabinet with tape drives**

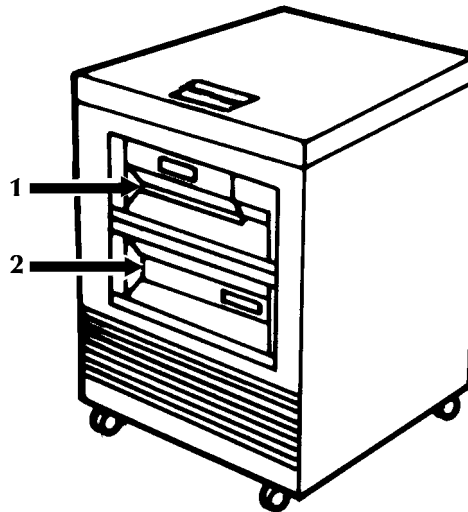

- 1 Open-reel tape drive
- 2 18/36 track cartridge tape drive

Open-reel tape drive

The open-reel tape drive has the following features:

- 1/2 inch/13 mm streamer with a horizontal tape path.
- Self-loading tape system.
- Tape is visible through a window in the front of the tape drive so you can verify the presence of the tape and tape motion.
- The tape cover can be raised for routine cleaning.
- It has a control panel including an eight-character alphanumeric display for messages and error information. Figure 1-12 shows the control panel.

Figure 1-12. Open-reel tape drive control panel

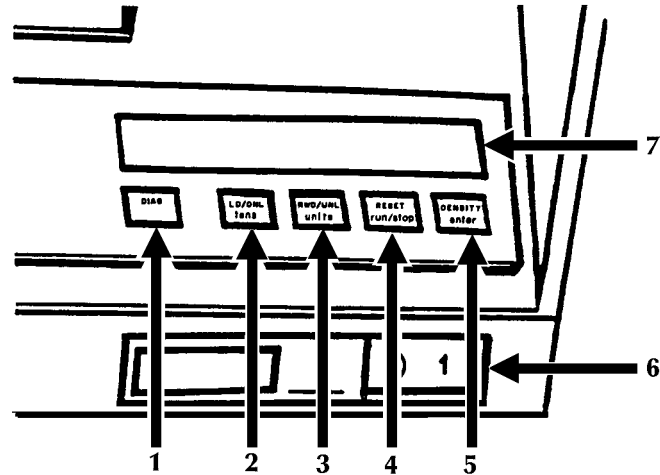

1. **Diag button.** Sets or cancels diagnostic mode. (If DIAG appears in the message display and a diagnostic program is not active, pressing the Diag button cancels the diagnostic mode. If DIAG does not appear in the message display, pressing the Diag button sets the diagnostic mode.)
2. **Ld/Onl(tens) button.** Initiates loading; if loading is finished, puts the tape drive online to the system controller. In diagnostic mode, pressing this button increments the program number appearing in the message display by tens.
3. **Rwd/Unl(units) button.** Rewinds the tape to beginning of tape (BOT) if the tape drive is not online; when at BOT, unloads the tape and opens the tape door. In diagnostic mode, pressing this button increments the program number appearing in the message display by single digits.
4. **Reset(run/stop) button.** Takes the tape drive offline and cancels load and unload sequences. In diagnostic mode, pressing this button starts a program or program stack if a program is not running and stops the program or program stack if a program is running.
5. **Density(enter) button.** Used to select the required operating density or check the current density setting. In diagnostic mode, this button is used to enter a program number to the program stack.
6. **Power switch.** Powers the tape drive on (1) or off (0).
7. **Message display.** Displays tape drive messages and error codes.

18/36 track cartridge tape drive

The 1/2 inch cartridge tape used with the Xerox DocuPrint 180 is the 18/36 track drive. While many of the features of the two drives are the same, there are some differences. The tape drive has the following features:

- An integrated controller and tape drive.
- A fully-featured IBM 3480/3490 compatible cartridge tape subsystem.
- Uses a 3480/3490 type tape cartridge.
- The tape drive is self-threading.

The 18/36 track drive has an 8 character display.

The 18/36 track drive can read either 18 or 36 track format, but records (writes) in only 36 track format.

Figure 1-13. 18/36 track cartridge tape drive control panel

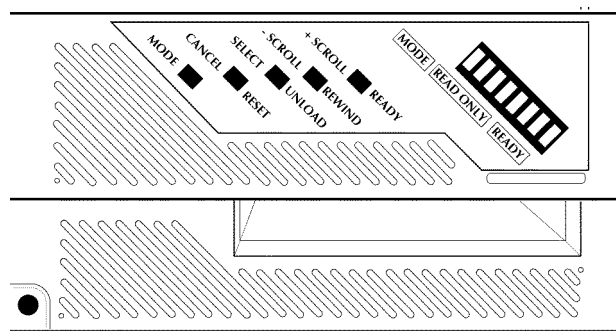

The following push buttons are located on the tape drive front panel:

Ready button. Places the drive "online" to communicate with the system controller. This button also serves as the + Scroll control menu selection when the alternate mode is selected.

Rewind button. Rewinds the tape to the beginning of Tape (BOT). This button also serves as the - Scroll control for menu selection when the alternate mode is selected.

Unload button. Rewinds tape completely into housing and then ejects the cartridge. This button only functions when the tape drive is "offline" to the controller. This button also serves as the Select function for menu items when the alternate mode is selected.

Reset button. Stops tape motion during rewind, unload, or "online" operation. If the drive is "online" pressing this button will take the drive "offline". This button also serves as the Cancel function, taking the operator back one menu level when the alternate mode is selected.

Mode button. Switches modes of the tape drive, displaying menu selections and assigning alternate functions to the buttons described above. This button only functions when the tape unit is not ready.

The front panel also contains the following three indicator lights:

Read only. Is illuminated if the installed cartridge is write protected.

Ready. Is illuminated when a cartridge is loaded and the tape drive is online to the system controller.

Mode. Is illuminated when the alternate mode has been selected.



Note: If all three indicators lights are flashing, a problem has occurred and operator intervention is required.

Message display. Displays tape drive messages, menus, and error codes. Messages such as LOADING, BOT, REWIND, CLEAN, are displayed to show status. Other messages such as CST indicating a standard length cassette, ECCST indicating an extended length cassette, or CLEANING indicating a cleaning cartridge are also displayed. The message display will also show a small flashing square in the rightmost character space to indicate tape unit interface activity.

Floppy disk drive

When installed, the optional floppy disk drive is located in the system controller, to the right of the 1/4 inch cartridge tape drive. It allows you to transfer files between a floppy disk and the system controller's hard disk.

Optional printer components

This section describes the following printer components:

- Feeder/stacker
- Bypass Transport Module
- Input enablement device
- 7 X 10 enablement kit

Feeder/stacker

The Xerox DocuPrint 180 has an inverter feeder stacker, and up to three optional feeder stackers. Refer to the section "Printer components" earlier in this chapter for information on the feeder stacker.

Bypass Transport Module

The Bypass Transport Module moves paper from the stacker to a third party finishing device (for example, a stitcher). When installed, the Bypass Transport Module is attached to the last feeder/stacker module. Figure 1-14 shows the Bypass Transport Module.

Figure 1-14. **Bypass Transport Module and input enablement device**

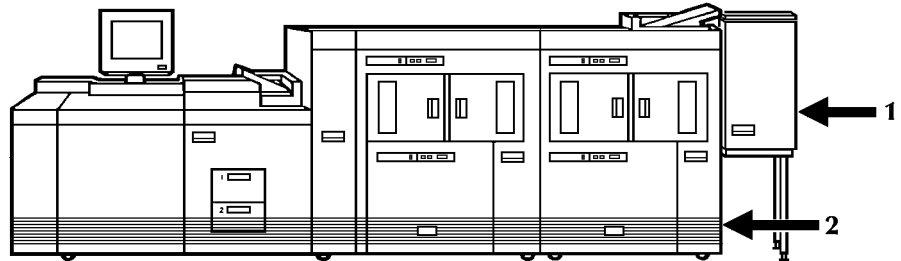

- 1 Bypass Transport paper output location
- 2 Input enablement device paper input location

Input enablement device

The input enablement device allows your Xerox DocuPrint 180 to support and interface directly with feeders. As shown in figure 1-15, it is located on the right side of the last feeder/stacker. Figure 1-15 shows the input enablement device.

7 X 10 enablement kit

The 7 X 10 input enablement kit allows your Xerox DocuPrint 180 to print on 7 by 10 inch/178 by 254 mm paper size, with throughput speed of up to 206 PPM.

Printer configurations

The Xerox DocuPrint 180 LPS is available in the following five configurations:

1. Printer + Inverter Feeder Stacker + Feeder Stacker
2. Printer + Inverter Feeder Stacker + Feeder Stacker + Bypass Transport
3. Printer + Inverter Feeder Stacker + Feeder Stacker + Feeder Stacker
4. Printer + Inverter Feeder Stacker + Feeder Stacker + Feeder Stacker + Bypass Transport
5. Printer + Inverter Feeder Stacker + Feeder Stacker + Feeder Stacker + Feeder Stacker

Each of these configurations can have the following printer options:

- 7X10 enablement kit
- Input enablement device.



Note: The input enablement device is not available on the last configuration: Printer + Inverter Feeder Stacker + three Feeder Stackers.



Note: Each of the configurations and options above is available with the Xerox DocuPrint 180 system.

Refer to the “Printer options” section earlier in this chapter for information about each of the options above.

Figures 1-15 through 1-19 illustrate each of five the printer configurations available.

Figure 1-15. **Printer + Inverter Feeder Stacker + Feeder Stacker**

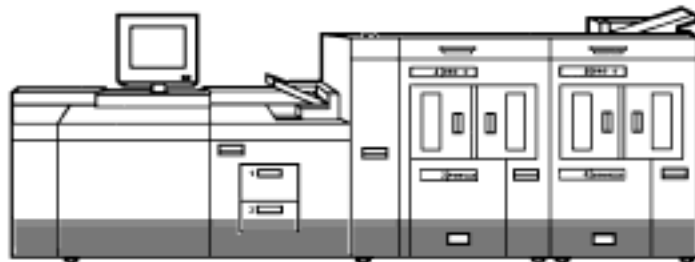

Figure 1-16. **Printer + Inverter Feeder/Stacker + Feeder/Stacker + Bypass Transport**

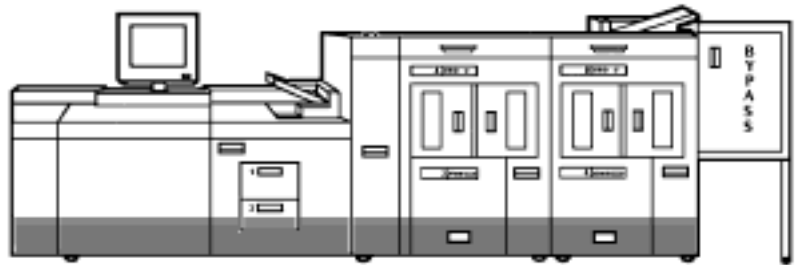

Figure 1-17. **Printer + Inverter Feeder Stacker + Feeder Stacker + Feeder Stacker**

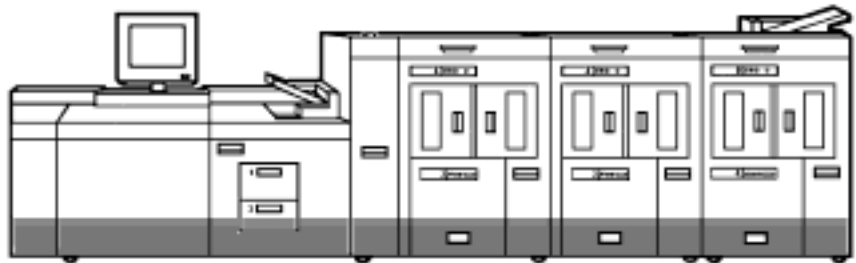
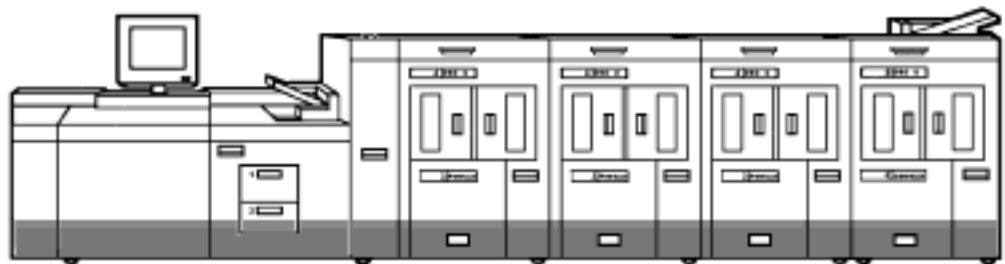

Figure 1-18. **Bypass transport module and input enablement device**



Figure 1-19. **Printer + Inverter Feeder Stacker + Feeder Stacker + Feeder Stacker + Feeder Stacker**



2.

Using the PC UI

PC UI

With the PC UI you perform operator tasks through a dynamic set of windows. Either a mouse or certain keyboard combinations are used to move between windows and select options. The PC UI also allows you to enter commands through a window on the display screen.



Note: Several PC UI types are available. Your PC UI may look different from the one illustrated in figure 2-1.

Figure 2-1. PC UI

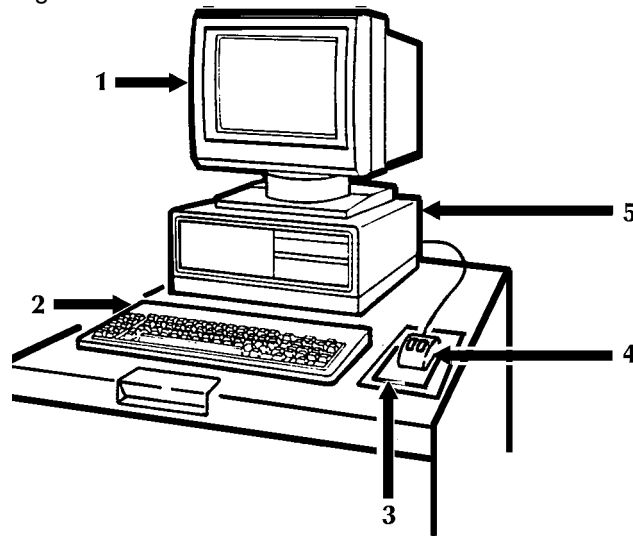

- 1 Monitor
- 2 Keyboard
- 3 Mouse pad
- 4 Mouse
- 5 Processor

Powering on the PC UI

To power on the PC UI:

- Step 1.** Locate the power switch on your PC UI. Turn it on.
- Step 2.** Locate the power switch on the PC UI monitor. Turn it on.

Some information appears on the screen as the PC UI starts. Next, the Wait cursor appears (refer to the “Types of cursors” section later in this chapter).

Adjusting the PC UI monitor

Most PC UI types allow you to adjust both the brightness and contrast of the PC UI monitor. Figure 2-2 shows one type of PC UI and its controls. Your PC UI may be different.

Figure 2-2. **Brightness and Contrast controls for the PC UI monitor**

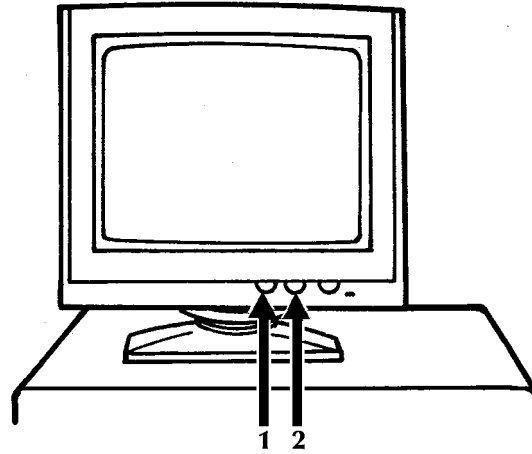

- 1 **Contrast control**
- 2 **Brightness control**

Turn the contrast control wheel clockwise to increase the contrast of the monitor display.

Turn the brightness control wheel clockwise to increase the brightness of the monitor display.

Components of the PC UI

The following sections explain the components of the PC UI in detail.

PC UI keyboard

The PC UI keyboard, shown in figure 2-3, allows you to enter text and perform tasks.

Figure 2-3. PC UI keyboard

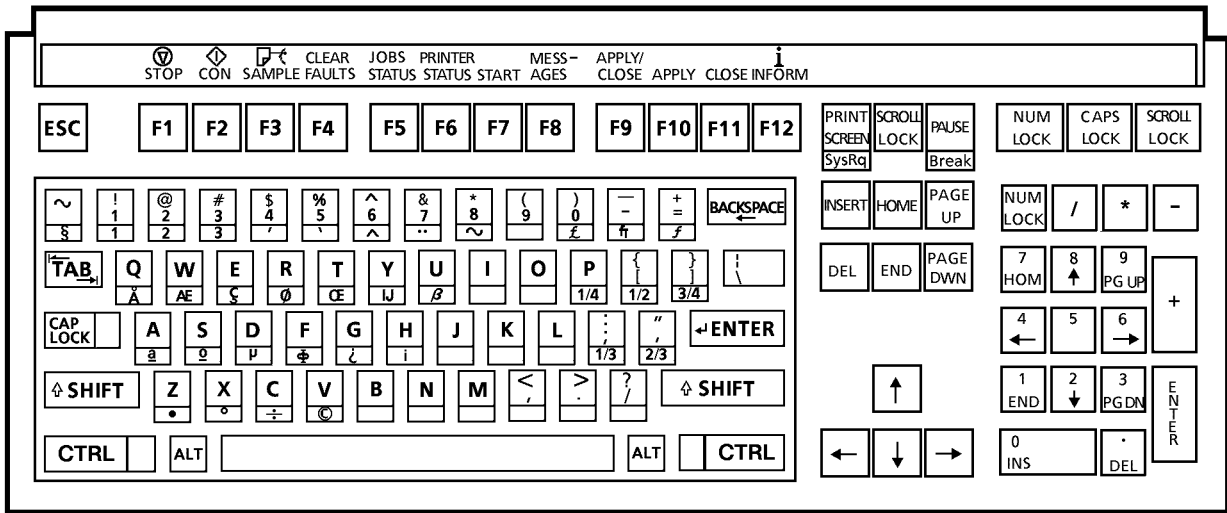

The PC UI keyboard contains the following:

Character keys These keys are used to enter text in the Command Line/Message window or input fields of windows.

Front face of some character keys The front face of certain character keys have multinational characters on them. These are language-specific characters (such as _ or £) or mathematic symbols (such as + or 3/4). To generate a multinational character, press and hold the <ALT> key while pressing the desired character key. For example, <ALT> + <P>=1/4.

Arrow keys These keys are used in place of the mouse to move the cursor around the desktop.

Function keys These keys perform functions as follows:

- F1. Stop printing
- F2. Continue printing
- F3. Sample
- F4. Clear Faults
- F5. Jobs status display
- F6. Printer status display

- F7. Start window
- F8. Messages window
- F9. Apply/Close
- F10. Apply
- F11. Close
- F12. Not functional at this time (future use as an information key)

Special function keys

Certain keys have special functions that mimic the mouse operation. You can use these keys if your mouse is not working. Both the keyboard and the mouse operation are listed below.

<ENTER> Pressing this key has the same result as clicking the left mouse button once. Holding the <ENTER> key down has the same result as holding the left mouse button down. Pressing the <ENTER> key when an input field is active (such as, when an input field contains the blinking data entry cursor) has the same result as selecting the header button containing the enter symbol.

<CTRL> + <ENTER> Pressing these keys has the same result as pressing the right mouse button once. Holding <CTRL> and <ENTER> down has the same result as holding down the right mouse button. When the data entry cursor is displayed in an input field, pressing <CTRL> + <ENTER> has the same result as pressing <ENTER>.

<CTRL> + <SPACEBAR> Pressing these keys has the same result as chording the mouse, that is holding down both the left and right buttons of the mouse. (Chording the mouse results in the I/O menu being displayed. Refer to chapter 7, "Job Control windows," for information on the I/O menu.) <CTRL> + <SPACEBAR> does not function when the data entry cursor is displayed in an input field. If necessary, press the <ESCAPE> key to remove the data entry cursor from the window.

<CTRL> + <X> This key combination cancels operations, such as file listings.

<ESCAPE> Pressing this key cancels entry into an input field by removing the data entry cursor from the window.

<TAB> This key selects the next input field.

Cursor

The cursor is the entry point for information or activity on the PC UI screen.

Types of cursors



Wait cursor. Appears when a system activity is being processed (for example, when a window is being opened) and during system initialization.



Main cursor. Appears when the cursor can be moved on the desktop.



Data Entry cursor. Appears when you can enter information in an input field.

Moving the cursor

You can move the cursor in either of two ways:

- Mouse
- Arrow keys.

Using the mouse

To move the cursor using the mouse, lightly move the mouse over the mouse pad. You may lift the mouse and put it down again gently in a different position on the mouse pad if you "run out of room" on the pad while you are moving it. (Lifting the mouse and setting it down does not cause the cursor to move.) Ensure that the mouse is touching the mouse pad.

Using the arrow keys

To move the cursor using the arrow keys, make sure that the **<NUM LOCK>** key is not activated. Then press the arrow key pointing in the direction you want the cursor to move. You may hold the arrow key down; however, the cursor moves very quickly when you do this.

To select an input field with the arrow keys:

- Step 1.** Press **<ESCAPE>** to remove the data entry cursor from the screen.
- Step 2.** Use the arrow keys to move the main cursor to the desired input field.
- Step 3.** Press **<ENTER>** to activate the input field. The data entry cursor appears in the input field.
- Step 4.** Use the arrow keys to move the data entry cursor within the input field.

PC UI mouse

The PC UI mouse controls the movement of the cursor. Use the mouse to position the cursor in order to select icons or options on the desktop. Figure 2-4 shows the PC UI mouse.

Figure 2-4. **PC UI mouse**

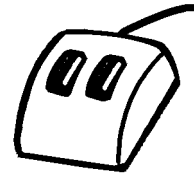

The PC UI mouse has two buttons:

- **Left mouse button.** This button is used to select the options displayed on the desktop.
- **Right mouse button.** This button is used during specialized activities (for example, resizing a window).

The mouse plugs into the back of the PC UI. You can place the mouse on either the right or left side of the keyboard by changing the direction of the mouse cable behind the PC UI.

Selecting options with the mouse

Position the cursor on top of the icon or option you want to select by sliding the mouse over the mouse pad. Then click once with the left mouse button to select the option.

PC UI desktop

The PC UI desktop is the basic display screen. The desktop is shown in figure 2-5.

Figure 2-5. PC UI desktop

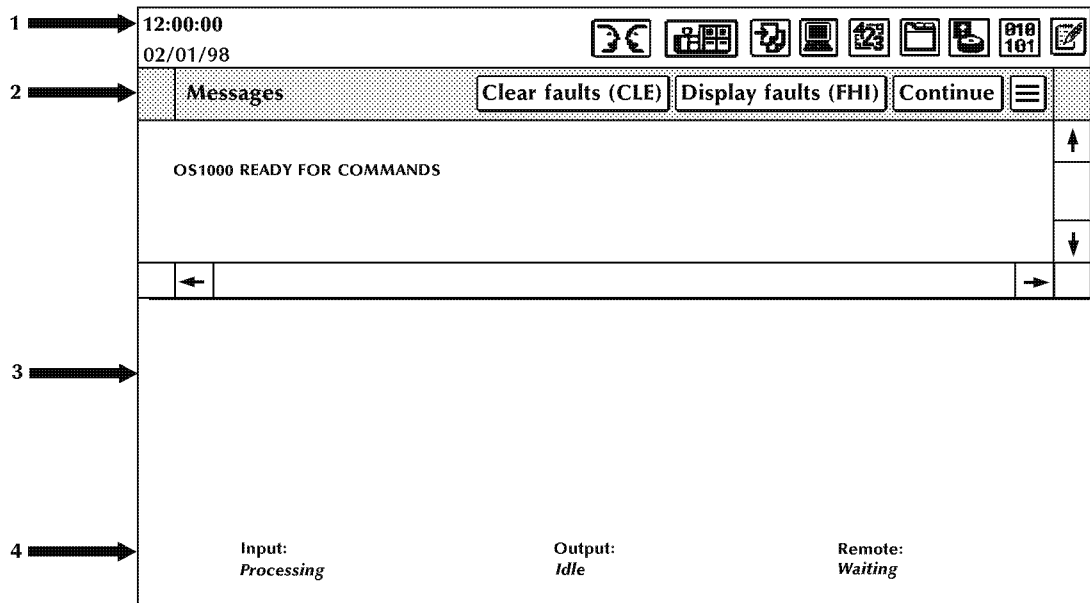

- 1 **Status area**
- 2 **Messages window**
- 3 **Work area**
- 4 **System status and source display**



Note: The icons you see depend on the level to which you are signed on. Certain tasks are restricted to certain log-on levels. You need a special password to access those tasks. The tasks covered in this manual are all tasks an operator needs to perform. For information on additional icons and options not covered in this guide, refer to the *180 LPS PC User Interface Reference*.

The messages window displays system messages and allows you to enter commands for performing LPS tasks. You can scroll through the messages in this window (refer to the “Using the scrollbars” section later in this chapter), and the window can be resized or moved (refer to the “Moving and resizing the window” section later in this chapter for instructions). This window cannot be closed. The Messages window contains three header buttons and three header options:

- **Clear Faults.** Select this button to clear printer software faults (when directed by a message in the Messages window or on the printer control console). Selecting this button also causes any outstanding printer faults to be displayed in the window.



Note: Entering CLEAR has the same effect as selecting the Clear Faults button or the function key <F4>.

- **Display Faults.** Select this button to display a list of all outstanding printer faults.



Note: Entering FHI has the same effect as selecting the Display Faults button.

- **Continue.** Select this button to resume input processing and printing.
- **Autoscroll Off.** Select this option, located in the header auxiliary menu, to disable automatic scrolling of new messages in the Messages window.
- **Autoscroll On.** Select this option, located in the header auxiliary menu, to enable automatic scrolling of new messages in the Messages window.
- **Close All Windows.** Select this option, located in the header auxiliary menu, to close all open windows (except for the Messages window).

The work area displays windows. Windows open in a specific place on the desktop and are a specified size. You can leave windows open, move them around, resize them, and generally arrange the work area to suit your needs. After the PC UI is powered off or you select the "Exit to DOS" option, the windows return to their default size and location. However, during a session, windows maintain their last-used size and location.

The system status and source display area displays the input source and status, the output status, and the remote source and status of the LPS.

Desktop icons

The desktop icons are as follows:



Hint icon. This icon appears only when certain conditions (such as low dry ink) arise. When the icon appears:

- Messages appear in the Messages window of the PC UI. These messages are preceded by an asterisk and contain information about any unavailable devices (such as feeder trays) and the condition itself.
- The Hint icon also appears on the printer control console, along with messages and graphic displays.
- If enabled, the printer Attention light goes on.



Fault icon. This icon appears only when fault conditions exist (such as paper jams). When the icon appears:

- Windows containing information open on the desktop or messages appear in the Messages window of the PC UI. These messages are preceded by an exclamation point and contain information about the fault, any unavailable devices (such as feeder trays), and instructions for clearing the fault.
- The Fault icon also appears on the printer control console, along with graphic displays and messages.
- If enabled, the printer Attention light flashes.



Language icon. This icon allows you to switch languages on the PC UI if it is configured for two languages.

For more information on this icon, refer to the *Xerox DocuPrint 180 Laser Printing System PC User Interface Reference*.



Print Tasks icon. This icon allows you to access the Print Tasks menu. A few of the tasks you can perform through Print Tasks windows are:

- Start an online, offline, or host interface processor (HIP) job
- Monitor job status
- Set paper tray sizes and bin stacking limits
- Set clusters.



Job Control icon. This icon allows you to access the Job Control menu. A few of the tasks you can perform through Job Control windows are:

- Stop, continue, or abort a job
- Clear the job queue
- Adjust print alignment
- Sample files.



System Control icon. This icon allows you to access the System Control menu. A few of the tasks you can perform through System Control windows are:

- Change logon level or password
- Restrict command usage (RCU)
- Back up, display, print, or empty the console log
- Exit to DOS.



Accounting icon. This icon allows you to access the Accounting menu. A few of the tasks you can perform through Accounting windows are:

- Access the list of completed reports (status file service)
- Access activity and user report information
- Print billing statistics.



Files icon. This icon allows you to access the Files menu. A few of the tasks you can perform through Files windows are:

- Display or print information on tape or disk files
- Copy, delete, or rename disk or tape files
- Fix fonts and logos
- Scale 300 spi fonts, forms, or logos.



Disks icon. This icon allows you to access the Disks menu. A few of the tasks you can perform through Disks windows are:

- Back up the system disk to tape
- Compress and verify the system disk file structure
- Reallocate print file and raster image file size
- Download communication and RIP software.



Utilities icon. This icon allows you to access the Utilities menu. A few of the tasks you can perform through Utilities windows are:

- compile FDL (forms description language) or PDL (print description language)
- Invoke file editor functions
- Transfer a single file from a Backup (DSR) tape to system disk
- Exit to DOS.



Notepad icon. This icon allows you to access the Notepad window to view or create electronic notes for yourself or other PC UI users.

Windows

When you open one of the Menu icons, a Menu window is displayed (see figure 2-6 for a sample). A Menu window is a list of options. Selecting one of the options may open another window (referred to in this guide as a "Task window"). The following section discusses the basic components of PC UI windows.

Figure 2-6. **Window example one**

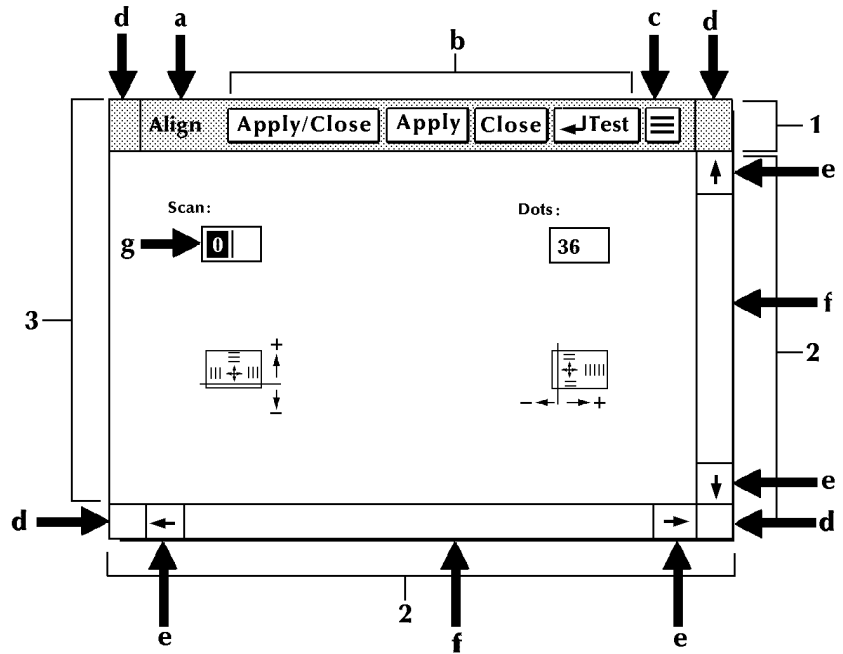

- 1 **Window header**
- 2 **Scroll bars**
- 3 **Window interior**

Window header The window header contains the following:

- a. **Window label.** This is the name of the window.
- b. **Header buttons.** These are buttons which perform specific functions. The Header buttons you see vary based on the window. The basic Header buttons are as follows:
 - **Apply/Close.** This button implements the selection you made in the window and closes the window.
 - **Apply.** This button implements the selection you made in the window. The window remains open.
 - **Close.** This button closes the window without implementing any selections.



Note: The following buttons are not shown in the window in figure 2-6, but are found in the Auxilliary menu. If the window is stretched to the right far enough all of these buttons would be seen in the window and nothing would remain in the Auxilliary wmenu.

- **Redisplay.** This button resets any default values or information to what they were when you opened the window or the last time any changes were applied.
- **Yes.** This button confirms the question asked in the window and closes the window.
- **No.** This button does not confirm the question asked and closes the window.

In addition, a window may have a Header button (or more than one) whose actions are directly related to the window's function.

- c. **Auxiliary menu.** This icon contains other options not shown in the window header due to lack of space. To open the auxiliary menu, click on the icon with the left mouse button. Then select the option you want. To close the auxiliary menu, click on the icon again, or click anywhere on the desktop, except on a menu item.
- d. **Move/Resize targets.** These targets allow you to reposition or resize the window. Refer to the "Moving and resizing the window" section of this chapter for instructions.

Scroll bars The scroll bars contain the following:

- e. **Scrolling targets.** These targets allow you to move the contents of a window up or down, left or right. Refer to the "Using the scroll bars" section of this chapter for instructions.
- f. **Index bar.** The index bar allows you to scroll through the window more quickly than using the scrolling targets. Click on the gray portion of the index bar to move the window information to the right or left, or up or down. (If the index bar is all white, all the window information is already displayed.)

Window interior The window interior contains the following:

- g. **Input fields.** In these areas you may enter information.

Buttons and check boxes. Buttons and check boxes are used to select options in a window (see figure 2-7). They can be on or off (selected or not selected). When a button is on, a dot fills the center of the circle. When a check box is on, an X fills the middle of the box. Refer to figure 2-7 for a display of buttons and check boxes that are on and off.

Figure 2-7. Buttons and check boxes

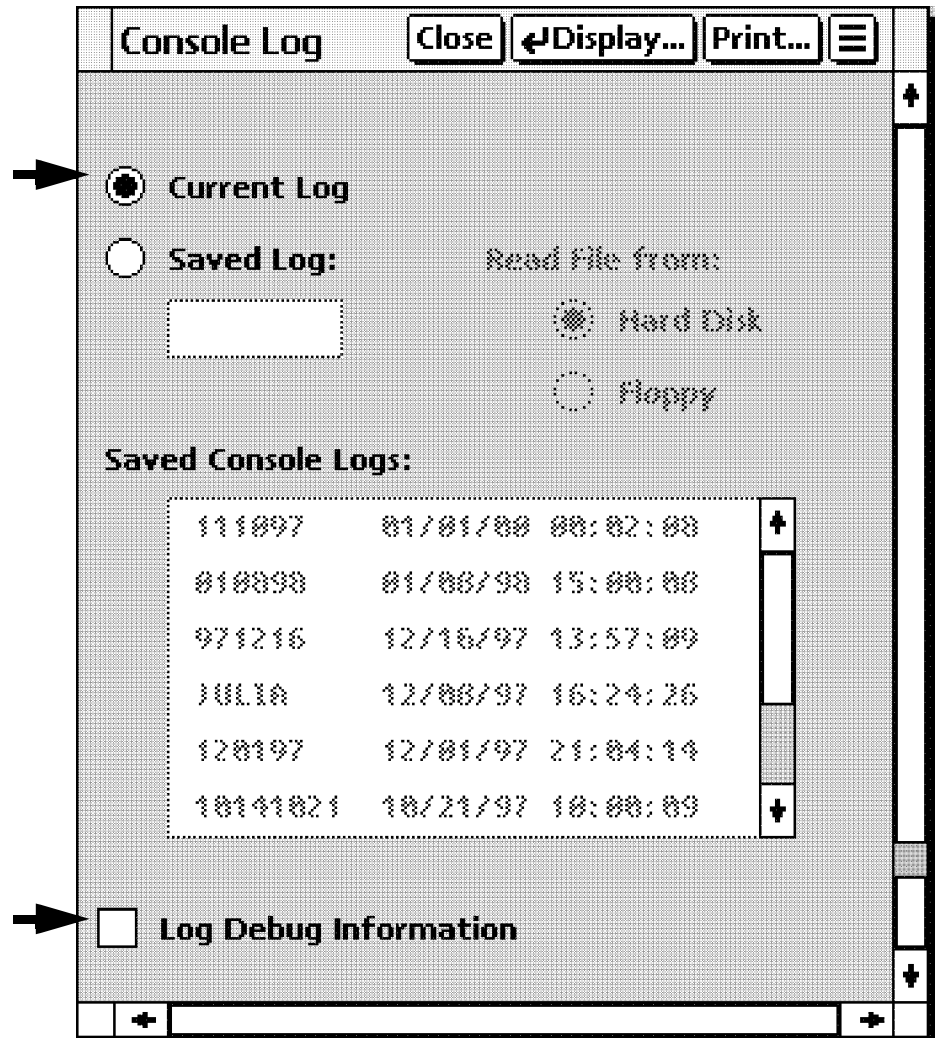

To select a button or check box, click on it using either the mouse or the keyboard (refer to the "PC UI mouse" and "PC UI keyboard" sections of this chapter). Only one button can be selected from a set of buttons; multiple check boxes may be selected in a set of check boxes.

Output fields. Display only fields, as shown in figure 2-8.

Figure 2-8. Window example three

Billing	Close Print
CUSTOMER BILLING REPORT	
Date	01/19/98
Time	12:02
Serial no	015012
System ID:	V3C2 R1.2 1/13/98 SARAH
**** System Configuration ****	
Machine Type - DP180 LPS	
CPU Memory =	1024 K
AIS: Version	2
Bitmap Memory:	256 Megabits
Ink Memory:	2 Megabits
Text and Metrics Memory:	3 Megabytes
Online: Address	CA
- Mode Burst ,	Device 3211
Terminal Type:	PC
SCSI Tape Devices:	
- Reel to Reel:	HP-SCSI A/Ch 0/Tg 0
- Streamer Tape:	HP-SCSI A/Ch 0/Tg 1
SCSI Disk Units:	0,1,2,Floppy
Page Buffer Memory Size:	128 Ban
Page Buffer A,B:	2 Buffers
Memory Test at Boot	= yes
Auto Boot Enabled	= no
Boot Message Display	= yes
Printer Characteristics	
- Speed:	180 ppm
- Resolution:	300 spi
- Default Order:	1 to N
- Paper size:	8.50 x 11.00 Inc
Language:	U.S. English
Graphics Type:	AIS
SCSI Tape Device Assignments:	
- TD0 =	Reel to Reel Tape
- TD1 =	Streamer Tape

Menu entries. Display a list of options, as shown in figure 2-9.

Figure 2-9. **Window example four**

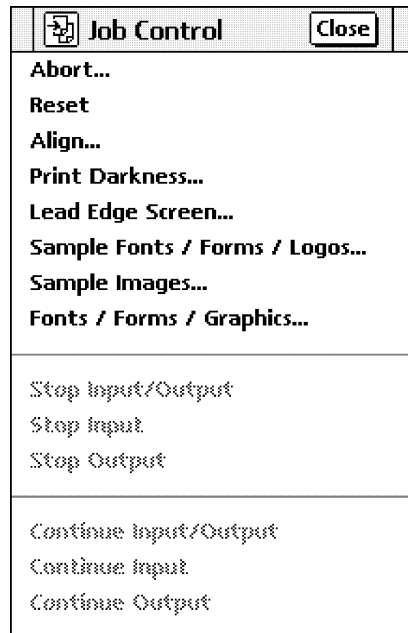

Note: If a window option is not currently available, it appears “grayed out”—the image is faint and you cannot select the option. If a window option is restricted, it is not shown at all.

Additional types of windows

In addition to Menu windows and Task windows, the following windows appear on the desktop as a result of things you have done or conditions in the LPS:

- Confirmation window
- Error window.

Confirmation window

The confirmation window opens as a result of something you have done in a Menu or Task window or as part of the logical sequence of an operation. It has two targets: Yes and No. You must respond to the confirmation window before you can continue using the PC UI windows. The confirmation window has a yellow header bar if one of the following applies:

- Data may be lost as a result of the proposed action.
- cycle down of the printer may occur as a result of the proposed action.

Otherwise, a confirmation window has a green header bar. Figure 2-10 shows a sample confirmation window.

Figure 2-10. **Confirmation window**

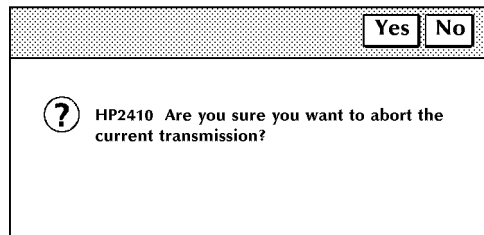

Error window

The error window opens when the system encounters an error or a condition that requires you to perform an action or choose from several options. A sample error window is shown in figure 2-11.

Figure 2-11. **Error window**

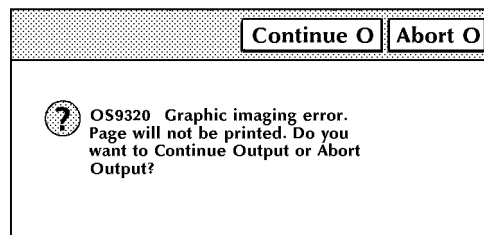

There are also message windows that may appear as a result of conditions in the LPS, communication problems between the PC UI and the system controller, or problems within the PC UI. For additional information on these windows, refer to the *180 LPS PC User Interface Reference*.

Working with windows

You can do the following with the windows of the PC UI:

- Leave more than one window open at a time
- Move and resize the windows
- Select options from the window header
- Select options from the auxiliary menu
- Select options from the main part of the window
- Enter information into the window.

Moving and resizing the window

The Move/Resize targets allow you to move or resize a window on the PC UI. Figure 2-12 shows how to move a window and figure 2-13 shows how to resize a window.

Moving the windows To move the window to a new position on the desktop:

- Step 1.** Place the cursor over the Move/Resize target.
- Step 2.** Press the left mouse button and hold it down while you "drag" the window to its new position.
- Step 3.** Release the left mouse button.

To move the window using only the keyboard:

- Step 1.** Position the cursor over the Move/Resize target.
- Step 2.** Press and hold the <ENTER> key while using the appropriate arrow keys to move the window.

Figure 2-12. **Moving a window**

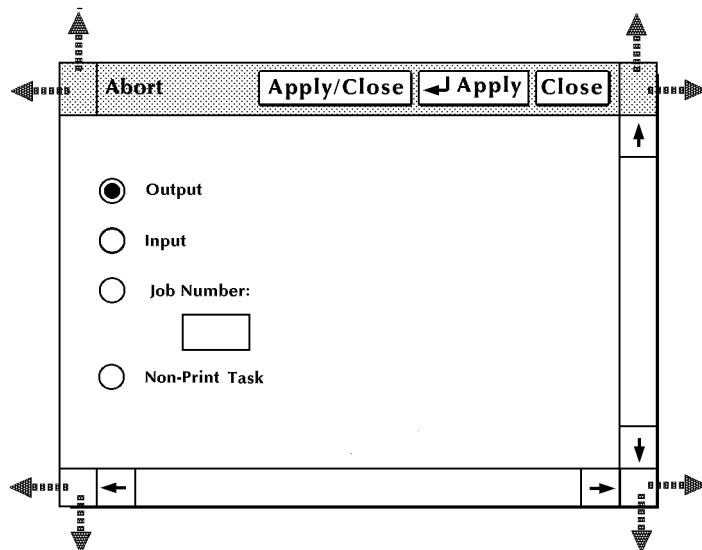

Resizing the windows To resize the window:

- Step 1.** Place the cursor over a corner Move/Resize target.
- Step 2.** Depress the right mouse button and hold.
- Step 3.** Move the cursor in one of the following directions to change the size of the window, accordingly:
- To the right
 - To the left
 - Up
 - Down
 - Diagonally.

To resize the window using only the keyboard:

- Step 1.** Press the <ESCAPE> key.
- Step 2.** Position the cursor over the corner Move/Resize.
- Step 3.** Press and hold the <CTRL> key and <ENTER> keys while using the appropriate arrow keys to resize the window.
- Step 4.** Place the cursor inside the box and press <ENTER>.

Figure 2-13. Resizing a window

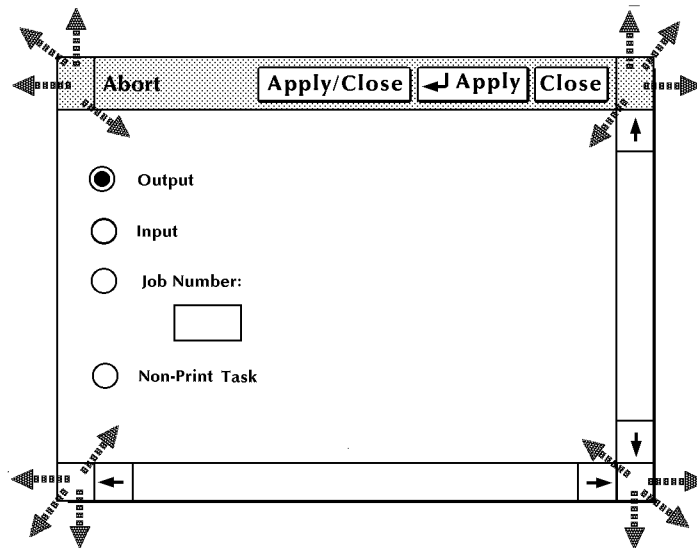

Note: The Move/Resize targets can also be used to move a window to the bottom or bring a window to the top of the desktop display. Use the mouse or <ENTER> key to click once on one of the Move/Resize targets of the window you want to move to the bottom or bring to the top.

Using the scroll bars

The scroll bars allow you to shift the display within a window (see figures 2-14 and 2-15). The scroll bars are especially useful in the Messages window.



Note: If all of the information within a window is already displayed, the scroll bars do not work.

Scrolling text up

To scroll text up, place the cursor in the arrow down target area, depress the left mouse button and hold. Text scrolls from bottom to top. When you release the button, the text stops scrolling. A single click on the target moves the text one line of information to the top.

Scrolling text down

To scroll text down, follow the above procedure, but place the cursor on the arrow up target area.

You can also scroll text up and down by moving the white box located inside the scroll bar. Move the box as follows:

- Step 1.** Place the cursor inside the box.
- Step 2.** Press the left mouse button and hold it down while you "drag" the box up or down within the scroll bar. Text within the window moves up or down accordingly.

You can scroll text using only the keyboard as follows:

- Step 1.** Press the <ESCAPE> key.
- Step 2.** Using the arrow keys, position the cursor over the arrow up or arrow down target area.
- Step 3.** Press the <ENTER> key to begin scrolling text.

Figure 2-14. Scrolling the text vertically

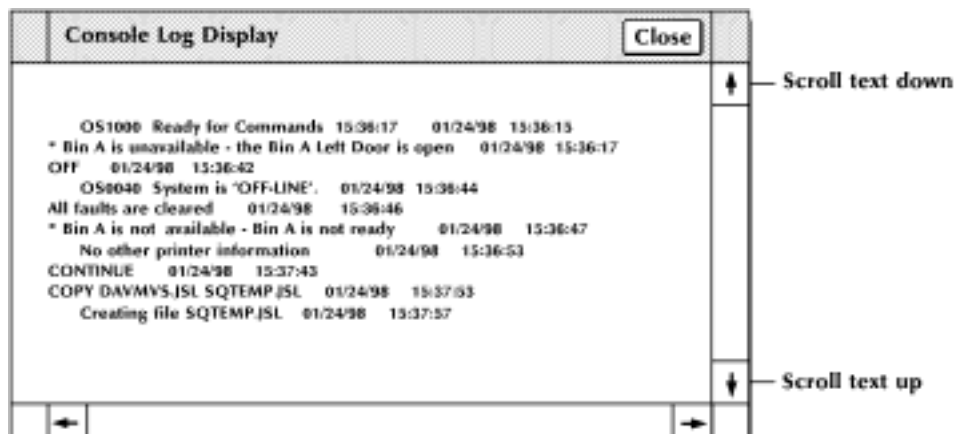

Scrolling text to the right

To scroll text to the right, follow the above procedure, but place the cursor on the arrow left target area. A single click moves the information one character to the right.

Scrolling text to the left To scroll text to the left, follow the above procedure, but place the cursor on the arrow right target area. A single click moves the information one character to the left.

Figure 2-15. **Scrolling the text horizontally**

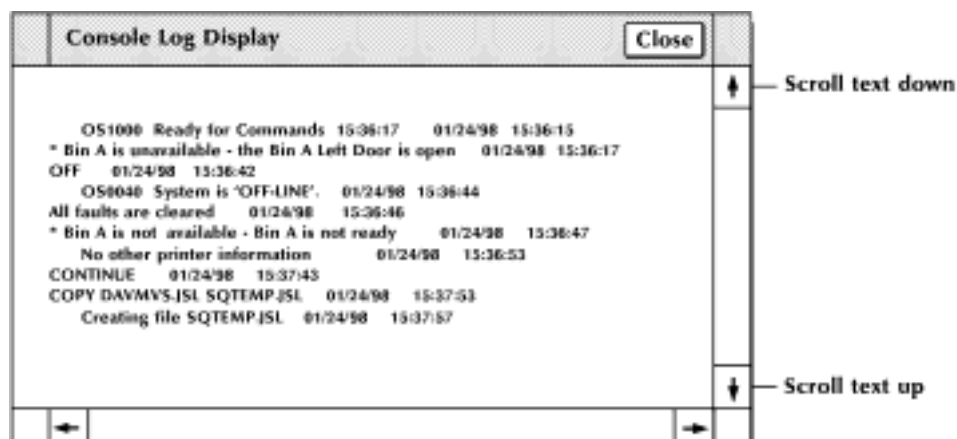

Activating an open window

Only one window can be active at a time, although more than one window can be open at a time. To activate an open window, move the cursor into the work area of the window and click once with the left mouse button. The header area of the window is now highlighted, and you can select options or enter commands in the window. If the window was underneath another window on the desktop, it now appears on top.



Note: To activate a Menu window, click once on a Move/Resize target, rather than the work area of the window.

Performing operator tasks through the PC UI

The PC UI gives you two options for performing operator tasks:

- Selecting tasks through windows
- Entering commands through the Messages window.

Performing tasks through windows

Follow the procedures outlined earlier in this chapter to open Menu and Task windows and select options using the PC UI windows.

Entering commands through the Messages window

Use the Messages window (see figure 2-16) if you want to perform a task by entering commands rather than selecting options in a window.

Figure 2-16. Messages window

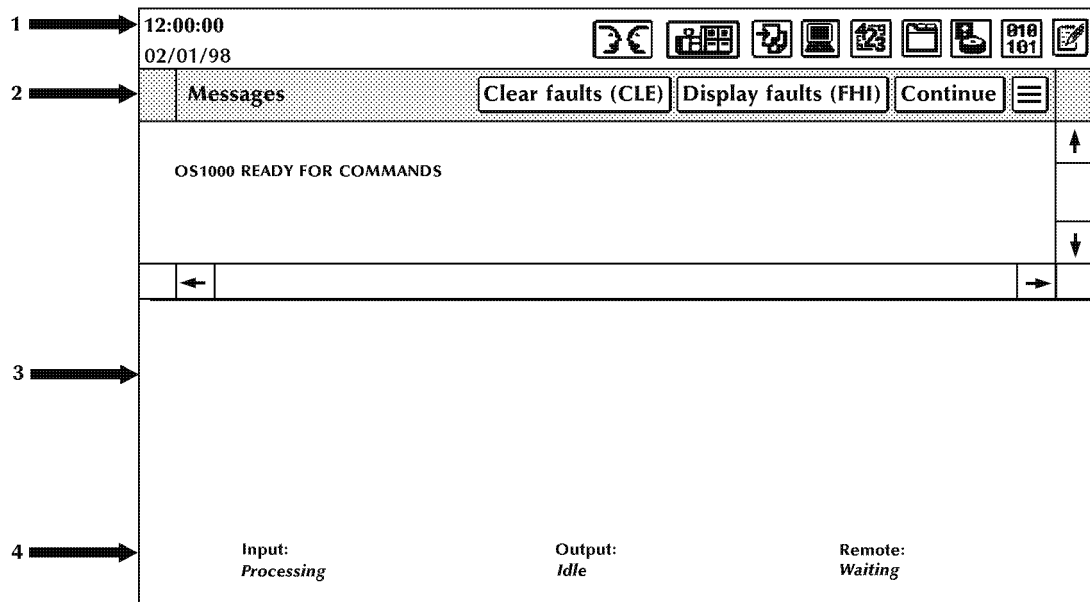

Place the cursor in the Messages window and click once with the left mouse button or the <ENTER> key to activate the window. Then enter the command at the cursor.

Key-in conventions

Follow these conventions when entering commands:

- The system is ready to receive commands when this message appears in the Messages window:
OS1000 READY FOR COMMANDS
- All commands may be abbreviated to the first three characters or spelled out fully and correctly.
- Commands are executed by pressing <ENTER>, except for those entered with the function keys.
- Spaces or commas may be used to separate command parameters.
- Error and information messages from the system are preceded by OS and a four-digit code indicating the severity level. Refer to the *Xerox DocuPrint 180 LPS Message Guide* for information on a particular error message.
- A message acknowledging your request appears as positive feedback to you. An error message appears when a command is entered incorrectly:

OS2710 INVALID COMMAND, PLEASE REENTER

Guide command conventions

When command instructions are given in this guide, the following conventions apply:

- Capital letters represent command keywords, the required part of the command.
- Lowercase letters, appearing in italics, represent data that changes each time you use the command. For example, the number of copies and the name of a form can vary for each job.
- Characters enclosed in square brackets ([]) are optional. You key them in only when you need them. For example, when you see [copies] in a command and you do not key in a specific number, the system automatically prints one copy.
- Characters enclosed in curly braces ({ }) are required.
- Options are separated by a vertical line (|).

Terminal emulation mode (TEM)

In certain instances (for example, when performing the Problem task), the PC UI display mimics a system controller terminal's screen for the duration of the task. This display mode is referred to as TEM. Once the task is finished, the desktop again appears on the screen.

Tasks performed in TEM mode are listed in the appropriate Menu window with "(TEM)" following the task name.

For example, when you select the "Problem . . . (TEM)" option from the System Control menu window, the PC UI is automatically put in TEM mode so that you can perform the Problem task.



Note: After finishing a task in TEM mode, you must wait for object mode to display before beginning another task in TEM mode. Failure to do so causes a system crash.

3.

Paper facts

This chapter contains information about paper handling and procedures for loading feeder trays and unloading stacker bins.

Important facts about paper

As the operator of the Xerox DocuPrint 180 LPS printer, you need to be aware of the importance of taking good care of the paper used in it. Using the correct type of paper and taking time to store and condition it properly helps to keep your printer running at optimum speed and efficiency, with fewer time-wasting paper jams.

For additional information about paper, refer to *Helpful Facts About Paper*.

Paper storage

Follow these storage guidelines:

- Do not unwrap the paper stock until it is needed.
- Store the reams of paper in their carton.
- Do not leave the paper cartons directly on the floor. Place something beneath them, for example, wooden pallets.
- When the paper stock is taken from a storage area with a different humidity or temperature, keep it in the room where it will be used for at least 48 hours before loading it into the LPS.

Paper specifications

This section lists the paper sizes, weights, and types that can be used in the Xerox DocuPrint 180 LPS.

Paper sizes

The following paper sizes can be used:

- Width: 7 to 17 inches/178 to 432 mm (17 inch/178 mm paper parallel to feed direction)
- Length: 10 to 14.33 inches/254 to 364 mm.

A continuous range of paper sizes from the system minimum to the system maximum is supported. Table 3-1 lists the standard paper sizes.



Note: 7 X 10 inch/178 by 254 mm paper can be fed with the optional 7 X 10 enablement kit installed.



Note: The minimum paper size is only available with the optional 7 X 10 enablement kit.



Note: Trays 1 and 2 hold 7 X 10 inch up to 9 X 14.33 inch paper. The High Capacity Feeders hold 7 X 10 inch up to A3 and 11 X 17 inch paper.

Table 3-1. **Standard table sizes**

Width (inches)	Length (inches)	Generic name
8.27	11.69	A4
7.17	10.12	JB5
8.50	11.0	USLETTER
8.50	14.0	USLEGAL
16.54	11.69	A3
10.12	14.33	B4
17.0	11.0	17 X 11

Paper weights

The Xerox DocuPrint 180 LPS recommends 16–110 lb (60–200 gsm) paper in simplex mode and 18–110 lb (64–200 gsm) paper in duplex mode.

Types of paper

The following types of paper are supported:

- Predrilled
- Perforated
- Pressure-sensitive labels
- Transparencies
- Precut or full tabs
- Carbonless (Xerox)
- Standard types.

Paper performance guides

The following guides summarize the capabilities of the paper trays, duplex printing considerations, and paper stock considerations.



Note: You may use the adjustable levers to optimize performance when running heavy weight or oversized papers. Refer to the “Problem solving tasks” chapter, “Printing problems” section for information on these levers.

Table 3-2. **Trays 1 and 2 performance guide¹**

Paper	Superior performance	Good performance	Performance limits and suggested alternatives
Size range ²	8 by 10 to 9 by 14 inches/203 by 254 to 229 by 356 mm. Includes: <ul style="list-style-type: none"> • 8.5 by 11 inches • A4 (210 by 297 mm) 		Paper smaller than 8 by 10 inches/203 by 254 mm cannot be used. For paper larger than 9 by 14 inches/229 by 356 mm, refer to the Performance Guide for trays 3, 4, 5 and 6.
Weight range	20 to 110 pounds/80 to 200 gsm	16 to 20 pounds/60 to 80 gsm ³	Weights outside the limits shown are not recommended. Refer to the Paper Stocks Guide later in this chapter for additional information.
Capacity	Tray 1: 1100 sheets, 20 pound/80 gsm paper Tray 2: 600 sheets, 20 pound/80 gsm paper		For greater capacity, use trays 3, 4, 5 and 6 and the Autoswitch feature.
Type or condition	<ul style="list-style-type: none"> • Xerographic paper in good condition • Predrilled stock (fanned thoroughly) • Tab stock (in perfectly flat condition) 	<ul style="list-style-type: none"> • Transparencies • High-speed label stock • Slightly curled paper⁴ • Intermixed weights • Paper with reinforced binding edges 	<ul style="list-style-type: none"> • Excessively curled paper⁵ • Manual two-sided (duplex) prints • Freshly printed offset prints

1. Refer to the Paper stocks guide (table 3-5) for additional information
2. Optional 7 X 10 enablement kit allows 7 by 10 inches/178 by 254 mm paper size.
3. Make sure that heavy weight paper levers (located in areas 2 and 4 of the printer) are in the appropriate position for the weight of paper being used. Refer to the “Prints are skewed” section of the “Problem solving tasks” chapter.
4. Curl direction should be determined before loading paper into trays. Refer to the “Paper jams and paper curl” section of chapter 12, “Problem solving tasks,” for additional information.
5. Curl direction should be determined before loading paper into trays. Refer to the “Paper jams and paper curl” section of chapter 12, “Problem solving tasks,” for additional information.

Table 3-3. **Trays 3, 4, 5 and 6 (or high capacity trays) performance guide¹**

Paper	Superior performance	Good performance	Performance limits and suggested alternatives
Size range ²	8 by 10 to 11.69 by 17 inches/ 203 by 254 to 297 by 432 mm. Includes: <ul style="list-style-type: none"> • 11 by 14 inches • 11 by 17 inches • B4 (250 by 353 mm) • A3 (297 by 420 mm) 		Smaller or larger sizes cannot be used.
Weight range	20 to 110 pounds/80 to 200 gsm	16 to 20 pounds/60 to 80 gsm ³	Weights outside the limits shown are not recommended.
Capacity	Tray 3: 2600 sheets, 20 pound/ 80 gsm paper Tray 4: 2600 sheets, 20 pound/ 80 gsm paper		For greater capacity, use the Autoswitch feature.
Type or condition	<ul style="list-style-type: none"> • Xerographic paper in good condition • Predrilled stock (fanned thoroughly) 	<ul style="list-style-type: none"> • Slightly curled paper⁴ • Manual two-sided (duplex) prints • High speed label stock 	<ul style="list-style-type: none"> • Excessively curled paper⁵ • Curl direction should be determined before loading paper into tray.⁶ • DO NOT use mylar reinforced paper in trays 3, 4, 5 or 6. Hardware damage may result. Use trays 1 or 2.

1. Refer to the Paper stocks guide (table 3-5) for additional information
2. Optional 7 X 10 enablement kit allows 7 by 10 inches/178 by 254 mm paper size.
3. Make sure that heavy weight paper levers (located in areas 2 and 4 of the printer) are in the appropriate position for the weight of paper being used. Refer to the "Prints are skewed" section of the "Problem solving tasks" chapter.
4. Curl direction should be determined before loading paper into trays. Refer to the "Paper jams and paper curl" section of chapter 12, "Problem solving tasks," for additional information.
5. Curl direction should be determined before loading paper into trays. Refer to the "Paper jams and paper curl" section of chapter 12, "Problem solving tasks," for additional information.
6. Curl direction should be determined before loading paper into trays. Refer to the "Paper jams and paper curl" section of chapter 12, "Problem solving tasks," for additional information.

Table 3-4. **Two-sided (duplex) printing performance guide¹**

Paper	Superior performance	Good performance	Performance limits and suggested alternatives
Size range ²	8 by 10 to 11.69 by 17 inches/ 203 by 254 to 297 by 432 mm.		Smaller or larger sizes cannot be used.
Weight range	20 to 110 pounds/80 to 200 gsm ³		Weights outside the limits shown are not recommended. If show through occurs, adjust print quality or use heavier weight paper.
Type or condition	<ul style="list-style-type: none"> • Xerographic paper in good condition • Predrilled stock (fanned thoroughly) 	<ul style="list-style-type: none"> • Slightly curled paper⁴ • Paper with reinforced binding edges • Tabs <p>Refer to the Paper Stocks Guide for additional information.</p>	<ul style="list-style-type: none"> • Excessively curled paper⁵ • Avoid Transparencies <p>Stock not defined here is included in the Paper Stocks Guide, which follows.</p>

1. Refer to the Paper stocks guide for additional information.
2. Optional 7 X 10 enablement kit allows 7 by 10 inches/178 by 254 mm paper size.
3. Make sure that heavy weight paper levers (located in areas 2 and 4 of the printer) are in the appropriate position for the weight of paper being used. Refer to the "Prints are skewed" section of the "Problem solving tasks" chapter
4. Curl direction should be determined before loading paper into trays. Refer to the "Paper jams and paper curl" section of chapter 12, "Problem solving tasks," for additional information.
5. Curl direction should be determined before loading paper into trays. Refer to the "Paper jams and paper curl" section of chapter 12, "Problem solving tasks," for additional information.

Table 3-5. Paper stocks guide

Stock type	Instructions for use
16 pound/60 gsm paper	<ul style="list-style-type: none"> • Load paper with ream wrapper seam side down. If there is no arrow on the ream wrapper, load paper in trays 3, 4, 5 and 6 only, with curl up. • Duplexing 16 lb. paper is not recommended. • Best performance can be expected from trays 3, 4, 5 and 6.
20 pound/80 gsm paper	Load paper with ream wrapper seam down. If there is no arrow on the ream wrapper, load paper in trays 3 and 4 only, with curl up.
65 pound card stock 110 pound/200 gsm paper (index)	Run from any tray.
20 pound or 80 gsm dual- purpose 3-hole drilled 4-hole drilled 7-hole drilled	<ul style="list-style-type: none"> • Load with holes to the RIGHT. • Use the Align task to avoid printing near the holes. • Fan paper thoroughly and check for loose paper plugs prior to loading
Non-tearing 3-hole	<ul style="list-style-type: none"> • Load in trays 1 and 2 only. • Load with holes to the RIGHT. • DO NOT run two-sided (duplex) prints.
Non-tearing	<ul style="list-style-type: none"> • Load in trays 1 and 2 only. • DO NOT run two-sided (duplex) prints.
Xerox carbonless paper	<ul style="list-style-type: none"> • Load paper in trays 3, 4, 5 and 6 only. • Only Xerox carbonless paper is recommended for High speed Xerographic equipment.
3-hole drilled, edge reinforced dual-purpose	<ul style="list-style-type: none"> • Use trays 1 and 2. • Load paper with holes to the right, reinforced side DOWN. • In two-sided (duplex) printing, degraded print quality may occur near the reinforcement. • Leave stock in wrapper until use to achieve maximum stock flatness. • Run with no more than 200 sheets in a tray.¹
Transparencies— Oversized (8.5 by 14 inches, 0.5 inch white stripe/216 by 356 mm, 1 mm white strip)	<ul style="list-style-type: none"> • Load with the white stripe to the RIGHT in trays 1 and 2 (“shiny” side UP for best performance). • Simplex only.
Preprinted stock	<p>Certain types of ink or insufficient drying time may cause the ink to adhere to various machine components and printed sheets. Allow at least 3 hours of drying time before using preprinted stock.</p> <p>CAUTION: Certain preprinted stocks lie unevenly in the feeder trays. If the right side of the stack is higher than the left in trays 3, 4, 5 and 6 SEVERE hardware damage can occur. Load the stock in trays 1 or 2 or load fewer sheets.</p>
Transparencies— Paper-backed, high-speed, removable stripe	<ul style="list-style-type: none"> • High-speed paper-backed transparencies may be run from trays 1 and 2 with paper side DOWN. • Run no more than 50 removable stripe transparencies at one time. • Load the transparencies on top of approximately 50 sheets of paper.

Table 3-5. **Paper stocks guide** (continued)

Stock type	Instructions for use
Tab stock	<ul style="list-style-type: none"> • Load into trays 1 and 2 with tabs to the LEFT. • For best performance, print should be centered on the tab and should not extend to either edge. • Use tab stock in perfectly flat condition. DO NOT use deformed, bent, or damaged tabs.
9-inch cover stock 110 pound/200 gsm	Load into any tray.
High-speed label stock	<ul style="list-style-type: none"> • Load FACE UP. • DO NOT run two-sided (duplex) prints.
Letterhead	<ul style="list-style-type: none"> • Load into trays with side 1 UP and top edge toward the front of the tray (avoid placing the print in line with the feed belt in trays 1 and 2). • Avoid using freshly preprinted paper.
Manual two-sided (duplex) prints	<ul style="list-style-type: none"> • Load into trays with printed side DOWN and top edge toward the front of the tray (avoid placing the print in line with the feed belt in trays 1 and 2). • Print the second side as soon as possible after the first side to prevent wrinkling and excessive curl.
Textured paper	Heavily textured paper may yield prints with ragged character appearance and/or deletions. To test, print a sample sheet.

1. You can order a mylar reinforcement tray which allows a feeder tray to handle up to 500 sheets of this type of stock. Contact your service representative for additional information.

Paper sizing and print jobs

The Xerox DocuPrint 180 LPS feeder trays have edge guide sensors that detect paper length and width. The LPS selects the correct feeder tray(s) for the print job, based on the paper size specified in the job.

- If an exact match is found, the print job proceeds.
- If an exact match is not found, depending on how the job was set up, one of the following occurs:
 - A message appears on the PC UI or system controller display and the printer control console telling you to load different paper or inquiring whether it is permissible to print the job on paper that is larger than specified for the job.
 - The job prints on paper larger than specified for the job.
 - The job is aborted.



Note: The LPS never prints a job on paper known to be smaller than that specified for the job.

If you encounter any problems related to paper sizing, contact your lead operator, systems specialist, or Xerox support specialist

Feeder trays

Your LPS provides six feeder trays:

Two processor feeder trays

Four high-capacity feeder (HCF) trays.

(Refer to the “System overview of the Xerox DocuPrint 180 LPS” chapter for additional information on the available feeder trays.)

Up to six different stocks may be used within a print job, including oversize covers or tabs.



Note: If your LPS is fitted with a bulk feeder, the number of available stocks increases by one.

For instructions on selecting feeder trays and managing clusters (groupings of trays), refer to the “Status and print tasks” chapter.

Feeder tray features

Note the following features of the feeder trays:

- Any tray not currently in use can be opened, pulled out, and loaded, without interrupting printing.
- If you try to open a tray currently in use, feeding switches to a backup tray if one is available. If one is not available, the printer stops.
- The printer does not feed all the paper out of a tray. (A stack of approximately 1/4 inch/6 mm remains in the tray.)

Loading a feeder tray

To load one of the feeder trays.

- Step 1.** Select the tray you want to load by pressing the Tray Unlock button on the paper tray. The Tray Unlock button is shown in figure 3-1. You may also select the tray through the PC UI or the printer mimic on the printer control console. Refer to the “Lower trays and bins” section of the “Status and print tasks” chapter for instructions.



Note: If the printer has stopped due to a low paper condition, you do not need to press the Tray Unlock button.

Figure 3-1. Tray Unlock button

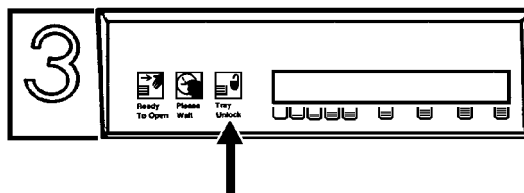

- Step 2.** Wait until the Ready to Open indicator lights (see figure 3-2).

Figure 3-2. Ready to Open indicator

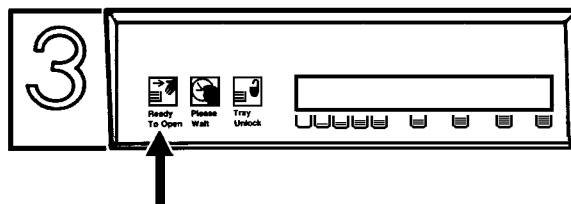

Step 3. Pull the feeder tray out until it stops, as shown in figure 3-3.

Figure 3-3. Pulling out the feeder tray

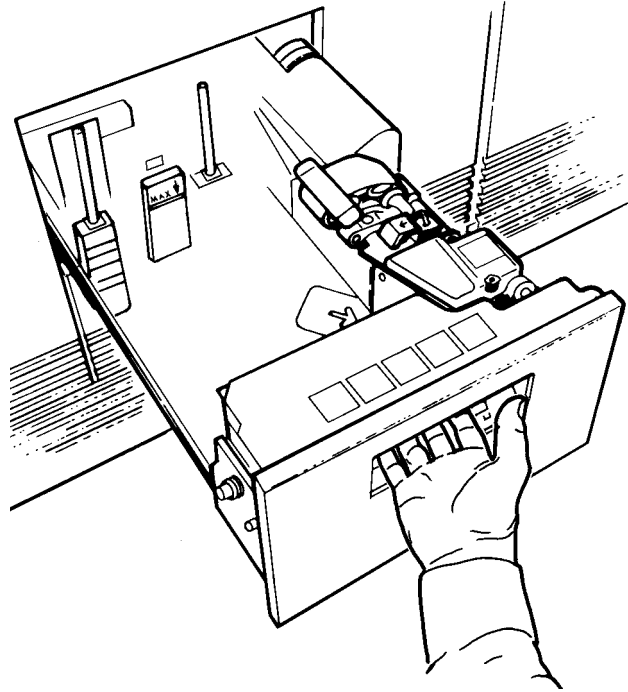

Step 4. Load paper, following the instructions on the label at the front top of the feeder tray. Figure 3-4 shows the location of these instructions.

Figure 3-4. Paper loading instructions

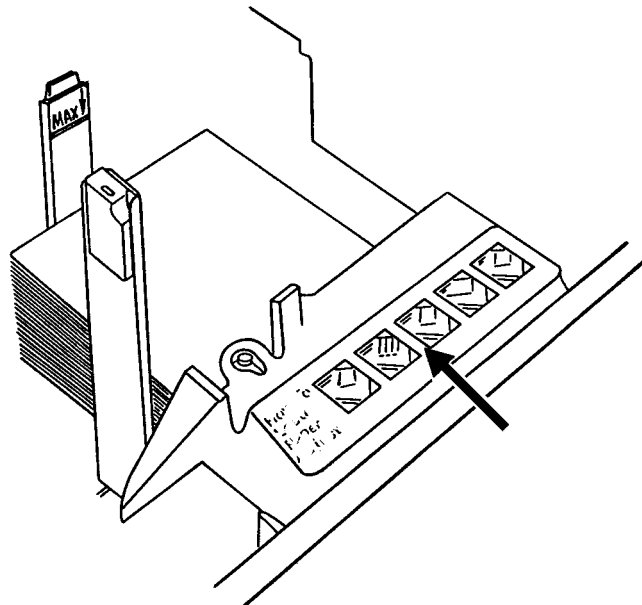

Note: Load transparencies and 9-inch/229-mm tabs into one of the processor feeder trays only.

Remember the following:

- Remove any damaged sheets.
- Load the paper with the package wrapper seam side up.
- For trays 3, 4, 5 and 6 only, load paper with curl side up if paper curl is detected. If no paper curl is detected, load paper with the wrapper seam side down.
- If using tab stock, remove any deformed, bent, or damaged stock.
- If using predrilled paper, fan thoroughly and remove any loose paper plugs
- Ensure the paper is loaded into the front, right corner of the tray, as indicated by the green arrow on the bottom of the tray and by the arrows on the instruction label (see figure 3-5).

Figure 3-5. **Arrows on the bottom of the tray and the instruction label**

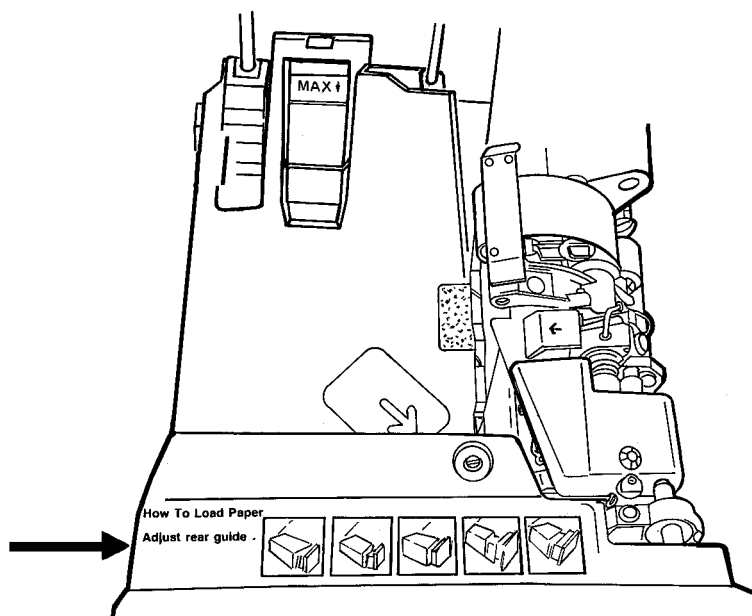

Caution: Do not load above the MAX line shown on the paper guide (see figure 3-6).

Figure 3-6. Max line on the paper guide

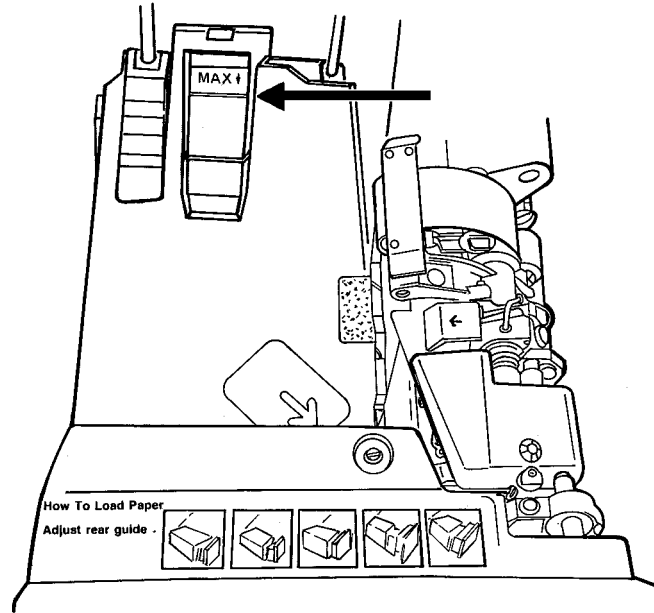

- Step 5.** For the high-capacity feeder trays, adjust the rear and side paper guides to touch the paper stack (see figure 3-7).

Figure 3-7. **High-capacity feeder tray rear and side paper guides**

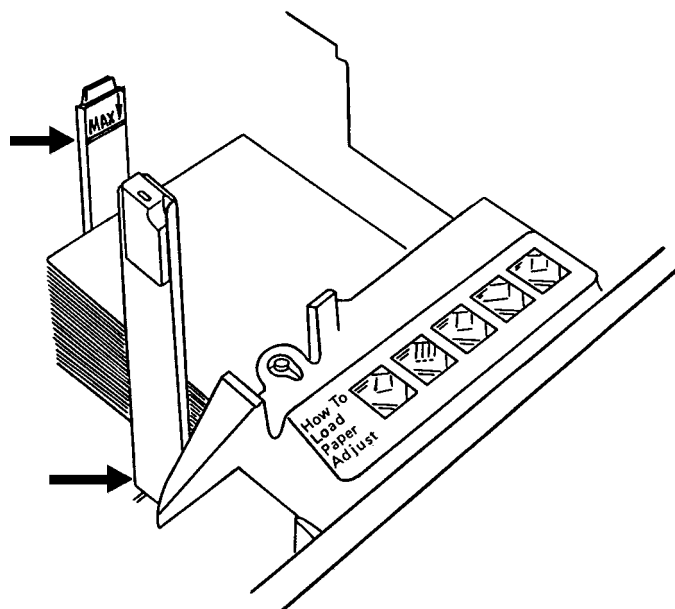

Note: The high-capacity feeder trays give you the option of loading paper with the short edge touching the side paper guide and the long edge touching the rear paper guide. This allows the Xerox DocuPrint 180 LPS to print on larger paper than would fit in the tray the usual way (that is, with the long edge touching the side paper guide and the short edge touching the rear paper guide). The way you load the paper in the high-capacity feeder trays depends on the paper size required by the job. (Refer to figures 3-8 and 3-9.) Refer to the *Xerox DocuPrint 180 LPS Operations Reference* for size considerations for short edge feed (SEF).

Figure 3-8. Paper loaded normally (for example, 7 by 10 inches/178 by 254 mm)

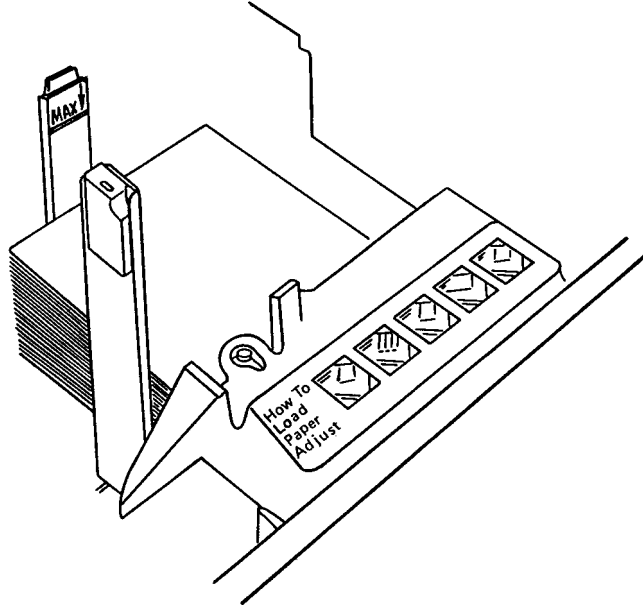
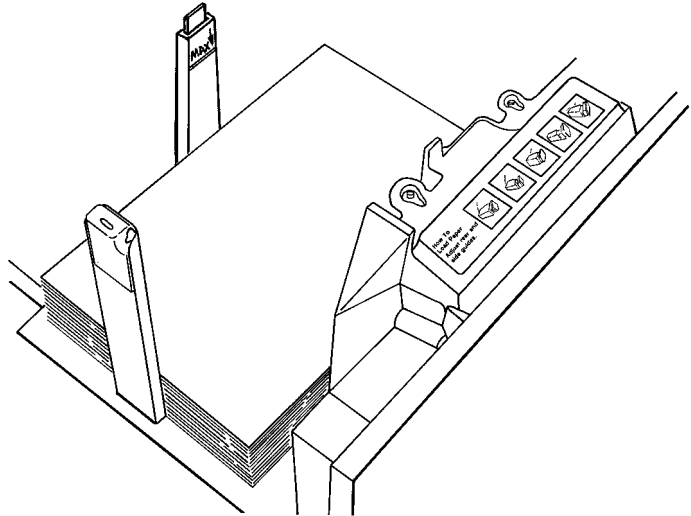
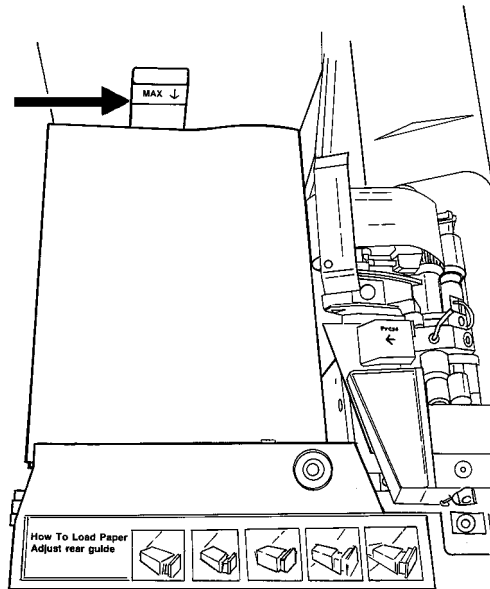

Figure 3-9. Paper loaded with the short edge to the left (for example, 11 by 17 inches/279 by 432 mm)



- Step 6.** For the processor feeder trays, adjust the rear guide until it touches the paper stack (see figure 3-10).

Figure 3-10. Rear guide of the processor feeder tray



- Step 7.** Relatch the paper feeder assembly by pressing the green dot (shown in figure 3-11) until the assembly clicks into place.

Figure 3-11. Relatching the paper feeder assembly

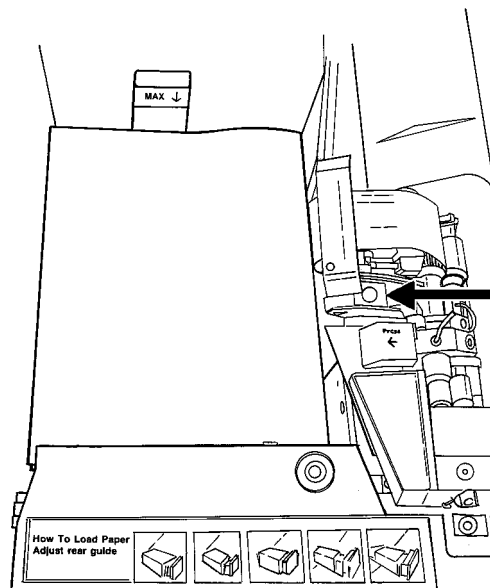

Step 8. Push the tray in, slowly but firmly, until it latches.



Caution: Do not slam the tray closed, as this can cause improper latching or machine damage.

Step 9. If the printer stopped due to a low paper condition, press the Continue button on the printer control console to resume the print job.

Stacker bins

The Xerox DocuPrint 180 LPS can have up to four high-capacity stacker (HCS) bins. (Refer to the “System overview of the Xerox DocuPrint 180 LPS” chapter for additional information on the high-capacity stacker bins.)

- You can lower, pull out, and unload any bin not currently in use, without interrupting printing, as long as another HCS is ready to receive paper.
- If you select a bin that is in use, the printer begins stacking in the next defined high-capacity stacker bin if it is available. If no stacker bin is available, printing stops.
- Once a sheet is delivered to a stacker bin, each subsequent sheet must be within 25 mm of each dimension of the first sheet.

Refer to table 3-6 for additional information on performance of the high-capacity stacker bins.

Table 3-6. **Stacker bin performance guide**

Paper	Superior performance	Good performance	Performance limits and suggested alternatives
Size range ¹	8 by 10 to 11.69 by 17 inches/203 by 254 to 297 by 432 mm		Smaller or larger sizes cannot be used.
Weight range	20 to 110 pounds/80 to 200 gsm	Lighter than 20 pounds/80 gsm and no lighter than 16 pounds/60 gsm	Weights outside the limits shown here are not recommended.
Capacity			<ul style="list-style-type: none"> • Capacity automatically limited so stack weight will not exceed 30 lbs/13.g kg • Selectable with bin capacity programming (Refer to the “Bin full criteria and setting bin limits” section of the “Status and print tasks” chapter for instructions.
Stack quality	<ul style="list-style-type: none"> • Xerographic paper in good condition • 20 pound/80 gsm and heavier stock • Very low to no output curl 	<ul style="list-style-type: none"> • Lighter weight stocks with low output curl • Intermixed stocks 	<ul style="list-style-type: none"> • Adjust process decurler • Flip paper in paper feeders • Limit stack capacity to acceptable limits.

Table 3-6. **Stacker bin performance guide** (continued)

Paper	Superior performance	Good performance	Performance limits and suggested alternatives
Type or condition	<ul style="list-style-type: none"> Xerographic paper in good condition Predrilled stock No cut-outs, perforated or intermixed weights 	<ul style="list-style-type: none"> Labels, preprinted forms, perforated stocks Intermixed weights 	<ul style="list-style-type: none"> High output curl stocks can cause severe stack quality problems Tab stock intermixed with smaller stocks results in degraded stack quality Reinforced mylar should be limited to small stacks of 200 sheets or less or sent to the sample tray

1. Optional 7 X 10 enablement kit allows 7 by 10 inches/178 by 254 mm paper size.

Unloading a stacker bin

To unload a stacker bin:

- Step 1.** Select a bin for unloading by pressing the Bin Unload button on the bin control panel. Figure 3-12 shows the Bin Unload button. You can also select the bin for unloading through the PC UI or the printer mimic of the printer control console. Refer to the “Lower trays and bins” section of the “Status and print tasks” chapter for instructions.

Figure 3-12. **Bin Unload button**

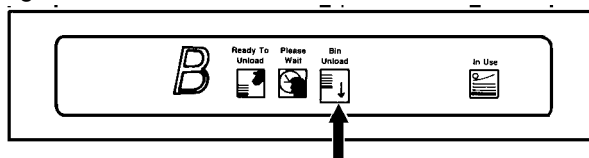

- Step 2.** Once a bin is selected, the bin elevator lowers.



Note: Once the bin elevator lowers, the bin cannot be used until it is emptied completely.

- Step 3.** When the bin elevator stops in the down position, the Ready to Unload indicator lights (see figure 3-13).

Figure 3-13. **Ready to Unload indicator**

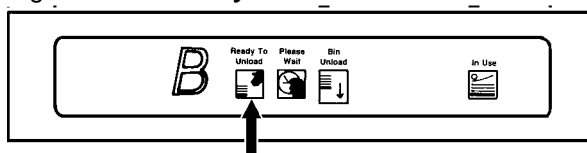

- Step 4.** Open the bin doors, pull the platform out until it stops, and lift the container, pallet (for "pallet only" stacking), or paper stack off the platform (see figure 3-14).



Caution: Always use both hands to lift a container or pallet out of the bin.

Figure 3-14. **Stacker bin and container**

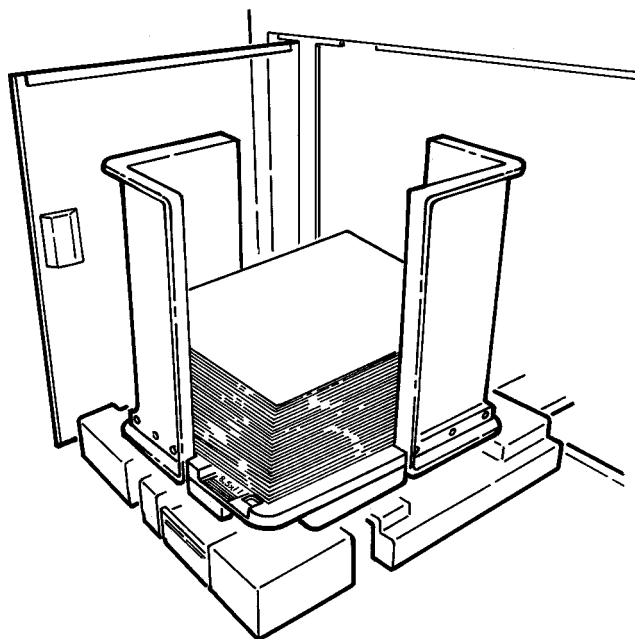

- Step 5.** Carry the loaded container, pallet, or paper stack to a nearby table or paper cart.

Step 6. If you are using a container or pallet, empty it and return it to the stacker bin.



Note: An empty container or a pallet must be in place if the bin is set for container stacking.

Note the following facts regarding the container:

- The empty container must be the same size as the previous container if the bin is in an auto switching combination or if the print job is not complete and stacking will continue into the bin.
- A different size container may be used if the bin is not selected for use or is not in an auto switching combination.
- To switch from containerless stacking to stacking into a container or onto a pallet (for “pallet only” stacking), press and release the green button on top of the stacker bin platform (see figure 3-15).

Figure 3-15. **Green button**

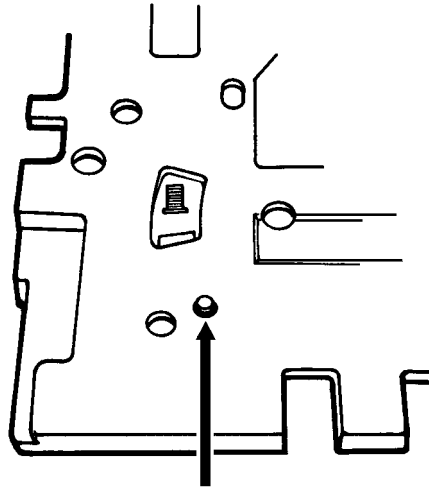

- To switch from stacking into a container or pallet to containerless stacking, slide the green tab (located on top of the stacker bin platform) forward until you hear a click. Figure 3-16 shows the green tab location.

Figure 3-16. **Green tab**

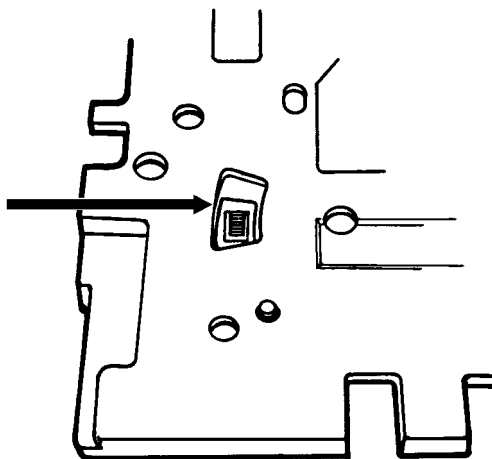

- Step 7.** Firmly push the platform back to its original position and close the bin doors. The bin elevator rises, and the bin is again ready for use.



Note: If the bin is not empty, the elevator remains down, and a message appears on the printer control console and the PC UI or system controller display telling you to empty the bin.

Sample tray and purge tray

This section describes the sample and purge trays of the Xerox DocuPrint 180 LPS.

Sample tray

Samples requested during operation of the LPS are delivered to the sample tray. The sample tray can hold up to 100 sheets. It can handle paper sized from 8 by 10 inches/203 by 254 mm to 11.69 by 17 inches/297 by 432 mm.

Note the following:

- Optional 7 X 10 enablement kit allows paper sized from 7 by 10 inches/178 by 254 mm to 14.33 by 17 inches/364 by 432 mm.
- Since the sample tray can receive waste sheets purged after a paper jam, always clear the sample tray after clearing a jam. This prevents waste sheets from being confused with good sample sheets.
- No message appears when the sample tray is full. Since a paper jam can occur if the tray is overfilled, empty the sample tray regularly, if it is in use.

Purge tray

Aborted sheets (that is, sheets damaged during printing or cleared before or after a paper jam) are sent to the purge tray. The purge tray can hold up to 100 sheets. It can handle paper sized from 8 by 10 inches/203 by 254 mm to 11.69 by 17 inches/297 by 432 mm.

Note the following:

- Optional 7 X 10 enablement kit allows paper sized from 7 by 10 inches/178 by 254 mm to 14.33 by 17 inches/364 by 432 mm.
- No message appears when the purge tray is full. Since a paper jam can occur if the tray is overfilled, empty the purge tray at least once a day.
- Sheets may be purged before, during, or after print jobs.
- Sheets are sent to the purge tray following a fuser area jam. The sheets purged at that time clean the fuser area, ensuring good print quality for your subsequent jobs.

4. System control tasks

Where applicable, instructions are given for accomplishing the tasks using either the windows of the PC UI or keyed-in commands. Refer to the list below for the tasks described in this chapter:

- System control tasks through windows of PC UI
- System control tasks through command line
- Power on the LPS
- Power off the LPS
- Boot the LPS
- System rollover
- System version
- Attention light/alarm
- Turn off Attention light
- Energy saver
- Console log (through windows)
- Problem
- Audit log (through windows)
- Exit to DOS (through windows).

System control tasks through windows of PC UI

To select system control tasks using the windows of the PC UI:

Step 1. Open the System Control menu icon.

The System Control menu window appears (see figure 4-1), listing the available options.

Figure 4-1. **System Control menu window**

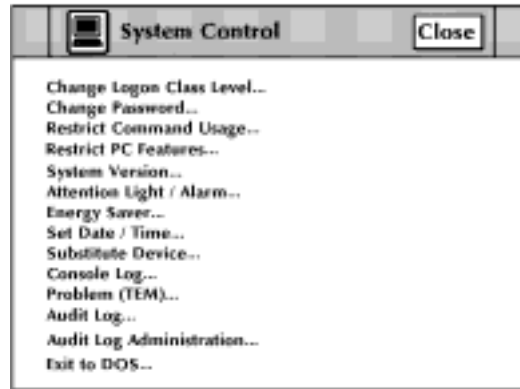

Step 2. Turn to the section of this chapter which explains the task in which you are interested.



Note: This chapter covers operator related tasks only. For information on any of the options not covered in this chapter, refer to the *Xerox DocuPrint 180 Laser Printing System PC User Interface Reference*.

System control tasks through command line

You can perform system control tasks by entering commands either:

- Through the Messages window of the PC UI
- Through the system controller terminal (non-U.S. markets only).

To enter commands through the Messages window of the PC UI:

Step 1. Place the cursor in the window.

Step 2. Click once with the left mouse button.

Step 3. Enter the command.

If you are using the system controller terminal, use the keyboard to enter the command.

System control tasks

The following sections contain instructions for performing specific system control tasks.

Power on the LPS

Use this task to start the LPS:

- Step 1.** Press the Local button on the operator control panel (see figure 4-2), unless otherwise instructed.

Figure 4-2. Local button on operator control panel

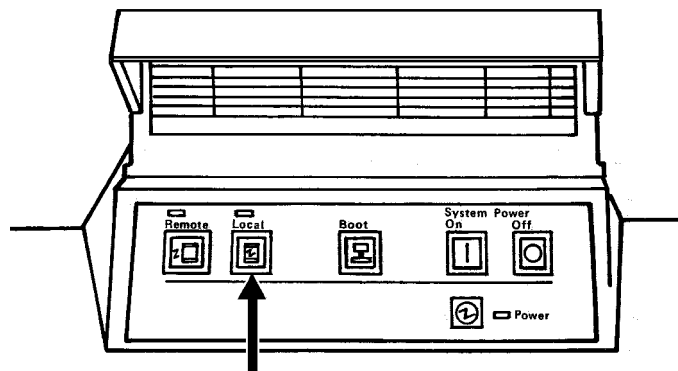

- Step 2.** Press the System Power On button on the operator control panel (see figure 4-3).

Figure 4-3. System Power On button on operator control panel

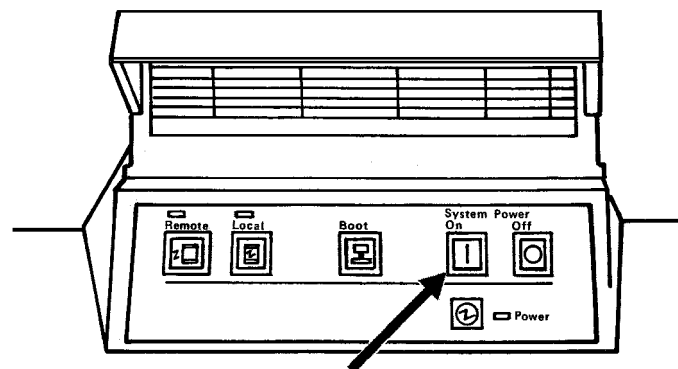

The Power indicator lights.

- If you have the PC UI, the desktop appears.
- If you have the system controller/keyboard display, READY \$ appears on the display.

Power off the LPS

If no one is using the LPS for more than eight hours, power it off. For idle times of less than eight hours, the LPS has a built-in energy saver feature that can be adjusted to conserve energy and machine parts. (Refer to the “Energy saver” section later in this chapter for additional information.)

When LPS is in online mode To power off the LPS if you are running online to a host computer:

- Step 1.** Contact the host system operator and request that the output from the host to the LPS be drained and the LPS be varied offline at the host.
- Step 2.** Press the <JOBS STATUS> key or check the status display on the PC UI desktop to ensure the system is idle (that is, not processing print jobs or performing nonprinting tasks).
- Step 3.** If the job queue is not empty: Use either the Endjob or Drain tasks to print any pages remaining in the print file. Press the <JOBS STATUS> key or check the status display on the PC UI desktop, again, to ensure the job queue is empty.
- Step 4.** Do one of the following:
- If you have the PC UI, either select the Offline button in the Start window or enter OFFLINE in the Messages window.
 - If you have the system controller terminal, enter the OFFLINE command.
- Step 5.** Do one of the following:
- Enter the CONTINUE I command.
 - Select CONTINUE I from the I/O window.
 - Press the Continue button on the printer control console.
 - Press the <CON> key, <F2>, on the keyboard.
 - Select CONTINUE from the header button of the Messages window.



Caution: Failure to have the LPS offline prior to powering off causes problems with the host system.

- Step 6.** When the LPS is offline, press the System Power Off button on the operator control panel (see figure 4-4).

Figure 4-4. **System Power Off button on operator control panel**

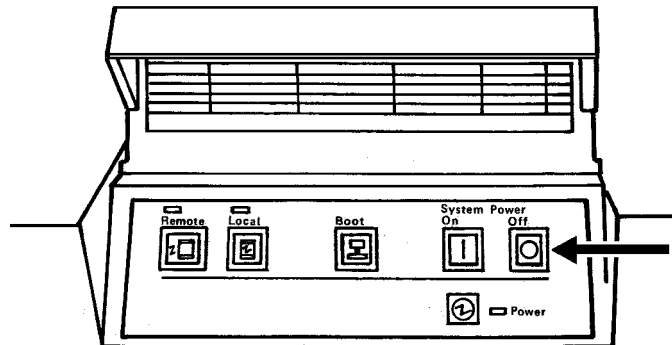

When the LPS is in offline mode To power off the LPS if you are running offline:

- Step 1.** Press the <JOBS STATUS> key or check the status display on the PC UI desktop, to ensure the system is idle.
- Step 2.** Unload the tape or cartridge. (Refer to "Offline printing tasks" chapter for instructions on unloading tapes and cartridges.)



Caution: If a tape or cartridge is loaded when the LPS is powered off, data on the tape or cartridge may be destroyed.

- Step 3.** Press the System Power Off button on the operator control panel. (Refer to figure 4-4.)

Boot the LPS

Use this task to select a boot source and start low-level system testing:

- If your LPS has the autoboot option, the system controller automatically begins booting the printer operating system when the LPS is first powered on.
- If your LPS does not have the autoboot option, the Boot menu is displayed automatically on the PC UI after the LPS is powered on. For the system controller terminal option (non-U.S. markets only), you boot the LPS through commands entered at the keyboard.

Boot the LPS task through PC UI

Figure 4-5 shows the Boot Menu window. The menu displays the boot options.

Figure 4-5. **Boot menu window**

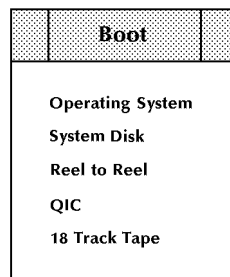

Note: If you need to reboot the LPS, press the Boot button on the operator control panel to display the Boot menu. Figure 4-6 shows the Boot button on the operator control panel.

Figure 4-6. **Boot button on the operator control panel**

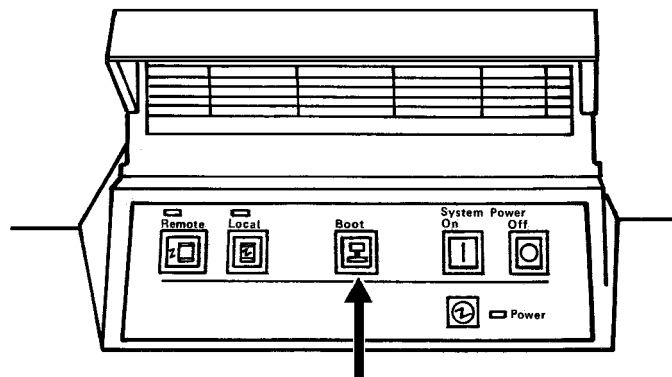

Select the option you want to use from the following:

- **Operating System.** Select this option to boot the LPS from the system disk.
- **System Disk.** Select this option to access TEM. You can then perform various system tasks, including SYSGEN.
- **Reel to Reel.** Select this option to boot the LPS from the open-reel tape drive. This option switches you to TEM.

- **QIC.** Select this option to boot the LPS from the 1/4 inch cartridge tape drive. This option switches you to TEM.
- **18/36 Track Tape.** Select this option to boot the LPS from the 18/36 track cartridge tape drive.

The full desktop appears after the system boot is completed.

Boot the LPS task through system controller terminal (non-U.S. markets only)

To boot the LPS from the system controller terminal, follow this procedure:

- Step 1.** Press for BOOT on the keyboard to load the operating system software (OSS).



Note: The operating system software must be loaded before the system can finish the warm-up cycle.

When loading is complete, the following messages appear on the system controller display:

```
LOADING PROGRAM.....
XEROX [PRODUCT ID]
LASER PRINTING SYSTEM
VERSION X REVISION Y
DISK ID: [Thirty-character-ID-record]
ENTER DATE:MM:DD:YY
```

- Step 2.** Key in the date, using numerals. You may use a space, a colon (:), or a slash (/) between the month, day, and year. Once you have entered the date, a written version is displayed, that is, 1/23/98 becomes January 23, 1998.

- Step 3.** Next you are asked to enter the time.

```
ENTER TIME (HH:MM:SS)
```

Enter the time, using the military 24-hour system. (For example, 2:30 p.m. is 14:30.) The date and time are displayed with the following message:

```
ARE THE DATE AND TIME CORRECT AS DISPLAYED (Y/N)?
```

- Step 4.** Press <Y> if they are correct.

If either is incorrect, enter <N> and reenter the date and time correctly.



Note: You are not always asked to enter the date and time.

Step 5. You are asked if you want the time displayed in the upper right corner of the screen and a constant update of the system's status.

LOAD AND ENABLE TIME-OF-DAY/STATUS DISPLAY (Y/N)?

In most cases, you should press <Y> for yes. If you do so, the system keeps you informed of the time and status. If you want to disable this feature at a later time, enter TIME OFF. To reenale it, you need only enter TIME ON.

If <N> is entered, you cannot add the time/status display without rebooting the system.

Allow four to seven minutes for the printer to complete its warm-up. When the printer is ready, a tone sounds, and the following message appears:

READY---JOB START WILL BE DELAYED 40-80 SECONDS FOR PRINT QUALITY ADJUSTMENT



Note: Before the LPS starts printing, the system checks print quality and controls. Any adjustments, if necessary, are made by the system to give you the best quality prints. The system also checks print quality on an ongoing basis and may stop printing, correct a quality problem, and resume where it left off.

System rollover

A system rollover is a recovery technique the LPS uses to initiate a restart following a system error. This error may be induced by either a software or hardware failure.

System rollover message through PC UI

A message appears in the Messages window of the PC UI telling you that the system has rolled over and processing has stopped.

If the LPS was running online at the time of the rollover, the information window shown in figure 4-7 appears.

Figure 4-7. **Information window (system rollover)**

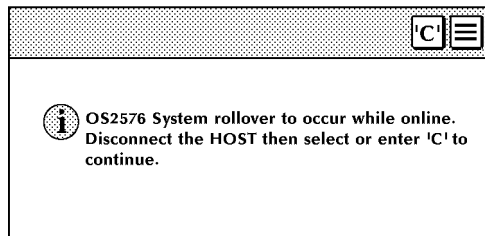

Perform the following steps:

Step 1. Vary the LPS offline from the host and either select the 'C' header button or enter "C" in the Messages window. Another message appears telling you that the system is reloading the software.

- Step 2.** After the software is reloaded, the confirmation window shown in figure 4-8 appears, asking if abort data should be printed for later analysis.

Figure 4-8. **Confirmation window (print abort data)**

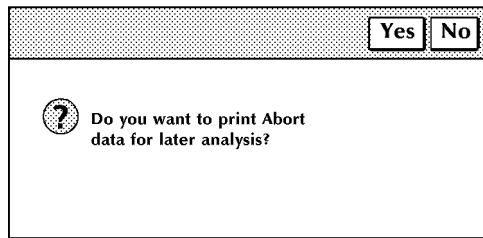

- Step 3.** Select Yes or No, as appropriate.
- Step 4.** Another confirmation window appears (see figure 4-9) asking if you want to recover jobs.

Figure 4-9. **Confirmation window (auto job recovery)**

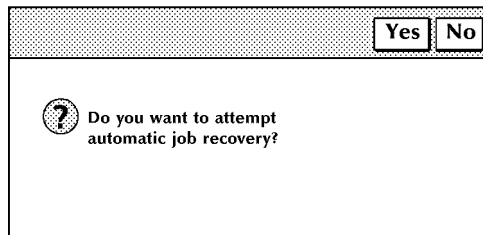

- Step 5.** Select Yes or No, as appropriate.

System rollover message through system controller terminal (non-U.S. markets only)

If you are running the printer online, the system controller display shows the following message:

```
OS2575 SYSTEM ROLLOVER. VARY OFFLINE FROM HOST.  
ENTER 'C'
```

Perform the following steps:

- Step 1.** Enter "C" to initiate the recovery procedure. With either online or offline mode, the following messages are displayed:
- ```
SYSTEM RECOVERY FROM ##### ABORT
PRINT ABORT DATA FOR LATER ANALYSIS Y/N?
```
- Step 2.** Press <Y> for yes. PRINT REQUEST WILL BE QUEUED is displayed. You are asked to verify date and time, and the following messages are then displayed for online mode:
- ```
DO YOU WANT TO ATTEMPT AUTOMATIC JOB  
RECOVERY? ('Y' OR 'N')  
OS1061 INITIALIZING CSI
```
- Step 3.** Press <Y> for yes. The system rollover causes the LPS to go offline. After the system rollover, the following messages are displayed:
- ```
OS0030 SYSTEM IS 'ONLINE'
OS2960 BACK UP HOST TO START OF REPORT
OR n PAGES, WHICHEVER IS LESS
OS2035 INPUT STOPPED. ENTER 'CONTINUE I' WHEN
HOST IS READY
```
- Step 4.** The system automatically goes back online. Enter CONTINUE I to resume printing. Any of the following messages may be displayed, depending on the status of the system before the system rollover:
- ```
OS0010 RESUMING INPUT  
OS0020 RESUMING OUTPUT  
OS1650 OUTPUT PROCESSING HAS CAUGHT UP WITH  
INPUT PROCESSING  
OS4650 INPUT HAS RECOVERED TO PAGE BOUNDARY  
OS4651 OUTPUT HAS RECOVERED TO PAGE  
BOUNDARY
```
- Printed output to be given to the analyst is generated after completion of the job in progress. It follows the message:
- ```
OS1030 JOB ##### HAS COMPLETED PRINTING
PERFORMING ABORT ANALYSIS DUMP
OS0040 SYSTEM IS OFFLINE
```
- Step 5.** Enter the ONLINE (for online mode) and START commands to resume normal operation.

## System version

Use this task to display the system version number, the disk ID, the PC UI version number, and the current logon level.

**System Version task through windows** Perform the following steps:

- Step 1.** Select "System Version" from the System Control menu to open the System Version window (see figure 4-10).

Figure 4-10. **System Version window**

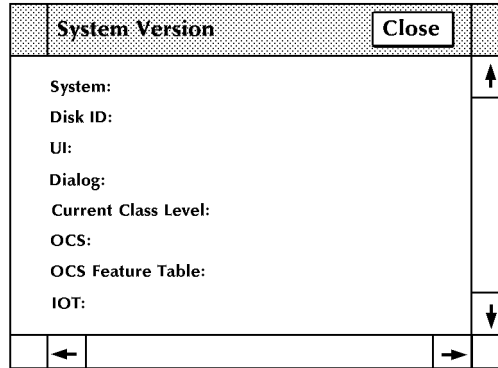

- Step 2.** Select the Close button to close the window.

### System Version task through command line

Enter the following command:

**OCS**



**Note:** The PC UI and Dialog versions do not appear when you enter this command.

## Attention Light/Alarm

Use this task to enable or disable the Attention light and/or alarm.

The Attention light can be enabled or disabled for either or both modes—steady and flashing. If, for example, you disable the steady mode of the Attention light, but leave the flashing mode enabled, the Attention light does not go on when a condition such as low dry ink occurs (and the corresponding Hint icons do not appear on the PC UI or the printer control console), but the Attention light still flashes when the printer stops due to a fault (and the corresponding Fault icons still appear on the PC UI and the printer control console).

### Attention Light/Alarm task through windows

Perform the following steps:

- Step 1.** Select “Attention Light/Alarm” from the System Control menu to open the Attention Light/Alarm window.

Figure 4-11. Attention Light/Alarm window

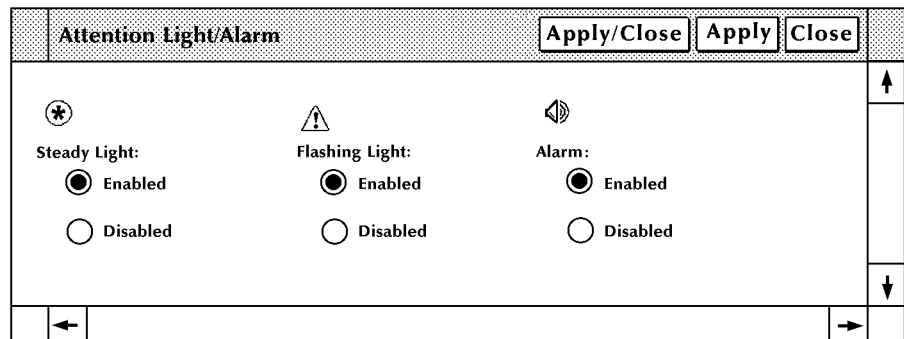

- Step 2.** Select the appropriate Enabled button to enable the:

- Steady Attention light
- Flashing Attention light
- Alarm.

Select the appropriate Disabled button to disable the:

- Steady Attention light
- Flashing Attention light
- Alarm.

- Step 3.** Select the appropriate header button:

- **Apply/Close.** Apply your selection and close the window.
- **Apply.** Apply your selection.
- **Close.** Close the window.



**Attention Light/Alarm task  
through command line**

To enable the Attention light, enter the following command:

**ATTENTION LIGHT ENABLE [STEADY | FLASHING]**

Table 4-1 lists each parameter and its description.

Table 4-1. **ATTENTION LIGHT ENABLE command parameters and descriptions**

| Parameter | Description                                            |
|-----------|--------------------------------------------------------|
| STEADY    | Enables only the steady mode of the Attention light.   |
| FLASHING  | Enables only the flashing mode of the Attention light. |

To disable the Attention light, enter the following command:

**ATTENTION LIGHT DISABLE [STEADY | FLASHING]**

Table 4-2 lists each parameter and its description.

Table 4-2. **ATTENTION LIGHT DISABLE command parameters and descriptions**

| Parameter | Description                                             |
|-----------|---------------------------------------------------------|
| STEADY    | Disables only the steady mode of the Attention light.   |
| FLASHING  | Disables only the flashing mode of the Attention light. |

To enable the alarm, enter the following command:

**ATTENTION ALARM ENABLE {0-10}**

**0-10** Sets the tone volume for the alarm. 0 is softest, 10 is loudest volume.

To disable the alarm, enter the following command:

**ATTENTION ALARM DISABLE**

## Turn off Attention light or alarm

---

Use this task to turn off the Attention light. Neither the steady nor flashing modes of the Attention light operate, and the Hint and Fault icons do not appear on the PC UI and the printer control console. When the next fault condition occurs, the Attention light and appropriate icons appear again.

### Turn off Attention Light task through windows

Select the appropriate Disabled button(s) as follows:

#### **Steady Light:**

Select this button to disable the Steady Attention light located on top of the printer.

#### **Alarm:**

Select this button to disable the audible alarm.

#### **Flashing Light:**

Select this button to disable the Flashing Attention light located on top of the printer.

### Turn off Attention Light task through command line

Enter the following command:

**ATTENTION ALL OFF**

## Energy saver

---

To conserve energy and prolong the life of some of its critical parts, the LPS was designed with a power saver mode. After a predetermined period of inactivity, portions of the printer are shut down. The time-out period is factory set, but it can be readjusted.

Heating and cooling are the most costly uses of electricity. Therefore, maintaining the system at full temperature while idle is not cost effective. After four hours of inactivity (or whatever time period you set), the fusing system shuts down. Once it cools down, it requires the same four- to seven-minute warm-up time as if the system had been turned off.

Use the Energy Saver task to readjust the time-out period. The energy saver timer starts whenever the printer stops.

### Energy Saver task through windows

Perform the following steps:

- Step 1.** Select "Energy Saver" from the System Control menu to open the Energy Saver window (see figure 4-12).

Figure 4-12. **Energy Saver window**

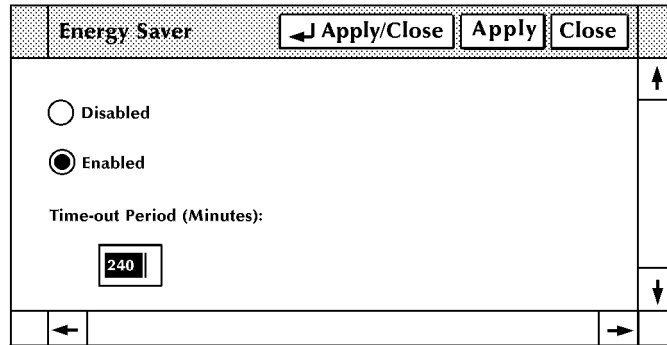

Select the Disabled button to turn off the energy saver mode, or select the Enabled button to turn on the energy saver mode.

- Step 2.** If the Enabled button is selected, the Time Out Period appears. Enter the number of minutes in the Time Out Period field. The smallest number that can be entered is 10, the largest is 65,535.
- Step 3.** Select the appropriate header button:
- **Apply/Close.** Apply your selection and close the window.
  - **Apply.** Apply your selection.
  - **Close.** Close the window.

#### Energy Saver task through command line

To adjust the time-out period, enter the following command:

**ENERGY [timeout]**

Table 4-3 lists the parameter and its description.

Table 4-3. **ENERGY command parameter and description**

| Parameter      | Description                                                                                                                     |
|----------------|---------------------------------------------------------------------------------------------------------------------------------|
| <i>timeout</i> | The number of minutes after which the energy saver mode begins. If you do not enter a value, the current timeout value appears. |

## Set date/time

Use this task to set the system date and time. The system must be idle when you perform this task. (Idle means not printing, offline, and not performing any non-printing tasks.)



**Note:** You must be at logon level 2 to use this task.



**Note:** The hours field is specified in military time, that is, 0—23, with 0 signifying midnight.

### Set Date/Time task through windows

Perform the following steps:

- Step 1.** Select “Set Date/Time” from the System Control menu to open the Set Date/Time window.

Figure 4-13. Set Date/Time window

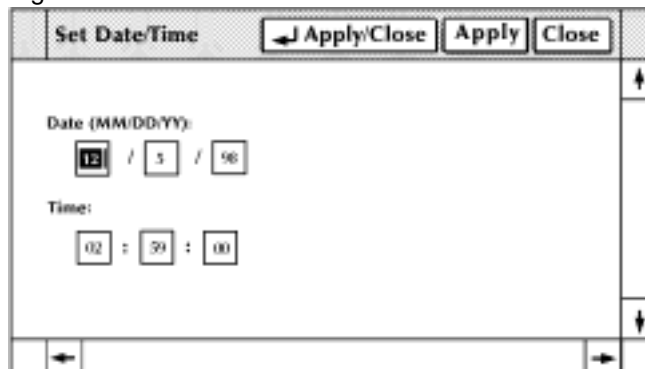

**Note:** When you set the time backwards, the chronological sequence of records in the console log is no longer valid. Save and empty the console log. (Refer to the “Console log” section, which follows.)

- Step 2.** The current value of date and time appear in the fields. If incorrect, enter the correct value in the input fields as follows:
- Date is entered in Month/Day/Year order.
  - Time is entered in Hours:Minutes:Seconds order.
- Step 3.** Select the appropriate header button:
- **Apply/Close.** Apply your selection and close the window.
  - **Apply.** Apply your selection.
  - **Close.** Close the window.

**Set Date/Time task through  
command line**

Enter the following command:

**SET TIME *mm/dd/yy hh:mm:ss***

You can separate the numbers in the date with a slash (/), a dash (—), or a space. You can use the numbers from 1 to 12 for the months or the following abbreviations: JAN, FEB, MAR, APR, MAY, JUN, JUL, AUG, SEP, OCT, NOV, DEC.

You can separate the numbers in the time with a colon (:) or a space. Entering the seconds is optional; the system assumes :00 if you do not enter the seconds.

Because the command is designed to allow you to change either the time, the date, or both, you do not enter commas for missing elements when setting only one of them. To change only the time, for example, enter:

**SET TIME 10:27**

## Console log

Use this task to display, print, save, or empty the current console log or to display, delete, or print a saved console log from the PC UI hard disk. This task also allows you to convert the console log to another file format, such as ASCII. The console log allows you to review system information that can help you determine the reason and any actions to take when the DocuPrint180 LPS appears to have a problem. The following items are contained in the console log:

- All commands sent to the system controller
- All messages received from the system controller
- PC UI internal messages
- Dialog messages
- Debug information.

**Console Log task through windows** Perform the following steps:

- Step 1.** Select “Console Log” from the System Control menu to open the Console Log window (see figure 4-14).

Figure 4-14. **Console Log window**

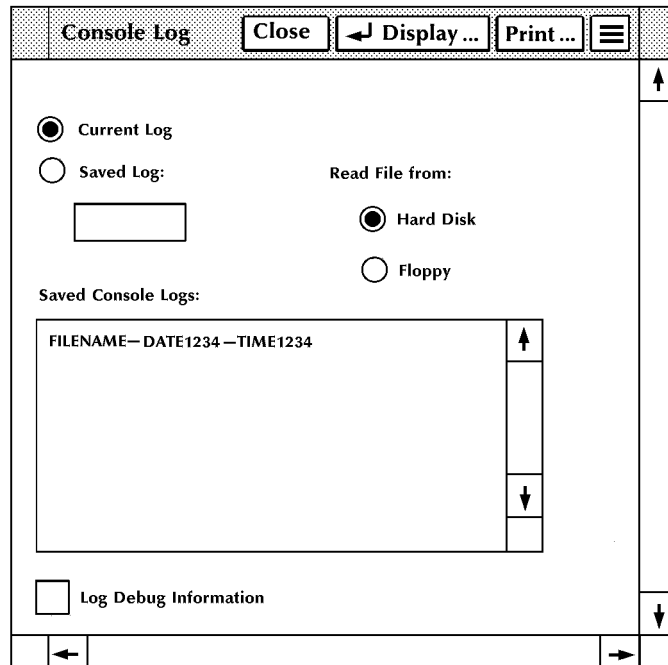

**Step 2.** The Console Log window gives you the following options:

- Displaying the current or a saved console log
- Printing the current or a saved console log
- Stopping the printing of a console log
- Saving the current console log
- Emptying the current console log
- Deleting a saved console log
- Requesting that log debug information be written to the current console log
- Converting the console log to another file format.

The following sections describe the procedures for these tasks.

## Displaying a console log

To display a console log:

**Step 1.** You can select either a saved or the current console log

To select a saved console log, select the Saved Log button and the log's file name from the Saved Console Logs field. You can use the scroll bars to display additional log names. Once you select a file name, it appears in the Saved Log field.

You can enter a saved console log file name directly into the Saved Log field.



**Note:** The logs that appear in the Saved Console Logs field are determined by the Read File From field. The default selection for this field is Hard Disk. This means that the logs displayed are saved on the PC UI hard disk. To display logs saved on a floppy disk, insert a floppy disk in the floppy drive and select the Floppy button.

To select the current console log, select the Current Log button. This is the default selection of the window.

**Step 2.** Select the Display header button to open the Display Console Log window (see figure 4-15).

Figure 4-15. Display Console Log window

**Step 3.** The following options allow you to select the type of information that appears in the displayed console log:

- **Complete.** If you select this button, the log display contains error, warning, and command logs sent to the system controller, including power on messages.
- **Condensed.** If you select this button, the log display contains error, warning, and command logs.
- **Errors.** If you select this button, the log display contains messages indicating a condition that prevents printer operation.
- **Warnings.** If you select this button, the log display contains messages warning of pending problems, but does not indicate that the printer has stopped.



- **Commands.** If you select this button, the log display contains all operator-initiated task or feature requests.
- **Debug.** If you select this button, the log display contains the complete log along with debug messages.
- **Start Date.** Use this field to select the starting month, day, and year for the console log display.
- **Start Hour.** Use this field to select the starting hour for the console log display.

**Step 4.** Select either:

- **Display.** Apply your selection and open the Console Log Display window.
- **Close.** Close the Display Console Log window.

**Step 5.** If you select Display, the Console Log Display window appears (see figure 4-16). It contains the information you selected.

Figure 4-16. **Console Log Display window**

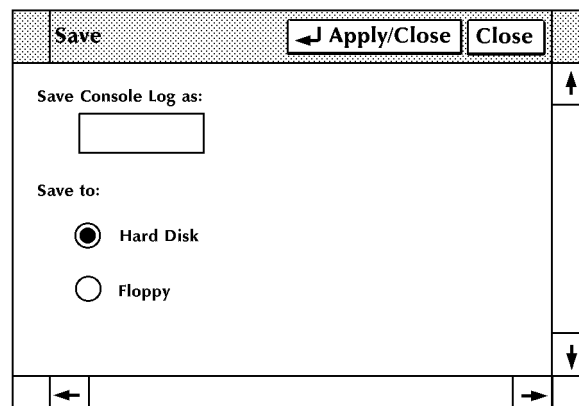

When using the floppy, the following message will appear at the bottom of the screen:

Insert Floppy before selecting "Apply/Close."

**Step 6.** Select the Close header button to close the Console Log Display window.

## Printing a console log

To print a console log:

- Step 1.** Follow the procedure described in step 1, a-b, of the “Displaying a console log” section earlier in this chapter.
- Step 2.** Select the Print header button to open the Print Console Log window.

Figure 4-17. **Print Console Log window**

- Step 3.** Follow the procedure described in step 3 of the “Displaying a console log” section earlier in this chapter. Note that for printing a console log, step 3 includes a “Duration” option. This option allows you to define the number of hours after the start hour for which to print console log entries.
- Step 4.** Select the appropriate header button:
- **Apply/Close.** Apply your selection and close the Print Console Log window.
  - **Apply.** Apply your selection.
  - **Close.** Close the window.
- Step 5.** If you select Apply/Close or Apply, a confirmation window appears (see figure 4-18).

Figure 4-18. **Confirmation window (Print option)**

- Step 6.** Select Yes to print the console log, or select No to cancel the print request.

## Stopping the printing of a console log

To stop the printing of a console log, select the Stop Print header button. If the console log has already started printing, use the <STOP> key to stop printing.

## Saving the current console log

To save the current console log:

- Step 1.** Select the “Save” option from the header auxiliary menu of the Console Log window to open the Save window (see figure 4-19).

Figure 4-19. **Save window**

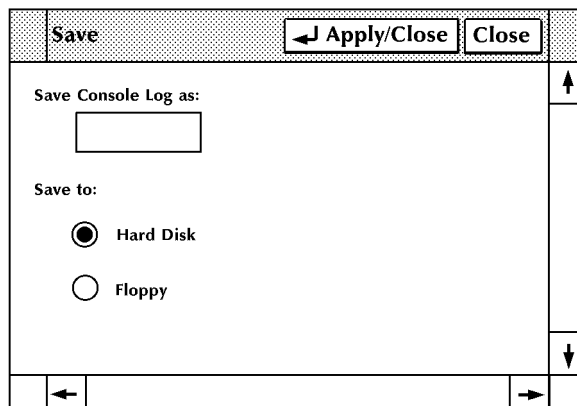

- Step 2.** Enter a file name for the console log in the Save Console Log as field.



**Note:** The file name can be up to eight characters in length, and can consist of letters or numbers. Punctuation characters (such as a comma) or spaces should not be used in the name.

- Step 3.** Select either:
- **Hard Disk.** Save the console log on the system disk.
  - **Floppy.** Save the console log on a formatted floppy disk.

- Step 4.** Select either:
- **Apply/Close.** Save the file and close the window.
  - **Close.** Cancel the save request and close the window.



**Note:** If the PC UI cannot save the whole console log due to insufficient space, an error message displays and no entry is saved.

---

### Emptying the current console log

---

Select the “Empty” option from the header auxiliary menu of the Console Log window . A confirmation window appears (see figure 4-20).

Figure 4-20. **Confirmation window (Empty option)**

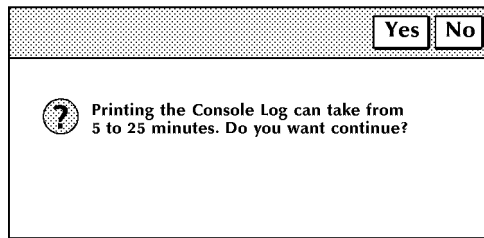

Select Yes to empty the console log, or select No to cancel the empty request.

---

### Deleting a saved console log

---

To delete a saved console log:

- Step 1.** Enter the file name of the console log to delete in the Saved Log field or select it from the Saved Console Logs field.
- Step 2.** Select the “Delete” option from the header auxiliary menu of the Console Log window. A confirmation window appears (see figure 4-21).

Figure 4-21. **Confirmation window (Delete option)**

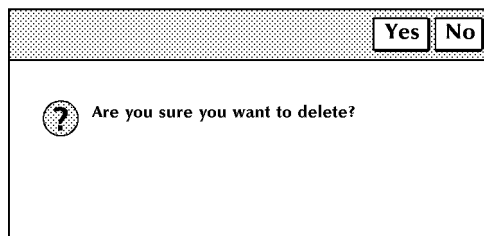

- Step 3.** Select Yes to delete the console log, or select No to cancel the delete request.

---

### Requesting log debug information

---

To have log debug information written to the current console log, select the Log Debug Information box in the Console Log window.

## Converting a console log

To convert a console log:

- Step 1.** Follow the procedure described in step 1, a-b, of the “Displaying a console log” section earlier in this chapter.
- Step 2.** Select the “Convert” option from the header auxiliary menu of the Console Log window to open the Convert window.

Figure 4-22. **Convert window**

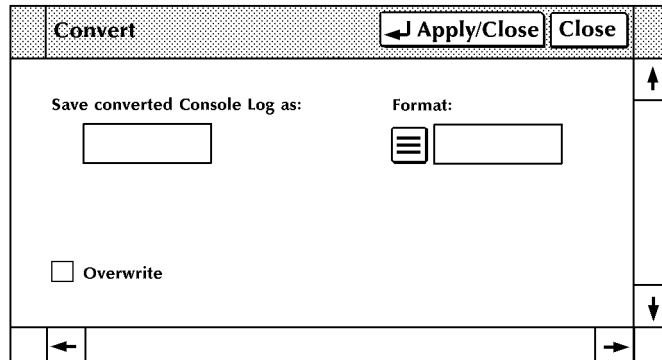

- Step 3.** Enter an ID for the converted file in the Save converted Console Log as field.

Note the following:

- The ID can be up to twelve characters—eight characters for the name and three for the extension, including a period.
- You cannot enter a path name (directory).
- The name cannot be the same as the console log file name.

- Step 4.** Select the format for the converted console log from the Format field’s auxiliary menu.



**Note:** In conversion to EBCDIC, any multinational characters in the console log are lost.

- Step 5.** Select Overwrite if you want any other destination files with the same name to be overwritten.

- Step 6.** Select either:
- **Apply/Close.** Apply your selection and close the Convert window.
  - **Close.** Close the window.



**Note:** The converted console log is stored on the PC UI hard disk. You can copy the converted console log to a PC UI floppy disk with the MS-DOS BACKUP command.

## Problem

---

Use this task before calling for service, when:

- The system recognizes a problem that is not correctable and directs you to key in the PROBLEM command
- You are experiencing difficulties that you wish to report to Service.

Prior to placing a service call, you should use the Problem task to get the 6-digit dispatch code from the system.

### Problem task through windows

Perform the following steps:

- Step 1.** Select "Problem" from the System Control menu.

You are switched to terminal emulation mode (TEM), that is, the PC UI emulates a system controller terminal for the duration of the Problem task. Once the Problem task is complete, the desktop reappears.

- Step 2.** Follow the procedure in the "Problem task through command line" section, which follows.

### Problem task through command line

Perform the following steps:

- Step 1.** Enter the following command:

#### **PROBLEM**

The following messages appear:

```
PROBLEM MXX PROBLEM ANALYSIS:RUNNING
```

```
WHICH OF THE FOLLOWING TYPES OF PROBLEMS DO YOU WISH
TO REPORT?
```

1. PRINT QUALITY PROBLEMS
2. FREQUENT JAMS
3. OUTPUT TRAY PROBLEMS
4. PAPER TRAY PROBLEMS
5. TAPE PROBLEMS
6. OTHER SYSTEM PROBLEMS
7. NO OTHER SYSTEM PROBLEMS

```
INDICATE SELECTION BY ENTERING NUMBER
```

- Step 2.** Select one of the above options.

When you select options 1, 3, 4, or 5, messages appear requesting more detail about the problem you are reporting.

Next, or after selecting option 2, the following messages appear:

```
PROBLEM ANALYSIS RESULTS<MDSH>DISPATCH CODES
(DISPATCH CODE AND MESSAGE)
```

1. TO REPORT ADDITIONAL PROBLEMS.
2. NO MORE PROBLEMS TO REPORT.

```
INDICATE SELECTION BY ENTERING NUMBER
```

If you select option 1, you are returned to the previous problem menu.

If you select option 2, the following messages appear:

CALL THE FIELD SERVICE DISPATCHER AND REPORT THESE NUMBERS

(DISPATCH CODES)

OPERATOR --- INDICATE THE ACTION YOU HAVE TAKEN.

1. SERVICE CALL HAS BEEN PLACED. WAITING FOR SERVICE.
2. SERVICE CALL HAS BEEN PLACED. RETURN TO THE OPERATING SYSTEM.
3. SERVICE NUMBERS COPIED FOR LATER CALL. RETURN TO THE OPERATING SYSTEM.
4. NONE OF THE ABOVE. RETURN TO THE OPERATING SYSTEM.

INDICATE SELECTION BY ENTERING NUMBER

If you select any option other than 1, you can continue using the LPS.

If you select option 1, the following messages appear:

SERVICE CALL PLACED.

WAITING FOR CE

1. REDISPLAY DISPATCH CODES
2. RETURN TO OPERATING SYSTEM

INDICATE SELECTION BY ENTERING NUMBER

- Step 3.** Select option 1 to see the dispatch codes, or select option 2 to continue using the LPS.
- Step 4.** Ensure that you record the 6-digit dispatch code to report to the service representative.



**Note:** In the U.S., the message CALL THE FIELD SERVICE DISPATCHER AND REPORT THESE NUMBERS refers to the National Customer Service Support Center. For non-U.S. areas, contact your local service representative.

## Audit log

Use this task to display, print, or copy the current audit log from the PC UI hard disk.

### Audit Log task through windows

Select "Audit Log" from the System Control menu to open the Audit Log window (see figure 4-23).

Figure 4-23. Audit Log window

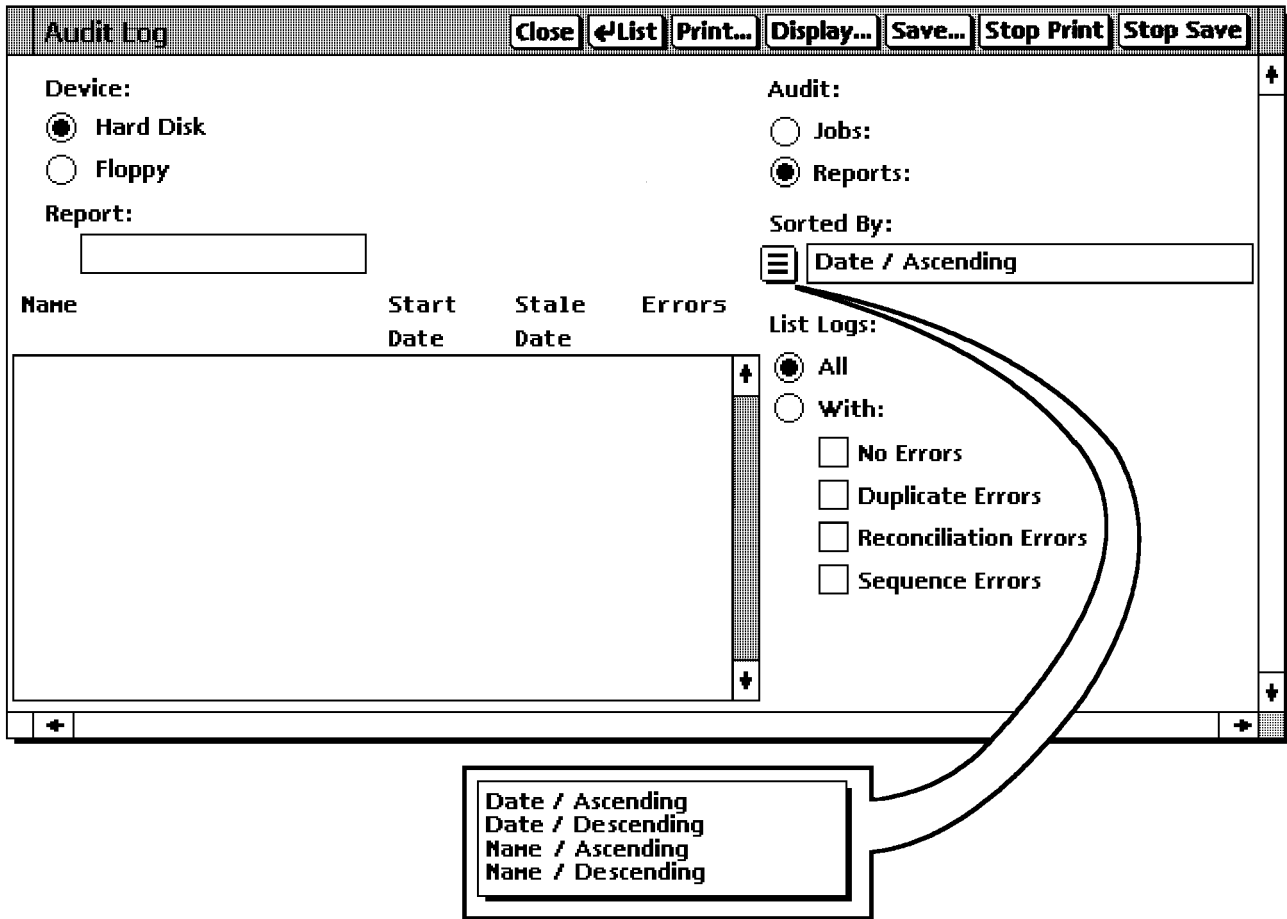

### Selecting a header option

The Audit Log window gives you the following header options:

- List** Lists all logs of reports or jobs in the field in the lower left corner of the window or the list display field.
- Print** Initiates printing of a report.
- Display** Initiates display of a report.
- Save** Saves the report in the Reports field



**Stop Print** Stops the printing of an Audit Log.

**Stop Save** Stops the Audit Log Save that is currently in process.

For more information on each of these options, refer to the *Xerox DocuPrint180 Laser Printing System PC User Interface Reference*.

### Selecting a device

---

Select a **Device** option.

Selecting the device determines where the Audit Logs listed in the **Display** field are stored. This selection is also used as the 'Source Device' when the **Save...** header button is selected.

### Selecting an Audit option

---

Select an **Audit** option.

Selecting Jobs or Reports determines what will be listed in the list display field.

### Sorting reports and jobs

---

Specify how you want your reports or jobs sorted, using the following **Sorted By** selections:

- Date/Ascending
- Date/Descending
- Name/Ascending
- Name/Descending.

### Listing logs

---

Specify the logs you want listed, using the following **List Logs** selections:

- **All** lists all jobs or reports
- **With** lists jobs or reports with one of the specified options.

## Remote Terminal

The remote terminal function is only available in conjunction with Xerox Print Services Manager software. Please refer to the *Xerox DocuPrint180 Installation Planning Guide* for hardware requirements for use of the remote terminal option.

Use this task to transfer control of the DocuPrint180 from the PC UI to a remote device when running DocuPrintServer (formerly XPSM) jobs.



**Note:** This selection will only appear if the required DocuPrintServer (formerly XPSM) software options have been loaded

### Remote Terminal task through windows

Select "Remote Terminal" from the System Control menu. A window appears asking you for confirmation.

Figure 4-24. Remote terminal confirmation window



After remote terminal has been entered, the System Controller will no longer recognize input from the PCUI and the message shown in figure 4-25 will be displayed. To return control of the DocuPrint180 to the PCUI, the command @UI\$ must be entered at the remote terminal.

Figure 4-25. Remote terminal display window

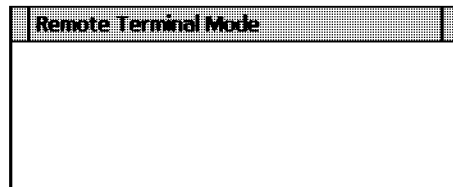

## Exit to DOS

Use this task to exit the desktop before turning off the PC UI or to return to the DOS command line.

### Exit to DOS task through windows

Select "Exit to DOS" from the System Control menu. A window appears asking you for confirmation.

Select Yes to exit to DOS, or select No to cancel the exit request.

To return to the desktop, key in **MANUI** and press the <ENTER> key.

---

## 5.

## Job control tasks

This chapter contains instructions for performing job control tasks. These tasks allow you to control and manage print jobs.

Instructions are given for accomplishing the tasks using either the windows of the PC UI or keyed-in commands. Refer to the list below for the tasks described in this chapter:

- Job control tasks through windows of PC UI
- Job control tasks through command line
- Abort
- Reset
- Align
- Print Darkness
- Lead edge screen
- Fonts/forms/graphics
- Sample files
- Stop input/output
- Continue input/output
- Sample

---

## Job control tasks through windows of PC UI

---

To select job control tasks using the windows of the PC UI:

**Step 1.** Open the Job Control menu icon.

The Job Control menu window appears (see figure 5-1), listing the available options.

Figure 5-1. **Job Control menu window**

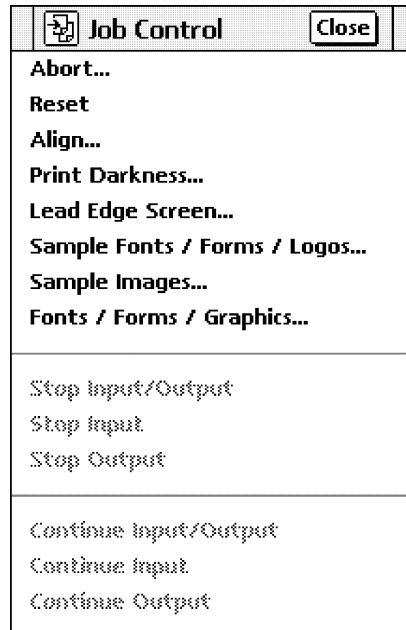

**Step 2.** Turn to the section of this chapter which explains the task in which you are interested.

---

## Job control tasks through command line

---

You can activate job control tasks by entering commands either:

- Through the Messages window of the PC UI
- Through the system controller terminal (non-U.S. markets only).

To enter commands through the Messages window of the PC UI:

- Step 1.** Place the cursor in the window.
- Step 2.** Click once with the left mouse button.
- Step 3.** Enter the command.

If you are using the system controller terminal, use the keyboard to enter the command.

## Job control tasks

The following sections contain instructions for performing specific job control tasks.

### Abort

Use this task to do one of the following:

- Remove a specific print job from the system
- Remove the print job currently being processed
- Cause the current print job to stop printing (printing continues with the next report)
- Cause the currently active nonprint task (such as FDL or PDL) to abort (there must be no active print jobs when this command is entered).

#### Abort task through windows

Perform the following steps:

- Step 1.** Select "Abort" from the Job Control menu to open the Abort window (see figure 5-2).

Figure 5-2. **Abort window**

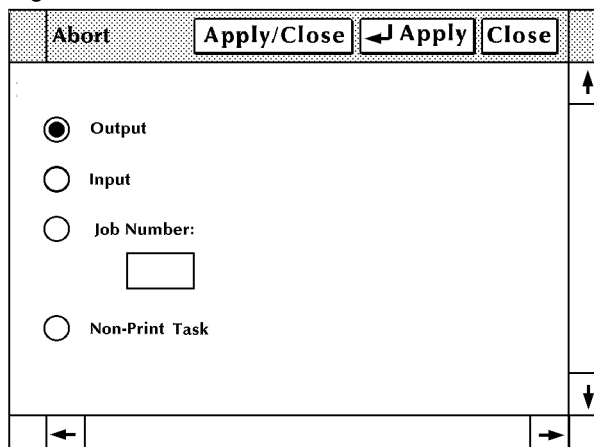

- Step 2.** Select one of the following options:

- To cause the current job to stop printing, select the Output button.
- To remove the print job currently being input into the system, select the Input button.
- To remove a specific print job from the system, enter the job number in the Job Number field.
- To abort a non print task (such as FDL or PDL), select the Non-Print Task button.



**Note:** You will only see this option if the system is idle.

**Step 3.** Select the appropriate header button:

- **Apply/Close.** Apply your selection and close the window.
- **Apply.** Apply your selection.
- **Close.** Close the window.

### Abort task through command line

To remove a specific print job from the system, enter the following command:

#### **ABORT *job-id***

Table 5-1 lists the parameter and its description.

Table 5-1. **ABORT command parameter and description**

| Parameter     | Description                            |
|---------------|----------------------------------------|
| <i>job-id</i> | The name of the job you want to abort. |

To cause the current job to stop printing, enter the following command:

#### **ABORT O**

To remove the print job currently being input into the system, enter the following command:

#### **ABORT I**

To abort a nonprint task (such as FDL or PDL), enter the following command:

#### **ABORT**

For this command to work, there must be no print jobs active at the time it is entered. If there is an active print job, the following message appears:

```
OS1190 INVALID PARAMETER, COMMAND IGNORED
```

## Reset

When the Reset task is used:

- All print jobs are removed from the job queue.
- Any pages in the printer paper path are sent to the selected stacker bin.
- All processing activity ceases, including accounting.
- If your LPS is operating online to a host computer, all jobs in the system need to be resent from the host.



**Note:** The Reset task should not be used if the Abort task can be used instead.

- If the system is idle when the Reset task is selected, a message appears informing you that the system has been reset and is ready for another request.
- If the system is not idle, a message appears asking you to confirm the clearing of the job queue.

### Reset task through windows

Select "Reset" from the Job Control menu. A confirmation window appears (see figure 5-3).

Figure 5-3. **Confirmation window (Reset option)**

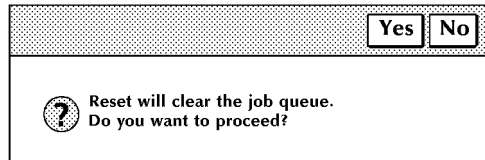

Select Yes to clear the job queue and close the confirmation window, or select No to close the confirmation window without clearing the job queue.

### Reset task through command line

Enter the following command:

#### **RESET**

If the system is idle when the Reset command is entered, a message displays informing you that the system has been reset and is ready for another request. If the system is not idle, the following messages appear in the Messages window of the PC UI or the system controller display (non-U.S. markets only):

```
RESET WILL CLEAR THE JOB QUEUE. DO YOU WANT TO
PROCEED?
(TYPE 'Y' FOR YES, OR 'N' FOR NO; ENTER = YES)
```

Press <Y> to clear the job queue; press <N> to cancel the RESET command.



## Align

Use this task to align the laser image of the printer with the paper.



**Note:** Normal alignment on the LPS is exceptionally accurate and very seldom, if ever, requires adjustment. If you need to adjust the alignment for a specific form, it is very important to remember to restore the alignment to the original specifications when the job is completed. Failure to do so could result in lost information when printing future jobs. (The normal alignment setting of the Xerox DocuPrint 180 LPS is 1,0.)

### Align task through windows

Perform the following steps:

- Step 1.** Select “Align” from the Job Control menu to open the Align window (see figure 5-4).

Figure 5-4. **Align window**

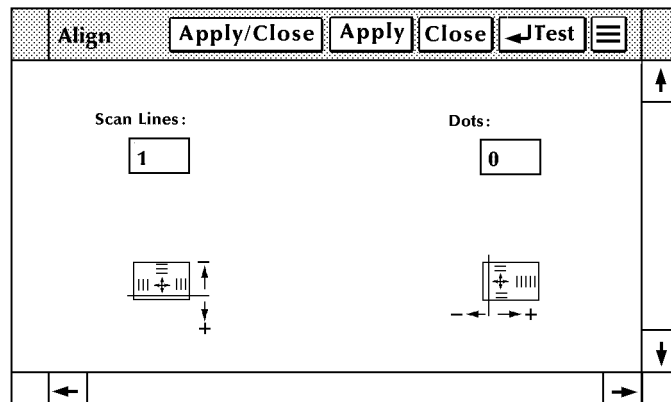

The Align window displays the current alignment.

The paper icons displayed underneath the Lines and Dots fields show the direction the image moves on the paper if you change the numeric value in the fields.

“-” is the direction the image moves if you decrease the number in the field.

“+” is the direction the image moves if you increase the number in the field

- Step 2.** To change the alignment, enter a new value in the Lines and/or Dots field(s).

- Step 3.** Select the appropriate header button:
- **Apply/Close.** Apply your selection and close the window.
  - **Apply.** Apply your selection.
  - **Close.** Close the window.
  - **Test.** Print a sample with the new alignment applied. If a job is currently printing, a page from the job with the new alignment applied is delivered to the sample tray. If a print job is not running, the test form is delivered to the sample tray. (Refer to figure 5-5.)
  - **Redisplay.** Return the alignment to the values displayed when you first opened the Align window.

**Align task through command line** To change the alignment for forms:

- Step 1.** Enter ALIGN to display the current setting (normal operating setting). For example:

```
OS1380 ALIGNMENT IS 1 SCAN LINES AND 0 DOTS
```

- Step 2.** To change these values (and move the image to correspond to your form), key in ALIGN plus the new line value and the new dot value. There is a space between ALIGN and the number for the new line value, but only a comma between the values for the lines and dots. For example, if the initial alignment was 1 and 0, ALIGN 16,20 changes the initial alignment by 15 lines and 20 dots.

When using the test pattern, which is in landscape format, adding dots moves the image to the right; adding scan lines moves the image toward the bottom of the page. You may move the image by adding as many as 296 lines and up to 1496 dots. To go in the opposite direction, subtract dots or lines. You may not use negative numbers.

- Step 3.** To check the amount of shift, key in SAMPLE TEST.FRM to print the built-in test form (see figure 5-5), or you may print a sample of the actual job on the preprinted form to be used.

Figure 5-5. Sample test form

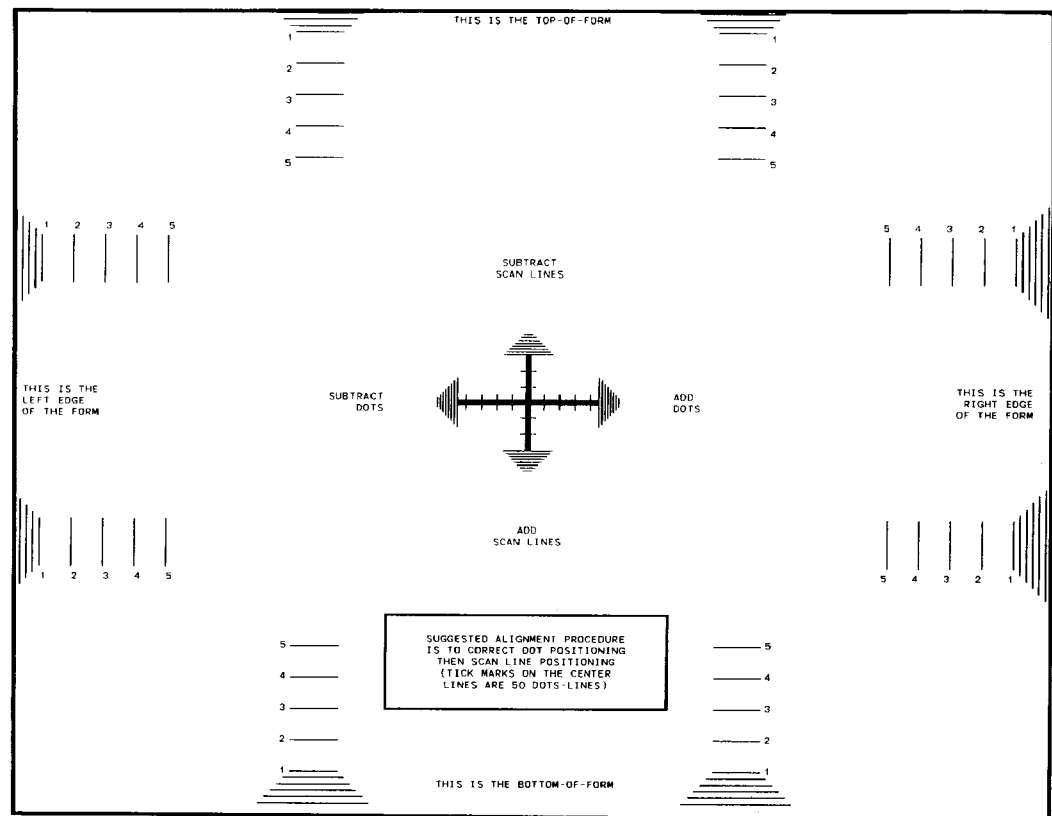

- Step 4.** If further adjustments are needed, repeat steps 2 and 3 until you are satisfied with the results.

There is another method used to set alignment with the system-generated test pattern. Enter the ALIGN command with the new values, followed immediately (no spaces) by, TEST (for example, ALIGN 3,8,TEST). This command sets the new values and automatically generates a single test form sample for your evaluation. The new values are printed near the top of the form.

The ALIGN, TEST command may be used any time you wish to generate a sample test form with the current values printed on it. (You could use this command in step 1, instead of the basic ALIGN command.)



**Note:** Remember to restore the printer to its original values. Enter ALIGN and the original values, whatever they were at the beginning. Refer to step 1.

## Print Darkness

Use this task to make the printed image lighter or darker. The setting ranges from 1 (the lightest) to 9 (the darkest). The default value is 5.

**Print Darkness task through windows** Perform the following steps:

- Step 1.** Select "Print Darkness" from the Job Control menu to open the Print Darkness window (see figure 5-6).

Figure 5-6. **Print Darkness window**

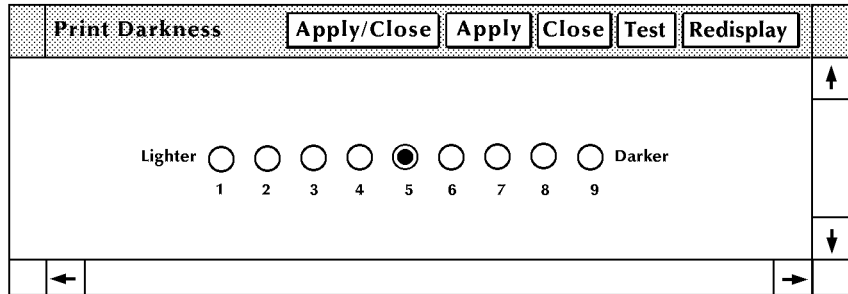

The current value of image darkness is indicated by the highlighted button.

- Step 2.** To change the print darkness value, select the radio button with the value you want to apply.
- Step 3.** Select the appropriate header button:
- **Apply/Close.** Apply your selection and close the window.
  - **Apply.** Apply your selection.
  - **Close.** Close the window.
  - **Test.** Print a sample with the new alignment applied. If a job is currently printing, a page from the job with the new alignment applied is delivered to the sample tray. If a print job is not running, the test form is delivered to the sample tray. (Refer to figure 5-5.)
  - **Redisplay.** Return the alignment to the values displayed when you first opened the Align window.

### Print Darkness task through command line

To change the print darkness level, enter the following command:

**DARKNESS [*level* [,TEST]]]**

Table 5-2 lists each parameter and its description.

Table 5-2. **DARKNESS command parameters and descriptions**

| Parameter    | Description                                              |
|--------------|----------------------------------------------------------|
| <i>level</i> | Print darkness level you want to apply.                  |
| TEST         | To receive a sample with the new darkness value applied. |

If a job is printing, a page with the new value applied is delivered to the sample tray. If no job is printing, the test form with the new value applied is delivered to the sample tray. (See figure 5-5.)

To display the current image darkness value, enter the following command:

**DARKNESS**

## Lead edge screen

Use this task to apply a screen to the leading margin of a printed sheet. The screen lightens a high density image in the margin. The edge lightening change is applied to:

- The next print job
- The current print job if printing was interrupted.

If you select this task while the LPS is printing, the confirmation window shown in figure 5-7 appears on the PC UI.

Figure 5-7. Confirmation window ("Lead Edge Screen" option)

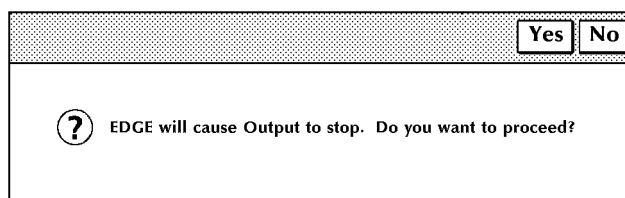

Select Yes to continue with the Lead Edge Screen task, or select No to cancel the task.

If you have the system controller terminal rather than the PC UI, the following messages appears on the screen:

```
OS1331 LEAD EDGE SCREEN SETTING IS [OFF, NORMAL,
STRESS]
OS0500 OUTPUT STOPPED
```

**Lead Edge Screen task through windows**

Perform the following steps:

- Step 1.** Select “Lead Edge Screen” from the Job Control menu to open the Lead Edge Screen window.

Figure 5-8. **Lead Edge Screen window**

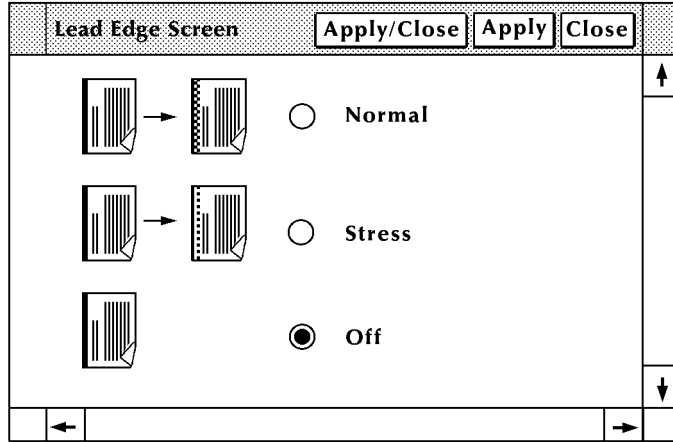

The current value of edge lightening is indicated by the highlighted button.

- Step 2.** Select one of the following options:
- To apply a normal lead edge screen, select the Normal button.
  - To apply a heavier lead edge screen, select the Stress button.
  - To turn the lead edge screen off, select the Off button.

- Step 3.** Select the appropriate header button:
- **Apply/Close.** Apply your selection and close the window.
  - **Apply.** Apply your selection.
  - **Close.** Close the window.

**Lead Edge Screen task through command line**

To change the edge lightening value, enter the following command:

**EDGE [NORMAL | STRESS | OFF]**

Table 5-3 lists each parameter and its description.

Table 5-3. **EDGE command parameters and descriptions**

| Parameter | Description                    |
|-----------|--------------------------------|
| NORMAL    | Apply normal edge lightening.  |
| STRESS    | Apply heavier edge lightening. |
| OFF       | Turn off edge lightening.      |

To display the current value of edge lightening, enter the following command:

**EDGE**

## Fonts/forms/graphics

---

In order to improve printer throughput, you can define the maximum number of fonts, forms, and graphics that the system stores in memory during a print job. The values remain in effect until you change them or perform an LPS Update or Sysgen task. (Refer to the *Xerox DocuPrint 180 LPS System Generation Guide* for additional information.)

Use the Fonts/Forms/Graphics task to set the maximum number for the following:

- **Fonts.** Sets the maximum number of active fonts per print job. No single printed page can have more fonts than this number.



**Note:** This number must include all fonts used on the form as well as in the variable data.

If the number of fonts specified is exceeded during a print job, the job aborts and a message displays in a message window on the PC UI or the display screen of the system controller.

- **Forms.** Sets the maximum number of active forms per print job. Specifying a number larger than one allows form changes on a page to page basis without negative effects on printing speed as long as there is room for all the forms in system memory.
- **Graphics.** Sets the maximum number of active graphics per print job. No single printed page may call for more than 16 graphics.



**Note:** This number must also include all graphics used on a form for the page, if a form is used.

**Fonts/Forms/Graphics task through windows**

Perform the following steps:

- Step 1.** Select "Fonts/Forms/Graphics" from the Job Control menu to open the Fonts/Forms/Graphics window (see figure 5-9).

Figure 5-9. **Fonts/Forms/Graphics window**

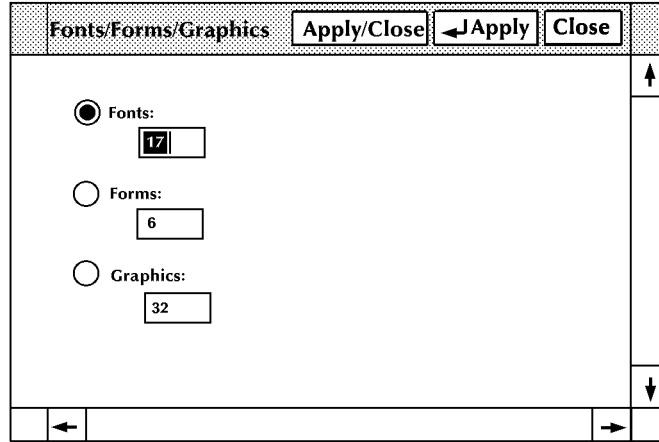

The current numbers for fonts, forms, and graphics are displayed.

- Step 2.** Change whatever values you want by entering a new number in the appropriate field. For example, to change the number of forms, place the cursor over the number, press the <DELETE> key, and then enter the new number.
- Step 3.** Select either:
- **Apply/Close.** Apply your selection and close the window.
  - **Apply.** Apply your selection.
  - **Close.** Close the window.

**Fonts/Forms/Graphics task through command line**

To set the maximum number of files, enter the following command:

**{FONTS | FORMS | GRAPHIC} *number***

Table 5-4 lists the parameter and its description.

Table 5-4. **FONTS/FORMS/GRAPHIC command parameter and description**

| Parameter     | Description                       |
|---------------|-----------------------------------|
| <i>number</i> | The maximum number per print job. |

To display the current number of fonts, enter the following command:

**FONTS**

To display the current number of forms, enter the following command:

**FORMS**

To display the current number of graphics, enter the following command:

**GRAPHIC**



## Sample files

Use this task to print samples of fonts, forms, logos, or graphics.

**Sample files task through windows** To print sample of fonts, forms, or logos:

- Step 1.** Select "Sample Fonts/Forms/Logos" from the Job Control menu to open the Sample Fonts/Forms/Logos window.

Figure 5-10. **Sample Fonts/Forms/Logos window**

- Step 2.** To print a sample of a font, form, or logo, either:
- Enter the file name in the File ID field to print a sample of a font, form, or logo stored on the system disk.
  - Select the appropriate option from the auxiliary menu next to the File ID field to print a sample of all the fonts, forms, or logos in the system:
    - \*.FNT to print samples of all fonts at 300 spots per inch (spi)
    - \*.FRM to print samples of all forms at 300 spots per inch
    - \*.LGO to print samples of all logos at 300 spots per inch.
  - a. If you want to print more than one copy of the file specified, enter the number in the copies field.



**Note:** The maximum number of copies you can print is 32,767.

- b. If you want to print on both sides of each sheet of paper, select the Duplex option from the Format field's auxiliary menu. Otherwise, the samples print on only one side of the paper (simplex).
- c. Select the appropriate header button:
  - **Apply/Close.** Apply your selection and close the window.
  - **Apply.** Apply your selection.
  - **Close.** Close the window.

To print a sample of graphic images:

- Step 1.** Select "Sample Images" from the Job Control menu to open the Sample Images window.

Figure 5-11. **Sample Images window**

The screenshot shows the 'Sample Images' window with the following settings:

- File ID:** \*.IMG
- Copies:** 1
- Format:** Simplex
- Scaling Factor:** 1 / 1
- Orientation:** Portrait
- Descriptor Page:**
  - Abbreviated
  - Comprehensive (Hardcopy)
- Vertical Position:** [Empty field]
- Vertical Units:** Inches
- Horizontal Position:** [Empty field]
- Horizontal Units:** Inches

- Step 2.** Either:

- Enter the image file name of the graphic in the File ID field to print a sample of a graphic stored on the system disk.
- Leave the default value of \*.IMG to print samples of all graphics at 300 spi.

- Step 3.** You have the following print options:

- To print an enlarged or reduced version of the graphic sample(s), enter the enlargement or reduction value in the Scaling Factor field. For example, to print a graphic image reduced by 25 percent, enter 1/4 in the field.



**Note:** An image may be enlarged by up to a factor of 8 or reduced as small as 1/8.

- To specify where the graphic prints on the page, enter the vertical and horizontal positions in the appropriate fields.
- To have the sample(s) print in landscape orientation, select the landscape option from the auxiliary menu next to the Orientation field. Otherwise, the samples print in portrait orientation.
- To specify the units used for the vertical and horizontal positioning of the image, select the unit from the auxiliary menus next to the Vertical and Horizontal Units fields. The default value of the field is inches.

- If you want to print more than one copy of the file specified, enter the number in the Copies field.



**Note:** The maximum number of copies you can print is 32,767.

- If you want the samples to print on both sides of each sheet of paper, select the duplex option from the auxiliary menu of the Format field. Otherwise, the samples print on only one side of the paper (simplex).

**Step 4.** Select the appropriate header button:

- **Apply/Close.** Apply your selection and close the window.
- **Apply.** Apply your selection.
- **Close.** Close the window.

**Sample Files task through command line**

To print a sample of a form, font, logo, or graphic stored on the system disk, enter the following command:

**SAMPLE *file-name.file-type* [,D,*copies*]**

Table 5-5 lists each parameter and its description.

Table 5-5. **SAMPLE command parameters and descriptions**

| Parameter        | Description                                                                                                                                                              |
|------------------|--------------------------------------------------------------------------------------------------------------------------------------------------------------------------|
| <i>file-name</i> | The name of the file, obtained from your systems personnel.                                                                                                              |
| <i>file-type</i> | One of the following: <ul style="list-style-type: none"> <li>• .FRM (form)</li> <li>• .FNT (font)</li> <li>• .IMG (graphic).</li> </ul>                                  |
| D                | Print the samples on both sides of each sheet of paper (duplex mode). If you do not enter a D, the samples print on only one side of each sheet of paper (simplex mode). |
| <i>copies</i>    | The number of copies you want. If you do not enter a number, one copy is printed.                                                                                        |



**Note:** For prints of graphics only, you may be asked to use the HARDCOPY command instead of the SAMPLE command. There is no difference in the graphic, but the data sheet that is printed with it is more detailed when the HARDCOPY command is used.

To print samples of all files of a certain type, such as font, form, and logo files, specify the type only. Enter the following command:

**SAMPLE *.file-type* [,D,*copies*]**

Table 5-6 lists each parameter and its description.

Table 5-6. **SAMPLE command parameters and descriptions**

| Parameter        | Description                                                                                                                                                              |
|------------------|--------------------------------------------------------------------------------------------------------------------------------------------------------------------------|
| <i>file-type</i> | One of the following: <ul style="list-style-type: none"> <li>• .FRM (form)</li> <li>• .FNT (font)</li> <li>• .IMG (graphic).</li> </ul>                                  |
| D                | Print the samples on both sides of each sheet of paper (duplex mode). If you do not enter a D, the samples print on only one side of each sheet of paper (simplex mode). |
| <i>copies</i>    | The number of copies you want. If you do not enter a number, one copy is printed.                                                                                        |

## Stop input/output

Use this task to stop input processing, output processing (printing), or both.

- To stop both input and output processing, you may also press the <STOP> key on the keyboard.
- To stop printing, you may also press the Stop button on the printer control console.
- You can open the I/O window, which gives you stop input/output options, by pressing both the left and right buttons of the mouse at the same time.

Figure 5-12. I/O window

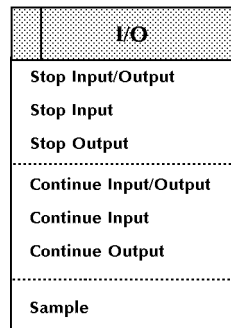

**Note:** When running an online job, stopping output processing will also stop input processing. When doing the same for an offline job, the input processing continues.

### Stop Input/Output task through windows

Through windows:

- To stop both input processing and printing, select "Stop Input/Output" from the Job Control menu.
- To stop input processing, select "Stop Input" from the Job Control menu.
- To stop printing, select "Stop Output" from the Job Control menu.

### Stop Input/Output task through command line

Through command line:

- To stop both input processing and printing, enter the following command:  
**STOP**
- To stop input processing, enter the following command:  
**STOP I**
- To stop printing, enter the following command:  
**STOP O**

## Continue input/output

---

Use this task to resume interrupted input processing, printing, or both.

Continue is also used:

- To confirm that you have completed activities such as loading paper
- To resume operation of the LPS after a system report of a fault, such as a paper jam.

Input and/or printing resume at the point where stopped.

- To resume both input and output processing, you may also press the <CONTINUE> key on the keyboard
- To resume printing, you may also press the Continue button on the printer control console.



**Note:** You can also open the I/O window by chording the mouse— that is, pressing both the left and right buttons of the mouse at the same time.

### Continue Input/Output task through windows

Through windows:

- To continue both input processing and printing, select “Continue Input/Output” from the Job Control menu.
- To continue input processing, select “Continue Input” from the Job Control menu.
- To continue printing, select “Continue Output” from the Job Control menu.

### Continue Input/Output task through command line

Through command line:

- To resume both input processing and printing, enter the following command:  
**CONTINUE**
- To resume input processing, enter the following command:  
**CONTINUE I**
- To resume printing, enter the following command:  
**CONTINUE O**

## Sample

---

Use this task to print a single page sample of the current job being printed.

Note the following when sampling the current job:

- The job may be running or suspended.
- The job must be at least three pages in length for you to be able to sample it.
- The next available page is printed twice and the extra page is sent to the sample tray.

To get a sample, you may also:

- Press the <SAMPLE> key on the keyboard.
- Press the Sample button on the printer control console.
- Open the I/O window, which gives you the sample option, by chording the mouse—that is, pressing both the left and right buttons of the mouse at the same time. (Refer to figure 5-12.)



**Note:** A print job must be in output processing in order to obtain a sample print. Also, you may not print samples when the sample tray is the output destination for a job, for example, when printing transparencies or when ordered stock is being used in the job.

### Sample task through windows

Select “Sample” from the Job Control menu.

### Sample task through command line

To print a sample of the current print job, enter the following command:

**SAMPLE**





---

## 6. Online printing tasks

This chapter contains instructions for performing online printing tasks. These tasks allow you to run print jobs from a host computer.

Where applicable, instructions are given for accomplishing the tasks using either the windows of the PC UI or keyed-in commands. Refer to the list below for the tasks described in this chapter:

- Online printing tasks through windows of PC UI
- Online printing tasks through command line
- Place the LPS online
- Start an online print job
- Space
- Endjob
- Drain
- Disk saturation

## Online printing tasks through windows of PC UI

To select online printing tasks using the windows of the PC UI:

**Step 1.** Open the Print Tasks menu icon.

The Print Tasks menu window appears (see figure 6-1), listing the available options.

Figure 6-1. **Print Tasks menu window**

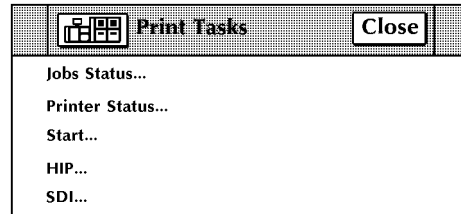

**Step 2.** Select the "Start" option to open the Start window.

You can also press the <F7> key to open the Start window.

Figure 6-2. **Start window**

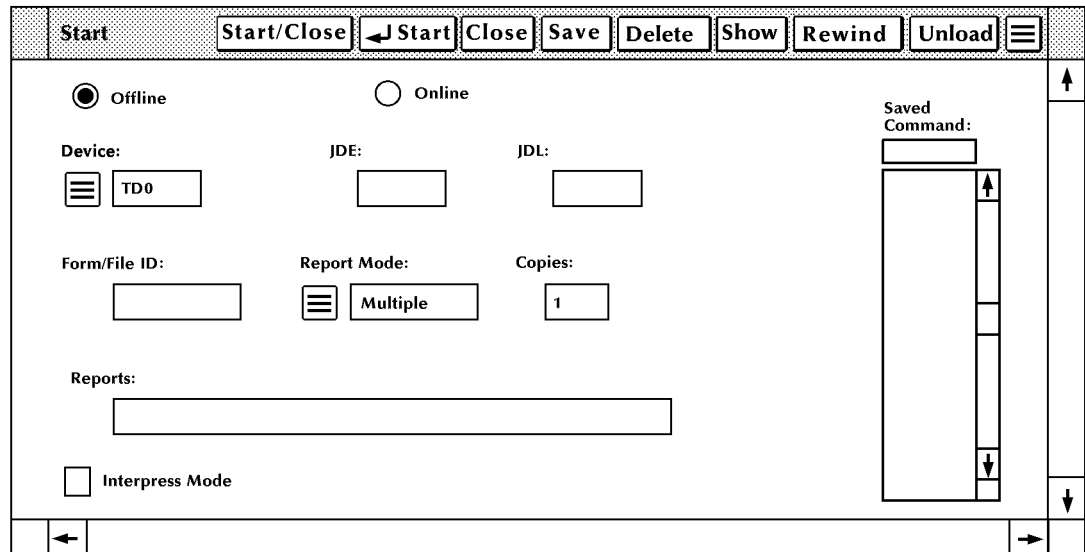

**Step 3.** Turn to the section of this chapter which explains the task in which you are interested.

---

## Online printing tasks through command line

---

You can perform online printing tasks by entering commands either:

- Through the Messages window of the PC UI
- Through the system controller terminal (non-U.S. markets only).

To enter commands through the Messages window of the PC UI:

- Step 1.** Place the cursor in the window.  
**Step 2.** Click once with the left mouse button.  
**Step 3.** Enter the command.

If you are using the system controller terminal, just use the keyboard to enter the command.

---

## Place the LPS online to the host computer

---

### Place the LPS Online task through windows

For the PC UI, selecting the “Online” option from the Print Tasks menu automatically places the LPS online to the host.

### Place the LPS Online task through command line

To place the LPS online to the host computer, enter the following command:

**ONLINE**

---

## Online printing tasks

---

The following sections contain instructions for performing specific online printing tasks.

## Start an online print job

Use this task to begin printing an online job.

### Start Job task through windows

Perform the following steps:

**Step 1.** Select the Online button.

**Step 2.** Enter information in the appropriate input field:

- **JDE.** The name or number of the job descriptor entry. It may be up to six characters in length.
- **JDL.** The name or number of the job descriptor library, which contains the JDE task used. It may be up to six characters in length.
- **Form.** The name of the form to be used in the job.
- **Copies.** The number of copies you want.
- **Saved Commands menu.** The Saved Commands menu (directly beneath the Saved Command Field) lists start commands.
  - To add commands to the list:
    - a. Enter the appropriate job information in the input fields.
    - b. Enter a start command name (up to eight characters in length) in the Saved Command field.
    - c. Select the Save header button.
  - To start a job from the list:
    - a. Select that job's start command from the Saved Commands menu. The job's information appears in the input fields.



**Note:** You can also display job information for a start command by entering the start command name in the Saved Command field and selecting the Show header button. The job's information now appears in the input fields.

- b. Select the Start header button to start the job.

— To delete a start command from the command library:

- a. Highlight the saved start command.
- b. Select the Delete header button.

**Step 3.** Select either:

- **Start.** Start the print job
- **Start/Close.** Start the print job and close the window.

**Start Job task through command line**

To start printing an online job, enter the following command:

**START [[*jde*][,*jdl*][,*copies*][,FORM=*form*]]]**

Table 6-1 lists each parameter and its description.

Table 6-1. **START command parameters and descriptions**

| Parameter         | Description                                                                                                                                  |
|-------------------|----------------------------------------------------------------------------------------------------------------------------------------------|
| START             | Specifies the command, to be followed by any or all of the specifications as needed.                                                         |
| <i>jde</i>        | The name or number of the job descriptor entry which may be up to six characters in length.                                                  |
| <i>jdl</i>        | The name or number of the job descriptor library which contains the JDE task used. The name or number may be up to six characters in length. |
| , (comma)         | The comma replaces the multi/single report mode parameter when giving the START command online.                                              |
| <i>copies</i>     | The requested number of prints for each report.                                                                                              |
| FORM= <i>form</i> | The name of the form to be used. The extension .FRM is optional.                                                                             |

Refer to the *Xerox DocuPrint 180 LPS Operations Reference* for further information.

## Space

The Space task allows you to move forward a specified number of pages within a report in order to begin printing at that point in the report.

If you have already started the print job, do the following:

- Step 1.** Stop the print job.
- Step 2.** Perform the Space task.
- Step 3.** Continue the print job.

**Space task through windows** Perform the following steps:

- Step 1.** Select the "Space" option from the Start window's header auxiliary menu to open the Space window (see figure 6-3).

Figure 6-3. **Space window**

- Step 2.** Enter the number of pages you want to space forward. You can enter only a positive number.
- Step 3.** Select the appropriate header button:
  - **Apply/Close.** Apply your selection and close the window.
  - **Apply.** Apply your selection.
  - **Close.** Close the window.

**Space task through command line** Enter the following command:

**SPACE *n* PAGES**

*n* is the number of pages you want to space forward. It must be a positive number.

## Endjob

---

The Endjob task signals the LPS that the current print job is the last job coming from the host. All formatted pages in the output queue are printed. You may want to use the Endjob task under the following circumstances:

- When switching from printing online to printing offline
- When an online print job doesn't contain a trailer page to indicate the end of the report
- If the trailer page has not been sent completely
- As an option to deal with multi-copy disk saturation
- When a "MOUNT FORM" message appears on an IBM host terminal.

**Endjob task through windows** Perform the following steps:

**Step 1.** Select the "Endjob" option from the Start window's header auxiliary menu. (See figure 6-2.)

A message appears when the job has printed.

**Step 2.** You can now enter another start request.

**Endjob task through command line** Enter the following command:

**ENDJOB**

## Drain

---

Use the Drain task to print all formatted pages in the print file or in memory without ending the print job in progress. You do not need to enter another start request for printing to continue.



**Note:** Sheets are printed if complete data pages are in the print file or in memory. Partially completed pages are not printed.

Before draining the print queue, check the status of the job using the jobs status task. Refer to the "Status and print tasks" chapter for instructions.

**Drain task through windows** Select the "Drain" option from the header auxiliary menu of the Start window. (See figure 6-2.) A message appears when the drain is complete.

**Drain task through command line** Enter the following command:

**DRAIN**

## Disk saturation

If a report is larger than the size of the print file, the system may not be able to receive the entire report onto the system disk at one time. If it cannot, a disk saturation message appears on the PC UI or system controller screen alerting you of the situation and asking you for instructions.

**Disk Saturation task through windows** Perform the following steps:

**Step 1.** When 16 cylinders of disk space are available, the following message appears in the Messages window:

APPROACHING DISK SATURATION

**Step 2.** If disk saturation occurs, input processing stops while printing continues. The confirmation window shown in figure 6-4 appears.

Figure 6-4. **Confirmation window (disk saturation)**

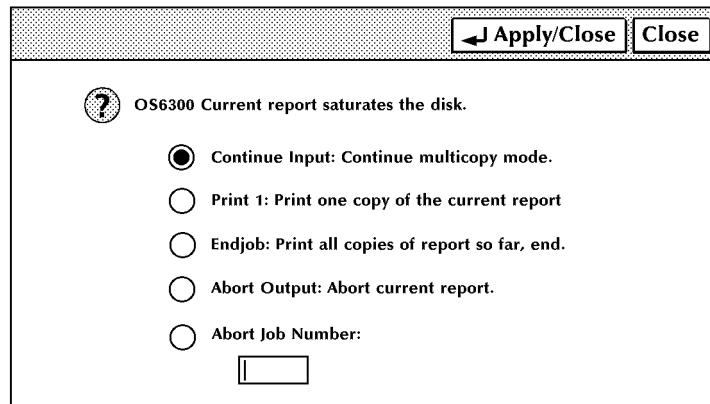

This window contains options for dealing with the disk saturation.

**Step 3.** Select the appropriate option:

- **Continue Input.** Continues multi-copy printing in sections. You will need to merge the prints of the different sections to get complete prints of the whole report.
- **Print 1.** One copy of the current report is printed. The report must be retransmitted from the host for each copy required.
- **Endjob.** Prints already formatted pages and ends the current job file.
- **Abort Output.** The current report is aborted and the next report begins printing.
- **Abort Job Number.** The job whose number appears in the field is aborted.

**Step 4.** Select the Apply/Close header button to apply your selection and close the window.



**Disk Saturation task through command line**

When disk saturation occurs, the following message appears:

```
OS6300 CURRENT REPORT SATURATES DISK. ENTER
OPTION:
"CONTINUE I - CONTINUE MULTI-COPY MODE
"PRINT - PRINT ONE COPY OF CURRENT REPORT
"ENDJOB" - PRINT ALL COPIES OF REPORT SO FAR, END
"ABORT O" - ABORT CURRENT REPORT
"ABORT n" - ABORT CURRENT JOB
```

To resolve disk saturation, enter one of the commands listed in table 6-2.

Table 6-2. **Commands options following disk saturation and descriptions**

| Parameter      | Description                                                                                                                                        |
|----------------|----------------------------------------------------------------------------------------------------------------------------------------------------|
| CONTINUE I     | Continues multi-copy printing in sections. You will need to merge the prints of the different sections to get complete prints of the whole report. |
| PRINT 1        | One copy of the current report is printed. The report must be retransmitted from the host for each copy required.                                  |
| ENDJOB         | Prints already formatted pages and ends the current job file.                                                                                      |
| ABORT O        | Cancels the current report and starts printing the next report.                                                                                    |
| ABORT <i>n</i> | Cancels the job whose number is entered.                                                                                                           |



---

## 7. Offline printing tasks

This chapter contains instructions for performing offline printing tasks. These tasks allow you to run print jobs from either the open-reel tape drive or the 1/2 inch cartridge tape drive of the peripheral cabinet. Procedures for handling the 1/4 inch cartridge tape drive and the floppy drive are also included. Refer to the "System overview of the Xerox DocuPrint 180 LPS" chapter for additional information on the tape drives.

The first part of this chapter describes the procedures for handling the tape drives and magnetic and cartridge tapes. The rest of the chapter explains the procedures for managing offline print jobs. For each of these tasks, instructions are given for accomplishing the task using either the windows of the PC UI or keyed-in commands. Refer to the list below for the tasks described in this chapter:

- Power on the open-reel tape drive
- Load an open-reel tape
- Load an open-reel tape by hand
- Unload an open-reel tape
- Unload an open-reel tape during a power failure
- Power off the open-reel tape drive
- Handle open-reel tapes
- Power on the 1/2 inch cartridge tape drive
- Load a 1/2 inch cartridge
- Unload a 1/2 inch cartridge
- Power off the 1/2 inch cartridge tape drive
- Handle cartridge tapes
- Load a 1/4 inch cartridge tape
- Unload a 1/4 inch cartridge tape
- Handle 1/4 inch cartridge tapes
- Load a floppy disk
- Unload a floppy disk
- Handle floppy disks
- Offline printing tasks through windows of PC UI
- Offline printing tasks through command line
- Start an offline print job
- Rewind/unload tape
- Space
- Move

---

## Open-reel tape drive procedures

---

The following sections contain instructions for handling the open-reel tape drive.

---

### Power on the open-reel tape drive

---

To power on the open-reel tape drive:

- Step 1.** Press the Power switch to the ON position by pressing down on the side marked (see figure 7-1).

Figure 7-1. Power switch

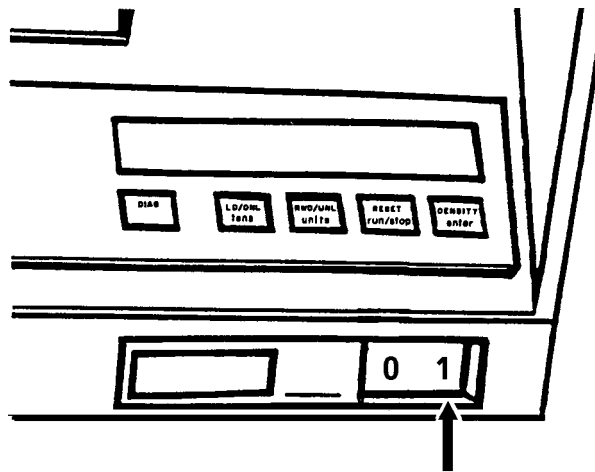

**Step 2.** Press the Reset button to open the loading door.

Figure 7-2. **Reset button**

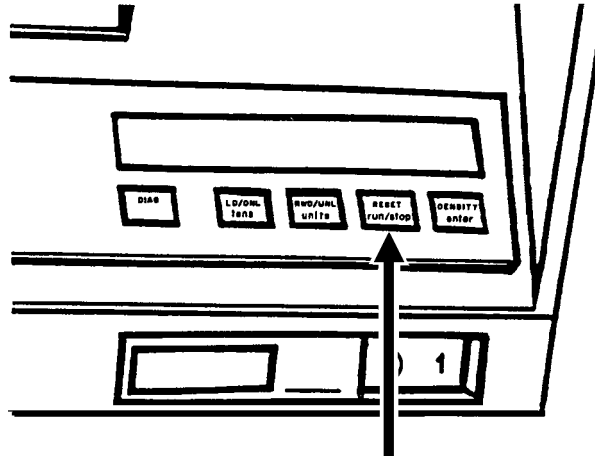

The loading door opens and you can load an open-reel tape.



**Note:** If "OK" appears on the message display, but the door is closed, press the Reset button to open it. If this fails, tap lightly on the door to open it

## Load an open-reel tape

Before loading a tape, ensure the following:

- The write enable ring is either:
  - On the tape to allow writing
  - Removed to prevent writing over existing data on the tape.
- The tape end is free; for new reels, remove the adhesive strip and/or rubber block that attaches the free end to the tape pack.

Follow this procedure to load a tape into the open-reel tape drive.

**Step 1.** Press the Reset button to open the tape loading door.

**Step 2.** Place the tape reel in the loading chamber and close the loading door.

The ring side should be facedown (see figure 7-3).

Figure 7-3. **Placing a tape in the loading chamber**

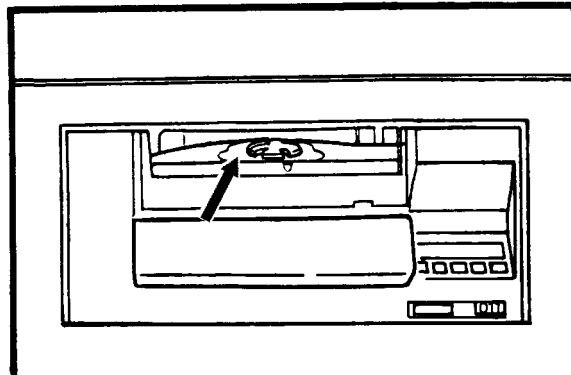

- "LOCATING" and then "LOCKING" appear on the tape drive message display.
- The self loading routine of the tape drive threads the tape.
- When the tape drive finds the BOT indicator, "Ld Point" appears on the tape drive message display and the tape drive is placed online.

## Load an open-reel tape by hand

If you need to load a tape by hand, follow this procedure.

- Step 1.** Press the Power switch to the OFF position by pressing down the side marked 0 (see figure 7-4).



**Warning:** This is essential for safety reasons.

Figure 7-4. Power switch

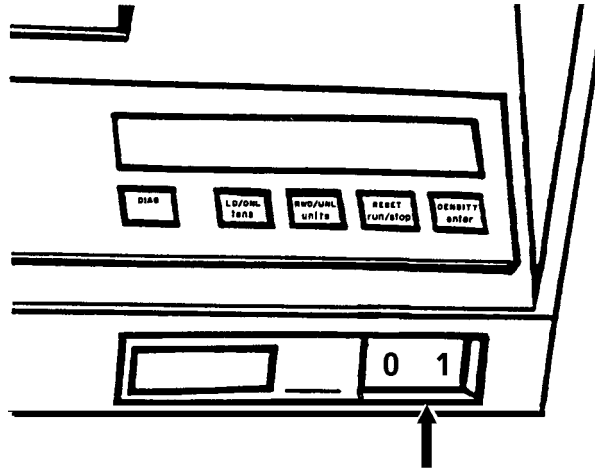

- Step 2.** Lift the cover of the peripheral cabinet (see figure 7-5).

Figure 7-5. Lifting the peripheral cabinet cover

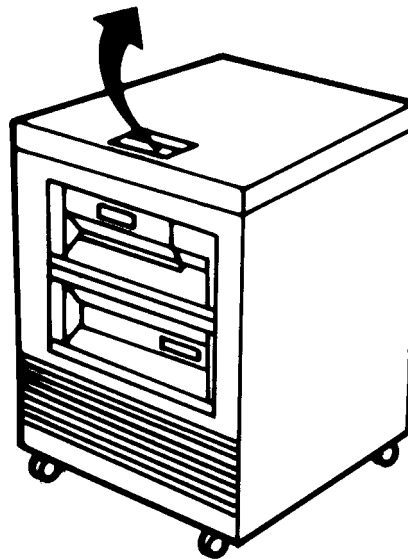

- Step 3.** Release the turnbuckles on the tape path cover by turning them counterclockwise (see figure 7-6)

Figure 7-6. Turnbuckles

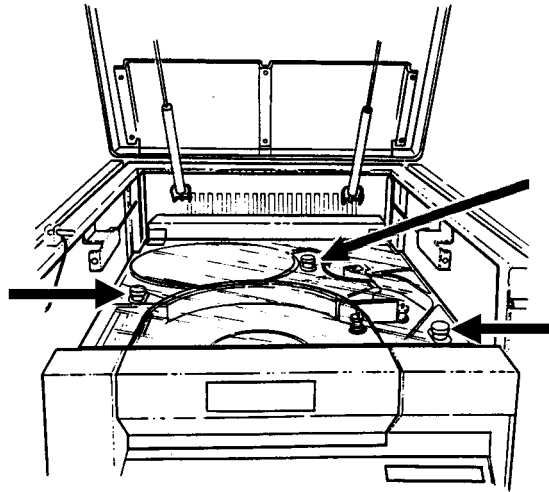

- Step 4.** Lift the tape path cover (see figure 7-7).

Figure 7-7. Lifting the tape path cover

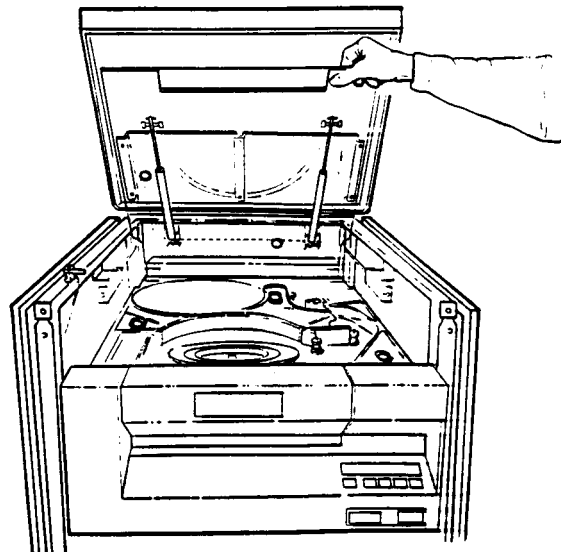



**Step 5.** Place the tape reel on the supply hub (see figure 7-8).

Figure 7-8. **Placing the tape reel on the supply hub**

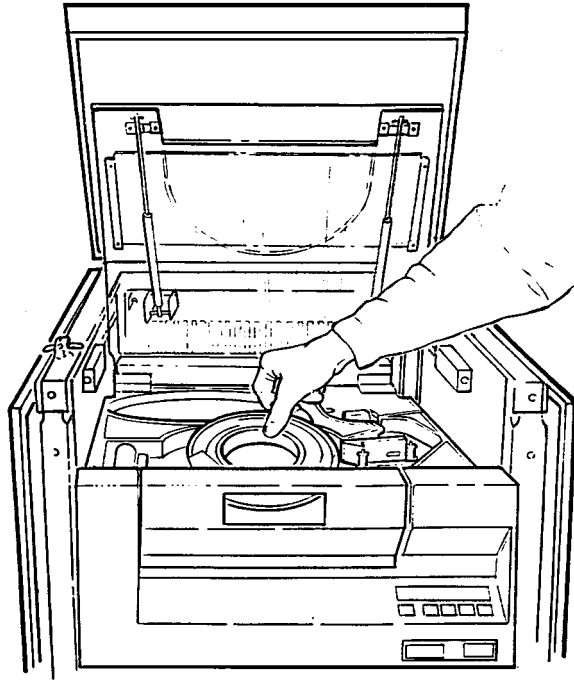

**Step 6.** Thread the tape to the take-up hub (see figure 7-9).

Figure 7-9. **Threading the tape**

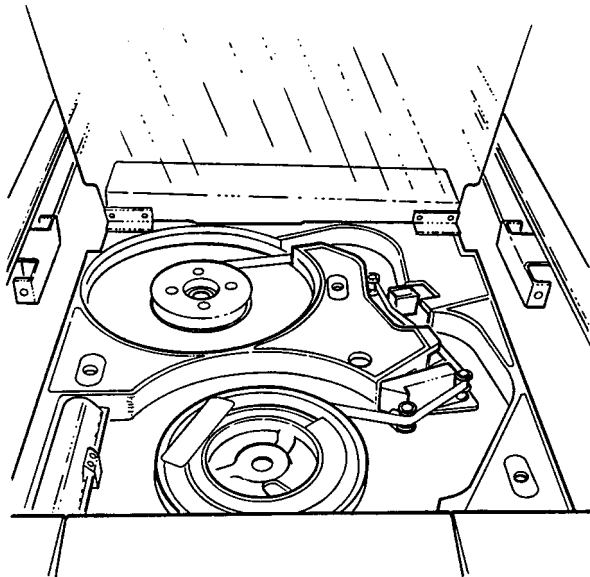

- Step 7.** Wind the tape clockwise for approximately two turns. Wind the take-up reel counterclockwise until the tape tightens (see figure 7-10).

Figure 7-10. **Winding the tape**

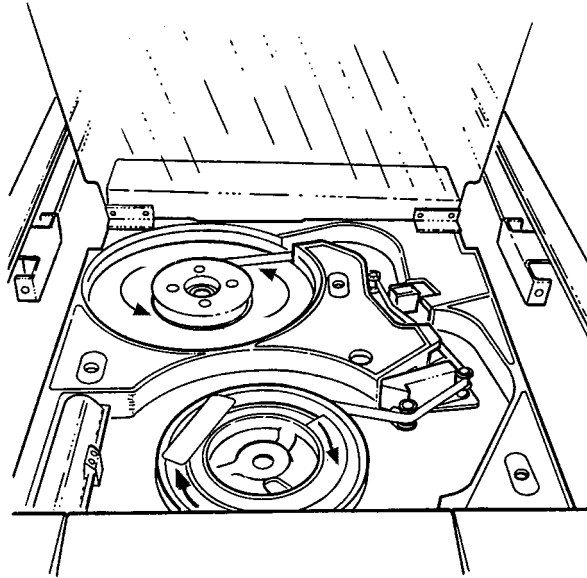

- Step 8.** Close the tape path cover and secure the turnbuckles by turning them clockwise.
- Step 9.** Close the cover of the peripheral cabinet and press the Power switch to the ON position by pressing down on the side marked 1 (see figure 7-11).

Figure 7-11. **Power switch**

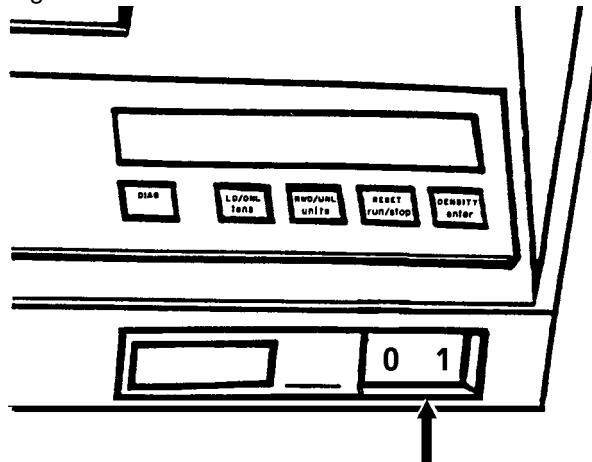

- Step 10.** When the tape drive finds the BOT indicator, "Ld Point" appears on the tape drive message display and the tape drive is placed online.

## Unload an open-reel tape

Before unloading a tape, ensure that the LPS system is not accessing the open-reel tape drive, to avoid loss of data. The tape drive should be offline and the message display should read "Ready" before you remove a tape.



**Note:** You can also rewind and/or unload a tape using the PC UI or system controller terminal. For instructions, refer to the "Rewind/unload tape" section later in this chapter.

### Place the tape drive offline

To take the open-reel tape drive offline, press the Reset button, or the Diag button if you are in Diagnostic mode (see figure 7-12).

Figure 7-12. Reset and Diag buttons

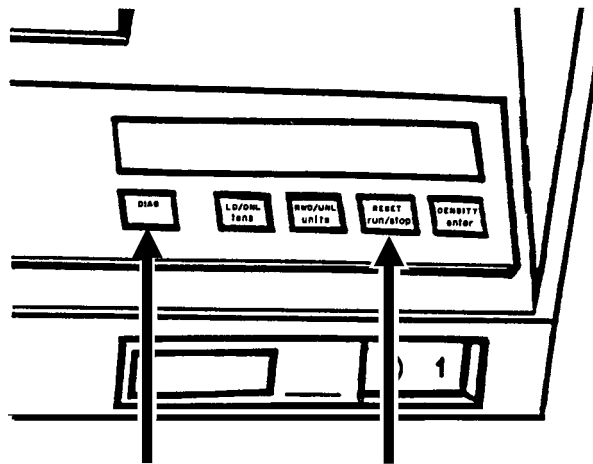

To unload a tape from the 9-track magnetic tape drive:

- Step 1.** When "Offline" appears on the message display, press and hold the Reset button and the Rwd/Unl button (see figure 7-13).

Figure 7-13. Reset and Rwd/Unl buttons

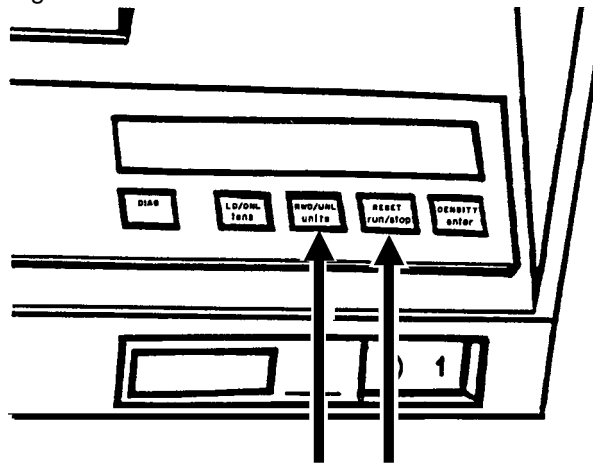

Then the following happens:

- The tape rewinds through beginning of tape (BOT).
- The tape reel is unclamped.
- The tape door opens.
- "OK" appears on the tape drive message display.

**Step 2.** Remove the tape.

## Unload an open-reel tape during a power failure

If power to the open-reel tape drive is cut off and you must unload the tape reel before power is restored, follow this procedure.

**Step 1.** Press the Power switch to the OFF position by pressing down the side marked 0 (see figure 7-14).



**Warning:** This is essential for safety reasons.

Figure 7-14. Power switch

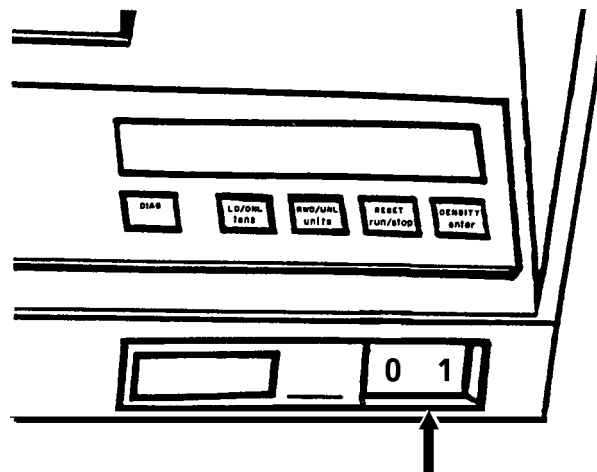

**Step 2.** Lift the cover of the peripheral cabinet (see figure 7-15).

Figure 7-15. **Opening the peripheral cabinet cover**

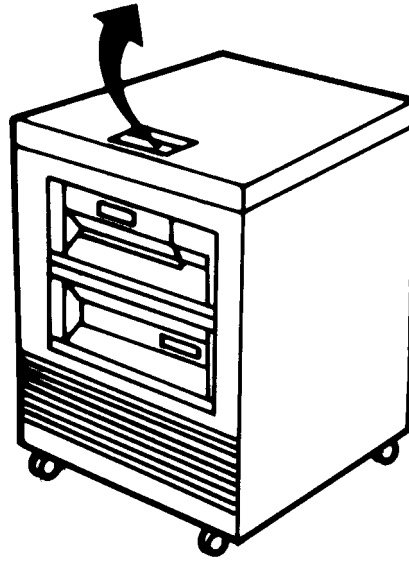

**Step 3.** Release the turnbuckles on the tape path cover by turning them counterclockwise (see figure 7-16).

Figure 7-16. **Turnbuckles**

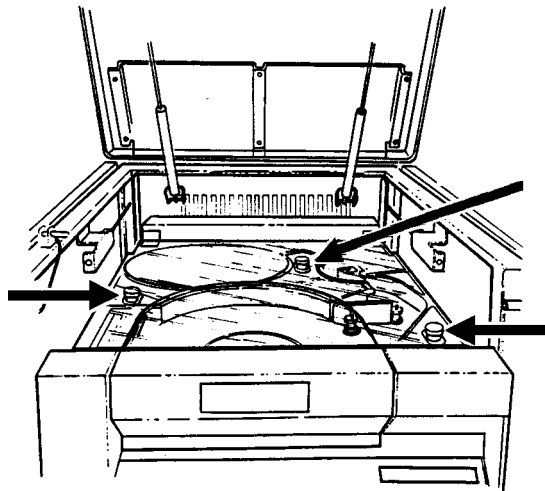

**Step 4.** Lift the tape path cover (see figure 7-17).

Figure 7-17. **Lifting the tape path cover**

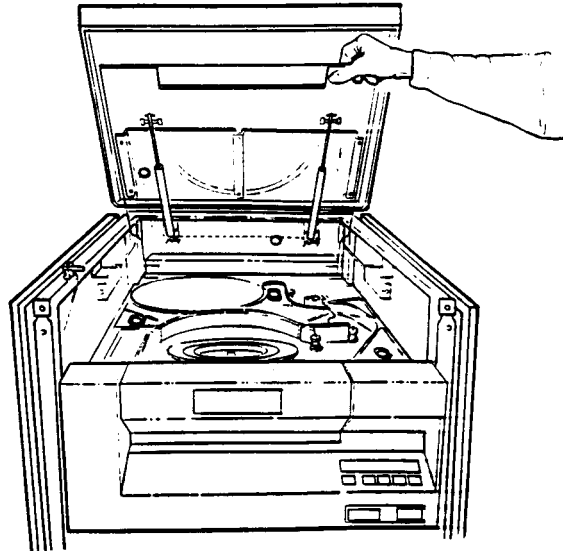

**Step 5.** Rotate the supply reel counterclockwise until all the tape is rewound (see figure 7-18).

Figure 7-18. **Rewinding the tape**

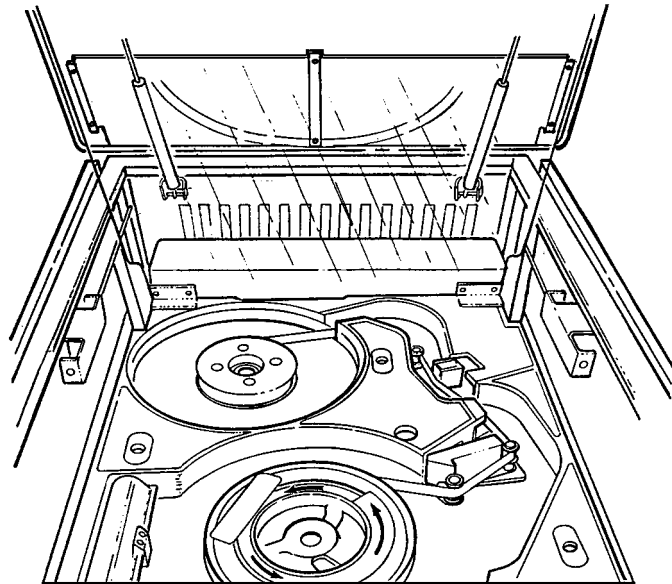

- Step 6.** Gently depress the Hub Release lever (see figure 7-19).

Figure 7-19. Hub Release lever

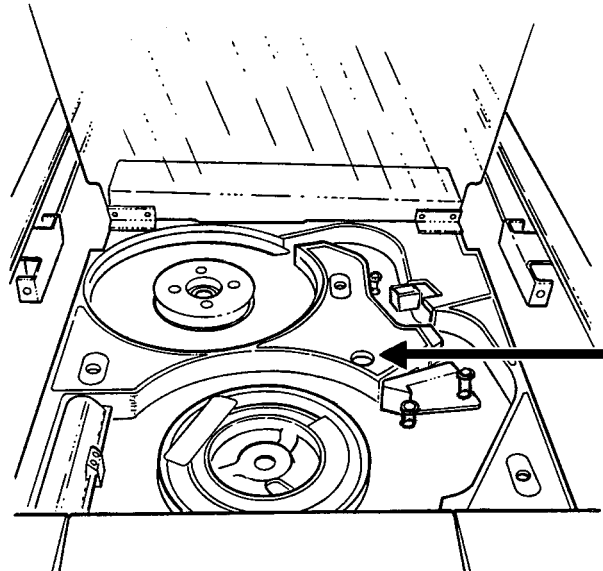

- Step 7.** While depressing the Hub Release lever, turn the tape reel counterclockwise to unclamp it.
- Step 8.** Carefully lift off the unclamped supply reel.
- Step 9.** Gently depress the Hub Release lever, again, and turn the hub counterclockwise until the clamp pads are fully retracted (see figure 7-20).

Figure 7-20. Turning the hub

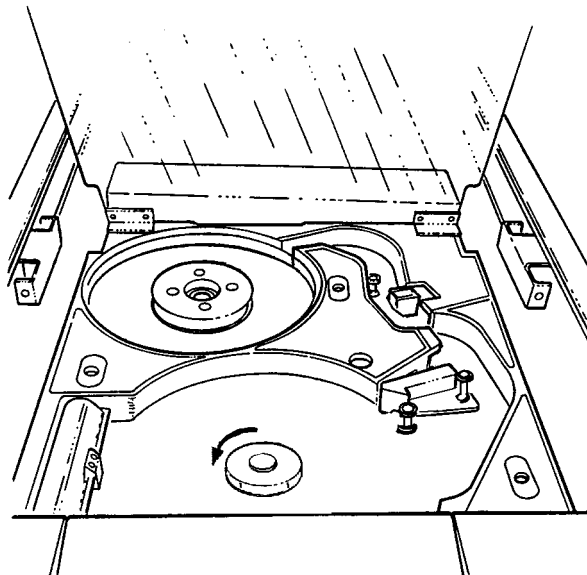

- Step 10.** Close the tape path cover and secure the turnbuckles by turning them clockwise.
- Step 11.** Close the cover of the peripheral cabinet.

## Power off the open-reel tape drive

To power off the open-reel tape drive, press the Power switch to the OFF position by pressing down on the side marked 0 (see figure 7-21).

Figure 7-21. Power switch

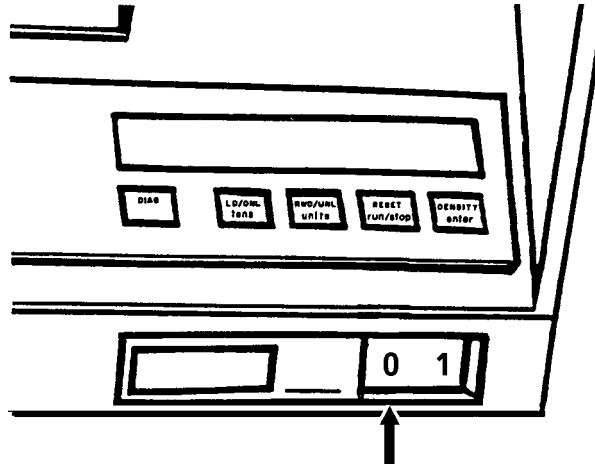

**Caution:** Unload the tape (or at least return it to BOT) before powering off the tape drive.



## Handle open-reel tapes

Since improper handling can cause damage to tapes and result in unreadable data, store tapes in their protective containers when they are not being used (see figure 7-22). Most read/write errors are caused by dust or dirt on the read/write head, transferred there by the tapes.

Figure 7-22. **Open-reel tapes and their protective containers**

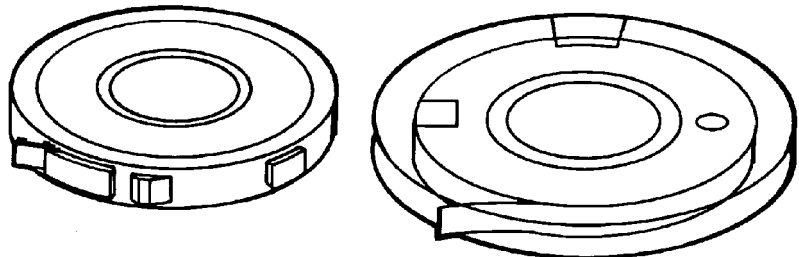

Make sure to follow these handling tips:

- Do not spill tape off the reel onto the floor or any dusty surface.
- Do not touch the flat sides of the tape between the beginning of tape (BOT) and end of tape (EOT) markers. In addition to possibly causing loss of data, oil from fingers attracts dust and dirt and leaves deposits on the read/write head.
- Do not smoke near the tape transport or tape storage area. Tobacco smoke and ash are especially damaging to tapes.
- Do not place tapes near line printers or other devices that produce paper dust.
- Do not place tapes near electric motors or any other magnetic sources that may erase data.
- Do not press the edges of the reel together. It can lead to tape edge damage when winding or unwinding tapes.
- Do not pull on the end of the tape to tighten it on the reel.
- Ensure the tape drive components are dry after cleaning them before loading the tape.
- Store tapes in the same climate-controlled environment in which you keep your system. Excessive heat can damage tapes.
- Store tapes vertically in racks.

### File protection

Files on an open-reel tape can be protected or written over, depending on whether or not there is a write-enable ring on the tape reel, sensed by the tape drive.

When the write-enable ring is absent, the tape is protected and you can perform only read functions, including printing data from the tape. When the write-enable is present, you can both read and write (add files) on that tape.

---

## 1/2 inch cartridge tape drive procedures

---

The following sections contain instructions for handling the 1/2 inch cartridge tape drive.

---

### Power on the 18/36 track 1/2 inch cartridge tape drive

---

To power on the 18/36 track cartridge tape drive, press the Power switch.

Figure 7-23. 18/36 track Power switch

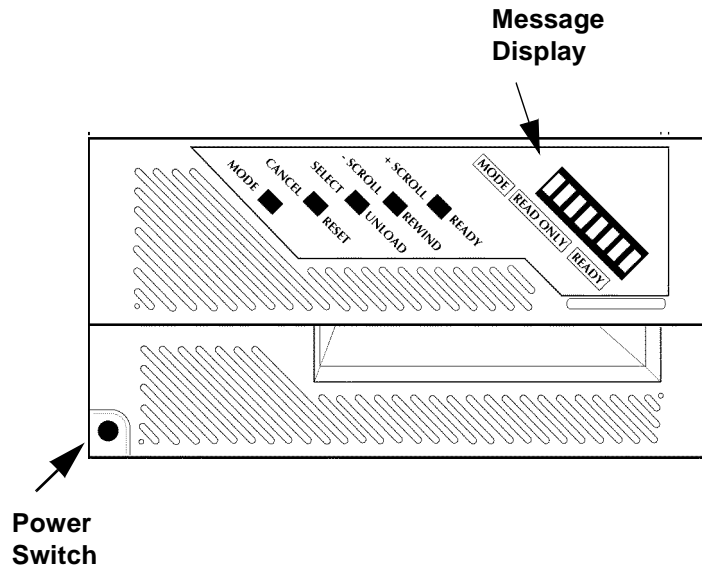

Diagnostics are performed and are listed on the message display.

**Place the tape drive online**

The 18/36 track drive must have a tape cartridge loaded before it can be placed online. If a cartridge is loaded but the drive is not online, press the Ready button to place the drive online.

Figure 7-24. Ready button

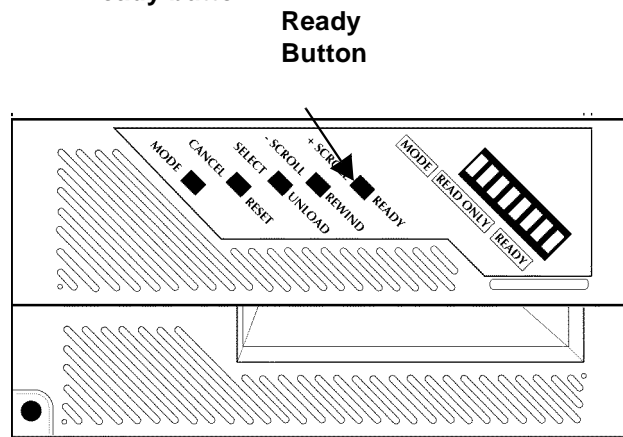

## Load a 1/2 inch cartridge

### Cartridge tape precautions

Before loading a cartridge, ensure it is not damaged. A damaged cartridge can prevent the tape from threading correctly and cause damage to the tape drive. A cartridge should not be used if the:

- Cartridge case is cracked or broken.
- Leader block or leader block latch is broken.
- File-protect selector is damaged.
- Label is peeling off.
- File protect sensor is damaged.
- Cartridge case contains any liquid.
- Cartridge has any other obvious damage.
- Tape was wound completely out of the cartridge onto the machine reel and then reattached to the cartridge reel.

If you have a damaged cartridge, substitute a back-up version of the data from another cartridge.

Follow this procedure to load a cartridge into the 1/2 inch cartridge tape drive.

- Step 1.** Hold the cartridge with the smooth side on top and the leader block toward the drive (see figure 7-28).

Figure 7-25. **Holding the 1/2 inch cartridge**

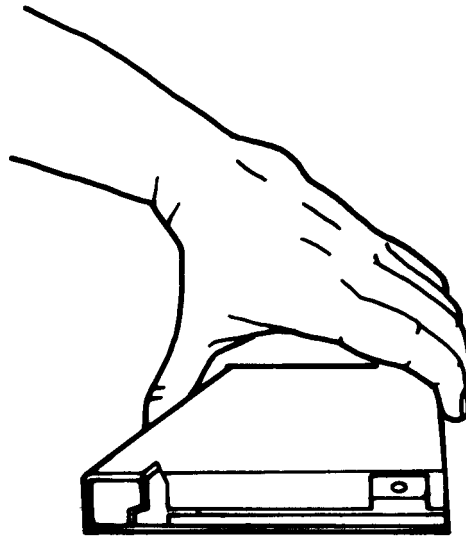

**Caution:** When you insert a cartridge, never force it.

- Step 2.** Insert the cartridge into the entry slot, and slide it all the way into the drive opening until it stops (see figure 7-29).

Figure 7-26. **Inserting the cartridge into the slot**

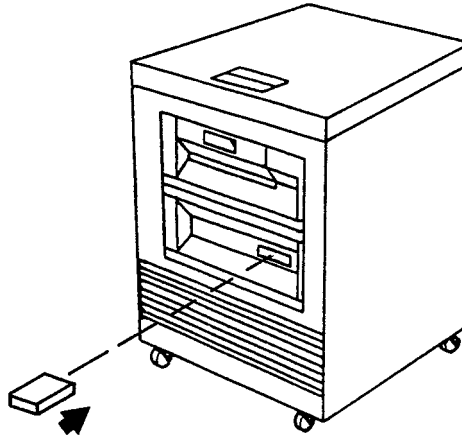

After about 15 seconds, the tape drive completes the loading process and the message display reads "ON LINE." The message display also shows whether the cartridge is file-protected (F) or unprotected (U).

## Unload a 1/2 inch cartridge

During normal operation:

**Automatic procedure** The tape drive automatically rewinds and unloads the cartridge when a job is finished, and the cartridge is ejected from the transport.

**Manual procedure** There may be times when you need to unload the cartridge manually. Follow this procedure:

To unload the 18/36 track cartridge manually, follow this procedure:

Press the Ready button to take the drive offline and then press the Unload button.

Figure 7-27. Ready and Unload buttons

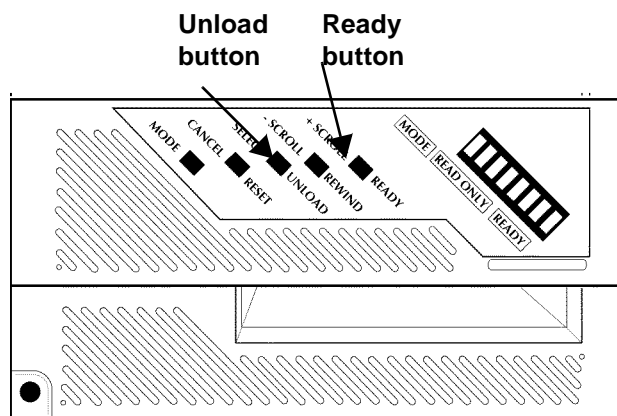

The message display shows the tape drive condition while the rewind and unload operation is in progress.

The cartridge is ejected from the transport.

Once the cartridge is ejected, you can remove it from the tape drive (see figure 7-32).

Figure 7-28. Removing the cartridge

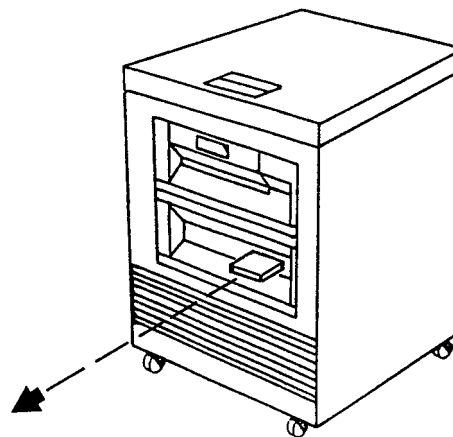



**Note:** You can also rewind and/or unload a tape using the PC UI or system controller terminal (non-U.S. markets only). For instructions, refer to the "Rewind/unload tape" section later in this chapter.

## Power off the 18/36 track 1/2 inch tape drive

Follow these instructions when powering off the tape drive.

Figure 7-29. Ready button

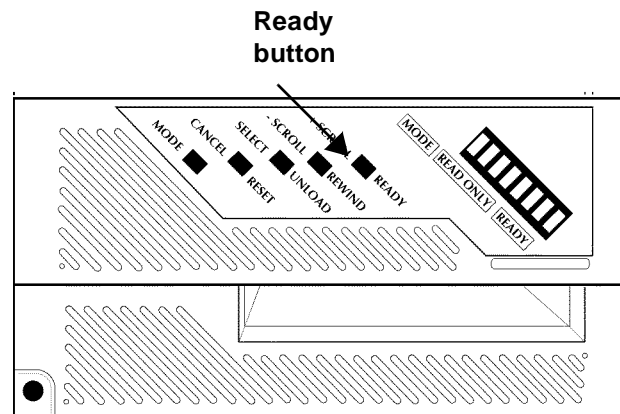

- Step 1.** Press and release the Ready button.
- Step 2.** If a cartridge is loaded in the tape drive, unload it. (Refer to the "Rewind/unload tape" section in this chapter.)
- Step 3.** Press and release the Power switch.

Figure 7-30. Power switch

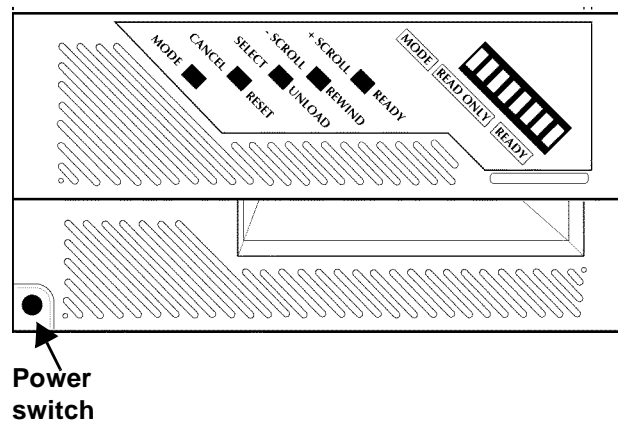

## Handle cartridge tapes

---

Follow these instructions when handling cartridge tapes:

- Never try to pry open the feed slot door or force a tape cartridge into or out of a drive.
- Never leave a cartridge in a tape drive when powering off. You could damage data on the tape and the tape drive components.
- When cartridges are not being used, store them vertically in a dirt-free area that matches as closely as possible the environment of the room where you have the tape system. If the temperature or humidity are different, bring cartridges into the tape system environment 24 hours in advance to condition them.
- Never remove the protective wrapping until you are ready to use the cartridge.
- Every time you pick up a cartridge, ensure the leader block is latched.
- Never carry two or more cartridges loose in a container. Leader blocks can snag on other cartridges and become unlatched.
- Keep cartridges clean and dry.
- Never release a leader block and pull tape from the cartridge.
- Never open a cartridge; you will probably damage the tape.
- Never expose the tape or cartridges to direct sunlight.
- Never smoke near the tape transport or cartridge storage areas. Tobacco smoke and ash are especially damaging to tapes.
- Never place cartridges near electric motors or any other magnetic sources that may erase data.
- To clean a cartridge, wipe off dust, dirt, and moisture with a lint-free cloth. If you must use a cleaning solution, ensure it is made specifically for cleaning cartridges. Never allow the solution to touch the tape.
- If a leader block (blank section at beginning of tape) comes off, but there is no other obvious damage to the cartridge or the tape, a leader block repair kit may be used. The kit allows you to reattach the block and use the cartridge one more time to copy the data onto a new cartridge.
- If a label starts to peel off, replace it immediately to avoid loading/unloading problems.
- Do not write on a label that is on a cartridge. If you want to change a label, fill out a new one, remove the old one, and replace it with the new one.
- Place the volume/serial number label on the side of the cartridge opposite the file-protect selector and the customer label on the top surface of the cartridge. Use the recessed areas provided for them. When you want a new label on a cartridge, remove the old one before you put on a new one. Figure 7-37 shows the 1/2 inch cartridge tape labels.



Figure 7-31. 1/2 inch cartridge tape labels

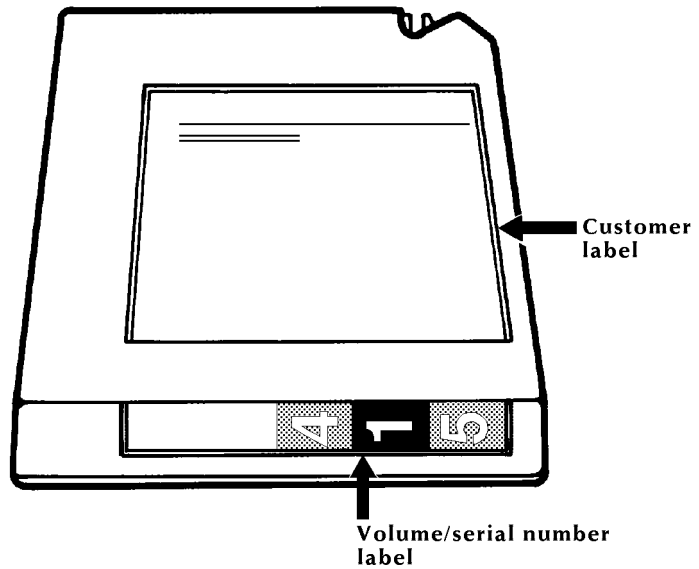

- Write on labels with markers that do not smear. Use only labels that leave no residue when removed.

### File protection

A 1/2 inch cartridge tape has a thumbwheel on the side of the cartridge that allows you to protect or write on a tape. When the white dot is showing in the window, the cartridge is protected and you can perform only read functions. When the white dot is not showing, you can both read and write on that tape. Figure 7-38 shows a 1/2 inch cartridge that is file protected (white dot showing).

Figure 7-32. File-protected 1/2 inch cartridge

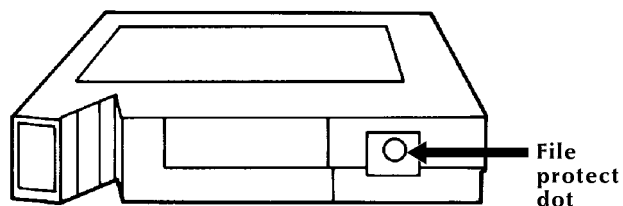

## 1/4 inch cartridge tape drive procedures

---

The following sections contain instructions for handling the 1/4 inch cartridge tape drive.

Figure 7-39 shows the components of the 1/4 inch cartridge tape drive.

Figure 7-33. 1/4 inch cartridge tape drive

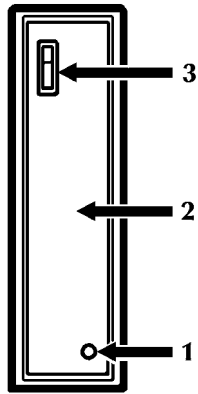

- 1 LED indicator
- 2 Door
- 3 Release button

---

## Load a 1/4 inch cartridge tape

---

To load a 1/4 inch cartridge tape:

- Step 1.** Press the Release button. The door opens partially.
- Step 2.** Manually open the door completely. Insert the cartridge into the feed slot with the label facing to the left.
- Step 3.** Close the door. The tape is automatically loaded and positioned at BOT.

The LED indicator is green when the tape is operating properly. If the indicator is flashing red, call for service.

Figure 7-34. **Inserting a cartridge**

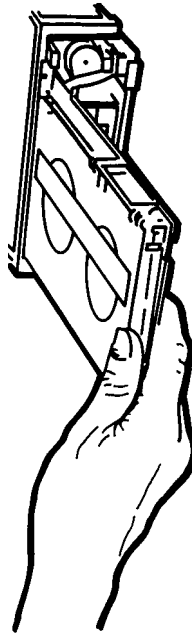

---

## Unload a 1/4 inch cartridge tape

---

To unload a 1/4 inch cartridge tape:

- Step 1.** Use the Rewind Tape task to rewind the tape. (Refer to the “Rewind/unload tape” section of this chapter.)
- Step 2.** Press the Release button to open the door. Lower the door manually.
- Step 3.** Carefully remove the cartridge.
- Step 4.** Close the door to prevent dust accumulation.

## Handle 1/4 inch cartridge tapes

---

Refer to the “Handle cartridge tapes” section earlier in this chapter.

### File protection

---

A 1/4 inch cartridge tape has a block file protect tab on the labeled side of the cartridge. When the arrow on the tab is pointing to the word “SAFE,” the cartridge tape is protected from being written over.

Figure 7-35. **File-protected 1/4 inch cartridge with the black tab pointing to SAFE**

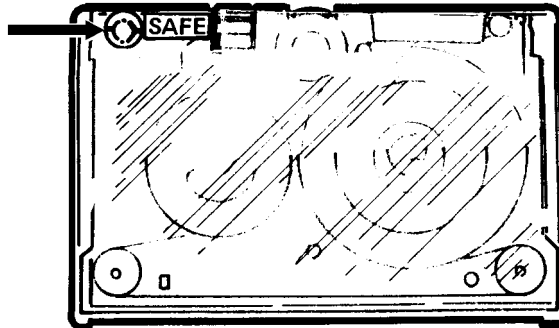

## Load a floppy disk

---

To load a floppy disk, insert the floppy disk label side up, until you hear a click.

## Unload a floppy disk

---

To unload a floppy disk, press the floppy eject button. The floppy disk will pop out slightly.

## Handle floppy disks

---

Floppy disks must be stored and handled properly to prevent damage. If a disk is damaged, files stored on it probably will be lost.

To help keep your floppy disks in good condition:

- Place identification labels on each disk, listing the names of the files it contains.
- Never attempt to clean a floppy disk.
- Never leave floppy disks on or near magnets or magnetized objects, such as telephones or the floppy disk drive. Exposure to magnetic fields can cause data loss.
- Never place heavy objects on top of a floppy disk.
- Never expose floppy disks to excessive heat or sunlight.

## Offline printing tasks through windows of PC UI

To select offline printing tasks using the windows of the PC UI:

**Step 1.** Open the Print Tasks menu icon.

The Print Tasks menu window appears, listing the available options (see figure 7-44).

Figure 7-36. **Print Tasks menu window**

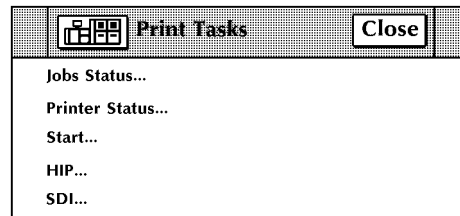

**Note:** You can also press the <F7> key to open the Start window.

**Step 2.** Select the "Start" option to open the Start window (see figure 7-45). You can also press the <F7> key to open the Start window.

Figure 7-37. **Start window**

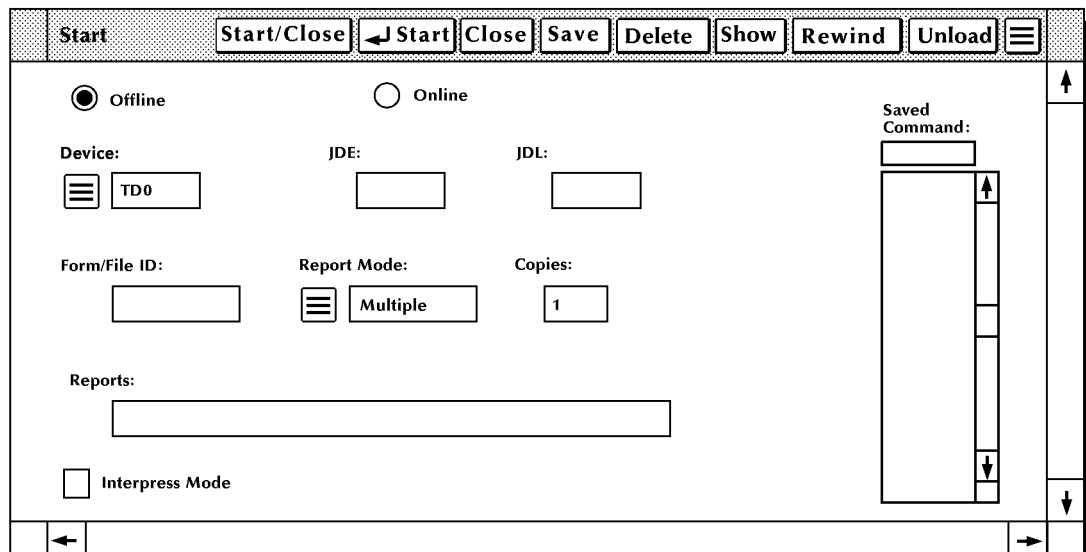

**Step 3.** Turn to the section of this chapter which explains the task in which you are interested.

---

## Offline printing tasks through command line

---

You can perform offline printing tasks by entering commands either:

- Through the Messages window of the PC UI
- Through the system controller terminal (non-U.S. markets).

To enter commands through the Messages window of the PC UI:

- Step 1.** Place the cursor in the window.
- Step 2.** Click once with the left mouse button.
- Step 3.** Enter the command.

If you are using the system controller terminal, use the keyboard to enter the command.

---

## Offline printing tasks

---

The following sections contain instructions for performing specific offline printing tasks.

---

### Start an offline print job

---

Use this task to begin printing an offline job.

**Start Job task through windows** Through windows:

- Step 1.** Select the Offline button.
- Step 2.** From the Start window, enter information in the appropriate field(s):
- **Device.** The tape drive you are using to print the job. (The tape device identifications are set up during sysgen. Refer to the *Xerox DocuPrint 180 LPS System Generation Guide* for additional information.)
  - **Report Mode.** There are two options for report mode:
    - Single. The LPS stops after each job is printed. You can then select the options for the next print job.
    - Multiple. The LPS prints all the reports continuously.The default for this field is "Multiple."
  - **JDE.** The name or number of the job descriptor entry. It may be up to eight characters in length.
  - **JDL.** The name or number of the job descriptor library, which contains the JDE task used. It may be up to eight characters in length.
  - **Copies.** The number of copies you want.
  - **Reports.** Allows you to specify the sequence and set of reports to be printed. For example, 1, 3-5, 2 directs the LPS to print the first report, then the third through the fifth, then the second.

If you do not use this option, the LPS assumes you want all jobs printed.

- **The Saved Commands menu** (directly beneath the Saved Command field) lists start commands.
  - To add commands to the list:
    - a. Enter the appropriate job information in the input fields.
    - b. Enter a start command name (up to eight characters in length) in the Saved Command field.
    - c. Select the Save header button.
  - To start a job from the list:
    - a. Select that job's start command from the Saved Commands menu. The job's information appears in the input fields.



**Note:** You can also display job information for a start command by entering the start command name in the Saved Command field and selecting the Show header button. The job's information now appears in the input fields.

- b. Select the Start header button to start the job.
  - To delete a start command from the command library:
    - a. Highlight the saved start command.
    - b. Select the Delete header button from the header auxiliary menu.

**Step 3.** Select either:

- **Start.** Start the print job.
- **Start/Close.** Start the print job and close the window.

**Start Job task through command line**

To start an offline print job, enter the following command:

```
START [[jde],[jdl],[S | M],[copies] [,[[REPORTS:r1,r2,...]
[,TDn] | [,TDn]] | [DISC:file.ext FORM=form.frm]]]]]
```

Table 7-1 lists each parameter and its description.

Table 7-1. **START command parameters and descriptions**

| Parameter                               | Description                                                                                                                                                                                                                                                                                                                                                                      |
|-----------------------------------------|----------------------------------------------------------------------------------------------------------------------------------------------------------------------------------------------------------------------------------------------------------------------------------------------------------------------------------------------------------------------------------|
| START                                   | Specifies the command, to be followed by any or all of the specifications as needed (often abbreviated as STA).                                                                                                                                                                                                                                                                  |
| <i>jde</i>                              | The name or number of the job descriptor entry, which may be up to six characters in length.                                                                                                                                                                                                                                                                                     |
| <i>jdl</i>                              | The name or number of the job descriptor library which contains the <i>jde</i> used. The name or number may be up to six characters in length.                                                                                                                                                                                                                                   |
| <b>S</b>                                | Single report mode processes only one report at a time. Use this mode when changes must be made to the job specification from one report to the next. The system assumes multiple report mode if you insert a comma instead of <b>S</b> or <b>M</b> .                                                                                                                            |
| <b>M</b>                                | Multiple report mode means that the LPS continuously processes all reports in the job. Processing automatically sequences from report to report, volume to volume, until all reports are processed. The system assumes multiple report mode if you insert a comma instead of <b>S</b> or <b>M</b> .                                                                              |
| <i>copies</i>                           | The requested number of prints for each report.                                                                                                                                                                                                                                                                                                                                  |
| <b>REPORTS</b> :<br><i>r1,r2</i>        | Allows you to specify the sequence and set of reports to be processed. In the example that follows, the LPS was directed to print the first report, then the third through the fifth, and finally the second. The system assumes you want prints of all the reports if you do not use this option. You are not required to use a comma if the <b>REPORTS</b> option is not used. |
| <b>TDn</b>                              | Specifies the tape device being used.<br><br><b>Notes:</b><br><br>1. The tape device identifications are set up during sysgen. Refer to the <i>Xerox DocuPrint 180 LPS System Generation Guide</i> for additional information.<br><br>2. You cannot select a tape device when you have selected <b>DISC</b> or <b>FORM</b> .                                                     |
| <b>DISC</b> : <i>file-name.filetype</i> | Indicates you want to print a file stored on the system disc.                                                                                                                                                                                                                                                                                                                    |
| <b>FORM</b> = <i>Form-name.Frm</i>      | Indicates you want to print a form stored on the system disc.                                                                                                                                                                                                                                                                                                                    |

**Example:** STA 21,POWGRP,M,2,REPORTS:1,3-5,2 means start to process or print from the JDE called 21, the JDL file called POWGRP, in multiple report mode, two prints each of reports 1, 3-5, and 2.



## Rewind/unload tape

The Rewind/Unload Tape task allows you to do the following from the PC UI or system controller terminal:

- Rewind a tape to BOT
- Rewind a tape and unload it from the take-up reel, clearing the tape path.

### Rewind/Unload Tape task through windows

To rewind a tape, select the Rewind header button from the Start window. A message appears when the tape is rewind.

To unload a tape, select the Unload button from the Start window. A message appears when the tape is unloaded.

### Rewind/Unload Tape task through command line

To rewind a tape, enter the following command:

**TAPE[CARTRIDGE | TD $n$ ] REWIND**

Table 7-2 lists the parameter and its description.

Table 7-2. **TAPE command parameter and description**

| Parameter | Description                                                                                                                                                                               |
|-----------|-------------------------------------------------------------------------------------------------------------------------------------------------------------------------------------------|
| TD $n$    | The tape drive you are using. (The tape device identifications are set up during sysgen. Refer to the <i>Xerox DocuPrint 180 LPS System Generation Guide</i> for additional information.) |

To unload a tape, enter the following command:

**TAPE[CARTRIDGE | TD $n$ ] UNLOAD**

Refer to table 7-2 for a description of the TD $n$  parameter.

## Space

The Space task allows you to print a specific job (or jobs) by spacing over pages or reports on a tape.

To move forward, enter a positive number; to move backward, enter a negative number.

If you have already started a print job:

- Step 1.** Stop the print job.
- Step 2.** Perform the Space task.
- Step 3.** Continue the print job.

**Space task through windows** Perform the following steps:

- Step 1.** Select the "Space" option from the header auxiliary menu of the Start window to open the Space window.

Figure 7-38. **Space window**

- Step 2.** Select one of the following options:
  - **Number of Pages.** Enter the number of pages you want to space forward or backward within the current report.
  - **Number of Reports.** Enter the number of print jobs you want to space forward or backward on the tape.
  - **Report Number.** Enter the number of the print job you want to space to on the tape.
- Step 3.** Select the appropriate header button:
  - **Apply/Close.** Apply your selection and close the window.
  - **Apply.** Apply your selection.
  - **Close.** Close the window.

**Space task through command line**

To space over pages within a report, enter the following command:

**SPACE *n* PAGES**

*n* is the number of pages.

To space over reports, enter the following command:

**SPACE *n* REPORTS**

*n* is the number of reports.

## Move

The Move task allows you to position a tape forward or backward a specific number of files or blocks.



**Note:** After using the Move task, you must reset the system before changing to another device.



**Note:** While the Move task is being processed, input stops and a message appears telling you that the tape is being positioned. You must press the Continue button to resume input processing of any active jobs.

### Move task through windows

Perform the following steps:

- Step 1.** Select the “Move” option from the header auxiliary menu of the Start window to open the Move window.

Figure 7-39. Move window

- Step 2.** Select one of the following options:
- **Files.** Select this button and enter the number of files you want to position the tape forward (a positive number) or backward (a negative number).
  - **Blocks.** Select this button and enter the number of blocks you want to position the file forward (a positive number) or backward (a negative number).
- Step 3.** Select the appropriate header button:
- **Apply/Close.** Apply your selection and close the window.
  - **Apply.** Apply your selection.
  - **Close.** Close the window.

**Move task through command line**

Enter the following command:

**MOVE *n* {files | blocks}**

*n* is the number of files or blocks you want to move forward or backward on the tape. A positive number positions you forward; a negative number positions you backward.



---

## 8.

## HIP printing tasks

This chapter contains procedures for accessing remote host systems (XPAF, or DocuPrintServer (formerly XPSM)) and printing jobs and receiving files from them, using Host Interface Processor (HIP) software.

Where applicable, instructions are given for accomplishing the tasks using either the windows of the PC UI or keyed-in commands. Refer to the list below for the tasks described in this chapter:

- HIP printing tasks through windows of PC UI
- HIP printing tasks through command line
- Enter HIP communication mode (through command line)
- Select a communication mode
- Place HIP online
- Take HIP offline
- Start a HIP print job
- Stop HIP print jobs
- Abort HIP print jobs
- HIP jobs status
- End HIP

## HIP printing tasks through windows of PC UI

To select HIP printing tasks using the windows of the PC UI:

**Step 1.** Open the Print Tasks menu icon.

The Print Tasks menu window appears, listing the available options (see figure 8-1).

Figure 8-1. **Print Tasks menu window**

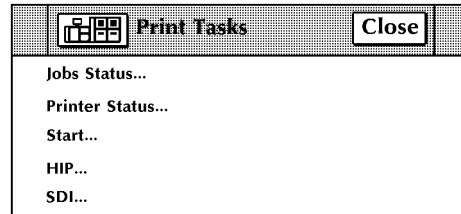

**Step 2.** Select the "HIP" option to open the HIP window (see figure 8-2).

Figure 8-2. **HIP window**

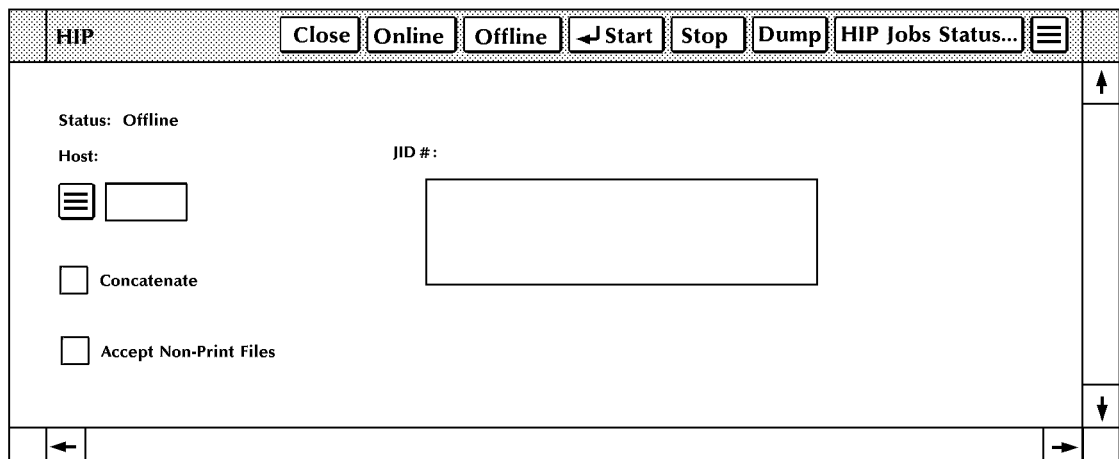

**Step 3.** Turn to the section of this chapter which explains the task in which you are interested.



## HIP printing tasks through command line

---

You can perform HIP printing tasks by entering commands either:

- Through the Messages window of the PC UI
- Through the system controller terminal (non-U.S. markets only).

To enter commands through the Messages window of the PC UI:

- Step 1.** Place the cursor in the window.
- Step 2.** Click once with the left mouse button.
- Step 3.** Enter the command.

If you are using the system controller terminal, just use the keyboard to enter the command.

---

## HIP printing tasks

---

The following sections contain instructions for performing specific HIP printing tasks.

## Enter HIP communication mode

Use this task to enter HIP communication mode.



**Note:** This task is not necessary if you are using the PC UI windows.

### Enter HIP Communication Mode task through command line

Enter the following command:

**HIP [option[,option[,...]]]**

HIP options are provided in this chapter in the task sections; however, for a complete list and explanation of all available HIP options, refer to the *Xerox DocuPrint 180 LPS Operations Reference*.

Note the following:

- If your LPS has only one host and it is set up as the default host in HIP.LIB, or if only one host is set up in HIP.Lib, entering HIP has the same effect as entering HIP HOST, HIP ONLINE, and HIP START.
- If your LPS has more than one host, then the one which is set up as the default host in the HIP.Lib becomes active when you enter the HIP command. If you want to use another host, you must specify the host name.
- The first time you enter HIP after performing a system generation, you must specify a host name. This host is saved in the recovery file of the system disk. If you do not enter a host name, the following message appears:

```
HP2010 NO HOST SELECTED
```

- If the host is not online and responding, the following message appears every 15 seconds until the host comes online or HIP is terminated:

```
HP1240 HOST NOT RESPONDING
```



**Note:** Note that listed options are separated by commas while parameters are separated from the option keyword by a space.

The Xerox DocuPrint 180 LPS does not support the XNS host type. If XNS is selected as the host type, the following message will be displayed:

```
INVALID HOST SELECTED
```

### Command errors

If an error is detected in the command line, the incorrect part of the line is displayed. A message to correct and reenter the command is made as follows:

```
HP2300 COMMAND IN ERROR AT: (part of command in
error)
HP2310 RE-ENTER COMMAND
```

Some commands are not valid for all hosts, and some commands are not valid if a host is not selected. When this happens, one of the following messages appears:

HP1320 FUNCTION IS NOT SUPPORTED BY CURRENT HOST  
 HP2320 INVALID COMMAND WITH CURRENT HOST TYPE  
 HP2330 INVALID COMMAND WITH NO HOST SPECIFIED

## Select a communication mode

---

Use this task to select the HIP communication mode to use.



**Note:** This task is not necessary if your LPS has only one host.

### Select a Communication Mode task through windows

From the HIP window, select the mode you want from the Host field's auxiliary menu.

### Select a Communication Mode task through command line

Enter the following command:

#### **HIP HOST XPF**

HIP must be offline to change from one host to another. If the system is not offline or is not idle, the command is rejected and one or more of the following messages appears:

```
HP2020 SELECTED HOST NOT PRESENT ON SYSTEM
HP2400 HIP INTERFACE MUST BE OFFLINE. ENTER 'HIP
OFFLINE'.
HP7100 CANNOT CHANGE HOSTS WHILE JOBS ARE PENDING
OR ACTIVE.
```

## Place HIP online

---

Use this task to place the LPS online to the host.

### Place HIP Online task through windows

Select the Online header button from the HIP window.

### Place HIP Online task through command line

Select the Online header button from the HIP window.

Enter the following command:

#### **HIP ONLINE [ALL]**

The ALL parameter specifies that both print and nonprint files are accepted. The default is that only print files are accepted. As print jobs are received, they are entered into HIP's internal job queue and become eligible for submission to Operator Communications Subsystem (OCS) for printing. One of the following messages appears:

```
HP1210 HOST ONLINE. ACCEPTING ALL JOBS
HP1220 HOST ONLINE. ACCEPTING PRINT JOBS ONLY
HP2010 NO HOST SELECTED
HP2030 ALL NOT ALLOWED AT CURRENT LOGON LEVEL
HP0200 FAILED TO GO ONLINE
```



**Note:** ONLINE ALL is accepted in logon level class 2 and above for all hosts

If the selected host is not online and responding, the following message appears every 30 seconds until the host comes online or the online request is terminated by the HIP OFFLINE command:

```
HP1240 HOST NOT RESPONDING
```

## Take HIP offline

---

Use this task to take HIP offline. The LPS no longer accepts jobs from the host.

### Take HIP Offline task through windows

Select the Offline header button from the HIP window.

### Take HIP Offline task through command line

Enter the following command:

#### **HIP OFFLINE**

The system's response is delayed to the end of the current file if a file is being transmitted. The following messages appear:

```
HP1200 OFFLINE PENDING END OF TRANSMISSION
HP1207 OFFLINE PENDING END OF CURRENT ACTIVE XPF
SESSION
HP1230 HOST OFFLINE
```

## Start a HIP print job

---

Use this task to start or continue printing jobs from HIP's internal job queue.



**Note:** The host must be selected and HIP online before you use this task.

### Start Job task through windows

To start or continue printing jobs, select one of the following:

- The Start header button to print the job normally.
- The Dump header button to print the next job in the queue as a formatted data dump for analysis.

To start a particular print job:

**Step 1.** Enter the job number in the JID# field.

**Step 2.** Select one of the following:

- The Start header button
- The Dump header button to submit the job as a formatted data dump for analysis.

To start accepting nonprint files (fonts, forms, or other files), select the Accept Non-Print Files box.

To start processing HIP jobs in concatenation mode, select the Concatenate box.

To clear the job queue, select the “Reset” option from the header auxiliary menu.

A confirmation window appears.

- Select Yes to reset the job queue.
- Select No to cancel the Reset request.

To display information about a job:

- Step 1.** Enter the job number in the JID# field.
- Step 2.** Select the “Job Information” option from the header auxiliary menu to open the Job Information window.

To display HIP buffer/version information, select the “Buffer/Version” option from the header auxiliary menu to open the Buffer/Version window.

To save one of the jobs in the HIP job queue as a file on the system disk:

- Step 1.** Select the “Change” option from the header auxiliary menu of the HIP window to open the Change window (see figure 8-3).

Figure 8-3. **Change window**

- Step 2.** Enter the HIP job number in the JID# field and the name you want to assign to the file in the File ID field.
- Step 3.** Select the appropriate header button:
- **Apply/Close.** Save the job as a file on the system disk and to close the window.
  - **Apply.** Save the job as a file on the system disk.
  - **Close.** Close the window.



**Note:** There are additional options that can be accessed only from Logon Level 3 or above. Refer to the *Xerox DocuPrint 180 LPS PC User Interface Reference* for information on these options.

**Start Job task through command line**

To start or continue printing jobs from HIP's internal job queue, enter the following command:

**HIP START [DUMP][JID[,...]]**

If no jid (job identification) parameters are specified, the entire queue is processed in the order the jobs were received (or as reordered by a previous START command).

If jids are specified, those jobs are reordered to the top of the job queue, so they will be the next jobs submitted to OCS for processing. Jobs that have already been submitted to OCS cannot be reordered. The START commands issued to OCS are displayed when the job is submitted.

If the optional DUMP parameter is specified, the specified job, or the next job in the HIP's queue, is submitted using the START command parameters specified by the DUMPJOB command in the HIP file. Only one job is submitted. After the job is submitted, HIP effects a HIP STOP command.

If any listed jid is not eligible, it is listed in the message:

```
HP1150 CANNOT START JOB(S): n [, ...]
```

Note that HIP may be taken offline temporarily with the HIP START command. Should this occur, processing automatically continues where it left off when HIP is put online again; that is, files are accepted immediately from the host and printed from HIP's internal job queue.

If printing is to stop while the printing system is taken offline and brought back online, enter the HIP STOP command. (Refer to the next section of this chapter.)

---

**Stop HIP print jobs**

Use this task to stop HIP from submitting jobs for printing.

**Stop Jobs task through windows**

Select the Stop header button from the HIP window.

**Stop Jobs task through command line**

Enter the following command:

**HIP STOP**

Jobs already submitted for processing are not affected and are processed.



**Note:** If jobs are being processed in job concatenation mode, enter HIP DRAIN instead.

## Abort a HIP print job

Use this task to abort a specific job or all jobs from the HIP job queue.



**Note:** You can abort only HIP jobs whose status is Receive or Pending.

### Abort Job task through windows

Through windows:

- Step 1.** Select the “Abort” option from the header auxiliary menu of the HIP window to open the HIP Abort window (see figure 8-4).

Figure 8-4. **HIP Abort window**

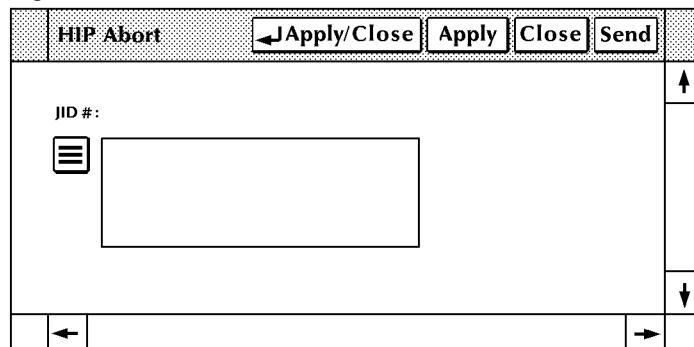

- Step 2.** Select one of the following options:

- Enter a job ID number in the Job ID field.



**Note:** You can find the ID number for a specific job through the HIP Jobs Status task.



**Note:** You can also use the HIP Jobs Status window to abort HIP jobs.

- Select “All” from the header auxiliary menu to abort all jobs in the job queue.

- Step 3.** Select the appropriate header button:

- **Apply/Close.** Abort the job(s) and close the window.
- **Apply.** Abort the job(s).
- **Close.** Close the window.
- **Send.** Specify that a HIP-to-host file transmission job is to be aborted.
- Select Yes to continue with the abort task.
- Select No to cancel the task.

**Abort Job task through command line** Enter the following command:

**HIP ABORT {ALL | *job-id*[,*job-id*...]}**

Table 8-1 lists each parameter and its description.

Table 8-1. **HIP ABORT command parameters and descriptions**

| Parameter                           | Description                                                                                                      |
|-------------------------------------|------------------------------------------------------------------------------------------------------------------|
| ALL                                 | Causes all jobs in the job queue to abort.                                                                       |
| [ <i>job-id</i> ],[ <i>job-id</i> ] | One or more HIP job numbers you want to abort. You can find the HIP job number through the HIP Jobs Status task. |

## HIP jobs status

Use this task to display a list of the jobs in the HIP job queue.

**HIP Jobs Status task through PC UI** Perform the following steps:

- Step 1.** Select the “HIP Jobs Status” option from the HIP window’s header auxiliary menu to open the HIP Jobs Status window.

Figure 8-5. **HIP Jobs Status window**

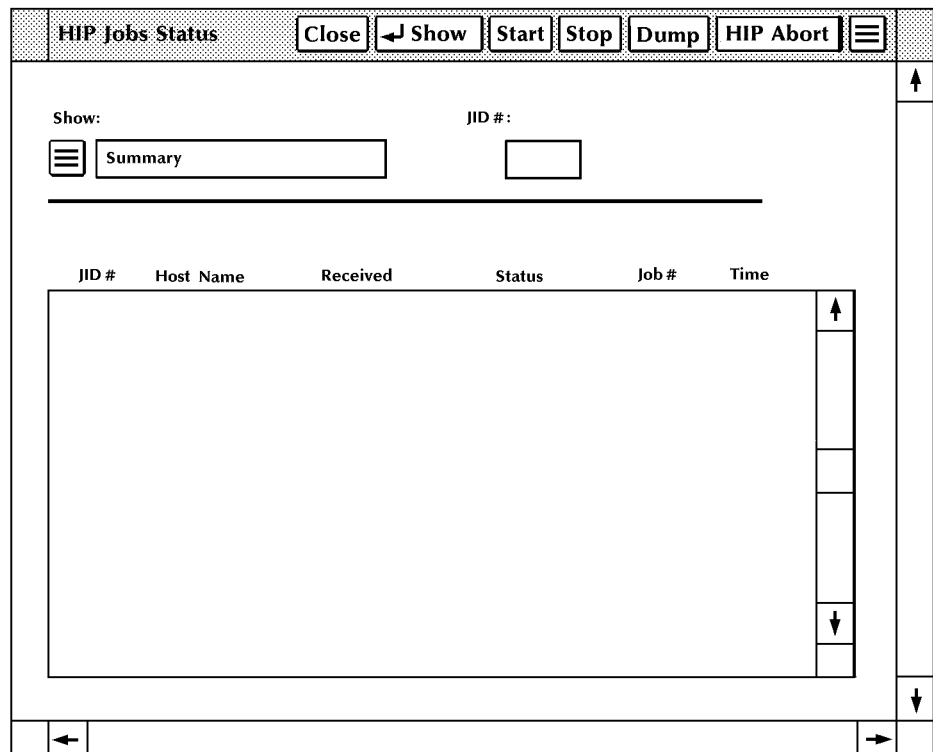



The HIP Jobs Status window:

- Displays a list of all jobs in HIP's internal queue
- Contains header buttons that allow you to perform most of the same tasks as the HIP window. Refer to the appropriate section of this chapter for instructions on performing those tasks.

**Step 2.** To view the HIP job queue, select one of the following options from the auxiliary menu next to the Show field.

- **Aborted.** Display all aborted jobs.
- **Active.** Display all active jobs, that is, jobs that are Queued, Active, OQueued, or Printing.
- **All.** Display all jobs in all queues.
- **Cancelled.** Display all cancelled jobs.
- **Completed.** Display all completed jobs, that is, Printed, Stored, Sent, or Aborted.
- **Pending.** Display all jobs in the Pending state, that is, Pending or Receiving, but not submitted to OCS.
- **Printed.** Display all jobs in the printed state, that is, Printed or Truncated.
- **Sent.** Display all files sent to the host.
- **Stored.** Display all files stored by the host.
- **Summary.** Display a summary of the job queue.



**Note:** The default of the Show option is "Summary." A summary of the job queue is displayed when you first open this window.

**Step 3.** Select the Show header button. The display box in the window work area now reflects your Show field selection.

**HIP Jobs Status task through system controller terminal (non-U.S. markets only)**

Enter the following command:

**HIP SHOW JOBS [parameter]**

This command displays the current status of the selected jobs in the HIP jobs queue as well as the current status of the HIP processor. The format of the display depends on the parameter.

Table 8-2 lists each parameter and its description.

Table 8-2. **HIP SHOW JOBS command parameters and descriptions**

| Parameter | Description                                                                                                       |
|-----------|-------------------------------------------------------------------------------------------------------------------|
| ABORTED   | Display all jobs that have been aborted.                                                                          |
| ACTIVE    | Display all jobs in the active state: QUEUED, ACTIVE, OQUEUED, or PRINTING.                                       |
| ALL       | Display all jobs in all queues.                                                                                   |
| CANCELLED | Display all jobs that have been cancelled.                                                                        |
| COMPLETED | Display jobs in a completed state: PRINTED, STORED, SEND, or ABORTED.                                             |
| CONTINUE  | Continue a previously requested display if all jobs in the queue were not displayed.                              |
| PAGE[n]   | Divide the queue up to 20 jobs, which are ordered from the oldest completed job to newest completed job received. |
| PENDING   | Display all jobs in the pending state: PENDING or RECEIVING (but not submitted to the OCS).                       |
| PRINTED   | Display the jobs in the printed state: PRINTED or TRUNCATED.                                                      |
| SENT      | Display all files that have been sent to the host.                                                                |
| STORED    | Display all files that have been stored by the host.                                                              |
| SUMMARY   | Display a summary of the job queue. (See figure 8-6.)                                                             |

Figure 8-6. Sample summary job queue display

| JID#                      | HOST NAME   | RECEIVED | STATUS        | JOB# | TIME     |
|---------------------------|-------------|----------|---------------|------|----------|
| nnnn                      | <host name> | hh:mm:ss | status        | 000  | hh:mm:ss |
| .                         | .           | .        | COMPLETED     | .    | .        |
| .                         | .           | .        | COMPLETED     | .    | .        |
| .                         | .           | .        | STORED        | .    | .        |
| ...                       | and n more  |          | COMPETED jobs |      |          |
| .                         | .           | .        | PRINTING      | .    | .        |
| .                         | .           | .        | ACTIVE        | .    | .        |
| .                         | .           | .        | PENDING       | .    | .        |
| .                         | .           | .        | PENDING       | .    | .        |
| .                         | .           | .        | PENDING       | .    | .        |
| .                         | .           | .        | PENDING       | .    | .        |
| .                         | .           | .        | PENDING       | .    | .        |
| ...                       | and n more  |          | PENDING jobs  |      |          |
| .                         | .           | .        | RECEIVE       | .    | .        |
| HP1110 END OF JOB DISPLAY |             |          |               |      |          |

The normal job queue display screen consists of:

- Two lines of header information
- Up to 20 lines of jobs status information
- A message indicating the end of the display.

Note the following:

- If there are fewer than 20 jobs in the selected state, only that number is displayed.
- If there are more than 20 jobs in the selected state, all jobs are not shown and the following message appears:

HP2145 ENTER 'HIP SHOW JOBS CONTINUE' FOR MORE.

To display the additional jobs, enter the following command:

**HIP SHOW JOBS CONTINUE**

Figure 8-7 shows the format of a normal display screen

Figure 8-7. Example of HIP job status display

| HOST:hst:linemode         | HIP:runmode | FILEMODE:filemode |        |      |          |
|---------------------------|-------------|-------------------|--------|------|----------|
| JID#                      | HOST NAME   | RECEIVED          | STATUS | JOB# | TIME     |
| nnnn                      | host name   | hh:mm:ss          | status | 000  | hh:mm:ss |
| .                         | .           | .                 | .      | .    | .        |
| .                         | .           | .                 | .      | .    | .        |
| .                         | .           | .                 | .      | .    | .        |
| HP1110 END OF JOB DISPLAY |             |                   |        |      |          |

Table 8-3 lists each field and its description.

Table 8-3. **HIP jobs status display fields and descriptions**

| Field    | Description                                                                                                                                                                                                                                                                                                                                                                                                                                                                                                                                                                                                                                                                                                                                                                                                                                                                                                                                                                                                                                                                                                                                                                                                                                                                                                                                                                                                                                                                  |
|----------|------------------------------------------------------------------------------------------------------------------------------------------------------------------------------------------------------------------------------------------------------------------------------------------------------------------------------------------------------------------------------------------------------------------------------------------------------------------------------------------------------------------------------------------------------------------------------------------------------------------------------------------------------------------------------------------------------------------------------------------------------------------------------------------------------------------------------------------------------------------------------------------------------------------------------------------------------------------------------------------------------------------------------------------------------------------------------------------------------------------------------------------------------------------------------------------------------------------------------------------------------------------------------------------------------------------------------------------------------------------------------------------------------------------------------------------------------------------------------|
| hst      | Specifies one of the possible hosts ( XPF).                                                                                                                                                                                                                                                                                                                                                                                                                                                                                                                                                                                                                                                                                                                                                                                                                                                                                                                                                                                                                                                                                                                                                                                                                                                                                                                                                                                                                                  |
| linemode | Specifies the status of the host interface (OFFLINE, ONLINE PEND, READY, RECEIVING, SENDING, or SUSPENDED).                                                                                                                                                                                                                                                                                                                                                                                                                                                                                                                                                                                                                                                                                                                                                                                                                                                                                                                                                                                                                                                                                                                                                                                                                                                                                                                                                                  |
| runmode  | Specifies the jobs run mode (STARTED, STOPPED, DUMP, or CONCATENATED).                                                                                                                                                                                                                                                                                                                                                                                                                                                                                                                                                                                                                                                                                                                                                                                                                                                                                                                                                                                                                                                                                                                                                                                                                                                                                                                                                                                                       |
| filemode | Specifies the acceptable file types (ALL JOBS or PRINT JOBS).                                                                                                                                                                                                                                                                                                                                                                                                                                                                                                                                                                                                                                                                                                                                                                                                                                                                                                                                                                                                                                                                                                                                                                                                                                                                                                                                                                                                                |
| nnnn     | Specifies the internal job identification number (JID) for HIP.                                                                                                                                                                                                                                                                                                                                                                                                                                                                                                                                                                                                                                                                                                                                                                                                                                                                                                                                                                                                                                                                                                                                                                                                                                                                                                                                                                                                              |
| hostname | Indicates the host name on the file label                                                                                                                                                                                                                                                                                                                                                                                                                                                                                                                                                                                                                                                                                                                                                                                                                                                                                                                                                                                                                                                                                                                                                                                                                                                                                                                                                                                                                                    |
| 0000     | Specifies the job number assigned by OCS when the job is submitted for printing. It is 0000 for nonprint and pending jobs.                                                                                                                                                                                                                                                                                                                                                                                                                                                                                                                                                                                                                                                                                                                                                                                                                                                                                                                                                                                                                                                                                                                                                                                                                                                                                                                                                   |
| hh:mm:ss | Specifies the time a job was received and when its status was last changed.                                                                                                                                                                                                                                                                                                                                                                                                                                                                                                                                                                                                                                                                                                                                                                                                                                                                                                                                                                                                                                                                                                                                                                                                                                                                                                                                                                                                  |
| status   | <p>Specifies the current status of a job, which is one of the following:</p> <ul style="list-style-type: none"> <li>• RECEIVE: The job is currently being received.</li> <li>• SENDING: The job is currently being sent.</li> <li>• PENDING: The job is waiting to be sent.</li> <li>• QUEUED: The job is in OCS job queue waiting to be processed.</li> <li>• ACTIVE: The job is being processed by input and/or output.</li> <li>• OQUEUED: Input phase is complete and the job is queued for printing.</li> <li>• PRINTING: Input phase is complete and printing is in progress.</li> <li>• TRUNCATED: The transfer was ended before completion.</li> <li>• COMPLETED: The job was completed normally.</li> <li>• STORED: The file was stored in a permanent file directory.</li> <li>• SENT: The file was successfully sent to the host.</li> <li>• ABORTED: The job was aborted by a HIP or OCS ABORT command.</li> <li>• HOSTABORT: The job was aborted by the host command.</li> <li>• REJECTED: The transfer from the host to the OEM was rejected.</li> <li>• CANCELLED: The transfer was cancelled by a host restart.</li> <li>• STOREFILE: The job is a file to be stored, not printed.</li> <li>• CONCATENATED: The job is a concatenated job.</li> <li>• RETAINDATA: The data from the job is retained for HIP CHANGE.</li> <li>• HOLDJOB: The job is retained due to HIP CHANGE.</li> <li>• PASSTHROUGH (XPF, only): The job is a pass through job.</li> </ul> |

---

## End HIP

---

Use this task to shut down HIP in an orderly manner. When using this task, the following occurs:

- The current files being received, transmitted, or printed (if any) are completed.
- The internal HIP job queue is saved on the system disk for later restart.
- The following message appears in the Messages window of the PC UI or the system controller display:

```
HP1020 HOST INTERFACE PROCESSOR UNLOADED
```

- The connection to the current host is sent offline.

### End HIP task through windows

Select the "End" option from the HIP window's header auxiliary menu.

### End HIP task through command line

Enter the following command:

**HIP END**



---

## 9. Status and print tasks

Where applicable, instructions are given for accomplishing the task using either the windows of the PC UI or keyed-in commands. Refer to the list below for the tasks described in this chapter:

- Status and print tasks through windows of PC UI
- Status and print tasks through command line
- Understanding clusters
- Printer status
- Select feeder trays
- Select stacker bins
- Tray loading
- Clusters
- Ordered stock
- Transparencies
- Select units through windows
- Purge feed
- Lower trays and bins
- Set tray size
- Set container size
- Bin full criteria and setting bin limits
- Separate
- Jobs status
- Configure feeding or finishing device through windows
- Notepad through windows.

## Status and print tasks through windows of PC UI

---

To select status and print tasks using the windows of the PC UI:

**Step 1.** Open the Print Tasks menu icon.

The Print Tasks menu window appears, listing the available options (see figure 9-1).

Figure 9-1. **Print Tasks menu window**

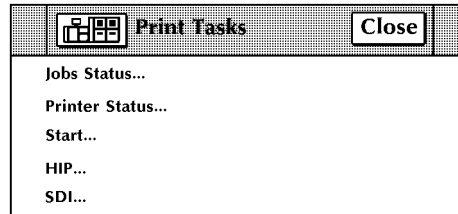

**Step 2.** Refer to the section of this chapter which explains the task in which you are interested.

---

## Status and print tasks through command line

---

You can perform status and print tasks by entering commands either:

- Through the Messages window of the PC UI
- Through the system controller terminal (non-U.S. markets).

To enter commands through the Messages window of the PC UI:

**Step 1.** Place the cursor in the window.

**Step 2.** Click once with the left mouse button.

**Step 3.** Enter the command.

If you are using the system controller terminal, use the keyboard to enter the command.



---

## Understanding clusters

---

A cluster is a group of related feeder trays. The trays assigned to a cluster usually contain the same size and type of paper. All trays within a cluster are considered equal when the LPS identifies which tray will feed a sheet of paper. This allows common stock to feed from more than one tray.

Clusters are set up and named by the person who creates the job. The cluster name consists of 1 to 6 alphanumeric characters, beginning with an alphabetic character. The name can represent the type of stock used in the job (for example, BLUE). The cluster definition and name allow the LPS to locate the feeder trays with the correct paper stock used for a specific job. Clusters allow you to use more than one size of paper within a job and to use groups of trays within a job as if they were only one tray.

Based on messages from the LPS, you load the correct stock into the feeder trays and tell the LPS which stock is in which tray (refer to the "Tray loading and clusters" section later in this chapter). The LPS then selects the stock as required by the print job, selecting a feeder tray for each page by checking the cluster name and paper size associated with the page.

You can display the current clusters, override the preferred trays recommended by the cluster, or choose a specific cluster or tray to be used for feeding paper for a job. For additional information on clusters, refer to the *Xerox DocuPrint 180 LPS Operations Reference*.

## Status and print tasks

---

The following sections contain instructions for performing specific status and print tasks.

### Printer status

---

Use this task to display the current status of the feeder trays and stacker bins. You see the following information:

- **Cluster names.** The name of the cluster(s) (currently in use) defined for each feeder tray.
- **Feeder tray state.** The state can be one of the following:
  - In Use. The tray is in the current stockset (though paper may not be feeding from it right now).
  - Ready. The tray is ready to feed paper.
  - Not Available. For example, the tray is broken.
  - Busy. The tray elevator is raising or lowering.
  - Lowered. The tray elevator is down.
  - Empty. The tray does not contain any paper.
- **Feeder tray size.** Name or measurement of paper currently assigned to the tray.
- **Paper tray levels.** The levels depicted indicate:
  - Empty
  - 1/4 ream
  - 1/2 ream
  - 3/4 ream
  - 1 ream
  - 2 reams
  - 3 reams
  - 4 reams
  - Full.
- **Stacker bin state.** The state can be one of the following:
  - In Use. The current print job is stacking in the bin.
  - Ready. The bin is ready to receive output.
  - Not Available. For example, the bin is broken).
  - Busy. The bin elevator is raising or lowering.
  - Lowered. The bin elevator is down.
- **Stacker bin size.** The size is either:
  - None. The bin is empty and containers are not being used. Any size output can be stacked in the bin.
  - x by y. The size of paper or container and paper currently stacked in the bin.



**Note:** When various sized paper is stacked in a bin, the size displayed indicates the largest paper width and length.

- **Stacker bin levels.** The levels depicted indicate:
  - Empty
  - 1 ream
  - 2 reams
  - 3 reams
  - 4 reams
  - Full.
- **Output bin mode.** The mode is either:
  - Auto. When the first bin is full, stacking automatically switches to the next bin.
  - Separate. The report switches to the next bin at the report boundary.



**Note:** The Output Bin mode displays on the bin that is currently in use.

Note the following:

- You can also access the Printer Status window (PC UI) or display by pressing the <PRINTER STATUS> key.
- The printer control console also provides a mimic of the printer showing some of the same information specified in this section.
- If you have the system controller terminal, or are running print jobs using command files, you will not see all of the information listed in the previous section.

**Printer Status task through PC UI windows**

Select "Printer Status" from the Print Tasks menu to open the Printer Status window (see figure 9-2).



**Note:** If you are running print jobs using command files, follow the instructions in the "Printer Status task through command line" section.

Figure 9-2. **Printer Status window**

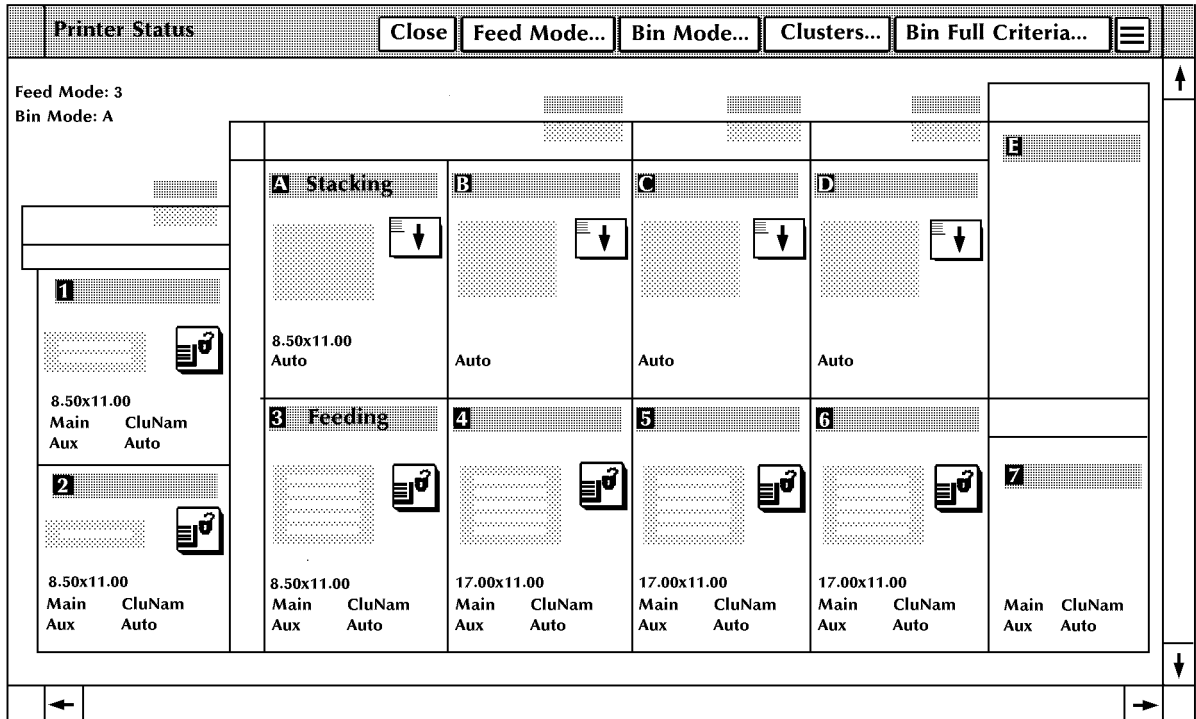

The Printer Status window provides:

- A mimic of the printer, showing:
  - Current status of all paper trays, including the size of paper loaded in the tray
  - Current status of all stacker bins, including the size of paper stacked in the bin
  - Current report's cluster names.
- Header buttons allowing you to perform tray, bin, and cluster tasks.



**Note:** The sizes on the feeder tray and stacker bin mimics appear in inches or millimeters depending on the selection of the Units window. To choose the unit of measurement, select the "Units" option from the Printer Status window's header auxiliary menu. Then select the Inches or Millimeters radio button. (Refer to the "Select Units" section of this chapter for additional information.)

**Printer Status task through command line**

Enter the following command:

**PSTATUS**

If you have the PC UI and are not currently running print jobs using command files, the Printer Status window appears. Otherwise, the selection and status information appears in the Messages window (PC UI) or on the terminal screen. Figure 9-3 shows an example of HIP job status display.

Figure 9-3. **Example of HIP job status display**

|                      |          |               |              |
|----------------------|----------|---------------|--------------|
| IOT State:           |          | Client-layer: |              |
| Current feed mode:   |          | feed mode     |              |
| Current select mode: |          | select mode   |              |
| Tray:                | Status:  | Paper level:  | Paper size:  |
| 1                    | Selected | 1/2 full      | 11.5 by 8.0  |
| 2                    | Ready    | Full          | 11.5 by 8.0  |
| 3                    | Ready    | Full          | 11.5 by 8.0  |
| 4                    | Ready    | 1/4 full      | 14.0 by 11.5 |
| 5                    | Ready    | full          | 11.5 by 8.0  |
| 6                    | Ready    | full          | 11.5 by 8.0  |
| Bin:                 | Status:  | Paper level:  | Paper size:  |
| A                    | Selected | 1/2 full      | 8.5 by 11.00 |
| B                    | Ready    | Empty         | 8.5 by 11.00 |
| C                    | Ready    | Unavailable   | Unavailable  |
| D                    | Ready    | Empty         | Empty        |



**Note:** When there is information about which you should be specifically aware, that information flashes on the display. For example, if you had keyed in SEL AUTO when one of the stacker trays is not empty, the message EMPTY ME flashes instead of the READY message.

## Select feeder trays

Use this task to override stock selections in the print job and force printing of a job using a specific tray, cluster, or a feeding device.

### Select Feeder Trays task through windows

Perform the following steps:

- Step 1.** Select the Feed Mode header button from the Printer Status window to open the Feed Mode window (see figure 9-4).

Figure 9-4. **Feed Mode window**

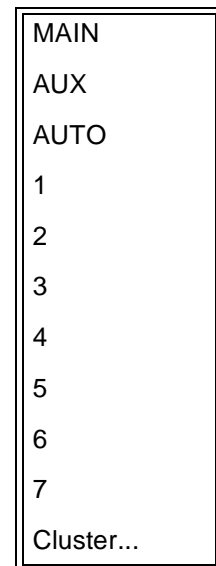

**Note:** Options 5, 6, and 7 only appear if the system is configured with these parts.

- Step 2.** Select one of the following options:

- To use the clusters set up in the print job, select MAIN from the Feed Mode window.
- To feed paper from the Aux cluster, select AUX from the Feed Mode window.
- To feed paper from all trays, select AUTO from the Feed Mode window.
- To feed paper using a specific cluster, select Cluster... to open the cluster window, then select an option from the displayed list.
- To feed paper from a specific tray, select the tray number from the Feed Mode window.
- To feed paper from a bulk feeder, select 7 from the Feed Mode window.

**Select Feeder Trays task  
through command line**

To use the clusters set up in the print job, enter the following command:

**FEED MAIN**

To feed paper from the Aux cluster, enter the following command:

**FEED AUX**

To feed paper from all trays, enter the following command:

**FEED AUTO**

To feed paper using a specific cluster, enter the following command:

**FEED *cluster name***

*cluster name* is the name of the cluster you want to use.

To feed paper from a specific tray, enter the following command:

**FEED *tray number***

*tray number* is the number of the tray you want to use.

To feed paper from a bulk feeder, enter the following command:

**FEED 7**

## Select stacker bins

Use this task to select the bin(s) used for stacking printed pages. You can also select the sample tray or a finishing device as the output destination.

The stacking order default is AUTOMODE, which specifies that:

- Stacker A is used first.
- The printed pages are sent to Stacker B when A is full, Stacker C when A and B are full, etc.

If you specify a different stacking order through this task:

- If the LPS is printing, the output goes to the selected bin (unless it is full).
- When the selected bin is full, the LPS sends output to the next empty bin that can accept the paper size.
- If no bin is available that can accept the paper size, the printer stops and you must unload the bin(s).
- If you select the sample tray, all printed pages are delivered there until the report ends or you change the stacker bin selection.

### Select Stacker Bins task through windows

Perform the following steps:

- Step 1.** Select the Bin Mode header button from the Printer Status window to open the Bin Mode window (see figure 9-5).

Figure 9-5. **Bin Mode window AUTO**

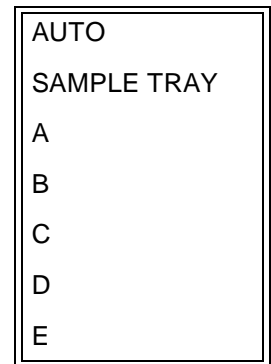

**Note:** Options C, D and E appear in the Bin Mode window only if the system is configured with these options.



**Step 2.** Select one of the following:

- AUTO. This is the default selection.
- SAMPLE TRAY. The sample tray is used.
- A. Stacker bin A is used first.
- B. Stacker bin B is used first.
- C. Stacker bin C is used first.
- D. Stacker bin D is used first.
- E. The finishing device is used.

**Select Stacker Bins task through  
command line**

To select the AUTOMODE stacking order, enter the following command:

**SELECT AUTO**

To select the sample tray, enter the following command:

**SELECT TRAY**

To select Stacker A, enter the following command:

**SELECT A**

To select Stacker B, enter the following command:

**SELECT B**

To select Stacker C, enter the following command:

**SELECT C**

To select Stacker D, enter the following command:

**SELECT D**

To select the finishing device, enter the following command:

**SELECT E**

## Tray loading

Use the Tray Loading task to respond to system messages concerning stockset problems for the current print job.

**Tray Loading task through PC UI** Perform the following steps:

**Step 1.** A confirmation window appears when the system encounters problems with the stockset (see figure 9-6).

Figure 9-6. **Confirmation window (tray loading)**

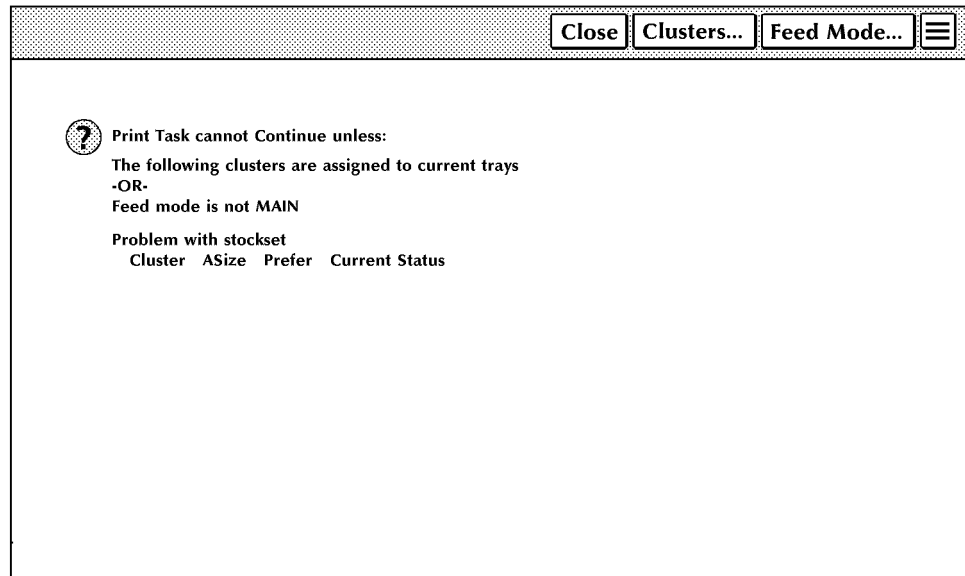

The confirmation window:

- Displays cluster names used in the current job and the trays in which they are currently loaded (current trays)
- Contains the undefined cluster names required for the job and the trays in which they should be loaded (preferred trays)
- Contains instructions for dealing with the stockset problem.

The confirmation window allows you to:

- Access the Clusters window to select the preferred loading pattern or other trays
- Access the Feed Mode window to change the feed mode to any tray or a specific cluster.

**Step 2.** Select the appropriate header button:

- Clusters. Open the Clusters window.
- Feed Mode. Open the Feed Mode window.
- Close. Close the confirmation window.

**Tray Loading task through system controller terminal (non-U.S. markets only)**

Perform the following steps:

- Step 1.** When a print job calls for a stock change, the existing clusters appear on the system controller display. The current trays field is blank for undefined clusters.

Refer to the following example.

|       |      |              |               |              |
|-------|------|--------------|---------------|--------------|
| BLUE  | ASIZ | ---PREFER--  | ---CURRENT--- | ---STATUS--- |
|       |      | -            | 1 3           | HAS TRAYS    |
|       |      | 1 3          |               |              |
| GREEN | ASIZ | ---PREFER--- | ---CURRENT--- | ---STATUS--- |
|       |      | 2            |               | IS DEFINED   |

- Step 2.** Load the correct stock in the correct trays.

- Step 3.** To define the current trays for the undefined cluster, enter the following command:

**CLUSTER *cl-name tray number***

Table 9-1 lists each parameter and its description.

Table 9-1. **CLUSTER command parameters and descriptions**

| Parameter          | Description                                                     |
|--------------------|-----------------------------------------------------------------|
| <i>cl-name</i>     | Disables only the steady mode of the Attention light.           |
| <i>tray number</i> | The tray(s) in which stock for the cluster is currently loaded. |

## Clusters

Use the Clusters task to:

- Display all the clusters in the system with their preferred and current trays
- Define new clusters
- Edit preferred or current trays for existing clusters.



**Note:** You must define tray contents to the LPS when you change the stock in a tray being used by the current stockset without being prompted by the system to change the stock in that tray.

### Clusters task through windows

Perform the following steps:

- Step 1.** Select the Clusters header button from the Printer Status window to open the Clusters window.



**Note:** You can also access the Clusters window by selecting the Clusters header button from the Tray Loading confirmation window.

Figure 9-7. Clusters window

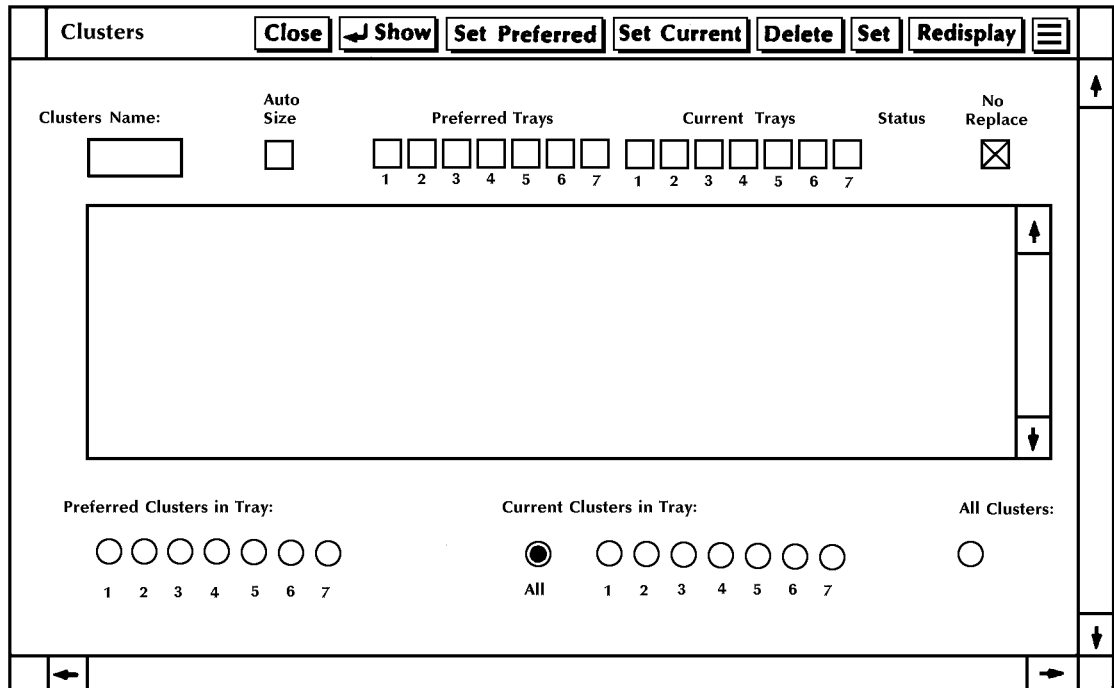

**Step 2.** Perform the steps for one of the following functions:

- Modify the cluster display
- Edit an existing cluster
- Delete an existing cluster
- Create a new cluster

The steps for each of these functions are listed next.

### Modify the cluster display

To modify the cluster display, do one of the following:

- Select the All button to display clusters that have current trays assigned to them.
- Select the All Clusters button to display all clusters in the system.
- Select the Current Clusters button for a tray number to display only clusters set up for that tray.
- Select the Preferred Clusters button for a tray number to display only preferred trays of all clusters using that tray.



**Note:** To update the display for your selection, select the Redisplay button.

### Edit an existing cluster

Perform the following steps:

**Step 1.** Highlight the cluster name in the display field.

The cluster name now appears in the Cluster Name field and the appropriate tray information appears in the check boxes.



**Note:** You can also display the cluster information by entering the cluster name in the Cluster Name field and selecting the Show header button.

**Step 2.** Select the box(es) above the tray number(s) you want to assign to the cluster or deselect the boxes above the tray numbers you want to remove from the cluster.

**Step 3.** Select either header button:

- **Set Preferred.** Assign the new preferred trays to the cluster.
- **Set Current.** Assign the new current trays to the cluster.

The tray information displayed for the cluster is updated with the new tray assignments.



**Note:** You can automatically assign the preferred trays to the current trays, for a cluster by entering the cluster name in the Cluster Name field and selecting the Set button.

**Delete an existing cluster** Perform the following steps:

- Step 1.** Highlight the cluster name in the display field.
- Step 2.** Select the Delete header button.

**Create a new cluster** Perform the following steps:

- Step 1.** Enter the new cluster name in the Cluster Name field.
- Step 2.** Select the box(es) above the tray number(s) you want to assign to the cluster.



**Note:** You assign only preferred trays to a new cluster.

- Step 3.** Select the Autosize box if you want to apply the autosize option to the new cluster. (Autosize allows you to load different size paper in different trays.
- Step 4.** Deselect the NR check box if you do not want to apply the No Replace option to the new cluster. (No Replace keeps all cluster definitions for trays, so that a tray can belong to more than one cluster. The default value of the No Replace check box is "selected.")



**Note:** Depending on how your system was set up, you may not have the NR option.

- Step 5.** Select the Edit Preferred header button to assign preferred trays to the new cluster.

**Clusters task through command line** To display all clusters in the system, enter the following command:

**CLUSTER**

To display all clusters and their preferred trays (without the current trays), enter the following command:

**CLP**

To create a new cluster or edit an existing cluster, enter the following command:

**CLUSTER** *cl-name* [SET | *n* | +*n* | -*n* | ALL | -ALL][*/NR*]

Table 9-2 lists each parameter and its description.

Table 9-2. **CLUSTER command parameters and descriptions**

| Parameter      | Description                                                              |
|----------------|--------------------------------------------------------------------------|
| <i>cl-name</i> | The name of the cluster.                                                 |
| SET            | Assigns current trays to match all preferred trays in the cluster.       |
| <i>n</i>       | Gives specified tray(s) current status in named cluster.                 |
| + <i>n</i>     | Adds specified tray(s) to cluster's current list.                        |
| - <i>n</i>     | Removes specified tray(s) from cluster's current list.                   |
| ALL            | Adds all trays to cluster's current status.                              |
| -ALL           | Deletes all current trays from the cluster.                              |
| <i>/NR</i>     | Prevents tray being removed from current status in any inactive cluster. |



**Note:** When a current tray is added or assigned to a cluster, that tray number is deleted from all other clusters, unless */NR* is entered with it.

## Ordered stock

Ordered stock consists of paper arranged in a specific order in a feeder tray so that it can be printed in a cycle. Prenumbered sheets and tabs are two examples of ordered stock.

The Ordered Stock task allows you to reset the ordered stock position in the feeder tray.



**Note:** Changes made in the Ordered Stock window are not reflected when the window is reopened. The defaults are displayed instead.

### Ordered Stock task through windows

Perform the following steps:

- Step 1.** Select the “Ordered Stock” option from the header auxiliary menu of the Printer Status window to open the Ordered Stock window (see figure 9-8).

Figure 9-8. **Ordered Stock window**

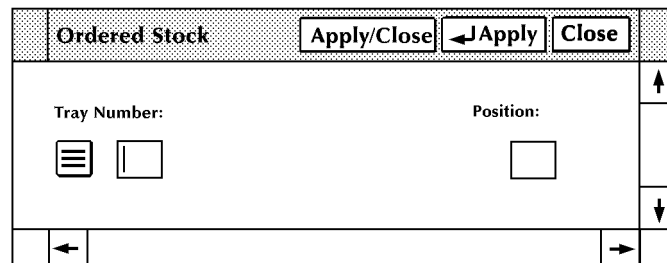

- Step 2.** Select the number of the tray containing the ordered stock from the auxiliary menu of the Tray Number field.
- Step 3.** Enter the ordered stock position in the Position field.  
For example, to tell the LPS that page number 6 is ready to be printed from ordered stock in tray 3, enter 3 in the Tray Number field and 6 in the Position field.
- Step 4.** Select the appropriate header button:
  - **Apply/Close.** Apply your selection and close the window.
  - **Apply.** Apply your selection.
  - **Close.** Close the window.



**Ordered Stock task through command line**

Enter the following command:

**OSTK *m,n***

Table 9-3 lists each parameter and its description.

Table 9-3. **OSTK command parameters and descriptions**

| Parameter | Description                                          |
|-----------|------------------------------------------------------|
| <i>m</i>  | The number of the tray containing the ordered stock. |
| <i>n</i>  | The new position of the ordered stock.               |

For example:

1. You are printing a job using prenumbered sheets of paper, numbered from 1-10, feeding from tray 3.
2. You remove some sheets from the top of the stack in tray 3.
3. The LPS expects the next sheet to be number 3, though it is, in fact, number 6.
4. Use the OSTK command in the following way:

**OSTK 3 6**

The above command tells the LPS that page 6 is ready to be printed from the ordered stock in tray 3



**Note:** Changes made through the command line are not reflected in the Ordered Stock window.

## Transparencies

---

Transparencies:

- Can feed only from the processor feeder trays (trays 1 and 2)
- Are printed only in simplex (one-sided) mode
- Must be delivered to the sample tray.

The Transparencies task allows you to override or request the use of transparencies for a particular print job. The Transparencies task:

- Can be entered only when the system is idle (that is, not printing and not engaged in any nonprinting tasks)
- Causes or cancels the use of transparencies in the next print job.

Once the job has printed, the transparency control returns to the coding in the job stream. (Refer to the *Xerox DocuPrint 180 LPS PDL/DJDE Reference* for additional information.)



**Note:** Changes made in the Transparencies window are not reflected when the window is reopened. The defaults are displayed instead.

**Transparencies task through windows** Perform the following steps:

- Step 1.** Select the “Transparencies” option from the header auxiliary menu of the Printer Status window to open the Transparencies window (see figure 9-9).

Figure 9-9. **Transparencies window**

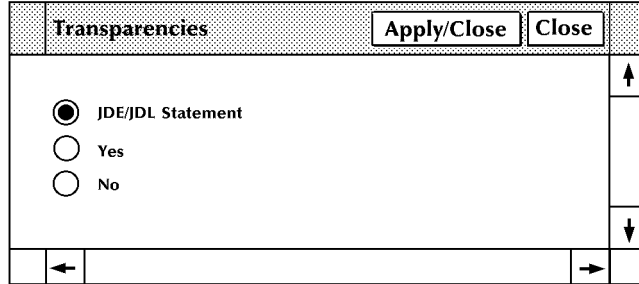

The default selection of the window is JDE/JDL. This means that transparency use is controlled by the coding in the job stream.

To override the coding and cause the job to print on transparencies, select the Yes button.

To override the coding and cancel printing on transparencies, select the No button.

- Step 2.** Select either:
- **Apply/Close.** Apply your selection and close the window.
  - **Close.** Close the window



**Note:** You must still ensure that either transparency or regular stock is loaded in the appropriate feeder trays.

**Transparencies task through command line**

To cause printing on transparencies, enter the following command:

**TRANS YES**

To cancel printing on transparencies, enter the following command:

**TRANS NO**



**Note:** You must still ensure that either transparency or regular stock is loaded in the appropriate feeder trays.



**Note:** Changes made through the command line are not reflected in the Transparencies window.

## Select units

Use this task to select the unit of measurement for the PC UI. This selection determines whether measurements are displayed and entered in the PC UI windows in inches or millimeters. The selection of the Units window affects the Printer Status window, the Tray Size window, and the Container Size window.

**Select Units task through windows** Perform the following steps:

- Step 1.** Select the “Units” option from the Printer Status window's header auxiliary menu to open the Units window (see figure 9-10).

Figure 9-10. **Units window**

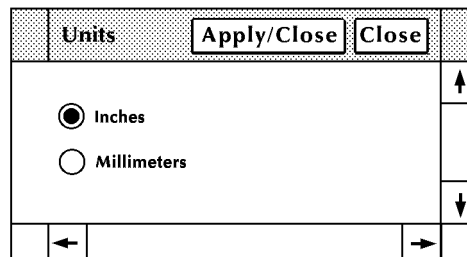

- Step 2.** Select the appropriate radio button:
- Inches. Display and enter sizes in inches.
  - Millimeters. Display and enter sizes in millimeters.
- Step 3.** Select the appropriate header button:
- **Apply/Close.** Apply your selection and close the window.
  - **Close.** Close the window.

## Purge feed

Use the Purge Feed task to specify which feeder trays you want to supply the LPS with purge sheets.



**Note:** In order to clean the photoreceptor properly following a fuser area jam, one of the feeder trays you specify must contain paper at least as long as the paper used in the current print job.



**Note:**  
Do not specify a tray containing ordered stock.

### Purge Feed task through windows

Through windows:

1. Select the “Purge Feed” option from the header auxiliary menu of the Printer Status window to open the Purge Feed window (see figure 9-11).

Figure 9-11. Purge Feed window

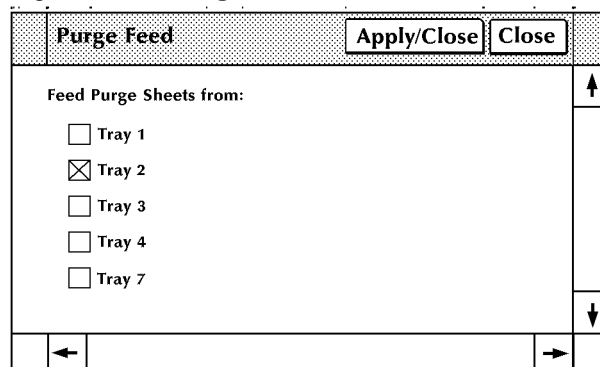

Select the checkbox of any tray you want the LPS to use for purge sheets. Tray 2 is the default selection of this window.

2. Select either:
  - **Apply/Close.** Apply you selection and close the window.
  - **Close.** Close the window.

### Purge Feed task through command line

To specify trays for purge feeding, enter the following command:

**PFEED [tray list]**

Table 9-4 lists the parameter and its description.

Table 9-4. PFEED command parameter and description

| Parameter        | Description                                                        |
|------------------|--------------------------------------------------------------------|
| <i>tray list</i> | The numbers of the trays you want the LPS to use for purge sheets. |

To display the currently assigned purge feed trays, enter the following command:

**PFEED**

## Lower trays and bins

Use this task to lower tray and bin elevators from the PC UI or system controller terminal.

### Lower Trays and Bins task through windows

In the printer mimic of the Printer Status window, select the down arrow on the tray or bin you want to lower.

If the tray or bin is currently in use and an alternative tray or bin is available, feeding or stacking switches to the other tray or bin.

If the tray or bin is currently in use and an alternative tray or bin is not available, printing stops.

### Lower Trays and Bins task through command line

Enter the following command:

**UNLOAD {*n* | *a*}**

Table 9-5 lists each parameter and its description.

Table 9-5. **UNLOAD command parameters and descriptions**

| Parameter | Description      |
|-----------|------------------|
| <i>n</i>  | The feeder tray. |
| <i>a</i>  | The stacker bin. |

## Set tray size

Use this task to tell the printer that custom size paper is loaded in a feeder tray.

You can also perform this task from the printer control console. To do so, follow this procedure:

- Step 1.** Touch the Guarded Tools icon.
- Step 2.** Select the Tray Size button.
- Step 3.** Follow the screen instructions to select feeder tray sizes.



**Caution:** If you use non-standard size paper for a print job without performing the Set Tray Size task, you may cause damage to the LPS photoreceptor belt. If you are using a custom transfer assist blade, follow the instructions for setting tray size in the “Using the custom transfer assist blade” section of the “Maintenance tasks” chapter.

**Set Tray Size task through windows** Perform the following steps:

- Step 1.** Select the “Tray Size” option from the header auxiliary menu of the Printer Status window to open the window (see figure 9-12).

Figure 9-12. Tray Size window

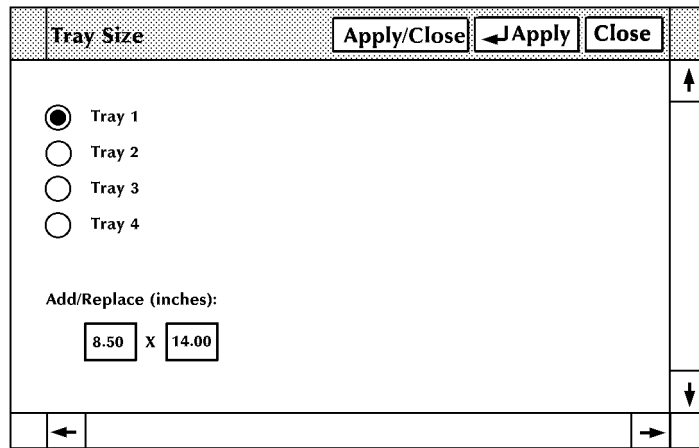

- Step 2.** Select the tray containing custom size paper.
- Step 3.** Enter the paper dimensions in the Add/Replace input fields.



**Note:** If the selection of the Units window is inches, enter the dimensions in inches; if it is millimeters, enter the dimensions in millimeters. (Refer to the “Select units” section of this chapter for additional information.)

**Step 4.** Select the appropriate header button:

- **Apply/Close.** Apply your selection and close the window.
- **Apply.** Apply your selection.
- **Close.** Close the window.

**Set Tray Size task through  
command line**

Enter the following command:

**SET TRAY *n,w,l***

Table 9-6 lists each parameter and its description.

Table 9-6. **SET TRAY command parameters and descriptions**

| Parameter | Description                    |
|-----------|--------------------------------|
| <i>n</i>  | The tray you want to modify.   |
| <i>w</i>  | The new width in millimeters.  |
| <i>l</i>  | The new length in millimeters. |



**Note:** You cannot enter inches in command line mode.

## Set container size

Use this task to change the maximum paper size allowed in a container for custom print jobs.

The allowable paper size range is 7 by 10 inches/178 by 254 mm to 11.69 by 17 inches/297 by 432 mm.

Any subsequent pages after the first sheet must be within 25 mm on each dimension of the first sheet.

You must not set the container size larger than the actual size of the container.



**Note:** Once you change a container size using this task, you must change it back again if you want to use a standard size container.

The following table shows the default size for each container.

Table 9-7. **Default container sizes**

| Container number | Default container size                                                    |
|------------------|---------------------------------------------------------------------------|
| 1                | 8 by 10.5 inches/203 by 267 mm                                            |
| 2                | A4 (210 by 297 mm/8.26 by 11.69 inches)                                   |
| 3                | 8.5 by 11 inches/216 by 279 mm                                            |
| 4                | 8.5 by 13 inches/216 by 330 mm                                            |
| 5                | 8.5 by 14 inches/216 by 356 mm                                            |
| 6                | 11 by 17 inches/279 by 432 mm or A3 (420 by 297 mm/16.53 by 11.69 inches) |
| 7                | 10.12 by 14.33 inches/257 by 364 mm                                       |



## Set Container Size task through windows

Perform the following steps:

- Step 1.** Select the “Container Size” option from the header auxiliary menu of the Printer Status window to open the Container Size window (see figure 9-13).

Figure 9-13. Container Size window

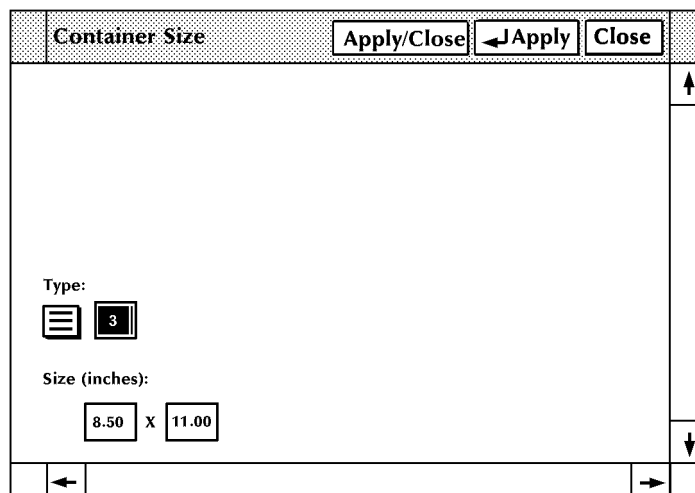

- Step 2.** Select the container you want to modify from the auxiliary menu next to the Type field. (Refer to table 9-1 for information on container numbers.)

- Step 3.** Enter the dimensions you want the container to have.



**Note:** If the selection of the Units window is inches, enter the dimensions in inches; if it is millimeters, enter the dimensions in millimeters.

- Step 4.** Select the appropriate header button:
- **Apply/Use.** Apply your selection and close the window.
  - **Apply.** Apply your selection.
  - **Close.** Close the window.

**Set Container Size task through command line**

Enter the following command:

**SET CONTAINER *container #,w,l***

Table 9-8 lists each parameter and its description.

Table 9-8. **SET CONTAINER command parameters and descriptions**

| Parameter          | Description                       |
|--------------------|-----------------------------------|
| <i>container #</i> | The container you want to modify. |
| <i>w</i>           | The new width in millimeters.     |
| <i>l</i>           | The new length in millimeters.    |



**Note:** You cannot enter inches in command line mode.

**Bin full criteria and setting bin limits**

You can request that bins continue to fill until:

- A specific number of reams or sheets has been stacked
- A specific report, report set, or print job is finished
- A specific report, report set, or print job is finished after a specific number of sheets has been stacked.

**Bin Full Criteria and Setting Bin Limits task through windows**

To set the maximum number of reams for a bin:

- Step 1.** Select the “Bin Full Criteria” option from the header auxiliary menu of the Printer Status window to open the Bin Full Criteria window (see figure 9-14).

Figure 9-14. **Bin Full Criteria window**

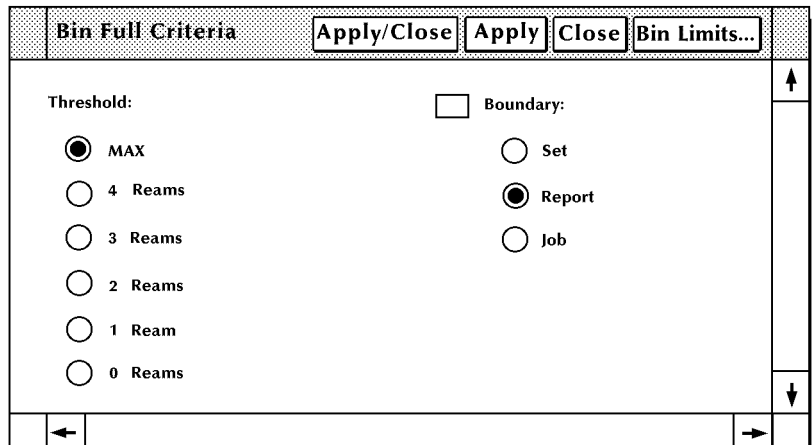

- Step 2.** Select the number of reams for the bins.



**Note:** If you select a button other than Max, the Boundary fields appear (see figure 9-15).

Figure 9-15. **Bin Full Criteria window, containing Boundary options**

The Boundary fields allow you to define the point at which stacking switches to the other bin.



**Note:** If the threshold you select is 0 reams, you must select a boundary. Otherwise, boundary selection is optional.

**Step 3.** To set a separation boundary, select the Boundary box and one of the following buttons:

- **Set.** The stacking switches after each printed set.
- **Report.** The stacking switches after each printed report.
- **Job.** The stacking switches after each printed job.

**Step 4.** Select the appropriate header button:

- **Apply/Close.** Apply your selection and close the window.
- **Apply.** Apply your selection.
- **Close.** Close the window.

To set the maximum number of sheets for a bin:

- Step 1.** Select the "Bin Limits" option from the header auxiliary menu of the Bin Full Criteria window to open the Bin Limits window (see figure 9-16).

Figure 9-16. **Bin Limits window**

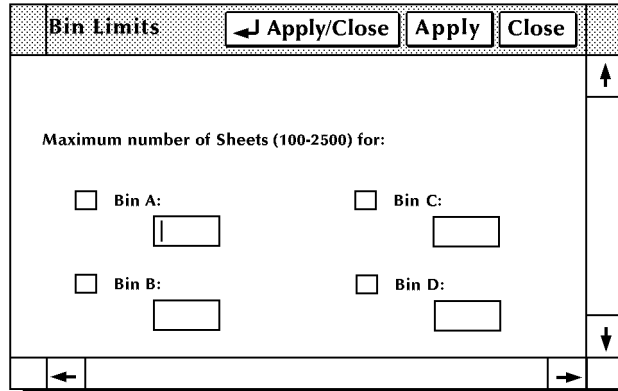

- Step 2.** Enter the maximum number of sheets for the stacker bin(s).

- Step 3.** Select the appropriate header button:

- **Apply/Close.** Apply your selection and close the window.
- **Apply.** Apply your selection.
- **Close.** Close the window.

**Bin Full Criteria and Setting Bin Limits task through command line**

To set the maximum number of reams for the bin, enter the following command:

**BINFULL [threshold, boundary]**

Table 9-9 lists each parameter and its description.

Table 9-9. **BINFULL command parameters and descriptions**

| Parameter        | Description                                                                                                                                                                                                                                                                                                                                                                  |
|------------------|------------------------------------------------------------------------------------------------------------------------------------------------------------------------------------------------------------------------------------------------------------------------------------------------------------------------------------------------------------------------------|
| <i>threshold</i> | The maximum number of reams for the bin. This number must be between 0 and 5.<br><br><b>Note:</b> If the threshold is 0, the boundary must be specified.                                                                                                                                                                                                                     |
| <i>boundary</i>  | The separation boundary for the bin. The options are: <ul style="list-style-type: none"> <li>• <b>NONE.</b> There is no separation boundary.</li> <li>• <b>SET.</b> The stacking switches after each printed set.</li> <li>• <b>REPORT.</b> The stacking switches after each printed report.</li> <li>• <b>JOB.</b> The stacking switches after each printed job.</li> </ul> |

To specify the maximum number of sheets for the bin, enter the following command:

**BLIMIT *bin letter, sheet count***

Table 9-10 lists each parameter and its description.

Table 9-10. **BLIMITL command parameters and descriptions**

| Parameter         | Description                                                                                   |
|-------------------|-----------------------------------------------------------------------------------------------|
| <i>bin letter</i> | The bin whose limit you are setting. For example, enter A to set the limit for stacker bin A. |
| sheet count       | The number of sheets that can be sent to the bin. The number must be between 100 and 2500.    |

## Separate

---

Use this task to cause a one-time switch to the other stacker bin when you are in auto switching mode.

You can cancel the Separate task by either:

- Selecting the “Separate off” option from the Printer Status window’s header auxiliary menu
- Entering the following command:

**SEPARATE OFF**

### Separate task through windows

Select the “Separate On” option from the header auxiliary menu of the Printer Status window.

### Separate task through command line

Enter the following command:

**SEPARATE**

## Job status

Use this task to display information about jobs in the print queue. The following information appears:

- The print job queued for input (that is, processing).
- Print job information for each job in the queue:
  - **Job number**
  - **Customer job number**
  - **Report number**
  - **Report name**
  - **Number of copies requested**
  - **Total pages in the job**
  - **Number of pages printed**
  - **Number of pages printed**
  - **Status of the job**
  - **Status message number** (either a blank if the print job completed normally, an error message number, or “CS” if the report is copy sensitive, that is, different copies of the report contain different information).

When the system is printing, the status and source information shown in figure 9-17 is displayed at the bottom of the PC UI monitor.

Figure 9-17. **Status and source information**

|                                |                     |                                 |
|--------------------------------|---------------------|---------------------------------|
| Input:<br>(Status)<br>(Source) | Output:<br>(Status) | Remote:<br>(Status)<br>(Source) |
|--------------------------------|---------------------|---------------------------------|

- **Input Status.** The processing stage of the job (for example, “Idle”).
- **Input source.** The origin of the print job (for example, “Tape”).
- **Output Status.** The printing stage of the job (for example, “Printing”).
- **Remote Status.** The status of the remote communication (for example, “Suspended”).
- **Remote Source.** The remote source of a job, if applicable (for example, “Site PC”).



**Note:** When the system is idle, only the status information is displayed: Input Status, Output Status, and Remote Status.

You may also use this task to display the status of less than 100 print jobs or up to 100 jobs with any of the following statuses:

- Done. The job was completely printed.
- Aborted. The job was aborted during processing or printing.
- Reset. The job was aborted by the Reset task.
- RCVY/NS. The job was aborted due to a system rollover, and you did not ask to recover and print the job.



**Note:** You can also access the Jobs Status window (PC UI) or display (system controller terminal) by pressing the <JOBS STATUS> key.

**Jobs Status task through windows** Perform the following steps:

- Step 1.** Select "Jobs Status" from the Print Tasks menu to open the Jobs Status window (see figure 9-18).

Figure 9-18. **Jobs Status window**

| Job Status                                                |            |           |             |         |         |             |               |            |       |       |  |          |  |
|-----------------------------------------------------------|------------|-----------|-------------|---------|---------|-------------|---------------|------------|-------|-------|--|----------|--|
| Close                                                     |            | ✓ Current |             | All...  |         | Done        |               | Aborted    |       | Reset |  | RCVY N/S |  |
| Approximately XXXXX unused entries in the accounting file |            |           |             |         |         |             |               |            |       |       |  |          |  |
| Job NO.                                                   | Cust JOB # | Rpt NO.   | Report Name | JDE/JDL | Cpy Cnt | Total Pages | Pages Printed | Status Msg | Msg # |       |  |          |  |
|                                                           |            |           |             |         |         |             |               |            |       | ↑     |  |          |  |
|                                                           |            |           |             |         |         |             |               |            |       | ↓     |  |          |  |
|                                                           |            |           |             |         |         |             |               |            |       | ← →   |  |          |  |

- Step 2.** To display the status of current jobs, select the Current header button. (This is the default display.)
- Step 3.** To display completed jobs, select either:
- The All header button to display all jobs awaiting processing and the status of up to 100 completed jobs. The Jobs All window opens, allowing you to select the number of completed jobs you want to display.
  - One of the other buttons to display only completed jobs with the selection status. For example, to display up to 100 completed jobs with the status Done, select the Done button.
- Step 4.** The Jobs Status window now displays completed jobs that fit your selection.



**Note:** To update the jobs status display for your selection, click on the appropriate header button. The current display is designated by a check mark.

**Jobs Status task through command line**

To display jobs status, enter the following command:

**JOBS**

To display only reports in the print queue (that is, waiting to be printed), enter the following command:

**JOBS Q**

To display up to 100 jobs with specific statuses, enter the following command:

**JOBS ALL {DONE | RESET | ABORT | RCVY | *n*}****DONE**

Display jobs with the status "Done."

**RESET**

Display jobs with the status "Reset."

**ABORT**

Display jobs with the status "Aborted."

**RCVY**

Display jobs with the status "RCVY/NS."

***n***

The number of jobs for which you want status information displayed.

---

**Configure feeding or finishing device**

---

Use this task to:

- Send the configuration values for a feeding or finishing device to the printer
- Display the current device configuration values.

---

**Configure task through windows**

---

Perform the following steps:

**Step 1.** Select one of the following options from the Printer Status window's header auxiliary menu:

- "Feeding Configuration"
- "Finishing Configuration"
- "Feed/Finish Configuration"



**Note:** The option you see depends on the devices set up for your LPS.

Depending on the option selected, one of the windows shown in figures 9-19 through 9-21 appears on the PC UI desktop.



Figure 9-19. Feeding Configuration window

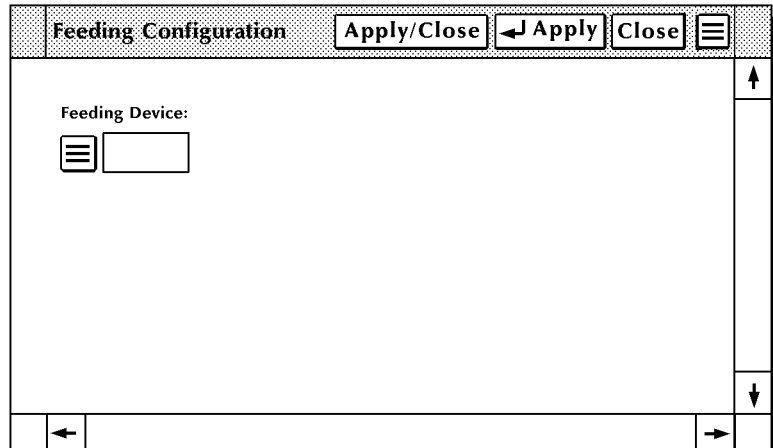

Figure 9-20. Finishing Configuration window

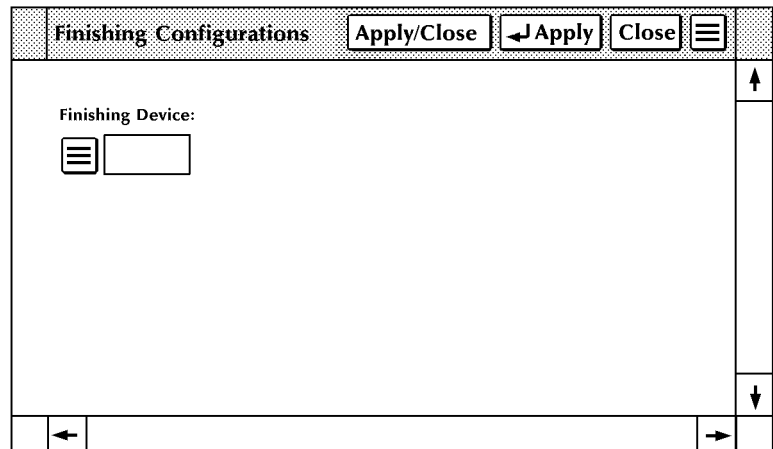
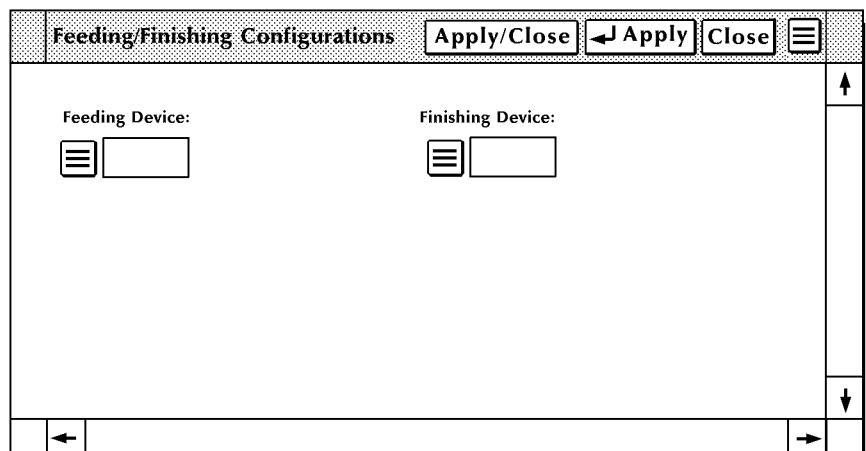

Figure 9-21. Feeding/Finishing Configurations window



**Step 2.** Select either of the following options:

- To select a configuration for the feeding or finishing device, select the profile label from the Feeding Device or Finishing Device field's auxiliary menu. You can also enter the profile label directly into the Feeding Device or Finishing Device field.
- To display the current device configuration values, select the "Show NVM Values" option from the window's header auxiliary menu. The current device values appear in the window, along with a description of each value.

**Step 3.** Select the appropriate header button:

- **Apply/Close.** Send the selected configuration values to the printer and close the window.
- **Apply.** Send the selected configuration values to the printer.
- **Close.** Close the window.

**Configuring task through command line**

---

**FCG (display the profile labels)** Use this command to display the profile labels in the FCG.LIB file.

Logon Level Levels 2 through 5.

Syntax FCG

**FCG (configure a finishing or feeding device)** Use this command to load into printer memory the personality profile the LPS must use to communicate with the finishing device or bulk feeder. The personality profile is an entry in a text file called "FCG.LIB." Once this file is created, it is preserved across sysgens.

Logon Level Levels 2 through 5.

Syntax FCG {*profile-label*}

Parameters Table 9-11 shows the parameters used in FCG to configure a finishing or feeding device.

Table 9-11. **Parameters of the FCG (configure a finishing or feeding device) command**

| Parameter            | Description                                                        |
|----------------------|--------------------------------------------------------------------|
| <i>profile-label</i> | Specifies the entry in the FCG.LIB file to be sent to the printer. |

**FCG SHOW (check finishing or feeding device settings)**

Use this command to check the settings for the finishing or feeding devices configured for the LPS.

Logon level      Levels 2 through 5.

Syntax            FCG SHOW

Restrictions      SHOW cannot be abbreviated to SHO.

**FCG procedures**

Use this task to:

- Send the configuration values for a feeding or finishing device to the printer
- Display the current device configuration values.

## Configure task

Table 9-12 shows the command to send feeding or finishing device configurations to the printer.

Table 9-12. **Parameters of the FCG SHOW (check finishing or feeding device settings) command**

| Parameter                | Description                                                         |
|--------------------------|---------------------------------------------------------------------|
| <b>FCG profile-label</b> |                                                                     |
| <i>profile-label</i>     | The name assigned to the feeding or finishing device configuration. |

To display all profile labels for the feeding or finishing device, enter the following command:

**FCG**

To display the current device configuration values, enter the following command:

**FCG SHOW**

**Note:** **SHOW** cannot be abbreviated to **SHO**.

## Notepad

The Notepad task allows you to create notes as reminders to yourself or to post notes to another person using the PC UI.

Using the Notepad task, you can:

- Create a note
- Display a note
- Edit a note
- Delete a note.

**Notepad task through windows** Perform the following steps:

- Step 1.** Select the Notepad icon from the desktop to open the Notepad window (see figure 9-22).

Figure 9-22. Notepad window

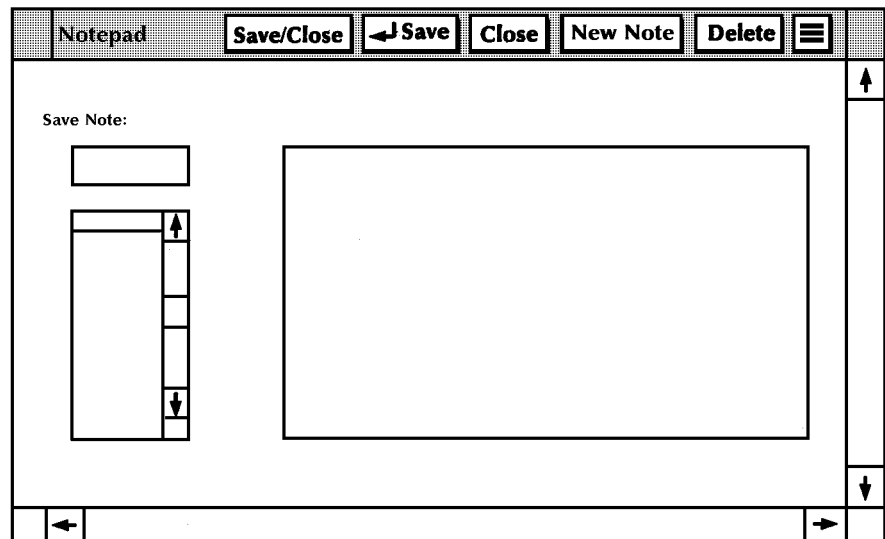

- Step 2.** Perform the steps for one of the following functions:

- Create a note
- Display a note
- Edit a note
- Delete a note

The steps for each of these functions are listed next.

**Create a note** Perform the following steps:

**Step 1.** Select the New Note header button.

**Step 2.** Enter the note text in the Note field (the large rectangular box). The note can be up to 256 characters in length.



**Note:** You cannot use the <ENTER> key to advance to the next line in the Note field. Use the <SPACEBAR> to advance to the next line if necessary, for instance, if you want to enter a short line or a blank line.



**Note:** If the Note field is not empty, select the New Note header button to clear the field.

**Step 3.** Press the <TAB> key to advance to the Saved Note field.

**Step 4.** Enter a name for the note in the Saved Note field. The name can be up to eight characters in length.

**Step 5.** Save the note, using either the Save or Save/Close header button.

**Step 6.** Select the Close header button to close the Notepad window.

**Display a note** Perform the following steps:

**Step 1.** Select the note you want to display from the list of notes. The name now appears in the Saved Note field and the text appears in the Note field.



**Note:** You can also enter the name of the note directly into the Saved Note field and select the "Display" option from the header auxiliary menu to display a saved note.

**Step 2.** Select the Close header button to close the Notepad window.

**Edit a note** Perform the following steps:

**Step 1.** Follow the procedure to display a note.

**Step 2.** Change the text and/or title of the note.



**Note:** If you change the title of a note, a new note is created and the old note is saved. Save the note using either the Save or Save/Close header button.

**Step 3.** Select the Close header button to close the Notepad window.

**Delete a note** Perform the following steps:

- Step 1.** Select the note from the list of saved notes, or enter the name of the note in the Saved Note field.
- Step 2.** Select the Delete header button. A confirmation window appears (see figure 9-23).

Figure 9-23. **Confirmation window (delete option)**

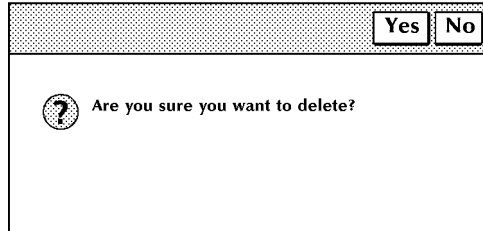

- Step 3.** Select Yes to delete the note, or select N to cancel the delete request.
- Step 4.** Select the Close header button to close the Notepad window.

---

# 10.

# File control tasks

This chapter contains instructions for copying files between the system disk and labeled and unlabeled tapes and cartridges.

Instructions are given for performing the tasks using either the windows of the PC UI or keyed-in commands. Refer to the list below for the tasks described in this chapter:

- File control tasks through windows of PC UI
- File control tasks through command line
- Copy labeled tapes
- Copy unlabeled tapes
- Copy floppy disks

## File control tasks through windows of PC UI

---

To select file control tasks using the windows of the PC UI:

**Step 1.** Open the Files menu icon.

The Files menu window appears, listing the available options (see figure 10-1).

Figure 10-1. Files menu window

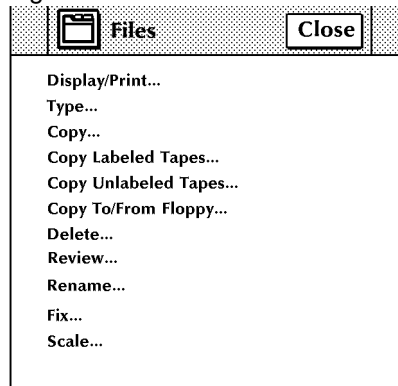

**Step 2.** Turn to the section of this chapter which explains the task in which you are interested.

---

## File control tasks through command line

---

You can perform file control tasks by entering commands either:

- Through the Messages window of the PC UI
- Through the system controller terminal (non-U.S. markets).

To enter commands through the Messages window of the PC UI:

**Step 1.** Place the cursor in the window.

**Step 2.** Click once with the left mouse button.

**Step 3.** Enter the command.

If you are using the system controller terminal, just use the keyboard to enter the command.



## File control tasks

The following sections contain instructions for performing specific file control tasks. For additional information about each task, refer to the *Xerox DocuPrint 180 Laser Printing System PC User Interface Reference*.

### Display/Print

Use this task to display and print information on files residing on the system disk and on tape. The abbreviated display/printout for files on disk contains the File ID (File Name and File Type).

Figure 10-2 shows the Display/Print window.

Figure 10-2. **Display/Print window**

The screenshot shows the 'Display / Print' window with the following elements:

- Title Bar:** 'Display / Print', 'Close', '←JDisplay...', 'Paged Display...', 'Print', 'Rewind', and a menu icon.
- Device:** A dropdown menu showing 'All Disks'.
- Disk File ID:** A text input field containing '\*.\*'.
- Floppy File ID:** A text input field containing '\*.\*'.
- Options:**
  - Options
  - Extended Display/Print
  - Sort File ID: [text input field]
  - String File ID: [text input field]
- String Comments:** A large text input area.
- Navigation:** A vertical scrollbar on the right and horizontal arrows at the bottom.

## Type

Use this task to display the contents of text files (such as .FSL, .JSL, or .TMP files) residing on the system disk. To be displayed, the selected file ID must be a non-compiled source file.

Figure 10-3 shows the Type window.

Figure 10-3. **Type window**

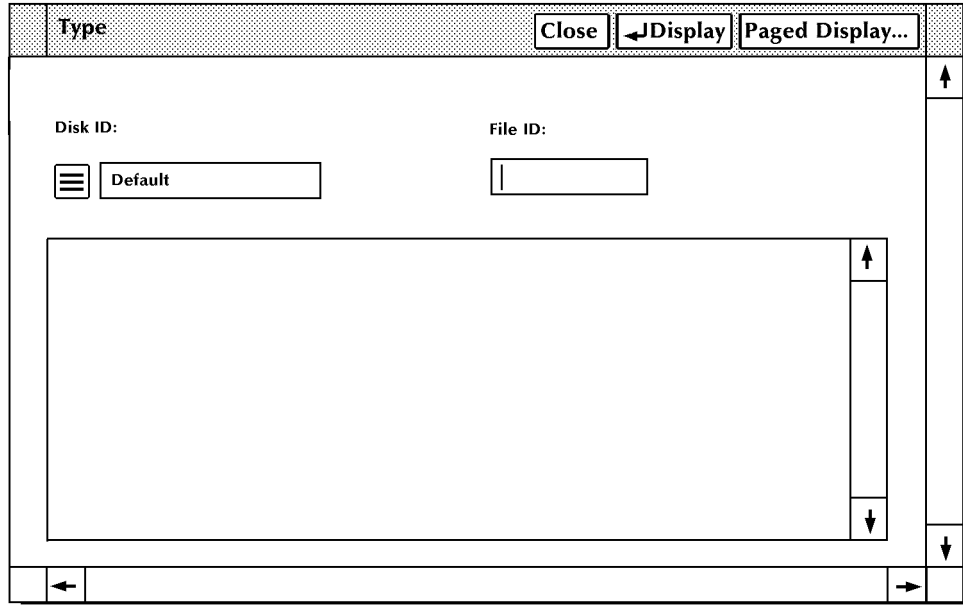

## Copy

Use this task to copy files residing on the system disk (disk to disk).

Figure 10-4 shows the Copy window.

Figure 10-4. **Copy window**

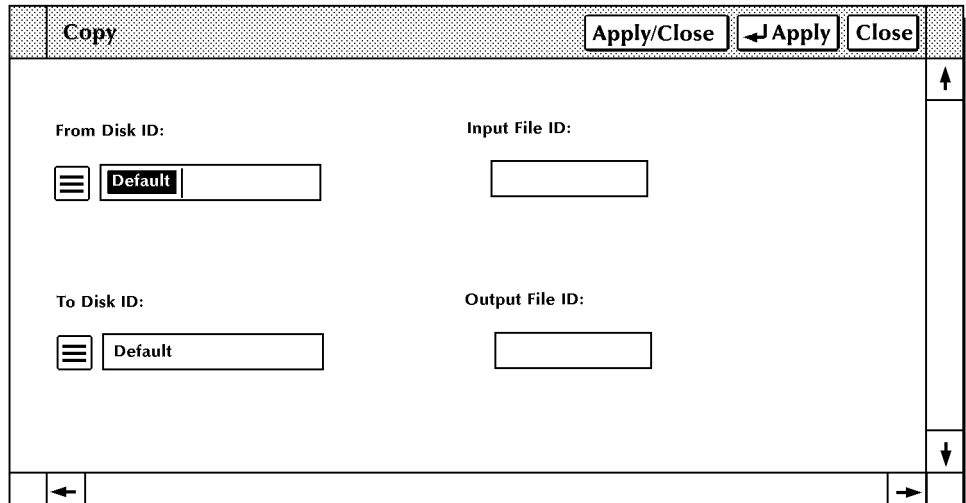

## Copy labeled tapes

Use this task to copy files residing on the system disk to tape and files on tape to disk.

### Copy Labeled Tapes task through windows

Select "Copy Labeled Tapes" from the Files menu to open the Copy Labeled Tapes window (see figure 10-5).

Figure 10-5. Copy Labeled Tapes window

To initialize a tape, select the Initialize header button (for 1600 bpi) or the appropriate Initialize option from the window's header auxiliary menu.



**Note:** You can initialize at either 1600 or 6250 bpi.

To copy files:

- Step 1.** Select the Copy option you want.  
The default is Disk to Tape.
- Step 2.** Select the tape device from the Tape Device auxiliary menu.
- Step 3.** If you are copying from labeled tape to disk, select the disk unit you want the file copied to from the Disk ID auxiliary menu.  
You may use the default disk unit if you prefer.
- Step 4.** Enter the file name to be copied in the Input Field ID field.
  - The format is ***file-name.file-type***.
  - The default is \*.\* (that is, all files).

**Step 5.** Enter the blocking factor.



**Note:** This option appears only when you are copying from system disk to tape. It is the number of disk blocks packed into one tape block.

**Step 6.** Enter the name to be given to the new file in the Output File ID field.

- The format is ***file-name.file-type***.

The file name can be up to six characters in length and can consist of letters or numbers. Punctuation characters (such as a comma) or spaces cannot be used in the name.

- If you do not enter a name in this field, the new file name is the same as the input file name.

**Step 7.** If you are copying files from tape to disk, select the Review check box to display a confirmation window when a file of the same name already exists on the system disk (see figure 10-6).

Figure 10-6. **Confirmation window (Review option)**

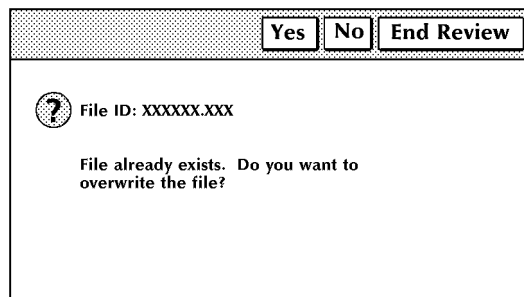

From the window, you can select one of the following options:

- Yes to write over the file on the system disk
- No to skip to the next file in the Copy task
- End Review to end the copy review request.

A confirmation window no longer appears if a file of the same name already exists on the system disk.

**Step 8.** Select the Next header button if you want the next file on the tape or disk to be displayed in the Input File ID field.

- Step 9.** Select the Find header button to search for a specific file. Then the Find window opens (see figure 10-7).

Figure 10-7. Find window

1. Enter the name of the file you want to locate.
2. Select the Apply or Apply/Close header button to position the tape or disk at the file.
3. Select the Skip header button to position the tape or disk over a specific number of files. Then the Skip window opens (see figure 10-8).

Figure 10-8. Skip window

4. Enter the number of files you want to skip over.
5. Select the Apply or Apply/Close header button to reposition the tape or disk.

- Step 10.** Select the Apply or Apply/Close header button to begin the Copy task.



**Note:** You may also rewind or unload a tape by selecting the appropriate option from the header auxiliary menu

**Copy Labeled Tapes task through command line**

To copy files from labeled tape to system disk, enter the following command:

**COPY {TAPE | CART | TD*n*}[READ] LABEL [REVIEW] [*disk-id*] {*input-file-id* [*output-file-id* | NEXT | ALL | *file-type*]}**

Table 10-1 lists each parameter and its description.

Table 10-1. **COPY command parameters and descriptions**

| Parameter                | Description                                                                                                                                                                                                                                                                                                 |
|--------------------------|-------------------------------------------------------------------------------------------------------------------------------------------------------------------------------------------------------------------------------------------------------------------------------------------------------------|
| TAPE [READ] LABEL        | The file(s) to be copied are on an LPS-labeled tape.                                                                                                                                                                                                                                                        |
| CART [READ] LABEL        | The file(s) to be copied are on an 1/2 inch LPS-labeled cartridge tape device.                                                                                                                                                                                                                              |
| TD <i>n</i> [READ] LABEL | The file(s) to be copied are on the specified tape device.                                                                                                                                                                                                                                                  |
| REVIEW                   | Displays a message when the file on the tape will replace an existing file of the same name on the disk and requests whether to replace the file. If you enter 'Y', the file on tape replaces the disk file. If you enter 'N', the tape skips to the next file. Enter 'X' to abort the entire copy process. |
| <i>disk-id</i>           | Tells which disk (DP0:, DP1:, DP2:, or DP3:) to which the file is to be written. Keying in this parameter is not necessary unless you want the file to reside on a specific system disk.                                                                                                                    |
| <i>input file-id</i>     | Gives the name of the input tape file to be copied to the system disk(s). Use the following form: file-name.file-type.                                                                                                                                                                                      |
| <i>output file-id</i>    | Provides the name to be given to the output disk file, using the following form: file-name.file-type. If no output file id is specified, the file written to the system disk has the same name as the file tape.                                                                                            |
| NEXT                     | The next file on the tape is to be copied to the system disk.                                                                                                                                                                                                                                               |
| ALL                      | Indicates that all the files on the tape are to be copied to the system disk.                                                                                                                                                                                                                               |
| <i>file-type</i>         | Specifies the name of a directory, such as FRM, FNT, IMG, to be written to the system disk.                                                                                                                                                                                                                 |

Use the following command to copy new files from system disk to tape. The new files follow existing files on the tape. If there are no existing files, the new files are written starting at the beginning of the tape.

**Note:** If you are using either a new tape or writing over existing files on a tape, you must use the VOLINIT command before the COPY command. The VOLINIT command format is as follows:

**TAPE[TD*n* | CARTRIDGE]VOLINIT [,1600 | 6250]**

Table 10-2 lists each parameter and its description.

Table 10-2. **VOLINIT command parameters and descriptions**

| Parameter  | Description                                                 |
|------------|-------------------------------------------------------------|
| <i>TDn</i> | The tape device containing the tape you want to initialize. |
| CARTRIDGE  | The 1/2 inch cartridge tape drive.                          |

You may set the tape density to either 1600 (default setting) or 6250 bpi.

To write files to a labeled tape, enter the following command:

**COPY {TAPE | CARTRIDGE | *TDn*}WRITE[/BF:n]LABEL [*disk-id*] {*input-file-id* [*output-file-id*] ALL | *file-type*}**

Table 10-3 lists each parameter and its description.

Table 10-3. **COPY command parameters and descriptions**

| Parameter              | Description                                                                                                                                                                                                                                                      |
|------------------------|------------------------------------------------------------------------------------------------------------------------------------------------------------------------------------------------------------------------------------------------------------------|
| TAPE WRITE LABEL       | Indicates the files are to be written to an LPS-labeled tape.                                                                                                                                                                                                    |
| CARTRIDGE WRITE LABEL  | Indicates the files are to be written to a labeled cartridge tape.                                                                                                                                                                                               |
| <i>TDn</i> WRITE LABEL | Indicates the files are to be written to the specified tape device.                                                                                                                                                                                              |
| /BF:n                  | The capability to pack n disk blocks into one tape block. n can have a value of 1 to 16. The size of the tape block, in bytes, resides in the tape label. The default blocking factor is 1. The label indicates the blocking factor. This parameter is optional. |
| <i>disk-id</i>         | Tells which disk (DP0:, DP1:, DP2:, or DP3:) from which the file is to be written. Keying in this parameter is not necessary unless you want the file to be written from a specific system disk.                                                                 |
| <i>input file-id</i>   | Gives the name of the system disk file to be copied to tape.                                                                                                                                                                                                     |
| <i>output file-id</i>  | Provides the name to be given to the output tape file, using the following form: file-name.file-type. If no output file id is specified, the system disk file name is used for the tape file.                                                                    |
| ALL                    | Indicates that all user files are to be copied to tape.                                                                                                                                                                                                          |
| <i>file-type</i>       | Specifies the name of a directory, such as FRM, FNT, IMG. All the files in that directory are written to tape.                                                                                                                                                   |

## Copy unlabeled tapes

Use this task to copy files from:

- System disk to unlabeled tape
- Unlabeled tape to system disk.

### Copy Unlabeled Tapes task through windows

Select "Copy Unlabeled Tapes" from the Files menu to open the Copy Unlabeled Tapes window (see figure 10-9).

Figure 10-9. Copy Unlabeled Tapes window

To initialize a tape, select the Initialize header button, the Initialize 1600 bpi header button, or the "Initialize 6250 bpi" option from the header auxiliary menu. (The Initialize and Initialize 1600 bpi buttons perform the same function.)

To copy files:

**Step 1.** Select the Copy option you want.



**Note:** The default is Disk to Tape.

**Step 2.** Select the tape device from the Tape Device auxiliary menu.

**Step 3.** If you are copying from tape to disk, select the disk unit you want the file copied to, from the Disk ID auxiliary menu.



**Note:** You may use the default disk unit if you prefer.

**Step 4.** Select the recording format of the tape being input. The default is EBCDIC. You can select ASCII from the Format auxiliary menu.

**Step 5.** Enter the file name to be copied to or from the system disk in the File ID field. The format is **file-name.file-type**.



- Step 6.** Select the Apply or Apply/Close header button to begin the Copy task.



**Note:** You may also rewind or unload a tape by selecting the appropriate option from the header auxiliary menu.

**Copy Unlabeled Tapes task through command line**

To copy files from unlabeled tape to system disk, enter the following command:

**COPY {TAPE | CARTRIDGE | TD*n*}[EBCDIC | ASCII] [*disk-id*] *file-id***

Table 10-4 lists each parameter and its description.

Table 10-4. **COPY command parameters and descriptions**

| Parameter      | Description                                                                                                                                                                              |
|----------------|------------------------------------------------------------------------------------------------------------------------------------------------------------------------------------------|
| TAPE           | The file being input is from a open-reel tape.                                                                                                                                           |
| CARTRIDGE      | The file is being input from an 1/2 inch cartridge tape.                                                                                                                                 |
| TD <i>n</i>    | The file is being input from the specified tape device.                                                                                                                                  |
| EBCDIC ASCII   | The recording format of the tape being input. If you do not specify either EBCDIC or ASCII, EBCDIC is assumed.                                                                           |
| <i>disk-id</i> | Tells which disk (DP0:, DP1:, DP2:, or DP3:) to which the file is to be written. Keying in this parameter is not necessary unless you want the file to reside on a specific system disk. |
| <i>file-id</i> | Gives the name of the file to be written to a system disk, using the following form: <b><i>file-name.file-type</i></b> .                                                                 |

To copy files from system disk to unlabeled tape, enter the following command:

**COPY TAPE | CARTRIDGE | TD $n$  WRITE [EBCDIC | ASCII] [*disk-id*] *file-id***

Table 10-5 lists each parameter and its description.

Table 10-5. **COPY command parameters and descriptions**

| Parameter       | Description                                                                                                                                                                                      |
|-----------------|--------------------------------------------------------------------------------------------------------------------------------------------------------------------------------------------------|
| TAPE WRITE      | Indicates the file is to be written to a open-reel tape.                                                                                                                                         |
| CARTRIDGE WRITE | Indicates the file is to be written to an 1/2 inch cartridge tape.                                                                                                                               |
| TD $n$ WRITE    | Indicates the file is to be written to the specified tape device.                                                                                                                                |
| EBCDIC ASCII    | The recording format of the tape being input. If you do not specify either EBCDIC or ASCII, EBCDIC is assumed.                                                                                   |
| <i>disk-id</i>  | Tells which disk (DP0:, DP1:, DP2:, or DP3:) from which the file is to be written. Keying in this parameter is not necessary unless you want the file to be written from a specific system disk. |
| <i>file-id</i>  | Gives the name of the file to be written from a system disk, using the following form: <b><i>file-name.file-type</i></b> .                                                                       |

For example, if you key in COPY TAPE UNSYS.JSL, the file name is UNSYS and the file type is “.JSL.”

## Copy to/from floppy

Use this task to copy files from:

- System disk to floppy disk
- Floppy disk to system disk.



**Note:** This task is used for the optional floppy disk drive on the system controller, not the PC UI floppy disk drive.

## Copy Floppy Disks task through windows

Through windows:

- Step 1.** Select "Copy To/From Floppy" from the Files menu to open the Copy To/From Floppy window (see figure 10-10).

Figure 10-10. Copy To/From Floppy window

- Step 2.** Select one of the following options:
- To initialize the floppy disk, select the Initialize header button.
  - To format the floppy disk, select the Format header button.
  - To copy files:
    1. Select the Copy option you want.
    2. Select from the Disk ID field's auxiliary menu the disk unit to which or from which you want to copy.  
You may use the default disk unit if you prefer.
    3. Enter the input and output file names in the Input File ID and the Output File ID fields.
    4. If you want to be warned when a file of the same name already exists on the destination disk, select the Review check box. Refer to the "Copy Labeled Tapes" section earlier in this chapter for additional information.

- Step 3.** Select the appropriate header button:
- **Apply/Close.** Apply your selection and close the window.
  - **Apply.** Apply your selection.
  - **Close.** Close the window.

**Copy Floppy Disks task through command line**

To format and initialize a floppy disk, enter the following command:

**FLOPPY FORMAT**

To copy files from the system disk to a floppy disk, enter the following command:

**FLOPPY SAVE [REVIEW] [*disk-id*] {*input-file-id* | *output-file-id* | *file-id* | *file-type* | ALL}**

Table 10-6 lists each parameter and its description.

Table 10-6. **FLOPPY SAVE command parameters and descriptions**

| Parameter                                                                        | Description                                                                                                                                                                                       |
|----------------------------------------------------------------------------------|---------------------------------------------------------------------------------------------------------------------------------------------------------------------------------------------------|
| REVIEW                                                                           | Prompts you to confirm or stop overwriting a floppy file by a system file. If you enter N, the file is not copied to floppy disk, and the save process skips to the next file on the system disk. |
| <i>disk-id</i>                                                                   | The system disk unit containing the files to be saved. If you do not specify a disk id, all disks are searched.                                                                                   |
| <i>input-file-id</i>   <i>output-file-id</i>   <i>file-id</i>   <i>file-type</i> | The identity of the input and output files.                                                                                                                                                       |
| ALL                                                                              | Saves all user files on the floppy disk.                                                                                                                                                          |

To copy files from a floppy disk to the system disk, enter the following command:

**FLOPPY RESTORE [REVIEW] [*disk-id*] {*input-file-id* | *output-file-id* | *file-id* | *file-type* | ALL}**

Table 10-7 lists each parameter and its description.

Table 10-7. **FLOPPY RESTORE command parameters and descriptions**

| Parameter                                                                        | Description                                                                                                                                                                                          |
|----------------------------------------------------------------------------------|------------------------------------------------------------------------------------------------------------------------------------------------------------------------------------------------------|
| REVIEW                                                                           | Prompts you to confirm or stop overwriting a system file by a floppy file. If you enter N, the file is not copied to system disk, and the restore process skips to the next file on the floppy disk. |
| <i>disk-id</i>                                                                   | The system disk unit to which the file is copied.                                                                                                                                                    |
| <i>input-file-id</i>   <i>output-file-id</i>   <i>file-id</i>   <i>file-type</i> | The identity of the input and output files.                                                                                                                                                          |
| ALL                                                                              | Saves all user files on the floppy disk to the system disk.                                                                                                                                          |

## Delete

Use this task to delete files on the ESS system disk or ESS floppy diskette.

Figure 10-11 shows the Delete window.

Figure 10-11. Delete window

The screenshot shows a window titled "Delete". At the top right, there are three buttons: "Apply/Close", "Apply" (with a left arrow), and "Close". The main area contains three input fields: "Device:" with a dropdown menu showing "Default", "Floppy File ID:" with a text box containing "\*", and "Disk File ID:" with a larger empty text box. The window has a standard border with arrow keys on the right and bottom sides.

## Review

Use this task to review files residing on the system disk. Specified files are displayed one at a time, with the options to delete the file, skip the file, or end the review process.

Figure 10-12 shows the Review window.

Figure 10-12. Review window

The screenshot shows a window titled "Review". At the top right, there are five buttons: "Close", "Display" (with a left arrow), "Delete", "Skip", and "End Review". The main area contains three input fields: "Disk ID:" with a dropdown menu showing "All", "File ID:" with a large empty text box, and another "File ID:" label below it. The window has a standard border with arrow keys on the right and bottom sides.

## Rename

Use this task to change the name and/or type of a file residing on the system disk. After a file is renamed, the old file name is deleted from the file directory.

Figure 10-13 shows the Rename window.

Figure 10-13. **Rename window**

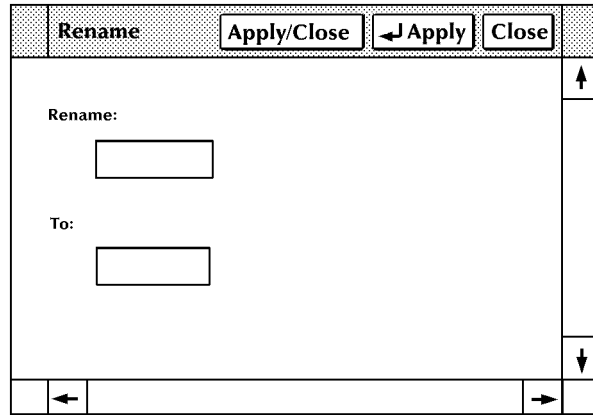

## Fix

Use this task to modify licensed and standard fonts, logos, and the font/logo matrix for the correct image generator (IG) version.

Figure 10-14 shows the Fix window.

Figure 10-14. **Fix window**

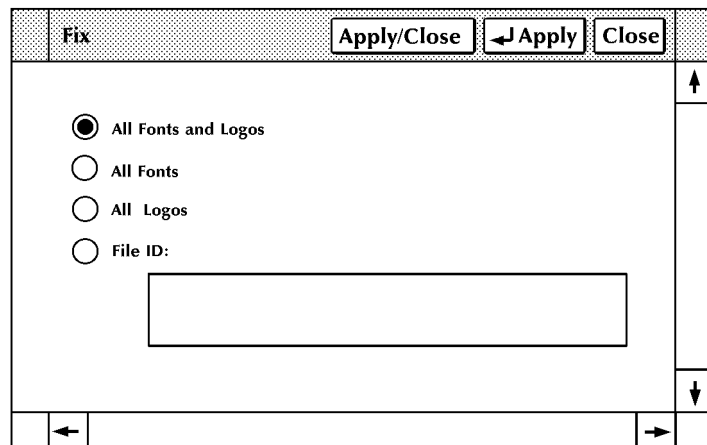

## Scale

Use this task to scale 300 spi fonts, forms, and logos to their 600 spi equivalents. You must provide an input (300 spi) file specification and an output (600 spi) file specification.

Figure 10-15 shows the Scale window.

Figure 10-15. **Scale window**

The image shows a graphical user interface window titled "Scale". The window has a title bar with the text "Scale" on the left and three buttons on the right: "Apply/Close", "← J Apply", and "Close". The main area of the window contains two input fields: "Input File ID:" on the left and "Output File ID:" on the right, each with a corresponding empty text box. Below these fields are three checkboxes, each followed by a label: " Overwrite Output Filename", " Bit-Double Font/Logo Bitmaps", and " Override Escapement Error Message". The window also features a vertical scrollbar on the right side and horizontal scrollbars at the bottom.





---

# 11.

# Maintenance tasks

This chapter contains instructions for performing routine maintenance tasks for the LPS. The activities described here are essential to maintain system reliability and productivity.

This chapter also contains instructions for using the custom transfer assist blade.

---

## Precautions you should take

---

For your own safety and to protect the DocuPrint 180LPS, follow these precautions whenever you perform maintenance tasks:

- Use only replacement supplies recommended by Xerox or Xerox Limited.
- Keep replacement supplies in stock. (Refer to appendix B, "Supplies.")
- Handle all system parts carefully when performing maintenance tasks.
- To prevent spillage, always use a drop cloth when replacing the dry ink, dry ink waste container, or fuser agent.

---

## Cleaning supplies

---

The cleaning supplies necessary to complete the cleaning tasks are described in this chapter, where appropriate. Additional information can be found in the "Supplies" appendix.

## Maintaining the printer

When supplies for the LPS need to be replaced, for instance, when the dry ink supply is low, the following indications appear:

- If enabled, the Attention light goes on.
- A message and instructions appear on the printer control console.
- The Hint icon appears on the PC UI and the printer control console.



**Note:** If the Attention light is turned off, the Hint icon does not appear.

To ensure that the LPS runs efficiently, replace the appropriate supplies as soon as possible after seeing the indications. If you do not do so, the printer eventually stops and does not continue until you replace the supplies.

## Replacing the dry ink cartridge



**Caution:** To prevent dry ink spillage, remove the cartridge only when directed to do so by a message on the printer control console.

Follow this procedure to replace the dry ink cartridge:

- Step 1.** Open the printer's right and left doors and locate the dry ink area at the left side of the printer (see figure 11-1). There are step-by-step instructions on the panel next to the dry ink cartridge.

Figure 11-1. **Locating the dry ink cartridge**

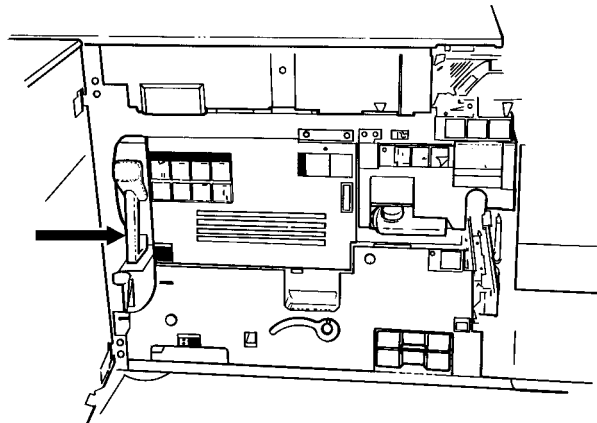

- Step 2.** Place a drop cloth on the floor under the dry ink area.
- Step 3.** Pull the empty dry ink cartridge out until it stops.

- Step 4.** Move the green handle to the right (the unlatched position) to release the cartridge and lid (see figure 11-2).

Figure 11-2. Unlatching the dry ink cartridge

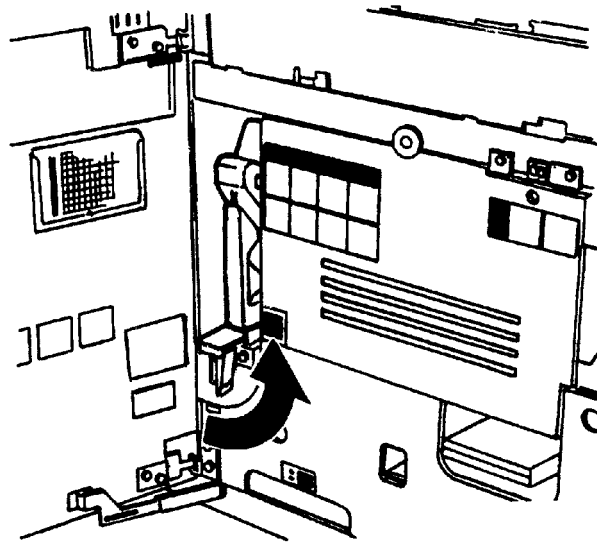

- Step 5.** Remove the empty cartridge and discard it.
- Step 6.** Turn a new, full cartridge of dry ink upside down and shake it well to loosen the contents thoroughly (see figure 11-3).

Figure 11-3. Preparing the dry ink cartridge



- Step 7.** Insert the new cartridge into the printer until it stops.

- Step 8.** Move the green handle to the left (the latched position) to secure the lid of the cartridge (see figure 11-4).

Figure 11-4. Inserting and latching the dry ink cartridge

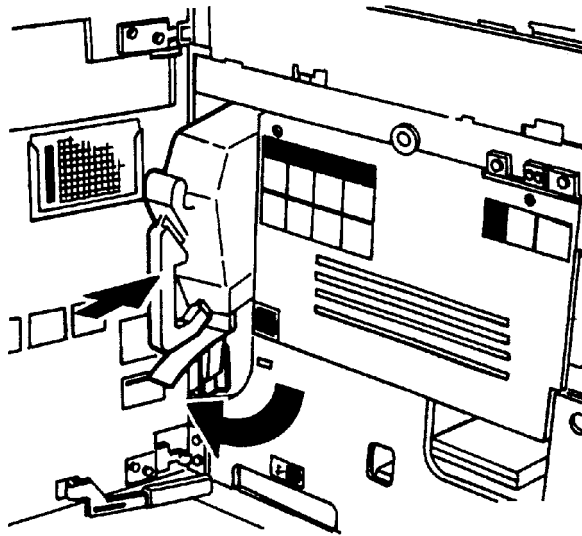

- Step 9.** Hold the cartridge in place and pull off the paper seal.
- Step 10.** Discard the seal along with the drop cloth.
- Step 11.** Close the printer doors.



**Note:** If any dry ink gets on your hands, wash them with soap and cold water. Heat sets the ink permanently. If any dry ink gets on your clothes, brush them with a dry paper towel or a stiff-bristled brush. If this does not remove the ink immediately, launder with detergent and cold water. Dry cleaners should be told that the spot is dry ink for a printer, so they will not use a solvent that sets the stain.

## Replacing the dry ink waste container

To replace the dry ink waste container:

- Step 1.** Open the right and left doors of the printer and locate the dry ink waste container (see figure 11-5).

Figure 11-5. **Dry ink waste container**

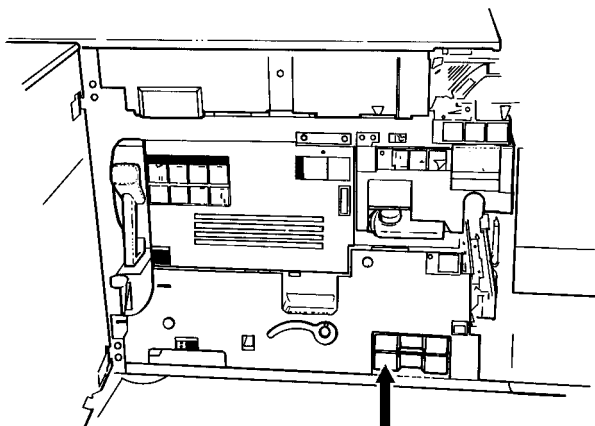

- Step 2.** Place a drop cloth on the floor under the dry ink waste container area.



**Caution:** To prevent dry ink spills, do not tip or tilt the waste container.

- Step 3.** Pull the full waste container out of the printer (see figure 11-6).

Figure 11-6. **Removing the full waste container**

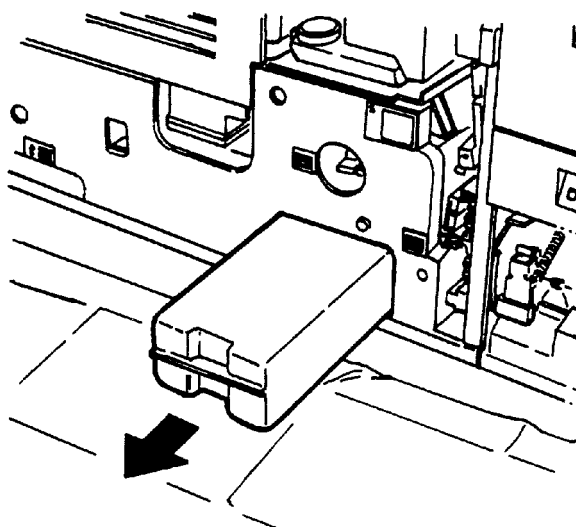

- Step 4.** Remove the cap from the top of the full waste container.

- Step 5.** Place the removed cap over the opening on the end of the full waste container (see figure 11-7).

Figure 11-7. **Placing the cap on the waste container**

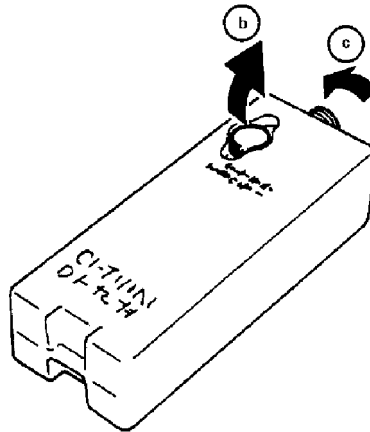

- Step 6.** Slide a new, empty, dry ink waste container into the printer until the container stops (see figure 11-8).



**Note:** Do not remove the cap from the new container.

Figure 11-8. **Inserting the new dry ink waste container**

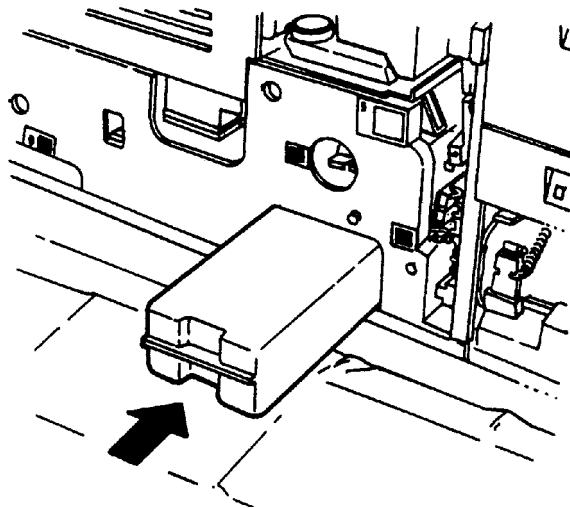

- Step 7.** Close the printer doors.



**Note:** If any dry ink gets on your hands, wash them with soap and cold water. Heat sets the ink permanently. If any dry ink gets on your clothes, brush them with a dry paper towel or a stiff-bristled brush. If this does not remove the ink immediately, launder with detergent and cold water. Dry cleaners should be told that the spot is dry ink for a printer, so they will not use a solvent that sets the stain.

## Adding fuser agent



**Warning:** Fuser agent contains silicone, which can cause irritation upon contact with the eyes. Be sure to wash your hands with soap and water after you finish this procedure.

To add fuser agent:

- Step 1.** Open the right and left doors of the printer and locate the fuser area (see figure 11-9).

Figure 11-9. **Fuser area**

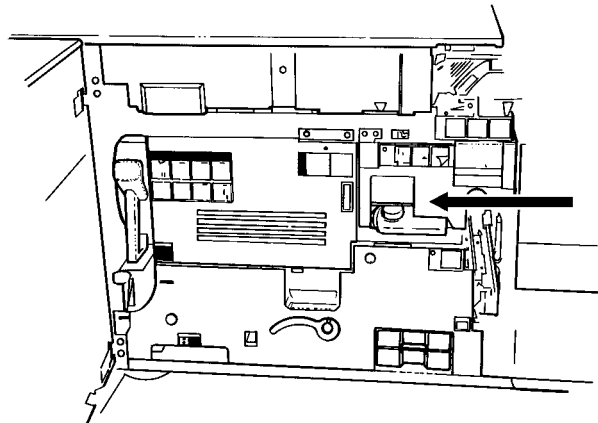

- Step 2.** Place a drop cloth on the floor under the fuser area.

- Step 3.** Grasp the green handle on the fuser drawer and pull it out until it stops (see figure 11-10).

Figure 11-10. Opening the fuser drawer

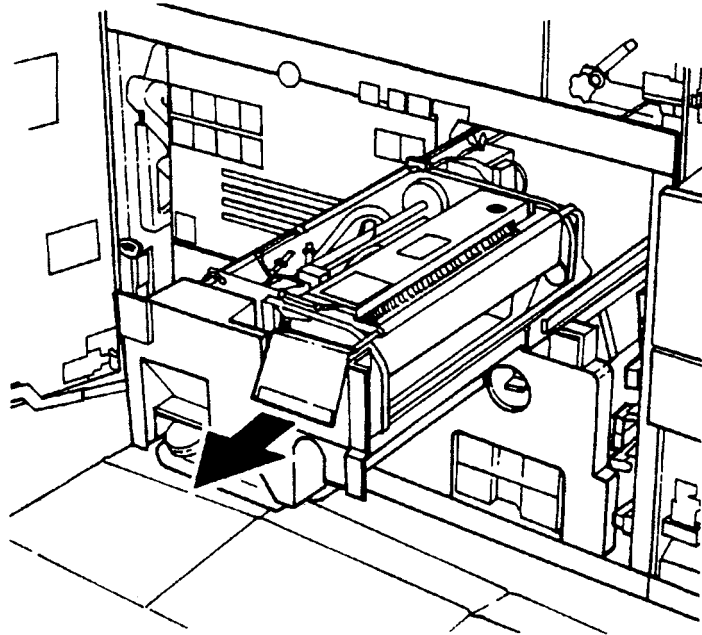

- Step 4.** Locate the fuser agent reservoir (see figure 11-11).

Figure 11-11. Locating the fuser agent reservoir

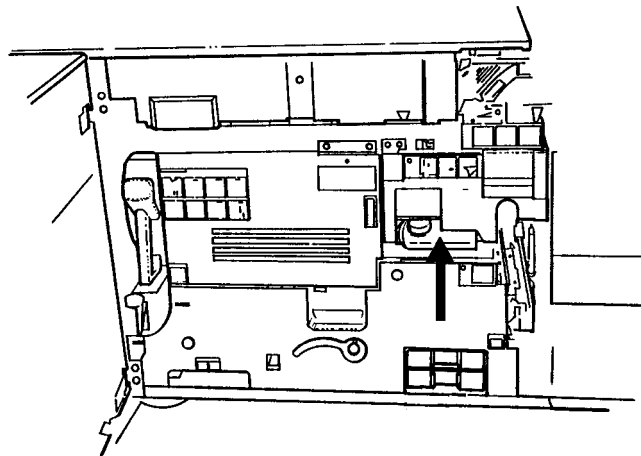

- Step 5.** Pull the fuser agent reservoir out until it stops.  
**Step 6.** Remove the reservoir cap by turning it counterclockwise.  
**Step 7.** Remove the cap from a new bottle of fuser agent.



**Warning:** If any fuser agent spills on the floor, remove it immediately. Fuser agent spills make the floor slippery.





**Caution:** The fuser reservoir has an antispash seal. Do not push the fuser agent bottle into the reservoir with excessive force, as this can damage the seal.

- Step 8.** Carefully pour the fuser agent into the reservoir, until the level reaches the MAX line (see figure 11-12).

Figure 11-12. Adding the fuser agent

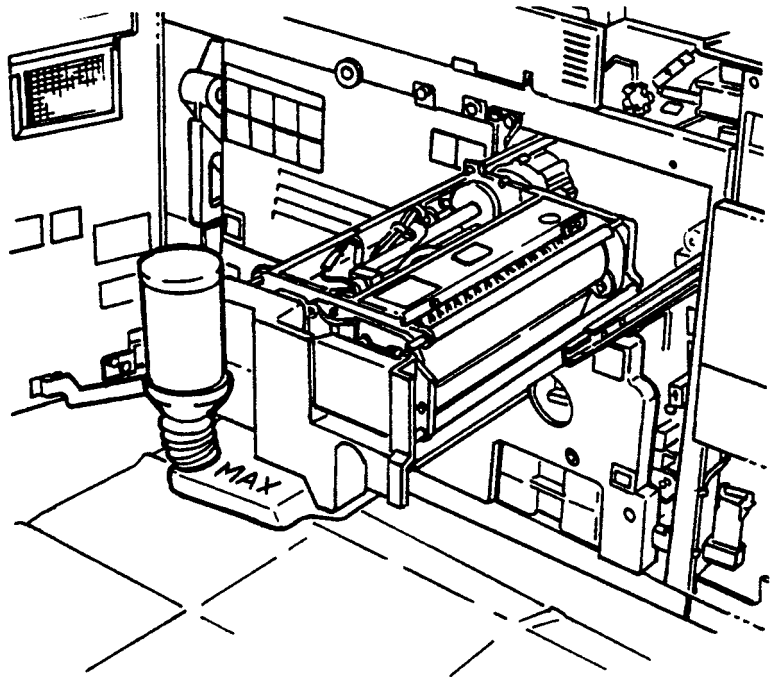

- Step 9.** Replace the reservoir cap by turning it clockwise.
- Step 10.** Push the fuser agent reservoir in until it stops.

**Step 11.** Push the fuser drawer in until it latches in place (see figure 11-13).

Figure 11-13. Closing the fuser drawer

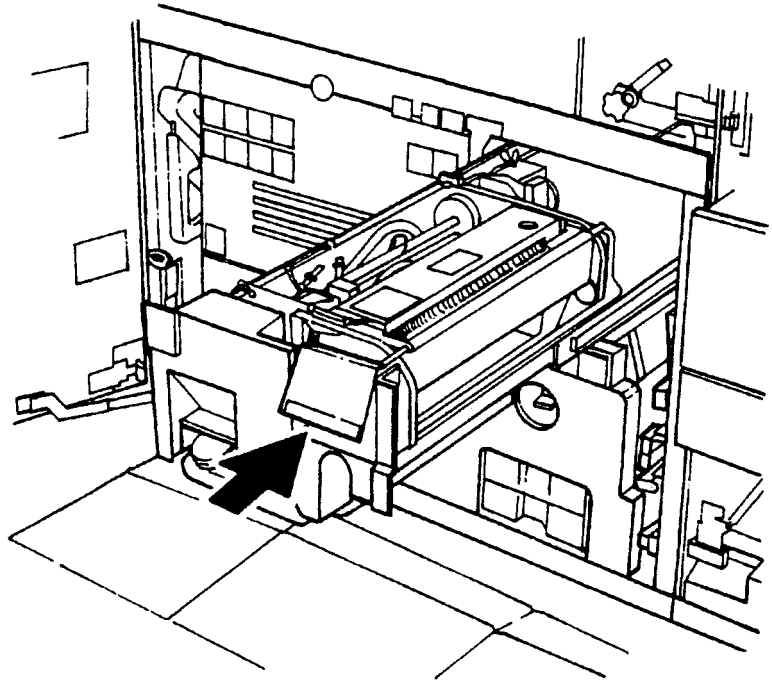

**Step 12.** Close the printer doors.



**Note:** The fuser agent message disappears after the LPS prints between 32 and 40 sheets. Since the sheets must be processed continuously, you may want to run 45 test pages in order to clear the message from the system (unless the current print job contains at least 40 pages).

## Cleaning the sensors and the reflecting surfaces

This section lists the steps to clean the following:

- Q850 sensor
- Q1011 sensor and mirror
- Q1106 sensor
- Q1166 sensor
- Q1107 sensor
- Q1164 sensor.

## Cleaning the Q850 sensor

Follow this procedure when directed by the Xerox Customer Support Center personnel.

- Step 1.** Open the printer right and left doors and locate area 4.
- Step 2.** Raise the area 4 green handle until it locks into place (see figure 11-14).

Figure 11-14. Raising the Area 4 green handle

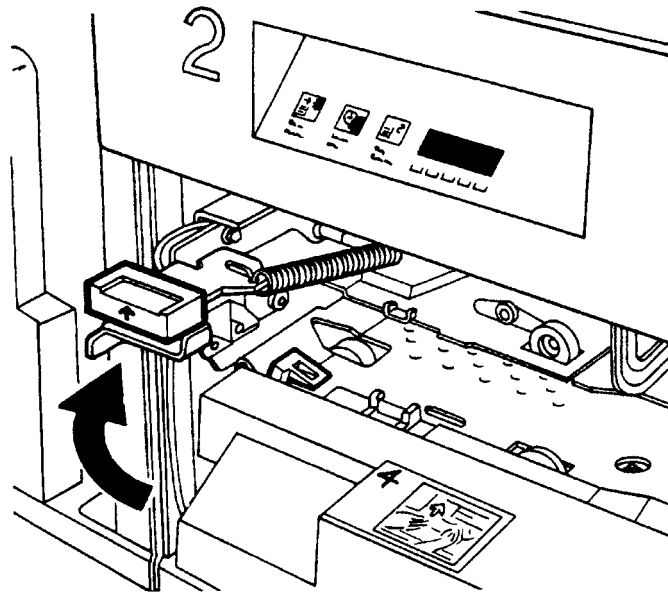

- Step 3.** Locate the Q850 sensor (see figure 11-15).

- Step 4.** Place a dry cleaning pad on the sensor and move it from left to right to clean the sensor.

Figure 11-15. Cleaning the Q850 sensor

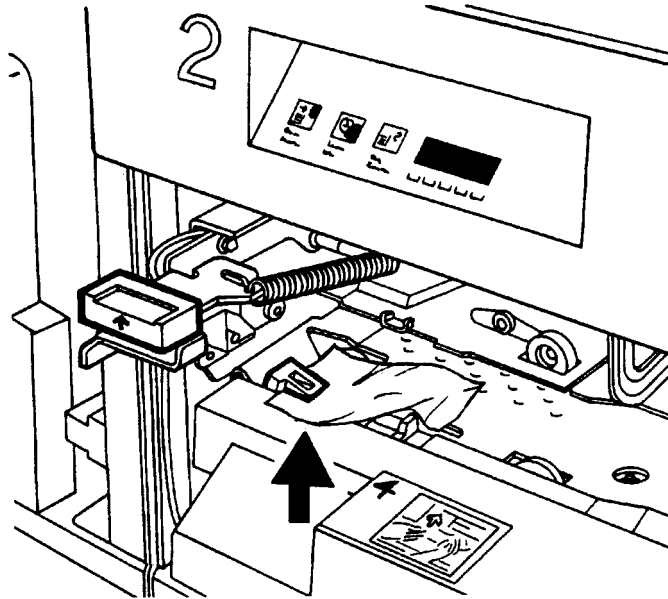

- Step 5.** Lower the area 4 green handle.
- Step 6.** Close the printer doors.

## Cleaning the Q1011 sensor and mirror

Follow this procedure when directed by the Xerox Customer Support Center personnel.

- Step 1.** Open the right and left doors of the printer and locate the Q1011 sensor (see figure 11-16).

Figure 11-16. Q1011 sensor location

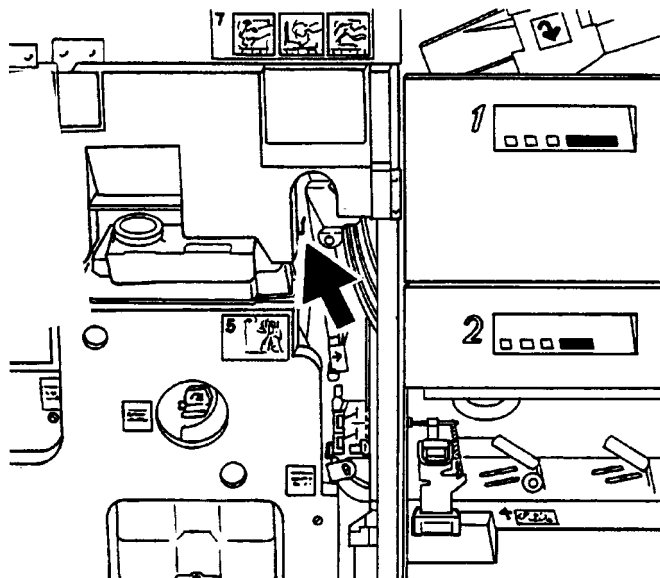

- Step 2.** Apply a small amount of lens and mirror cleaner to a cleaning pad.

- Step 3.** Wipe the sensor and mirror gently with the cleaning pad (see figure 11-17).

Figure 11-17. Areas to clean

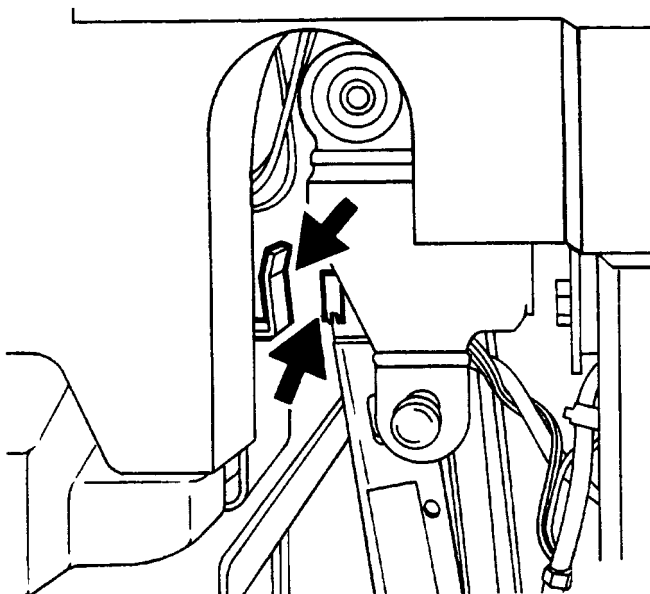

- Step 4.** Close the printer doors.

### Cleaning additional sensors

There are additional sensors which you should clean when directed by the Xerox Customer Support Center personnel. To clean the sensors, follow this procedure:

- Step 1.** Brush or wipe the sensor window lightly.
- Step 2.** Remove any paper dust present in the area.



**Note:** If the sensor is very dirty, you may use a small amount of alcohol on a swab to clean it.



**Caution:** Do not use any abrasive materials or stronger solvents on the sensor.

#### Sensors Q1106 and Q1166

To access sensors Q1106 and Q1166, open the top cover of the high-capacity stacker. See figure 11-18 for the location of the sensors.

Figure 11-18. Q1106 and Q1166 sensor location

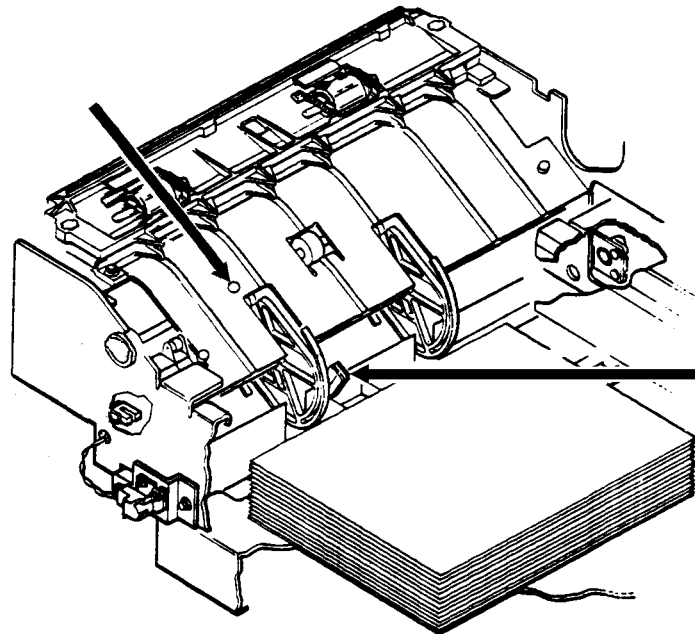

- Sensor Q1107** To access sensor Q1107, open the top cover of the high-capacity stacker. See figure 11-19 for the location of the sensor.

Figure 11-19. Q1107 sensor location

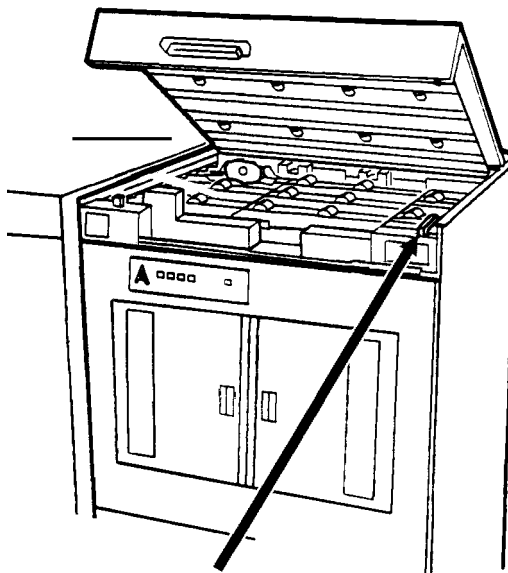

- Sensor Q1164** To access sensor Q1164, open the top cover of the last feeder/stacker module (the one containing the purge tray). See figure 11-20 for the location of the sensor.

Figure 11-20. Q1164 sensor location

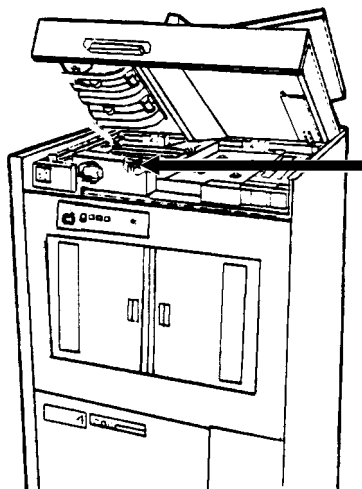

## Cleaning the terminal and the exterior surfaces of the system

---

Clean the display with a soft, lint-free cloth dampened with a glass or lens and mirror cleaner. Do not spray the liquid directly onto the display since it may cause damage.

Although the keyboard may seldom need to be cleaned, the exterior surfaces of the system controller and printer should be cleaned daily, if possible. Clean the keyboard and exterior surfaces with a mild household detergent which has been poured or sprayed onto a cloth lightly dampened with water. Do not saturate the cloth; just dampen it. Liquids must not be allowed to drip onto anything electrical or mechanical. For the same reason, **never spray or pour the cleaner directly onto the keyboard or the exterior surfaces of the system.**

---

## Cleaning the open-reel tape drive

---

The open-reel tape drive must be cleaned regularly to keep it functioning properly. Clean the:

- Tape path
- Exterior of the tape drive.



**Note:** Use Isopropyl alcohol and lint free swabs to perform the cleaning of the tape drive.

---

## Tape drive cleaning schedule

---

When first using the open-reel tape drive, follow this cleaning schedule:

- If the tape drive is used continuously, clean the following parts daily:
  - Tape heads
  - Tape cleaner
  - Bollards
  - Rollers
  - Tacho roller.
- Clean after 100 tape loads:
  - Supply reel
  - Clamp pads.
- Clean as required:
  - Painted surfaces
  - Tape path cover.

Figure 11-21 shows the location of the tape path components.



Figure 11-21. 9-track tape drive tape path components

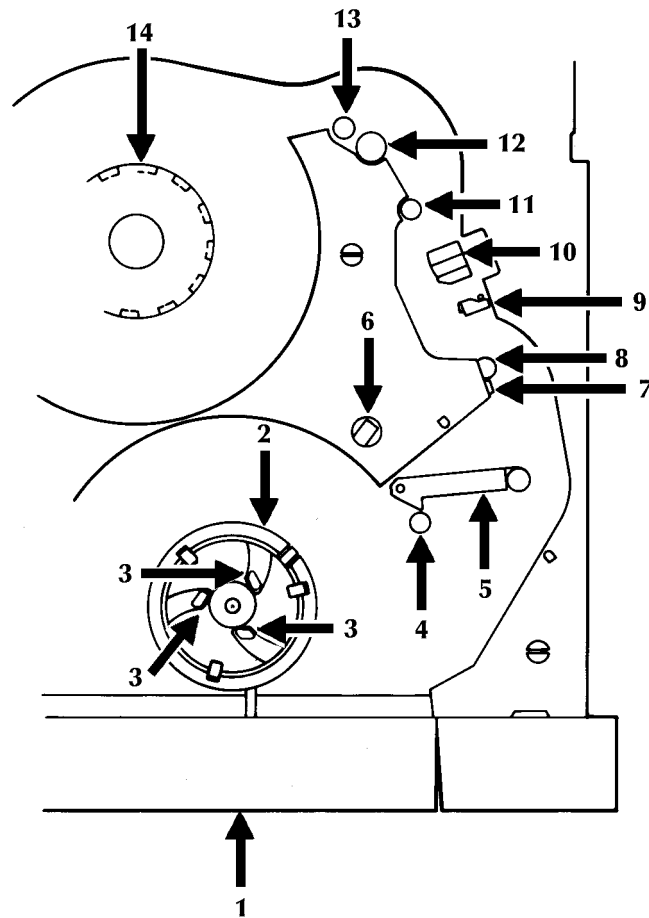

- 1 Tape loading door
- 2 Supply hub
- 3 Clamp pads
- 4 Roller
- 5 Tension arm
- 6 Hub Release lever
- 7 BOT/EOT sensor
- 8 Bollard
- 9 Tape cleaner
- 10 Tape heads
- 11 Bollard
- 12 Tachometer
- 13 Roller
- 14 Take-up hub

Inspect the tape path regularly and monitor the error rates. You may be able to clean less frequently after seeing the results of this schedule.

## Cleaning precautions—READ BEFORE CLEANING

Note the following:

- The edges of the tape cleaner are extremely sharp. Observe great care when cleaning them.
- Avoid inhaling fumes from the cleaning fluids.
- Keep the cleaning solution containers tightly closed when not in use.
- Use the cleaning solutions only in well-ventilated areas.
- If you have sensitive skin, you may want to wear gloves when using the cleaning solutions.
- Avoid prolonged contact with the skin.

## Cleaning procedures

This section lists the steps to access and clean the tape path, and to clean the exterior of the tape drive.

### Access to the tape path

To access the tape path:

- Step 1.** Open the cover of the peripheral cabinet.
- Step 2.** Release the three turnbuckles on the tape path cover by turning them counter clockwise (see figure 11-22).

Figure 11-22. Releasing the turnbuckles

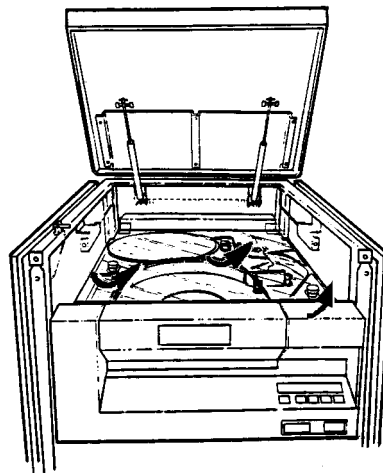

- Step 3.** Raise the cover as far as it will go.
- Step 4.** Press the Reset button to open the tape loading door.
- Step 5.** Turn off the tape drive by pressing the Power switch off.

## Cleaning the tape path

---

To clean the tape path:

**Step 1.** Lightly moisten a soft, lint-free cloth with cleaning solution.

**Step 2.** Carefully wipe the surfaces of the head and the tape cleaner, removing all traces of dirt and oxide.

In *extreme* cases, you may need to use a scrubbing action to remove hard oxide deposits.



**Warning:** The edges of the tape cleaner are extremely sharp. Observe great care when cleaning them.

**Step 3.** Inspect the remaining tape path components. If necessary, clean the following components:

- Tape contact surfaces of the roller guides
- Tension arm roller
- Surface of the tachometer (tacho) roller.



**Caution:** Do not use alcohol-based fluid or any other solvents on plastic or painted parts.



**Caution:** Do not allow cleaning fluid to enter pregreased roller bearings.

**Step 4.** Remove any dirt or oxide you find around the take-up and supply reel areas.

**Step 5.** Close the tape path cover and secure the turnbuckles by turning them clockwise.

**Step 6.** Close the cover of the peripheral cabinet.

**Step 7.** Turn on the tape drive by pressing the Power switch on.

## Cleaning the exterior of the tape drive

---

To clean the exterior of the tape drive, you must use the following materials:

- Antistatic cleaner and a soft cloth to clean the tape path cover.
- A cloth moistened with soapy water to clean the painted surfaces of the tape drive.

## Cleaning the 18/36 track cartridge tape drive

---

You must clean the 18/36 track cartridge tape drive regularly to keep it functioning properly. You can clean the:

- Tape path
- Cartridges.

### Cleaning supplies

A cleaning cartridge is shipped with each 18/36 track cartridge tape drive. This cartridge should be replaced after 500 uses.

## When to clean the tape drive

---

When the tape drive needs to be cleaned, CLEAN appears in the message display after a cartridge is unloaded and during a rewind or locate operation.



**Caution:** Never power off the tape drive without following the cleaning procedure once the CLEAN message has appeared.

## Cleaning procedures

---

This section lists the steps to clean the tape path and the cartridge.

### Cleaning the tape path

---

To clean the tape path:

- Step 1.** Remove any cartridge loaded in the tape drive.
- Step 2.** Insert the cleaning cartridge.



**Caution:** The cleaning cartridge must be undamaged and clean.

The cleaning cycle takes approximately 15 seconds.

- Step 3.** Remove the cleaning cartridge when it is unloaded.
- Step 4.** Mark the usage on the tape label. Do not use a grease pencil.

### Cleaning a cartridge

---

Before inserting a cartridge, inspect it for damage or dirt.

If the cartridge is dirty, wipe the outside surfaces with a lint-free cloth.

---

## Cleaning the quarter inch cartridge (QIC) tape drive

---

The quarter inch cartridge (QIC) tape drive heads should be cleaned at least once a week. If you use the drive for eight hours or more per day, then you should clean the drive daily. The process is simple and requires very little time.

- Step 1.** If there is a cartridge in the tape drive, remove it.
- Step 2.** Insert the cleaning cartridge into the tape drive and close the door. Cleaning begins automatically once the cartridge is inserted.
- Step 3.** Allow the tape to run for approximately 30 seconds, then remove it.



**Note:** Replace the foam pad on the cleaning cartridge after it has been used three times. The cleaning cartridge itself can be used approximately 100 times.

## Using the custom transfer assist blade

---

The transfer assist blade in the Xerox DocuPrint 180 LPS assures good print quality for your jobs. A kit is available allowing you to customize a transfer assist blade for use with non-standard paper size.

## When not to use the custom transfer assist blade

---

You cannot use the custom transfer assist blade for print jobs that use more than one paper size. In addition, the following range of paper lengths cannot use the custom blade:

- In U.S. markets
  - 11.1 to 11.4 inches/282 to 290 mm
  - 11.8 to 12.1 inches/300 to 307 mm
  - 13 to 13.5 inches/330 to 343 mm.
- In non-U.S. markets
  - 11.1 inches to 11.4 inches/282 to 290 mm
  - 11.8 inches to 12.1 inches/300 to 307 mm.



**Note:** With these paper sizes, transfer efficiency may be reduced.



**Caution:** For the above paper sizes, the standard transfer assist blade must be used.



**Caution:** To avoid damage to the photoreceptor, you must perform the Set Tray Size task explained in the “Status and print tasks” chapter.

## Installing the custom transfer assist blade

---

The custom transfer assist blade comes in a package containing detailed instructions. Be sure to follow the instructions carefully.



**Caution:** To prevent damage to the LPS, have your service representative show you the procedure before you attempt to customize and install a custom transfer assist blade for the first time.

## Setting tray size with the custom transfer assist blades

When you are using the custom transfer assist blade, you must set the tray length differently than described in the “Set tray size” section of the “Status and print tasks” chapter. Use tables 11-1 and 11-2 to determine the tray length setting to use.

Table 11-1. **Tray length settings for custom transfer assist blades (U.S. markets)**

| Paper size                        | Set tray size to... |
|-----------------------------------|---------------------|
| 11.5 to 11.7 inches/292 to 297 mm | 11.7 inches/297 mm  |
| 12.1 to 12.9 inches/307 to 328 mm | 13 inches/330 mm    |
| 13 to 13.9 inches/330 to 353 mm   | 14 inches/356 mm    |

Table 11-2. **Tray length settings for custom transfer assist blades (Non-U.S. markets)**

| Paper size                        | Set tray size to... |
|-----------------------------------|---------------------|
| 10 to 10.9 inches/254 to 277 mm   | 11 inches/279 mm    |
| 11.5 to 11.6 inches/292 to 294 mm | 11.7 inches/297 mm  |
| 12.1 to 12.9 inches/307 to 328 mm | 13 inches/330 mm    |



**Note:** Set the tray width to the width of the custom paper.





---

## 12. Problem solving tasks

This chapter contains instructions for diagnosing and solving common problems that may arise when operating the LPS. Also included are instructions for placing a service call, when needed.

---

### LPS problems

---

The following sections deal with LPS problems.

#### Fault masking and the printer control console

---

The Xerox DocuPrint 180 LPS allows you to continue printing while certain faults or conditions exist in areas of the printer not currently being used. The LPS does this by “masking” the fault or condition and continuing to print the current job. For example, if you are printing a report using feeder tray 1 and stacking into stacker bin A, the LPS continues printing even if a jam exists in feeder tray 2 or if stacker bin B is full. Whenever there is a masked fault or condition, the Hint icon (a light yellow circle with an asterisk inside) appears on the printer control console and the Attention light goes on. If a condition is being masked, such as low dry ink, a message also appears in line 3 of the message area of the printer control console. The message is preceded by an asterisk. In the case of either a masked fault or condition, the Hint icon appears on the PC UI and a message appears in the Messages window. To display the area containing the masked fault (for example, the location of the paper jam), touch the Fault List icon on the printer control console.



The Fault List screen appears. (See figure 12-1.)

Figure 12-1. **Fault List screen**

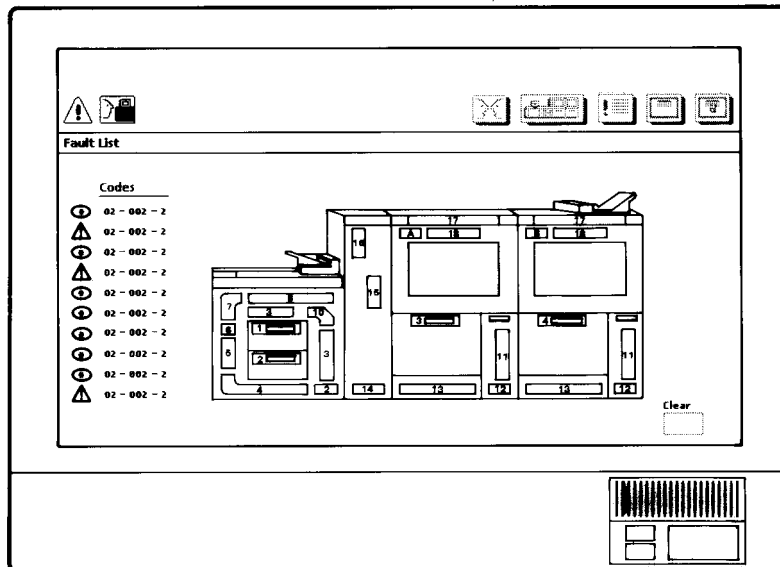

The Fault List screen displays any outstanding fault codes and shows a mimic of the printer, with the area containing the masked fault highlighted in light yellow.

Note the following:

- For greatest printer productivity, clear any masked faults at your earliest opportunity.
- When the printer stops because of a fault, it is a good idea to display the Fault List screen after clearing the fault to see if there are any outstanding masked faults. Clear these masked faults before continuing with the print job. Doing so will enhance printer productivity.
- When there is a fault that cannot be masked, that is, that causes the printer to stop, the Fault icon (a dark yellow triangle with an exclamation point inside) appears on the printer control console and the Attention light flashes. The Fault screen appears on the printer control console, highlighting (in dark yellow) the area(s) of the printer containing the fault, and instructions are given for clearing the fault.
- If a fault exists in the system at the time that a masked fault occurs, only the Fault icon appears on the printer control console. Any masked fault condition messages still appear in the message area of the printer control console.

## Printing problems

When prints are skewed or damaged, follow these steps to adjust the registration transport roll levers (heavy paper levers):

### Prints are skewed or damaged

To correct this problem, adjust the registration transport roll levers (heavy paper levers) in the following way:

- Step 1.** Open the right and left doors of the printer and locate the heavy paper levers. (They are located behind area 4 and area 2.)
- Step 2.** Pull the levers forward (toward you) on the silver latch release.
- Step 3.** Turn both levers to the left (counter clockwise), as illustrated in figure 12-2.

Figure 12-2. Locating the two heavy weight levers

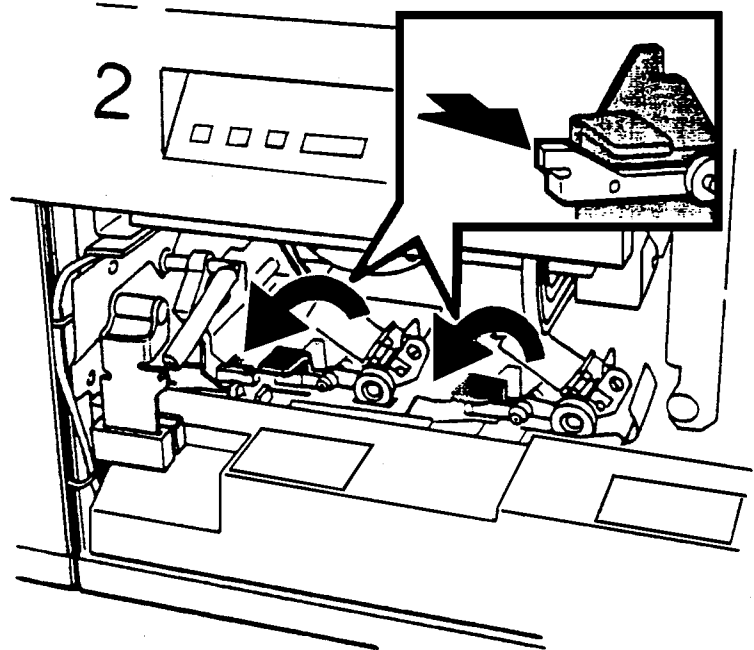



**Note:** If your system is equipped with the optional 7 X 10 enablement kit, you have three levers, as illustrated in figure 12-3. Turn the left lever to the left (counter clockwise), and the other two levers to the right (clockwise) for heavy weight papers.

Figure 12-3. **Locating the three heavy weight levers in systems with the optional 7 X 10 enablement kit**

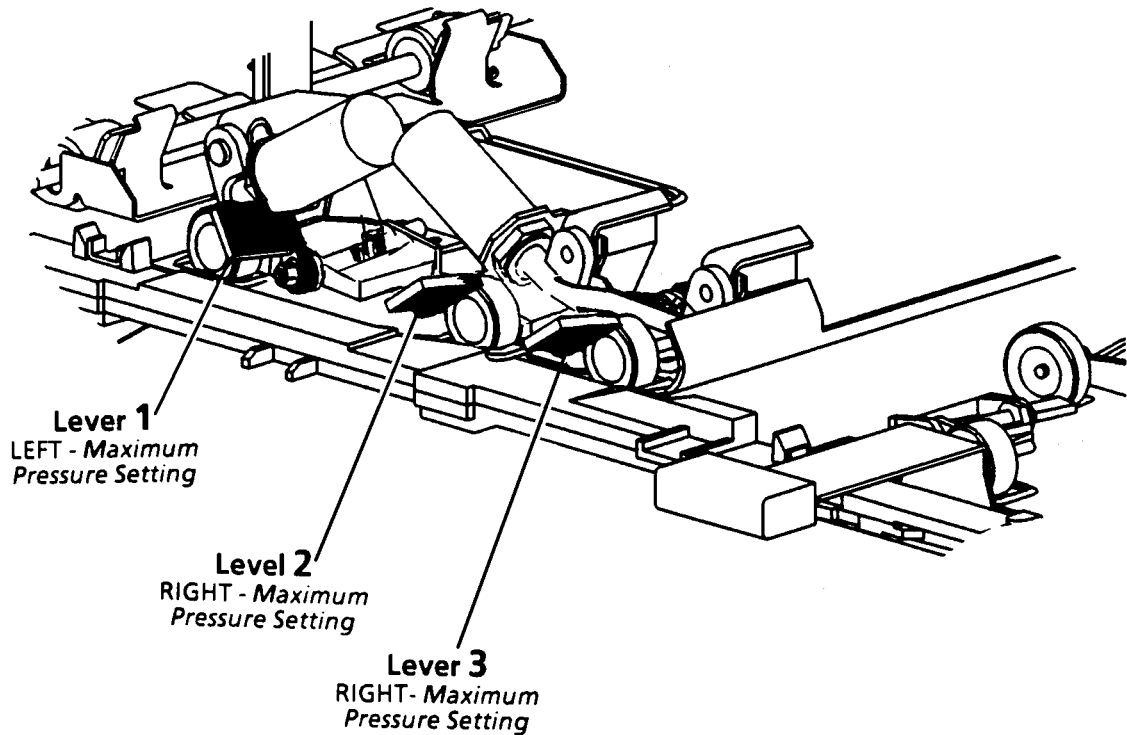

**Step 4.** When the print job is complete, return the levers to their normal position.

**Step 5.** Close the printer doors.

Note the following:

- Position all levers for either the minimum or the maximum pressure settings. Do not intermix the position of the levers.
- Paper greater than 14 inch is considered oversized.
- Paper heavier than 24 pounds is considered heavy weight.
- The following factors may affect the positioning of the paper levers:
  - machine tolerance
  - paper supplier
  - job type (e.g., duplex).

## Paper jams

The paper path is the route materials (paper, transparencies, labels, and so on) follow through the printer from the feeder trays to the stacker bins, sample tray, or purge tray. Paper jams can occur at any stage of the paper path. Following a paper jam the printer stops, and the following indications appear:

- If enabled, the Attention light flashes.
- The Fault icon appears on the PC UI and printer control console.
- Messages appear on the system controller display and the PC UI, informing you of the paper jam.
- The printer mimic on the printer control console shows the area of the paper jam and lists instructions for clearing the jam (see figure 12-4).

Figure 12-4. Jam display on the printer control console

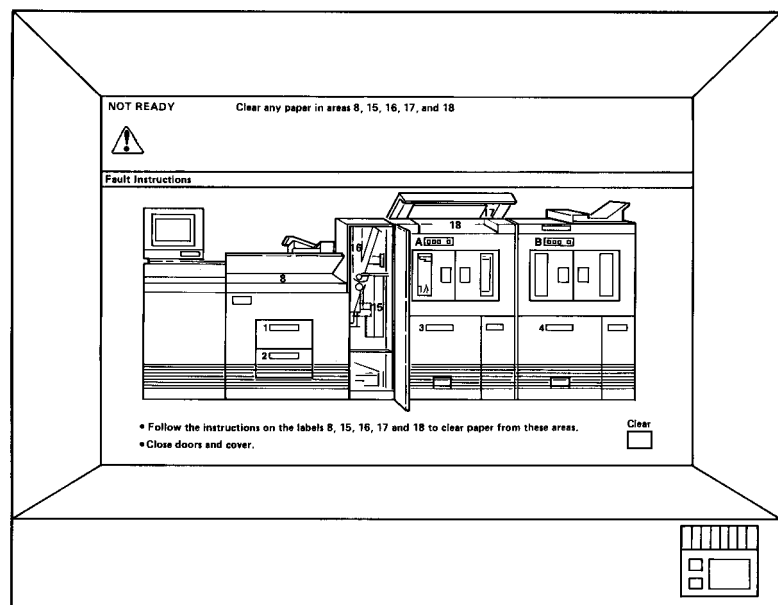

**Note:** It is important that you clear the sheets only in the area(s) indicated on the printer control console.

## Paper curl and paper jams

Too much curl in the paper stock can cause paper jams. You can adjust the decurler lever to correct most of these problems. Refer to the paper curl chart at the end of this chapter (figure 12-45) to determine the amount of curl in the paper stock.

**Measuring the paper curl** To measure the paper curl:

- Step 1.** Print five one-sided (simplex) 8.5 by 11 inch or A4 sheets.
- Step 2.** Measure the amount of curl in the prints by holding the five prints in the top center of the short edge (see figure 12-5).  
Keep the image toward you.

Figure 12-5. **Measuring the paper curl**

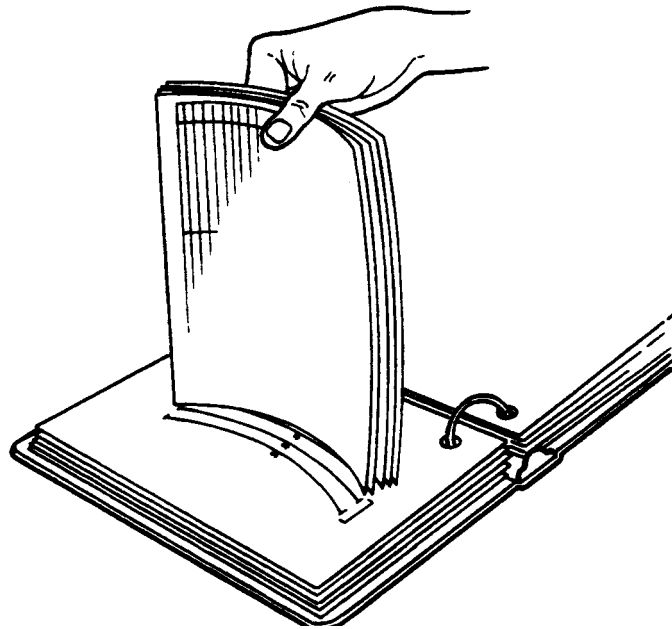

- Step 3.** Place the bottom edge of the prints over the paper curl measurement chart located at the end of this chapter.
- If the print curl on the printed paper stock measures between +2 and -2, do not change the decurler setting.
  - If the curl is between +2 and +3, or -3 and -4, use the following procedure to adjust the decurler lever.

**Adjusting the decurler lever** To adjust the decurler lever:

- Step 1.** Open the right door of the printer and locate the decurler lever (see figure 12-6).

Figure 12-6. **Decurler lever**

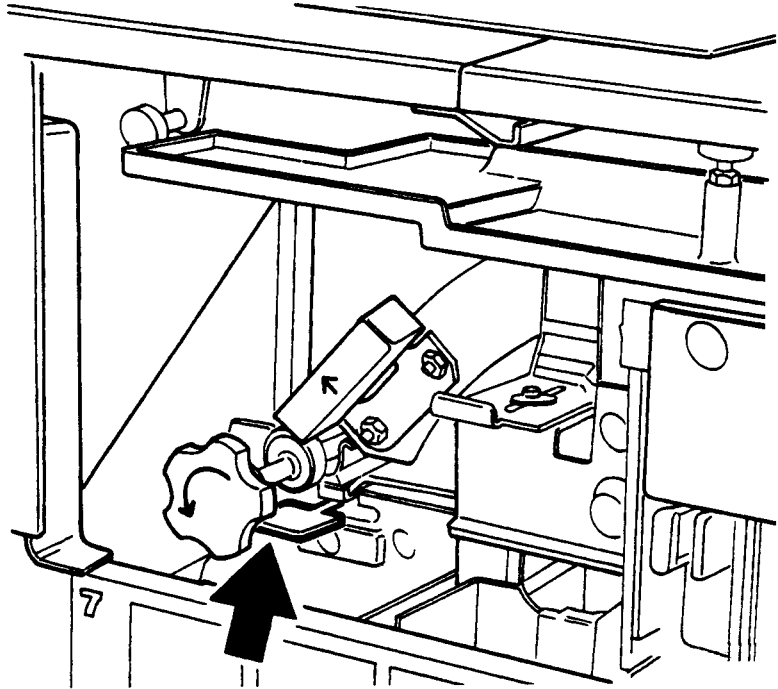

- Step 2.** If the print curl is +2 or more, move the green decurler lever to the right.
- Step 3.** If the print is -3 or more, move the green decurler lever to the left.
- Step 4.** If the decurler adjustment does not eliminate the paper curl problem, turn the paper stack over in the feeder tray.
- Step 5.** If there is still a paper curl problem, perform steps 1 to 4 again.
- Step 6.** If all else fails, insert paper from a new ream.

**Aids to paper jam clearance**

Each area of the printer where jams can occur has detailed message labels that tell you how to clear the jam (see figure 12-7).

Figure 12-7. Message labels inside the LPS

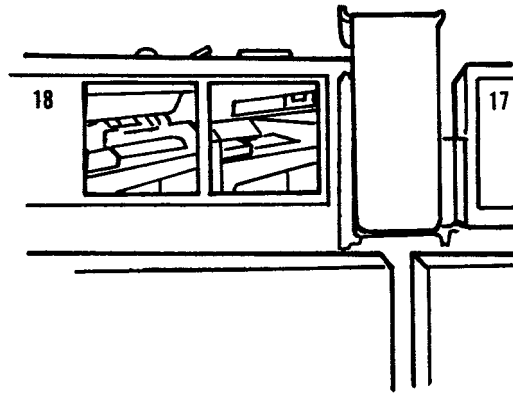

Each handle, lever, or knob that must be moved to clear a jam is bright green and marked with an arrow indicating the direction it moves.

**Clearing area paper jams**

Refer to figure 12-8 for an overview of the paper jam areas.

Figure 12-8. Paper jam areas

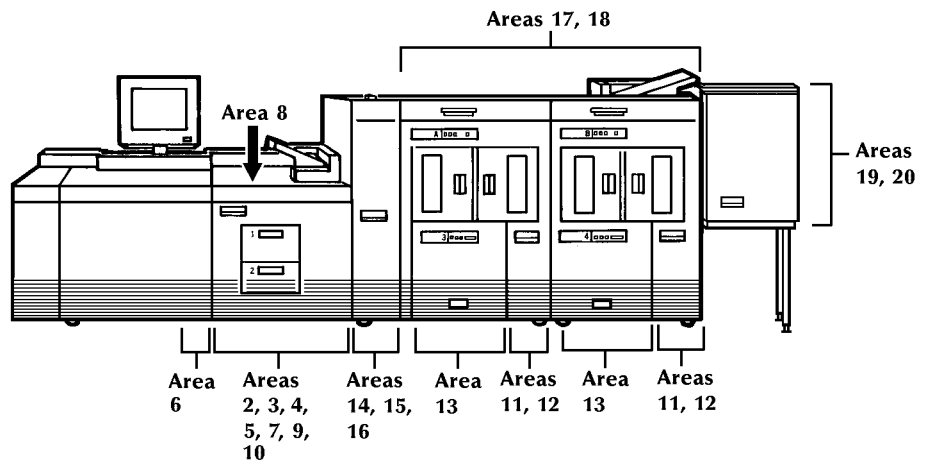

To clear a paper jam:

- Step 1.** Go to the area of the printer indicated by the messages and display on the printer control console.
- Step 2.** Open any printer doors necessary to access the area.
- Step 3.** Clear the jammed paper from the area, following the instructions on the LPS message labels and the messages on the printer control console.





**Note:** Occasionally you may find that the printer has already cleared the paper from a paper jam area to the sample or purge trays.

- Step 4.** Close any printer doors that were opened.
- Step 5.** Press the Continue button to resume printing.
- Step 6.** Discard any damaged sheets sent to the sample tray or purge tray.

#### **Checking job integrity following a paper jam**

---

When printing resumes following a paper jam, there is a slight possibility that duplicate sheets may be printed or sheets may be missing from a report. For that reason, you should check job integrity once the report has been printed.

To check job integrity:

- Step 1.** The printer offsets the first sheet printed following a paper jam. Locate that sheet.
- Step 2.** Check the sheets immediately before and after the offset sheet to see if there are any missing or duplicate sheets in the report.



**Note:** A message may appear on the PC UI and the printer control console telling you that there is a suspected page delivery error and advising you to check the output.

**Printer areas**

Figures 12-9 through 12-27 show printer areas 2 through 20.

Figure 12-9. **Area 2**

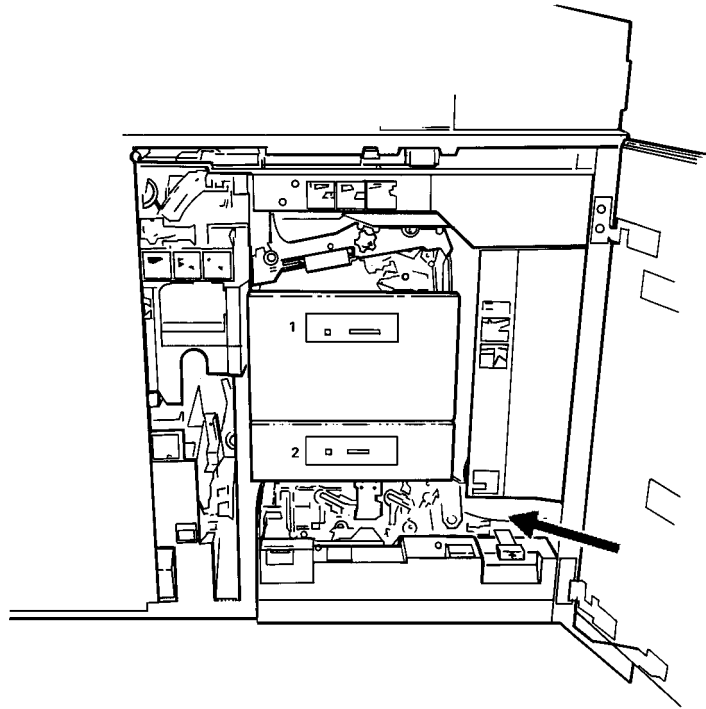

Figure 12-10. **Area 3**

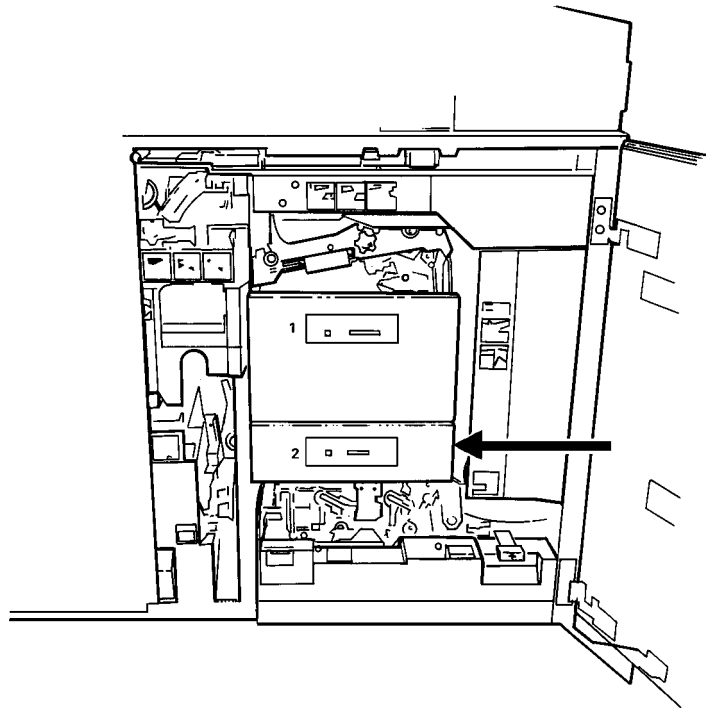

Figure 12-11. Area 4

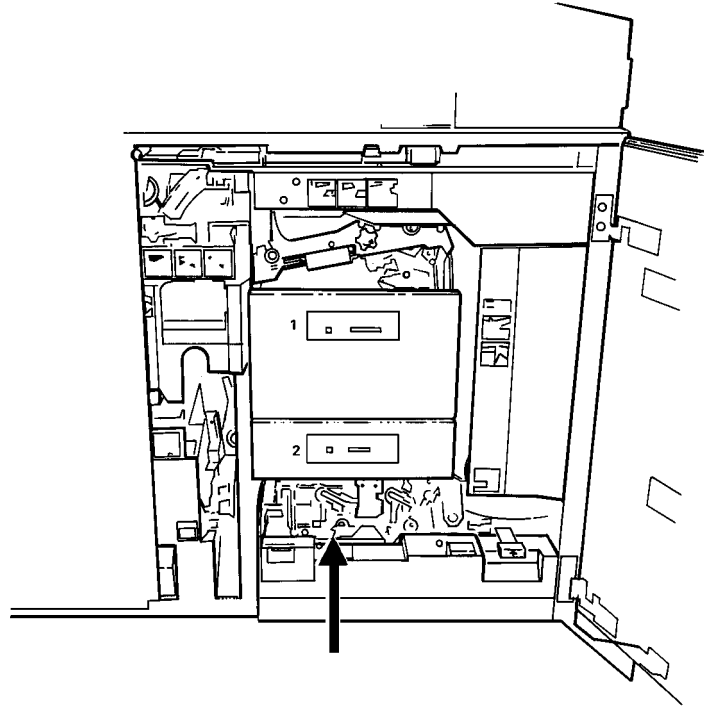

Figure 12-12. Area 5

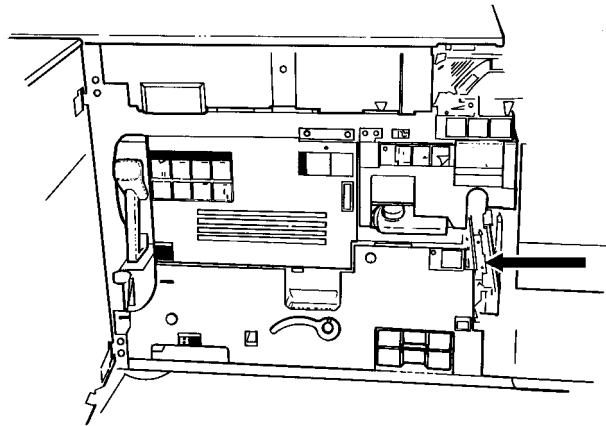

Figure 12-13. Area 6

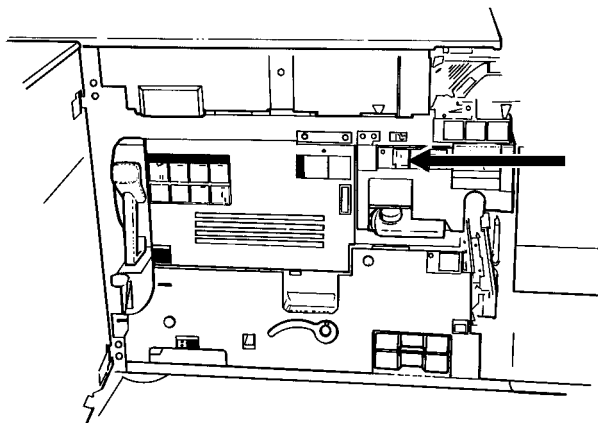

Figure 12-14. Area 7

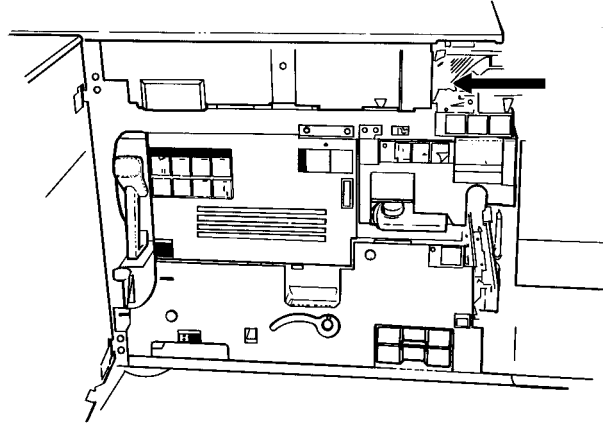
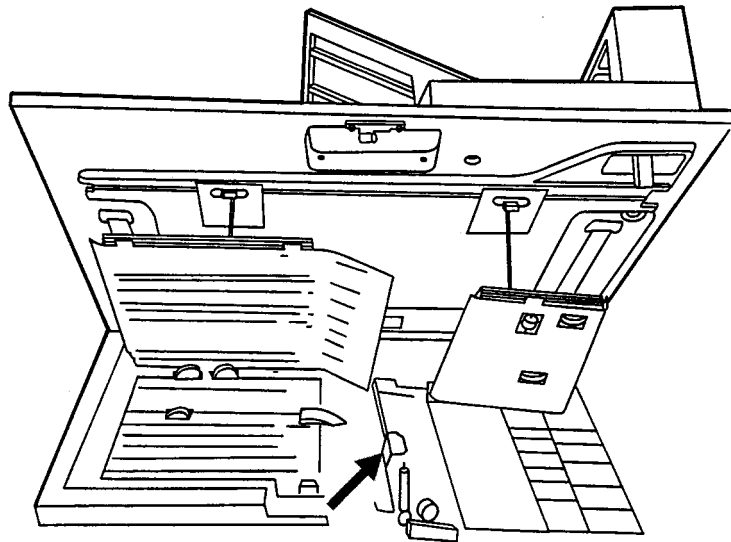

Figure 12-15. Area 8



Note the following:



**Note:** If jammed paper rips as you are removing it from area 8, you may have to use the pinch lever in area 9 to remove the paper. Refer to the "Notes" section following figure 12-16 for instructions.

Figure 12-16. Area 9

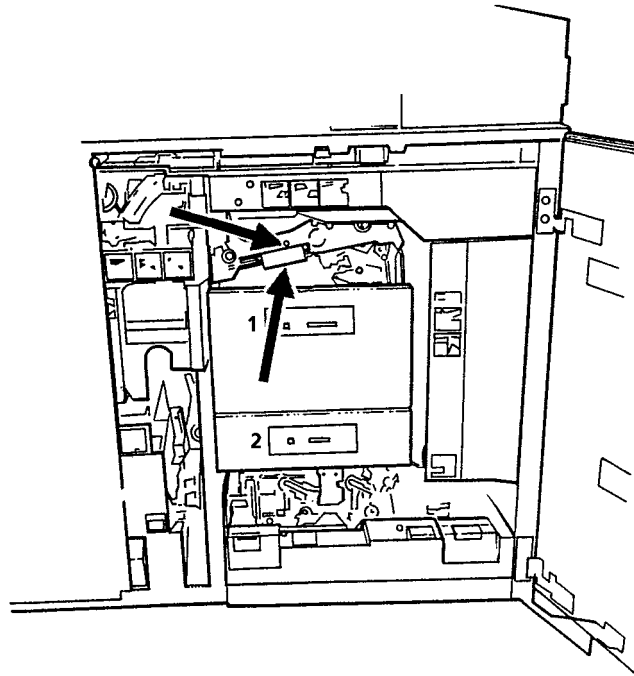

Note the following:

- Lower tray 1 and pull out tray to allow better access, when clearing area 9.
- Pull the area 9 green lever toward you to unlatch it. Ensure that you relatch the lever once you have cleared any paper in this area. You may also want to pull out tray 1 and hold the green lever down in order to remove paper wedged in this area more easily.
- Area 9 also has a green knob (located to the right of the lever), which can be turned to help you clear paper.
- If paper rips as you are removing it from area 9, or if you have difficulty removing paper from this area, you may have to use the pinch lever located further inside area 9. Paper may be caught in this area when doing duplex printing.

To use the pinch lever located inside area 9:

- Step 1.** Locate the green pinch lever directly behind area 9 (above the green knob and further inside area 9).
- Step 2.** Carefully reaching your hand into the area, squeeze the edges of the pinch lever and lift it up.



**Caution:** This area of the printer may be hot. Be careful when inserting your hand.

- Step 3.** Remove any paper caught in this area.
- Step 4.** Replace the green pinch lever to its original position. Make sure that you relatch the lever once you have cleared any paper in this area.

**Step 5.** Discard any paper you removed.

Figure 12-17. Area 10

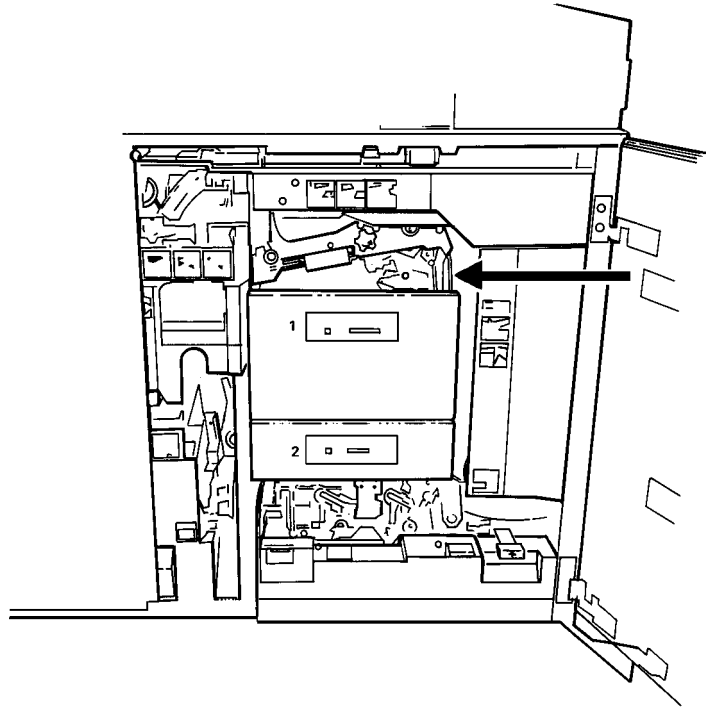

Figure 12-18. Area 11 (all feeder/stackers)

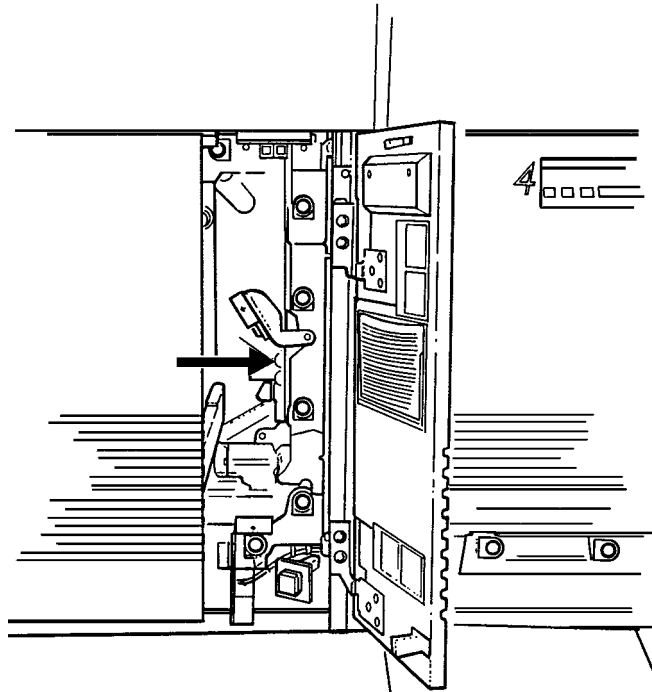

Figure 12-19. Area 12 (all feeder/stackers)

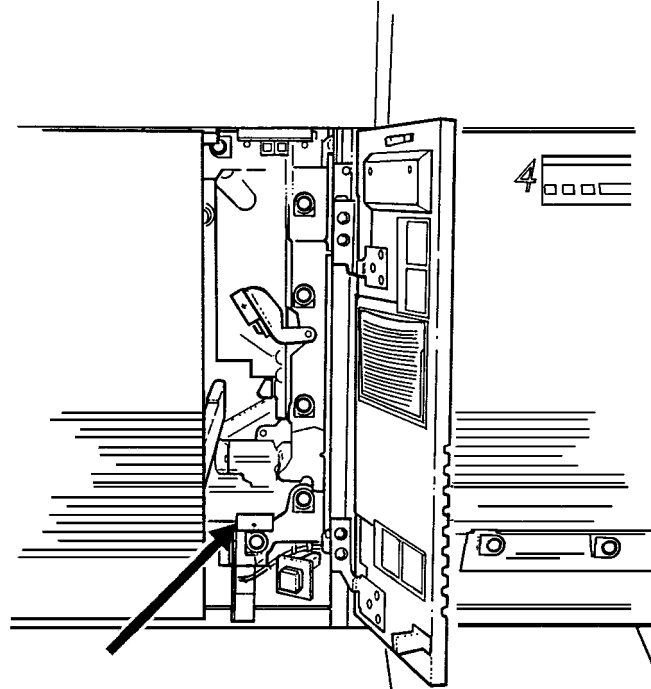

Figure 12-20. Area 13

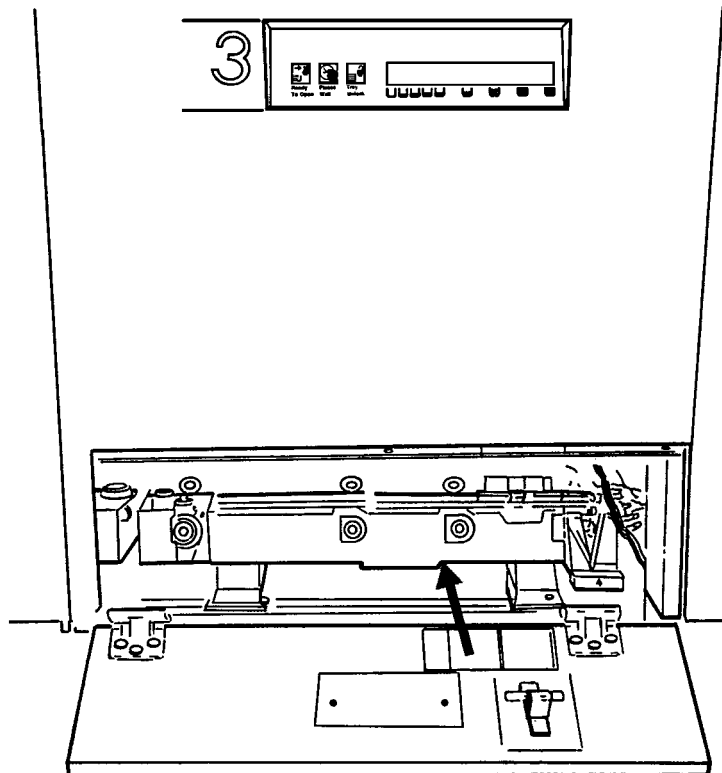
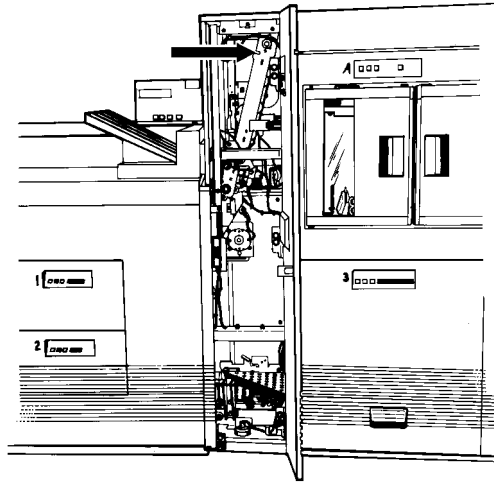

Figure 12-21. Area 14



**Note:** You may sometimes find paper lying on top of area 14, even though there is no message indicating a jam in this area. Discard the paper.

Figure 12-22. Area 15

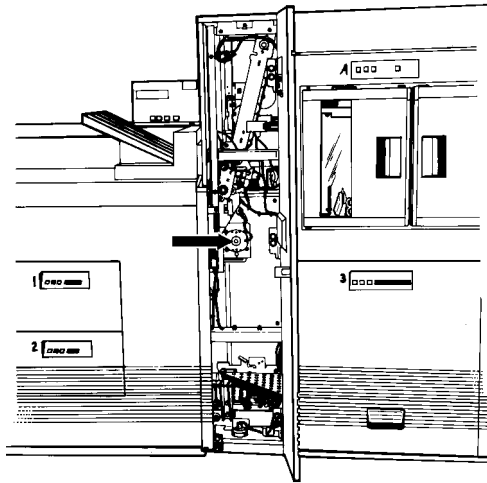



Figure 12-23. Area 16

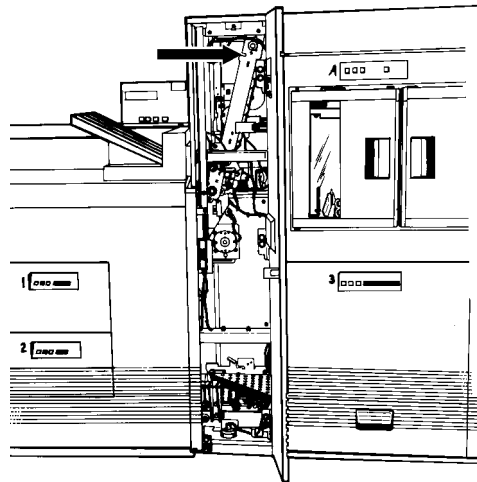
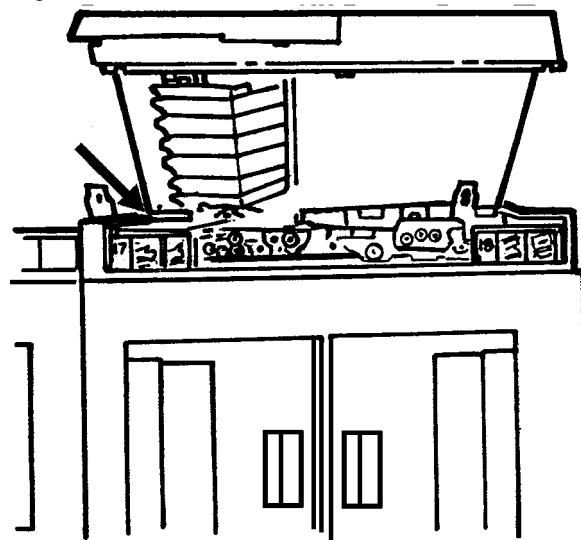
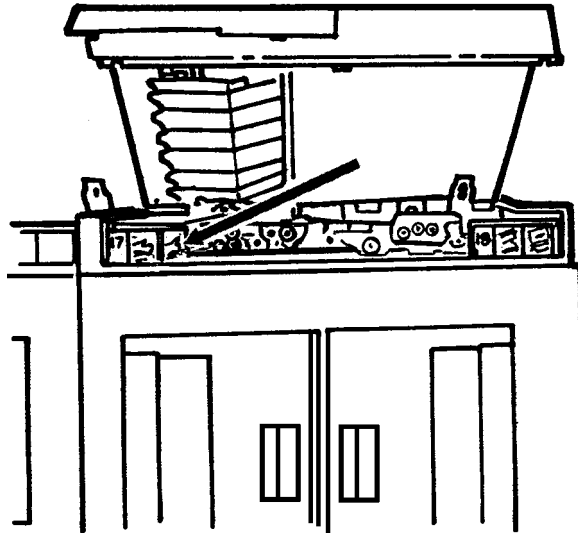

Figure 12-24. Area 17



**Note:** If your LPS has frequent jams in this area, you may need to clean the Q1106 sensor. Refer to the "Cleaning the sensors and the reflecting surfaces" section of the "Maintenance tasks" chapter.

Figure 12-25. Area 18



Note the following:

- Sometimes the printer control console messages direct you to discard the last sheet delivered to the stack following a jam in area 18. Check for this message when clearing an area 18 paper jam.
- If your LPS has frequent jams in this area, you may need to clean the Q1107A sensor. Refer to the “Cleaning the sensors and the reflecting surfaces” section of the “Maintenance tasks” chapter.
- If your LPS is fitted with a Bypass Transport Module, you should check for paper jams in areas 19 and 20 after clearing an area 18 paper jam. To do so:

To clear a paper jam of an LPS with a Bypass Transport Module:

- Step 1.** Open the Bypass Transport Module door.

- Step 2.** Press the Area 19 green lever in the direction of the arrow printed on it (see figure 12-26).

Figure 12-26. Area 19

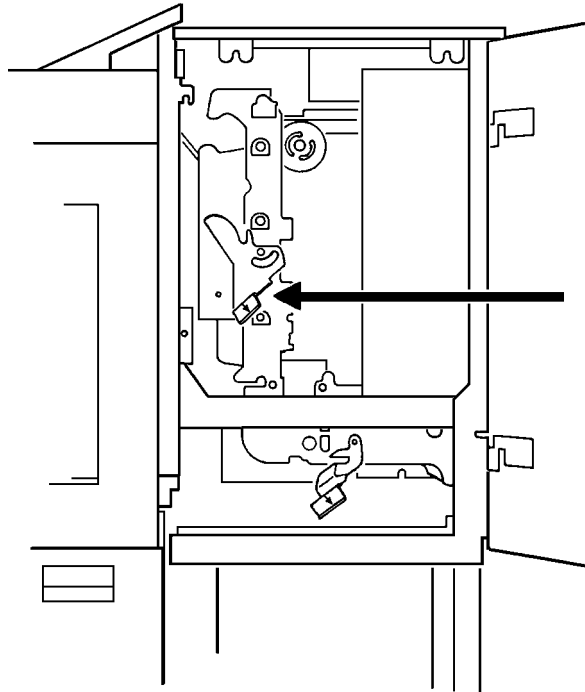

- Step 3.** Remove any paper in the exposed area.
- Step 4.** Press the green lever to the left until the latch catches.
- Step 5.** Press the Area 20 green lever in the direction of the arrow printed on it (see figure 12-27).

Figure 12-27. **Area 20**

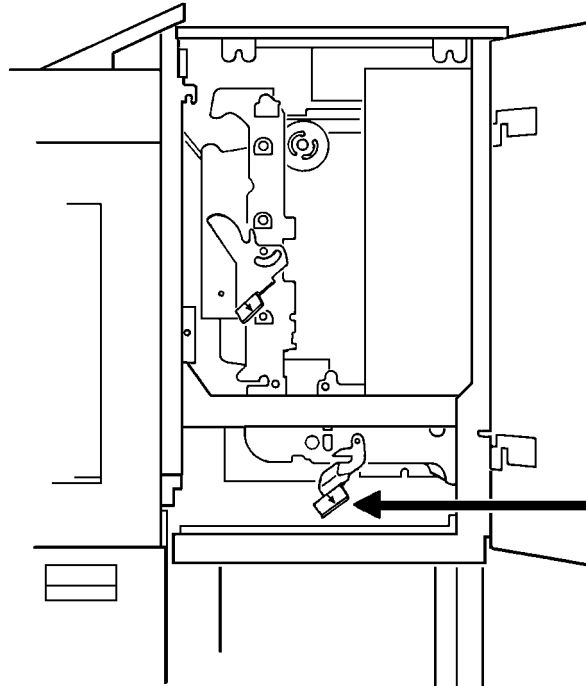

- Step 6.** Remove any paper in the exposed area.
- Step 7.** Press the green lever down and to the left until the latch catches.
- Step 8.** Close the Bypass Transport Module door.

### Clearing a misfeed (feeder tray fault)

To clear a misfeed:

- Step 1.** Go to the feeder tray indicated by the message and display on the printer control console.
- Step 2.** If the Ready to Open indicator is not lit, press the Tray Unlock button located on the feeder tray control panel (see figure 12-28).

Figure 12-28. **Tray Unlock button**

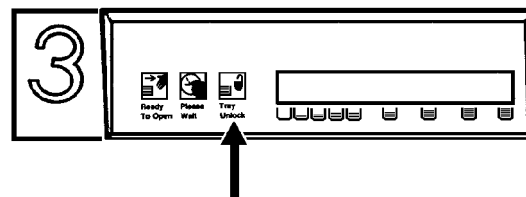

- Step 3.** When the Ready to Open indicator lights, open the feeder tray. Pull the tray all the way out for best results.
- Step 4.** For the processor feeder trays, press the green lever to unlatch the paper feeder assembly (see figure 12-29).

Figure 12-29. Unlatching the paper feeder assembly

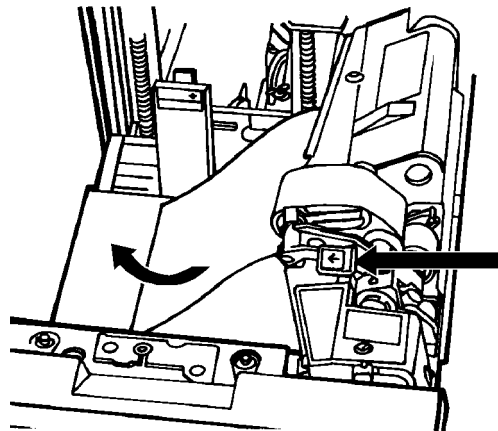

- Step 5.** Remove and discard any partially fed paper. Ensure that:
- The paper supply is neatly stacked
  - The stack is not higher than the MAX line on the length guide
  - The length guide is firmly touching the back edge of the stack.
  - For the high-capacity feeder trays, also ensure the side guide is firmly touching the side of the stack.



**Note:** You do not need to discard transparencies and other stiff materials unless they are damaged.

- Step 6.** For the processor feeder trays, relatch the paper feeder assembly by pressing the green dot until the assembly clicks into place (see figure 12-30).

Figure 12-30. Relatching the paper feeder assembly

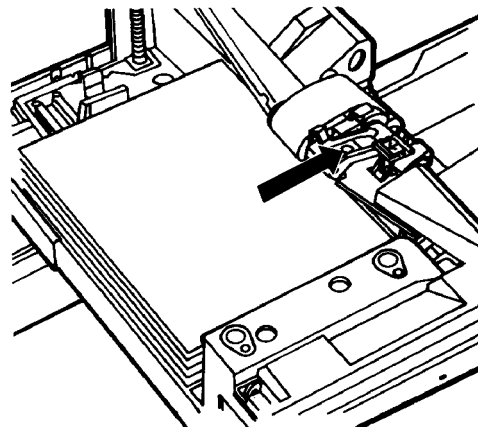

- Step 7.** Slide the tray back into the printer until the tray latches and press the Continue button to resume printing.
- Step 8.** Discard any pages sent to the sample tray, purge tray, or unused stacker bin when the misfeed was detected.

## Frequent misfeeds (processor feeder trays)

If the printer misfeeds frequently, the problem may be caused by a glazed feed belt, especially if you notice that one tray feeds the same paper better than another one does. (Glazing is caused by a buildup of the chemicals found on most papers.)

If you suspect this is the problem, cleaning the feed belt may eliminate the need to place a service call. Refer to the following procedure.

**Cleaning the feed belt** To clean the feed belt:

- Step 1.** Clear any misfeeds that have occurred, but do not relatch the paper feeder assembly. The paper feeder assembly must be unlatched to clean the belt; if necessary, unlatch it by pressing down on the bright green lever on the right side of the paper tray (see figure 12-31).

Figure 12-31. Unlatching the paper feeder assembly

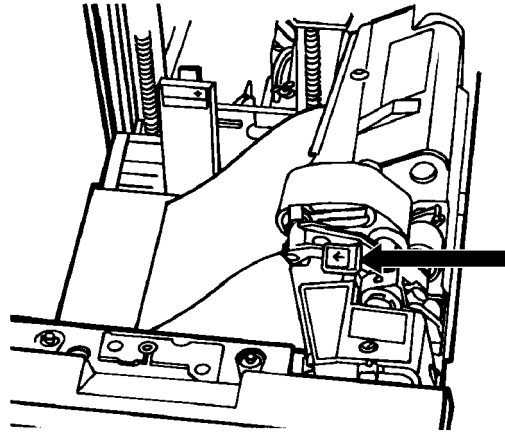

- Step 2.** Lightly moisten a lint-free towel with Xerox recommended film remover and wipe the outside surface of the feed belt thoroughly in the same direction as the ribs on the belt (see figure 12-32). Wiping from side to side might pull the belt off its track. Allow a few seconds for the film remover to evaporate.

Figure 12-32. Cleaning the feed belt

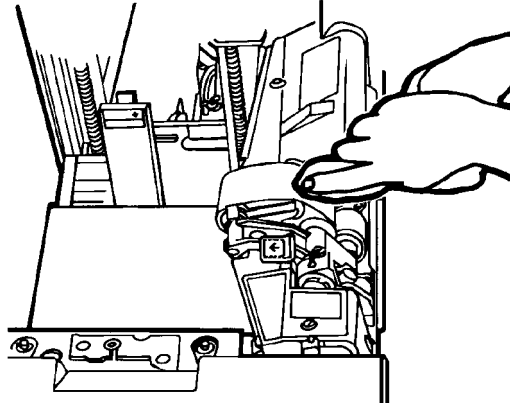

- Step 3.** Relatch the paper feeder assembly by pressing down on the bright green dot (see figure 12-33). Slide the paper tray completely back into the printer.

Figure 12-33. Relatching the paper feeder assembly

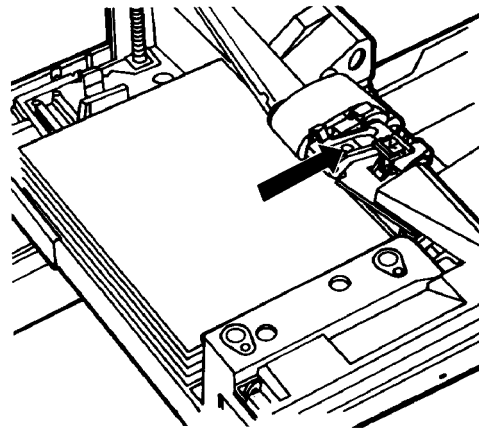

- Step 4.** Operate the system as usual. If you are still experiencing misfeeds, place a service call.



**Note:** *This procedure should be used only to correct a problem, not as a routine maintenance procedure.* Because the belts are made of rubber, frequent cleaning with film remover will dry them out and cause them to fail prematurely. Film remover may be obtained from your Xerox service representative.

## Faults are cleared but the Attention light is still on

---

If you have cleared all faults that are listed on the printer control console, but the Attention light is still on and the message “Output is stopped. See message at the System Display” appears on the printer control console, there may be an uncleared output fault. Check the PC UI Command Line/Message window or an opened window for an output message (preceded by an asterisk and OS followed by a number). Follow the instructions in the output message and press the Continue button.

## Printing does not continue when the Continue button is pressed

---

If the Continue button is pressed before all printer faults are cleared, the outstanding faults are changed to the status of masked faults (refer to the “Fault masking and the printer control console” section earlier in this chapter). If the printer status displayed in the message area of the printer control console is READY, but printing does not continue when you press the Continue button, touch the Fault List icon on the printer control console to display the Fault List screen. (Refer to figure 12-1.) Clear any faults displayed on this screen and press the Continue button again.

## Incorrect paper size message

---

If printing stops and a message appears on the printer control console telling you that an incorrect paper size is loaded in a feeder tray, check the paper in the indicated tray. If the paper is not the correct size for the job, either load the correct size paper or select another feeder tray containing the correct size paper. If the paper size is correct, press the Continue button to resume printing. The message may have been caused by a damaged sheet.



**Note:** In order to assure good print quality for your jobs, the LPS automatically purges any dog-eared or skewed sheets of paper. When the LPS encounters paper in this condition, it may stop printing and issue an incorrect paper size message.



---

## Stacker bin problems

---

This section explains what to do when papers are being thrown around the stacker, and when paper stack is falling over or sliding around the bin.

### Papers are being thrown around the stacker

---

This problem may occur when you have unloaded paper by opening the top cover of the stacker bin.



**Note:** Never unload paper this way.

To remedy this situation, unload the bin following the normal procedure. (Refer to the “Unloading a stacker bin” section of the “Paper facts” chapter.)

### Paper stack is falling over or sliding around the bin

---

This problem may be due to excessive paper curl. Try the following remedies:

- Reduce the paper curl by following the instructions in the “Paper curl and paper jams” section of this chapter.
- Reduce the number of sheets going to the bin through the Bin Limits task. (Refer to the “Status and print tasks” chapter for instructions.)

## System controller problems

This section explains what to do when one of the following problems occur:

- LPS does not boot
- Printer does not respond to the system controller
- Blank display on the system controller terminal
- Rasterization messages appear in the Messages window of the PC UI or on the system controller display

### LPS does not boot (system controller terminal)

If you have followed the procedure for powering on and booting the LPS, but the system does not boot properly:

- Step 1.** Press the <CAPSLOCK> key on the system controller keyboard.
- Step 2.** Press the Boot button on the operator control panel (see figure 12-34).

Figure 12-34. **Boot button on the operator control panel**

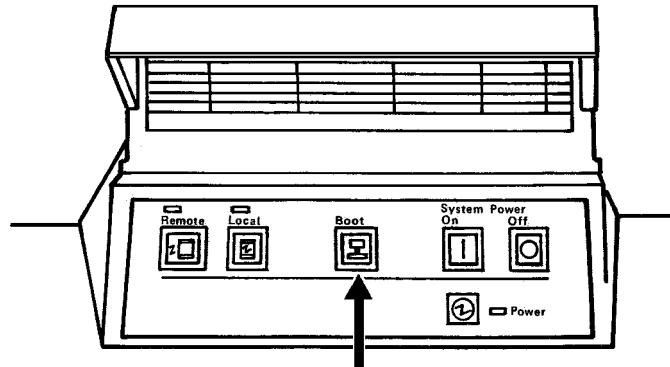

- Step 3.** Reenter the BOOT command.
- If the system still does not boot, call for service.

### Printer does not respond to system controller

If the printer control console displays PRESS CONTINUE TO RESUME PRINTING, but the printer does not respond when you press the Continue button, or if the printer does not respond to directions from the PC UI or the system controller keyboard (non-U.S. markets only), they may have lost communication with each other. Use the following procedure to restore the communication between the system controller and printer.

- Step 1.** Press the Continue button on the printer control console, if directed to do so.



**Note:** If the printer responds and resumes printing, do not follow the rest of this procedure.

- Step 2.** If the printer does not respond and resume printing, either:
- Enter the RESET command.
  - Select the Reset task from the Job Control menu of the PC UI.
- (Refer to the “Reset” section of chapter 5, “Job control tasks.”)

- Step 3.** Enter the PSC (printer subsystem controller) command. This should put the printer back in communication with the system controller.



**Note:** Ask your Xerox service representative to change this command to a Logon Level 2 if not already done. Otherwise, you will not be able to access it.

- Step 4.** Retry the command to which the printer would not respond earlier. If it still does not respond, tell your supervisor or a systems analyst.

### Blank display (system controller terminal)

---

To prolong the life of the system controller display, the light is turned off and the display becomes blank when it has not been used for 15 minutes. As soon as any key is pressed, the image returns exactly as it was prior to turning itself off. There is no loss of information.

If there is no display when you press a key, check that the ON/OFF switch on the right side of the display (just below the screen) is in the ON position. Also check the brightness control (intensity adjustment lever); slide it to the right to make the screen brighter. If the display is turned on, the lever is all the way to the right, and the display screen is still blank, place a service call

### Rasterization messages

---

When a line of print is too complex for the system to process normally, the output processor directs the image generator to produce a bitmap image instead of aborting the page. This process can take anywhere from 3 to 20 minutes. The following messages appear in the Messages window of the PC UI or on the system controller display:

OS1620 Local density problem has caused a printer cycle down  
OS1625 Local density problem rasterization in progress.



**Note:** Do not press any keys until the process is complete. Any commands normally allowed during print mode (for example, FEED, JOBS, PSTATUS, SELECT, and so on) entered while rasterization is in progress are delayed until the rasterization process is finished. When the process is complete, the following message appears:

OS1627 Local density problem rasterization is complete  
The printer now cycles up and prints the problem page.

## Power failure

---

If there is a power failure and your LPS is online to a host computer, the PC UI or system controller display (non-U.S. markets, only) should prompt you to enter "C". (It is possible that the message will not appear. Enter "C" anyway at the system controller keyboard or in the Messages window of the PC UI.) If there is no response from the system after you enter "C", press the System Power Off and System Power On buttons on the operator control panel to reboot the system.

In the event of a power failure, you must initiate recovery of the data files to recover the data content. The system asks if you want it to attempt recovery. If you do, key in <Y> (yes), or select the Yes button.

It is possible that not all data can be recovered; the amount of recovery that can be accomplished depends on when the last system checkpoint was taken because of the method used by the system to restore its dynamic (active) memory.

If working online to a host computer, check the output in the stacker bins to find the last completed page. Request that the host operator retransmit the job beginning at that point. The operator may have to back up the spooler a number of pages.

---

## Status file nearly full message

---

As jobs are printed, report information is automatically accumulated and saved in the status file on a report basis each time a report is both input and printed.

When the following message appears:

**STATUS FILE NEARLY FULL**

The accounting/status file has only enough space for 25 more reports. When that number is exceeded, the system continues to add new reports by deleting those at the beginning of the status file, thereby losing important information.

When this message appears, notify your supervisor immediately. Appropriate action can then be taken to save the report information and reinitialize the status file.

---

## Open-reel tape drive problems

---

The following sections deal with open-reel tape drive problems.

### Tape drive does not perform self-load routine

---

Ensure the tape path cover and the loading door are fully closed (see figure 12-35).

Figure 12-35. Tape path cover and loading door

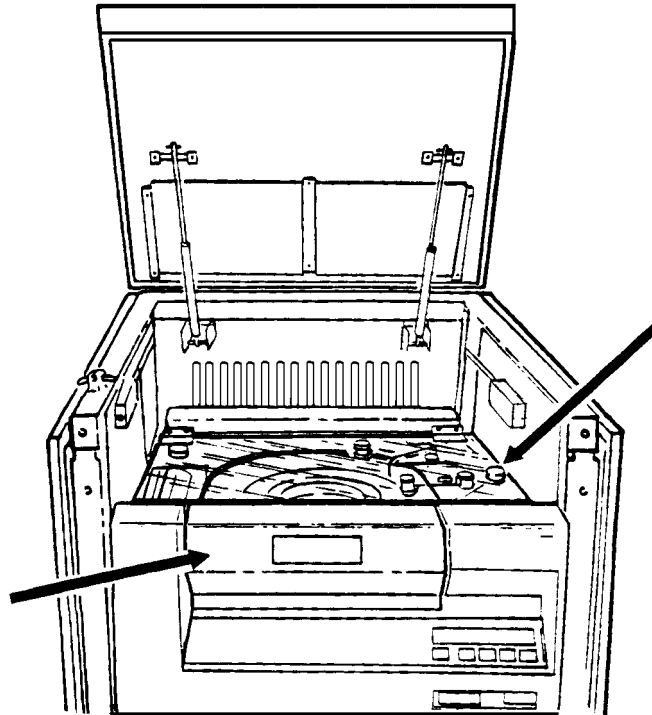

---

**“OK” appears on the tape drive message display, but the loading door is closed**

---

Press the Reset button to open the door (see figure 12-36).

Figure 12-36. Reset button

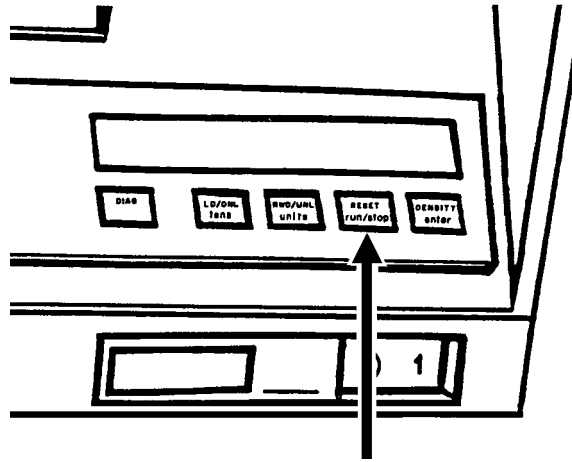

If the door still does not open, tap on it lightly to open it.

---

**“LID OPEN” appears on the tape drive message display**

---

Ensure the tape path cover turnbuckles are all secured (see figure 12-37).

Figure 12-37. Tape path cover turnbuckles

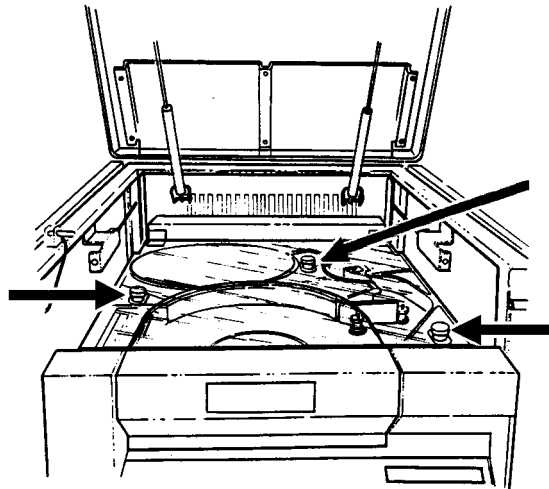

## 1/2 inch cartridge tape drive problems

The following sections deal with 1/2 inch cartridge tape drive problems.

### Basic recovery procedure

Always try to recover the cartridge from the 1/2 inch cartridge tape drive before you try to correct any problems with the drive. Follow these basic recovery steps:

- Step 1.** Vary the tape drive offline. (Refer to the "Power off the 1/2 inch cartridge tape drive" section of chapter 7, "Offline printing tasks.")
- Step 2.** If there is a relevant message on the printer control console, PC UI, or system controller display, perform the action described there.
- Step 3.** If there is an error code on the tape drive message display, record the error code and time and call for service.

### Initial program load (IPL) procedure fails

An error occurred during the IPL procedure if:

1. The tree indicator lights (Read only, Ready, and Mode) flash on the 18/36 track drive
2. An error code displays after you power on the tape drive.

Re-IPL the tape drive using one of the following procedures:

- Turn off the tape drive by pressing the Power switch to OFF.
- Wait 10 seconds and then turn the tape drive back on by pressing the Power switch to ON.

Figure 12-38. Power switch

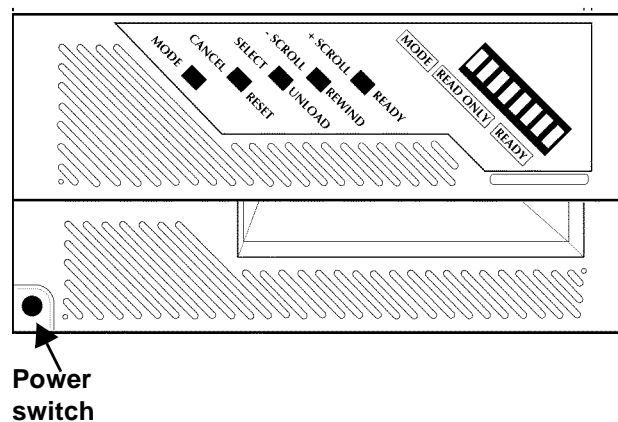

- For the 18 track drive, press and hold the Select, Scroll, and Ready buttons for at least five seconds.

Figure 12-39. Ready and Unload buttons

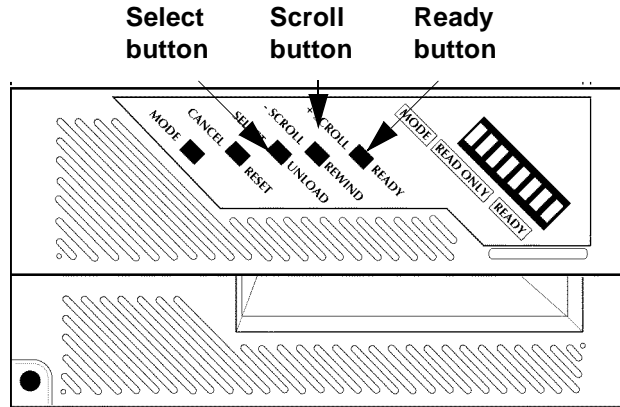

If the IPL procedure still fails, note the error code and time and call for service.

---

### You cannot insert a cartridge

Inspect the cartridge for damage. (Refer to the "Load a cartridge tape" section of the "Offline printing tasks" chapter.)

If the cartridge is damaged, use an undamaged cartridge instead.

If the cartridge is undamaged but you cannot load it, call for service.



## Tape does not unload

To solve this problem:

- Step 1.** If there is an error code message on the message display, record the error code.
- Step 2.** Press the Unload button (see figure 12-40).

Figure 12-40. Unload buttons

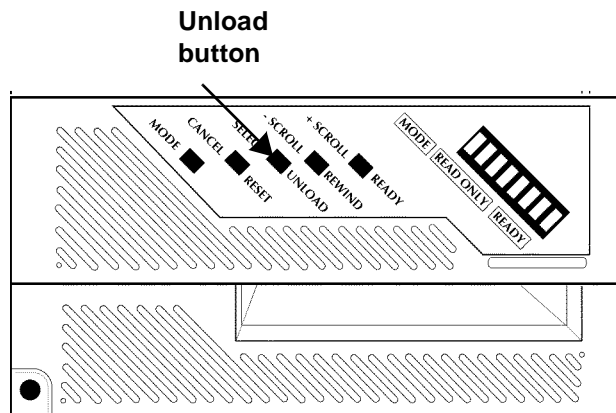

- Step 3.** Try unloading the tape again.
- Step 4.** If the tape still does not unload, record the error code on the message display, record the time, and call for service.

## Unloading a cartridge after a power failure

To unload a cartridge after a power failure:

- Step 1.** Turn the tape drive on. (Refer to the "Emergency procedures" section of the "Offline printing tasks" chapter.)
- Step 2.** Press the Unload button.

## Tape winds completely out of cartridge

Call for service. If there is an error code message on the message display, record the code and report it to the service representative.

## Message display is blank

To solve this problem:

- Step 1.** Ensure the tape drive is receiving power from the main AC source.
- Step 2.** Ensure that the AC Power switch on the rear of the tape drive is on (see figure 12-41).

Figure 12-41. 18/36 Track AC power switch

AC Power switch

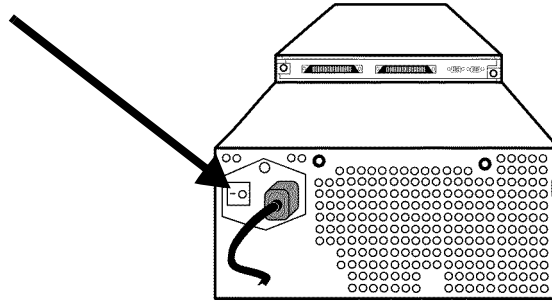

- Step 3.** Turn the DC Power switch OFF(0) and then ON (1). Figure 12-42 shows the switch.

Figure 12-42. DC power switch

DC Power switch

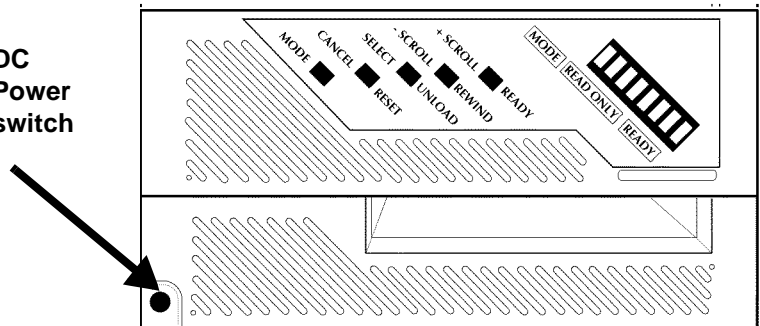

- Step 4.** If the display is still blank, call for service.

## Tape drive does not become ready

To solve this problem:

- Step 1.** Determine if the tape drive is online by pressing the Scroll button until the message display shows the Status display.
- Step 2.** If the tape drive is offline, follow the procedures listed in the "Place the tape drive online" section of the "Offline printing tasks" chapter.
- Step 3.** If the drive still does not become ready, the cartridge may be inserted incorrectly. Remove the cartridge from the transport and insert it again.
- Step 4.** If there is an error code message in the message display, record the error code, press the Unload switch (see figure 12-43), and try the operation again.

Figure 12-43. Unload switch

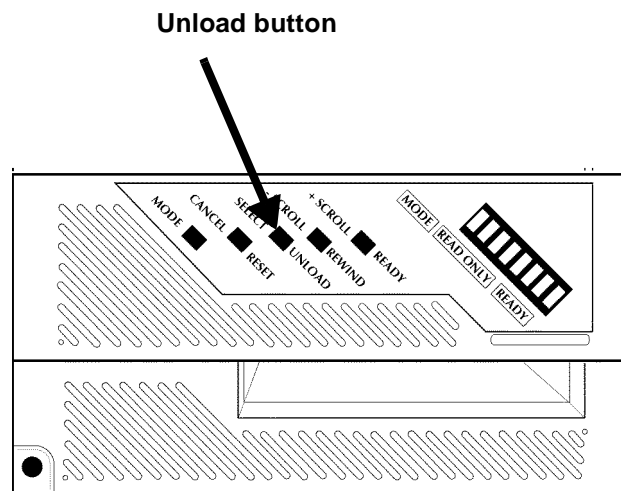

- Step 5.** If the drive still does not become ready, call for service. If there is an error code message on the message display, record the code and report it to the service representative.

---

## Calling for service

---

Before calling the Customer Service Support Center, ensure you have read this chapter and have tried the corrective actions described here. If the problem persists, gather the necessary information (details follow) and call the appropriate Customer Service Support Center phone number. Your site representative can supply you with the telephone number for the Customer Service Support Center in your area.



**Note:** The correct phone number is attached to your printer at installation time.

Before contacting Xerox service, please make note of:

- Status code numbers and messages which appear on the PC UI, including the 6-digit San Code that resulted from running the PROBLEM command
- Status messages which appear on the printer control console
- Indicator lights which may or may not be lit
- Status codes which appear in the message display of the tape drive control panel if there is a tape drive problem.

Your call will be answered by a Xerox representative who will ask you for your equipment model (Xerox DocuPrint 180).

You will also be asked for:

- Your printing system's serial number, located on a panel inside the printer, behind the left-hand, small door (see figure 12-44).

Figure 12-44. Locating the LPS serial number

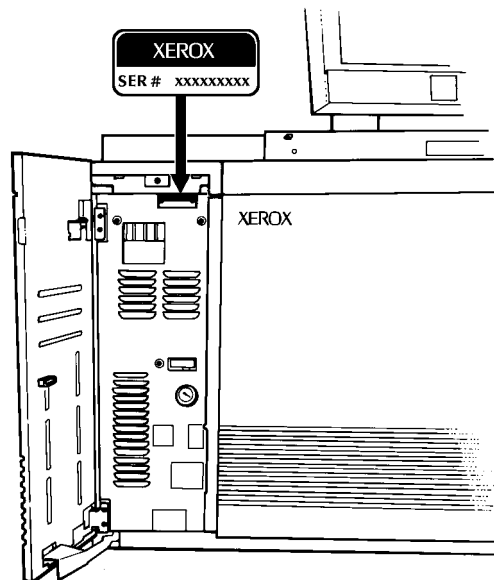

- Your name
- Your company's name
- The system condition or status.



**Note:** The LPS's serial number and fault codes can also be seen on the Call For Service window of the PC UI (refer to the "Call for service" section of the "System control tasks" chapter) and the Tools display of the printer control console.

This information is given to a customer service representative who will call you back to discuss the information and give you an estimated time of arrival or assist you over the phone to resolve the problem.



---

## A. Meter reading and reporting

As jobs are printed by the LPS, usage information is accumulated and saved. Instead of using physical meters, software in the printer maintains the page count in its memory. Each month, that information needs to be reviewed and transmitted to Xerox for billing purposes. This appendix describes the procedures necessary to extract the information and report it to Xerox.

---

### Meter reading and billing report

---

There are two meters maintained by the laser printing system for customer billing as follows:

- Meter A counts all good impressions delivered to their intended output tray. This meter cannot be reset.
- Meter J counts only sheets printed in the printer diagnostic mode and delivered to their intended output tray. Like meter A, it cannot be reset.

Sometime during the last five working days of the month, *when the system is idle*, you must extract the billing information and report it to Xerox. To obtain a billing report, enter the REPORT BILLING command at the system controller keyboard or use the Billing window of the PC UI.

### Billing report through command line

---

To display billing report information, enter the following command:

**REPORT BILLING,DISPLAY**

To print the billing report, enter the following command:

**REPORT BILLING,PRINT**

To display and print the billing report, enter the following command:

**REPORT BILLING,DISPLAY,PRINT**

## Billing report through windows of the PC UI

---

To access billing report information:

- Step 1.** Open the Accounting icon.  
The Accounting menu window appears (see figure A-1).

Figure A-1. Accounting menu window



- Step 2.** Select the "Billing" option to open the Billing window (see figure A-2).



Figure A-2. Billing window

| Billing                        |                                | Close                         | Print             |
|--------------------------------|--------------------------------|-------------------------------|-------------------|
| <b>CUSTOMER BILLING REPORT</b> |                                |                               |                   |
| Date                           | 01/19/98                       |                               |                   |
| Time                           | 12:02                          |                               |                   |
| Serial no                      | 015012                         |                               |                   |
| System ID:                     | V3C2 R1.2 1/13/98 SARAH        |                               |                   |
|                                | **** System Configuration **** |                               |                   |
|                                | Machine Type - DP180 LPS       |                               |                   |
| CPU Memory =                   | 1024 K                         | SCSI Disk Units:              | 0,1,2,Floppy      |
| AIS: Version                   | 2                              | Page Buffer Memory Size:      | 128 Ban           |
| Bitmap Memory:                 | 256 Megabits                   | Page Buffer A,B:              | 2 Buffers         |
| Ink Memory:                    | 2 Megabits                     | Memory Test at Boot           | = yes             |
| Text and Metrics Memory:       | 3 Megabytes                    | Auto Boot Enabled             | = no              |
| Online: Address                | CA                             | Boot Message Display          | = yes             |
| - Mode Burst , Device          | 3211                           | Printer Characteristics       |                   |
| Terminal Type:                 | PC                             | - Speed:                      | 180 ppm           |
| SCSI Tape Devices:             |                                | - Resolution:                 | 300 spi           |
| - Reel to Reel:                | HP-SCSI A/Ch 0/Tg 0            | - Default Order:              | 1 to N            |
| - Streamer Tape:               | HP-SCSI A/Ch 0/Tg 1            | - Paper size:                 | 8.50 x 11.00 Inc  |
|                                |                                | Language:                     | U.S. English      |
|                                |                                | Graphics Type:                | AIS               |
|                                |                                | SCSI Tape Device Assignments: |                   |
|                                |                                | - TD0 =                       | Reel to Reel Tape |
|                                |                                | - TD1 =                       | Streamer Tape     |

The Billing window displays billing report information.

- Step 3.** Select either header button:
- **Print.** Print the Billing report.
  - **Close.** Close the window.

---

## Reporting meter reads

---

Before you call the Xerox Electronic Meter Collection Center, ensure you have the following information:

- Meter read information (the A meter)
- Your printing system's serial number, located on a panel inside the printer, behind the center door (see figure A-3).

Figure A-3. **Locating your LPS serial number**

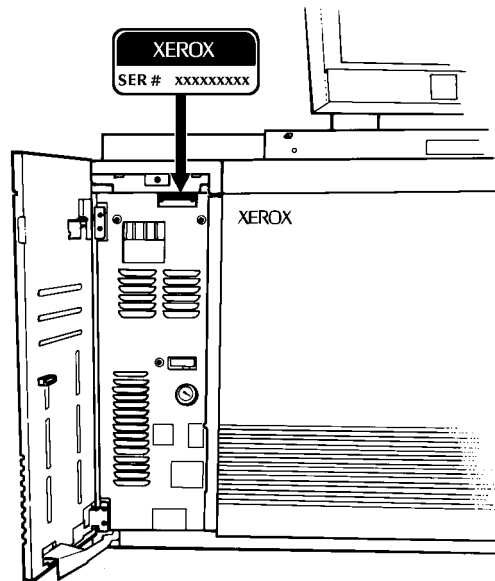

If you are reporting other Xerox printers during the same call, ensure you have the serial number and meter read information available for each one before calling the Electronic Meter Read Collection System.

*Read through all of the following instructions carefully before you attempt to make your first meter reading report. If you need assistance with this process, place a toll-free call to the Help Line 1-800-433-7769 between 8:30 a.m. to 5:15 p.m., Eastern time. An answering device operates during nonbusiness hours; please leave your name and phone number, and your call will be returned.*

---

## Touchtone Telephone Direct Meter Read Entry System

---

The Touchtone Telephone Direct Meter Read Entry System is designed to guide you through an error-free meter read entry session. After reviewing this procedure and making several entries, you will need these instructions only for special situations. You should have no problems in entering your meter reads; if you do, the system is designed to enable you to make any necessary corrections.

This section includes:

- Step-by-step instructions for entering your meter readings and reviewing and changing data.

- A Month End Meter Read Reporting Worksheet (see figure A-4) to help you record your meter readings. The worksheet can be used as a master for making additional copies.

Figure A-4. **Month End Meter Read Reporting Worksheet**

| <b>Month End Meter Read Reporting Worksheet</b>                                                                                                                                |                      |
|--------------------------------------------------------------------------------------------------------------------------------------------------------------------------------|----------------------|
| <b>Call:</b><br>423-6168 (in Rochester, NY)<br>1-800-638-7979 (All other U.S. locations)                                                                                       |                      |
| <b>Enter:</b><br><br>Converted Serial Numbers                                                                                                                                  | Ending Meter Read(s) |
| _____#                                                                                                                                                                         | _____#               |
| _____#                                                                                                                                                                         | _____#               |
| _____#                                                                                                                                                                         | _____#               |
| _____#                                                                                                                                                                         | _____#               |
| _____#                                                                                                                                                                         | _____#               |
| _____#                                                                                                                                                                         | _____#               |
| _____#                                                                                                                                                                         | _____#               |
| _____#                                                                                                                                                                         | _____#               |
| _____#                                                                                                                                                                         | _____#               |
| <p><b>Enter:</b> # to acknowledge completion of serial number/meter read entry for each machine.</p> <p><b>Enter:</b> **91# to end call and record entry in computer base.</p> |                      |
| <p>For your information only:</p> <p>Date of Entry: _____</p> <p><b>For Assistance Call 1-800-433-7769.</b></p>                                                                |                      |

## Understanding the system

---

The following points are very important to understand before beginning to use the touchtone system:

- Always wait for the system voice to finish a prompt before entering data.
- Always complete each entry with the # (pound sign). This tells the system you have finished entering the data item it requested. When you press the pound sign, the system repeats the information you just entered and prompts you for the next piece of information for the report.
- Any time you want the system to repeat the voice prompt or message it just completed, enter \*\*3#.
- When you want the system to cancel an entry it just read back to you, enter \*\*4#. After acknowledging the cancellation, the system asks you to reenter the needed information.
- Enter \*\*94# to cancel all data entered for a machine. It can be used any time before you enter the pound sign that completes the data entry for that machine. (Refer to step 5 in the following section.)
- Each letter in the serial number must be translated into numbers because letters are not individual keys on the touchtone keypad.
  - To tell the system you are about to enter a letter, press the asterisk (\*).
  - Next, press the number key on the touchtone pad that has the letter on it—press 7 for S, for example.
  - Finally, press 1, 2, or 3 for the letter's position on the key. S is in the third position on the 7 key, for example, so you press 3. (The entire "code" for S is \*73.)

**Example:** To enter the serial number 6D5789123, press the following keys: 6 \*31 5 7 8 9 1 2 3 #



**Note:** It is possible for a serial number to contain letters in any or all of the first three positions. If there are no letters, simply enter the nine numbers and the #. For assistance in converting your serial numbers, refer to table A-1.

Table A-1. Letter-to-number conversion chart

| Letter | Conversion | Letter | Conversion       |
|--------|------------|--------|------------------|
| A      | 21         | N      | *62              |
| B      | *22        | O      | *63              |
| C      | *23        | P      | *71              |
| D      | *31        | Q      | *11 <sup>1</sup> |
| E      | *32        | R      | *72              |
| F      | *33        | S      | *73              |
| G      | *41        | T      | *81              |
| H      | *42        | U      | *82              |
| I      | *43        | V      | *83              |
| J      | *51        | W      | *91              |
| K      | *52        | X      | *92              |
| L      | *53        | Y      | *93              |
| M      | *61        | Z      | *13 <sup>2</sup> |

1. Indicates letters not on the touchtone keypad that were assigned by this system to the 1 key.
2. Indicates letters not on the touchtone keypad that were assigned by this system to the 1 key.

**Entering meter read information**

---

To enter meter read information:

- Step 1.** Call the Xerox Electronic Meter Data Collection System's toll-free number. It operates 24 hours a day, every day, including weekends and holidays. Meter readings should be reported between the 20th and the last working day of each month.

**423-6168** (in Rochester, NY)

**1-800-638-7979** (all other U.S. locations)

When the system answers your call, you hear:

"Thank you for calling the Xerox Electronic Meter Collection System. For assistance, please call 800-433-7769."

When it is necessary to provide special information of interest to our customers, a special announcement message follows this greeting. Following these initial messages, the system is ready to receive your meter readings.

- Step 2.** The system prompts you to begin by asking for your machine serial number.

"Please enter the machine serial number."

Enter your machine serial number, followed by a pound sign (#), on the telephone keypad.

Once you enter your machine serial number, the system repeats it back to you. (To eliminate the possibility of a coding error for any letters in the serial number, the system uncodes your entry and says it with the letters. If the system says the wrong letter, cancel this entry by entering \*\*4#, recode the letter, and reenter your serial number.)

- Step 3.** When the serial number has been entered and accepted, the system asks for the date of the reading.

"Please enter the date of the reading or enter the pound sign for today's date."

For example, May 3, 1998 would be entered as 05 03 98 #.

If a date appears to be incorrect, you receive a special message and are asked to reenter the date.

If the system tells you your date is not within the acceptance range, it also gives you the correct range. If you do not enter a date within that range, the system refers you to the touchtone information number and terminates the call.

When a correct date is entered, the system reads back the date, for example:

"Date is five three ninety-eight."

- Step 4.** When the system finishes reading back the date, it then asks for the meter reading.

"Please enter meter A."

Enter the A meter reading, ending with the pound sign. Do not enter zeros in front of the numbers of the meter read.



**Note:** From the serial number, the system knows how many meters there are to report and asks for them by name.

If you want to review the data, enter \*\*1# to start the review. Refer to the following section “How to review and change data” for instructions.

**Step 5.** When the A meter has been entered, the system reads it back to you and says:

“All meter reads for this machine are complete. Enter pound sign to acknowledge.”

Enter the pound sign (#) if the meter read was correctly entered. If there was a mistake, enter \*\*4# to cancel the read and reenter the correct meter read. Once again the system repeats the meter read to you and asks you to enter the pound sign to confirm the entry. If it is correct, enter #; if it is not, repeat the cancellation/reentry process.

**Step 6.** Once you have successfully completed step 5, the system says:

“All readings accepted.”

The system's next message is to ask you for a machine serial number. At this point you have the following choices:

- If you have more machines to report, repeat the previous steps until all machines have been reported.
- If you have no more machines to report and you are sure of the accuracy of the information, enter \*\*91# to end the reporting session. The system responds by indicating how many machines were processed and accepted during this session.

“Readings for \_\_\_ machines accepted. Thank you for using the Xerox Electronic Meter Reading System.”



**Note:** If you would like to practice with an imaginary serial number before entering your actual serial number and meter read, you can use serial number X12377889 (which converts to \*9212377889). This serial number is only a demonstration serial number; it cannot generate a bill. You may practice all procedures described in the “Entering meter read information” section using this serial number.

### Reviewing and changing data

---

To review and change data:

- Step 1.** To begin the review, enter \*\*1#. The system reads the first serial number.
- Step 2.** To accept the serial number and continue, enter #. The system then reads back the A meter read.
- Step 3.** Continue the review by accepting with the # sign each time the entry is read back correctly.  
  
If an entry read back is incorrect, enter \*\*4# to cancel the entry, and reenter the correct information after the voice prompts you to do so. Be sure to wait until the voice is finished before making entries.
- Step 4.** To end the review at any time, enter \*\*2#. When the review is ended, the system asks you to enter the # sign to acknowledge the entries as complete. You may then choose to enter more machine information or terminate the session. (Refer to step 6 in the previous section.)



---

## B.

## Supplies

Effective management of your laser printing system requires that you maintain proper inventory levels of paper and other supplies at all times. No one wants to lose production time because supplies are not available when they are needed.

Planning ahead also makes sense from a financial standpoint. It allows you to take advantage of quantity discounts, which can mean very great savings to your company. Your sales representative or supply specialist can help you plan most effectively and economically. The purpose of this chapter is to give you a summary of the most-used paper and the necessary supplies, their order numbers, and how to order them from Xerox.

---

### How to order supplies (in U.S.A.)

---

Call this toll-free number: 1-800-822-2200, Monday through Friday, between 8:00 a.m. and 5:00 p.m., Pacific time.

Give the supply order representative the following information:

- Your Xerox customer number (which is supplied by your Xerox representative. Your customer number is also included on your Xerox invoice.)
- Your equipment model number: DocuPrint180
- Item description (Refer to table B-1, "Consumable supplies.")
- Quantities required for each item
- A purchase order number, if that is the method of payment used by your company.

## Consumable supplies table

Table B-1 lists the supplies that are available from Xerox for your laser printing system. Use this table to help you determine your supply needs.

Table B-1. **Consumable supplies**

| Item          | Description                                                                                                                                                           | Part number |
|---------------|-----------------------------------------------------------------------------------------------------------------------------------------------------------------------|-------------|
| <b>Paper</b>  | Xerox paper quantities are 10 reams (5000 sheets) to a carton unless otherwise noted. The 3-hole papers marked with an asterisk (*) are drilled with 5/16-inch holes. |             |
| 8.5 x 11 inch | 4024 Dual Purpose Paper                                                                                                                                               | 3R721       |
| A4            | 4024 Dual Purpose Paper                                                                                                                                               | 3R2594      |
| 8.5 x 14 inch | 4024 Dual Purpose Paper                                                                                                                                               | 3R727       |
| 8.5 x 11 inch | 4024 Dual Purpose Paper, 3-hole                                                                                                                                       | 3R723       |
| 8.5 x 11 inch | 4024 Dual Purpose Paper, 3-hole*                                                                                                                                      | 3R2193      |
| 8.5 x 11 inch | 4024 Dual Purpose Paper, 4-hole                                                                                                                                       | 3R1983      |
| 8.5 x 11 inch | 4024 Dual Purpose Paper, 4-hole*                                                                                                                                      | 3R3008      |
| 8.5 x 11 inch | 4024 Dual Purpose Paper, 7-hole                                                                                                                                       | 3R1984      |
| 8.5 x 11 inch | 4024 Dual Purpose Paper, 7-hole*                                                                                                                                      | 3R3010      |
| 8.5 x 11 inch | 4024 Smooth                                                                                                                                                           | 3R2675      |
| 8.5 x 14 inch | 4024 Smooth                                                                                                                                                           | 3R2677      |
| 8.5 x 11 inch | Dual Purpose Colors—Blue                                                                                                                                              | 3R3052      |
| 8.5 x 11 inch | Dual Purpose Colors—Blue, 3-hole                                                                                                                                      | 3R3068      |
| 8.5 x 14 inch | Dual Purpose Colors—Blue                                                                                                                                              | 3R3084      |
| 8.5 x 11 inch | Dual Purpose Colors—Green                                                                                                                                             | 3R3056      |
| 8.5 x 11 inch | Dual Purpose Colors—Green, 3-hole                                                                                                                                     | 3R3072      |
| 8.5 x 14 inch | Dual Purpose Colors—Green                                                                                                                                             | 3R3088      |
| 8.5 x 11 inch | Dual Purpose Colors—Pink                                                                                                                                              | 3R3058      |
| 8.5 x 11 inch | Dual Purpose Colors—Pink, 3-hole                                                                                                                                      | 3R3074      |
| 8.5 x 14 inch | Dual Purpose Colors—Pink                                                                                                                                              | 3R3090      |
| 8.5 x 11 inch | Dual Purpose Colors—Yellow                                                                                                                                            | 3R3054      |
| 8.5 x 11 inch | Dual Purpose Colors—Yellow, 3-hole                                                                                                                                    | 3R3070      |
| 8.5 x 14 inch | Dual Purpose Colors—Yellow                                                                                                                                            | 3R3086      |
| 8.5 x 11 inch | Dual Purpose Colors—Buff                                                                                                                                              | 3R3060      |
| 8.5 x 11 inch | Dual Purpose Colors—Buff, 3-hole                                                                                                                                      | 3R3076      |
| 8.5 x 14 inch | Dual Purpose Colors—Buff                                                                                                                                              | 3R3092      |

Table B-1. **Consumable supplies** (continued)

| Item                              | Description                                                             | Part number |
|-----------------------------------|-------------------------------------------------------------------------|-------------|
| 8.5 x 11 inch                     | Dual Purpose Colors—Goldenrod                                           | 3R3062      |
| 8.5 x 11 inch                     | Dual Purpose Colors—Goldenrod, 3-hole                                   | 3R3078      |
| 8.5 x 14 inch                     | Dual Purpose Colors—Goldenrod                                           | 3R3094      |
| 8.5 x 11 inch                     | Dual Purpose Colors—Ivory                                               | 3R3064      |
| 8.5 x 11 inch                     | Dual Purpose Colors—Ivory, 3-hole                                       | 3R3080      |
| 8.5 x 14 inch                     | Dual Purpose Colors—Ivory                                               | 3R3096      |
| 8.5 x 11 inch                     | Dual Purpose Colors—Gray                                                | 3R3066      |
| 8.5 x 11 inch                     | Dual Purpose Colors—Gray, 3-hole                                        | 3R3802      |
| 8.5 x 14 inch                     | Dual Purpose Colors—Gray                                                | 3R3098      |
| 8.5 x 11 inch                     | Dual Purpose Colors—Rainbow Pack (35,000 sheets/carton—250 sheets/pack) | 3R3107      |
| 8.5 x 11 inch                     | 10 Series Dual Purpose Paper                                            | 3R2950      |
| 8.5 x 11 inch                     | 10 Series Dual Purpose Paper, 3-hole                                    | 3R2952      |
| 8.5 x 11 inch                     | 10 Series Dual Purpose Paper, 3-hole*                                   | 3R3016      |
| 8.5 x 14 inch                     | 10 Series Dual Purpose Paper                                            | 3R2954      |
| 8.5 x 11 inch                     | 10 Series Smooth                                                        | 3R54        |
| 8.5 x 14 inch                     | 10 Series Smooth                                                        | 3R83        |
| 8.5 x 11 inch                     | 4024 Dual Purpose, reinforced 3-hole                                    | 3R2057      |
| 9 x 11 inch                       | 65 lb., divider white                                                   | 3R3428      |
| 11 x 17 inch                      | 4024 Dual Purpose Paper                                                 | 3R729       |
| <b>Transparencies</b>             | Xerox transparencies are packaged 100 to a box                          |             |
| 8.5 x 11 inch                     | Clear, with a white strip on the edge                                   | 3R2780      |
| <b>High Speed Labels (gummed)</b> | All labels are on 8.5 x 11 inch sheets, 1000 sheets to a box.           |             |
| 8.5 x 11 inch                     | 33 labels per sheet                                                     | 3R3139      |
| 8.5 x 11 inch                     | 24 labels per sheet                                                     | 3R4474      |
| 8.5 x 11 inch                     | 8 labels per sheet                                                      | 3R4475      |
| 8.5 x 11 inch                     | 6 labels per sheet                                                      | 3R3146      |
| 8.5 x 11 inch                     | 1 labels per sheet                                                      | 3R4476      |
| 8.5 x 11 inch                     | Custom form<br>To order call: 800-822-2200,<br>or 714-423-3861          |             |
| <b>Tab stock</b>                  | 250 sheets per carton                                                   |             |

Table B-1. **Consumable supplies** (continued)

| Item                                  | Description                                                                                                                                | Part number |
|---------------------------------------|--------------------------------------------------------------------------------------------------------------------------------------------|-------------|
| Straight Collated Singles (5-tab set) | Non-drilled, 90 lb., Index white                                                                                                           | 3R4417      |
|                                       | 3 hole drilled, 90 lb., Index white                                                                                                        | 3R4418      |
|                                       | Non-drilled, 90 lb., Index white                                                                                                           | 3R4425      |
|                                       | 3 hole drilled, 90 lb., Index white                                                                                                        | 3R4426      |
| Reverse Collated Singles (5-tab set)  | Non-drilled, 90 lb., Index white                                                                                                           | 3R4415      |
|                                       | 3 hole drilled, 90 lb., Index white                                                                                                        | 3R4416      |
| <b>Cover stock</b>                    |                                                                                                                                            |             |
| 8.5 x 11 inch                         | 65 lb., blue                                                                                                                               | 3R3044      |
| 8.5 x 11 inch                         | 65 lb., white                                                                                                                              | 3R3041      |
| <b>Dry ink (for DocuPrint180)</b>     | Packaged three cartridges per carton. (Consumption rate is approximately 180,000 pages per carton for 8.5 x 11 inch paper at 7% coverage.) | 6R206       |
| <b>Developer (for DocuPrint180)</b>   | Packaged two bottles per carton. (Effective life is approximately 600,000 pages per carton.)                                               | 5R161       |
| <b>Fuser agent</b>                    | Packaged one bottle per carton. (Consumption rate is approximately 250,000 pages per liter.)                                               | 8R2955      |
| <b>Waste toner bottle</b>             |                                                                                                                                            | 93K460      |
| <b>Cleaning supplies</b>              | 1/2 inch cleaning cartridge—Call 1-800-828-5881 to order                                                                                   | 8R3635      |
|                                       | QIC Tape Drive Head Cleaning Kit                                                                                                           | 9R88432     |
|                                       | Foam-tipped swabs                                                                                                                          | 99P87256    |
|                                       | Lint-free towels                                                                                                                           | 35P2163     |
| <b>Containers</b>                     |                                                                                                                                            |             |
| 8.5 x 11 inch                         | Base                                                                                                                                       | 9R1103      |
|                                       | Pallet                                                                                                                                     | 9R1104      |
| 11 x 17 inch                          | Base                                                                                                                                       | 9R1105      |
|                                       | Pallet                                                                                                                                     | 9R1106      |
| <b>QIC blank cartridge</b>            | Call 1-800-828-5881 to order                                                                                                               | 9R84168     |

---

# Glossary

|                              |                                                                                                                                                                                                                                                                                                                                                                              |
|------------------------------|------------------------------------------------------------------------------------------------------------------------------------------------------------------------------------------------------------------------------------------------------------------------------------------------------------------------------------------------------------------------------|
| <b>A3</b>                    | Paper size measuring 297 by 420 mm.                                                                                                                                                                                                                                                                                                                                          |
| <b>A4</b>                    | Paper size measuring 210 by 297 mm.                                                                                                                                                                                                                                                                                                                                          |
| <b>abort</b>                 | To terminate the printing of a job or execution of a program before it completes.                                                                                                                                                                                                                                                                                            |
| <b>algorithm</b>             | Computational procedure that can be repeated any number of times.                                                                                                                                                                                                                                                                                                            |
| <b>alignment</b>             | Positioning of an image on a page for printing.                                                                                                                                                                                                                                                                                                                              |
| <b>alphanumeric</b>          | Set of characters including the letters A through Z, numerals 0 through 9, and all printable special symbols.                                                                                                                                                                                                                                                                |
| <b>AIM</b>                   | Ancillary IOT message processor. System task that initializes the client layer between the printer and the system controller. It also displays the Fault, Hint, and information messages.                                                                                                                                                                                    |
| <b>ASCII</b>                 | American Standard Code for Information Interchange. Standard 7-bit code that represents alphanumeric information. Each alphanumeric character and several nonprinting characters are assigned a binary number, covering 128 possible characters. It is used for information interchange among data processing systems, data communication systems, and associated equipment. |
| <b>application</b>           | Use to which a computer program or system is put, for example, sorting employee records.                                                                                                                                                                                                                                                                                     |
| <b>applications software</b> | Host- or LPS-resident software that directs the computer to perform specific tasks or functions as opposed to the software used to operate the computer. Common business applications include payroll, accounting, and inventory.                                                                                                                                            |
| <b>ascender</b>              | Portion of alphabetic character that rises above the body of the character (its x-height portion). See also descender; x height.                                                                                                                                                                                                                                             |
| <b>asynchronous</b>          | Transmission in data communications controlled by start and stop elements at the beginning and end of each character. Thus, time intervals between transmitted characters may be unequal in length.                                                                                                                                                                          |
| <b>audit log</b>             | Captures the sheet delivery information for every page in an audited report, certain details about each sheet, the planned and actual report control totals, and waste management.                                                                                                                                                                                           |

|                                        |                                                                                                                                                                                                                                                                                                                                                                                                                                                                                                                                                                                              |
|----------------------------------------|----------------------------------------------------------------------------------------------------------------------------------------------------------------------------------------------------------------------------------------------------------------------------------------------------------------------------------------------------------------------------------------------------------------------------------------------------------------------------------------------------------------------------------------------------------------------------------------------|
| <b>auxiliary menu</b>                  | Menu that contains options not displayed in a window. The symbol for an auxiliary menu is a box containing three horizontal lines.                                                                                                                                                                                                                                                                                                                                                                                                                                                           |
| <b>B4</b>                              | Paper size measuring 250 by 353 mm.                                                                                                                                                                                                                                                                                                                                                                                                                                                                                                                                                          |
| <b>background job</b>                  | Low-priority job, usually batched, that is executed automatically as system resources become available.                                                                                                                                                                                                                                                                                                                                                                                                                                                                                      |
| <b>backup file</b>                     | File copied to a storage medium for safekeeping in case the original is damaged or lost.                                                                                                                                                                                                                                                                                                                                                                                                                                                                                                     |
| <b>band</b>                            | Rectangular area in printer memory into which an image sent to the printer from a computer is divided.                                                                                                                                                                                                                                                                                                                                                                                                                                                                                       |
| <b>batch processing</b>                | Allows for repetitive operations to be performed sequentially on batched data without much involvement of the computer operator.                                                                                                                                                                                                                                                                                                                                                                                                                                                             |
| <b>baud</b>                            | Measurement of data rate in bits per second. This term is used to describe information flow between two devices. Unit of data transmitting and receiving speed is roughly equal to a single bit per second. Common baud rates are 110, 300, 1200, 2400, 4800, and 9600.                                                                                                                                                                                                                                                                                                                      |
| <b>binary</b>                          | Numbering system based on 2 that uses only the symbols 0 and 1. Binary is used in computers and related devices since information can be represented with electric pulses (0=off, 1=on). Most computer calculations are binary.                                                                                                                                                                                                                                                                                                                                                              |
| <b>binary digit (bit)</b>              | <p>In the binary numbering system, either of the characters 0 or 1. The "bit" is the base unit of information used by computers. It can take the form of a magnetized spot, an electric pulse, or a positive or negative charge. A sequentially stored set of bits represents a character on a computer.</p> <p>Multipliers are:</p> <p>1 or 0 byte = 8,192 bits</p> <p>kilobyte (KB) or 1,024 bytes = 8,388,608 bits.</p> <p>Computer space equivalents are:</p> <p>1.5 KB = about 1 single-spaced typed page</p> <p>30 KB = about 20 typed pages</p> <p>150 KB = about 100 typed pages</p> |
| <b>binary synchronous transmission</b> | Data transmission in which synchronization of characters is controlled by timing signals generated at the sending and receiving stations.                                                                                                                                                                                                                                                                                                                                                                                                                                                    |
| <b>bit</b>                             | Abbreviation for binary digit, the smallest unit of information recognized by a computer. See also binary digit.                                                                                                                                                                                                                                                                                                                                                                                                                                                                             |

---

|                         |                                                                                                                                                                                                                                                                                                      |
|-------------------------|------------------------------------------------------------------------------------------------------------------------------------------------------------------------------------------------------------------------------------------------------------------------------------------------------|
| <b>bit map</b>          | Visual representation of graphic images in which a bit defines a picture element (pixel); for example, if a bit is 1, the corresponding pixel is printed.                                                                                                                                            |
| <b>bit mapped</b>       | Display image generated bit by bit for each point or dot. A software-driven scanner is used to create characters or graphics.                                                                                                                                                                        |
| <b>blocking</b>         | Process of combining two or more records into a single block of data which can then be moved, operated upon, or stored, as a single unit by the computer.                                                                                                                                            |
| <b>block length</b>     | Number of characters or bytes contained in a block of data (the block is treated as a unit within the computer). Block length is usually invariable within a system and may be specified in units such as records, words, computer words, or characters.                                             |
| <b>boot</b>             | To load the initial instructions of a program into computer memory; these instructions then direct the loading of the rest of the program. Booting may require entry of a few commands at the keyboard or the flip of a switch to begin the process.                                                 |
| <b>bps</b>              | bits per second. In serial communication, the instantaneous bit speed with which a device or channel transmits a character.                                                                                                                                                                          |
| <b>BSC</b>              | binary synchronous communication. 1. Communication using binary synchronous line discipline. 2. Uniform procedure using a standardized set of control characters and control character sequences for synchronous transmission of binary-coded data between stations.                                 |
| <b>buffer</b>           | Compartment of memory in which this data is stored during transfer from one device to another. This is useful for accumulating data into blocks before storage or processing and for adjusting differences of speed between devices, or between a device and a communicating facility.               |
| <b>Bypass Transport</b> | Optional module that moves paper from the last stacker bin to a finishing device.                                                                                                                                                                                                                    |
| <b>byte</b>             | Fixed number of bits (in data processing, usually 8) operated upon as a unit. A byte may represent a character, a machine instruction, or some other logical unit of information.                                                                                                                    |
| <b>carriage return</b>  | Control character that causes the printing system to start printing at the left margin of the current line unless set to be interpreted as a line end.                                                                                                                                               |
| <b>channel</b>          | 1. In data communications, a path or line that enables two or more devices to communicate (sometimes called a circuit, facility, or link).<br>2. In computers, a path for communication between the central processing unit (CPU) and input/output units, or between the CPU and peripheral devices. |

|                                  |                                                                                                                                                                                                                                                   |
|----------------------------------|---------------------------------------------------------------------------------------------------------------------------------------------------------------------------------------------------------------------------------------------------|
| <b>character</b>                 | Single printable letter (A-Z), numeral (0-9), symbol (& % #), or punctuation mark (, . ! ?) used to represent data. Characters can also be nonprinting, such as space, tab, or carriage return.                                                   |
| <b>character cell</b>            | Digitized space containing a single character within a font set.                                                                                                                                                                                  |
| <b>character code</b>            | Code representing alphanumeric information, for example, ASCII.                                                                                                                                                                                   |
| <b>character code identifier</b> | Code associated with the universal identifier "Xerox" to indicate the version of the Xerox character code standard used to code Interpress strings.                                                                                               |
| <b>character set</b>             | Number of different characters used by a particular device, including alphabetic, numeric, and special characters such as symbols.                                                                                                                |
| <b>client layer</b>              | The software interface used by the AIM task and the Output task to communicate with the printer, allowing printing commands and fault and status information to be exchanged.                                                                     |
| <b>clocking</b>                  | A method of synchronizing the sending and receiving of data communications devices. Clocking allows synchronous transmission at high speeds.                                                                                                      |
| <b>cluster</b>                   | Group of paper feeder trays, usually containing the same size and type of paper (stock). Each cluster has a name, consisting of one to six alphanumeric characters. See also stock; stockset.                                                     |
| <b>CME</b>                       | copy modification entry. Entry modifying the output printing characteristics of a report on a copy-to-copy basis.                                                                                                                                 |
| <b>code</b>                      | 1. Set of symbols representing data or instructions to a computer. 2. To write a list of instructions (software) to cause the product/system to perform specified operations.                                                                     |
| <b>code conversion</b>           | Translation of one type of character or symbol code to another.                                                                                                                                                                                   |
| <b>collate</b>                   | To arrange or assemble into ordered sets.                                                                                                                                                                                                         |
| <b>column</b>                    | Vertical arrangement of characters.                                                                                                                                                                                                               |
| <b>command</b>                   | User instruction to a computer, using the system controller keyboard or the PC UI. Commands are words, mnemonics, or characters that cause a computer to perform predefined operations. Coded instruction to a computer or computer-based system. |
| <b>command language</b>          | Set of commands that can be used for a system, such as how the system can be instructed to perform a task.                                                                                                                                        |
| <b>comment</b>                   | Explanations written with program instructions. They are ignored by the computer.                                                                                                                                                                 |



---

|                            |                                                                                                                                                                                |
|----------------------------|--------------------------------------------------------------------------------------------------------------------------------------------------------------------------------|
| <b>communication line</b>  | Telecommunication line connecting devices at one location with devices at other locations in order to transmit and receive information.                                        |
| <b>communication link</b>  | Physical means, such as data link, connecting one location to another to transmit and receive information.                                                                     |
| <b>communications</b>      | Ability of two devices to transmit information to each other.                                                                                                                  |
| <b>compatibility</b>       | Characteristic of computer equipment permitting one device to use the same information or programs as another device without conversion or code modification.                  |
| <b>compiler</b>            | Software that translates instructions written in high-level language into machine language for execution by a system.                                                          |
| <b>computer</b>            | Functional unit capable of performing substantial computations, including numerous arithmetic or logic operations without human intervention during a run.                     |
| <b>computer language</b>   | Computer-oriented language consisting solely of computer instructions. See also machine language.                                                                              |
| <b>computer system</b>     | Central processing unit (CPU) with main storage, input/output channels and devices, control units, and external storage devices connected to it.                               |
| <b>concatenate</b>         | To connect or link in a series, as when files are grouped together for faster processing. See also job concatenation mode.                                                     |
| <b>console</b>             | Functional unit containing devices used by an operator to communicate with an operating system. It may consist of a display, keyboard, and certain switches or other controls. |
| <b>consumable supplies</b> | Supplies such as paper and dry ink that are depleted (used up) during the course of normal printer operation.                                                                  |
| <b>continuous printing</b> | Refers to Interpress job integrity under any of the following conditions: excessive graphics, forms, or font use problems.                                                     |
| <b>control program</b>     | Program that supports the operating system by monitoring the flow of jobs, tasks, processing, and so on, within the system; for example, a data communication program.         |
| <b>coordinate</b>          | Point on the x and y axis that determines a grid position.                                                                                                                     |
| <b>copy</b>                | To duplicate data in a new location or on an additional storage medium, for example, to copy files from disk to tape.                                                          |

|                            |                                                                                                                                                                                                                                                      |
|----------------------------|------------------------------------------------------------------------------------------------------------------------------------------------------------------------------------------------------------------------------------------------------|
| <b>copy-sensitive</b>      | Term used to indicate jobs in which multiple copies of a report will contain different data, as with paychecks and banking statements.                                                                                                               |
| <b>cpi</b>                 | characters per inch. Designates the number of characters per inch for a particular typeface. See also pitch.                                                                                                                                         |
| <b>CPU</b>                 | central processing unit. Interprets and executes instructions, performs all operations and calculations, and controls input and output units and auxiliary attachments.                                                                              |
| <b>data</b>                | 1. In general, facts, numbers, letters, symbols, and so on, which can be processed or produced by a computer. 2. In data processing, the source data or raw data entered for processing, as opposed to the results obtained by processing.           |
| <b>database</b>            | Information to meet specific processing and retrieval needs. Generally applies to integrated file of data, arranged for access by many subsystems.                                                                                                   |
| <b>data communications</b> | Transmission and reception of encoded information over telecommunication lines.                                                                                                                                                                      |
| <b>data file</b>           | Collection of related data records organized in a specific manner so that each record is similarly structured, for example, a payroll file set up with one record for each employee, last name first, indicating the rate of pay and all deductions. |
| <b>data processing</b>     | Operations carried out on data by means of algorithms and programs to produce information or a specific result. The rearrangement of data into a suitable form for further use.                                                                      |
| <b>data rate</b>           | In data communications, the rate at which a channel carries data, measured in bits per second (bps).                                                                                                                                                 |
| <b>data storage</b>        | Preservation of data on various media, for example, tape, disks, magnetic bubble memory, and so on.                                                                                                                                                  |
| <b>data transmission</b>   | Transmission of coded data over telephone or other telecommunication lines.                                                                                                                                                                          |
| <b>debug</b>               | To detect and correct errors in a program.                                                                                                                                                                                                           |
| <b>decompose</b>           | To break down into component parts, such as when Interpress breaks down a Font Interchange Standard (FIS) master to compile font information.                                                                                                        |
| <b>default</b>             | Value assigned to a field by the system. Default fields may be used for such items as document formats, menu selections, input fields, font selection, and paper or image size. The default value of a field may be changed.                         |

---

|                              |                                                                                                                                                                                           |
|------------------------------|-------------------------------------------------------------------------------------------------------------------------------------------------------------------------------------------|
| <b>descender</b>             | Portion of alphabetic character that extends below the baseline. See also ascender, x height.                                                                                             |
| <b>desktop</b>               | Basic display screen of the PC UI.                                                                                                                                                        |
| <b>device</b>                | Any piece of hardware other than the central processing unit (CPU).                                                                                                                       |
| <b>digitize</b>              | To express or represent data in digital (binary) form so that it can be processed electronically.                                                                                         |
| <b>disk drive</b>            | Device that can read or write magnetic media.                                                                                                                                             |
| <b>display</b>               | Viewing device (monitor) that visually communicates system warnings, status, and error messages and reflects operator interaction with the system on a display.                           |
| <b>DJDE</b>                  | Dynamic Job Descriptor Entry. Command within an input data stream used to modify the printing environment dynamically.                                                                    |
| <b>DMR</b>                   | Command parameter that designates a Digital Equipment Corporation host system.                                                                                                            |
| <b>document</b>              | 1. Data medium and the data recorded on it, usually permanent, which can be read by you or a computer. 2. Collection of information pertaining to a specific subject or related subjects. |
| <b>dot</b>                   | Unit of measurement representing a fraction of an inch, for example, 300 dots per inch (dpi). It may also be referred to as a picture element (pixel) or spot.                            |
| <b>download</b>              | To copy files using communication lines from the host onto LPS system disks.                                                                                                              |
| <b>dry ink</b>               | Minute dry particles of resin and carbon black used to create images. Dry ink can accept an electrical charge.                                                                            |
| <b>duplex printing</b>       | Printing on both sides (front and back) of a page. See also simplex printing.                                                                                                             |
| <b>EBCDIC</b>                | Extended Binary Coded Decimal Interchange Code. Coded character set consisting of 8-bit coded characters. It can accommodate 256 characters.                                              |
| <b>edgemarking</b>           | Use of graphic objects, usually lines or boxes, that bleed off the edge of the physical page. See also physical page.                                                                     |
| <b>electronic publishing</b> | Integrated production of documents on demand, using digitally stored documents, computerized composition, and electronic printing systems.                                                |

|                         |                                                                                                                                                                                                                                |
|-------------------------|--------------------------------------------------------------------------------------------------------------------------------------------------------------------------------------------------------------------------------|
| <b>elite</b>            | Smallest size standard typewriter type: 12 characters per horizontal inch. See also pica.                                                                                                                                      |
| <b>embedded blanks</b>  | Blank spaces within a command line.                                                                                                                                                                                            |
| <b>Ethernet</b>         | Xerox local area network (LAN) that allows data to be transmitted by cable from one device to another, enabling it to share the network.                                                                                       |
| <b>extended metrics</b> | Measurements used in Interpress to alter the size of fonts, allowing more precision with character escapement. Used for rendered characters.                                                                                   |
| <b>FCB</b>              | forms control buffer. Buffer for controlling the vertical format of printed output.                                                                                                                                            |
| <b>FDL</b>              | forms description language. LPS-resident source language used for designing electronic forms. See also FSL; form.                                                                                                              |
| <b>field</b>            | 1. Part of a record that serves a similar function in all records of that group, such as name and address field. 2. Area or setting of practical activity or application.                                                      |
| <b>file</b>             | Set of records or text that can be stored and retrieved. An organized, named collection of records treated as a unit. For offline, it is the data between the two tape marks. For online, it is the data between banner pages. |
| <b>file protection</b>  | To prevent the contents on a disk or tape from being erased or written over by disabling the write head of a unit.                                                                                                             |
| <b>firmware</b>         | Permanent programs stored in read-only memory (ROM).                                                                                                                                                                           |
| <b>FIS</b>              | Font Interchange Standard. Standard that defines the digital representation of fonts and character metrics for the generation of an entire series of Interpress fonts.                                                         |
| <b>fixed font</b>       | Font containing characters with fixed spacing. See also proportional font.                                                                                                                                                     |
| <b>fixed pitch</b>      | Font set in which every character cell has the same width. In reference to character sets, this term describes typefaces in which all character cells are of equal width. Monospaced as opposed to proportional spaced.        |
| <b>fixed spacing</b>    | Arrangement of characters on a line so that all characters occupy the same amount of horizontal space.                                                                                                                         |
| <b>floating accent</b>  | Nonspacing accent characters that can be combined with characters and printed as a composite.                                                                                                                                  |

---

|                        |                                                                                                                                                                                                                                                                                                                                                                                                                  |
|------------------------|------------------------------------------------------------------------------------------------------------------------------------------------------------------------------------------------------------------------------------------------------------------------------------------------------------------------------------------------------------------------------------------------------------------|
| <b>font</b>            | Set of images, usually characters and symbols, having common characteristics such as style, width, height, and weight.                                                                                                                                                                                                                                                                                           |
| <b>form</b>            | 1. Compiled forms source library (.FSL) file. 2. Printed or typed document with blank spaces for inserting information. Specific arrangement of lines, text, and graphics stored in a computer under an identifying name. Page of data that, when preceded by proper commands, is stored on the system disk as a permanent file. It may be merged with variable data by a form start command. See also FDL; FSL. |
| <b>format</b>          | 1. Layout of a document, including margins, page length, line spacing, typeface, and so on. 2. In data storage, the way the surface of a disk is organized to store data. 3. To prepare the surface of a disk for acceptance of data.                                                                                                                                                                            |
| <b>form feed</b>       | Keyboard or printer control character that causes the printer to skip the top of the next page.                                                                                                                                                                                                                                                                                                                  |
| <b>FSL</b>             | forms source library. Uncompiled collection of user-created files containing FDL commands. Refer to FDL; form.                                                                                                                                                                                                                                                                                                   |
| <b>function keys</b>   | Keyboard keys that produce no character but initiate a particular machine function, such as delete.                                                                                                                                                                                                                                                                                                              |
| <b>fuse</b>            | To affix dry ink to paper by heat or pressure or a combination of both.                                                                                                                                                                                                                                                                                                                                          |
| <b>GCR</b>             | group code recording mode. Refers to the specific density of data (such as 6250 bpi) as it is recorded on tape, which is measured in bits per inch (bpi).                                                                                                                                                                                                                                                        |
| <b>graphics</b>        | Use of lines and figures to display data, as opposed to using text.                                                                                                                                                                                                                                                                                                                                              |
| <b>grid</b>            | Imaginary pattern of evenly spaced horizontal and vertical lines on a page.                                                                                                                                                                                                                                                                                                                                      |
| <b>grid unit</b>       | Smallest rectangle enclosed by horizontal and vertical lines on a grid. The size of a grid unit is expressed as the length of one side of a rectangle.                                                                                                                                                                                                                                                           |
| <b>halftone screen</b> | A tool used in offset printing, typesetting, and laser printing to convert a continuous tone (such as photographic) image to dots, which allows the image to be rendered accurately in these printing processes.                                                                                                                                                                                                 |
| <b>hardcopy</b>        | Machine output in permanent form, such as printed reports, listings, and so on. Output in a permanent form (usually on paper or paper tape) rather than in temporary form, as on a display. Contains readable printed copy of machine (for example, computer) output.                                                                                                                                            |
| <b>hard values</b>     | Nonoptimal adjustment of particular FIS fonts in terms of point size and orientation.                                                                                                                                                                                                                                                                                                                            |

|                               |                                                                                                                                                                                                                                                      |
|-------------------------------|------------------------------------------------------------------------------------------------------------------------------------------------------------------------------------------------------------------------------------------------------|
| <b>hardware</b>               | Physical components, such as mechanical, magnetic, and electronic elements of a system, as opposed to programs, procedures, rules, and associated documentation. Hardware is operated by software and firmware.                                      |
| <b>HCF</b>                    | high-capacity feeder. Feeder tray capable of holding 2500 sheets of 20 pound/75 gsm paper. The high-capacity feeder trays are the primary paper supply for the DP180 LPS. They are located in the bottom half of the feeder/stacker modules.         |
| <b>HCS</b>                    | high-capacity stacker. Stacker bin capable of holding 2500 sheets of 20 pound/75 gsm paper. In the LPS, the high-capacity stacker bins are located in the top half of the feeder/stacker modules.                                                    |
| <b>hexadecimal</b>            | Numbering system with a base of 16. In this system, 10 through 15 are represented by A through F, respectively.                                                                                                                                      |
| <b>hierarchy</b>              | Relative priority assigned to arithmetic or logical operations that must be performed.                                                                                                                                                               |
| <b>high-level language</b>    | Language consisting of words and symbols that are close to normal English and, therefore, readily understandable by the user. High-level languages are oriented to problems or commercial procedures and are the source languages for most programs. |
| <b>host</b>                   | Computer accessed by users which serves as a source of high-speed data processing for workstations with less computer power. See also mainframe.                                                                                                     |
| <b>host interface</b>         | Connection between network and host computer.                                                                                                                                                                                                        |
| <b>icon</b>                   | Symbol appearing on the PC UI or printer control console that can be opened to display a window or screen options.                                                                                                                                   |
| <b>id</b>                     | identifier. Character used to identify or name data and possibly to indicate certain properties of that data.                                                                                                                                        |
| <b>image area</b>             | Area on a physical page that may contain text or graphics.                                                                                                                                                                                           |
| <b>information processing</b> | Generic term encompassing both word and data processing, used to describe the entire scope of operations performed by a computer.                                                                                                                    |
| <b>initialize</b>             | 1. To prepare the magnetic surface of a blank diskette so that it can accept data. 2. To set all information in a computer system to its starting values (usually the first step is accomplished when a program is booted).                          |
| <b>input</b>                  | Data or text introduced into a computer-based system.                                                                                                                                                                                                |
| <b>input/output</b>           | General term encompassing the flow of data into and out of a system.                                                                                                                                                                                 |

---

|                                              |                                                                                                                                                                                                                                                        |
|----------------------------------------------|--------------------------------------------------------------------------------------------------------------------------------------------------------------------------------------------------------------------------------------------------------|
| <b>input processing</b>                      | Formatting control for the pages of a report.                                                                                                                                                                                                          |
| <b>insert</b>                                | To add text or graphics to a document.                                                                                                                                                                                                                 |
| <b>interface</b>                             | Device by which two systems connect and communicate with each other.                                                                                                                                                                                   |
| <b>interpolation</b>                         | Series of logical rules implemented in the printer to convert a 300 spi input video stream to a 600 spi output video stream. Interpolation is functionally analogous to bit doubling (2x scaling), except the logical rules result in superior output. |
| <b>Interpress</b>                            | Xerox standard that defines digital representation of lines for printing. Interpress documents can be printed on any sufficiently powerful printer equipped with Interpress print software.                                                            |
| <b>Interpress font utility (IFU) program</b> | Program used to convert FIS fonts to LPS fonts.                                                                                                                                                                                                        |
| <b>Interpress master</b>                     | File written according to the Interpress standard.                                                                                                                                                                                                     |
| <b>IPL</b>                                   | initial program load. For the optional open-reel tape drive, the internal initialization sequence whereby certain functions are loaded into random access memory (RAM).                                                                                |
| <b>JDE</b>                                   | job descriptor entry. Collection of job descriptions. See also job; JSL.                                                                                                                                                                               |
| <b>JDL</b>                                   | job descriptor library. Collection of compiled job descriptions. See also JSL.                                                                                                                                                                         |
| <b>job</b>                                   | 1. Set of instructions (JDEs) defining a unit of work for the system. 2. In setting a separation boundary through the Bin Full Criteria task, job refers to everything printed as the result of a single start command. See also JDE.                  |
| <b>job concatenation mode</b>                | In HIP, a mode in which multiple print jobs are processed as reports in one print job. See also concatenate.                                                                                                                                           |
| <b>job control</b>                           | Program called into storage to prepare each job or job step to be run.                                                                                                                                                                                 |
| <b>job management</b>                        | Collective functions of job scheduling and command processing.                                                                                                                                                                                         |
| <b>JSL</b>                                   | job source library. Collection of uncompiled job descriptions. See also job; JDE; and JDL.                                                                                                                                                             |
| <b>keyboard</b>                              | Group of alphabetic, numeric, and/or function keys used to enter information into a system.                                                                                                                                                            |
| <b>keyword</b>                               | Required part of a command. See also operator command.                                                                                                                                                                                                 |

|                                   |                                                                                                                                                                                                                                                                                                                            |
|-----------------------------------|----------------------------------------------------------------------------------------------------------------------------------------------------------------------------------------------------------------------------------------------------------------------------------------------------------------------------|
| <b>label</b>                      | 1. In data storage, a reference to a file saved on tape or disk, a record indicating the file name or date created, or other control information.<br>2. In programming, a name assigned to a particular instruction or portion of a program as a locational reference (the computer translates the label into an address). |
| <b>landscape page orientation</b> | Orientation of print lines or top of an illustration parallel to the long edge of the paper if the sheet is within the standard size range. (Sheets larger than standard have the reverse print orientation.)                                                                                                              |
| <b>language</b>                   | Defined set of characters and symbols combined together by specific rules. See also high-level language; low-level language.                                                                                                                                                                                               |
| <b>laser printing</b>             | Technology that uses a laser to transfer character forms to a page by direct or indirect means.                                                                                                                                                                                                                            |
| <b>latent image</b>               | Static charge present on the photoconductor before contact with dry ink particles.                                                                                                                                                                                                                                         |
| <b>leading</b>                    | 1. Vertical distance between lines (also called line space), measured from a baseline of one line to the baseline of the next. 2. Extra spacing between lines of type. 3. In typography, spacing between lines and paragraphs.                                                                                             |
| <b>LED</b>                        | light emitting diode. Solid substance that glows when a current is passed through it. Often used for indicator lights on disk drives or modems, as well as for displays on other electronic equipment.                                                                                                                     |
| <b>LEF</b>                        | long-edge feed. The movement of paper through the printer in the direction of the paper length (the longer side of a sheet of paper).                                                                                                                                                                                      |
| <b>legal size</b>                 | Sheet the standard size of legal briefs, 8.5 by 14 inches.                                                                                                                                                                                                                                                                 |
| <b>letter size</b>                | Paper sized 8.5 by 11 inches/216 by 279 mm.                                                                                                                                                                                                                                                                                |
| <b>library</b>                    | In data storage, a collection of related files or programs.                                                                                                                                                                                                                                                                |
| <b>line</b>                       | One horizontal flow of characters.                                                                                                                                                                                                                                                                                         |
| <b>line feed</b>                  | Control character that, unless set to be interpreted as a line end, causes the printing system to begin printing in the current character position of the next line.                                                                                                                                                       |
| <b>line tables</b>                | Internal data structures providing a record in memory of lines to be drawn on a page.                                                                                                                                                                                                                                      |
| <b>listing</b>                    | Printout or display of the statements in a program, usually used as a convenience in examining or editing programs.                                                                                                                                                                                                        |



---

|                         |                                                                                                                                                                                                                                                                                                                                                |
|-------------------------|------------------------------------------------------------------------------------------------------------------------------------------------------------------------------------------------------------------------------------------------------------------------------------------------------------------------------------------------|
| <b>literal</b>          | Alphanumeric beginning with a letter, optionally including an asterisk, period, colon, or slash, and not enclosed in single quotes.                                                                                                                                                                                                            |
| <b>load</b>             | To enter data into storage or working registers.                                                                                                                                                                                                                                                                                               |
| <b>location</b>         | Place in which data can be stored.                                                                                                                                                                                                                                                                                                             |
| <b>log</b>              | Collection of messages or message segments placed on an auxiliary storage device for accounting or data collection purposes.                                                                                                                                                                                                                   |
| <b>logical page</b>     | In the Xerox printing systems environment, a formatted page that is smaller than the physical page. A logical page is defined by an origin, thus allowing more than one logical page to be placed on a physical page.                                                                                                                          |
| <b>logo</b>             | Small illustration or design, usually simple, typically used to identify a company.                                                                                                                                                                                                                                                            |
| <b>log off</b>          | Procedure by which a user ends a session.                                                                                                                                                                                                                                                                                                      |
| <b>log on</b>           | Procedure by which a user begins a session between an application program and a logical unit.                                                                                                                                                                                                                                                  |
| <b>magnetic media</b>   | Term for all storage devices, such as disks, diskettes, and tape, on which data is stored in the form of magnetized spots on surface of the media.                                                                                                                                                                                             |
| <b>magnetic storage</b> | Use of magnetic media to store data, programs, and so on.                                                                                                                                                                                                                                                                                      |
| <b>magnetic tape</b>    | Flexible plastic tape, with one side offering a magnetic surface suitable for storing computer data in the form of magnetized spots. Magnetic tape is often used for long-term storage since it can accommodate large volumes of information.                                                                                                  |
| <b>mainframe</b>        | Central processing unit (CPU) and memory of a large computer. More often used to denote any large computer of the type that might be used to control a group of smaller computers, terminals, or other devices. See also host.                                                                                                                 |
| <b>margins</b>          | White space on each side of printed text.                                                                                                                                                                                                                                                                                                      |
| <b>mask</b>             | 1. Selection of bits from a storage unit by using an instruction that eliminates the other bits in the unit. 2. In accessing files, a file name mask is used to reference one or more files with similar file-id (identifier) syntax. 3. In Interpress, a mask serves as a template, indicating the shape and position of an object on a page. |
| <b>MB</b>               | megabyte. Unit of one million bytes.                                                                                                                                                                                                                                                                                                           |

|                   |                                                                                                                                                                                                                                                                                                                                            |
|-------------------|--------------------------------------------------------------------------------------------------------------------------------------------------------------------------------------------------------------------------------------------------------------------------------------------------------------------------------------------|
| <b>media</b>      | Vehicles or devices by which information is stored or transmitted. Classifications include source, input, and output.                                                                                                                                                                                                                      |
| <b>medium</b>     | Object or material on which data is stored, for example, magnetic tape or floppy disk.                                                                                                                                                                                                                                                     |
| <b>memory</b>     | Space in a device where information is kept, or the ability of a device to keep information until needed.                                                                                                                                                                                                                                  |
| <b>menu</b>       | List of available functions, commands, and options.                                                                                                                                                                                                                                                                                        |
| <b>message</b>    | Unit of information transmitted by one facility to another in a form that the receiving facility can understand and act upon. The standard message format consists of a header (containing identifying and control information), followed by the actual message content, followed by a trailer (indicating that the message is completed). |
| <b>metacode</b>   | Same as "native mode." The method of speaking to and controlling the image generator. These controls are used by the character dispatcher to generate scan line information. This information is sent in the form of character specifications to the image generator, which uses it to compose the bit stream that modulates the laser.    |
| <b>MHz</b>        | megahertz. 1. Unit of cycling speed (one million cycles per second) for an electromagnetic wave (in particular, a radio wave). 2. Sending and receiving stations of a radio wave transmission must be tuned in to the same unit of megahertz.                                                                                              |
| <b>mode</b>       | Manner in which an activity or process is carried out.                                                                                                                                                                                                                                                                                     |
| <b>modem</b>      | Device that converts digital information into an analog signal suitable for sending over analog telecommunication lines. Also converts an analog signal from telecommunication lines into digital information.                                                                                                                             |
| <b>module</b>     | Cohesive unit within a program. It is consistent in its level and identifiable in terms of loading or with other units.                                                                                                                                                                                                                    |
| <b>mouse</b>      | Electronic device used with the PC UI to select options and enter data.                                                                                                                                                                                                                                                                    |
| <b>mouse pad</b>  | Base that provides friction and direction information to the electronic mouse.                                                                                                                                                                                                                                                             |
| <b>mouse tray</b> | Optional extension module attached to the system controller to accommodate the mouse pad and provide ample working space.                                                                                                                                                                                                                  |
| <b>network</b>    | 1. System of geographically separate computers, linked to one another over transmission lines. 2. Communication lines connecting a computer to its remote terminals.                                                                                                                                                                       |

---

|                          |                                                                                                                                                                                                                                                                                                                                                                                           |
|--------------------------|-------------------------------------------------------------------------------------------------------------------------------------------------------------------------------------------------------------------------------------------------------------------------------------------------------------------------------------------------------------------------------------------|
| <b>nonimpact printer</b> | Printer that forms characters without any strikes of a key or element against the paper.                                                                                                                                                                                                                                                                                                  |
| <b>object file</b>       | Source file converted into machine language (binary code).                                                                                                                                                                                                                                                                                                                                |
| <b>offline</b>           | Devices not under the active control of a central processing unit. For example, a computer makes output to a magnetic tape. The tape is then used by an offline printing system to produce printed data. Offline operations are much slower than online operations. See also online.                                                                                                      |
| <b>offset</b>            | To place pages currently being printed in slightly different positions from previous pages.                                                                                                                                                                                                                                                                                               |
| <b>offset printing</b>   | Widely-used method of commercial and corporate printing, where ink is picked up by a metal or paper plate, passed to an offset drum, and then passed to the paper.                                                                                                                                                                                                                        |
| <b>online</b>            | Devices under the direct control of a central processing unit, for example a printing system in interactive communication with a mainframe. See also offline.                                                                                                                                                                                                                             |
| <b>operating system</b>  | Basic host- or LPS-resident controlling program that governs the operations of a computer, such as job entry, input/output, and data management. The operating system is always running when the computer is active. Unlike other types of programs, it does not run to an end point and stop. The operating system of a Xerox LPS is referred to as the operating system software (OSS). |
| <b>operation</b>         | Well-defined action that, when applied to any permissible combination of known entities, produces a new entity.                                                                                                                                                                                                                                                                           |
| <b>operator area</b>     | The 24-inch exclusive clearance that must be available directly in front of each component of an LPS for operator activities.                                                                                                                                                                                                                                                             |
| <b>operator command</b>  | Statement to control a program, issued through a console device, PC UI, or terminal, causing a control program to provide requested information, alter normal operations, initiate new operations, or terminate existing operations.                                                                                                                                                      |
| <b>orientation</b>       | 1. In reference to image area, orientation describes whether the printed lines are parallel to the long edge of the paper or the short edge of the paper. 2. Choice of printing portrait (vertically) or landscape (horizontally).                                                                                                                                                        |
| <b>origin</b>            | In reference to image area, this is the upper left corner of a sheet.                                                                                                                                                                                                                                                                                                                     |
| <b>output</b>            | 1. Material produced by a peripheral device of a computer, such as a printout or a magnetic tape. 2. Result of completed operations.                                                                                                                                                                                                                                                      |
| <b>overprinting</b>      | Printing more than one character at the same position.                                                                                                                                                                                                                                                                                                                                    |

|                         |                                                                                                                                                                                                                                                                                                                                                                                                                                                       |
|-------------------------|-------------------------------------------------------------------------------------------------------------------------------------------------------------------------------------------------------------------------------------------------------------------------------------------------------------------------------------------------------------------------------------------------------------------------------------------------------|
| <b>overprint lines</b>  | Print lines whose carriage control specifies printing with no line spacing after the last printed line.                                                                                                                                                                                                                                                                                                                                               |
| <b>overprint ratio</b>  | Maximum number of variable data and form characters that may be intersected by a single scan line.                                                                                                                                                                                                                                                                                                                                                    |
| <b>override</b>         | To take precedence or priority over, to overrule.                                                                                                                                                                                                                                                                                                                                                                                                     |
| <b>overstrike</b>       | To print characters over each other.                                                                                                                                                                                                                                                                                                                                                                                                                  |
| <b>page</b>             | 1. In computer programming, a block of instruction, data, or both that can be located in main or auxiliary storage. 2. In word processing, a defined section of a document.                                                                                                                                                                                                                                                                           |
| <b>page orientation</b> | Direction in which data is printed on a report. See also landscape page orientation; portrait page orientation.                                                                                                                                                                                                                                                                                                                                       |
| <b>parameter</b>        | Part of a command, other than the keyword. See also keyword; operator command.                                                                                                                                                                                                                                                                                                                                                                        |
| <b>pass-through job</b> | On systems with XPAF, a job that is sent directly from a host to a Xerox printer using XPAF, without undergoing XPAF processing.                                                                                                                                                                                                                                                                                                                      |
| <b>password</b>         | Unique word or set of characters that an operator or user must supply to log on to a system.                                                                                                                                                                                                                                                                                                                                                          |
| <b>patch</b>            | In programming, to modify a portion of the program at the machine language level, as opposed to modifying at the source program level.                                                                                                                                                                                                                                                                                                                |
| <b>PC UI</b>            | PC user interface. The PC hardware and Xerox-supplied software which allows the operator to control the LPS by means of a mouse, windows, and icons. See also object mode; TEM.                                                                                                                                                                                                                                                                       |
| <b>PDL</b>              | print description language. Language used to describe printing jobs to an LPS. PDL describes the input (type, format, characteristics), performs the processing functions (logical processing), and describes the output (type, format, font selection, accounting options).                                                                                                                                                                          |
| <b>physical page</b>    | Sheet of paper on which printing is done. See also edgemarking.                                                                                                                                                                                                                                                                                                                                                                                       |
| <b>pitch</b>            | 1. Horizontal character spacing; 10-pitch (10 characters per inch) spacing is called pica, and 12-pitch (12 characters per inch) spacing is called elite. 2. The number of page images placed on the xerographic belt during one revolution. The DocuPrint 180 LPS supports two pitch modes: 7 pitch when paper 9 inches/229 mm long or less is used to print a job, and 3 pitch when paper 9 to 17 inches/229 to 432 mm long is used to print a job. |
| <b>pixel</b>            | Acronym for picture element. Smallest addressable point of a bit-mapped screen that can be independently assigned color and                                                                                                                                                                                                                                                                                                                           |

intensity. Pixels are definable locations on a display used to form images. For graphic displays, more pixels generally provide higher resolution. Spots, dots, and pixels are used interchangeably.

|                                  |                                                                                                                                                                                                                       |
|----------------------------------|-----------------------------------------------------------------------------------------------------------------------------------------------------------------------------------------------------------------------|
| <b>point</b>                     | Unit of measurement equal to 0.0139 inch. Points are always used to express type size and leading. There are 12 points to a pica and about 72 points to every inch. See also pica.                                    |
| <b>point size</b>                | Height of character set from the top of its ascenders to the bottom of its descenders in units (points). Point size does not always include leading.                                                                  |
| <b>portrait page orientation</b> | Orientation of print lines or the top of an illustration parallel to the short edge of the paper if the sheet is within the standard size range. Sheets larger than standard have the reverse print orientation.      |
| <b>printer</b>                   | Output device that produces hardcopy printouts. Also referred to as the IOT.                                                                                                                                          |
| <b>print file</b>                | Position of the system disk memory (up to 4 MB) received for temporary storage of formatted pages for printing. Pages are retained until they are delivered to the output tray.                                       |
| <b>printout</b>                  | Informal expression referring to almost anything printed by a computer peripheral device.                                                                                                                             |
| <b>process</b>                   | 1. To perform a systematic sequence of operations, such as add, edit, delete. 2. To produce a specific result by manipulating data.                                                                                   |
| <b>program</b>                   | Complete set of instructions in language compatible with the device to be used. A program directs a system to perform each operation at the right time in the proper sequence.                                        |
| <b>programmer</b>                | Person involved in designing, writing, and testing computer programs.                                                                                                                                                 |
| <b>prompt</b>                    | Message or symbol displayed on a system console requiring the operator to take action.                                                                                                                                |
| <b>proportional font</b>         | Font containing characters that vary in width. See also fixed font.                                                                                                                                                   |
| <b>proportional spacing</b>      | Text in which each alphanumeric character is given a weighted amount of space. Such output has print-like appearance. Proportional spacing allows more space for wide characters and less space for narrow characters |
| <b>proportional type</b>         | Characters that vary in width.                                                                                                                                                                                        |
| <b>protocol</b>                  | Formal set of conventions governing the format of data and the control of information exchange between two communication devices.                                                                                     |

|                        |                                                                                                                                                                                                                                                      |
|------------------------|------------------------------------------------------------------------------------------------------------------------------------------------------------------------------------------------------------------------------------------------------|
| <b>purge</b>           | To delete data from a system.                                                                                                                                                                                                                        |
| <b>queue</b>           | List of documents waiting to be processed.                                                                                                                                                                                                           |
| <b>RAM</b>             | random access memory. Storage that allows data, such as documents, to be stored and retrieved directly by address location without reading through any other data.                                                                                   |
| <b>raster data</b>     | Binary data, usually consisting of dots arranged in scan lines, according to the print order.                                                                                                                                                        |
| <b>rasterization</b>   | Creation of a page's bit map image for printing.                                                                                                                                                                                                     |
| <b>read/write head</b> | Input/output device that reads and writes data in the form of magnetic dots on the surface of an external storage medium, such as a magnetic disk.                                                                                                   |
| <b>record</b>          | Collection of data or words treated as a unit.                                                                                                                                                                                                       |
| <b>recovery</b>        | Act of overcoming a problem or error during processing. Typically, a specialized software recovery routine gains control and attempts to resolve the error without crashing the system.                                                              |
| <b>remote access</b>   | Access to a central computer by terminals or devices geographically separated from that computer.                                                                                                                                                    |
| <b>replace</b>         | Process of exchanging one portion of text for another. This process encompasses two functions: deleting old text and inserting new.                                                                                                                  |
| <b>report</b>          | In setting a separation boundary through the Bin Full Criteria task, report refers to a subset of a job (a job may consist of one or more reports).                                                                                                  |
| <b>resolution</b>      | Number of dots per unit. The LPS imaging system converts a character from digitized data into a printed image composed of these tiny dots. The greater the number of dots per inch, that is, the resolution, the clearer the image that is produced. |
| <b>RIP</b>             | raster image processor. LPS option that supports the Interpress V3.0 Publications Set.                                                                                                                                                               |
| <b>ROM</b>             | read-only memory. Solid-state memory for programs. It cannot be rewritten.                                                                                                                                                                           |
| <b>save</b>            | To store programs, data, or text for retrieval at a later time.                                                                                                                                                                                      |
| <b>scale</b>           | To adjust font or image size according to given proportions.                                                                                                                                                                                         |

---

|                          |                                                                                                                                                                                                                                                                                                               |
|--------------------------|---------------------------------------------------------------------------------------------------------------------------------------------------------------------------------------------------------------------------------------------------------------------------------------------------------------|
| <b>scroll</b>            | Manipulation of a display to bring upper or lower portions of a document page into view when no space is available for the entire document at once.                                                                                                                                                           |
| <b>scroll bar</b>        | Part of a window that allows you to view information extending beyond the window display.                                                                                                                                                                                                                     |
| <b>SCSI</b>              | small computer system interface. Accepted standard for connecting peripheral devices to computers.                                                                                                                                                                                                            |
| <b>secondary storage</b> | Form of storage external to a system, such as magnetic tapes or floppy disks.                                                                                                                                                                                                                                 |
| <b>security</b>          | 1. Procedure for limiting access to the system resources, programs, or files, to authorized personnel. 2. Protecting programs and files from unintentional or undesired modification.                                                                                                                         |
| <b>SEF</b>               | short-edge feed. The movement of paper through the printer in the direction of the paper width (the shorter side of a sheet of paper). For the DocuPrint 180 LPS, short-edge feed allows larger sizes of paper (up to 11 by 17 inches/279 by 432 mm) to be printed.                                           |
| <b>sequential</b>        | In numeric sequence, usually in ascending order. As applied to a file organization, describes files in which records are written one after another and cannot be randomly accessed. For example, the first 99 records in a sequential file-access file have to be read before the 100th record is accessible. |
| <b>set</b>               | In setting a separation boundary through the Bin Full Criteria task, set refers to multiple copies of the same report.                                                                                                                                                                                        |
| <b>simplex printing</b>  | Printing on one side of the page. See also duplex printing.                                                                                                                                                                                                                                                   |
| <b>software</b>          | Programs, including operating systems, procedures, utilities, and applications programs, written for a system. Software can be supplied by the hardware manufacturer or other firms but does not include programs written by the user.                                                                        |
| <b>sort</b>              | To rearrange data records according to a particular item (field) which they all contain, using a predetermined ordering scheme.                                                                                                                                                                               |
| <b>source</b>            | Terminal node at which data enters a network. For example, a computer transmitting data through telecommunication lines to several other computers or receiving terminals.                                                                                                                                    |
| <b>source file</b>       | File containing source language statements or commands.                                                                                                                                                                                                                                                       |
| <b>source language</b>   | Language, high-level or low-level, used by a programmer. A source language must be converted by a compiler to machine language for the instructions to be executed.                                                                                                                                           |

|                           |                                                                                                                                                                                                                                                                                                    |
|---------------------------|----------------------------------------------------------------------------------------------------------------------------------------------------------------------------------------------------------------------------------------------------------------------------------------------------|
| <b>source program</b>     | Program written in source language                                                                                                                                                                                                                                                                 |
| <b>space</b>              | Blank area between words, recognized as a character by word and data processing systems.                                                                                                                                                                                                           |
| <b>special processing</b> | Commands allowing the user to process special reports, such as printing certain records, or printing on special paper.                                                                                                                                                                             |
| <b>spooling</b>           | Process of releasing data from main memory and storing it temporarily until a peripheral device is ready to accept it, for example storing text before sending it to a printer.                                                                                                                    |
| <b>spot</b>               | Unit of measurement representing a fraction of an inch, for example, 300 spots per inch (spi). May also be referred to as a picture element (pixel) or dot.                                                                                                                                        |
| <b>statement</b>          | Detailed written instructions in a program step. A statement is written according to specific rules called syntax.                                                                                                                                                                                 |
| <b>static data</b>        | Information usually found on preprinted forms or overlays.                                                                                                                                                                                                                                         |
| <b>stock</b>              | User-defined name in the JSL that specifies a certain type of paper for printing a job. See also cluster.                                                                                                                                                                                          |
| <b>stockset</b>           | Collection of stocks to be used on a print job. See also stock; cluster.                                                                                                                                                                                                                           |
| <b>storage</b>            | Retention of information. Primary storage refers to internal storage where data and program instructions pertinent to current operations/jobs are held. Auxiliary storage refers to external media, such as disks or tapes, for use at a later time.                                               |
| <b>string</b>             | Connected sequence of alphanumeric characters treated as one unit of data by a program.                                                                                                                                                                                                            |
| <b>symbol</b>             | Character used in a computer language to specify a particular function.                                                                                                                                                                                                                            |
| <b>synchronous</b>        | Efficient encoding of data suitable for high-speed, block-oriented data transmission by using equal time elements.                                                                                                                                                                                 |
| <b>syntax</b>             | Rules governing the structure of expressions in a programming language.                                                                                                                                                                                                                            |
| <b>syntax error</b>       | System response to a mistake in a command entry.                                                                                                                                                                                                                                                   |
| <b>system</b>             | 1. In data processing, a collection of parts and procedures organized to accomplish a set of specific functions. 2. Assembly of components united by some form of regulated interaction to form an organized whole. 3. Operations or procedures through which a business activity is accomplished. |



---

|                           |                                                                                                                                                                                                                                                                                                                |
|---------------------------|----------------------------------------------------------------------------------------------------------------------------------------------------------------------------------------------------------------------------------------------------------------------------------------------------------------|
| <b>system controller</b>  | Part of the LPS that provides interfacing capability, data handling, formatting, buffering, and operator control for the system. Also referred to as the "ESS".                                                                                                                                                |
| <b>system disk</b>        | Magnetic disk storage medium, usually of large capacity, that is not removable as opposed to floppy disk or disk packs.                                                                                                                                                                                        |
| <b>system file</b>        | Master software program that keeps all components working together.                                                                                                                                                                                                                                            |
| <b>system generation</b>  | Process whereby the system is made ready to operate. Typically involves selecting the operative parameters and activating the relevant software.                                                                                                                                                               |
| <b>system page</b>        | Maximum area in which text and graphics can be imaged on a printing system.                                                                                                                                                                                                                                    |
| <b>system software</b>    | Software programs that support and/or control system functions by governing hardware operation and input/output processes, interpreting source programs and breaking them down into machine language, distributing tasks among various processors, and so on.                                                  |
| <b>tab</b>                | To move the cursor on a display or printer to a prespecified column on the display or paper, most often by using the <TAB> key on a keyboard.                                                                                                                                                                  |
| <b>tape</b>               | Recording media for data or computer programs. Tape can be in permanent form, such as perforated paper tape. Generally, tape is used as a mass storage medium in magnetic form and has a far higher storage capacity than disk storage, but it takes longer to write or recover data from tape than from disk. |
| <b>tape density</b>       | The number of characters that can be stored on magnetic media, such as how close together data can be recorded. The Xerox LPS may use either 1600 bpi or 6250 bpi density magnetic media.                                                                                                                      |
| <b>tape drive</b>         | Input/output device that controls the movement of magnetic storage tape past the read/write head while data is accessed or stored.                                                                                                                                                                             |
| <b>task</b>               | 1. Any major job performed by a computer. 2. One of several programs being executed by a system.                                                                                                                                                                                                               |
| <b>telecommunications</b> | Voice or data communications transmitted and received through telephone lines.                                                                                                                                                                                                                                 |
| <b>teleprocessing</b>     | Sending and receiving data through telecommunication lines for processing among various remote terminals and the central processing unit (CPU).                                                                                                                                                                |

|                               |                                                                                                                                                                                                                                                                                                       |
|-------------------------------|-------------------------------------------------------------------------------------------------------------------------------------------------------------------------------------------------------------------------------------------------------------------------------------------------------|
| <b>TEM</b>                    | terminal emulation mode. The processing method of the PC UI which features a character display and the operator's use of the keyboard. The mouse, windows, and icons are inactive in this mode. The PC UI operates in either the TEM mode or in the object mode. See also object mode.                |
| <b>terminal</b>               | Device equipped with a keyboard and connected to a computer or a network                                                                                                                                                                                                                              |
| <b>testing</b>                | 1. Process of running a program for the express purpose of discovering any errors it may contain. 2. For computer-oriented systems, the process of verifying a system's ability to meet performance objectives in a simulated environment or validating its actual performance in a live environment. |
| <b>text</b>                   | In communications, the content portion of a transmitted message.                                                                                                                                                                                                                                      |
| <b>text string</b>            | Consecutive series of characters to be printed exactly as specified in a command.                                                                                                                                                                                                                     |
| <b>throughput</b>             | In data processing systems, the amount of data that can be processed, transmitted, printed, and so on, per a specified unit of time.                                                                                                                                                                  |
| <b>toggle</b>                 | To switch (alternate) from one tray to another. The system switches from an active feeder or stacker tray to an inactive one to allow continuous printing when the proper commands are invoked.                                                                                                       |
| <b>trailer</b>                | In data communications, the last portion of a message that signals the end.                                                                                                                                                                                                                           |
| <b>transaction processing</b> | Method of data processing in which files are updated and results are generated immediately after data entry.                                                                                                                                                                                          |
| <b>translation</b>            | 1. In data communications, the conversion of one code to another on a character-by-character basis. 2. In programming, the function of a language processor which converts a source program from one programming language to another.                                                                 |
| <b>transmission speed</b>     | In data communications, the rate at which data is passed through communication lines, usually measured in bits per inch (bpi).                                                                                                                                                                        |
| <b>transmit</b>               | To send data from one place to another.                                                                                                                                                                                                                                                               |
| <b>truncated</b>              | Cut off before completion, as when data transfer from a host to a printer is cut off before all data has been transmitted.                                                                                                                                                                            |
| <b>two-up</b>                 | Application that prints two logical pages on one side of a physical page.                                                                                                                                                                                                                             |

---

|                        |                                                                                                                                                                                 |
|------------------------|---------------------------------------------------------------------------------------------------------------------------------------------------------------------------------|
| <b>typeface</b>        | 1. All type of a single design. 2. Set of characters with design features that make them similar to one another.                                                                |
| <b>type size</b>       | Height of a typeface, measured from the bottom of its descenders to the top of its ascenders, expressed in points.                                                              |
| <b>type style</b>      | Italic, condensed, bold, and other variations of typeface that form a type family.                                                                                              |
| <b>UCS</b>             | Universal Character Set. Printer feature that permits the use of a variety of character                                                                                         |
| <b>upload</b>          | To copy files from a remote peripheral device to a host. LPS files are not copied to the host because one of the LPS functions is to store files for the host.                  |
| <b>utility program</b> | General-purpose program that performs activities, such as initializing a disk or sorting, which are not specific to any application.                                            |
| <b>validation</b>      | Process of testing a system's ability to meet performance objectives by measuring and monitoring its performance in a live environment.                                         |
| <b>variable</b>        | Information of a changeable nature which is merged with a standard or a repetitive document to create specialized or personalized versions of that document.                    |
| <b>variable data</b>   | Variable data is not a part of a form design. It varies from page to page.                                                                                                      |
| <b>variable text</b>   | Text of changing nature, such as various names and addresses combined with a form letter to make a complete document.                                                           |
| <b>virtual page</b>    | Page area selected by a forms designer for printing.                                                                                                                            |
| <b>warning message</b> | System-issued message indicating that an error has been encountered even though the program has not failed.                                                                     |
| <b>weight</b>          | Characteristic of type determined by how light or dark it appears.                                                                                                              |
| <b>wildcard</b>        | Part of a command (* symbol, / symbol, ? symbol) that represents a category for which the possible options are requested.                                                       |
| <b>wildcarding</b>     | In a command, calling out a general category rather than a specific item within that category. The purpose of wildcarding is to generate the options within the given category. |
| <b>window</b>          | In the PC UI, the graphic display object that allows you to select options and enter information.                                                                               |

|                           |                                                                                                                                                                    |
|---------------------------|--------------------------------------------------------------------------------------------------------------------------------------------------------------------|
| <b>write</b>              | To record data in memory or an external storage medium.                                                                                                            |
| <b>write protection</b>   | Data protection feature implemented on magnetic media (for example floppy disk, 9-track tape) to prevent stored data from being modified, written over, or erased. |
| <b>x axis</b>             | Horizontal axis on a forms grid.                                                                                                                                   |
| <b>x dot</b>              | Unit of measurement representing a fraction of an inch. It may also be referred to as a picture element (pixel) or spot, for example, 1/600 spots per inch (spi).  |
| <b>xerographic engine</b> | Component of a printer that develops an image, transfers it to paper, and fuses it for output as hardcopy.                                                         |
| <b>x height</b>           | Height of lowercase letters without their ascenders or descenders (height of letter "x"). See also ascender; descender.                                            |
| <b>y axis</b>             | Vertical axis on a forms grid                                                                                                                                      |
| <b>ACT</b>                | Advanced Customer Training                                                                                                                                         |
| <b>AFP</b>                | Advanced Function Printing                                                                                                                                         |
| <b>ANSI</b>               | American National Standards Institute                                                                                                                              |
| <b>ASCII</b>              | American Standard Code for Information Interchange                                                                                                                 |
| <b>BCD</b>                | binary coded decimal                                                                                                                                               |
| <b>BOF</b>                | bottom of form                                                                                                                                                     |
| <b>BOT</b>                | beginning of tape                                                                                                                                                  |
| <b>bpi</b>                | bits per inch                                                                                                                                                      |
| <b>bps</b>                | bits per second                                                                                                                                                    |
| <b>BSC</b>                | binary synchronous communications                                                                                                                                  |
| <b>CD</b>                 | character dispatcher                                                                                                                                               |
| <b>CDC</b>                | control data communications                                                                                                                                        |
| <b>CD/IG</b>              | character dispatcher/image generator                                                                                                                               |

---

|               |                                                                 |
|---------------|-----------------------------------------------------------------|
| <b>CM</b>     | control module                                                  |
| <b>CME</b>    | copy modification entry                                         |
| <b>cpi</b>    | characters per inch                                             |
| <b>CPU</b>    | central processing unit                                         |
| <b>CR</b>     | carriage return                                                 |
| <b>DCE</b>    | data communications equipment                                   |
| <b>DDCMP</b>  | Digital Data Communication Message Protocol                     |
| <b>DEC</b>    | Digital Equipment Corporation                                   |
| <b>DFA</b>    | Document Feeding and Finishing Architecture                     |
| <b>DJDE</b>   | dynamic job descriptor entry                                    |
| <b>DMR</b>    | data mode ready (DEC interface for LPS)                         |
| <b>DOS</b>    | disk operating system                                           |
| <b>dpi</b>    | dots per inch                                                   |
| <b>DSDD</b>   | double sided double density                                     |
| <b>DSU</b>    | digital signal unit                                             |
| <b>DSR</b>    | disk save and restore                                           |
| <b>DSSD</b>   | double sided single density                                     |
| <b>DTE</b>    | data terminal equipment                                         |
| <b>EBCDIC</b> | Extended Binary Coded Decimal Interchange Code                  |
| <b>ENET</b>   | Ethernet network                                                |
| <b>EOT</b>    | end of tape                                                     |
| <b>EP</b>     | electronic publishing                                           |
| <b>ESS</b>    | electronic subsystem, also referred to as the system controller |

|             |                                             |
|-------------|---------------------------------------------|
| <b>FCB</b>  | forms control buffer                        |
| <b>FCG</b>  | finishing configuration utility             |
| <b>FCP</b>  | file control parameter                      |
| <b>FDL</b>  | forms description language                  |
| <b>FDR</b>  | file directory                              |
| <b>FFM</b>  | font file management                        |
| <b>FIS</b>  | Font Interchange Standard                   |
| <b>FMS</b>  | file management subsystem                   |
| <b>FPS</b>  | formatting print service                    |
| <b>FSL</b>  | forms source library                        |
| <b>FST</b>  | font specification table                    |
| <b>GCR</b>  | group code recording                        |
| <b>gsm</b>  | grams per square meter                      |
| <b>HCF</b>  | high-capacity feeder                        |
| <b>HCS</b>  | high-capacity stacker                       |
| <b>HFDL</b> | host forms description language             |
| <b>HIP</b>  | Host Interface Processor                    |
| <b>hpos</b> | horizontal positioning                      |
| <b>IBM</b>  | International Business Machines Corporation |
| <b>IFU</b>  | Interpress font utility                     |
| <b>IG</b>   | image generator                             |
| <b>IGM</b>  | image generator module                      |
| <b>I/O</b>  | input/output                                |

---

|                |                                                                                                           |
|----------------|-----------------------------------------------------------------------------------------------------------|
| <b>IOM</b>     | image output module                                                                                       |
| <b>IOT</b>     | input output terminal, also referred to as "printer"                                                      |
| <b>IPD</b>     | Interpress decomposer                                                                                     |
| <b>IPFONTS</b> | Interpress fonts                                                                                          |
| <b>IPL</b>     | initial program load                                                                                      |
| <b>IPM</b>     | Interpress mapping                                                                                        |
| <b>ips</b>     | inches per second                                                                                         |
| <b>JCB</b>     | job control block                                                                                         |
| <b>JCL</b>     | job control language                                                                                      |
| <b>JDE</b>     | job descriptor entry                                                                                      |
| <b>JDL</b>     | job descriptor library                                                                                    |
| <b>JID</b>     | job identifier                                                                                            |
| <b>JSL</b>     | job source library                                                                                        |
| <b>LAN</b>     | local area network                                                                                        |
| <b>laser</b>   | light amplification by stimulated emission of radiation                                                   |
| <b>LED</b>     | light-emitting diode                                                                                      |
| <b>LEF</b>     | long-edge feed                                                                                            |
| <b>LF</b>      | long-edge feed                                                                                            |
| <b>lpi</b>     | lines per inch                                                                                            |
| <b>LPS</b>     | Laser Printing System                                                                                     |
| <b>MTU</b>     | magnetic tape unit (refers to the 9-track magnetic tape drive; also referred to as "magnetic tape drive") |
| <b>OCR</b>     | optical character recognition                                                                             |

|               |                                        |
|---------------|----------------------------------------|
| <b>OCS</b>    | operator communications subsystem      |
| <b>OLI</b>    | online interface                       |
| <b>OS</b>     | operating system                       |
| <b>OSDS</b>   | operating system diagnostic software   |
| <b>OSEXEC</b> | operating system executive             |
| <b>OSS</b>    | operating system software              |
| <b>PC</b>     | personal computer                      |
| <b>PCC</b>    | printer carriage control               |
| <b>PC UI</b>  | personal computer user interface       |
| <b>PDL</b>    | print description language             |
| <b>PE</b>     | phase encoded                          |
| <b>ppm</b>    | pages per minute                       |
| <b>PQA</b>    | print quality adjustment               |
| <b>PROM</b>   | programmable read-only memory          |
| <b>PSC</b>    | printer subsystem controller           |
| <b>pt</b>     | point                                  |
| <b>PWBA</b>   | printed wiring board assembly          |
| <b>QIC</b>    | 1/4 inch cartridge                     |
| <b>RAM</b>    | random access memory                   |
| <b>RIP</b>    | raster image processor                 |
| <b>ROS</b>    | raster output scanner                  |
| <b>SAFES</b>  | stand-alone field engineering software |
| <b>SAN</b>    | software analysis number               |



---

|               |                                 |
|---------------|---------------------------------|
| <b>sci</b>    | START command index             |
| <b>SCSI</b>   | small computer system interface |
| <b>SDLC</b>   | synchronous data link control   |
| <b>SEF</b>    | short-edge feed                 |
| <b>SFS</b>    | status file services            |
| <b>SIF</b>    | sequence insert file            |
| <b>SNA</b>    | system network architecture     |
| <b>spi</b>    | spots per inch                  |
| <b>SST</b>    | system software tape            |
| <b>sysgen</b> | system generation               |
| <b>TL/DL</b>  | text line/display list          |
| <b>TOF</b>    | top of form                     |
| <b>tpi</b>    | tracks per inch                 |
| <b>TPJ</b>    | test pattern job                |
| <b>TXC</b>    | total xerographic convergence   |
| <b>UCS</b>    | Universal Character Set         |
| <b>UCSB</b>   | Universal Character Set Buffer  |
| <b>UI</b>     | user interface                  |
| <b>VM</b>     | virtual memory                  |
| <b>vpos</b>   | vertical positioning            |
| <b>VS</b>     | virtual storage                 |
| <b>WAN</b>    | wide area network               |
| <b>XCSC</b>   | Xerox Customer Support Center   |

|                  |                                               |
|------------------|-----------------------------------------------|
| <b>XDGI</b>      | Xerox DCF and GDDM Interface                  |
| <b>XDSS</b>      | Xerox Documentation and Software Services     |
| <b>XICS</b>      | Xerox Integrated Composition System           |
| <b>XJCF</b>      | Xerox Job Control Facility                    |
| <b>XMP</b>       | xerographic mode persistence                  |
| <b>XMS</b>       | xerographic mode switching                    |
| <b>XPAF, XPF</b> | Xerox Printer Access Facility                 |
| <b>XPMF-VMS</b>  | Xerox Print Management Facility - VMS Version |
| <b>XPPI</b>      | Xerox Pen Plotter Interface                   |
| <b>XPS</b>       | Xerox Publishing System                       |

## Free Manuals Download Website

<http://myh66.com>

<http://usermanuals.us>

<http://www.somanuals.com>

<http://www.4manuals.cc>

<http://www.manual-lib.com>

<http://www.404manual.com>

<http://www.luxmanual.com>

<http://aubethermostatmanual.com>

Golf course search by state

<http://golfingnear.com>

Email search by domain

<http://emailbydomain.com>

Auto manuals search

<http://auto.somanuals.com>

TV manuals search

<http://tv.somanuals.com>