

XEROX

WorkCentre Pro 423/428

Printer User Guide

708P86637



THE DOCUMENT COMPANY
XEROX[®]



Prepared and translated by:
The Document Company Xerox
GKLS European Operations
Bessemer Road
Welwyn Garden City
Hertfordshire
AL7 1HE
ENGLAND

©2001 by Xerox Corporation. All rights reserved.

Copyright protection claimed includes all forms and matters of copyrighted material and information now allowed by statutory or judicial law or hereinafter granted, including without limitations, material generated from the software programs which are displayed on the screen, such as icons, screen displays, looks etc.

Xerox[®], The Document Company[®], the digital X[®] and all Xerox products mentioned in this publication are trademarks of Xerox Corporation. Product names and trademarks of other companies are hereby acknowledged.

Changes are periodically made to this document. Changes, technical inaccuracies, and typographical errors will be corrected in subsequent editions.

Table of Contents

1	Overview of the Printer	1-1
	Getting Ready to print or fax.....	1-2
	Special features of the printer.....	1-3
	Main components and their functions.....	1-4
	Parts of the printer kit	1-4
	Front view	1-4
	Back view	1-5
	Printer control panel	1-6
	Display message	1-7
	Print screen	1-7
	Common menu screen.....	1-7
	Mode menu screen	1-8
	Power Saver Mode.....	1-8
2	Setting Up.....	2-1
	Setting Printer Environments.....	2-2
	As a local printer.....	2-2
	Using parallel interface.....	2-2
	Using USB interface	2-2
	As a network printer (Ethernet interface).....	2-3
	Windows Network (SMB)	2-3
	TCP/IP Print Utilities for Windows 95/98/Me.....	2-3
	TCP/IP (Windows NT 4.0, Windows 2000)	2-4
	TCP/IP (UNIX).....	2-4
	AppleTalk	2-5
	NetWare,	2-5
	Internet printing	2-6
	Connecting Cable	2-7
	Connecting by parallel interface	2-7
	Connecting by USB interface	2-8
	Connecting by Ethernet interface	2-10
	Using Quick Setup Menu.....	2-11
	Quick Setup menu items	2-11
	Procedure for setting the Quick Setup Menu.....	2-12
	Sequence for Setting Different Printer Environments.....	2-14
	Setting IP Address.....	2-15
	Flow of setting	2-15
	DHCP server	2-15
	Outputting Printer Settings List	2-16
	Checking Printer Settings List.....	2-16
	Setting Address	2-17
	Setting IP Address	2-17
	Setting Subnet Mask and Gateway Address.....	2-18
	Setting Port.....	2-19
	When using TCP/IP (LPD).....	2-19
	When using internet printing.....	2-19
	When using SMB.....	2-19
	When using software for managing printer remotely	2-19
	Activating port.....	2-20
	Setting the port and transport protocol	2-21

Other Printer Settings	2-22
When using TCP/IP (LPD)	2-22
When using SMB	2-22
When using IPP	2-23
Memory Allocation	2-24
Uses	2-24
Suggested values	2-24
System	2-24
Receive buffer use	2-24
Page buffer use	2-25
PCL memory use	2-25
PS memory use	2-25

3 Useful Operations.....3-1

Printing Sequence	3-2
For Windows	3-2
Printing vs Copying/Faxing	3-3
Control panel operations during printing	3-3
Printing and copying/faxing functions	3-3
Auto Tray Switch	3-3
Paper Tray Priority	3-4
Printing Priority	3-4
Printing functions during copying/faxing functions	3-4
Printing Features	3-5
Setting printing features	3-5
Properties screen	3-5
Online Help	3-6
Canceling Printing/Faxing	3-9
Canceling from computer	3-9
Using Windows	3-9
Using CentreWare Internet Services	3-9
Canceling jobs from the printer	3-10
Canceling jobs in process	3-10
Canceling all jobs in the printer	3-10
Canceling fax transmission from the touch panel display	3-11
Checking job status of print instruction	3-11
Using Windows	3-11
Using CentreWare Internet Services	3-12
Outputting	3-13
Forced outputting of remaining print data	3-13
Outputting all jobs in the printer	3-14
Printing Data Combined Using Overlays	3-16
Creating an overlay	3-16
Printing with an overlay	3-17
Printing Secure Print and Sample Print Jobs	3-19
Secure Print	3-19
Sample Print	3-19
Storing User ID and Password	3-20
Printing Secure Print/Sample Print Jobs	3-21
At the computer	3-21
At the control panel	3-21
Faxing From the Computer	3-25
Direct faxing	3-25
Entering Recipient List	3-27
Entering fax recipient information	3-28

4	Installing/Configuring the Printer Drivers	4-1
	About the Printer Drivers	4-2
	The PCL 6 printer drivers	4-2
	Installation/configuration methods	4-2
	Settings on the printer	4-2
	Installing/Uninstalling the Printer Drivers	4-3
	For a local printer	4-3
	If you click Decline in the License Agreement	4-11
	Configuring the Printer Drivers	4-12
	Accessing the printer properties dialog box	4-12
	For Windows 95/Windows 98/Windows Me	4-12
	For Windows NT 4.0/Windows 2000	4-13
	Setting the printer properties	4-14
	Printer	4-15
	Paper/Output	4-19
	Output Options	4-23
	Graphics	4-26
	Layout	4-28
	Overlays	4-33
	Watermarks	4-34
	Fax Options	4-35
5	Mode Menu and Common Menu	5-1
	Menus	5-2
	About menu	5-2
	Menu Navigation	5-3
	Mode Menu Items	5-4
	List of Mode Menu items	5-4
	PCL Settings	5-5
	Common Menu Items	5-10
	List of common menu items	5-10
	System Settings	5-15
	NetWork/Port	5-16
	Allocate Memory	5-27
	Initialize/Delete Data	5-28
	Printer Settings	5-29
	Outputting Reports/Lists	5-30
	Types of reports/lists	5-30
	PCL Settings List	5-30
	Printer Settings List	5-31
	Error History Report	5-31
	Job History Report	5-31
	Print Meter Report	5-31
	PCL Fonts List	5-32
	Stored Documents List	5-32
	PostScript Fonts List	5-32
	PostScript Logical Printer List	5-33
	Job Template List	5-33
	Domain List	5-33
	Printing reports/lists	5-34
	CentreWare Internet Services	5-35
	Structure of the CentreWare Internet Services screen	5-35
	Top panel	5-35
	Bottom panel	5-36
	Right and left frame	5-36
	System environment	5-36
	Target computers and browsers	5-36

	Target computers	5-36
	Browsers	5-36
	Configuring browser	5-37
	For Netscape Communicator	5-37
	For Internet Explorer	5-37
	Checking proxy server and port number	5-37
	Proxy server setting	5-37
	Port number setting	5-37
	Configuring the printer	5-38
	Using CentreWare Internet Services	5-39
	Checking Printer Status via E-Mail	5-40
	About Mail Notice	5-40
6	Precautions and Limitations	6-1
	In General	6-2
	When switching on/off power	6-2
	When switching on power	6-2
	When the Printer HDD kit has been installed	6-2
	When the finisher has been installed	6-3
	When the print result is different from the setting	6-3
	Setting Draft Mode	6-3
	Using optional products	6-3
	Using the printer driver for faxing	6-3
	On Using TCP/IP	6-5
	During setup	6-5
	Setting up at the printer	6-5
	Setting up at the computer/workstation	6-5
	During switching power on/off	6-5
	When LPD Spool is set to Memory (spool mode)	6-5
	When LPD Spool is set to Hard Disk (spool mode)	6-5
	When LPD Spool is set to Off (non-spool mode)	6-6
	During printing	6-6
	When LPD Spool is set to Hard Disk or Memory (spool mode)	6-6
	When LPD Spool is set to Off (non-spool mode)	6-6
7	Troubleshooting	7-1
	When Problems Occur	7-2
	When the Print Quality is Poor	7-5
	Messages	7-9
	List of messages	7-9
	Messages about error codes	7-12
	Using TCP/IP	7-17
	When using Windows 95, Windows 98, Windows Me....	7-17
	When using Windows NT 4.0	7-18
	Using CentreWare Internet Services	7-19
A	Appendix	Appendix-1
	Specifications	Appendix-1
	Product specifications	Appendix-1
	Standard printing area	Appendix-2
B	Glossary	Glossary-1

1 *Overview of the Printer*

The following information can be found in this chapter:

- Getting ready to print or fax
- Special Features of the printer
- Main components and their functions

Getting Ready to print or fax

This section explains the procedure for setting up the printer. The flow of operations is as follows:

WARNING: Check that the printer is switched off before handling it to prevent electric shock.

Connect the cable and allocate memory. See *"Connecting Cable"* on page 2-7. and *"Memory Allocation"* on page 2-24.

Carry out the necessary installation on the computer. The printer control panel also needs to be set.

See *"Chapter 4 Installing/Configuring the Printer Drivers"*

When the printer is used via a network, it is necessary to adjust the settings on the different types of servers and the printer control panel.

See the *"Network Print Environment User Guide"* (Network.pdf) on the Customer Documentation CD-ROM regarding these settings.

NOTE: It is suggested that the memory be increased.

Special features of the printer

This printer kit can be used as a network-compatible printer that can be connected directly to the network.

It can be installed with multi-emulation.

The special features of the printer are as follows:

- It is installed with PCL emulation. PostScript emulation is an optional feature.
- Printing can be specified without taking into consideration the printer language as there is an automatic printer language detection feature (applicable only when more than one emulation is installed).
- High quality printing can be achieved with its 600 dpi laser-style resolution.
- Also, it comes with an image-enhancement feature which can increase resolution and produce smooth printing without any notches (equivalent to 2,400 dots per inch or dpi).
- Besides the parallel and USB interfaces, it can be used in network (multi-protocol) environment through the installation of an interface card for Ethernet.
- All the interfaces installed can receive data at the same time.
- Double-sided printing can be done by installing a duplex module.
- Multiple-copies sorting can be achieved through the electronic sorting feature (when installing the hard disk). Also, there is no need to rearrange pages as pages can be output with the printed side facing up without interrupting the page order.
- Direct faxing from the network computer can be done by using the printer with the Fax Module installed.

NOTE: Protocol is the essential communication regulation for carrying out data transmission.

Main components and their functions

This section describes the names of the various parts of the printer kit. For other parts, see "Main Components and Their Functions" of the User Guide (Copier).

Parts of the printer kit

Front view

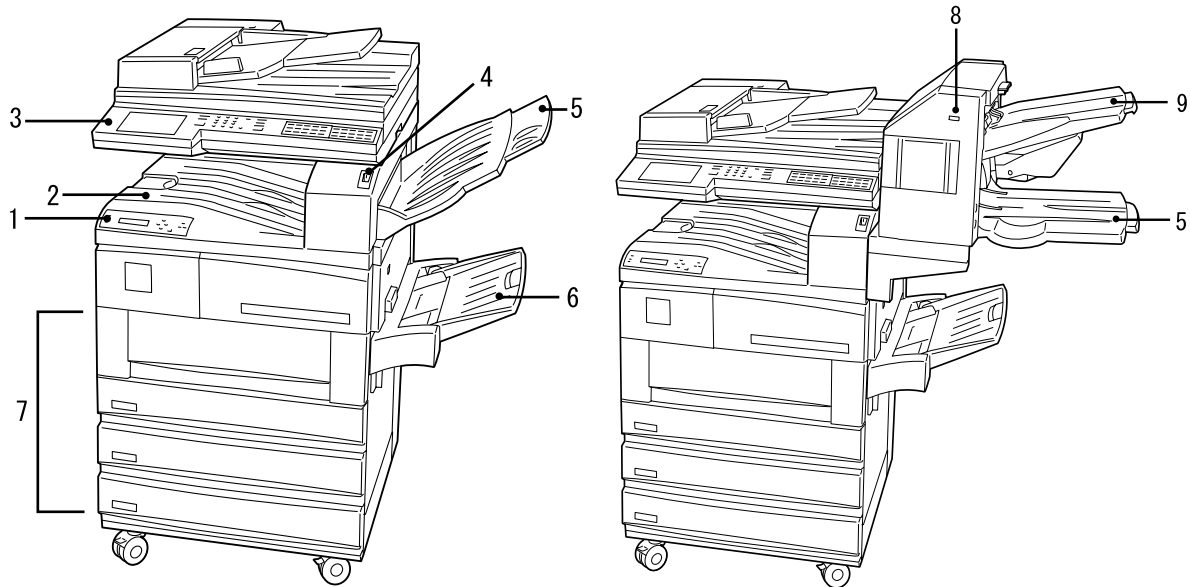

1	Printer control panel	For use of printer functions.
2	Centre output tray	For outputting printed copies, facing down.
3	Control panel	For use of copier functions. When necessary, it will also indicate that the machine is being used for printer functions.
4	Switch	For switching machine on/off.
5	Side output tray*	For outputting printed copies, facing up. When the optional finisher is installed, the lower tray of the finisher will become the side output tray.
6	Bypass tray*	For loading a paper source that cannot be loaded in paper trays, like postcard or transparency.
7	Paper trays*	For loading paper. Tray 4 is an optional kit.
8	Pause/Resume button	For retrieving paper output from the finisher.
9	Finisher tray (upper)*	For outputting printed copies when the finisher is installed. Documents output here can be stapled. Finisher is an optional kit.

* optional kit but may be installed for certain models

Back view

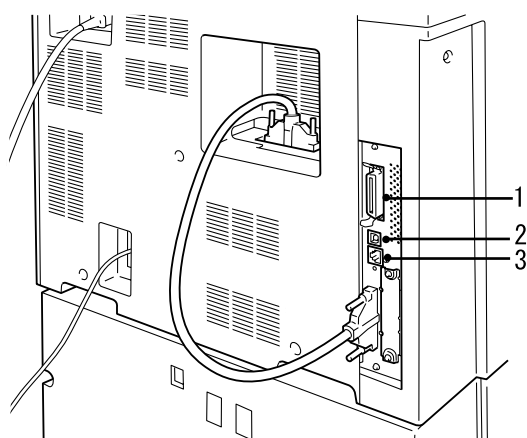





1	Parallel interface connector	For connecting this printer to a computer by a centronics/IEEE 1284-compliant interface cable.
2	USB interface connector	For connecting this printer to a computer by an USB cable.
3	Ethernet interface connector	For connecting this printer by an Ethernet interface cable.

Printer control panel

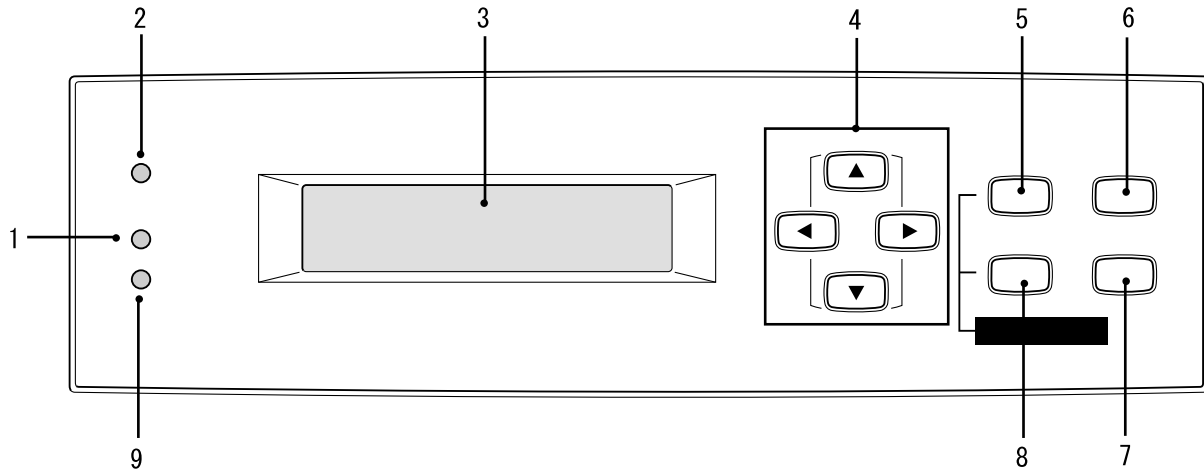
The different parts of the printer control panel are shown in the following illustration:

See “Display message” on page 1-7 for details on the messages of the display.



1	Processing indicator	When the light is on, indicates that this printer is processing print instructions.
2	Online indicator	When the light is on, indicates that this printer is ready to receive data from the computer.
3	Display	Shows settings, printer status, messages etc.
4	The up, down, right, left buttons	Press to navigate the menu, menu item, item and candidate value. In this manual, these four buttons will be displayed as  ,  ,  ,  .
5	Mode button	Press to enter the Mode menu.
6	Pause button	Press to enter the Pause state. When in the pause state, no data can be received and print instruction processed. Press again to exit the pause state.
7	Eject/Set button	Press Eject/Set to set the candidate value of the menu. Also used to print reports and lists.
8	Menu button	Press Menu to navigate to the common menu.
9	Error indicator	When the light is on, indicates that there is a machine breakdown.

Display message

The display shows messages indicating the printer and settings status, which may include the following screens.

NOTE: Depending on the optional kits installed, printer settings, and printer model, some messages may not be displayed.

Print screen

While printing or waiting for data, the display will show the print screen which indicates the printer status as well as the ongoing data processing.

As an example, the following message will be shown on the display when data has been received from the parallel port and is to be printed on paper from tray 1:

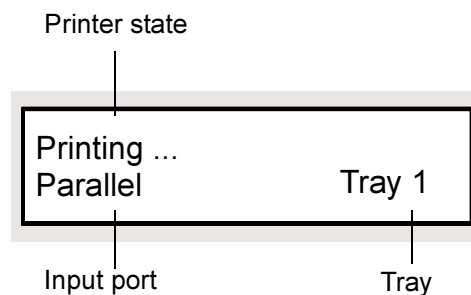

Printer state

Indicates the state of the printer. Messages include "Please wait", "Ready to print or fax", "Printing", "Canceling" and "Data wait".

See "Messages" on page 7-9.

Input port

Indicates the input port that is receiving the data. Messages include "Parallel", "IPP", "SMB", "EtherTalk", "LPD", "NetWare", "USB", "Port9100" "Salutation".

Tray

Indicates the paper tray for printing. Messages include "Tray 1", "Tray 2", "Tray 3", "Tray 4", "Bypass".

Common menu screen

The screen to set items common to all print modes.

To display the common menu screen, press **Menu**.

As an example, the screen to set Port Setting is displayed as follows:

See "Common Menu Items" on page 5-10. for details on the Common menu screen.



Mode menu screen

The screen to fix settings for emulation processing.

To display the mode menu screen, press **Mode**.

As an example, the screen to set PCL Settings is displayed as follows:



See "Mode Menu Items" on page 5-4. for details on the mode menu screen.

Power Saver Mode

When the machine is in Low power mode or Sleep mode, the touch panel display will be off and the **Power Saver** lights up.

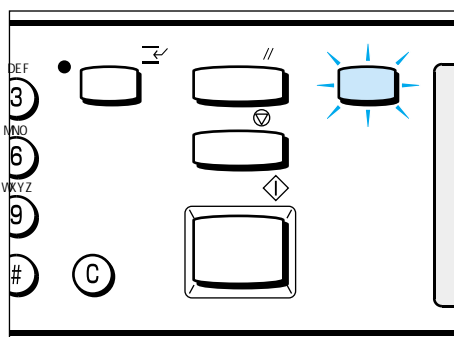

When print data is received from the computer, the machine will automatically exit the power saver mode and start processing printing. You can exit the power saver mode by pressing the illuminated **Power Saver**.

NOTE: To use the printer control panel during power saver mode, exit the mode first by pressing Power Saver.

2 *Setting Up*

The following information can be found in this chapter:

- Setting Printer Environments
- Connecting Cable
- Using Quick Setup Menu
- Flow of Setting Different Printer Environments
- Setting IP Address
- Setting Port
- Other Printer Settings
- Memory Allocation

Setting Printer Environments

This section explains the different printer environments that can be set up for the printer.

When connected to a computer directly, the printer can be used as a local printer.

When connected to a network, the printer can be used as a network printer. As this printer supports multi-protocol, it can be shared among users from different network environments.

As a local printer

Using parallel interface

Connects the printer to a computer by parallel interface for printing.

Use an IEEE1284 parallel cable.

Windows 95, Windows 98, Windows Me
Windows NT 4.0, Windows 2000

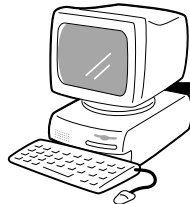

Printer

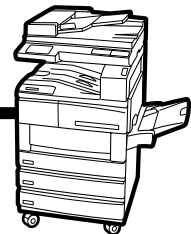

Using USB interface

Connects the printer to a computer via a USB cable for printing.

Windows 2000

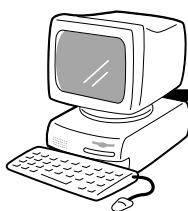

Printer

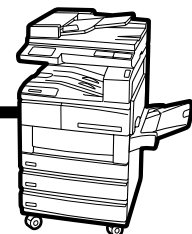

As a network printer (Ethernet interface)

Windows Network (SMB)

Server Message Block (SMB) is a protocol for sharing files or printers on Windows[®] 95, Windows[®] 98, Windows[®] Me, Windows NT[®] 4.0, and Windows[®] 2000. Using SMB, print data or settings can be sent directly to a printer on the same network (Ethernet interface) without going through the server.

As this printer supports SMB, you can print by just activating the SMB port and registering the printer on the network on each of the Windows 95, Windows 98, Windows Me, Windows NT 4.0 and Windows 2000 operating system (OS).

You can use NetBEUI and TCP/IP as the transport protocol for SMB.

Windows 95, Windows 98, Windows Me
Windows NT 4.0, Windows 2000

Printer

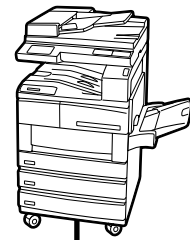
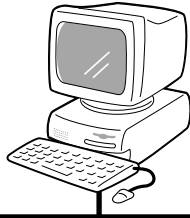

NetBEUI or TCP/IP

TCP/IP Print Utilities for Windows 95/98/Me

One of two utilities will be provided to allow print data to be sent directly from a Windows 95,98,Me computer to a printer on the same network (Ethernet interface) without going through the server.

The utilities are called Port Monitor and Direct Print and will be supplied appropriately according to global region in which you live.

As the printer supports TCP/IP (LPD) protocol, the print data can be sent directly and printed from the computer when using the utility software. You will need to set the IP address on the printer and the computer.

Windows 95, Windows 98, Windows Me

Printer

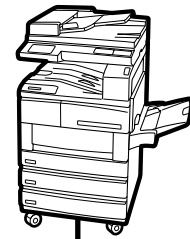
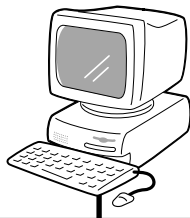

TCP/IP

TCP/IP (Windows NT 4.0, Windows 2000)

As this printer supports TCP/IP protocol, print data can be sent directly from a Windows NT 4.0, Windows 2000 computer for printing, not only using SMB but LPR as well. You will need to set the IP address on the printer and the Windows NT 4.0, Windows 2000 computer.

In Windows NT 4.0, once the printer is registered or, in Windows 2000 once the printer is shared, you can then print from Windows 95/98/Me using this printer.

Windows NT 4.0, Windows 2000

Printer



TCP/IP

TCP/IP (UNIX)

As this printer supports TCP/IP protocol, you can print from a UNIX machine. You will need to set the IP address on the printer and the UNIX machine.

See the “*Network Print Environment User Guide*” (Network.pdf) on the Customer Documentation CD-ROM for details on printing from the UNIX machine.

UNIX

Printer



TCP/IP

AppleTalk

As the printer supports AppleTalk protocol, you can print from a Macintosh using EtherTalk.

NOTE: You will need the optional PostScript Kit for using EtherTalk to print.

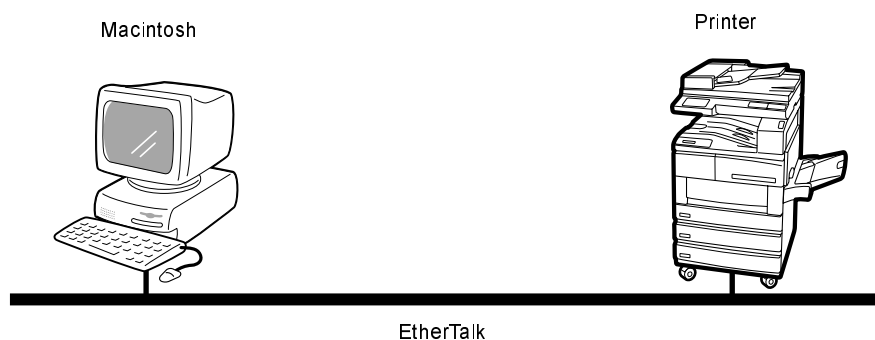

NetWare®

As a network OS, this printer supports Novell NetWare (version 3.12, 3.2, 4.11, 4.2, 5, 5.1) as well as the print server (PServer) mode only using bindery and NDS (version 4.11 and above).

In the PServer mode, the printer will be the print server and will print out jobs in the print queue. This printer uses one user licence of the file server.

You can use IPX/SPX and TCP/IP as the protocol for NetWare.

See the “*Network Print Environment User Guide*” (Network.pdf) on the Customer Documentation CD-ROM for details on using NetWare for printing.

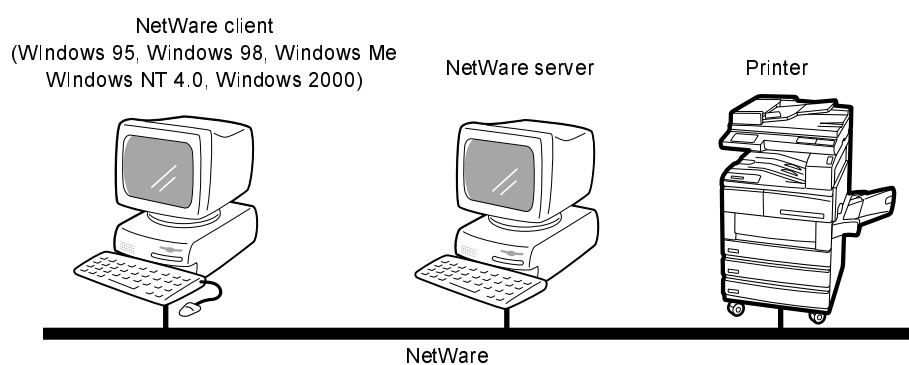

Internet printing

This printer supports Internet Printing Protocol (IPP). As Windows 2000 is installed with the client software needed to output to an IPP printer, you can specify the printer to support IPP using the Add Printer Wizard. Using IPP, you can print to a remote printer through the internet or intranet.

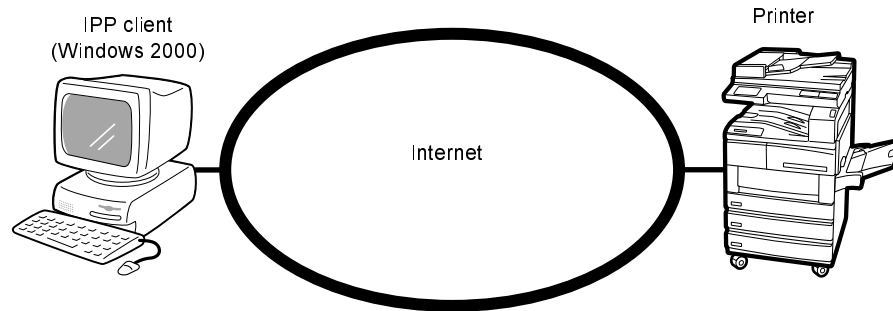

Connecting Cable

This section describes connecting by cable, to the interface of the environment to be used.

WARNING: Remember to switch off the power supply during installation to prevent electric shock.

Connecting by parallel interface

The following procedure explains how to connect by the parallel interface.

NOTE: To connect by the parallel interface, you will need the parallel interface cable. Use an IEEE1284 parallel cable.

1. Insert the interface cable connector to the parallel interface connector and secure it by the wire clips on both sides.

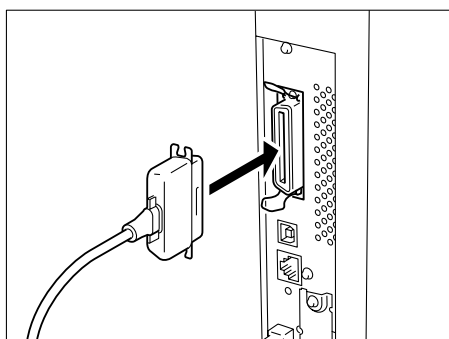

2. Connect the other end of the interface cable connector to the computer.
3. Switch on the printer.

If necessary, set the following items on the printer control panel (Network/Port > Parallel):

- Print Mode (Factory setting: Auto)
- PjL (Factory setting: Enable)
- Adobe Protocol (Factory setting: Normal)
- Auto Eject Time (Factory setting: 30 Secs)
- Bi-directional (Factory setting: Enable)

See “Common Menu Items” on page 5-10. for details on the individual item and the setting method.

NOTE: For normal use, there is no need to change the factory settings of all the items.

Connecting by USB interface

The following procedure explains how to connect by the USB interface.

NOTE: USB is supported by Windows 2000 only.

1. Insert the USB cable connector to the USB interface connector.

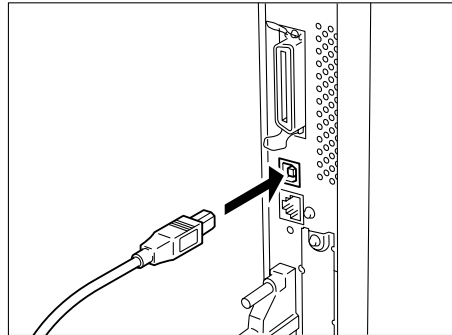

2. Connect the other end of the interface cable connector to the computer.
3. Switch on the printer.
4. On the printer control panel, set the USB Port to Enable. Proceed by following the procedure below:

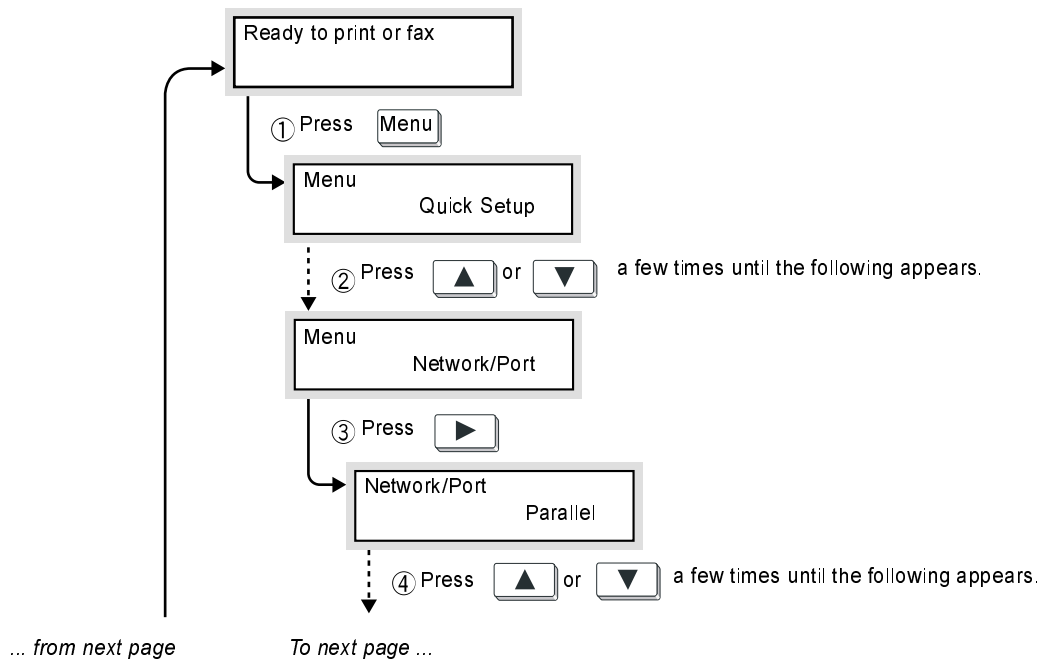

To previous page ...

... from previous page

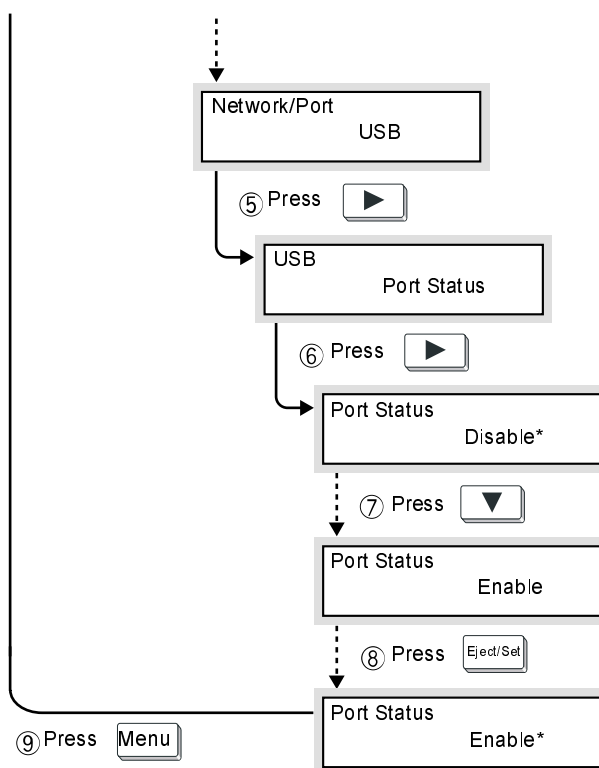

(When "Ready to print or fax" appears, the printer is ready to receive data.)

If necessary, set the following items on the printer control panel
(Network/Port > USB):

- Print Mode (Factory setting: Auto)
- PJL (Factory setting: Enable)
- Adobe Protocol (Factory setting: Normal)
- Auto Eject Time (Factory setting: 30 Secs)

See "Common Menu Items" on page 5-10. for details on the individual item and the setting method.

NOTE: For normal use, there is no need to change the factory settings of all the items.

Connecting by Ethernet interface

The Ethernet interface supports the following two types of environment:

- 100BASE-TX
- 10BASE-T

NOTE: The factory setting of Ethernet is set as Auto, enabling automatic switching to 100BASE-TX or 10BASE-T.

The following procedure explains how to connect by the Ethernet interface:

1. Insert the Ethernet interface cable connector to the interface connector.

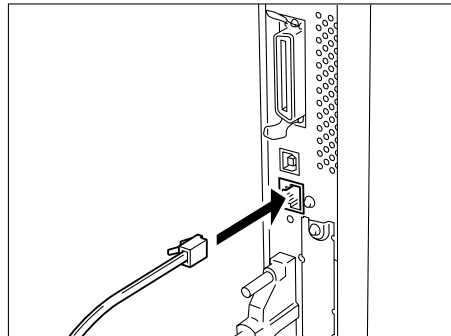

NOTE: Use only interface cable suitable for the network connection in use.

2. Switch on the printer.

You can set the Ethernet transmission speed to 10BASE-T or 100BASE-TX connector or automatically change the printer setting according to the environment in use. See “Common Menu Items” on page 5-10.

Using Quick Setup Menu

When setting up the printer environment, you can use the Quick Setup menu to set the basic necessary items all at once.

Quick Setup menu items

The following menu items can be set by the Quick Setup menu. Set each item by answering the questions displayed on the printer control panel.

Item	Remarks
Setup?	Sets whether to proceed with the Quick Setup.
Job History Auto Print	The Job History Report includes information on the latest 50 print jobs. Sets whether to print the Job History Report automatically for every 50 print jobs reached.
Set System Clock?/Set Date/Set Time	Sets the system clock which displays the date and time in the following formats: YYYY/MM/DD (year/month/date) (for years between 2000-2099 only) HH:MM (hour:minute). The date/time set will be printed in lists/reports.
Enable network? Enable SMB (Net BEUI)?/Enable SMB Spool? Enable SMB (TCP/IP)?/Enable SMB Spool? Enable LPD (TCP/IP)?/Enable LPD Spool? Enable IPP?/Enable IPP Spool? Enable Netware (IPX)? Enable Netware (TCP/IP)? Enable Port9100? Enable EtherTalk? Enable Salutation? Enable FTP Client? Enable SNMP (TCP/IP)? Enable SNMP (IPX)? Enable DHCP? Enable BOOTP? Enable RARP? IP Address Print Printer List	Sets whether to define settings for the following ports: <ul style="list-style-type: none"> SMB, LPD, IPP, NetWare, Port9100, EtherTalk Sets the port, protocol and spool setting to be used for the network environment. Salutation, FTP Client Sets these items when using the scanner feature. SNMP Sets this when using certain software, like that used for managing multiple printers remotely.
Enable Internet Service?	Sets whether to use the CentreWare Internet Services, through a web browser, to display the printer/job status and change the printer settings.

NOTE: You can also specify settings for the individual items without using the Quick Setup Menu. For items that cannot be set using the Quick Setup Menu or details on setting individual items. Refer to "Sequence for Setting Different Printer Environments" on page 2-14 and "Common Menu Items" on page 5-10.

Procedure for setting the Quick Setup Menu

Follow the procedure below to set essential settings using the printer control panel.

When using the Quick Setup Menu to change settings, select **Y** for Save Settings to save settings and reboot before printing the Printer Settings List.

NOTE: During setting up, the settings will not be valid if you press Menu.

R: Reboot; Y: Yes; N: No.

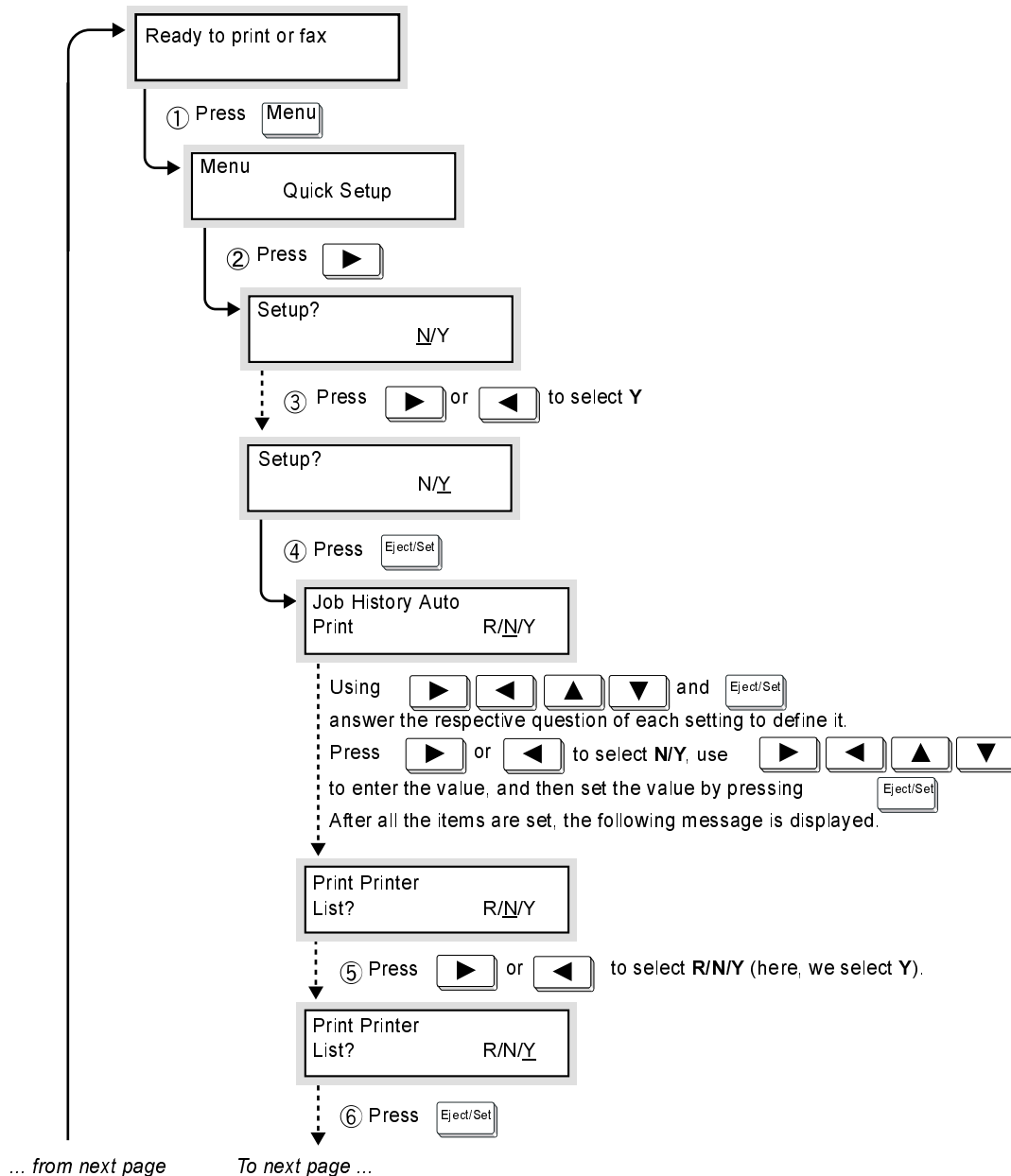

To previous page from previous page

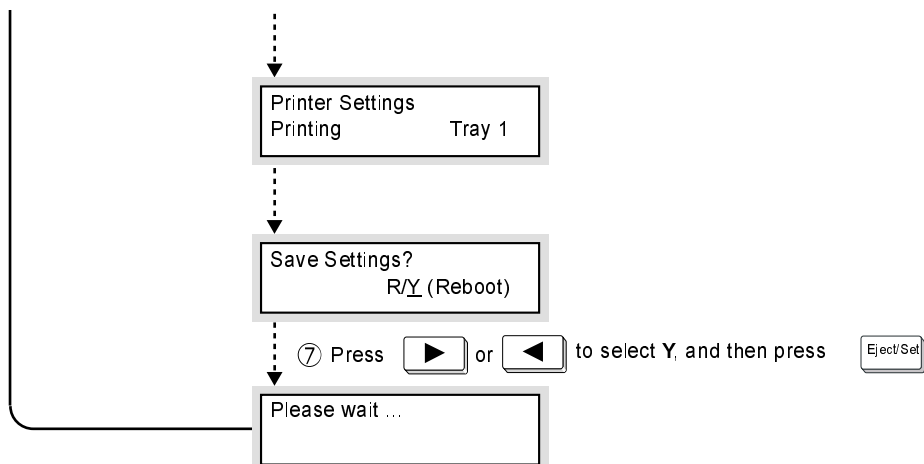

(When "Ready to print or fax" appears, the printer is ready to receive data.)

Sequence for Setting Different Printer Environments

This section explains the sequence of setting the printer environments for the different environment in use.

Check the necessary settings for the respective printer environments as you proceed by following the flow chart. When using EtherTalk, refer to the manual bundled with the PostScript Kit.

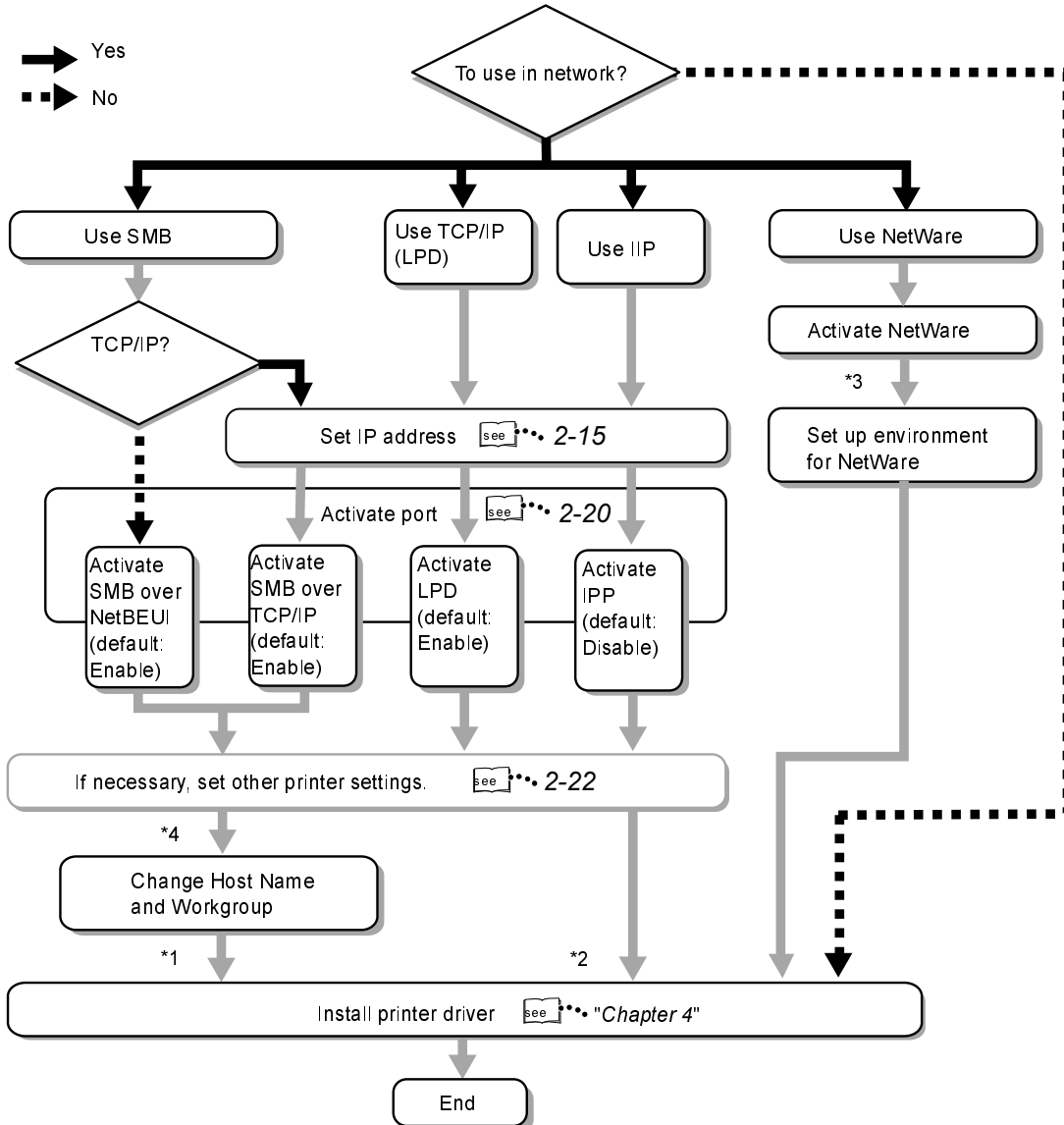

You can install the printer driver from the attached CD-ROM or download it automatically.

Refer to the Network Print Environment User Guide (Network.pdf) on the Customer Documentation CD-ROM for details on the procedure to:

- Install the printer driver when using IPP.
- Set up the environment for using NetWare.
- Change the host name and workgroup name.

Setting IP Address

This section explains how to set the *IP address*. Depending on the network environment, you may need to set the *subnet mask* and *gateway address*. If your network has a Dynamic Host Configuration Protocol (DHCP), BOOTP or RARP environment, the printer can obtain these items automatically from each of the servers.

By the factory setting, these items are obtained automatically from the DHCP server.

Use the DHCP server together with the Windows Internet Name Service (WINS) server at the same time. When using the WINS server, make settings if necessary, by selecting the following on the printer control panel: Network/Port, followed by WINS Server, and then the various items.

When using the BOOTP or RARP server, select the following on the printer control panel:

Network/Port, followed by TCP/IP Settings, Get IP Address, and then BOOTP or RARP.

Check with your system administrator if you have any queries on the BOOTP or RARP environment.

See "Common Menu Items" on page 5-10. for details on each of these items and the way to set them.

Flow of setting

When the IP address is obtained automatically from the DHCP, BOOTP or RARP server, you do not need to follow the procedure in this section to set the IP address.

When you need to set the IP address manually using the printer control panel, refer to "Setting Address" on page 2-17.

When you are unsure whether you have a DHCP server, follow the procedure below to check.

If you do not have a DHCP server, set the IP address by referring to "Setting Address" on page 2-17.

DHCP server

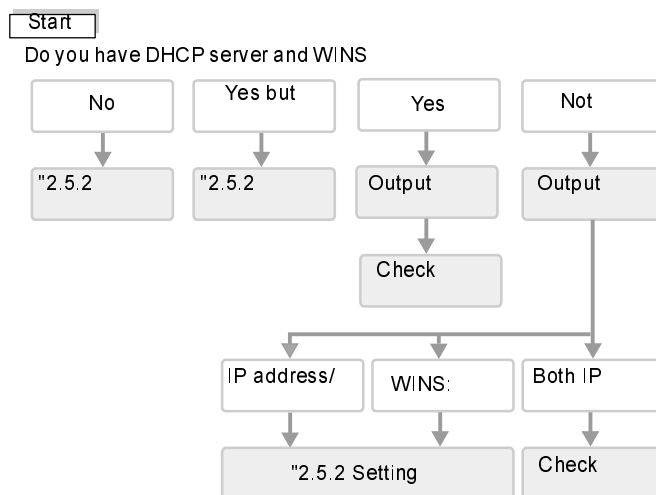

NOTE: Check with your system administrator if you have any queries on DHCP environment.

Outputting Printer Settings List

1. Print out the Printer Settings List by referring to *“Outputting Reports/Lists” on page 5-30.*
2. Check the following items under Communication Settings on the Printer Settings list:
 - TCP/IP: IP Address
 - TCP/IP: Subnet Mask
 - TCP/IP: Gateway Address
 - WINS Server: Primary Server IP Address
 - WINS Server: Secondary Server IP Address

Refer to the following section on how to check the Printer Settings List.

Checking Printer Settings List

➤ **When the addresses in TCP/IP and WINS are not obtained:**

There is no DHCP server and WINS server.

Set the IP address by referring to *“Setting Address” on page 2-17.*

➤ **When the address in TCP/IP is obtained but not in WINS:**

There is no WINS server. Do not use the DHCP environment as the printer may not be usable due to a change in the IP address allocated to the machine.

Set the IP address manually by referring to *“Setting Address” on page 2-17.*

➤ **When the addresses in both TCP/IP and WINS are obtained:**





The DHCP server and WINS server are in operation. It is recommended to use the DHCP environment. When the DHCP environment is used, the printer IP address is set by the DHCP server. The name listed in Host Name of SMB under Communication Settings in the Printer Settings List is registered in the WINS server.

Setting Address

The following procedure explains how to set the IP address from the printer control panel. Depending on the network used, you may need to set the subnet mask and gateway address. Consult your system administrator before setting the essential items. Take note that the initial display of the IP address setting might be different. If the message initially displayed is "Unable to get IP Address", proceed from Step 2 after pressing **Menu**.

Setting IP Address





1. With "Ready to print or fax" displayed, press the **Menu** button.

 to move down a column.   to move between columns.  to select an item (* shows beside item).			
Quick Setup			
Report List			
System Setting			
Network/Port	Parallel		
	LPD		
	Netware		
	SMB		
	IPP		
	USB		
	Port 9100		
	EtherTalk		
	Salutation		
	FTP Client		
	SNMP		
	Internet Service		
	TCP/IP Settings	Get IP Address	DHCP
			BOOTP
			RARP
			Manually
		IP Address	000.000.000.000

2. Set "Get IP Address" to Manually.
3. Enter the IP Address.
Use the left and right arrows to move between the numbers.
Use up and down arrows to increment or decrement the value. If you keep your finger on a button, the number will change automatically.
4. Press the **Menu** button to accept the changes and re-initialize the printer.

Setting Subnet Mask and Gateway Address

1. With "Ready to print or fax" displayed, press the ^{Menu} button.

	 		
	to move down a column.	to move between columns.	to select an item (* shows beside item).
Quick Setup			
Report List			
System Setting			
Network/Port	Parallel		
	LPD		
	Netware		
	SMB		
	IPP		
	USB		
	Port 9100		
	EtherTalk		
	Salutation		
	FTP Client		
	SNMP		
	Internet Service		
	TCP/IP Settings	Get IP Address	
		IP Address	
		Subnet Mask	000.000.000.000
		Gateway Address	000.000.000.000

2. Enter the Subnet Mask.
Use the left and right arrows to move between the numbers.
Use up and down arrows to increment or decrement the value. If you keep your finger on a button, the number will change automatically.
3. Enter the Gateway Address.
Use the left and right arrows to move between the numbers.
Use up and down arrows to increment or decrement the value. If you keep your finger on a button, the number will change automatically.
4. Press the ^{Menu} button to accept the changes and re-initialize the printer.

Setting Port

Activate the port to be used from the printer control panel.

If the settings have already been set to Enable, the procedure here is not needed. Follow the procedure here only if the settings have been set to Disable.

You can also set the port settings from CentreWare Internet Services. For details, refer to *“CentreWare Internet Services”* on page 5-35.

When using TCP/IP (LPD)

➤ (LPD) Port Status - (factory setting: Enable)

See *“Activating port”* on page 2-20. for details on activating LPD port.

When using internet printing

➤ (IPP) Port Status - (factory setting: Disable)

See *“Activating port”* on page 2-20. for details on activating IPP port.

When using SMB

➤ (SMB) Port Status - (factory setting: Enable)

➤ (SMB) Transport Protocol - (factory setting: TCP/IP, NetBEUI)

See *“Setting the port and transport protocol”* on page 2-21. for details on setting the SMB port and transport protocol.

When using software for managing printer remotely

➤ (SNMP) Port Status - (factory setting: Enable)





➤ (SNMP) Transport Protocol - (factory setting: UDP)

See *“Setting the port and transport protocol”* on page 2-21. for details on setting the SNMP agent and transport protocol.

Activating port

As an example, the following procedure explains how to activate the LPD port (factory setting: Enable) using the printer control panel. Follow the same procedure if you are activating the IPP port (factory setting: Disable).

1. With "Ready to print or fax" displayed, press the **Menu** button.

 to move down a column.   to move between columns.  to select an item (* shows beside item).			
Quick Setup			
Report List			
System Setting			
Network/Port	Parallel		
	LPD	Port Status	Disable
			Enable





2. Enable the Port Status.
3. Press the **Menu** button to accept the changes and re-initialize the printer.

Setting the port and transport protocol

As an example, the following procedure explains how to activate the SNMP port (factory setting: Enable) and transport protocol to IPX and/or UDP (factory setting: UDP).

Follow the same procedure if you want to activate the SMB port (factory setting: Enable) and transport protocol (factory setting: TCP/IP, NetBEUI).

1. With "Ready to print or fax" displayed, press the **Menu** button.

 to move down a column.   to move between columns.  to select an item (* shows beside item).			
Quick Setup			
Report List			
System Setting			
Network/Port	Parallel		
	LPD		
	Netware		
	SMB		
	IPP		
	USB		
	Port 9100		
	EtherTalk		
	Salutation		
	FTP Client		
	SNMP	Port Status	Disable
			Enable
		Transpt Protocol	UDP
			IPX
			IPX, UDP

2. Enable the Port Status.
3. Set the Transport Protocol as required.
4. Press the **Menu** button to accept the changes and re-initialize the printer.

Other Printer Settings

If necessary, use the printer control panel to define settings for the following items.

However, it is usually not necessary to change the factory settings of these items for normal use.

See "Common Menu Items" on page 5-10. for details on each item and the way of setting.

When using TCP/IP (LPD)

Network/Port > LPD

Print Mode	(factory setting: Auto)
PJL	(factory setting: Enable)
Connect Time-Out	(factory setting: 16 Secs)
TBCP Filter	(factory setting: Disable)
IP Filter	(factory setting: Off)

Allocate Memory > Buffer Size

LPD Spool	(factory setting: Off/256K)
-----------	-----------------------------

When using SMB

Network/Port > SMB

Print Mode	(factory setting: Auto)
PJL	(factory setting: Enable)
TBCP Filter	(factory setting: Disable)

Allocate Memory > Buffer Size

SMB Spool	(factory setting: Off/256K)
-----------	-----------------------------

Set the following items by using CentreWare Internet Services or changing the "config.txt" file of the printer via a Windows computer:

Workgroup	(factory setting: WORKGROUP)
Host Name	(factory setting: X-xxxxxx)

[where xxxxxx is the last six digits of the printer's Ethernet address]

Administrator Name	(factory setting: admin)
Administrator Password	(factory setting: admin)
Maximum Sessions	(factory setting: 5)
TBCP Filter	(factory setting: Disable)
Auto Driver Download	(factory setting: Enable)
Unicode Support	(factory setting: Disable)
Auto Master Mode	(factory setting: On)

Encrypt Password (factory setting: On)

See "CentreWare Internet Services" on page 5-35. for details on operating CentreWare Internet Services

See the "Network Print Environment User Guide" (Network.pdf) on the Customer Documentation CD-ROM for details on "config.txt" file.

When using IPP

Network/Port > IPP

Print Mode	(factory setting: Auto)
PJL	(factory setting: Enable)
TBCP Filter	(factory setting: Disable)
Access Control	(factory setting: Disable)
DNS	(factory setting: Enable)
Add Port No.	(factory setting: 80)
Connect Time-Out	(factory setting: 60 Secs)

Allocate Memory > Buffer Size

IPP Spool	(factory setting: Off/256K)
-----------	-----------------------------

Memory Allocation

This sections explains how to allocate memory.

Uses

Memory is meant for the following uses:

- System
- Receive buffer
- Page buffer
- PCL memory
- PS memory

Besides page buffer, you can allocate memory using the printer control panel or the CentreWare Internet Services. The memory allocated will become effective after the power has been switched off and then on again (or after the system has been rebooted).

See *“Common Menu Items”* on page 5-10. for details on each of the memory and the way to set these on the printer control panel.

See *“CentreWare Internet Services”* on page 5-35. for details on using CentreWare Internet Services

Suggested values

System

Area used by the printer system, with the capacity remaining unchanged.

Receive buffer use

A receive buffer is prepared for each of the multiple ports in order to receive data from the ports. The following receive buffers can be set:

- Parallel buffer
- SMB spool
- LPD spool
- IPP spool
- NetWare Memory
- EtherTalk Memory
- USB Memory
- Port9100 Memory

It is recommended to stop unused ports, and allocate memory for other uses.

For the NetWare Memory, the default value is usually sufficient.

For the EtherTalk Memory, it is recommended that as many areas are maintained as possible. You will need to install the optional PostScript Kit to set this.

Page buffer use

Area for drawing the actual print image. It is possible to allocate this area from the remaining area after all the other uses have been allocated. To confirm the page buffer capacity, print the Printer Settings List and then check the page buffer capacity. If the page buffer is too small, it will affect the performance and two-sided printing may be rejected.

PCL memory use

Area for the use of PCL. This memory is to store the interim data for creating the print image. By increasing the memory capacity, the printing speed may be increased. The memory capacity is 2.50 to 32.00 Mbytes in increments of 0.25 Mbytes. The default is 5.00 Mbytes.

PS memory use

Area for the use of PS. The optional PostScript Kit needs to be installed to set this memory size.

3 *Useful Operations*

The following information can be found in this chapter:

- Printing Sequence
- Printing vs Copying/Faxing
- Printing Features
- Canceling Printing/Faxing
- Outputting
- Printing Data Combined Using Overlays
- Printing Secure Print and Sample Print Jobs
- Faxing From the Computer

Printing Sequence

For Windows

The basic flow of printing from Windows environment is as follows:
(This may differ depending on the computer and system configuration used.)

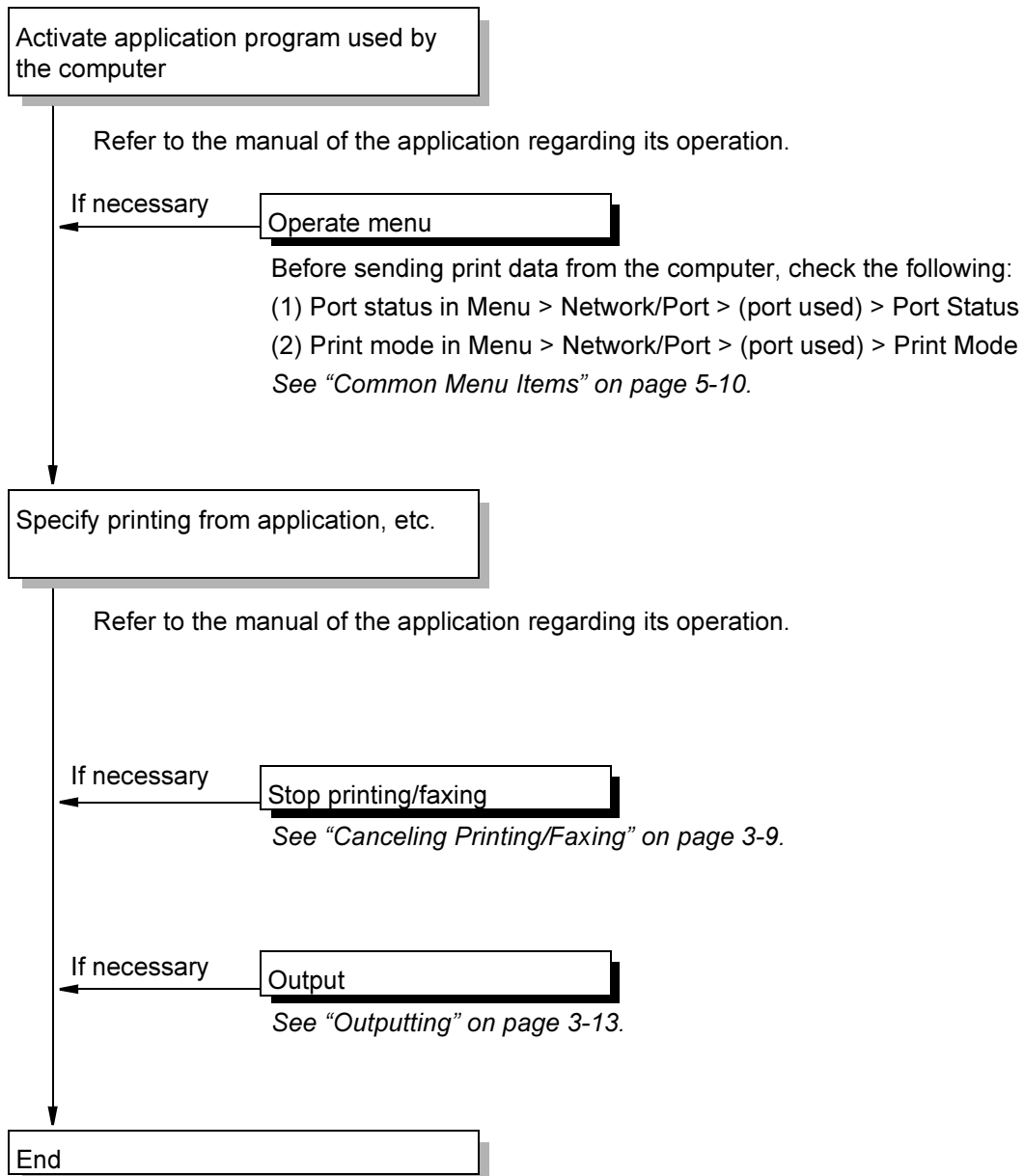

Printing vs Copying/Faxing

Control panel operations during printing

The touch panel display of the *control panel* (not *printer control panel*) during printing will be as follows:

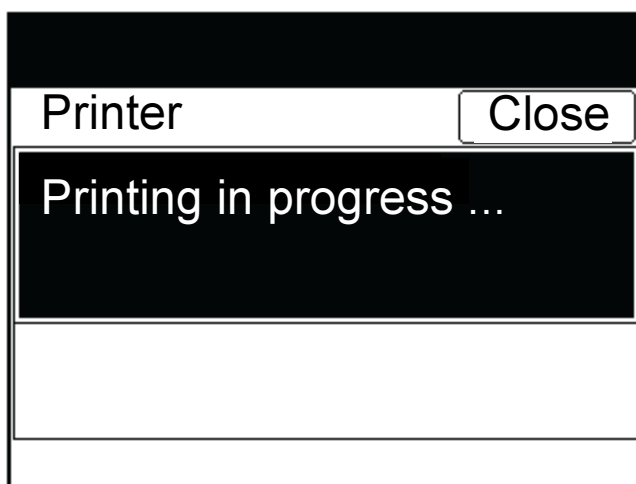

The operations that can be done on this control panel during printing are as follows:

Control panel operations	Printer actions
Press Close on the screen displayed above to start copying/faxing.	You can program the next operation without disrupting the current printing.
Press Interrupt during printing.	Printing will be paused and you can use the copying/faxing functions. Press Interrupt again to exit the Interrupt mode and resume printing.
Press Job Status ▶ Stop , select a print job, and press Stop .	Printing will be paused and the copying/faxing functions can be used. The paused printing will resume automatically. The print job cannot be stopped using the control panel.

Printing and copying/faxing functions

The relationship between the printing and copying/faxing functions is explained below.

Auto Tray Switch

Auto Tray Switch refers to the feature of automatically sending paper from another tray with the same size/orientation as the paper in the tray which has run out of paper.

This feature will usually be activated when **Auto** has been selected for **Paper Source** on the Paper/Output tab of the printer properties dialog box. This feature is independent of the copying/faxing function setting.

Paper Tray Priority

For printing, the trays are allocated priority as follows: tray 1, tray 2, tray 3 and tray 4 (with tray 1 having the highest priority). This feature is independent of the copying/faxing function setting.

Printing Priority

Printing of the following items will be prioritized according to the setting made on the control panel if they are all in the Output Waiting Job list: print job, fax job, auto-output report.

Printing functions during copying/faxing functions

When the control panel is being used

- Printing cannot be done when the control panel is being used. However, printing instruction can be received from the computer.
- Printing specified from the computer will be printed after a certain time* has passed after using the control panel.

** Setting of this time is done on the control panel. See the "User Guide (Copier)" for details.*

When transmitting

Printing instruction specified from the computer will be printed according to the order received.

When copying and outputting originals for copying

- Printing cannot be done during copying and outputting originals. However, printing instructions can be received from the computer.
- Printing specified from the computer will be printed after all the originals and copies that are being copied and output have been output.

When in the Interrupt mode

Printing cannot be done during the Interrupt mode. However, printing instructions can be received from the computer.

Press **Interrupt** to exit the Interrupt mode and begin printing. Even during the Interrupt mode, the printing will resume if no operations have been carried out for a certain time*.

** Setting of this time is done on the control panel. See the "User Guide (Copier)" for details.*

Printing Features

Setting printing features

Most of the printing features are set on the screens of the different tabs of the printer properties dialog box, which is displayed when printing from an application program or clicking the printer icon of the printer installed on the computer.

For details on these features and the way to set them, refer to the Online Help of the printer driver or “*Configuring the Printer Drivers*” on page 4-12.

NOTE: For details on using the Online Help, refer to “*Online Help*” on page 3-6.

- Hardware options installed on the printer must be set on the Printer tab of the printer driver. If not, they may not be usable and may be dimmed on other tabs.

Properties screen

Notice the tabs of the following two screens showing the same Paper/Output tab but which are displayed differently.

The screen displayed when you click **Start**; select **Settings**, followed by **Printers**; and then double click the icon of your printer model to display the properties screen (for Windows 98) and then select Properties from the right mouse menu.:



The screen displayed when you print from an application program, and then select **Properties** of the printer to set printing features (for Windows 98):

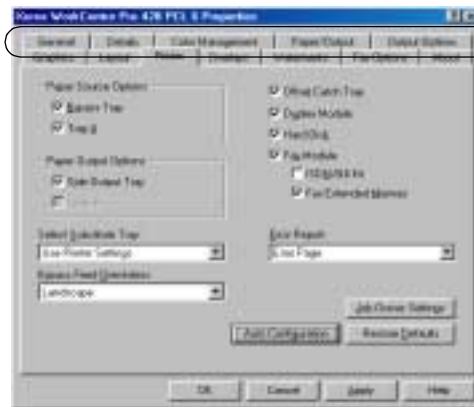

Online Help

You can use the online Help of the printer driver to check the explanation and way of setting of the items on the printer driver.

The following procedure explains how to display the Online Help. Here, we will use the Windows 98 printer driver as an illustration.

1. Click **Start**, select **Settings**, followed by **Printers**. The Printers window appears.

Double click the icon of your printer model, and then select **Properties** from the File menu to display the properties dialog box.

2. To find out more about a printer item, click on the appropriate tab to display it.

Next, either click the "?" mark at the top right corner of the printer driver screen, followed by another click on the item itself or simply click **Help** on the bottom left corner of the screen.



The different Help displayed:

- when you click the "?" mark:

An explanation on the item clicked will be displayed in a pop-up window.



- when you click **Help**

The Driver Help with the page containing the explanation on the tab shown will be displayed.



Click on **Contents** on the top left of the screen if you want to

display the whole Online Help.



Canceling Printing/Faxing

To cancel printing/faxing, first of all, try deleting the print instruction from the computer. If this is not possible, then delete it from the printer. You can check the job status of the print instruction on the computer.

When using the USB port for printing, some data will not be deleted by canceling the print instruction from the computer if you have pressed Pause on the printer to enter the pause state. The undeleted data will be printed if you exit the pause state.

Canceling from computer

Using Windows

The following procedure explains how to cancel printing from Windows:

1. Click **Start**, select **Settings**, followed by **Printers**. The Printers window appears.
2. Double click the icon of your printer model.
3. In the window displayed, click the document that you want to delete and then press **Delete** on the keyboard.



Using CentreWare Internet Services

You can use CentreWare Internet Services to cancel print data sent to the printer.

See “CentreWare Internet Services” on page 5-35.

Canceling jobs from the printer

Canceling jobs in process

The procedure to cancel jobs in process from the printer is as follows. However, the page which is being printed will still be output.

1. When the display is at a state as shown on the right, press **Mode** and **Menu** together.

The cancelling of the jobs will be processed.

When the process has been completed, the message will display, "Ready to print or fax".

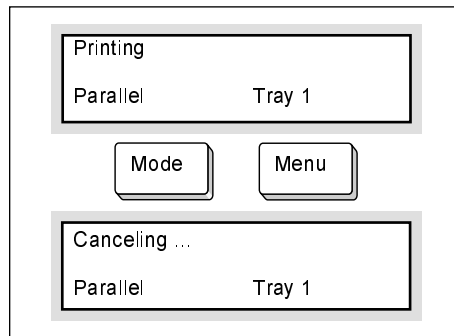

Canceling all jobs in the printer

The procedure to cancel all jobs that have been received by the printer is as follows.

By following this procedure, you can prevent the machine from receiving data and empty the buffer.

NOTE: Buffer is the location to store data sent from the computer.

See "Outputting all jobs in the printer" on page 3-14.

1. When the display is at a state as shown on the right, press **Pause**. The printer will enter the Pause mode.

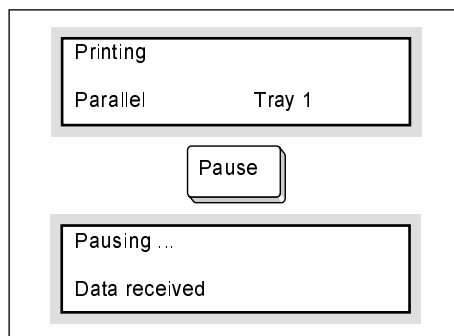

NOTE: When Pause is pressed, the printer will automatically be unable to receive data.

2. Press **Mode** and **Menu** together. The cancelling of printing will be processed.

When the processing is complete, "Printer paused" will be shown.

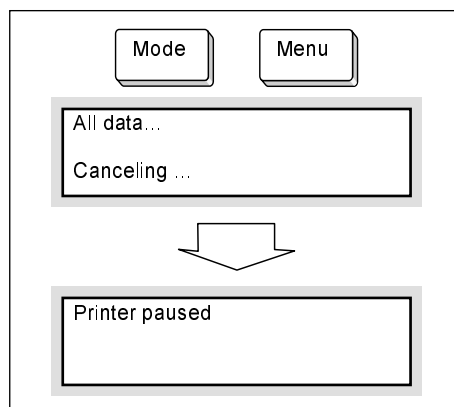

3. Press **Pause**.

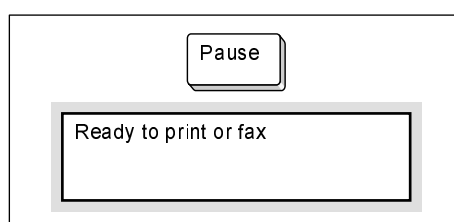

"Ready to print or fax" will be shown.

Canceling fax transmission from the touch panel display

Use the touch panel display on the control panel to cancel fax job in the process of being transmitted or fax job delayed to be sent at a later time.

Refer to *User Guide (Facsimile)* for details.

Checking job status of print instruction

NOTE: Use the touch panel display on the control panel to check the job status of fax transmission specified. Refer to *User Guide (Facsimile)* for details.

Using Windows

The procedure to check job status from Windows is as follows:

1. Click **Start**, select **Settings**, followed by **Printers**. The Printers window appears.
2. Double click the printer icon.
3. In the window displayed, check **Status**.



Using CentreWare Internet Services

You can use CentreWare Internet Services to check job status.
See *“CentreWare Internet Services”* on page 5-35.

Outputting

This section explains the two types of outputting:

- Forced outputting of remaining print data
- Outputting all jobs in the printer

Forced outputting of remaining print data

For the PCL emulation mode, data will not be output until a full page of data is collected.

If the last piece of data ends at the middle of a page, it will wait for the next data until the present Auto Eject Time has passed and "Data wait" will be shown on the display.

To forcibly print data in the printer without waiting for the Auto Eject Time to pass in such an instance is known as forced outputting.

The procedure is as follows:

NOTE: For parallel interface, the next job sent when the display shows "Data wait" might not be printed properly.

Send the next job after forced outputting or when Auto Eject Time is over.

See "Common Menu Items" on page 5-10. regarding Auto Eject Time.

1. When the display is at the state as shown on the left, press **Eject/Set**.

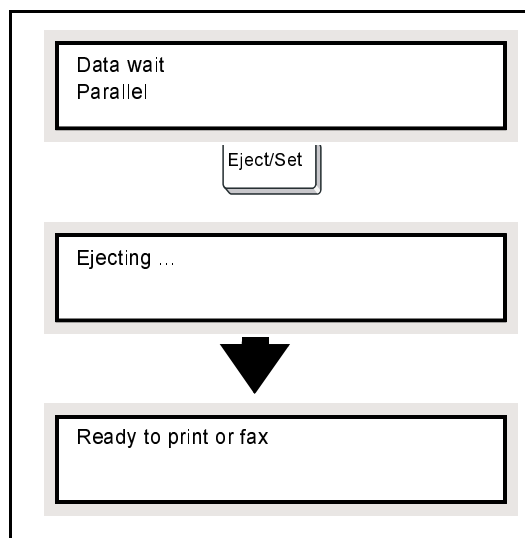

Printing will begin.

When printing is done, "Ready to print or fax" will be shown.

Outputting all jobs in the printer

To execute and print all jobs received in the printer.

This operation can prevent the printer from receiving data and empty the buffer.

The procedure is as follows:

See "Canceling jobs from the printer" on page 3-10." for details on how to erase all jobs in the printer.

1. When the display is at the state as shown on the right, press **Pause**.

The printer will enter the Pause mode.

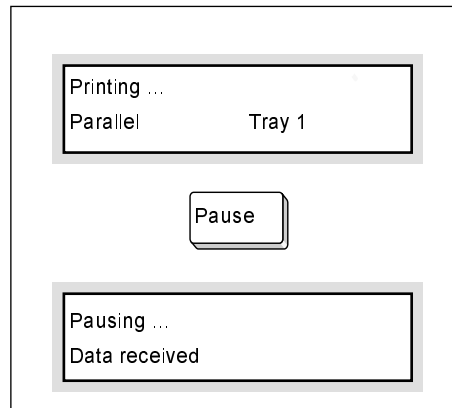

NOTE: When Pause is pressed, the printer will automatically be unable to receive data.

2. Press **Eject/Set**.

The printing begins.

When all the jobs have been executed and printed, "Printer paused" will be shown.

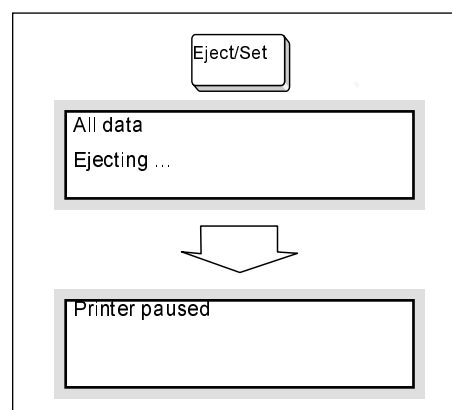

NOTE: For parallel interface, data might be received in the middle of a job depending on the timing when Pause is pressed in Step 1. In this case, all data following this will be recognized as a new job after Eject/Set is pressed and then processed as a new job after exiting the pause state in Step 3.

3. Press **ポーズ**.

"Ready to print or fax" will be shown.

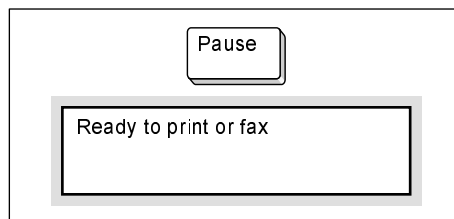

NOTE: After exiting the pause state here, data that have been treated as a new job will not be printed properly if the Print Mode is set to Auto.

See "Common Menu Items" on page 5-10. regarding the Print Mode setting.

Printing Data Combined Using Overlays

You can use the overlay feature of the printer driver to combine data for printing.

For example, you can first create an overlay for a blank form and store it in your computer. Later, you can send the data for the form to the printer for printing out the data with the form.

Here, we will explain the process by printing from Word on Windows 98 as an example.

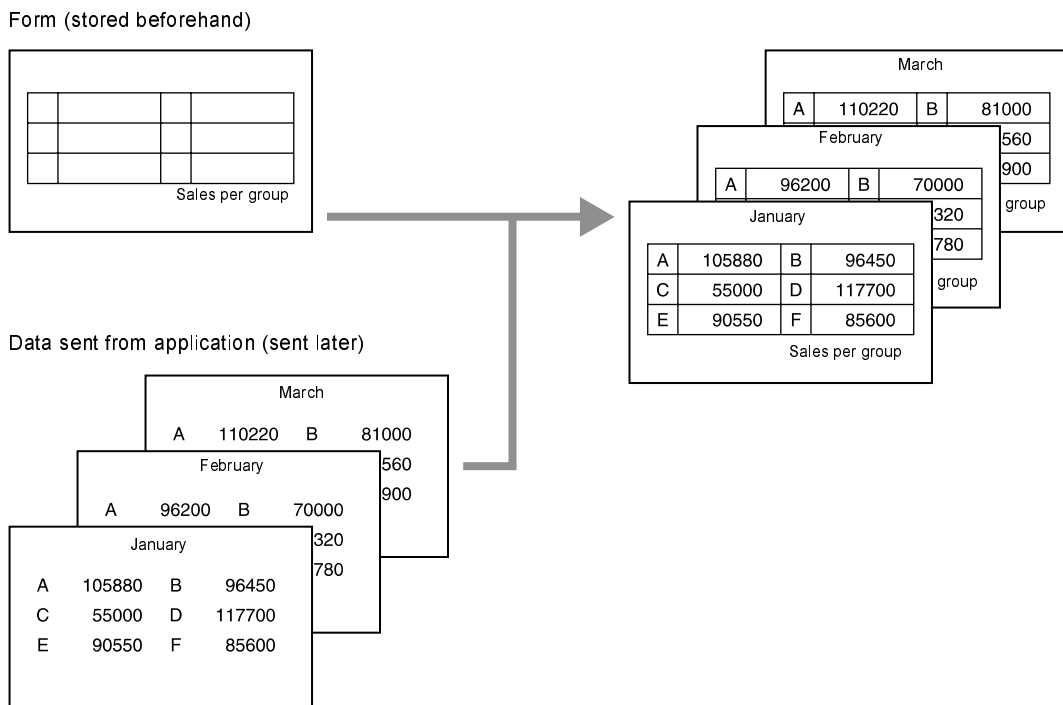

NOTE: Depending on the application program, the way to display the printer properties dialog box might be different. Check the manuals of the program used.

Creating an overlay

The procedure to create an overlay is as follows:

1. Using the application program, create the form.
2. From the File menu, select **Print**.
3. Check that this printer is selected at the Name list box, and then click **Properties**.

The printer properties dialog box appears.

4. Click the Overlays tab.

NOTE: It is not recommended to use the overlay feature with a fax job. In order for the correct placement of the overlay in a printed page, the overlay should be created on the same paper size as the printed document.



5. Click **Create Overlay**.
The Create Overlay dialog box appears.

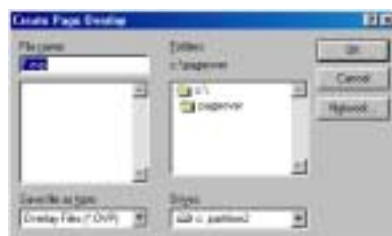

6. Enter a name for the overlay in the File name box.
If you wish, select another directory other than the default C:\pageover.
7. Click **Save**.
8. Click **OK** to close the Create Page Overlay dialog box.
9. Click **OK** to close the printer properties dialog box.
Then click **OK** to close the Print dialog box. When a confirmation message, "Create Page Overlay?" appears, click **Yes** to confirm.
The overlay will be stored in your computer.

Printing with an overlay

The procedure to print your data with the overlay is as follows:

1. Using the application program, create the data for the form.
2. From the File menu, select **Print**.
3. Check that this printer is selected at the Name list box, and then click **Properties**. The printer properties dialog box appears.
4. Click the Overlays tab.
5. Select the overlay (e.g. "Form1") to be used from **Overlays**.



6. Click **OK** to close the printer properties dialog box. Then click **OK** to close the Print dialog box. The data will be printed with the overlay.

Printing Secure Print and Sample Print Jobs

When the Printer HDD Kit has been installed, you can use the Secure Print and Sample Print features.

NOTE: Before specifying Secure Print and Sample Print features, select Hard Disk on the Printer tab of the printer driver.

Secure Print

You can attach a password to a piece of data on the computer, send it to the printer for storing, and then print out the data later using the control panel. This feature is known as Secure Print. You can also send data to the printer without a password. This feature is useful for storing frequently-used data in the printer, and then using only the printer and not the computer to print it out.

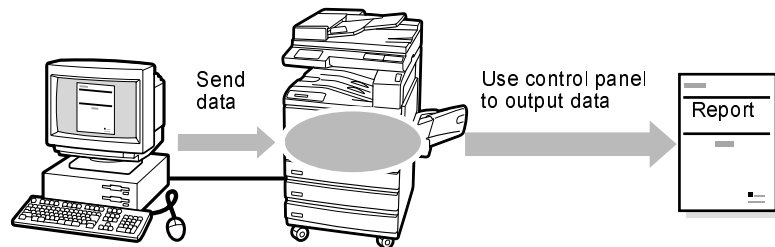

Sample Print

When printing multiple copies, you can print out only the first set to check the printing result first before printing the remaining copies from the printer control panel. This feature is known as Sample Print.

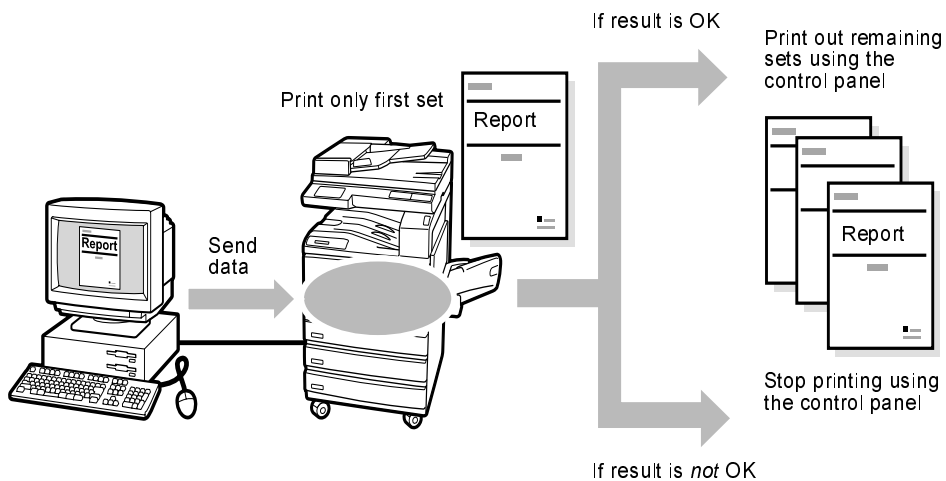

Storing User ID and Password

To use the Security Print and Sample Print features, you need to set the User ID and password (for Security Print only) first.

1. Click **Start**, select **Settings**, followed by **Printers**. The Printers window appears.
Double click the printer icon, and select **Properties** from the File menu to display the properties dialog box.
2. Click the Paper/Output tab.



3. From the Job Type list box, select **Secure Print** or **Sample Print**. The Secure Print Settings or Sample Print Settings dialog box appears.



4. For **User ID**, specify a user ID using 1-24 characters.
This is mandatory. If no user ID is specified, you will be prompted by a warning message.
5. For **Document Name**, specify a document name using 1-24 characters.
This is optional. If you do not enter a name here, it will be retrieved from the application.
6. For *Secure Print only*:
For **Password**, specify a password using one to four numbers.
This is optional. The password specified will be displayed by one * for each number entered.
After **Password** is entered, **Confirm Password** will be enabled for you to re-enter the password for confirmation.
7. Click **OK**.
A button, **Secure Print Settings** or **Sample Print Settings** will

become available just below the Job Type list box.



Printing Secure Print/Sample Print Jobs

The procedure to print Secure Print and Sample Print jobs is as follows. First, you need to set the Secure Print and Sample Print features on the computer. Then, you print out the print data using the printer.

At the computer

Here, we will use the Wordpad of Windows 98 as an example.

NOTE: The way to display the printer properties dialog box differs according to the application program. Refer to the manuals of the application program used.

1. From the File menu of the application program, select **Print**.
2. Check that the printer to be used is the printer where you have set your User ID and password, and then click **Properties**.
3. *For Sample Print only:*
Click the Paper/Output tab, and select at least 2 for **Copies**.
4. Click **Secure Print Settings** or **Sample Print Settings** that have been created on the Paper/Output tab.
A Secure Print Settings or Sample Print Settings dialog box appears.
5. Check the User ID and Document Name on these dialog boxes, and then click **OK** to close it.
6. If necessary, select settings on the tabs of the printer driver, and then click **OK** to close the printer properties dialog box.
7. Click **OK** on the Print dialog box to close it and to send data to the printer for storing.

At the control panel

The following procedure describes how to print out, using the control panel, the Secure Print or Sample Print job that has been stored in the printer.

1. Press the button, **Job Status ► Stop** on the control panel.

The Job Status screen is displayed.

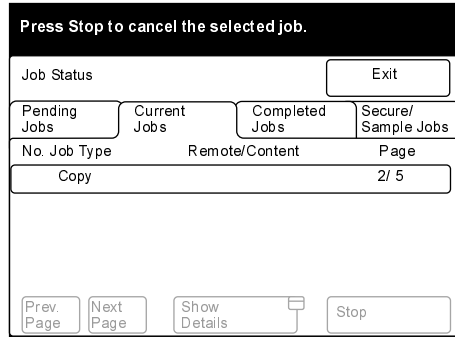

2. Select **Secure/Sample Job**.

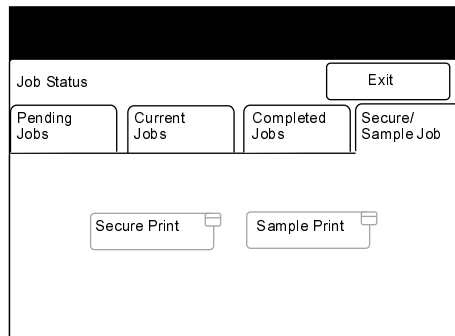

3. Select **Secure Print** or **Sample Print**.

Here, we will select **Secure Print** as an illustration.

4. Select the job that you want to print by the ID assigned to the Secure Print/Sample Print job, and then touch **Show Document List**.

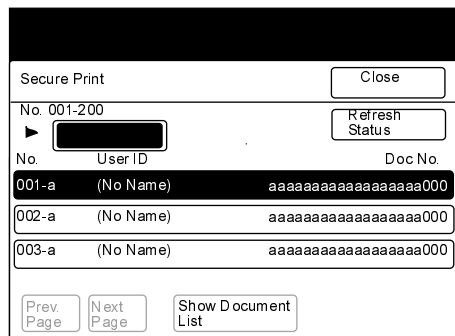

5. *For Secure Print jobs with password assigned only.*

A Password Entry screen appears. Enter your password and then

select **Confirm**.

Secure Print Close

Password

▶

6. Select the job that you want to print, and then select **Print**.

Secure Print Close

No. 001-200

▶

No.	Document Name	Stored Date	Pages
001-a	(No Name)	aaaaaaaa00/00/00a00:00a0000	
002-a	(No Name)	aaaaaaaa00/00/00a00:00a0000	
003-a	(No Name)	aaaaaaaa00/00/00a00:00a0000	

NOTE: Selecting **Select All** will select the jobs all at once. To stop printing, select the jobs that you want to stop printing and then select **Delete**.

7. Select an option after printing.
 Select **Print and Delete** if you want to delete the job after printing.
 Select **Print and Save** if you want to save the job after printing.
 Printing will then begin.

Print selected documents.
(No Name)

Select an option
after printing.

8. Select **Close** if you want to end operations at the control panel.

The screenshot shows a control panel window titled "Secure Print". At the top right is a "Close" button. Below the title bar, there is a "No. 001-999" label, a "Select All" button, and a "Refresh Status" button. A table with the following columns is displayed: "No.", "Document Name", "Stored Date", and "Pages". The table contains three rows of data:

No.	Document Name	Stored Date	Pages
001-a	(No Name)	aaaaaaaa00/00/00a00:00a0000	
002-a	(No Name)	aaaaaaaa00/00/00a00:00a0000	
003-a	(No Name)	aaaaaaaa00/00/00a00:00a0000	

At the bottom of the window, there are four buttons: "Prev. Page", "Next Page", "Print", and "Delete".

9. Select **Exit**.

The screenshot shows a control panel window titled "Job Status". At the top right is an "Exit" button. Below the title bar, there are four buttons: "Pending Jobs", "Current Jobs", "Completed Jobs", and "Secure/Sample Job". At the bottom of the window, there are two buttons: "Secure Print" and "Sample Print".

Faxing From the Computer

Documents created from an application program on the computer can be sent to the printer for faxing, in the same manner as in printing and using the same printer driver. This is known as *direct faxing*.

NOTE: To send extremely high resolution A3 sized documents (600×600 dpi) you need to install the optional 64MB SDRAM for printer.

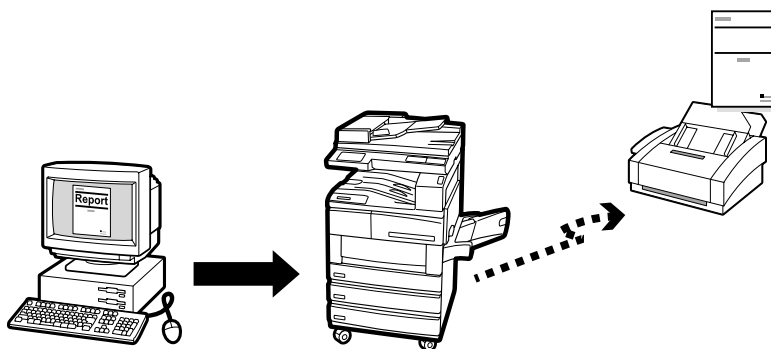

Direct faxing

To use the printer for faxing, you must first attach a Fax Module to it and then on the Printer tab of the printer driver, select **Fax Module** before carrying out the following procedure.

1. From the File menu of the application program, select **Print** to display the Print dialog box.
2. Check that the correct printer is selected, and then click **Properties** to display the printer properties dialog box.
3. Click the Paper/Output tab, and then select **Fax** for **Job Type**.

The options on the Fax Options tab will then be available for your selection.

See the Fax Options of “Configuring the Printer Drivers” on page 4-12.



4. Select the necessary settings on the Fax Options and other tabs, and then click **OK** to close the printer properties dialog box.
5. On the displayed Print dialog box, click **OK**.

The Fax Recipient dialog box appears.

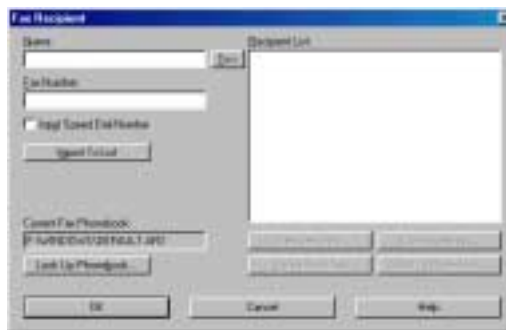

6. Enter the fax recipient to **Recipient List**. There are a few ways to do this.

If you do not have a ready list of fax recipients, enter the respective information of each fax recipient at **Name** and **Fax Number**, and then click **To->**.

You can also enter the recipient by clicking **Import To List** to import from a fax recipient data or **Look Up Phonebook** to import from fax phonebook entries.

See "Entering Recipient List" on page 3-27." for details on entering Recipient List information.

7. After the fax recipient has been added to **Recipient List**, the four buttons just below it will become available.

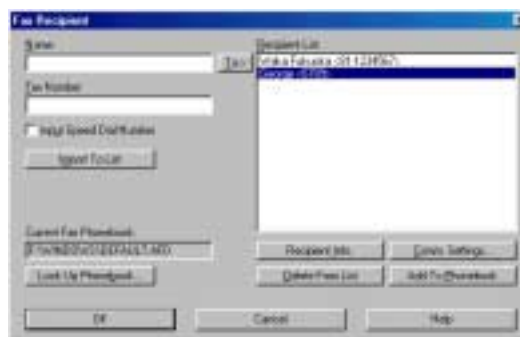

By referring to the following explanation, edit the recipient information if necessary, and then click **OK**.

Recipient Info.

Click to display the Recipient Information dialog box of the selected recipient.



Particulars shown will include those that have been entered when creating the fax recipient like name, company, fax number, telephone number, e-mail address. This button will not be available for fax recipients whose particulars are entered directly on the Fax Recipient dialog box.

Refer to "To create a new fax phonebook" of the Fax Options tab of "Configuring the Printer Drivers" on page 4-12 for details.

Comm. Settings

Click to display the Communication Setting dialog box for entering detailed communication settings for the fax recipient.

Refer to "To create a new fax phonebook" of the Fax Options tab of "Configuring the Printer Drivers" on page 4-12 for details.

Delete From List

Click to delete the selected recipient from the Recipient List.

Add To Phonebook

Click to add the selected recipient to the current Fax Phonebook.

8. The Fax Job Confirmation dialog box appears.

Check that the recipient information is correct and then click **OK** to send the fax job.

To cancel the job, click **Abort**.

If you wish to send the fax at a later time, check the check box, **Delayed Send**, and then enter the required hour and minute at **Time**.



Entering Recipient List



You can enter fax recipient information to **Recipient List** on the Fax Recipient dialog box in the following ways:

- entering fax recipient information directly
- entering fax recipient information
- importing from fax phonebook entries

Fax recipients can be individuals or groups to whom the fax is to be sent.

Entering fax recipient information

1. At the edit box, **Name**, of the Fax Recipient dialog box, enter the name of the fax recipient.

You can enter up to 30 characters here, including numbers, letters and spaces.

2. At the edit box, **Fax Number**, enter the fax number.

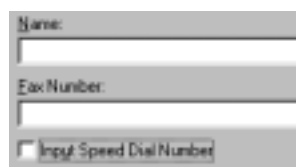

The screenshot shows a dialog box with two text input fields. The first field is labeled 'Name:' and the second is labeled 'Fax Number:'. Below the 'Fax Number' field is a checkbox labeled 'Input Speed Dial Number'.

You can enter up to 30 characters here, including numbers, letters and "-" (which represents pause) for a fax number.

Characters that cannot be entered include "[", "]", "{", "}", "|", "~", ";", and spaces.

All letters entered will be displayed in upper case. When dialing the fax number, the letters will be translated into numbers as follows:

ABC -> 2, DEF -> 3, GHI -> 4, JKL -> 5, MNO -> 6, PQRS-> 7, TUV->8, WXYZ-->9.

You may enter a speed dial number instead of a fax number.

Click the check box, **Input Speed Dial Number** to change the edit box, **Fax Number** to **Speed Dial Number**.



The screenshot shows a dialog box with two text input fields. The first field is labeled 'Name:' and the second is labeled 'Speed Dial Number (1-200):'. Below the 'Speed Dial Number' field is a checkbox labeled 'Input Speed Dial Number'.

You can enter a number between 1-200 for Speed Dial Number.

If **Extended Fax Memory** for **Fax Module** has been selected on the Printer tab, the dial number limit will be increased to 1-999.

3. Click **To->** to add the name and fax number (or speed dial number) entered to **Recipient List**.
4. On the Fax Recipient dialog box, click **Import To List**.

The Import Fax Recipient Data dialog box appears.

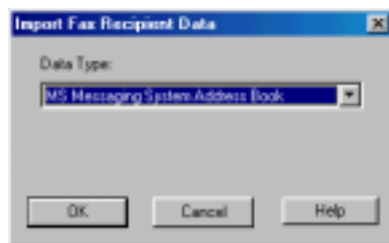

5. From **Data Type**, select one of the following options and then proceed to the respective step stated for each option:
 - MS Messaging System Address Book (proceed to Step 6)
 - Windows Address Book (WAB) (proceed to Step 7)
 - Comma Separated Values (CSV) (proceed to Step 8)
 - Speed Dial Data EWS-CSV (proceed to Step 9)
6. When **MS Messaging System Address Book** has been selected for **Data Type**:

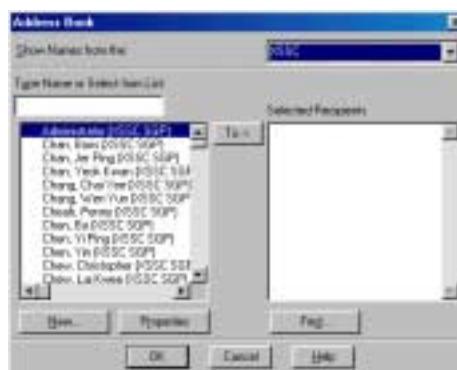

If you have already logged on to the MS Messaging System Address Book before, selecting **MS Messaging System Address Book** on the Import Fax Recipient dialog box and clicking **OK** will display the Address Book dialog box.

From the Address Book dialog box, select the required entry (which must have a fax number) and then click **To->** to enter it to **Selected Recipients**. Click **OK** to close the dialog box after all the required entries are in the selected list. Proceed to Step 10.

NOTE: To access the MS Messaging System, you must have installed the Messaging Application Programming Interface (MAPI) subsystem, a Dynamic-Link Library (DLL) built into the Windows OS. If you have not installed it, a Choose Profile dialog box will be displayed. Choose a profile from the dialog box to log on to the messaging system. Consult your system administrator for details.

7. When **Windows Address Book (WAB)** has been selected for **Data Type**:

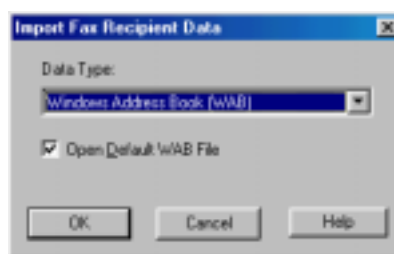

Selecting **Windows Address Book (WAB)** on the Import Fax Recipient dialog box will display a check box, **Open Default WAB File**, on it.

By default, the check box is selected to allow the default WAB file to be automatically opened. If you do not want to open the default WAB file, uncheck the check box. An Import WAB File dialog box will be displayed for you to select the required WAB file for importing entries.

If you have already installed the WAB sub-system, selecting the required WAB file to be opened will display the Address Book dialog box.

From the Address Book dialog box, select the required entry (which must have a fax number) and then click **To->** to enter it to **Selected Recipients**. Click **OK** to close the dialog box after all the required entries are in the selected list. Proceed to Step 10.

NOTE: To access WAB, you must have installed the WAB sub-system (WAB32.DLL), a Dynamic-Link Library (DLL) installed by the Internet Explorer. Consult your system administrator for details.

8. When **Comma Separated Values (CSV)** has been selected for **Data Type**:

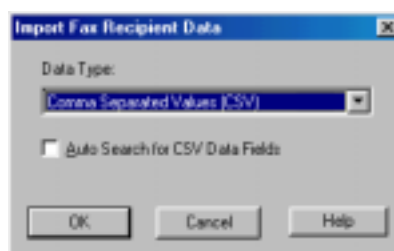

Selecting **Comma Separated Values (CSV)** on the Import Fax Recipient dialog box will display a check box, **Auto Search for CSV Data Fields**, on it.

By default, the check box is *not* selected to allow you to select a CSV data file to be imported. A CSV Import dialog box will be displayed for you to select the required CSV file and then manually select data fields in the CSV file to be mapped to Name and Fax Number fields. If the check box, **Auto Search for CSV Data Fields**, has been selected, the Name and Fax Number fields will be automatically searched from the CSV data fields.

Next, the CSV records will be displayed as entries, consisting of name and fax number, in the CSV Import dialog box for your selection.

From this dialog box, select the required entry and then click **To->** to enter it to **Selected Recipients**. Click **OK** to close the dialog box after all the required entries are in the selected list. Proceed to Step 10.

9. When **Speed Dial Data EWS-CSV** has been selected for **Data Type**:

Selecting **Speed Dial Data EWS-CSV** on the Import Fax Recipient dialog box and clicking **OK** will display the Import EWS-CSV File dialog box for you to select the CSV file for import.

After the CSV file has been opened, the import dialog box will display the Speed Dial fields of the file as entries for your selection.

From this dialog box, select the required entry and then click **To->** to enter it to **Selected Recipients**. Click **OK** to close the dialog box after all the required entries have been selected. Proceed to Step 10.

10. The Import Fax Recipient Data - Confirmation dialog box will be displayed.



Check that the correct fax recipient has been imported and then click **OK**.

The fax recipient will be imported to the **Recipient List** of the Fax Recipient dialog box.

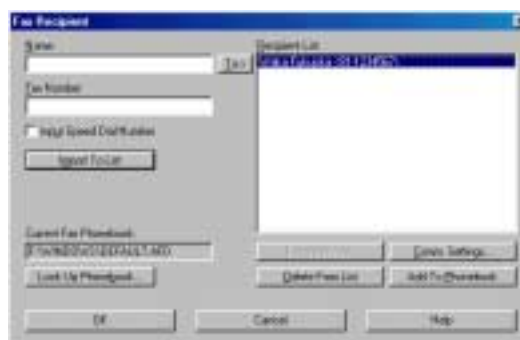

11. On the Fax Recipient dialog box, click **Look Up Phonebook**.

The following Fax Phonebook dialog box appears.

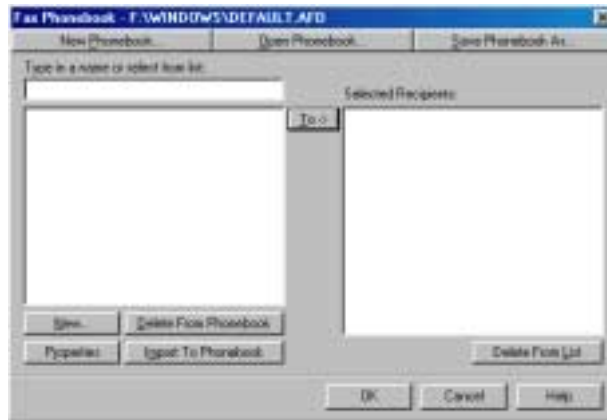

12. Refer to the description on **Fax Phonebook** on the Fax Options tab of *“Configuring the Printer Drivers”* on page 4-12 to open (as well as to edit or create) a fax phonebook for the fax phonebook entries to be displayed in the list box on the left.

13. Select the required entry in the list box on the left, and then click **To->** to add it to **Selected Recipients**.

To delete any entry in **Selected Recipients**, simply select it and then click **Delete From List**.

Click **OK** to close the dialog box after all the required entries have been selected.

The fax recipient will be imported to **Recipient List** of the Fax Recipient dialog box.

4 Installing/Configuring the Printer Drivers

The following information can be found in this chapter:

- About the Printer Drivers
- Installing/Uninstalling the Printer Drivers
- Configuring the Printer Drivers

About the Printer Drivers

This section gives an overview of the printer drivers.

The PCL 6 printer drivers

The PCL 6 printer drivers are installed on the Windows operating systems to provide a standard interface between an application program and the printer device. By installing these printer drivers, print jobs are converted into the PCL and PCL 6 printer languages and then printed through the printer device.

These printer drivers are system specific, each will only run on either Windows 95/Windows 98/Windows Me, or Windows NT 4.0/Windows 2000. There are two different printer drivers provided:

- PCL 6 printer driver for Windows 95/Windows 98/Windows Me
- PCL 6 printer driver for Windows NT 4.0/Windows 2000

Installation/configuration methods

The methods of installing/configuring all these different printer drivers as well as the procedures for printing using these drivers are basically the same. Regardless of the operating system (OS) you are using, the basic steps are similar except for the look of some of the dialog boxes. Only one printer driver will be used to discuss these operations in this chapter but any differences among these drivers will be pointed out.

Settings on the printer

Make sure the PCL switch for the interface is turned to ON. If the PCL switch is turned to OFF, you may not obtain the desired printing results when using some driver features.

Installing/Uninstalling the Printer Drivers

This section describes the procedure for installing and uninstalling the printer drivers.

Two methods of installation are described here, one for a local printer and the other for a network printer.

If you have installed an earlier version of the printer driver, uninstall it before installing the new version.

NOTE: You can also use the Add Printer Wizard to install the printer driver. Refer to ReadMe for more details.

For a local printer

1. Start Windows 95, Windows 98, Windows Me, Windows NT 4.0 or Windows 2000.

NOTE: In this procedure, Windows 98 has been used. Screens will vary according to the operating system used.

2. Insert the PostScript driver CD in the CD-ROM drive.
The Install program should run automatically.



3. Click Driver Installation.
The Welcome screen for the PostScript driver installation is displayed.

4. Click the Copier/Printer tab.



5. Click Begin Installation on the Copier/Printer tab.



6. Click [Next] on the Welcome screen.

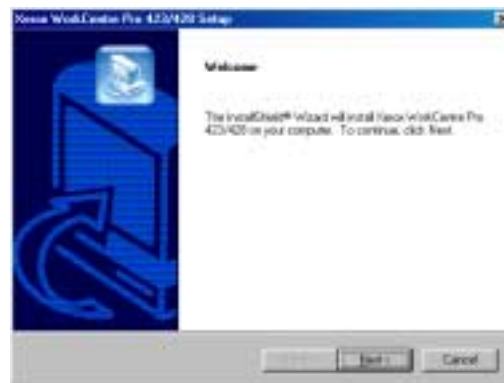

7. Read the License Agreement and click [Yes] to accept the agreement.

NOTE: If you click **[No]** the installation will terminate.

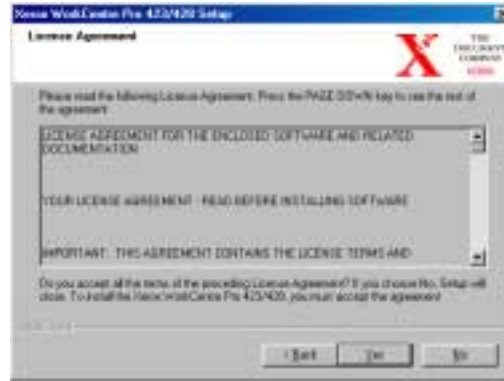

8. Read the readme information and click **[Next]**.

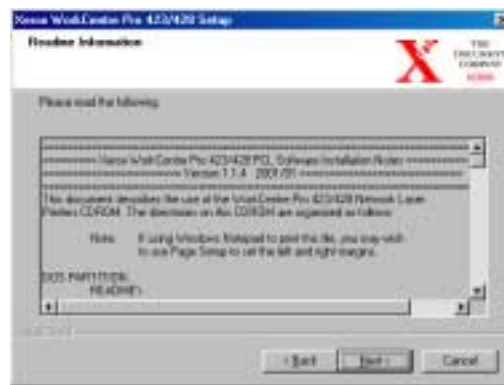

9. Highlight the printer that you want to install and click **[Next]**.

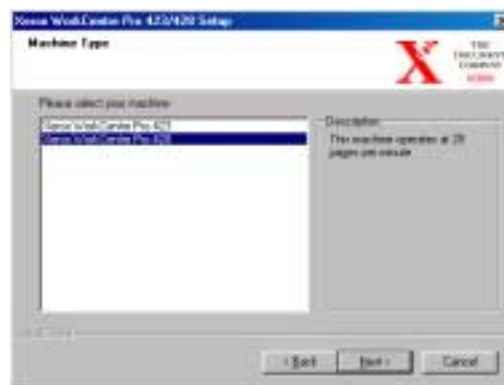

10. Click the Setup button that you want to use to install the printer.

NOTE: It is recommended that you use the Typical button unless you are an advanced user wanting to customize the installation.



11. Check the information screen and click **[Next]**.

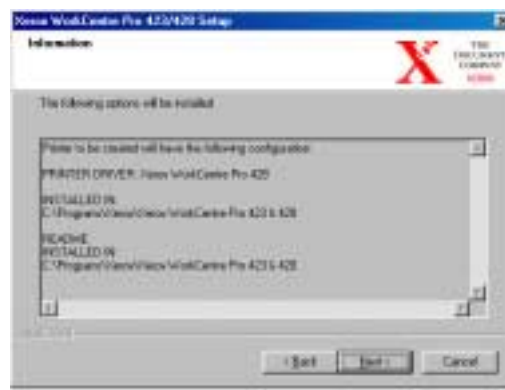

12. Read the Printer Installation Information screen and click **[Next]**.



13. Make sure that the Select Printer Setup box is checked and click **[Finish]** to launch the Add Printer Wizard and complete the installation of the printer.

NOTE: If you want to complete the installation of the printer later, uncheck the Select Printer Setup box before clicking **[Finish]**.



14. Click **[Next]** to start the wizard.

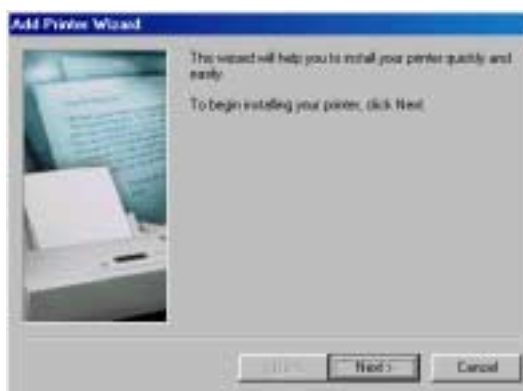

15. Select how the printer is connected to the computer.

Select Local printer when the printer is connected directly to the computer. Otherwise, select Network printer.

For a network connected printer:

i. Click the **[Network printer]** radio button then click **[Next]**.



- ii. Enter the Network path or queue name for the printer or click **[Browse]** and locate the printer. When the network path or queue name is displayed, click **[Next]**.



For a locally connected printer:

- i. Click the **[Local printer]** radio button then click **[Next]**.

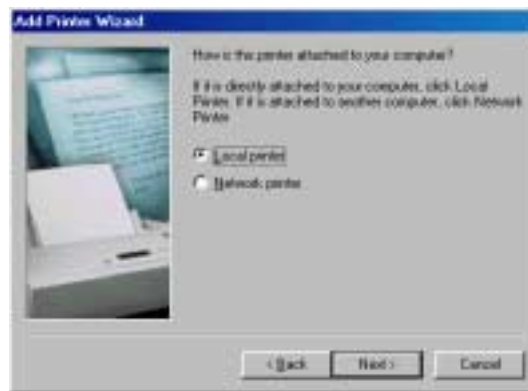

16. Click **[Have Disk]**.



17. Browse to where the driver files were installed.
If you installed the files on your workstation, the location will be:
C:\Program Files\Xerox\Xerox WorkCentre Pro 423 & 428
The driver file is called **xrx128eb**.
18. Choose this file and click **[Open]**.

19. Click **[OK]**.

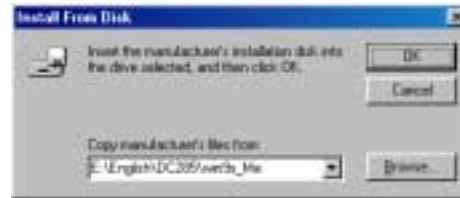

20. Select your printer model from the Printers list and click **[Next]**.



21. For **Local Printer only**, select the port that you are using and click **[Next]**.



22. Type a name for the printer, specify whether you want to use the printer as the default printer, then click **[Next]**.

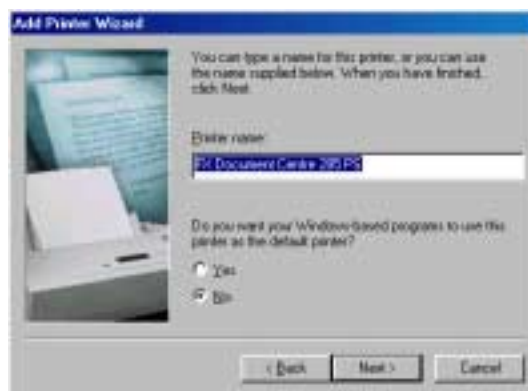

23. Specify whether you want to print a test page, then click **[Finish]**.

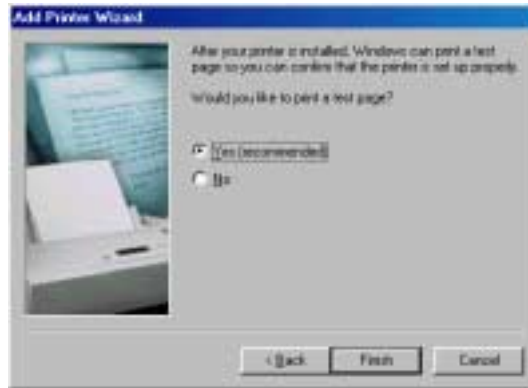

Installation begins.

24. Read the End User License Agreement and click **[Accept]**.



25. If you click Decline, see *“If you click Decline in the License Agreement”* on page 4-11 for details.

26. Confirm that a printer has been added in the Printers window.



This completes installation of the printer driver. Remove the CD-ROM from the drive.

See *“Configuring the Printer Drivers”* on page 4-12. to configure the printer.

Store your CD-ROM in a safe place.

If you click Decline in the License Agreement

If you click **[Decline]** in the End User License Agreement, the following dialog box appears.



Click **[No]** to return to and continue the operation.

Click **[Yes]** to cancel installation. A printer is added in the Printers window, but the printer driver is not installed properly.

When you right-click the printer and click Properties from the menu, the Re-installation tab is added to the printer driver properties dialog box. Follow the directions on that tab.

When you finish reinstalling the printer driver, see *"Configuring the Printer Drivers"* on page 4-12 to set up the printer.

Configuring the Printer Drivers

This section describes how to configure the printer driver from the printer properties dialog box. This dialog box will appear if you click Printer Setup (for Windows 95/Windows 98/Windows Me) or Printer Properties (for Windows NT 4.0/Windows 2000) on the Installation Successful screen. If you have quit the printer setup program, follow the procedure in “*Accessing the printer properties dialog box*” on page 4-12 to display this dialog box.

This printer properties dialog box includes many tabs for you to set up the printing conditions, such as Printer and Paper/Output. You will need to select appropriate options on the Printer tab first before the other tabs. If not, the other tabs may not show options appropriate to your machine.

For Windows NT 4.0/Windows 2000 drivers: You have to define settings on the Printer tab from this printer properties dialog box before accessing the *document default* dialog box (for Windows NT 4.0) or *printing preferences* dialog box (for Windows 2000) to define the other properties.

For details of all the different properties, refer to “*Setting the printer properties*” on page 4-14.

Accessing the printer properties dialog box

For Windows 95/Windows 98/Windows Me

1. Click **Start**, select **Settings**, followed by **Printers**.
The Printers window appears.
2. Double click the icon of your printer model.
3. Select **Properties** from the File menu to display the Properties dialog box.



For Windows NT 4.0/Windows 2000

Accessing the printer properties dialog box

1. Follow Steps 1 and 2 of the procedure for Windows 95/Windows 98/Windows Me to select the icon of your printer model.
2. Select **Properties** from the Printer menu to display the following Properties dialog box.



Windows NT 4.0



Windows 2000

Accessing the document defaults/printing preferences dialog box

1. Follow Steps 1 and 2 of the procedure for Windows 95/Windows 98/Windows Me to select the icon of your printer model.
2. Select **Document Defaults** (for Windows NT 4.0) or **Printing Preferences** (for Windows 2000) from the Printer menu to display the following document defaults/printing preferences dialog box to define settings on the other tabs.

NOTE: For Windows 2000: You can also click Printing Preferences on the General tab of the printer properties dialog box to display the printing preferences dialog box.



Windows NT 4.0



Windows 2000

Setting the printer properties

Through the printer properties (and document default/printing preferences) dialog box, the printer driver will provide an interface for you to ensure that the driver settings match those of the printer and to select printer option settings for the different properties. The settings made here will be the default printer configuration for printing subsequent jobs.

Although an application may change the page setup each time a job is printed, it will not affect these default settings. Changes to these configurations can only be made through these dialog boxes.

Here is a summary of the different properties of each tab:

➤ Printer

Settings here include the printer hardware options installed (e.g. Bypass Tray, Tray 4, Side Output Tray, Finisher, Offset Catch Tray, Duplex Module, Hard Disk and Fax Module) and other printer settings that are not configured frequently, like Error Report, Select Substitute Tray, Bypass Feed Orientation, Job Owner Settings, Auto Configuration. (*for Windows NT 4.0/Windows 2000 only: Device Halftone*)

➤ Paper/Output

This property controls several aspects of how the printer works with paper and how it handles a print job. Settings include Job Type (i.e. Print, Secure Print, Sample Print and Fax), Paper Size, Paper Source, Image Orientation, Copies, Output Destination, 2 Sided Print etc.

➤ Output Options

Includes settings on how the printed output is to be processed. Settings include Job Offset Settings, Collated Settings, Finishing, Document Options (e.g. First Sheet, Transparency Separators) etc. (*for Windows NT 4.0/Windows 2000 only: EMF Spooling*)

➤ Graphics

Settings contained here control the quality of printed output as well as how the graphics and TrueType fonts will be processed and printed. (*for Windows NT 4.0/Windows 2000 only: Halftone Color Adjustment*)

➤ Layout

The layout property provides six job finishing features to modify the printed layout of a document like Multi-Up, Booklet Creation, Fit To Output Size, Zoom, Change Output Size (No Zoom), Poster.

➤ Overlays

Allows you to create, use and delete page overlays for the printer.

➤ Watermarks

A watermark is a light image printed in the background on a page. The PCL 6 driver allows text (as watermark) to be printed in the background or foreground and placed across the first page or all pages of a document. This property dialog allows you to create, delete and modify such watermarks.

➤ Fax Options

Settings here include fax options like Fax Resolution, Transmission Report, Send Header, and Fax Phonebook.

Printer



Windows 95/Windows 98/Windows Me



Windows NT 4.0/Windows 2000

The Printer tab defines two main types of settings: the current hardware configuration of the printer (**Paper Source Options** and **Paper Output Options**) as well as other printer settings that are not configured frequently. You need to define your printer configuration on the Printer tab before specifying other options, which may be disabled if the installed options are not correctly specified. You can simply click **Auto Configuration** to search through the network for options installed on your printer, and automatically display the correct hardware option settings on this tab. Or you may also specify the installed options manually instead.

Paper Source Options

Specify the optional paper source that can be attached to your printer other than the standard tray. The printer image on the Paper/Output tab will be changed accordingly.

➤ Bypass Tray (default: off)

Select this if your printer is installed with this manual feeder for loading paper that cannot be used in a paper tray.

➤ Tray 4 (default: off)

Select this if your printer is installed with tray 4.

If Bypass Tray is not checked here, the Bypass Tray will not be available for Paper Source on the Paper/Output tab.

If Tray 4 is not checked here, Tray 4 will not be available for Paper Source on the Paper/Output tab.

Paper Output Options

Specify the optional output tray that can be attached to your printer for additional capacity over the standard output tray.

➤ Side Output Tray (default: off)

Select this if your printer is installed with the Side Tray Kit. Printed copies are delivered face up in this tray.

➤ Finisher (default: off)

Select this if your printer is installed with this attachment of two finisher trays. It is equipped with the offset catch tray and the stapler.

If Side Output Tray is not checked here, the Side Output Tray will not be available for Output Destination on the Paper/Output tab.

If Finisher is not checked here, the Finisher Tray Upper and Finisher Tray Lower will not be available for Output Destination on the Paper/Output tab.

Only one of these two options, Side Output Tray or Finisher, can be selected at a time.

Select Substitute Tray

Use this feature to determine the output action when the printer fails to feed the desired paper size for print jobs with **Auto** selected for **Paper Source** on the Paper/Output tab. Options include:

➤ **Use Printer Settings (default)**

Paper will be fed according to the printer settings.

➤ **Use Larger Size (No Zoom)**

The next bigger size to the selected size will be used for outputting the job without adjusting the image size and position. A smaller size will be used if a bigger size is not available.

➤ **Display Message**

A message, prompting for paper to be loaded in tray, will be displayed on the printer control panel.

Bypass Feed Orientation

Select the orientation of the paper to be loaded in the bypass tray. Options include:

➤ **Landscape (default)**

Paper will be fed by its short edge and the paper will be output in landscape orientation.

➤ **Portrait**

Paper will be fed by its long edge and the paper will be output in portrait orientation.

Enabled only if **Bypass Tray** has been selected for **Paper Source Options** on this tab.

Even when Portrait has been selected, some paper sizes need to be loaded and fed only in landscape orientation because of the bypass tray specification.

Offset Catch Tray (default: off)

Select this if your printer is installed with the Offset Output Kit. Only the standard Center Output Tray can be used with the offset catch tray.

If this is not checked, Offset Per Job and Offset Per Set will not be available for Job Offset on the Output Options tab.

Duplex Module (default: off)

Select this if your printer is installed with a duplex module to perform two-sided printing.

If this is not checked, Flip on Long Edge and Flip on Short Edge will not be available for 2 Sided Print on the Paper/Output tab.

Hard Disk (default: off)

Select this if your printer is installed with a hard disk which enables the printer to support job collation. This has to be selected also when using the stapling function.

If this is not checked, Collated on the Output Options tab will not be available.

Fax Module (default: off)

Select this if your printer is installed with a fax module which enables the printer to send a print job from an application program as a fax job. When this option has been selected, Fax will be available for Job Type on the Paper/Output tab and following two options will be available for selection just below it:

➤ Fax Extended Memory

Selecting this will increase the dial number limit from 1-200 to 1-999.

Error Report

Select whether or not errors are to be reported for print jobs. Options include:

➤ Off

No error report will be printed.

➤ Error Page (default)

An error page will be printed when the printer encounters error in printing the job.

Device Halftone (for Windows NT 4.0/Windows 2000 only)

Click to display the Device Color/Halftone Properties dialog box for defining the color and halftone properties for the printer.

Job Owner Settings

Click to display the Job Owner Settings dialog box to define the job owner name, which is required by the printer to generate the Print Meter Report. The name can be entered in 1 to 31 characters. If you do not specify the name, the printer will use the user's login name.

Auto Configuration

Click to automatically display the correct hardware options instead of manually specifying each device option.

Before clicking this button to update the printer configuration, you will need to enable **SNMP** as a network port and select **UDP** or **IPX** for **Transport Protocol** on the printer control. For details, refer to "Setting the port and transport protocol" on page 2-21.

If the printer driver is using TCP/IP or IPX network port, and the connected printer is of the same target model as the printer driver, the driver will successfully acquire the information on your printer configuration and the check box of the installed options will be selected.

Once the printer has been configured automatically, the network printer address will be displayed on the tab, immediately below the **Bypass Feed Orientation** box.

However, the driver may fail to acquire the information and display an error message:

When this happens, carry out the following procedure:

1. Click **Yes** on the Searching for a Printer dialog box. The following Printer Searching Method dialog box will appear.



2. Select **Network Printer Address** if you can specify exactly the network printer address, and proceed to Step 4. Otherwise, select **Broadcast**, and proceed to Step 3.
3. *When **Broadcast** has been selected:*
Select **TCP/IP** or **IPX**, and then click **Search** to list the printer in the Searched Printers window. Then select the appropriate printer, and click **OK**.
Alternatively, you can select the check box, **User defined broadcast address** for TCP/IP selection, and then enter numbers between 0-255 for each box.

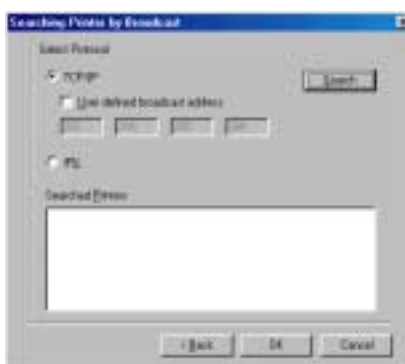

4. *When **Network Printer Address** has been selected:*
Select **TCP/IP** or **IPX** for your protocol, enter the printer network address, and then click **OK**.



NOTE: For TCP/IP, enter numbers between 0-255 for each box. For IPX, enter 8 characters for the first box and 12 for the second box. You can enter numbers (0-9) or letters (a-f, case insensitive).

The options installed on your printer will be detected through the network, and the check boxes of the installed options will be selected. The network printer address will be displayed.

NOTE: If the driver is still not able to acquire the information, specify the printer configuration manually.
If the configuration settings have been modified manually after performing Auto Configuration, the display of network printer address will be gone.

Restore Defaults

Restore the settings in the dialog box to their default values.

Paper/Output



The Paper/Output tab has option settings that determine the print environment in which a job is printed. Notice that there are image displays of Job Type, Paper Size, Image Orientation and 2 Sided Print to the left of these drop-down lists, which will change according to the selections made. There is also a display of the printer with clickable image areas of the paper input and output devices. You can either click on these displays or choose from the drop-down lists to make selections.

Job Type

Specify the type of job you want to output. Options include:

- Print (default)
 - Select this for the usual print job.
- Secure Print
 - Select this when you want to keep the job in the printer. The jobs can then be printed only when requested from the printer control panel.
- Sample Print
 - Select this when you want to print only the first copy of multiple collated copies as sample. The rest of the copies will be stored in the printer until requested from the printer control panel.
 - (Secure Print and Sample Print are available only if Hard Disk has been selected on the Printer tab)**
- Fax
 - Select this for fax job. (available only if **Fax Module** has been selected on the Printer tab)
 - See *“Printing Secure Print and Sample Print Jobs”* on page 3-19. for details on printing Secure Print and Sample Print jobs.

Copies (default: 1)

Specify the number of copies to print. The valid range is 1-999 copies.

Paper Size

Specify the paper size to use for the print data. Options include:

• A4 (210×297 mm) (default)	• A5 (148×210 mm)
• 8.5×11" (Letter)	• 5.5×8.5" (Statement)
• B5 (182×257 mm)	• B6 (128×182 mm)
• B4 (257×364 mm)	• A6 (105×148 mm)
• 8.5×13" (Folio)	• Booklet on A4
• 8.5×14" (Legal)	• Booklet on Letter
• 8K (267×388 mm)	• Booklet on A3
• A3 (297×420 mm)	• Booklet on Ledger
• 11×17" (Ledger)	

(5.5×8.5" (Statement), B6 (128×182 mm), and A6 (105×148 mm) are available only if **Bypass Tray** has been selected for **Paper Source Options** on the Printer tab;

Booklet on A4, Booklet on Letter, Booklet on A3, and Booklet on Ledger are available only if **Duplex Module** has been selected on the Printer tab)

NOTE: You can define your own paper size by clicking Custom Paper Size.

Custom Paper Size

Click to display the Custom Paper Size dialog box for defining the non-standard size of the print media that you are using. For a print job, it is enabled only if **Bypass Tray** has been selected for **Paper Source Options** on the Printer tab.

Options include:

➤ Select

Select from one of the standard paper sizes that is closer to your custom size, and then click **New** to enable the other options for editing.

➤ Name

Enter up to a maximum of 32 characters.

➤ Unit

Choose either millimeter or inch to define the custom paper size.

➤ Size

Enter a paper size ranging from 100×148 mm (3.94×5.83") to 297×431 mm (11.7×17").

➤ Portrait

Define the printable area margins in portrait orientation by defining the left, right, top and bottom margins.

➤ Landscape

Define the printable area margins in landscape orientation by defining the left, right, top and bottom margins.

Paper Source

Specify the default paper tray to use. Options include:

➤ Auto (default)

Paper will be automatically selected.

➤ Tray 1

➤ Tray 2

➤ Tray 3

➤ Tray 4

(available only if **Tray 4** has been selected for **Paper Source Options** on the Printer tab)

➤ Bypass Tray

(available only if **Bypass Tray** has been selected for **Paper Source Options** on the Printer tab)

The paper sizes available for each paper source are as follows:

Paper Size	Auto	Tray 1	Tray 2, 3, 4	Bypass Tray
A4	<input type="radio"/>	<input type="radio"/>	<input type="radio"/>	<input type="radio"/>
8.5×11" (Letter)	<input type="radio"/>	<input type="radio"/>	<input type="radio"/>	<input type="radio"/>
B5	<input type="radio"/>	<input type="radio"/>	<input type="radio"/>	<input type="radio"/>
B4	<input type="radio"/>	<input type="radio"/>	<input type="radio"/>	<input type="radio"/>
8.5×13" (Folio)	<input type="radio"/>	<input type="radio"/>	<input type="radio"/>	<input type="radio"/>
8.5×14" (Legal)	<input type="radio"/>	X	<input type="radio"/>	<input type="radio"/>
8K	<input type="radio"/>	X	<input type="radio"/>	<input type="radio"/>
A3	<input type="radio"/>	X	<input type="radio"/>	<input type="radio"/>
11×17" (Ledger)	<input type="radio"/>	X	<input type="radio"/>	<input type="radio"/>
A5	<input type="radio"/>	<input type="radio"/>	X	<input type="radio"/>
Postcard	<input type="radio"/>	<input type="radio"/>	X	<input type="radio"/>
5.5×8.5" (Statement)	X	X	X	<input type="radio"/>
A6	X	X	X	<input type="radio"/>
B6	X	X	X	<input type="radio"/>
Booklet on A4	<input type="radio"/>	<input type="radio"/> *	<input type="radio"/>	X
Booklet on Letter	<input type="radio"/>	<input type="radio"/> *	<input type="radio"/>	X
Booklet on A3	<input type="radio"/>	X	<input type="radio"/>	X
Booklet on Ledger	<input type="radio"/>	X	<input type="radio"/>	X
Custom	X	X	X	<input type="radio"/>

NOTE: : supported; X: not supported

* : not supported if Fit To Output Size or Change Output Size (No Zoom) has been selected for Layout Mode on the Layout tab.

Output Destination

Specify an output destination. Options include:

- Center Output Tray (default)
 - Printouts are delivered face down.
- Finisher Tray Upper
 - (available only if **Bypass Tray** has not been selected for **Paper Source** on the Paper/Output tab)
- Finisher Tray Lower
 - (Finisher Tray Upper and Finisher Tray Lower are available only if **Finisher** has been selected for **Paper Output Options** on the Printer tab)
- Side Output Tray
 - Printouts are delivered face up.
 - (available only if **Side Output Tray** has been selected for **Paper Output Options** on the Printer tab)

NOTE: Paper of the following paper sizes, even if selected, will not output to the Finisher Tray Upper or Finisher Tray Lower: postcard, A6, B6, custom paper size.

Image Orientation

Select the orientation of the image when printed. Options include:

- Portrait (default)
 - Portrait means the page is printed with the height of the image greater than the width.
- Landscape
 - Landscape means the page is printed with the width of the image greater than the height.

2 Sided Print

Select when you want to print on one or both sides of the paper. If you are printing on both sides, you have to decide whether to align to the long or short edge of the paper. Options include:

- 1 Sided Print (default)
 - Prints only on one page.
- Flip on Long Edge
 - Two-sided printing aligned to the long edge of the paper.
- Flip on Short Edge
 - Two-sided printing aligned to the short edge of the paper.

Two-sided print options are available only if all of the following conditions are met:

- **Duplex Module** has been selected on the Printer tab;
- **Bypass Tray** has not been selected for **Paper Source** on the Paper/Output tab.

Paper Type (Bypass Tray)

Select the type of paper or media for the bypass tray. Options include:

- Plain (default)
- Heavyweight
- Transparency

Enabled only if **Bypass Tray** has been selected for **Paper Source Options** on the Printer tab.

Restore Defaults

Restore the settings in the dialog box to their default values.

Output Options



Windows 95/Windows 98/Windows Me



Windows NT 4.0/Windows 2000

The Output Options tab has some advanced features for sending a print job. Notice that there are image displays of Collated Settings and Finishing which will change according to the selections made. You can either click on these displays or choose from the drop-down list (for Stapling) to make selections.

Job Offset Settings

This feature provides a means of identifying one print job from another in the printer output tray by outputting jobs in an in-out manner.

Job Offset

Options include:

- None (default)
 - No job offset.
- Offset Per Job
 - Offsets each print job.
- Offset Per Set

Offsets each set within a print job. This will only apply when two or more sets have been selected.

The two job offset options are available only if either one of the following conditions is met:

- **Offset Catch Tray** has been selected on the Printer tab and **Center Output Tray** for **Output Destination** on the Paper/Output tab; or
- **Finisher** has been selected for **Paper Output Options** on the Printer tab and **Finisher Tray Upper** for **Output Destination** on the Paper/Output tab.

Collated Settings

Specify how you want your document to be arranged.

Collated (default: on)

Check on the check box to collate or uncollate your documents.
Enabled only if all of the following conditions are met:

- **Hard Disk** has been selected on the Printer tab;
- more than 1 is selected for **Copies** on the Paper/Output tab.

Finishing

Select where to staple your printed document. Paper sizes that can be stapled include A5, B5, A4, 8.5×11", B4, A3, 8.5×13", 8.5×14", 8K and 11×17".

Stapling

Options include:

- None (default)
 - Staple function off.
- Top Left Corner
- Top Right Corner
- Bottom Left Corner
- Bottom Right Corner

Enabled only if all of the following conditions are met:

- **Finisher** has been selected for **Paper Output Options** on the Printer tab;
- **Hard Disk** has been selected on the Printer tab;
- **Finisher Tray Upper** has been selected for **Output Destination** on the Paper/Output tab;
- **Collated** has been selected for **Collated Settings**;
- more than 1 has been selected for **Copies** on the Paper/Output tab.

NOTE: The finisher can staple up to a maximum of 30 sheets.

Document Options

Enables special output document options for print jobs. Options include:

None (default)

The print job is output normally.

First Sheet

Allows the paper source for the first sheet in your job to be different from the rest of the printed output sheets. The paper size must be the same as the body of the document.

When this is selected, a drop-down list, **Feed First Sheet from** will become available for you to choose your paper source for the First Sheet. Options include:

- Auto (default)

- Tray 1
- Tray 2
- Tray 3
- Tray 4

(available only if **Tray 4** has been selected for **Paper Source Options** on the Printer tab)

- Bypass Tray

(available only if all of the following conditions are met:

- on the Printer tab, **Bypass Tray** has been selected;
- on the Paper/Output tab, **1 Sided Print** has been selected for **2 Sided Print** and **Finisher Tray Upper** has *not* been selected for **Output Destination**)

Transparency Separators

Allows separators to be inserted between the transparencies output of a print job. Enabled only if all of the following conditions are met:

- on the Printer tab, **Bypass Tray** has been selected;
- on the Paper/Output tab, **Bypass Tray** has been selected for **Paper Source** and **Transparency for Paper Type (Bypass Tray)**.

When this is selected, a drop-down list, **Feed Separators from** will become available for you to choose your paper source for the separators. Options include:

- Use Printer Settings (default)
- Auto
- Tray 1
- Tray 2
- Tray 3
- Tray 4

(available only if **Tray 4** has been selected for **Paper Source Options** on the Printer tab)

EMF Spooling *(for Windows NT 4.0/Windows 2000 drivers only)*

Check the check box to allow the print job to be output in vector graphic mode.

Enabled only if **Vector** has been selected for **Graphics Mode** on the Graphics tab.

Restore Defaults

Restore the settings in the dialog box to their default values.

Graphics



Windows 95/Windows 98/Windows Me



Windows NT 4.0/Windows 2000

The Graphics tab has option settings that affect the quality of a printed output. Notice that there is a visual representation of the selected graphics mode.

Clicking the image will toggle both the radio button and the image display selections.

Graphics Mode

The graphics mode option enables you to optimize graphics printing, increase speed and improve print quality. Options include:

➤ Raster

Graphics are sent to the printer as bitmap raster images (i.e. images composed of individual dots). The printed output may appear to be a closer match to the screen image than the other mode, but printing is slower.

➤ Vector (default)

Graphics are sent to the printer as a combination of vector and raster images. This mode enables images to be printed faster but not all graphic images can be printed using this mode. If the printed graphic images do not appear the same way as they did on your screen, select **Raster** and reprint your graphic.

Halftone

Halftone refers to a type of pattern that is applied to the printed image. By using a combination of black dots, these patterns produce a grey appearance on the printed image.

This Halftone feature is designed to process images (e.g. photographs) but not computer generated art (e.g. clip art). The appearance of the printed image will vary depending on the Halftone settings. The best way to select a Halftone setting for your graphic image is to experiment. Print a graphic image at each setting and choose the one you like best.

Note the different options available for the different drivers.

For Windows 95/Windows 98/Windows Me:

➤ Device (default)

Uses the default printer Halftone attributes to produce the image objects.

- **Line Art**

Provides solid lines and sharp contrasts between shaded areas. It is usually used for images with fine lines.
- **Fine**

Provides smooth shades of grey.
- **Coarse**

Provides rough greyscale with high contrasts for images that will be scanned/copied.
- **Diffusion**

Ideal for photographic images. However, it requires more time to create the appearance of grey scale. Available only if **Raster** has been selected for **Graphics Mode**.

For Windows NT 4.0/Windows 2000:

- **Device (default)**

Uses the default printer Halftone attributes to produce the image objects. Available only if **Vector** has been selected for **Graphics Mode**.
- **System**

Enables the system to process the Halftone setting. Click **Halftone Color Adjustment** for system halftone color adjustment.

Image Enhancement (default: on)

Enhances the quality of the output image.

All Text to Black (default: off)

Sets the color of all text in the print job to black. If this is not selected, colors will be printed in varying degrees of grey. Disabled if **Print as Graphics** has been selected for **TrueType Font Mode**.

Draft Mode (default: off)

Reduces the amount of toner the printer uses by using less toner on each page.

When this is selected, text and graphics are printed in grey rather than black. It is suitable for the printing of drafts.

TrueType Font Mode

Select how the Windows TrueType fonts are to be processed. Options include:

- **Download as TrueType** (default)

The complete character set of the TrueType font contained on the page is sent to the printer in an outline form that the printer can understand and deal with directly. The downloaded fonts are vector-based, scalable typefaces.

- **Download as Bitmap**

Each TrueType character will be sent to the printer as an individual bitmap font. The downloaded fonts are raster-based, non-scalable typefaces.

- **Print as Graphics**

Prints TrueType texts as graphic images. The printed output may appear to be a closer match to the screen image than the other

options, though it may print slower. Enabled only if **Raster** has been selected for **Graphics Mode**.

Use Printer TrueType Fonts (default: on)

When this is selected, printer-resident fonts will be used and the fonts will not be downloaded to the printer, unless they are not present on the printer. This frees memory and speeds up printing. Disabled if **Print as Graphics** has been selected.

Halftone Color Adjustment (for Windows NT 4.0/Windows 2000 only)

Click to display the Halftone Color Adjustment dialog box for setting the color adjustment values that are used to adjust the color of bitmap images for printing. Color adjustments affect certain attributes of the image, such as contrast and brightness. Enabled only if **System** has been selected for **Halftone**.

Restore Defaults

Restore the settings in the dialog box to their default values.

Layout



The Layout property provides six job finishing features for you to modify the printed layout of a document. Notice that an image is displayed for each type of layout mode selected and which also indicates the current page orientation.

Layout Mode

Provides a list of the job finishing options:

- Multi-Up (default)
- Booklet Creation
 - (available only if **Duplex Module** has been selected on the Printer tab)
- Fit To Output Size
- Zoom
- Change Output Size (No Zoom)
- Poster

Selecting each of the features will display one of the following corresponding options:

(1) Multi-Up

(available when Multi-Up has been selected for Layout Mode)

The Multi-Up function allows more than one page to be printed on the same paper.

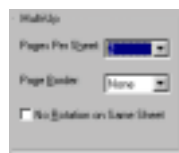

Pages Per Sheet (default: 1)

Lists the possible pages per sheet for the Multi-Up printing function: 1, 2, 4, 6, 9, 16.

Page Border

To provide options of printing each document page with a page border:

➤ None (default)

Border is not applied.

➤ Grid

A rectangle is drawn to divide each document page on the paper output.

➤ Shadow

A rectangle with drop shadow effect is drawn around each document page.

Enabled when more than 1 has been selected for **Pages Per Sheet**.

No Rotation on Same Sheet (default: off)

Defines how the Multi-Up document pages of different orientations are to be handled on the same printed sheet. In general, the first document page of each sheet will determine the physical orientation of that output sheet.

When this is not selected, images that have a different orientation from the first document page will be rotated for best fit on the same sheet with minimum size reduction.

When this is selected, images that have a different orientation from the first document page will be scaled down further without page rotation, so as to keep the same viewing orientation as the first document page on the same sheet.

Enabled when more than 1 has been selected for **Pages Per Sheet**.

(2) Booklet Creation

(available only when Booklet Creation has been selected for Layout Mode)

This function allows the document to be printed as a booklet. Document pages are re-ordered and printed 2-Up on each sheet of paper. This allows the output sheets to be stacked and folded to form a booklet, and the pages will appear in the correct order.



When this feature is chosen in Layout Mode, the following dialog box will be displayed if **Flip on Short Edge** has not been selected for **2 Sided Print** on the Paper/Output tab:

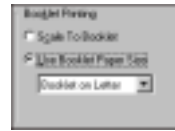

Take note of the message and click **OK** to proceed.

Booklet Creation

There are two types of booklet creations:

➤ **Fit To Paper Size (default)**

Allows a non-booklet document to be printed as a booklet. Each document page is scaled down and printed to fit the booklet output using a paper size that is defined by the document.

➤ **Use Booklet Paper Size**

Selecting this option will change the current Paper Size setting in the driver to a specified booklet size. This selection applies only to documents that are printed using the paper size defined in the driver as the target paper output. It does not affect the normal printout of a document unless the document is created or formatted as a booklet on a specific paper size. The application is presented with a special paper size such as Booklet on A4. Using these sizes means that the application is formatting the data for the target paper size. The booklet document is therefore printed without scaling the pages. The options available for creating a booklet document are:

- Booklet on A4 (default)
- Booklet on Letter
- Booklet on A3
- Booklet on Ledger

Gutter (default: 0)

Gutter is the spacing in dots between two document pages on a sheet of paper. Valid range is from 0 to 150 dots.

Pages Per Split (default: No Limit)

Pages Per Split is the number of pages to be printed as a booklet. The number will be in multiples of 4. Options include 4, 8, 12, 16, No Limit. When No Limit is selected, all pages will be output in one booklet.

(3) Fit To Output Size

(available when Fit To Output Size has been selected for Layout Mode)

This feature allows you to print on a paper size that is different from the page size designated in your document. The document page will be scaled and printed on a smaller or larger paper.



Fit to Output Size (default: A4 (210×297 mm) 8.27x11.7")

Lists the possible paper sizes that can be used. The options available for the paper size are similar to the settings of **Paper Size** on the Paper/ Output tab.

(4) Zoom

(available when Zoom has been selected for Layout Mode)

This will enlarge or reduce your document page for printing.

**Zoom%** (default: 100%)

Define a zoom% of between 50 to 400% for enlargement (>100%) or reduction (<100%) of your page.

Page Position

Select the position where the document page is to be printed on the output:

- Top Left
- Top Right
- Center (default)
- Bottom Left
- Bottom Right

(5) Change Output Size (No Zoom)

(available when Change Output Size (No Zoom) has been selected for Layout Mode)

This feature allows you to print on a paper size that is different from the page size designated for your document. The document page will be scaled and printed on a smaller or large paper size.

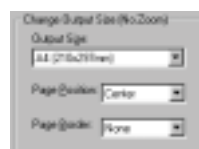
**Output Size** (default: A4 (210×297 mm) 8.27x11.7")

Lists the possible paper sizes that can be used. The options available for the paper size are similar to the settings of Paper Size on the Paper/ Output tab.

Page Position

Specify the position where the document page is to be printed on the output:

- Top Left
- Top Right

- Center (default)
- Bottom Left
- Bottom Right

Page Border

To provide options of printing each document page with a page border:

- None (default)
 - Border is not applied.
- Shadow
 - A rectangle with drop shadow effect is drawn around each document page.

(6) Poster

(available when Poster has been selected for Layout Mode)

This feature allows you to enlarge proportionally and print the image of each document across multiple pages.



NOTE: Depending on the paper size to be used and the image size to be output, you may not be able to carry out printing. When this happens, reduce either the paper size or image size, and then print again.

Style

Select the number of times of its page size to enlarge or a zoom% (under Custom) to define the style:

- 2 x 2 (default)
- 3 x 3
- 4 x 4
- Custom

Overlap (default: 100)

Define the overlapped width between each enlarged image across different page. The width can be set between 0 - 150 dots.

Page Position

Select the position where the document page is to be printed on the output:

- Top Left
- Top Right
- Center (default)
- Bottom Left
- Bottom Right

Overlays



The Overlays function is meant for printing one or more objects (texts/graphics) on every page of your document, e.g. letterhead, logo. An Overlay object is created within one page, and is usually known as a page overlay. Once created and stored in your computer, a page overlay can be invoked upon request and eliminates the need to download the same information over and over again, thus saving transmission time.

Load Overlay

When you want to use a file from an external source as an overlay, click this button to inform the overlay manager of the file and its location.

NOTE: If you source an external file from a floppy disk and then remove the disk from the disk drive, the file will no longer be available as an overlay. If you intend to use this file regularly, it is recommended that you copy the file to your system local disk before using this button.

Create Overlay

Creates and stores a Page Overlay from a file containing the overlay that you want.

See *“Printing Data Combined Using Overlays”* on page 3-16. for more details on creating overlays.

Delete Overlay

To delete an overlay, select it in the Overlay list box, and click **Delete Overlay**. Click **Yes** to confirm deletion and **No** to abort the action.

Delete All

Deletes all overlays from any or all of the destinations.

Query Page Overlay

When this is selected, a message box requesting confirmation will appear whenever a page overlay command is sent to the printer. If this option is off, the selected page overlay file will be sent directly to the printer.

NOTE: This option is not active if No Overlay is selected or if the currently selected overlay has been permanently downloaded to the printer.

Selected Overlay Details

Displays information on the selected overlay.

Overlay Creation Status

Displays information regarding the creation of overlays.

Watermarks



The Watermarks feature allows you to print text in the background or foreground of a page. Watermarks can be applied to the first page or all pages of a document. A selection of pre-defined watermarks is available. You can modify these or add new ones to the list.

To create a watermark:

1. Specify the text for the watermark in **Text** (maximum 32 characters).
2. Select **Fonts** to display the Font dialog box and specify the font, font style and size. Font style includes regular, italic, bold and bold italic; size ranges from 6-300.
3. Select **Color** to display the Color dialog box and specify/create the required color.
4. Specify the position and angle of the text by adjusting the Angle scrollbar (-90 to +90 degrees) and the scrollbar just below the preview window which moves the x and y position values. These position values are in the 1/100ths (0.01) of an inch and are offsets from the page centre. To reset the position to the paper origin, press **Center Watermark**.
5. Click **Add** to add the new watermark to the Watermark list.

To edit a watermark:

1. Select an existing watermark from the Watermark drop-down list.
2. Make changes to it as required.
3. Click **Update** to replace the previous version or **Add** to save a modified version of the watermark.

To delete a watermark:

1. Select an existing watermark from the Watermark drop-down list.
2. Click **Delete** to remove the watermark from the list.

To print a watermark, the options available include:

In Background

Selecting this prints the watermark underneath the primary texts and graphics in the document. Otherwise the watermark will be printed on top of all images in the document. Disabled if **As Outline Only** has been selected.

First Page Only

Selecting this prints watermark on the first page of the document only. Otherwise the watermark will be printed on all pages.

As Outline Only

Selecting this prints the text outline of the watermark which is always printed on top of all document images. Disabled if **In Background** has been selected.

Fax Options



The Fax Options tab enables you to specify the fax attributes to be used by the printer when sending a fax job.

The options on this tab are enabled only if all of the following conditions are met:

- (1) **Fax Module has been selected on the Printer tab;**
- (2) **Fax has been selected for Job Type on the Paper/Output tab.**

Fax Resolution

Specify the fax resolution for fax transmission. Options include:

- Normal - 100×200 dpi
- Fine - 200×200 dpi (default)
- Super Fine - 400×400 dpi
- Super Fine - 600×600 dpi

Transmission Report

Specify whether to generate a report for fax transmission. Options include:

- Report Always
- Report On Error (default)
- No Report

Send Header (default: off)

Specify whether to send the fax job with a header.

Fax Phonebook

Click to display the Fax Phonebook dialog box which enables you to store and retrieve fax recipient information.

The default fax phonebook (Default.AFD) will be automatically selected and opened as the current fax phonebook each time the Fax Phonebook dialog box is opened.

Fax phonebook data file will be created in Able Fax Data (AFD) file extension format.



To create a new fax phonebook:

If there are no entries in the current fax phonebook, simply follow the procedure below to create entries for it.

If there are existing entries, click **New Phonebook** on the Fax Phonebook dialog box. The standard Windows' New dialog box will appear for you to enter a new file name. A new Fax Phonebook dialog box will then appear with the new file name and directory displayed on the title bar of the dialog box.

1. Proceed to create an entry for the fax phonebook by clicking **New**. The New Entry dialog box appears.



2. Determine the entry type you want to create by selecting **Individual** or **Group**, and click **OK**. Proceed to Step 3 if **Individual** has been selected or Step 4 if **Group** has been selected.

An *individual entry* stores information of an individual whereas a *group entry* contains a group of individual entries. The individual entries of the group must be created before they can be assigned to a group entry.

3. When **Individual** has been selected for **Entry Type**:

The New Individual Entry dialog box appears.

By referring to the following explanation, enter the properties of the individual entry and then click **OK**. Then proceed to Step 5.



Name

The name of the fax recipient. You can enter up to 30 characters here, including numbers, letters and spaces.

Company

The name of the company or organization of the fax recipient. You can enter up to 59 characters here.

Fax

The fax number of the fax recipient. You can enter up to 30 characters here, including numbers, letters and "-" (which represents pause) for a fax number.

Characters that cannot be entered include "[", "]", "{", "}", "|", "~", ",", and spaces.

All letters entered will be displayed in upper case.

When dialing the fax number, the letters will be translated into numbers as follows:

ABC -> 2, DEF -> 3, GHI -> 4, JKL -> 5, MNO -> 6, PQRS-> 7, TUV-->8, WXYZ-->9.

Comm. Settings

Click this button to display the Communication Setting dialog box for entering detailed communication settings for the fax recipient.

Communication Mode

Select a communication protocol for sending the fax job. Options include:



- G3-Auto (default)
- F4800

F Code

An optional input for specifying the fax job. You can enter up to 20 numbers here.

Password

An optional input for specifying the fax job. You can enter numbers, and the characters "#" and "*". Each character entered will be displayed as "*" .

Secure Send



Check this check box to send a secure fax job to a particular mail box where a password can be assigned to access the designated mail box. The following options will be available when **Secure Send** has been selected:

Mailbox ID (1-200)

A mandatory numeric code that identifies the designated mail box. Enter any number from 1 to 200.

Mailbox Password

An optional password to access the fax job received at the designated mail box. Enter any 4-digit number.

Relay Send

Check this check box to send a relay fax job to a maximum of 20 destinations via a relay station. The following options will be available when **Relay Send** has been selected:

Relay Station ID (1-99)

A mandatory numeric code that identifies a relay station. Enter any number from 1 to 99.

Print at Relay Station

Check this check box if you want to print the fax job at the relay station.

Group Send

Check this check box if you want to send the fax job as a group. When this has been checked, **Destination ID** will specify a Destination Group ID which ranges from 1-9.

When this has not been checked, **Destination ID** will specify an individual ID which ranges from 1-99.

Destination ID

A numeric code that identifies a destination or a group of destinations. After entering a Destination ID, click **Add To->** to enter the ID to **Destination List**. Click **Remove** to remove the ID from **Destination List**.

Destination List

The list of Destination IDs that will receive the relay fax job. At least 1 and up to 20 Destination IDs must be entered here. When **Group Send** has been selected, the Destination ID (1 digit) entered here will be preceded by a "0" and "#" to form a 3-digit code.

When **Group Send** has *not* been selected, the Destination ID (2 digits) entered here will be preceded by a "0" to form a 3-digit code.

Tel.

The telephone number of the fax recipient. You can enter up to 46 characters here, including numbers, letters and "-".

E-mail

The e-mail address of the fax recipient. You can enter up to 59 characters here.

Memo

About other information about the fax recipient. You can enter up to 254 characters here.

4. When **Group** has been selected for **Entry Type**:

The New Group Entry dialog box appears.

Use this dialog box to create a group entry consisting of individual entries.

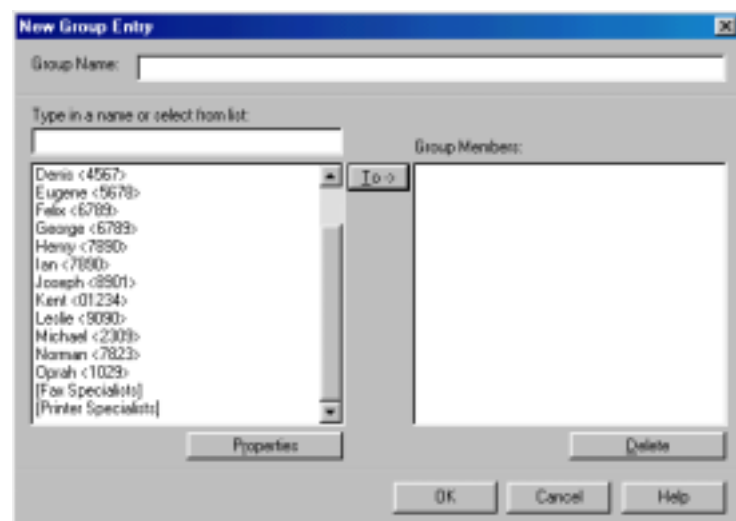

- i. First, enter a name for the group entry of fax recipients at the edit box, **Group Name**.

You can enter up to 30 characters here, including numbers, letters and spaces.

- ii. Assign individual entries to **Group Members**.

You can do this by selecting the required individual or group entry in the list box on the left, and then either click **To->** or double-click the entry to add it to **Group Members**. A group entry added to **Group Members** will not appear as a group entry anymore. Instead each individual entry of the group will be individually displayed.

If the entries list in the list box are too long, you can enter an entry name at the edit box, **Type in a name or select from list**. The contents of the list box will be scrolled so that either the entered entry appears at the top of the list box or the maximum scroll range is reached.

- iii. To delete any entry from **Group Members**, select the entry and then click **Delete**. You will be prompted by a confirmation message. Click **Yes** to continue.

If you need to edit an entry in the list box, select the entry and

then click **Properties**.

If an individual entry has been selected, an Edit Individual Properties dialog box will be displayed.



The example on the left shows the individual properties dialog box of the individual entry, Norman.

Edit the necessary items and then click **OK**.

If a group entry has been selected, a group properties dialog box will be displayed.



The example on the left shows the group properties dialog box of the group entry, Printer Specialists.

To edit the individual entry properties of this group entry, simply select the entry and then either click **Properties** on this group properties dialog box or double-click on the entry. The Edit Individual Properties dialog box will then be displayed. Edit the necessary items and then click **OK**.

Click **Close** after all the individual entries have been edited.

- iv. Click **OK** to close the New Group Entry dialog box.
5. Repeat Steps 1 to 3 or 4 until all the entries of the fax phonebook are created.

All created entries will be displayed in Fax Phonebook dialog box.



6. Click **Close** to save the fax phonebook.

You can also save the current fax phonebook with another name by clicking **Save Phonebook As**. The standard Windows' Save As dialog box will appear for you to enter a new file name.

To open an existing fax phonebook:

On the Fax Phonebook dialog box, click **Open Phonebook** to display the standard Windows' Open dialog box for you to select an existing fax phonebook to open.

To edit a current fax phonebook:

Use the following controls on the Fax Phonebook dialog box to edit a current fax phonebook:

Type in a name or select from list

Enter an entry name at this edit box to check the entry if the entries list in the list box are too long. The contents of the list box will be scrolled so that either the entered entry appears at the top of the list box or the maximum scroll range is reached.

New

Click to add a new entry for the fax phonebook.

Refer to the above procedure on "To create a new fax phonebook".

Properties

Click to edit the selected entry.

If an individual entry has been selected, the Edit Individual Properties dialog box will be displayed for you to edit the individual properties. If a group entry has been selected, the Edit Group Properties dialog box will be displayed instead. The following example shows the Edit Group Properties dialog box when Printer Specialists has been selected.

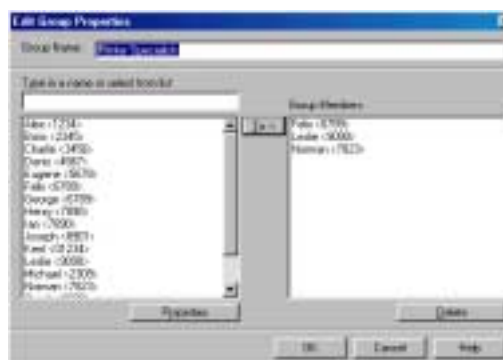

Delete From Phonebook

Click to delete a selected entry from the phonebook.

If an individual entry has been deleted, any entry of it in a group will also be deleted.

If a group entry has been deleted, the individual entries that made up the group will *not* be deleted.

Import To Phonebook

Click to display the Import Fax Recipient Data dialog box which enables you to import entries from an external database to the fax phonebook. Refer to "Importing from fax recipient data" of *"Entering Recipient List"* on page 3-27 for details.

5 *Mode Menu and Common Menu*

The following information can be found in this chapter:

- Menus
- Mode Menu Items
- Common Menu Items
- Outputting Reports/Lists
- CentreWare Internet Services
- Checking Printer Status via E-Mail

Menus

This section explains about the types and levels of menu.

About menu

There are two types of menus: mode menu and common menu.

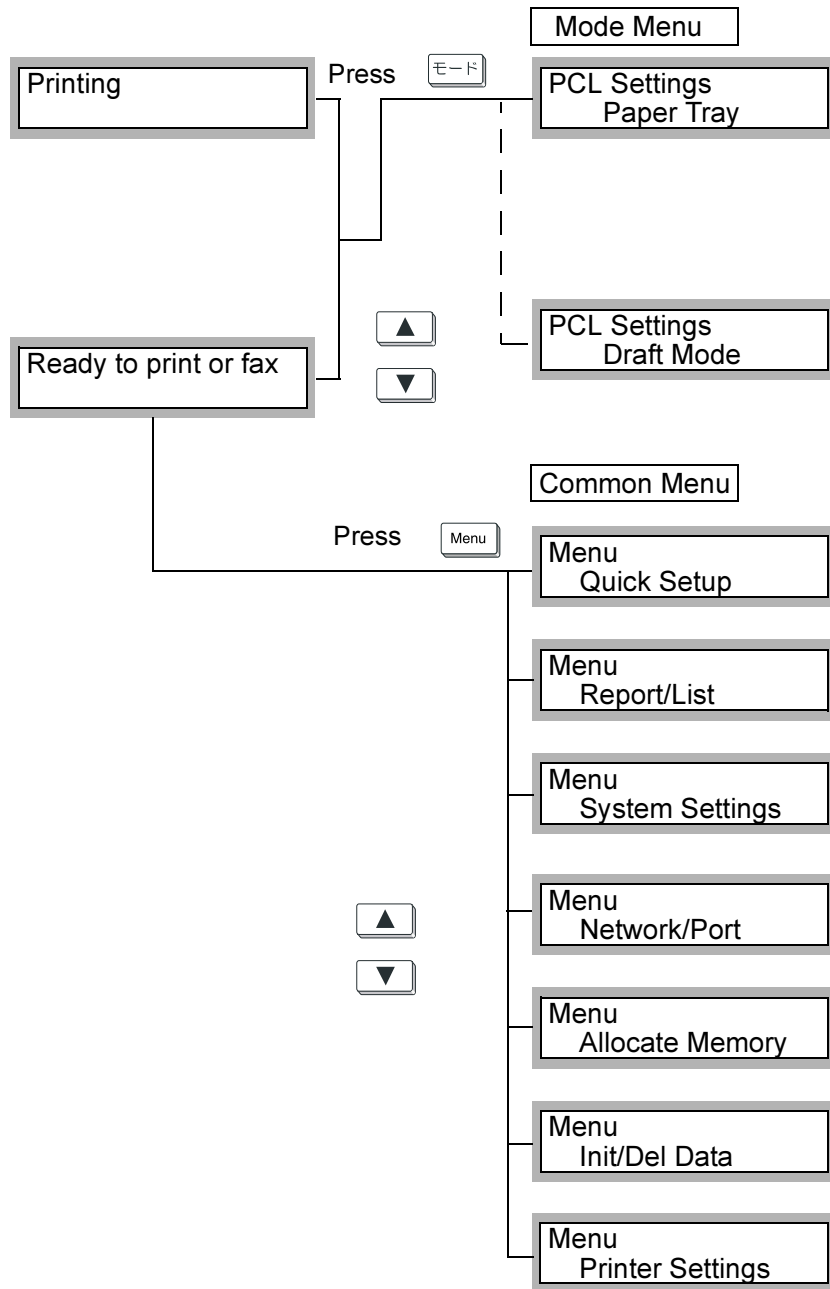





Common Menu	Overview	Reference
Quick Setup	By following the flow, sets the basic essential settings needed to use the printer.	See "Using Quick Setup Menu" on page 2-11.
Report/List	Prints the PCL Settings, Printer Settings, Error History, Job History, Print Meter, PCL Font Lists etc.	See "Types of reports/lists" on page 5-30.
System Settings	Sets the operation settings like fault tone, system clock, etc.	See "List of common menu items" on page 5-10.
Network/Port	Sets the interface type to connect to computer, and the essential settings for transmission. You cannot select other settings for a port that has been set to Disable.	See "List of common menu items" on page 5-10.
Allocate Memory	Changes the memory for each of the interface. You cannot change the memory for a port that has been set to Disable.	See "List of common menu items" on page 5-10.
Initialize/Delete Data	Initializes NVM, Hard Disk and Print Meter.	See "List of common menu items" on page 5-10.
Printer Settings	Sets settings related to paper and paper tray.	See "List of common menu items" on page 5-10.

Menu Navigation

With "Ready to print or fax" displayed, access to the menus is through the ^{Menu} button for common menu items and the ^{Mode} button for PCL settings.

When you are in the menu system, you can navigate through the tree-like structure using arrow keys.

- The  and  buttons move up and down a column.
- The  and  buttons move between columns.
- The  is used to select an item (* shows beside item).

For some selections, IP Address for example, you can use the left and right arrows to move between the character.

Where values have to be entered, you can use the up and down arrows to increment or decrement the value. If you keep your finger on a button, the number will change automatically.

Mode Menu Items





This section explains the values that can be set in each of the mode menu items and the setting method.

List of Mode Menu items

See “PCL Settings” on page 5-5 for a description of the item and possible settings.

The procedure to set a mode menu (PCL Settings) is as follows:

1. With “Ready to print or fax” displayed, press the ^{Mode} button.

 to move down a column.   to move between columns.  to select an item (* shows beside item).		
Paper Tray	Auto	Possible settings
	Tray 1	Possible settings
	Tray 2	Possible settings
	Tray 3	Possible settings
	Tray 4	Possible settings
	Bypass tray	Possible settings
Output	Center tray	
	Side tray	
	Finisher tray	
Orientation	Portrait	
	Landscape	
2-Sided	Off	
	On	Long Edge flip
		Short Edge Flip
Font	Possible settings	
Symbol Set	Possible settings	
Font Size	Possible settings	
Font Pitch	Possible settings	
Form Lines	Possible settings	
No. of Sets	Possible settings	
Image Enhance	On	
	Off	
Hex Dump	On	
	Off	
Draft Mode	On	
	Off	

2. Make changes as required.
3. Press the ^{Menu} button to accept the changes and re-initialize the printer.

PCL Settings

Menu item	Explanation
Paper Tray	<p>Sets the paper tray that supplies paper. The possible settings are:</p> <ul style="list-style-type: none"> • Auto (default) Supplies paper from a selected tray among trays which have been loaded with the paper size set in the Paper size selection. However, the bypass tray cannot be set for automatic paper supply. • Tray 1 • Tray 2 • Tray 3 • Tray 4 • Bypass Tray Supplies paper from the bypass tray. In this case, the paper size specified in Paper size selection must be loaded in the bypass tray. This option is displayed when the bypass tray has been installed. <hr/> <p>NOTE: When Auto is selected and the same size of papers are set in the same direction in multiple trays, the paper tray retrieved will be in the order of Tray 1, Tray 2, Tray 3 and then Tray 4.</p> <hr/> <ul style="list-style-type: none"> • The values set are changeable by commands. • The setting takes on default value when the NVM is initialized. <p>When Tray 1 to Tray 4 are selected, the Paper size selection cannot be set. When Bypass Tray is set and the wrong paper size is confirmed, a message requesting the specified paper size will appear in the control panel.</p>
Output	<p>Sets to output with printed page facing up or down. The possible settings are:</p> <ul style="list-style-type: none"> • Centre Tray (default) Outputs with the printed side facing down. Also, when printing two-sided pages, the odd-numbered pages will be facing down. • Side Tray Outputs with the printed side facing up. In addition, during two-sided printing, the odd-numbered pages will be facing down. • Finisher Tray <hr/> <p>NOTE: The values set are changeable by commands. The setting takes on default value when the NVM is initialized.</p>
Orientation	<p>Sets the orientation for printing. The possible settings are:</p> <ul style="list-style-type: none"> • Portrait (default) • Landscape. <hr/> <p>NOTE: The values set are changeable by commands. The setting takes on default value when the NVM is initialized.</p>

Menu item	Explanation
2 Sided Print	<p>Sets two-sided printing. The possible settings are:</p> <ul style="list-style-type: none"> • Off (default) • On which includes another set of options on Binding Edge: <ul style="list-style-type: none"> • Long Edge Flip (default) • Short Edge Flip <hr/> <p>NOTE: The values set are changeable by commands.</p> <hr/> <ul style="list-style-type: none"> • The setting takes on default value when the NVM is initialized. <p>Paper supply from the bypass tray cannot be used for two-sided printing. Also, even if Bypass Tray is set for Paper Tray when two-sided printing is specified, the printing will be in one-sided.</p>
Font	<p>Sets the font to be the default. The possible settings are (0 - 80):</p> <ul style="list-style-type: none"> • 0 - CG Times • 1 - CG Times It • 2 - CG Times Bd • 3 - CG Times Bdlit • 4 - Univers Md • 5 - Univers Mdlt • 6 - Univers Bd • 7 - Univers Bdlit • 8 - Univers MdCd • 9 - Univers MdCdlt • 10-Univers BdCd • 11-Univers BdCdlt • 12-AntiqueOlv • 13-AntiqueOlv It • 14-AntiqueOlv Bd • 15-CG Omega • 16-CG Omega It • 17-CG Omega Bd • 18-CG Omega Bdlit • 19-GaramondAntiqua • 20-Garamond Krsv • 21-Garamond Hlb • 22-GaramondKrsvHlb • 23-Courier (default) • 24-Courier It • 25-Courier Bd • 26-Courier Bdlit • 27-LetterGothic • 28-LetterGothic It • 29-LetterGothic Bd • 30-Albertus Md • 31-Albertus XbBd • 32-Clarendon Cd • 33-Coronet • 34-Marigold • 35-Arial • 36-Arial It • 37-Arial Bd • 38-Arial Bdlit • 39-Times New

Menu item	Explanation
Font (con't...)	<ul style="list-style-type: none"> • 40-Times New It • 41-Times New Bd • 42-Times New BdIt • 43-Symbol • 44-Wingdings • 45-Line Printer • 46-Times Roman • 47-Times It • 48-Times Bd • 49-Times BdIt • 50-Helvetica • 51-Helvetica Ob • 52-Helvetica Bd • 53-Helvetica BdOb • 54-CourierPS • 55-CourierPS Ob • 56-CourierPS Bd • 57-CourierPS BdOb • 58-SymbolPS • 59-Palatino Roman • 60-Palatino It • 61-Palatino Bd • 62-Palatino BdIt • 63-ITCBookman Lt • 64-ITCBookman LtIt • 65-ITCBookmanDm • 66-ITCBookmanDm It • 67-HelveticaNr • 68-HelveticaNr Ob • 69-HelveticaNr Bd • 70-HelveticaNrBdOb • 71-N C Schbk Roman • 72-N C Schbk It • 73-N C Schbk Bd • 74-N C Schbk BdIt • 75-ITC A G Go Bk • 76-ITC A G Go BkOb • 77-ITC A G Go Dm • 78-ITC A G Go DmOb • 79-ZapfC MdIt • 80-ZapfDingbats

Menu item	Explanation
Symbol Set	<p>Sets the specific set of symbols provided by a font with each symbol set defined with a specific application in mind.</p> <p>There are altogether 34 internal symbol sets:</p> <ul style="list-style-type: none"> • ROMAN-8 (default) • ISO-L1 • ISO-L2 • ISO-L5 • ISO-L6 • PC-8 • PC-8 DN • PC-775 • PC-850 • PC-852 • PC-1004 • PC-8 TK • WIN L1 • WIN L2 • WIN L5 • DESKTOP • PS TEXT • MC TEXT • MS PUB • MATH-8 • PS MATH • PI FONT • LEGAL • ISO-4 • ISO-6 • ISO-11 • ISO-15 • ISO-17 • ISO-21 • ISO-60 • ISO-69 • WIN 3.0 • WINBALT • SYMBOL • WINGDINGS <hr/> <p>NOTE: Available only to all True Type typeface, and to the four Bitstream Dutch 801 SWC (CG Times), the four Bitstream Swiss 742 SWC (Univers), the four Bitstream Fixed Pitch 810 Courier SWC (Courier), and the three Fixed Pitch 850 Letter Gothic 12 pitch/text SWC (Letter Gothic) typefaces.</p> <hr/> <p>Proper selection of Symbol Set is important in printing the required output.</p>
Font Size	<p>Sets the height of the font in points.</p> <p>The range of setting is between 4 to 50. Default is 12 and each unit is 0.25.</p> <hr/> <p>NOTE: The point size item available depends on the fonts source and font number selected.</p> <hr/> <ul style="list-style-type: none"> • The values set are changeable by commands. • The setting takes on default value when the NVM is initialized. • This item is ignored in the selection of a fixed-space scalable font. It is saved and is available when a bitmap font or a proportionately-spaced scalable font is selected.

Menu item	Explanation
Font Pitch	<p>Sets the pitch of the font in characters per inch. The range of setting is between 6 to 24. Default is 10.00 and each unit is 0.01.</p> <p>NOTE: Pitch is the horizontal spacing of a fixed-space (bitmap or scalable) font in terms of number of characters per inch. This characteristic is ignored when selecting a proportionately-spaced (bitmap or scalable) font but is saved in the font select table and available when a fixed spaced font is selected.</p>
Form Lines	<p>Sets the page length (printing area) of one page. The range of setting is between 5-128 lines with 1 line per unit. Default is 64.</p> <p>NOTE: The values set are changeable by commands. The setting takes on default value when the NVM is initialized.</p>
No. of Sets	<p>Sets the number of output copies. The range of setting is between 1-999 copies. Default is 1 and each unit is 1.</p> <p>When there is a specific number of sets output from the host device, this value can be displayed and printed out. Also, it can be changed on the setting of the operator panel. However, the number of sets specified as output from Netware, lpd and AppleTalk cannot be changed.</p> <p>If there is instruction from the host device regarding the number of copies, that value will be reflected and printed. After printing, the setting of the control panel will be overwritten by that value.</p> <p>However, the number of copies specified by Netware, lpd, or AppleTalk will not overwrite the value at the control panel.</p>
Image Enhance	<p>Enables or disables image enhancement. Image enhancement raises the resolution to produce smooth print of sharp edges. The possible settings are:</p> <ul style="list-style-type: none"> • On (default) • Off <p>NOTE: The values set are changeable by commands. The setting takes on default value when the NVM is initialized.</p>
HexDump	<p>Turns on/off the Hex(adecimal) Dump mode. Turning on the HexDump mode allows data that are sent to the printer to be printed in plain ASCII format. The possible settings are:</p> <ul style="list-style-type: none"> • Off (default) • On <p>NOTE: Turning on the HexDump mode allows data that are sent to the printer to be printed in plain ASCII format. It will not be interpreted by the emulation. HexDump is used for troubleshooting. HexDump is supported in the Parallel, LPD and Netware interfaces.</p>
Draft Mode	<p>Turns the Draft Mode on and off. The possible settings are:</p> <ul style="list-style-type: none"> • Off (default) • On <p>NOTE: Draft mode causes the printer to use less of toner. As a result, pages printed with Draft mode turned on will be lighter than pages printed with it turned off. This feature can be used to print draft-quality documents so as to extend the life of your toner cartridge. Draft mode will not affect the speed or performance of your printer. The setting takes on default value when the NVM is initialized.</p>

Common Menu Items

This section explains the values that can be set in the common menu items and the setting method.

List of common menu items





See “System Settings” on page 5-15 for a description of the item and possible settings.

The values of System Settings, NetWork/Port, Allocate Memory, Initialize/Delete Data and Printer Settings are as follows:

This section explains the values that can be set in each of the mode menu items and the setting method.

The procedure to make Common Menu Settings is as follows:

1. With “Ready to print or fax” displayed, press the  button.

 to move down a column.   to move between columns.  to select an item (* shows beside item).			
Quick Setup	See “Using Quick Setup Menu” on page 2-11.		
Report list See page 5-30.	PCL Settings	Print	
	Printer Settings	Print	
	Error history	Print	
	Job History	Print	
	Print Meter	Print	
	PCL Font List	Print	
	Stored Documents	Print	
	PS Font List	Print	
	PS Logical	Print	
	Job Template	Print	
	Domain List	Print	
System Settings See page 5-15.	Fault Tone	Off	
		On	
	Panel Lock	Off	
		On	Enter/Confirm Password
	Change Password	Enter/Confirm Password	
	AutoCancelPause	Off	
		1 Mins	
		2 Mins	
		3 Mins	
		to 30 Mins	
	System Clock	Set Date	Enter date
		Set Time	Enter Time
		Set Time Zone	Possible settings
		Set Summer Time	Off
			On
		Start Date	Enter date
End Date	Enter date		

	Auto Job History	Do not Print	
		Print	
	2-Sided report	1-Sided	
		2-Sided	
	Print Area	Normal	
		Extended	
NetWork/Port See page 5-16.	Parallel	Port Status	Enable
			Disable
		Print Mode	Auto
			PCL
			PS
		PJL	Enable
			Disable
		Adobe Protocol	Normal
			Binary
			TBCP
		Auto Eject Time	Enter Time
		Bi-directional	Enable
	Disable		
	LPD	Port Status	Enable
			Disable
		Print Mode	Auto
			PCL
			PS
		PJL	Enable
			Disable
		Connect Time Out	Enter Time
		TBCP Filter	Enable
			Disable
		IP Filter	Off
			On
	IP List	Filter 1	
		Filter 2	
		to Filter 10	
	Netware	Port Status	Enable
			Disable
		Transpt Protocol	TCP/IP, IPX/SPX
			TCP/IP
			IPX/SPX
Print Mode		Auto	
		PCL	
		PS	
PJL		Enable	
		Disable	
No. of Search	No Limit		

			100
			1
		TBCP Filter	Enable
			Disable
	SMB	Port Status	Enable
			Disable
		Transpt Protocol	TCP/IP, NetBEUI
			TCP/IP
			NetBEUI
		Print Mode	Auto
			PCL
			PS
		PJL	Enable
			Disable
		TBCP Filter	Enable
			Disable
	IPP	Port Status	Enable
			Disable
		Print Mode	Auto
			PCL
			PS
		PJL	Enable
			Disable
		TBCP Filter	Enable
			Disable
		Access Control	Enable
			Disable
		DNS	Enable
			Disable
	Add Port No.	80	
		0	
		9999	
	Connect Time Out	60 - 0 Secs	
		65535 - 61 Secs	
	USB	Port Status	Enable
			Disable
		Print Mode	Auto
			PCL
			PS
		Adobe Protocol	Normal
		Binary	
		TBCP	
	Auto Eject Time	Enter Time	
	Port9100	Port Status	Enable
			Disable



		Print Mode	Auto
			PCL
			PS
		PJL	Enable
			Disable
		Port No.	9100 to 8000
			9999 to 9101
	TBCP Filter	Enable	
		Disable	
	Connect Timeout	60 - 0 Secs	
		65535 - 61 Secs	
	EtherTalk	Port Status	Enable
			Disable
		PJL	Enable
			Disable
Salutation	Port Status	Enable	
		Disable	
FTP Client	Port Status	Enable	
		Disable	
SNMP	Port Status	Enable	
		Disable	
	Transpt Protocol	UDP	
		IPX	
		IPX, UDP	
	Community (R)	Enter Name	
Community (R/W)	Enter Name		
Community (Trap)	Enter Name		
Internet Service	Enable		
	Disable		
TCP/IP Settings	Get IP Address	DHCP	
		BOOTP	
		RARP	
		Manually	
	IP Address	000.000.000.000	
	Subnet Mask	000.000.000.000	
Gateway Address	000.000.000.000		
WINS Server	Get DHCP Address	On	
		Off	
	Primary IP	000.000.000.000	
Secondary IP	000.000.000.000		
IPX/SPXFrameType	Auto		
	Ethernet II		
	Ethernet 802.3		
	Ethernet 802.2		
	Ethernet SNAP		

	Ethernet	Auto		
		100BASE-TX		
		10BASE-T		
Allocate Memory See page 5-27.	PCL Memory	2.5 - 32 Mbyte		
	PS	4.5 - 32 Mbyte		
	Buffer Size	Parallel	64 - 1024 kbyte	
		LPD Spool	Off	
			Hard Disk	
			Memory	
		NetWare Memory	64 - 1024 kbyte	
		SMB Spool	Off	
			Hard Disk	
			Memory	
		IPP Spool	64 - 1024 kbyte	
			Off	
	Hard Disk			
USB Memory	64 - 1024 kbyte			
Port9100 Memory	64 - 1024 kbyte			
EtherTalk Memory	64 - 1024 kbyte			
Int/Del Data See page 5-28.	NVM	Initialize		
	Hard Disk	Initialize		
	Print Meter	Initialize		
Printer Settings See page 5-29.	Substitute Tray	Off		
		Larger Size		
		Nearest Size		

2. Make changes as required.
3. Press the ^{Menu} button to accept the changes and re-initialize the printer.

System Settings

Sets machine operations like fault tone, panel lock, system clock.



Menu item	Explanation
Fault Tone	<p>Sets whether to sound an alarm when a fault is detected in the machine. The possible settings are:</p> <ul style="list-style-type: none"> • Off (default) • On. <p>NOTE: The volume of the fault tone cannot be adjusted.</p>
Panel Lock	<p>Sets whether to lock the control panel with the use of a password. The possible settings are:</p> <ul style="list-style-type: none"> • Off (default) • On <p>When On is selected, you need to enter a 4-digit password to use the control panel.</p> <p>NOTE: When On has been selected and a password is not entered, a screen to enter the password appears. Enter a 4-digit password.</p>
Change Password	<p>Sets whether to change the password entered for Panel Lock. Enter a 4-digit password.</p> <p>NOTE: When you are pressing  or  to change the possible setting, press and hold on to the button to run the displays continuously. When both of these buttons are pressed together, the value will be reset to the factory setting. When Off has been selected for Panel Lock, you cannot change the password.</p>
AutoCancelPause	<p>Sets whether to exit the pause state automatically. The possible settings are:</p> <ul style="list-style-type: none"> • Off (default) • 1-30 Mins (each unit is 1 Min)
System Clock	<p>Sets the system clock, which is the printer built-in clock. The following items are to be set:</p> <p>Set Date Sets the date in YYYY/MM/DD format (YYYY: 2000-2099 only, MM: 01-12, DD: 01-31).</p> <p>Set Time Sets the time in HH:MM format (HH: 00-23, MM: 00-59).</p> <p>Time Zone (default: +09:00) Sets the time zone in GMT ±HH:MM format. The possible settings are: +12:00, +11:00, +10:00, +09:30, +09:00, +08:00, +07:00, +06:00, +05:30, +05:00, +04:30, +04:00, +03:30, +03:00, +02:00, +01:00, 00:00, -01:00, -02:00, -03:00, -03:30, -04:00, -05:00, -06:00, -07:00, -08:00, -09:00, -10:00, -11:00, -12:00.</p> <p>Set Summer Time Sets whether to enable summer time. The possible settings are:</p> <ul style="list-style-type: none"> • Off (default) • On <p>Start Date Sets the start date of summer time in mm/dd format (mm: 01-12, dd: 01-31). Can be set when Set Summer Time has been set to On.</p> <p>End Date Sets the end date of summer time in mm/dd format (mm: 01-12, dd: 01-31). Can be set when Set Summer Time has been set to On.</p>



Menu item	Explanation
Auto Job History	<p>Sets whether to automatically print the Job History, which contains information on print jobs processed. The possible settings are:</p> <ul style="list-style-type: none"> • Do not print (default) • Print <p>When Print is selected, the previous 50 print jobs which have not been output automatically before will be printed chronologically. Print jobs being processed or waiting to be processed will not be included.</p>
2 Sided Report	<p>Sets whether to print reports/lists on 1 or 2 sides of the paper when the Duplex Module has been installed. The possible settings are:</p> <ul style="list-style-type: none"> • 1 Sided (default) • 2 Sided
Print Area	<p>Sets whether to extend the print area when the PostScript Kit has been installed. The possible settings are:</p> <ul style="list-style-type: none"> • Normal (default) • Extended



NetWork/Port

Sets the conditions of the interface type connected to the computer and the transmission.

Menu item	Explanation
Parallel	<p>The following items are to be set when using the parallel port:</p> <p>Port Status Sets the port status of the parallel interface when the power is switched on. The possible settings are:</p> <ul style="list-style-type: none"> • Enable (default) • Disable <p>If the memory is not enough when the Port Status is set to Enable, it may be set to Disable automatically. When this happens, either set the Port Status of other ports not in use to Disable or change the memory allocation. If the Port Status still cannot be set to Enable, you are recommended to install the 64MB SDRAM for printer.</p> <p>Print Mode Sets the printer language. The possible settings are:</p> <ul style="list-style-type: none"> • Auto (default) The language to be used will be determined automatically • PCL • PS (available only when PostScript Kit is installed) <p>When the value is set to Auto, and if the printer language used cannot be found by the automatic printer language detection feature or it is not the selected printer language, the data may be erased.</p> <p>PJL Sets whether to enable the PJL commands sent from the computer. The possible settings are:</p> <ul style="list-style-type: none"> • Enable (default) • Disable

Menu item	Explanation
Parallel (con't...)	<p>Adobe Protocol Sets the PostScript protocol. Available only when PostScript Kit is installed. The possible settings are:</p> <ul style="list-style-type: none"> • Normal (default) For communication protocol in ASCII format. • Binary For communication protocol in binary format. Depending on the data, the print processing in this protocol may be faster than Normal. • TBCP (Tagged Binary Communications Protocol) For communication protocol in a mixture of ASCII or binary format which is switched by a specific control code. <hr/> <p>NOTE: Select the protocol to match the format of the data output by the printer driver.</p> <hr/> <p><i>For normal use, select Normal.</i></p> <p>Auto Eject Time Sets the time to automatically print and output any remaining data in the printer when it is in a continuous state of not receiving data. The range of setting is between 5-1275 seconds with 5 seconds per unit. Default is 30 seconds. When the next data is not received within the time set here after the last data has been received, it will be deemed as end of job.</p> <hr/> <p>NOTE: When you are pressing the  or  buttons to change the candidate value, press and hold onto the button to run the displays continuously. When both of the buttons are pressed together, the value will be reset to the factory setting.</p> <hr/> <p>Bi-directional Sets whether to enable the bi-directional communication (IEEE1284) for parallel interface. The possible settings are:</p> <ul style="list-style-type: none"> • Enable (default) • Disable





Menu item	Explanation
LPD	<p>The following items are to be set when using LPD:</p> <p>Port Status Sets the port status of the LPD interface when the power is switched on. The possible settings are:</p> <ul style="list-style-type: none"> • Enable (default) • Disable <hr/> <p>NOTE: To set LPD to Enable, you will need to set the IP address.</p> <hr/> <p>If the memory is not enough when the Port Status is set to Enable, it may be set to Disable automatically. When this happens, either set the Port Status of other ports not in use to Disable or change the memory allocation. If the Port Status still cannot be set to Enable, you are recommended to install the 64MB SDRAM for printer.</p> <p>Print Mode Sets the printer language. The possible settings are:</p> <ul style="list-style-type: none"> • Auto (default) The language to be used will be determined automatically • PCL • PS (available only when PostScript Kit is installed) <p>When the value is set to Auto, and if the printer language used cannot be found by the automatic printer language detection feature or it is not the selected printer language, the data may be erased.</p> <p>PJL Sets whether to enable the PJL commands sent from the computer. The possible settings are:</p> <ul style="list-style-type: none"> • Enable (default) • Disable <p>Connect Time-Out Sets the time to disconnect after data transmission is disrupted. The range of setting is between 2-3600 seconds with 1 second per unit. Default is 16 seconds.</p> <hr/> <p>NOTE: When you are pressing the  or  buttons to change the candidate value, press and hold onto the button to run the displays continuously. When both of the buttons are pressed together, the value will be reset to the factory setting.</p> <hr/> <p>TBCP Filter Sets whether to enable the TBCP filter when processing PostScript data. Available only when PostScript Kit is installed. The possible settings are:</p> <ul style="list-style-type: none"> • Enable • Disable (default) <p>IP Filter Sets whether to enable the filter for the IP address used for printing. The possible settings are:</p> <ul style="list-style-type: none"> • Off (default) • On <hr/> <p>NOTE: If all the IP addresses are registered as 000.000.000.000, this setting will not be in effect even if it is set to On.</p> <hr/> <p>IP List Registers the IP address and mask of the IP address receiving printing when the IP Filter is set to On. You can register up to 10 IP addresses and masks. Enter in the XXX.XXX.XXX.XXX format where XXX ranges from 0-255.</p>

Menu item	Explanation
LPD (cont..)	<p>NOTE: When you are pressing the  or  buttons to change the candidate value, press and hold onto the button to run the displays continuously. When both of the buttons are pressed together, the value will be reset to the factory setting.</p>
NetWare	<p>The following items are to be set when using NetWare:</p> <p>Port Status Sets the port status of the NetWare port when the power is switched on. The possible settings are:</p> <ul style="list-style-type: none"> • Enable • Disable (default) <p>If the memory is not enough when the Port Status is set to Enable, it may be set to Disable automatically. When this happens, either set the Port Status of other ports not in use to Disable or change the memory allocation. If the Port Status still cannot be set to Enable, you are recommended to install the 64MB SDRAM for printer.</p> <p>Transpt Protocol Sets the protocol of the transport layer used by NetWare. The possible settings are:</p> <ul style="list-style-type: none"> • TCP/IP, IPX/SPX (default) • TCP/IP • IPX/SPX <p>NOTE: To use TCP/IP, you will need to set the IP address on both the computer and printer.</p> <hr/> <p>Print Mode Sets the printer language. The possible settings are:</p> <ul style="list-style-type: none"> • Auto (default) The language to be used will be determined automatically • PCL • PS (available only when PostScript Kit is installed) <p>When the value is set to Auto, and if the printer language used cannot be found by the automatic printer language detection feature or it is not the selected printer language, the data may be erased.</p> <p>PJL Sets whether to enable the PJL commands sent from the computer. The possible settings are:</p> <ul style="list-style-type: none"> • Enable (default) • Disable <p>No. of Search Sets the number of times of searching the file server. The possible settings are:</p> <ul style="list-style-type: none"> • No Limit (default) • 1-100 <p>TBCP Filter Sets whether to enable the TBCP filter when processing PostScript data. Available only when PostScript Kit is installed. The possible settings are:</p> <ul style="list-style-type: none"> • Enable • Disable (default)

Menu item	Explanation
SMB	<p>The following items are to be set when using SMB:</p> <p>Port Status Sets the port status of the SMB port when the power is switched on. The possible settings are:</p> <ul style="list-style-type: none"> • Enable (default) • Disable <p>If the memory is not enough when the Port Status is set to Enable, it may be set to Disable automatically. When this happens, either set the Port Status of other ports not in use to Disable or change the memory allocation. If the Port Status still cannot be set to Enable, you are recommended to install the 64MB SDRAM for printer.</p> <p>Transpt Protocol Sets the protocol of the transport layer used by SMB. The possible settings are:</p> <ul style="list-style-type: none"> • TCP/IP, NetBEUI (default) • TCP/IP • NetBEUI <hr/> <p>NOTE: To use TCP/IP, you will need to set the IP address on both the computer and printer.</p> <hr/> <p>Print Mode Sets the printer language. The possible settings are:</p> <ul style="list-style-type: none"> • Auto (default) The language to be used will be determined automatically • PCL • PS (available only when PostScript Kit is installed) <p>When the value is set to Auto, and if the printer language used cannot be found by the automatic printer language detection feature or it is not the selected printer language, the data may be erased.</p> <p>PJL Sets whether to enable the PJL commands sent from the computer. The possible settings are:</p> <ul style="list-style-type: none"> • Enable (default) • Disable <p>TBCP Filter Sets whether to enable the TBCP filter when processing PostScript data. Available only when PostScript Kit is installed. The possible settings are:</p> <ul style="list-style-type: none"> • Enable • Disable (default)

Menu item	Explanation
IPP	<p>The following items are to be set when using IPP:</p> <p>Port Status Sets the port status of the IPP port when the power is switched on. The possible settings are:</p> <ul style="list-style-type: none"> • Enable • Disable (default) <hr/> <p>NOTE: To set IPP to Enable, you will need to set the IP address.</p> <hr/> <p>If the memory is not enough when the Port Status is set to Enable, it may be set to Disable automatically. When this happens, either set the Port Status of other ports not in use to Disable or change the memory allocation. If the Port Status still cannot be set to Enable, you are recommended to install the 64MB SDRAM for printer.</p> <p>Print Mode Sets the printer language. The possible settings are:</p> <ul style="list-style-type: none"> • Auto (default) The language to be used will be determined automatically • PCL • PS (available only when PostScript Kit is installed) <p>When the value is set to Auto, and if the printer language used cannot be found by the automatic printer language detection feature or it is not the selected printer language, the data may be erased.</p> <p>PJL Sets whether to enable the PJL commands sent from the computer. The possible settings are:</p> <ul style="list-style-type: none"> • Enable (default) • Disable <p>TBCP Filter Sets whether to enable the TBCP filter when processing PostScript data. Available only when PostScript Kit is installed. The possible settings are:</p> <ul style="list-style-type: none"> • Enable • Disable (default) <p>Access Control Sets whether to enable the access control when entering/exiting the pause state or canceling/deleting print job. The possible settings are:</p> <ul style="list-style-type: none"> • Enable • Disable (default) <p>DNS Sets whether to use the name registered in the Domain Name Server (DNS) when it is recognizing the printer. The possible settings are:</p> <ul style="list-style-type: none"> • Enable (default) The DNS name will be used. • Disable The printer will be recognized by its IP address. <p>Add Port No. Sets the number for the added port. The possible settings are:</p> <ul style="list-style-type: none"> • 80 (default) • 0 • 8000-9999 <p>Connect Time-Out Sets the time to disconnect after data transmission is disrupted. The range of setting is between 0-65535 seconds. Default is 60 seconds.</p>

Menu item	Explanation
IPP (con't...)	<p>DNS Sets whether to use the name registered in the Domain Name Server (DNS) when it is recognizing the printer. The possible settings are:</p> <ul style="list-style-type: none"> • Enable (default) The DNS name will be used. • Disable The printer will be recognized by its IP address. <p>Add Port No. Sets the number for the added port. The possible settings are:</p> <ul style="list-style-type: none"> • 80 (default) • 0 • 8000-9999 <p>Connect Time-Out Sets the time to disconnect after data transmission is disrupted. The range of setting is between 0-65535 seconds. Default is 60 seconds.</p>
USB	<p>The following items are to be set when using USB:</p> <p>Port Status Sets the port status of the USB port when the power is switched on. The possible settings are:</p> <ul style="list-style-type: none"> • Enable • Disable (default) <p>If the memory is not enough when the Port Status is set to Enable, it may be set to Disable automatically. When this happens, either set the Port Status of other ports not in use to Disable or change the memory allocation. If the Port Status still cannot be set to Enable, you are recommended to install the 64MB SDRAM for printer.</p> <p>Print Mode Sets the printer language. The possible settings are:</p> <ul style="list-style-type: none"> • Auto (default) The language to be used will be determined automatically • PCL • PS (available only when PostScript Kit is installed) <p>When the value is set to Auto, and if the printer language used cannot be found by the automatic printer language detection feature or it is not the selected printer language, the data may be erased.</p> <p>PJL Sets whether to enable the PJL commands sent from the computer. The possible settings are:</p> <ul style="list-style-type: none"> • Enable (default) • Disable <p>Adobe Protocol Sets the PostScript protocol. Available only when PostScript Kit is installed. The possible settings are:</p> <ul style="list-style-type: none"> • Normal (default) For communication protocol in ASCII format. • Binary For communication protocol in binary format. Depending on the data, the print processing in this protocol may be faster than Normal. • TBCP (Tagged Binary Communications Protocol) For communication protocol in a mixture of ASCII or binary format which is switched by a specific control code. <hr/> <p>NOTE: Select the protocol to match the format of the data output by the printer driver. For normal use, select Normal.</p>

Menu item	Explanation
USB (con't...)	<p>Auto Eject Time Sets the time to automatically print and output any remaining data in the printer when it is in a continuous state of not receiving data. The range of setting is between 5-1275 seconds with 5 seconds per unit. Default is 30 seconds. When the next data is not received within the time set here after the last data has been received, it will be deemed as end of job.</p>
Port9100	<p>The following items are to be set when using Port9100:</p> <p>Port Status Sets the port status of the Port9100 port when the power is switched on. The possible settings are:</p> <ul style="list-style-type: none"> • Enable • Disable (default) <p>If the memory is not enough when the Port Status is set to Enable, it may be set to Disable automatically. When this happens, either set the Port Status of other ports not in use to Disable or change the memory allocation. If the Port Status still cannot be set to Enable, you are recommended to install the 64MB SDRAM for printer.</p> <p>Print Mode Sets the printer language. The possible settings are:</p> <ul style="list-style-type: none"> • Auto (default) The language to be used will be determined automatically • PCL • PS (available only when PostScript Kit is installed) <p>When the value is set to Auto, and if the printer language used cannot be found by the automatic printer language detection feature or it is not the selected printer language, the data may be erased.</p> <p>PJL Sets whether to enable the PJL commands sent from the computer. The possible settings are:</p> <ul style="list-style-type: none"> • Enable (default) • Disable <p>Port No. Sets the port number. The range of setting is between 8000-9999. Default is 9100.</p> <hr/> <p>NOTE: When you are pressing the  or  buttons to change the candidate value, press and hold onto the button to run the displays continuously. When both of the buttons are pressed together, the value will be reset to the factory setting.</p> <hr/> <p>TBCP Filter Sets whether to enable the TBCP filter when processing PostScript data. Available only when PostScript Kit is installed. The possible settings are:</p> <ul style="list-style-type: none"> • Enable • Disable (default) <p>Connect Time-Out Sets the time to disconnect after data transmission is disrupted. The range of setting is between 2-65535 seconds. Default is 60 seconds.</p> <hr/> <p>NOTE: When you are pressing the  or  buttons to change the candidate value, press and hold onto the button to run the displays continuously. When both of the buttons are pressed together, the value will be reset to the factory setting.</p>

Menu item	Explanation
EtherTalk	<p>The following items are to be set when using EtherTalk. This menu item is available only when PostScript Kit is installed.</p> <p>Port Status Sets the port status of the EtherTalk port when the power is switched on. The possible settings are:</p> <ul style="list-style-type: none"> • Enable • Disable (default) <p>If the memory is not enough when the Port Status is set to Enable, it may be set to Disable automatically. When this happens, either set the Port Status of other ports not in use to Disable or change the memory allocation.</p> <p>PJL Sets whether to enable the PJL commands sent from the computer. The possible settings are:</p> <ul style="list-style-type: none"> • Enable (default) • Disable
Salutation	<p>The following items are to be set when using Salutation. Specify setting for this menu item when using the scanner feature.</p> <p>Port Status Sets the port status of the Salutation port when the power is switched on. The possible settings are:</p> <ul style="list-style-type: none"> • Enable • Disable (default) <p>If the memory is not enough when the Port Status is set to Enable, it may be set to Disable automatically. When this happens, either set the Port Status of other ports not in use to Disable or change the memory allocation. If the Port Status still cannot be set to Enable, you are recommended to install the 64MB SDRAM for printer.</p>
FTP Client	<p>The following items are to be set when using FTP Client.</p> <p>Port Status Sets the port status of the FTP Client port when the power is switched on. The possible settings are:</p> <ul style="list-style-type: none"> • Enable • Disable (default) <p>If the memory is not enough when the Port Status is set to Enable, it may be set to Disable automatically. When this happens, either set the Port Status of other ports not in use to Disable or change the memory allocation. If the Port Status still cannot be set to Enable, you are recommended to install the 64MB SDRAM for printer.</p>

Menu item	Explanation
SNMP	<p>The following items are to be set when using SNMP. These SNMP settings are necessary when using an application program to manage multiple printers remotely. The printer information is managed by SNMP and gathered from SNMP by the application program.</p> <p>Port Status Sets the port status of the SNMP port when the power is switched on. The possible settings are:</p> <ul style="list-style-type: none"> • Enable (default) • Disable <p>If the memory is not enough when the Port Status is set to Enable, it may be set to Disable automatically. When this happens, either set the Port Status of other ports not in use to Disable or change the memory allocation. If the Port Status still cannot be set to Enable, you are recommended to install the 64MB SDRAM for printer.</p> <p>Transpt Protocol Sets the protocol of the transport layer used by SNMP. The possible settings are:</p> <ul style="list-style-type: none"> • UDP (default) • IPX • IPX, UDP <hr/> <p>NOTE: To use UDP, you will need to set the IP address on both the computer and printer.</p> <hr/> <p><i>Refer to the manuals of the application program to decide whether to use IPX or UDP.</i></p> <p>Community (R) Registers the community name needed to read the printer management information (MIB). Enter up to 12 characters for the name. Default is Not Registered.</p> <p>Community (R/W) Registers the community name needed to read/write the printer management information (MIB). Enter up to 12 characters for the name. Default is Not Registered.</p> <p>Community (Trap) Registers the community name used by the trap. Enter up to 12 characters for the name. Default is Not Registered.</p>
Internet Service	<p>The following item is to be set when using Internet Service.</p> <p>The possible settings are:</p> <ul style="list-style-type: none"> • Enable (default) • Disable <p>If it is set to Enable, you can, through a web browser, make use of the CentreWare Internet Services to display the printer/job status and change printer settings.</p> <hr/> <p>NOTE: To activate the Internet Service, you will need to set the IP address on both the computer and printer.</p> <p>You can make use of CentreWare Internet Services to set detailed settings. For more details, refer to <i>“Using CentreWare Internet Services”</i> on page 5-39</p>

Menu item	Explanation
TCP/IP Settings	<p>Get IP Address Sets the way of obtaining the essential information for using TCP/IP (IP address, subnet mask, gateway address). The possible settings are:</p> <ul style="list-style-type: none"> • DHCP (default) • RARP • BOOTP • Manually <p>Check with your system administrator for the address if you choose Manually.</p> <hr/> <p>NOTE: If you change the setting from DHCP or BOOTP to Manually, you will need to set the IP address manually on the screen displayed for setting IP address.</p> <hr/> <p>IP Address, Subnet Mask, Gateway Address These items will be available whether you choose Manually or automatically (i.e. by DHCP, BOOTP or RARP) for Get IP Address. If you have chosen Manually, enter the value for these items in the XXX.XXX.XXX.XXX format where XXX is between 000-255.</p> <p>If a wrong IP Address is set, the whole network might be badly affected. If a wrong Subnet Mask is entered (e.g. setting the bit to "0"), the value will resume the previous setting even if you have pressed after the entering the value. You cannot navigate to other items until the correct value is set. Enter the Gateway Address only when it is clear that there is a need to do so. You do not need to set it for environment that allows it to be set automatically.</p>
WINS Server	<p>Get DHCP Address Sets whether to obtain automatically the IP Address for WINS server from the DHCP server. This IP Address is needed in order to use WINS. The possible settings are:</p> <ul style="list-style-type: none"> • Off (default) The address will be obtained manually. Check with your system administrator for the address. • On <hr/> <p>NOTE: If you change the setting from On to Off, you will need to set the IP address manually on the screen displayed for setting IP address.</p> <hr/> <p>Primary IP, Secondary IP These items will be available whether you choose Off (manually) or On (automatically) for Get DHCP Address. If you have chosen Off, enter the value for these items in the XXX.XXX.XXX.XXX format where XXX is between 000-255. If the Primary IP is not in effect, the Secondary IP will not be in effect too.</p> <p>If a wrong IP Address is set, the whole network might be badly affected.</p>
IPX/SPX FrameType	<p>The following items are to be set when using IPX/SPX Frame Type. The possible settings are:</p> <ul style="list-style-type: none"> • Auto (default) Sets the frame type automatically. • Ethernet II Uses the Ethernet specification frame type. • Ethernet 802.3 Uses the IEEE802.3 specification frame type. • Ethernet 802.2 Uses the IEEE802.2 specification frame type. • Ethernet SNAP Uses the IEEE802.3/IEEE802.2/SNAP specification frame type.

Menu item	Explanation
Ethernet	<p>Sets the transmission speed/connector type of the Ethernet interface. The possible settings are:</p> <ul style="list-style-type: none"> • Auto (default) 100BASE-TX or 10BASE-T will be interchanged automatically. • 100BASE-TX Select this when you want to fix the value at 100BASE-TX for use. • 10BASE-T Select this when you want to fix the value at 10BASE-T for use.

Allocate Memory

Changes the memory capacity of each of the interface.

If the memory capacity is changed, all the data stored in each of the memory domains will be deleted as the memory will be reset.

You cannot allocate the memory capacity to exceed its overall capacity. If the value set exceeded the memory capacity when the power is switched on, it can be automatically adjusted depending on the system. For details on memory allocation, refer to "Memory Allocation" on page 2-24.

When printing documents with large amount of data, the resolution might decrease. Increasing memory capacity might prevent a decrease of resolution.

Menu Item	Explanation
PCL Memory	<p>Sets the capacity of the memory for the use of PCL. When the memory capacity is increased, the printing speed may be increased, complicated documents can be printed, and a good image quality can be obtained.</p> <p>The range of setting is between 2.50-32.00 Mbytes with 0.25 Mbytes per unit. Default is 5.00 Mbytes.</p> <p>When Menu is pressed after the setting, a system reset will be executed. "Diagnostics in progress" will be displayed during the system reset and key operations are not accessible.</p> <p>All the data stored in the various memory domains will be cleared by reset.</p> <p>The maximum value of the memory capacity that can be set changes according to the free memory capacity.</p>
PS	<p>Sets the capacity of the memory for use by PostScript. Available only when the PostScript Kit is installed.</p> <p>The range of setting is between 4.50-32.00 Mbytes with 0.25 Mbytes per unit. Default is 8.00 Mbytes.</p> <p>When Menu is pressed after the setting, a system reset will be executed. "Diagnostics in progress" will be displayed during the system reset and key operations are not accessible.</p> <p>All the data stored in the various memory domains will be cleared by reset.</p> <p>The maximum value of the memory capacity that can be set changes according to the free memory capacity.</p>

Menu Item	Explanation
Buffer Size	<p>Sets the memory capacity of the receive buffer for the respective interfaces. (Receive buffer is the temporary storage location of the data sent from the computer.) For lpd, SMB and IPP, you will set whether to on/off spool, storage location as well as the memory capacity.</p> <p>The memory capacity of the buffer can be changed according to the status and objective of the usage. If the memory capacity for the buffer is increased, the release of the computer for each interface can be speed up. The maximum size that can be set changes according to the free memory capacity.</p> <hr/> <p>NOTE: When the Port Status of the interface is set to Disable, the items related to the interface will not be available.</p> <p>Depending on the data volume sent from the computer, the release time for the computer may not change even if the memory capacity is increased.</p> <hr/> <p>Parallel, NetWare Memory, USB Memory, Port9100 Memory, EtherTalk Memory Sets the memory capacity between 64-1024Kbytes with 32Kbytes per unit. Default is 256K. EtherTalk Memory is available only when PostScript Kit is installed.</p> <p>LPD Spool, SMB Spool The possible settings are:</p> <ul style="list-style-type: none"> • Off (default) No spool processing will be done. When processing LPD/SMB printing from a computer, data by the same interface cannot be received from other computers. The memory capacity of the receive buffer for LPD/SMB is between 64-1024Kbytes with 32Kbytes per unit. Default is 256K. • Hard Disk Spool processing will be done. For the receive buffer used for spool processing, the hard disk is used. Available only when the Printer HDD Kit is installed. • Memory Spool processing will be done. For the receive buffer used for spool processing, memory is used. When this possible setting is selected, the memory capacity of the receive buffer used for spool processing is set between 0.51-32.00Mbytes with 0.25Mbytes per unit. Default is 1.00M. Print data that is larger than the set memory capacity cannot be received. For such instance, select either Off or Hard Disk. <p>IPP Spool The possible settings are (<u>when the Printer HDD Kit is installed</u>):</p> <ul style="list-style-type: none"> • Off (default) No spool processing will be done. When processing IPP printing from a computer, data by the same interface cannot be received from other computers. The memory capacity of the receive buffer for IPP is between 64-1024Kbytes with 32Kbytes per unit. Default is 256K. • Hard Disk Spool processing will be done. For the receive buffer used for spool processing, the hard disk is used. <p>The possible settings are (<i>when the Printer HDD Kit is not installed</i>) between 64-1024Kbytes with 32Kbytes per unit. Default is 256K.</p>

Initialize/Delete Data

Executes the initialization of the printer setting values stored in the NV memory, as well as those of the hard disk, and print meter.

NOTE: The value of these items will be reset to the default setting after the initialization.

Menu Item	Explanation
NVM	Initializes the NV memory. NV memory is the non-volatile memory that maintains the printer settings even after the power has been switched off. Once the NV memory has been initialized, the possible setting of all the items will be reset to their factory setting.
Hard Disk	Initializes the hard disk. Once the hard disk has been initialized, the PCL/PS data will be deleted. However, Secure Print/Sample Print data will not be erased. This item is available only when the Printer HDD Kit has been installed.
Print Meter	Initializes the print meter.

Printer Settings

Includes substitute tray setting.

Menu Item	Explanation
Substitute Tray	<p>The feature of selecting a paper tray corresponding to the size and orientation of the original document when a print instruction has been sent from the computer is known as Auto Tray Selection. The item here sets whether to automatically substitute paper from another tray for printing by Auto Tray Selection when there is no paper in the tray selected. The paper size will be set as well if the paper is to be substituted. The possible settings are:</p> <ul style="list-style-type: none"> • Off (default) No paper tray will be substituted. Displays a message to prompt users to replenish paper. • Larger Size The next larger size to the selected paper size will be used to print in the same image size. • Nearest Size The nearest size to the selected paper size will be used for printing. If necessary, the image size can be reduced automatically. <hr/> <p>NOTE: The Nearest Size option has effect on PS print mode only. If instruction has been sent from the computer, it will have priority over the one from the printer.</p> <hr/>

Outputting Reports/Lists

This section describes the types of reports/lists and the way to print them.

Types of reports/lists

Besides data sent from the computer, this printer is also equipped to print the following reports/lists:

- PCL Settings List
- Printer Settings List
- Error History Report
- Job History Report
- Printer Meter Report
- PCL Fonts List

The following report/list is available only when the Printer HDD Kit has been installed:

- Stored Documents List

The following reports/lists are available only when the PostScript Kit has been installed:

- PostScript Fonts List
- PostScript Logical Printer List

PCL Settings List

About PCL Settings List

Prints information on the PCL settings on the printer.

Print result

The following items will be included:

- Paper Tray
- Output Size
- Paper Size (Bypass Tray)
- Output Destination
- Orientation
- 2 Sided Print
- Font
- Symbol Set
- Font Size
- Font Pitch
- Form Lines
- Number of Sets
- Image Enhancement
- Hexdump
- Draft Mode

Printer Settings List

About Printer Settings List

Prints information in the system menu.

Print result

The following items will be included:

- System Settings
- Printer Settings
- Communication Settings

Error History Report

About Error History Report

Prints information on the error history of the printer.

Print result

The following items will be included:

- Date
- Time
- Error Code
- Error Type

Job History Report

About Job History Report

Prints information on the job history.

Print result

The following items will be included:

- Date
- Time
- Input Data
- Output Destination
- Job Info
- Page Info
- Pages
- Sheets
- Job Status

Print Meter Report

About Print Meter Report

Prints information on the usage of the printer by users.

Print result

The following items will be included:

- Job Owner
- Pages
- Sheets

PCL Fonts List

About PCL Fonts List

Prints a list of PCL fonts that can be used by the printer.

Print result

The following items will be included:

- Fonts applicable to PCL
- Example

** Fonts stated in the PCL Fonts List are trademarks of Bitstream Inc. and International Type Company.*

Stored Documents List

About Stored Documents List

Prints information on the mailbox size, Secure Print and Sample Print jobs.

Print result

The following items will be included:

Mailbox Size:

- Size Used
- Free Space

Secure Print:

- Doc. No.
- User ID
- Document Name
- Document Size
- Stored Date
- Pages

Sample Print:

- Doc. No.
- User ID
- Document Name
- Document Size
- Stored Date
- Pages

PostScript Fonts List

About PostScript Fonts List

Prints a list of PostScript fonts that can be used by the printer.

Print result

The following items will be included:

- Fonts
- Example

PostScript Logical Printer List

About PostScript Logical Printer List

Prints a list of PostScript logical printers.

NOTE: Use CentreWare Internet Services to set the PostScript logical printer. For details on the setting items, refer to the online Help of CentreWare Internet Services. For details on how to use CentreWare Internet Services refer to “*CentreWare Internet Services*” on page 5-35. Refer to the Network Print Environment User Guide (Network.PDF) in the User Documentation CD ROM for details on using UNIX to print from this machine.

Print result

The following items will be included:

- Printer Number
- Format
- Option
- Print Control

Job Template List

About Job Template List

Prints the job template data retrieved from the server. The job template is used by the CentreWare Scanning Services.

The Job Template List is available only if FTP Client (of Network/Port) has been set to Enable.

Print result

The following items will be included:

- No.
- Template Name
- M/C ID Code
- Server
- Storage Bus
- Select File
- Protocol
- File Name
- Format

Domain List

About Domain List

Prints the list of domain.

Print result

The following items will be included:

- No.
- Domain Name

Printing reports/lists

The following procedure shows how to print the reports/list:

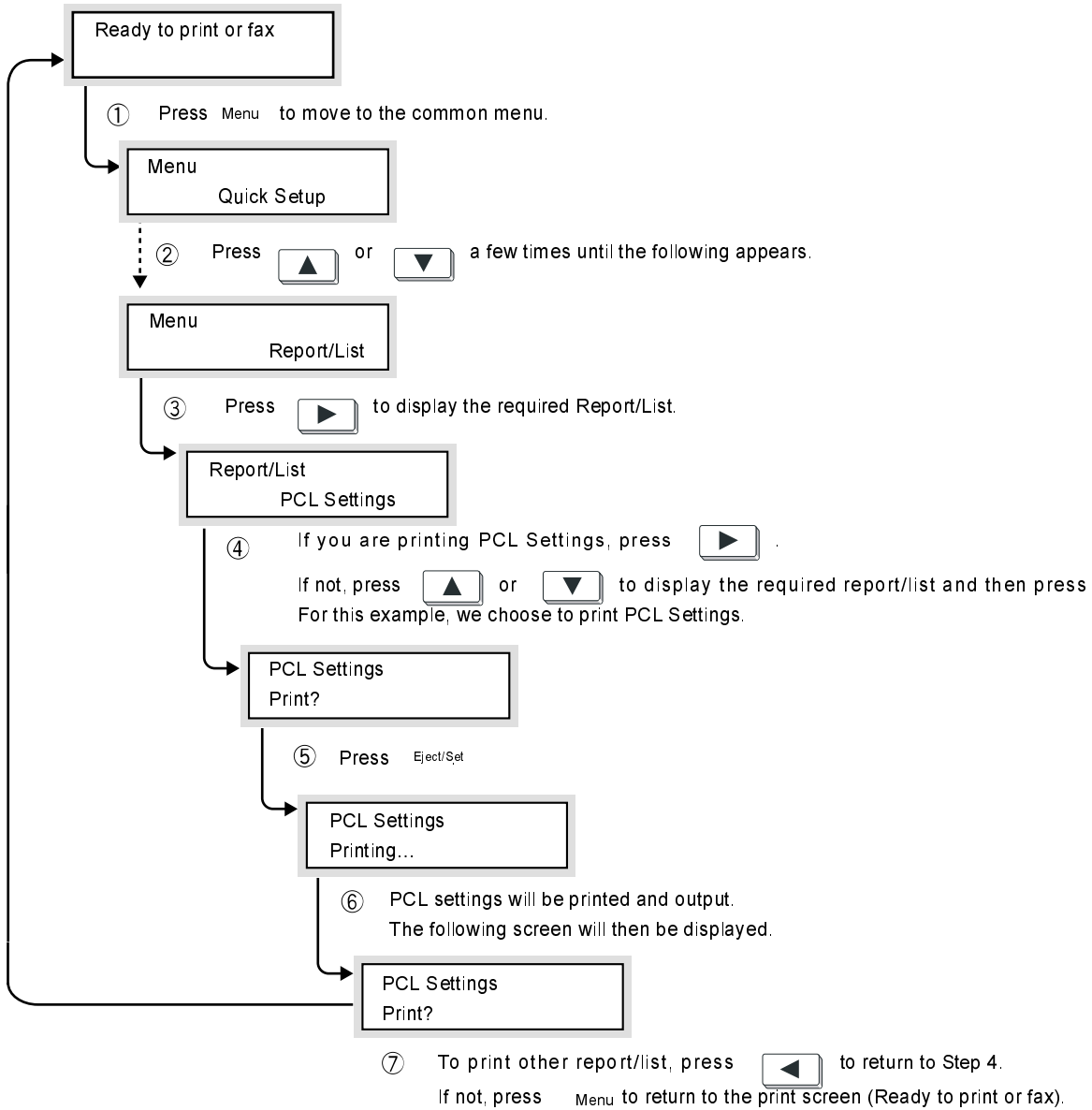

CentreWare Internet Services

CentreWare Internet Services is a software that enables the user to display the printer/job status or change the printer settings via a web browser when the printer has been configured for the TCP/IP environment.

Using the Properties dialog box of CentreWare Internet Services, you can define the settings on the printer control panel, like the items of system settings or the various network port settings.

Depending on the items, some settings become effective only after rebooting (i.e. after switching on/off the printer, or after defining the system settings using the printer control panel).

Structure of the CentreWare Internet Services screen

The CentreWare Internet Services screen consists of four parts: a panel each at the top and bottom parts of the window (top panel, bottom panel), as well as two frames on the left and right at the middle part of the window (left frame, right frame).

The contents of each part change according to the features used (Job, Status, Properties, Maintenance, or Support).

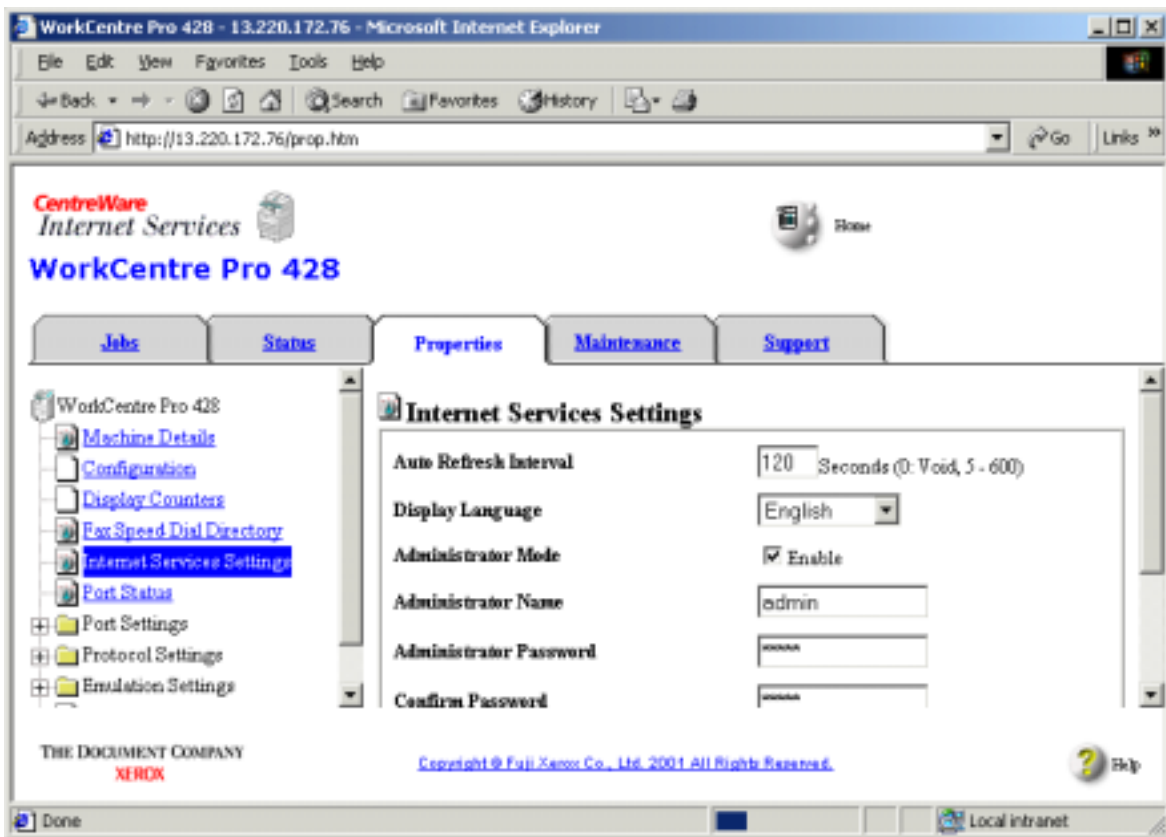

Top panel

The top panel is at the top of the window. A logo mark and the printer name are displayed on the top page (default status) as well as on every category page. In addition, you will find tabs to link to the top page and to move to each category on every category page.

Bottom panel

The bottom panel is at the bottom of the window. It displays links to Customer Support Home Page, copyright screen, and the Help file. The contents in this panel remains unchanged regardless of which page is displayed.

Right and left frame

The right and left frames are in the middle of the window. The contents in these frames will change according to the items selected in the category.

System environment

To use CentreWare Internet Services, you will need to activate the network environment using TCP/IP protocol as well as to set the Internet service to Enable (factory setting: Enable) at the printer.

Target computers and browsers

Target computers

- Microsoft Windows 95 OS
- Microsoft Windows 98 OS
- Microsoft Windows Me OS
- Microsoft Windows NT Server 4.0
- Microsoft Windows NT Workstation 4.0
- Microsoft Windows 2000 Server
- Microsoft Windows 2000 Professional
- Macintosh OS 8.0 onwards

Browsers

- Netscape Communicator (version 4.51 onwards for Windows/ version 4.5 onwards for Macintosh)
- Internet Explorer (version 4.01 onwards for Windows/version 5.0 onwards for Macintosh)

Configuring browser

For Netscape Communicator

1. From the Edit menu, select **Preferences**.
2. From the Category tree, click **Advanced**.
3. If the Enable Java check box is not selected, select it.
4. Click the "+" sign on the left of **Advanced**.
5. Click **Cache** under **Advanced**.
6. Select **Once per session** or **Every time** for **Document in cache is compared to document on network**.
7. Click **OK**. The dialog box is closed.

For Internet Explorer

1. Select **Internet Options** from the Tools menu.
2. Click **Settings** for **Temporary Internet files** on the General tab.
3. In **Check for newer versions of stored pages**, select either **Every visit to the page** or **Every time you start Internet Explorer**, and then click **OK**.
4. Click **OK** on the Internet Options dialog box.

Checking proxy server and port number

Proxy server setting

When using CentreWare Internet Services, it is recommended that you do not connect to a proxy server but make direct connections.

NOTE: When you define connection to be made to a proxy server, it might take a long time to set the IP address at the browser or the screen might not be displayed. When this happens, change the setting to a direct connection at the browser. For details on how to define these settings, refer to the manuals of the browser that you are using.

Port number setting

The factory setting of the port number of the CentreWare Internet Services is 80. The port number can be changed from the Properties screen. The port numbers that can be set are 80, 8000 - 9999. After the port number has been changed, it is necessary to specify the number after ":" of the address when connecting from the browser. For example, for port number, "8080", enter the number to the internet or IP address as follows:

http://(internet address):8080

or

http://(IP address):8080.

Configuring the printer

Follow the process below to activate the CentreWare Internet Services at the printer control panel if it is not set to Enable.

You will have to set the IP address after the CentreWare Internet Services has been activated if it is not set. Follow the below process to set it.

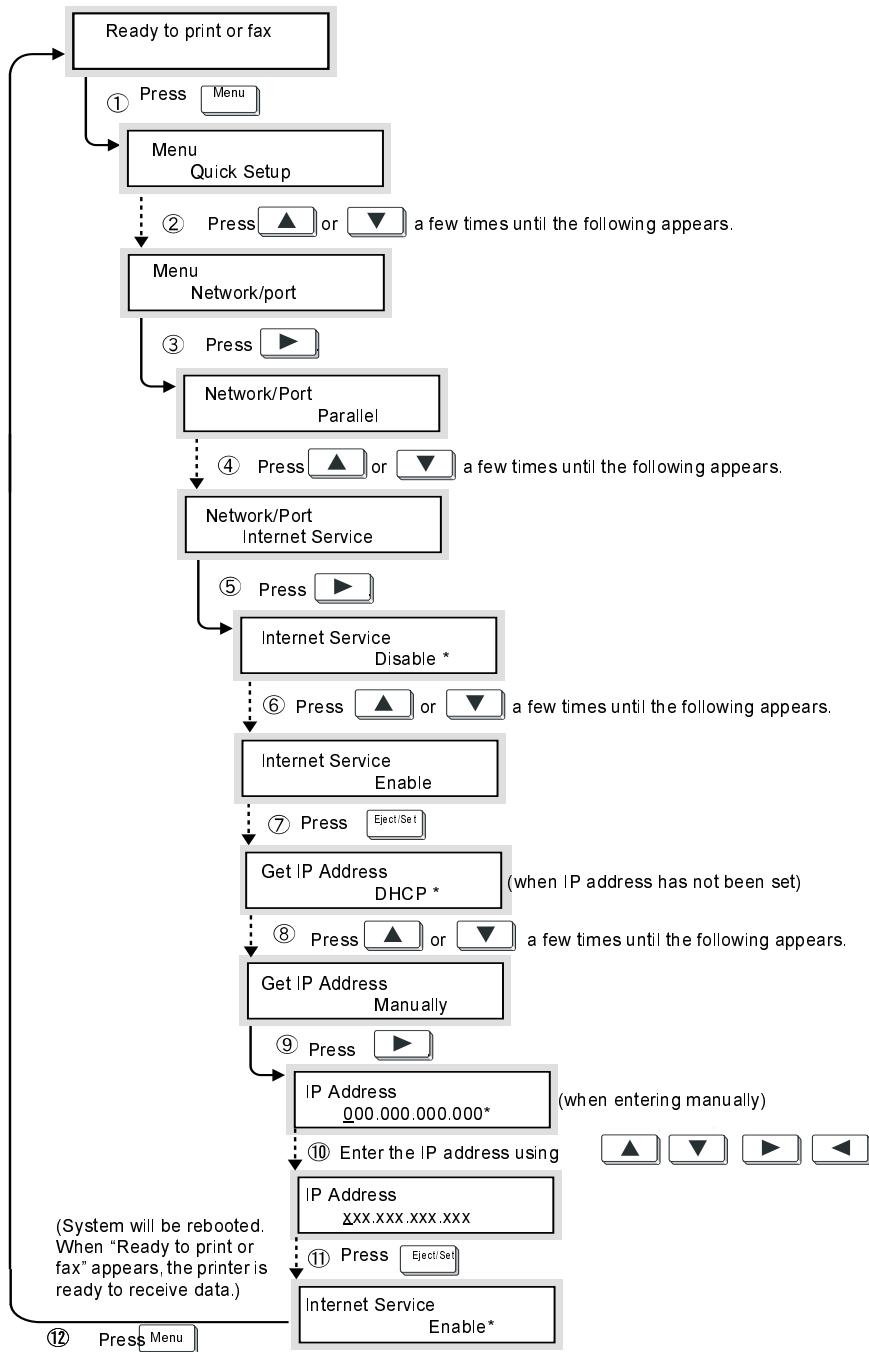

Using CentreWare Internet Services

1. Switch on the computer and activate the browser.
2. At the address column of the browser, enter the IP address or internet address of the printer, and then press **Enter** on the keyboard.

Example of specifying an IP address



Example of specifying an internet address



NOTE: When specifying a port number, add ":" after the address, followed by "80" (factory setting of the port number).



The screen of the CentreWare Internet Services is displayed.

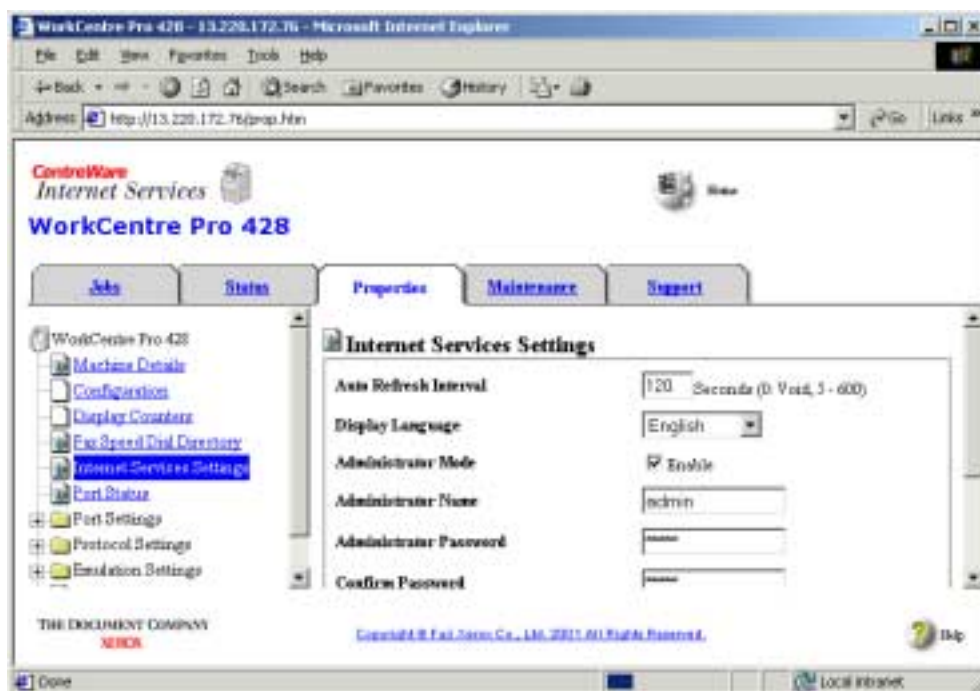

Checking Printer Status via E-Mail

When installed with the Internet fax kit (optional) and set up in TCP/IP environment, this machine can send an e-mail with the following report to your computer through the office network or Internet:

- conditions of error in machine
- list of rejected job requests
- list of rejected e-mails sent through Internet fax

This feature is known as *Mail Notice*.

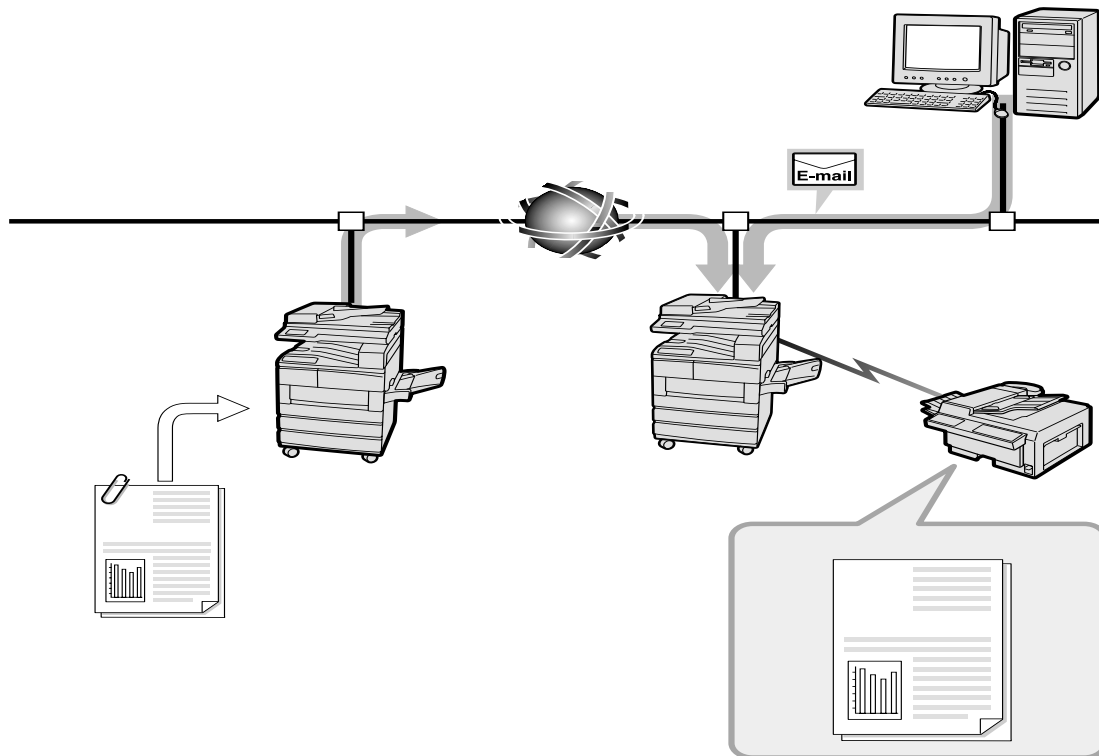

About Mail Notice

There are three types of information that can be sent through Mail Notice:

Regular Notice	Notifies the conditions leading to errors that need to be attended by user.
Print Reject Notice	Notifies the number of print rejects and the time of the last reject, grouped according to the client IP address/client of the rejected print jobs.
Mail Reject Notice	Notifies the number of mail rejects and the time of the last reject, grouped according to the mail address/user of the rejected mails.

To use Mail Notice, the following items have to be set beforehand using CentreWare Internet Services:

- Port Status (Receive E-mail/iFax, Send E-mail/iFax, Mail Notice)
- Protocol Settings (E-mail/iFax > Machine Mail Address, SMTP Server Address)
- Mail Notice Settings

Follow the process below to use Mail Notice.

Refer to "CentreWare Internet Services" on page 5-35" and the online Help of CentreWare Internet Services for details on CentreWare Internet Services.

1. Switch on the computer and activate the browser.
2. At the address column of the browser, enter the IP address or internet address of the printer, and then press **Enter** on the keyboard.

The CentreWare Internet Services screen is displayed.



3. Click **Properties**, and then from the left frame of the screen displayed, select **Port Status**.

The Port Status screen is displayed on the right frame.

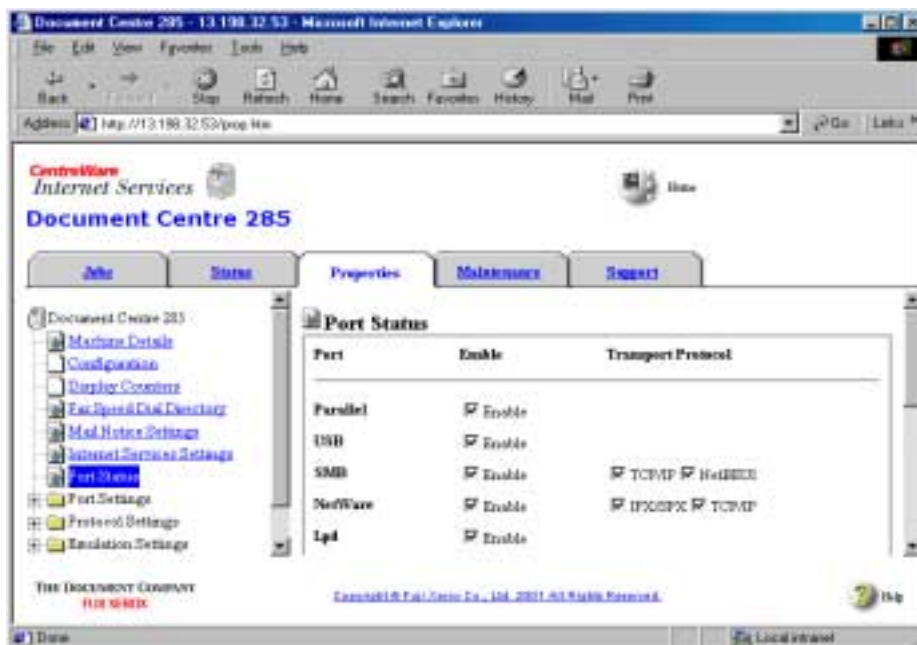

4. Check the check box on the right of **Mail Notice** to enable the port.

If the port has been enabled, proceed to Step 6.

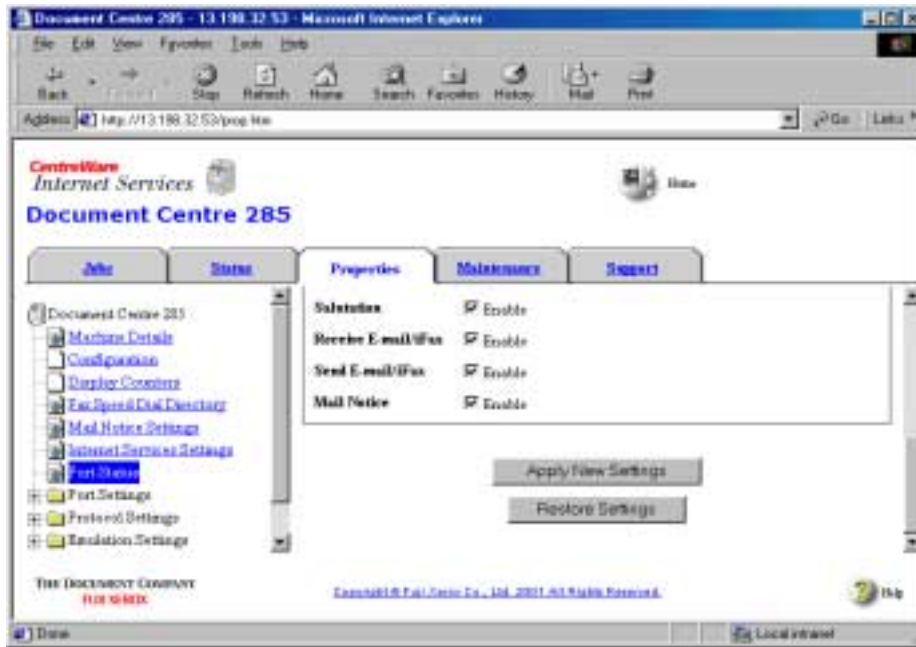

5. If the port has just been enabled, click the button at the bottom of the right frame, **Apply New Settings**.

When a screen appears to prompt you for the user name and password, enter these items and then click **OK**.

The new settings will be transferred to the machine, and the settings updated.

If a message prompts you to reboot the machine, switch the machine off and then on again.

NOTE: For a port that has just been enabled, the machine must be rebooted for the settings to take effect. If not, **E-mail/iFax** will not be displayed under **Protocol Settings**.

6. After the machine has been rebooted, select from the left frame, **E-mail/iFax** under **Protocol Settings**.

The E-mail/iFax screen will be displayed in the right frame.

7. To use Mail Notice, specify setting for **Machine Mail Address** and **SMTP Server Address**.

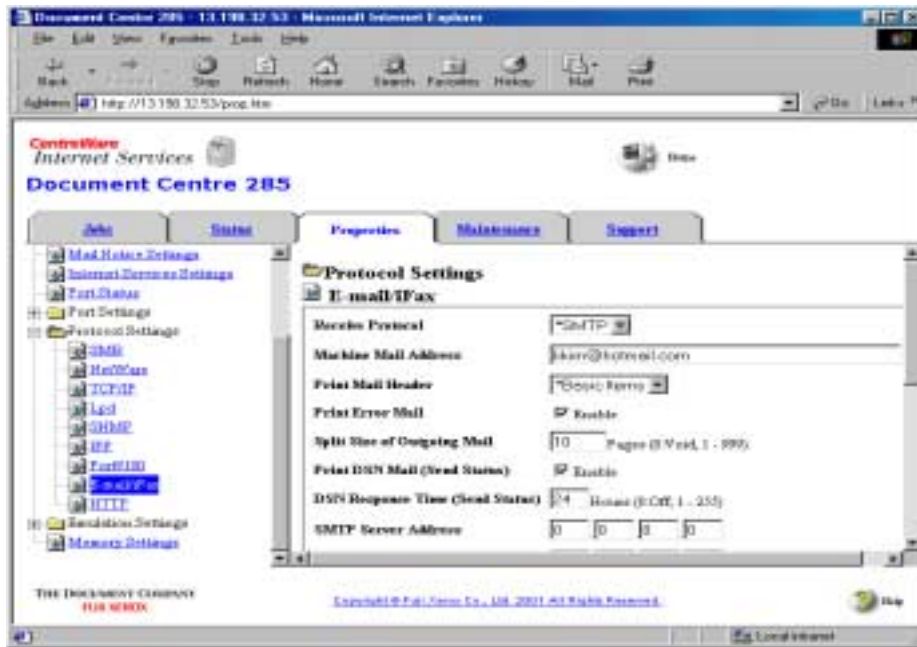

8. From the left frame, select **Mail Notification Settings**.
The Mail Notification Settings screen will be displayed on the right frame.
9. If necessary, specify settings for each item.

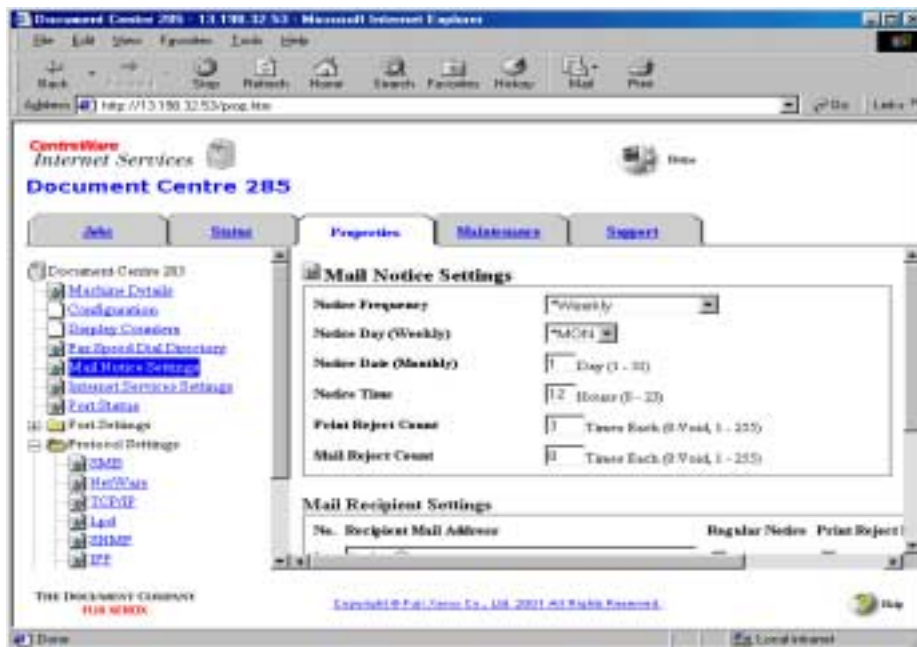

10. After all the settings have been made, click the button at the bottom of the right frame, **Apply New Settings**.
When a screen appears to prompt for the user name and password, enter these items and then click **OK**.
The new settings will be transferred to the machine, and the settings updated.
Depending on the item, you might have to reboot the machine. If a message prompts you to reboot the machine, switch the machine off and then on again.

6 *Precautions and Limitations*

The following information can be found in this chapter:

- In General
- On Using TCP/IP

In General

This section explains the precautions and limitations of using this printer in general.

When switching on/off power

- After you have switched off the power, wait at least five seconds before switching it on again.
- After the message, "Ready to print or fax" is displayed, wait at least five seconds before switching the power off.

When switching on power

For printers connected to the computer by parallel interface; when the display shows, "Printing" immediately after switching on the printer even though no data have been sent, press **Mode** and **Menu** at the same time.

When the Printer HDD kit has been installed

- When the Printer HDD kit has been installed, you can specify a hard disk as a storing location for print data from LPD, SMB, IPP.
- Data erased by the initialization of the hard disk include added fonts and SMB folder. Secure Print/Sample Print documents and the respective logs will not be erased.
- The number of files registered in the hard disk that can be called up at one time changes according to the additional memory capacity, which depends on whether the optional SDRAM for Printer is installed.
- When the Printer HDD kit and the SDRAM for Printer are installed with a large number of files registered in the hard disk, the printer might not be able to start up if the SDRAM for Printer is removed.
- When this happens, either switch off the power and remove the Printer HDD kit or install the SDRAM for Printer.
- The hard disk may become defective. Hence, back up important data stored in the hard disk.

When the finisher has been installed

Paper with length of 130 mm or less cannot be output to Finisher Tray Lower (face up). Even if Finisher Tray Lower has been selected for Output Destination on the Paper/Output tab for printing, it will be switched to Center Output Tray.

Paper feed direction

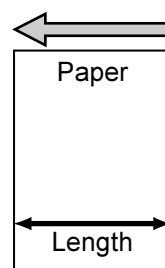

When the print result is different from the setting

Due to insufficient capacity of the print page buffer, the following situations where the print results differ from the setting might occur. When this happens, it is recommended to increase the memory.

- Set at two-sided printing but printed on one side only.
- Job is stopped (when a page processing cannot be carried on in the print page buffer, the job including that page will be stopped).

Setting Draft Mode

Depending on the application software used, even if **Draft Mode** has been selected on the Graphics tab of the printer driver, the feature might not work.

Using optional products

- The Printer HDD Kit and SDRAM for Printer have to be installed in order to use the sorter (electric sorting feature) and Secure Print/Sample Print.
- The optional PostScript Kit has to be installed in order to use the printer for supporting PostScript.
- The SDRAM for Printer has to be installed with the Printer HDD Kit.
- The SDRAM for Printer has to be installed when activating multiple network protocols at the same time.

Using the printer driver for faxing

- From the computer, you can use the driver to specify up to 50 fax recipients. However, as the total number of fax recipients that can be specified for the machine is 200, you can specify from the touch panel display on the machine as well as from the computer, a total of 200 fax recipients.

- Depending on the data transmission status, the machine may not enter the pause state even if you press **Pause**, when a fax transmission is being sent directly from the computer.

On Using TCP/IP

Be aware of the following precautions and limitations when using the printer with the TCP/IP protocol.

During setup

Setting up at the printer

- Be very careful in setting IP addresses which are controlled as an entire system. Consult your network administrator before defining any IP address.
- Depending on the network environment used, it may be necessary to set up the subnet mask and gateway address. Consult your network administrator to set up the necessary items.
- If setting the port to Enable leads to insufficient memory, a message to that effect will be displayed on the control panel and the port status may be set to Disable automatically. When this happens, set the ports which are not in use to Disable, change the memory size, or install more memory.
- Specify the size for the receive buffer memory as required by the environment. If the size of the receive buffer memory is smaller than the file data to be received, the data may not be received.

Setting up at the computer/workstation

- Be very careful in setting IP addresses which are controlled as an entire system. Consult your network administrator before defining any IP address.
- Before setting any network (such as the IP address) to a computer being used under Network Information Service (NIS), consult the NIS administrator.

During switching power on/off

Take note of the following when switching off the power.

When LPD Spool is set to Memory (spool mode)

All the print data spooled to the printer memory, including print data which is being output, will be deleted. When the printer is switched on again, the print data will not be found.

However, if the printer is switched off immediately after the print data has been sent, the data may be stored in the computer. In this case, when it is switched on again, the stored print data will be printed first even if new print data has been specified.

When LPD Spool is set to Hard Disk (spool mode)

All the spooled print data, including print data which is being printed, will be saved. When the printer is switched on again, the stored print data will be printed first even if new print data has been specified.

When LPD Spool is set to Off (non-spool mode)

All the print data spooled to the printer receive buffer, including print data which is being output, will be deleted. When the printer is switched on again, the print data will not be found.

However, if the power is switched off immediately after the print data has been sent, the data may be stored in the computer. In this case, when the power is switched on again, the stored print data will be printed first even if new print data has been specified.

During printing

Take note of the following when printing:

When LPD Spool is set to Hard Disk or Memory (spool mode)

If the print data is larger than the hard disk or the remaining memory capacity at the point of receiving data, the data will not be received by the printer.

NOTE: Some client computers may re-send immediately when the print data has exceeded the receiving capacity. When this happens, the client computer appears as if it has crashed. To rectify this situation, the client computer must be stopped from sending print data.

When LPD Spool is set to Off (non-spool mode)

The printer will process print data as soon as data is being received. If the printer has accepted a print request from a client computer, it will not receive another print request from another client computer.

7 *Troubleshooting*

The following information can be found in this chapter:

- When Problems Occur
- When the Print Quality is Poor
- Messages
- Using TCP/IP
- Using CentreWare Internet Services

When Problems Occur

Check the conditions of the printer again before treating it as a breakdown.

If the problem cannot be solved by the suggested treatment below, proceed to "7.2 When the Print Quality is Poor" and "7.3 Messages" to carry out the appropriate treatment.

WARNING:This printer uses precision parts and high voltage.

WARNING:Never open any panels or covers that are secured with screws unless specifically instructed in this user guide. There is a danger of electric shock as there are internal parts of high voltage. If you have to carry out any disassembling operation of panels and covers, make sure you follow the instructions in the relevant user guides.

WARNING:Never try to alter the printer configuration or modify any parts as it may cause fire or smoke.

Condition	Cause	Treatment
No power	Are the printer breaker switch and power switch turned on?	Turn on the printer breaker switch and power switch.
	Is the power cord securely connected?	Turn off the power switch and check that the power cord is plugged in properly. Then turn on the power switch.
	Is the power voltage suitable?	Check that the power source is 110 V (60 Hz), 220 - 240 V (50/60 Hz). Check that the power capacity matches the printer highest consumption power indicated in the User Guide (Copier).
Cannot print.	Is the Online indicator of the printer control panel off?	The printer is in the pause state or the menu setting state. Treat accordingly as follows: <ul style="list-style-type: none"> • "Pause" Press Pause to exit the pause state. • Others Press Menu to exit the menu setting state. See "Printer control panel" on page 1-6.
	Is there any message being shown on the display?	Treat according to the message displayed. See "Messages" on page 7-9.

Condition	Cause	Treatment
Cannot print. (con't...)	When the printer and the computer are connected by a parallel interface cable, the computer does not respond to bi-directional communication.	By default, the bi-directional communication setting of the printer is set to Enable. If the computer is not responding to bidirectional communication, printing cannot be done. In this case, turn the bi-directional communication setting to Disable from the printer control panel and then print again. <i>See "Common Menu Items" on page 5-10.</i>
	Is the memory sufficient?	Increase the page buffer or install the additional RAM module to increase the memory. <i>See "Memory Allocation" on page 2-24.</i> for details on page buffer. NOTE: If the memory is insufficient, the port status will become Disable and printer will reboot automatically.
	Is the Poster feature being selected to output an image across multiple sheets of paper?	Depending on the paper size to be used and the image size to be output, you may not be able to carry out printing. When this happens, reduce either the paper size or the image size, and then print again.
Printing has been specified but the Processing indicator does not light up.	Is the interface cable securely connected?	Turn the switch off and check the interface cable connection.
	If the interface card is used, has it been correctly set?	Turn the printer power switch off and check the installation status of the interface card.
	Is the interface card activated?	Check the port status of the interface. <i>See "Common Menu Items" on page 5-10.</i>
	Is the operating environment of the host device correctly set?	Check the operating environment of the host device such as the printer driver.
Printing specification has been sent to the bypass tray but no printing is done.	Are the specified paper sizes being used?	Insert the correct sized paper and send to print again. User Guide (Copier)
No printing is sent but display shows "Printing".	Is the power of the computer turned on after the printer has been on?	Just wait for five minutes or press Mode and Menu together to stop printing. NOTE: When switching on the power of the printer, check whether the host device is switched on.
Poor print quality.	There might be an image error.	<i>See "When the Print Quality is Poor" on page 7-5.</i> and treat accordingly.
The correct characters are not printed (printing garbage).	The printer is printing with non-standard built-in fonts.	1. Check the printer-resident fonts by the "PCL Font List" and the font indication of the driver. 2. Try to use the font downloaded from the driver.

Condition	Cause	Treatment
The Processing indicator is on or blinking but no paper is output.	There is data remaining in the printer.	Stop printing or force the remaining data to be output. See <i>"Canceling Printing/Faxing"</i> on page 3-9. See <i>"Outputting"</i> on page 3-13.
Paper tray is stuck.	During printing, has the cover been opened or the power switched off?	Switch off the power without forcefully moving the paper tray. After a few seconds, switch it on. Check that the printer is in the state to receive data and then push in/pull out paper tray.

NOTE: When printing has not been correctly processed, the information will be saved in Print History. When printing has not been processed, make use of the Print History feature to check the print processing condition. Print data that cannot be correctly processed might be discarded.



See *"Outputting Reports/Lists"* on page 5-30. for details on how to print the Print History.



When the Print Quality is Poor

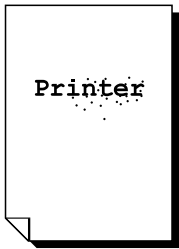
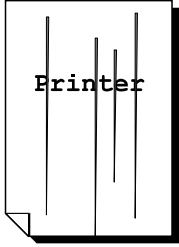

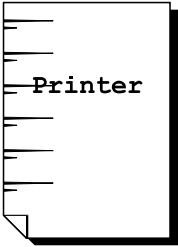
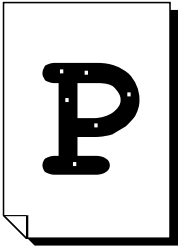

When the print quality is poor, carry out the necessary treatment according to the condition as close to those listed below as possible. When printing document with large amount of data, the resolution might decrease. Increasing the PCL memory data might prevent a decrease of resolution.

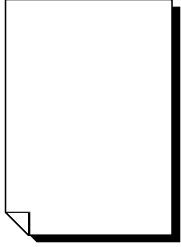
If the print quality does not improve after the treatment, contact our Customer Support Center.

Condition	Cause	Treatment
Printing is not clear (faded, not sharp). 	The paper has excessive moisture.	Replace with new paper. User Guide (Copier)
	The drum/toner cartridge is defective or damaged.	Replace with a new drum/toner cartridge. See the "User Guide (Copier)"
	The toner in the drum/toner cartridge has been used up.	Replace with a new drum/toner cartridge. See the "User Guide (Copier)"
Black spots printed. 	The paper used is not suitable.	Load the suitable paper. See the "User Guide (Copier)"
	The drum/toner cartridge is defective or damaged.	Replace with a new drum/toner cartridge. See the "User Guide (Copier)"
Black stripes printed. 	The drum/toner cartridge is defective or damaged.	Replace with a new drum/toner cartridge. See the "User Guide (Copier)"

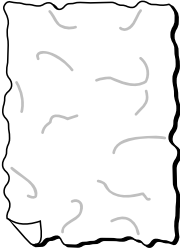
Condition	Cause	Treatment
Stains at equal intervals. 	The transportation route for the paper is stained.	Print a few pages.
	The drum/toner cartridge is defective or damaged.	Replace with a new drum/toner cartridge. See the <i>"User Guide (Copier)"</i>
White spots in the printed black portion. 	The paper used is not suitable.	Load the suitable paper. See the <i>"User Guide (Copier)"</i>
	The drum/toner cartridge is defective or damaged.	Replace with a new drum/toner cartridge. See the <i>"User Guide (Copier)"</i>
Smudges when scrubbed with fingers. 	The paper has moisture.	Replace with new paper. See the <i>"User Guide (Copier)"</i>
	The paper used is not suitable.	Replace with suitable paper. See the <i>"User Guide (Copier)"</i>
	The front cover is not completely closed.	Close the front cover. Check that the two sides of the cover are locked.
Page is printed completely black. 	The drum/toner cartridge is defective or damaged.	Replace with a new drum/toner cartridge. See the <i>"User Guide (Copier)"</i>
	May be due to high voltage problem.	Contact our Customer Support Center.

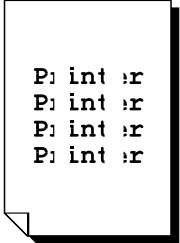
Condition	Cause	Treatment
Nothing is printed. 	The toner seal of the drum/toner cartridge is not pulled out.	Remove the seal from the drum/ toner cartridge. See the <i>"User Guide (Copier)"</i>
	Multiple sheets of paper are fed at once (double feeding).	Fan the paper and load them again. See the <i>"User Guide (Copier)"</i>
	The toner in the drum/toner cartridge has been used up.	Replace with a new drum/toner cartridge. See the <i>"User Guide (Copier)"</i>
	The drum/toner cartridge is defective or damaged.	Replace with a new drum/toner cartridge. See the <i>"User Guide (Copier)"</i>
	May be due to high voltage problem.	Contact the Customer Support Center.
Character void 	The paper has moisture.	Replace with new paper. See the <i>"User Guide (Copier)"</i>
	The paper used is not suitable.	Replace with suitable paper. See the <i>"User Guide (Copier)"</i>
	The toner seal is not pulled out completely.	Replace with a new drum/toner cartridge. See the <i>"User Guide (Copier)"</i>

Condition	Cause	Treatment
Paper has wrinkles. Printing smeared.  	The paper used is not suitable.	Replace with suitable paper. See the <i>"User Guide (Copier)"</i>
	The paper has curled corners.	Replace with suitable paper. See the <i>"User Guide (Copier)"</i>
	The paper has moisture.	Replace with new paper. See the <i>"User Guide (Copier)"</i>
Vertical white strips. 	The drum/toner cartridge is not correctly set.	Adjust and set it correctly. See the <i>"User Guide (Copier)"</i>
	The seal is not completely pulled out.	Replace with a new drum/toner cartridge. See the <i>"User Guide (Copier)"</i>
	The drum/toner cartridge is defective or damaged.	Replace with a new drum/toner cartridge. See the <i>"User Guide (Copier)"</i>
	Toner in the drum/toner cartridge has been used up.	Replace with a new drum/toner cartridge. See the <i>"User Guide (Copier)"</i>
Printing is slanted. 	The guide clips of the paper tray are not set in the correct positions.	Adjust and set the side guide and end guide correctly. See the <i>"User Guide (Copier)"</i>

Messages

This section explains about the different messages and error codes that appear on the printer control panel display.

List of messages

There are two types of messages: machine status (indicated by "Status") and errors (by "Cause/Treatment"):

The print data remaining in the printer and information stored in the printer memory are not secured when the error message is being displayed.

Message	Cause/Treatment
Ready to print or fax	Status: The printer is ready to receive data from the computer.
Please wait	Status: The printer system is being diagnosed or initialized. This message is displayed when the power is on or when the system is reset. After a while, it will change to "Ready to print or fax". The printer is warming up to print the data remaining in the machine.
Please wait XXXX	Status: The printer is warming up to print the data remaining in the machine.
XXXX Printing ... Tray *	Status: Printing report/list.
Printing ... XXXX	Status: Processing printing.
Printing ... XXXX Tray *	Status: Using Tray * for printing. Do not pull our the paper tray in use.
Ejecting ... XXXX Tray *	Status: Processing printing.
Canceling ... XXXX Tray *	Status: Canceling print data.
Data wait XXXX	Status: In the state of waiting for data.
Storing image ... XXXX HDD	Status: Saving Secure Print job data.

Message	Cause/Treatment
Printer paused	Status: In the pause state after pressing Pause . To exit the pause state, press Pause again.
Pausing ... Data received	Status: In the pause state after pressing Pause while printing. To exit the pause state, press Pause again.
All data Canceling ...	Status: Canceling all data remaining in the printer.
All data Ejecting ...	Status: Ejecting all data remaining in the printer.
Initializing PostScript ...	Status: Initializing the optional PostScript ROM.
Replace Drum/ Toner Cartridge	Cause: The drum/toner cartridge has to be replaced now or soon. Treatment: If the light of the Error indicator on the printer control panel is on, it is time to replace the drum/toner cartridge. If the light is off, get ready to replace it soon. See the <i>"User Guide (Copier)"</i>
Push in tray *	Cause: Tray * is not pushed in properly. Treatment: Push in tray * right to the end. See the <i>"User Guide (Copier)"</i>
Add paper tray * XXXX	Cause: Tray * has run out of paper of xxxx-size/ orientation. Treatment: Replace with paper of xxxx-size/orientation. See the <i>"User Guide (Copier)"</i>
Check Tray * XXXX	Cause: Tray * is not loaded with the correct paper. Treatment: Replace with paper of xxxx-size/orientation. See the <i>"User Guide (Copier)"</i>
Load Tray * XXXX	Cause: Tray * has run out of paper of xxxx-size/ orientation. Treatment: Replace with paper of xxxx-size/orientation. See the <i>"User Guide (Copier)"</i>
Duplicate IP Address	Cause: IP address is duplicated. Treatment: Change the IP address. See <i>"Setting IP Address" on page 2-15.</i>
Unable to get IP Address	Cause: Unable to get IP address from the DHCP server. Treatment: Set the IP address manually. See <i>"Setting IP Address" on page 2-15.</i>
Duplicate SMB host names	Cause: There is an existing similar SMB host name. Treatment: Change the host name. See <i>"Other Printer Settings" on page 2-22.</i>

Message	Cause/Treatment
<div style="border: 1px solid black; padding: 5px; width: fit-content;"> <p>Ready to print or fax (***-***-****)</p> </div>	<p>Cause: There is an error in the machine.</p> <p>Treatment: Switch off the machine, and switch it on again after the printer control panel display has been turned off. If the error code appears again, check the error code (***-****) to treat it. <i>See "Messages about error codes" on page 7-12.</i></p>
<div style="border: 1px solid black; padding: 5px; width: fit-content;"> <p>Error resolved (***-****)</p> </div>	<p>Cause: There is an error in the machine, and printing cannot be done correctly.</p> <p>Treatment: Check the error code (***-****) on the display to treat it. <i>See "Messages about error codes" on page 7-12.</i></p>
<div style="border: 1px solid black; padding: 5px; width: fit-content;"> <p>Please reboot printer (***-****)</p> </div>	<p>Cause: There is an error in the machine.</p> <p>Treatment: Switch off the machine, and switch it on again after the printer control panel display has been turned off. If the error code appears again, copy the error code (***-****) displayed, and then switch off the machine. When the light of the printer control panel display is gone, unplug the machine, and contact our Customer Support Center.</p>

Messages about error codes

The following messages will appear when printing cannot not be completed properly due to an error or when there is a machine breakdown:

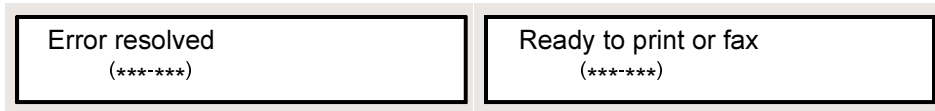

Treat the error by referring to the following table.

When an error code is displayed, print data remaining in the machine or information stored in its memory may not be secure.

Error Code	Cause/Treatment
003-747	<p>Cause: Wrong combination of print parameters, like selecting custom paper size and setting Auto for Paper Source.</p> <p>Treatment: Check the print parameters. For the above instance, select Bypass Tray.</p>
012-281 012-282 012-283 012-284 012-261 012-262	<p>Cause: Breakdown of the stapler finisher.</p> <p>Treatment: Contact our Customer Support Center. You can use other paper tray besides the finisher.</p>
016-702	<p>Cause: PCL print data cannot be processed due to insufficient page buffer.</p> <p>Treatment: Carry out one of the following treatments: increase the page buffer install more memory. <i>See "Memory Allocation" on page 2-24.</i></p>
016-705	<p>Cause: Cannot save Secure Print documents as the Printer HDD Kit has not been installed.</p> <p>Treatment: The Printer HDD Kit has to be installed in order to use the Secure Print feature. <i>See "Printing Secure Print and Sample Print Jobs" on page 3-19.</i></p>
016-706	<p>Cause: The number of users of Secure Print/Sample Print has exceeded the limit.</p> <p>Treatment: Cancel some of the unnecessary documents stored in the machine, and print again. <i>See "Printing Secure Print and Sample Print Jobs" on page 3-19.</i></p>
016-707	<p>Cause: Cannot process Sample Print jobs as the Printer HDD Kit has not been installed or there is a hard disk error.</p> <p>Treatment: The Printer HDD Kit has to be installed in order to use the Sample Print feature. <i>See "Printing Secure Print and Sample Print Jobs" on page 3-19.</i></p>
016-708	<p>Cause: The number of pages for printing has exceeded 999.</p> <p>Treatment: Reduce the number of pages for printing, like printing one set at a time instead of multiple sets.</p>
016-719	<p>Cause: Insufficient memory for PCL.</p> <p>Treatment: Increase the number of PCL memory.</p>

Error Code	Cause/Treatment
016-720	Cause: Detected PCL command error. Treatment: Send data again. If the same error code appears, check PCL data.
016-721	Cause: Error in print processing. Treatment: Send printing again. If the same error code appears, contact our Customer Support Center.
016-726	Cause: Printer language cannot be selected automatically although the Print Mode has been set to Auto. Treatment: Select the printer language using the printer control panel or command.
016-731	Cause: Cannot print as the TIFF data has been cut. Treatment: Print again.
016-735	Cause: Printed the Job Template List while it is being changed. Treatment: Wait awhile and print again.
016-736	Cause: Syntax error in Job Template List detected. Treatment: Select or recreate another Job Template List.
016-737	Cause: Error in reading data from pool server of Job Template List. Treatment: Check the access right of the directory where the Job Template List is being stored.
016-739	Cause: Cannot detect the selected pool server of the Job Template List. Treatment: Check the path name of the Job Template List pool server.
016-740	Cause: Cannot log in to the pool server of the Job Template List. Treatment: Check log-in information like user name and password.
016-741	Cause: Cannot connect to the pool server of the Job Template List. Treatment: Request for help from the network administrator, to check the network and server environments.
016-742	Cause: Cannot save to Job Template due to insufficient hard disk. Treatment: Increase the free space by deleting unnecessary data in the hard disk or initializing it.
016-743	Cause: Wrong setting for the Job Template pool server. Treatment: Check the setting of the Job Template pool server.
016-744	Cause: Cannot obtain the IP address of the Job Template pool server. Treatment: Check whether connection can be made to the DNS server. Or check if the domain name of the Job Template pool server is registered in the DNS.
016-745	Cause: Cannot obtain the IP address of the Job Template pool server. Treatment: Set the DNS address correctly. Or enter the IP address as the Job Template pool server address.
016-746	Cause: Wrong IP address set for this machine. Treatment: Check the DHCP environment. Or set a fixed IP address for this machine using the printer control panel.
016-748	Cause: Cannot print due to insufficient hard disk space. Treatment: Increase the free space by deleting unnecessary data in the hard disk.
016-749	Cause: PJI command syntax error detected. Treatment: Check the printer settings or correct the PJI command.

Error Code	Cause/Treatment
016-760	<p>Cause: Error in PostScript data (optional) processing.</p> <p>Treatment: Do one of the following: increase the print page buffer increase the memory of PostScript See "Memory Allocation" on page 2-24.</p>
016-762	<p>Cause: Uninstalled printer language selected.</p> <p>Treatment: Select the printer language using the printer control panel or command.</p>
016-764	<p>Cause: Cannot connect to the SMTP server.</p> <p>Treatment: Consult the mail system administrator.</p>
016-765	<p>Cause: Cannot send mail as the SMTP server is full.</p> <p>Treatment: Consult the mail system administrator.</p>
016-766	<p>Cause: Error in the SMTP server.</p> <p>Treatment: Consult the mail system administrator.</p>
016-767	<p>Cause: Cannot send mail as the mail address is wrong.</p> <p>Treatment: Check the mail address and send again.</p>
016-768	<p>Cause: Cannot connect to the SMTP server as the mail address of this machine is not correct.</p> <p>Treatment: Check the mail address of this machine.</p>
016-769	<p>Cause: The SMTP server cannot respond to DSN.</p> <p>Treatment: Do not use DSN to send mail.</p>
016-770	<p>Cause: Cannot process the Job Template due to insufficient hard disk space.</p> <p>Treatment: Increase the hard disk space by deleting unnecessary data in the hard disk.</p>
016-771 016-772	<p>Cause: Cannot obtain the scan data repository address by the CentreWare Scanning Services.</p> <p>Treatment: Set the DNS address correctly. Or set the scan data repository address by the IP address.</p>
016-773	<p>Cause: Wrong IP address set for this machine.</p> <p>Treatment: Check the DHCP environment. Or set a fixed IP address for this machine using the printer control panel.</p>
016-775	<p>Cause: Cannot process image replacement due to insufficient hard disk space.</p> <p>Treatment: Increase the hard disk space by deleting unnecessary data in the hard disk.</p>
016-777	<p>Cause: Hard disk error during image processing.</p> <p>Treatment: The hard disk might be spoilt. Replace with another one and try again.</p>
016-781	<p>Cause: Connection to the server failed during fax transmission by CentreWare Scanning Services or internet fax.</p> <p>Treatment: Check with the network administrator on the network environment and server environment.</p>
016-782	<p>Cause: Cannot log on to the server during fax transmission by CentreWare Scanning Services.</p> <p>Treatment: Check the user name and password for logging on to the server.</p>
016-783	<p>Cause: Cannot locate the specified server during fax transmission by CentreWare Scanning Services.</p> <p>Treatment: Check the server path name set in the Job Template.</p>

Error Code	Cause/Treatment
016-784	Cause: Error in writing to the server during fax transmission by CentreWare Scanning Services. Treatment: Check the access right of the directory housing the file.
016-785	Cause: File transmission by CentreWare Scanning Services failed due to insufficient disk memory of the server. Treatment: Increase the free space by deleting unnecessary data in the hard disk.
016-786	Cause: Cannot save file temporarily by CentreWare Scanning Services due to insufficient hard disk memory. Treatment: Increase the free space by deleting unnecessary data in the hard disk or initializing.
016-787	Cause: Wrong server IP address set for the Job Template. Treatment: Check the server IP address set for the Job Template.
016-793	Cause: Insufficient hard disk space. Treatment: Increase the hard disk space by deleting unnecessary data in the hard disk.
016-799	Cause: Wrong combination of print parameters, like selecting custom paper size and setting Auto for Paper Source . Treatment: Check the print parameters. For the above instance, select Bypass Tray .
081-701	Cause: Wrong fax number specified. Treatment: Check the fax number and try again.
081-702	Cause: Wrong fax parameter settings, like specifying an internal line when it does not exist. Treatment: Check the printer driver setting.
081-703	Cause: Insufficient memory when using fax. Treatment: Send the document in batches or with decreased resolution. Or delete any unnecessary stored documents found.
081-704	Cause: Processing canceled by user. Treatment: --
081-705	Cause: Machine cannot be used in the condition specified, like the tray specified is available but has no paper. Treatment: Check the machine condition.
081-706 081-707	Cause: Error in fax processing. Treatment: Switch off the power, wait for the control panel display light to go off before switching on the power again.
081-708	Cause: Circuit is cut-off at the recipient when faxing. Treatment: Check the recipient machine and the circuit, and then try again.
081-709	Cause: Transmission error during faxing. Treatment: Check the circuit connection and try again.
081-710	Cause: Breakdown of the recipient machine or error when faxing. Treatment: Check the machine condition and try again.
081-711	Cause: Insufficient resource when operating the mailbox. Treatment: Switch off the power, wait for the control panel display light to go off before switching on the power again.
081-712	Cause: Specified mailbox number is outside the range. Treatment: Check the mailbox number.

Error Code	Cause/Treatment
081-713	Cause: Incorrect mailbox number and password style. Treatment: Check the mailbox number and password style.
081-714	Cause: Specified mailbox is not registered. Treatment: Check the mailbox number.
081-715	Cause: Incorrect mailbox password. Treatment: Check the mailbox password.
081-716	Cause: Specified document not found in mailbox. Treatment: Check the mailbox number.
081-717	Cause: Document in specified mailbox is being used. Treatment: Wait awhile, and then try again.
081-718	Cause: Document in mailbox cannot be retrieved. Treatment: Try again.
081-719	Cause: Document cannot be saved in specified mailbox. Treatment: Try again.
081-720 081-722	Cause: Internal machine error. Treatment: Switch off the power, wait for the display on the control panel to go off, and then switch on the power again.
081-721	Cause: Processing interrupted according to user's instruction. Treatment: --

Using TCP/IP

This section provides information on the possible causes, verifying methods and recommended actions pertaining to errors which may occur when the printer is being used with TCP/IP.

When using Windows 95, Windows 98, Windows Me

Cause		
The printer and the computer are connected to different networks.	Status Display	Network Error (Unable to Print)
	Verification	Check with the network system administrator to verify that the network connecting the computer and that connecting the printer are linked by a router or a gateway.
	Action	Connect the printer directly to the network connecting the computer.
An error has occurred in the network between the computer and the printer. Connection cannot be established.	Status Display	Network Error (Unable to Print)
	Verification	--
	Action	Ask the system administrator of the network to check the network for errors.
The IP address of the printer is entered wrongly.	Status Display	Network Error (Unable to Print)
	Verification	From the printer window, select Properties from the Printer menu. Click the Details tab of the dialog box displayed. Then select Port Settings. Compare the IP address in the dialog box and the Printer Settings List. <i>See "Types of reports/lists" on page 5-30.</i>
	Action	Enter the correct IP address set at the printer in the dialog box.
The printer is switched off after the print instruction has been sent from the computer. Or the print instruction is sent to the printer which is switched off.	Status Display	Network Error (Unable to Print)
	Verification	Check whether the printer is switched on.
	Action	Switch on the printer.
Print instructions from multiple computers are sent to the printer at the same time.	Status Display	Network Error (Unable to Print)
	Verification	--
	Action	-- (Printing will be reprocessed automatically.)
Printing files cannot be spooled due to insufficient disk capacity of the computer.	Status Display	Spool Error (Unable to print)
	Verification	Double-click My Computer and right-click the disk installed with Windows 95/Windows 98/Windows Me (e.g. C drive). Select Properties from the menu displayed and then check the free space available.
	Action	After erasing unnecessary files to increase the free space available, select Pause Printing from the Document menu of the Printer window to enable printing to restart.

When using Windows NT 4.0

When the printer is not printing

Cause	Verification	Action
Incorrect IP address	Ask the network administrator to check that the IP address is correct.	Set up the correct IP address for the printer.
If LPD spool is set to memory, the print data sent by the user in a single print instruction has exceeded the upper limit of the receiving capacity set up on the printer control panel.	Check the upper limit of the receiving capacity from the touch panel display and compare it with the print data which was sent in the single print instruction.	<ol style="list-style-type: none"> 1. If a single file of print data has exceeded the upper limit of the receiving capacity, split the file into smaller ones to keep them below the upper limit of the receiving capacity. 2. If multiple files have exceeded the upper limit of the receiving capacity, reduce the number of files which can be sent at one go.
An irrecoverable error has occurred during printing.	Check the display of "LPD Error" from the printer control panel.	Power off and on the printer.
The transport protocol is different from that of the client.	Check the selected transport protocol on the touch panel display.	Select the same transport protocol as that of the client.

Unable to obtain the desired print results

Cause	Verification	Action
The specified print language and that of the print data are different.	Check the specified print language and that of the print data.	Specify the same print language as that of the print data.
If it is running in Windows, the printer driver for this printer has not been used (a printer driver from another company has been used).	Check that the printer driver which came with this printer has been selected.	Select the printer driver which came with this printer. If it does not appear on the selection list, install and select the printer driver. If a printer driver from another company is used, the printer may not print properly.

Using CentreWare Internet Services

Cause	Treatment
Cannot be connected to CentreWare Internet Services.	Is the printer working properly? Check if the power of the printer is switched on.
	Is CentreWare Internet Services activated? Print out the Printer Settings List to check.
	Is the internet address correctly entered? Check the internet address again. If cannot be connected, enter the IP address to connect again.
	Is the proxy server used? Depending on the proxy server, connections might not be made. Without using the proxy server, either change the browser setting or the address to which you want to connect to one without using the proxy server.
The "Please wait" message is displayed throughout.	Wait for awhile as instructed. If nothing happens, try clicking the Refresh button. And even then, if nothing happens, check if the printer is working properly.
The Refresh button is not working. Selecting the left frame menu does not change the right frame settings.	Are you using the target OS and browser? Check if the OS and browser you are using can be used.
The screen display is distorted.	Change the window size of the browser.
The latest information is not displayed.	Click the Refresh button.
The new settings are not reflected by clicking the Apply New Settings button.	Is the value entered correct? If the value entered is not within the correct range, it will be changed to a value within the correct range automatically.
Clicking the Apply New Settings button prompts messages like no data or the server has returned ineffective or unrecognizable response.	Is the password correct? The entry for Confirm Password is not similar to Password. Enter the correct password.
	Reboot the printer.
Even if the job you want to delete is checked, the selection is unchecked later.	Is the Auto Refresh set? Either set Auto Refresh Interval of Internet Services Settings on the Properties tab to Void or to a higher value.
The job cannot be deleted.	Wait for awhile, and then click the Refresh button. Even if jobs are detected from LPD of Job List, they might not be deleted from system. When this happens, delete the job from system again.
When LPD or SMB is selected, a message will appear to say that it is not spool mode.	After the present page is displayed, the printer might be rebooted. Click the Refresh button. If nothing happens, try changing from the browser.

Appendix







































Specifications

The following information can be found in this chapter:

- Product specifications
- Printing area

Product specifications

The specifications of the printer is as follows. We regret that improvements in specifications/appearance of the product may be made without prior notice.

Item	Contents
Continuous Printing Speed (Paper from Tray 2)	WorkCentre Pro 428: 1 Sided: 21.5 copies/min. (A4 ) , 28 copies/min. (A4 ) 15.5 copies/min. (A3), 15.5 copies/min. (B4)
	WorkCentre Pro 423: 1 Sided: 17 copies/min. (A4 ) , 23 copies/min. (A4 ) 12 copies/min. (A3 ) , 12 copies/min. (B4 )
Resolution	23.6 dot/mm (600 dpi)
Paper Size	Tray 1: A5  , B5  , 8.5×11"  (Letter), A4 
	Tray 2 - Tray 4: B5  , B5  , 8.5×11"  , 8.5×11"  , A4  , A4  , 8.5×13"  , 8.5×14"  , B4  , A3  , 11×17" 
	Bypass Tray: A6  , B6  , 5.5×8.5"  , 5.5×8.5"  , A5  , A5  , B5  , B5  , 8.5×11"  , 8.5×11"  , A4  , A4  , 8.5×13"  , 8.5×14"  , B4  , A3  , 11×17"  Custom [short edge: 100-297 mm; long edge:148-432 mm] (when the short edge is 128 mm or less, the maximum length of the long edge will be 297 mm for paper in the  orientation)
Paper Type	Tray 1: Plain
	Tray 2 - Tray 4: Plain
	Bypass Tray: Plain, Transparency Heavyweight (105-156 mg/m ²)
Paper Supply	Tray 1 - Tray 4: 500 sheets
	Bypass Tray: 100 sheets
Output Tray Capacity	Center Output Tray: 500 sheets
	Side Output Tray: 200 sheets
	Finisher Tray Upper: 500 sheets
	Finisher Tray Lower: 200 sheets

Item	Contents
2 Sided Printing	Supported with the Duplex Unit installed Paper size supported: A5, B5, B5, 8.5×11", 8.5×11", A4, A4, 8.5×13", 8.5×14", B4, A3, 11×17"
Memory	Standard: 32 Mbyte
	Option: 64 Mbyte additional memory
Installed Fonts	Standard: European 81
PDL	Standard: PCL6
	Option: PostScript 3
Interface	Standard: Ethernet (100Base-TX/10Base-T), Bi-directional Parallel (IEEE1284-B), USB (for Windows 2000 only)
Supported OS for drivers	Windows 95/Windows 98/Windows Me/Windows NT 4.0/Windows 2000

Standard printing area

The printing area of each paper size is about the area remaining after subtracting 4.1 mm from all edges of the paper. The actual printing area may differ according to the printer language used.

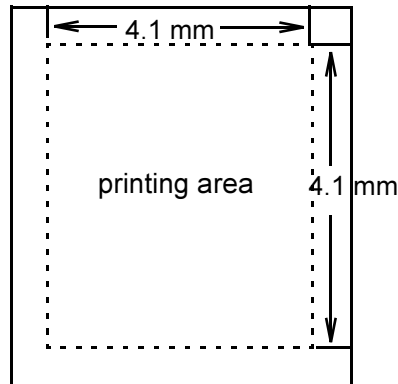

Glossary

A3	420×297 mm paper.
A4	297×210 mm paper.
A5	210×148 mm paper.
ACK	The signal indicating that the printer is ready to receive data from the host device or that data is correctly received.
Adobe protocol	Communication protocol of PostScript printer in serial/parallel connection.
B4	364×257 mm paper.
B5	257×182 mm paper.
Buffer	The place where data received by the host device is stored.
Busy	Signal indicating that the printer is not able to receive data from the host device.
Common Menu	This is where port settings, the print utility and maintenance mode are set.
CPI	Stands for Character Per Inch, which is the number of characters that can be printed within a width of 1 inch.
CR	Stands for Carriage Return, which is the change of line.
Cut paper	Standard types of paper like A4, B5 etc.
DPI	Stands for Dot Per Inch, which is the number of dots that can be printed within a width of 1 inch. Used as the unit for resolution.
DL	Stands for Double Letter. Also known as Ledger. 17×11" (432×279 mm) paper size.
DTR Control	Stands for Data Terminal Ready, which is the hardware signal that indicates whether the printer can receive data from the host device.
Emulation	The ability of the printer to perform the features of other printers.
Folio	13×8.5" (330×216 mm) paper.
Hard clip area	The actual rectangular area on the paper which can be printed.
Image Enhance	Feature which makes the border between black and white smooth, with rough edges reduced, giving the appearance of a higher resolution.
Job	A group of print data. The stopping and output of printing are conducted on a job basis. For mode menu changes, the new settings will be effective from the next job.

LED	Stands for Light Emitting Diode.
LG	14×8.5" (356×216 mm) paper. Also known as Legal.
LT	11×8.5" (279×216 mm) paper. Also known as Letter.
Mode Menu	Menu for setting the conditions pertaining to the PCL 6 emulation mode.
N-up	Feature for printing the data of N pages on a single sheet of paper.
NV Memory	Non-volatile memory which allows the settings of the printer to be maintained even when power is off.
Page buffer	The actual place where print data is retrieved and stored. The page buffer memory is secured after the printer memory is allocated to memories such as form memory, receive buffer memory etc., and it cannot be set using the control panel.
Parity check	The checking of whether the data sent is being received.
PostScript	Page-description language of Adobe Systems Incorporated.
Power Saver	The feature which saves the power consumption by lowering the temperature of the printer's fuser. The power saver mode is automatically activated when the time set has elapsed after the previous print job.
Printing area	The actual area on paper which can be printed.
Protocol	The rules of communication necessary for carrying out data transmission.
RAM	Stands for Random Access Memory, which is the memory device where information can be retrieved as well as recorded.
ROM	Stands for Read Only Memory, which is the memory device specific for the retrieval of information.

Index

Numerics

- 1 Sided Print **4-22**
- 100BASE-TX **2-10, 5-27**
- 10BASE-T **2-10, 5-27**
- 2 Sided Print **4-22, 5-6**
- 2 Sided Report **5-16**

A

- Access Control
 - IPP **5-21**
- Add Port No.
 - IPP **5-21, 5-22**
- Adobe Protocol
 - parallel **5-17**
 - USB **5-22**
- All Text to Black **4-27**
- Allocate Memory menu **5-3, 5-27**
- AppleTalk **2-5**
- Auto Configuration **4-17**
- Auto Eject Time
 - parallel **5-17**
 - USB **5-23**
- Auto Job History **5-16**
- Auto Tray Switch **3-3**
- AutoCancelPause **5-15**

B

- Bi-directional
 - parallel **5-17**
- Binding Edge **5-6**
- Booklet Creation **4-28, 4-29, 4-30**
- Buffer Size **5-28**
- Bypass Feed Orientation **4-16**
- bypass tray **1-4, 4-15, 5-5**

C

- center output tray **1-4, 4-22**
- Center Tray **5-5**
- CentreWare Internet Services **2-11, 2-24, 3-9, 7-19**
- Change Output Size (No Zoom) **4-28, 4-31**
- Change Password **5-15**
- Collated Settings **4-24**
- Comma Separated Values (CSV) **3-30**
- common menu **1-7, 5-2, 5-10**
- Communication Mode **4-38**
- Communication Setting **3-27, 4-37**
- Community (R) **5-25**

- Community (R/W) **5-25**
- Community (Trap) **5-25**
- Connect Time-Out
 - IPP **5-21, 5-22**
 - LPD **5-18**
 - Port9100 **5-23**
- control panel **1-4, 3-3**
- Copies **4-20**
- Custom Paper Size **4-20**

D

- Delayed Send **3-27**
- Device Halftone **4-17**
- direct faxing **3-25**
- Display Message **4-16**
- DNS **5-21, 5-22**
- Document Options **4-24**
- Domain List **5-33**
- Download as Bitmap **4-27**
- Download as TrueType **4-27**
- Draft Mode **4-27, 5-9**
- duplex module **4-16**
- Dynamic Host Configuration Protocol (DHCP) **2-15**

E

- E-mail/iFax **5-42**
- EMF Spooling **4-25**
- error codes **7-12**
- Error History Report **5-30**
- Ethernet **2-3, 2-10, 5-27**
- Ethernet 802.2 **5-26**
- Ethernet 802.3 **5-26**
- Ethernet II **5-26**
- Ethernet SNAP **5-26**
- EtherTalk **2-5, 5-24**

F

- Fault Tone **5-15**
- Fax Extended Memory **4-17**
- Fax Options tab **4-14, 4-35**
- Fax Phonebook **3-32, 4-36**
- Fax Recipient **3-26**
- Fax Resolution **4-35**
- finisher **4-15**
- finisher tray **1-4**
 - lower **4-22**
 - upper **4-22**
- Finishing **4-24**

First Sheet **4-24**
Fit To Output Size **4-28, 4-30**
Fit To Paper Size **4-30**
Flip on Long Edge **4-22**
Flip on Short Edge **4-22**
Font **5-6**
Font Pitch **5-9**
Font Size **5-8**
Form Lines **5-9**
FTP Client **2-11, 5-24**

G

Gateway Address **5-26**
Get DHCP Address **5-26**
Get IP Address **5-26**
Graphics Mode **4-26**
Graphics tab **4-14, 4-26**
Group Send **4-39**
Gutter **4-30**

H

Halftone **4-26**
Halftone Color Adjustment **4-28**
Hard Disk **4-17, 5-29**
Heavyweight **4-23**
HexDump **5-9**

I

Image Enhance **5-9**
Image Enhancement **4-27**
Image Orientation **4-22**
Import Fax Recipient Data **3-29**
Initialize/Delete Data menu **5-3, 5-28**
interface
 Ethernet **2-3, 2-10**
 parallel **2-2, 2-7**
 USB **2-2, 2-8**
interface connector
 Ethernet **1-5**
 parallel **1-5**
 USB **1-5**
Internet Printing Protocol (IPP) **2-6, 2-19, 2-23, 5-21**
Internet Service **5-25**
Interrupt mode **3-3, 3-4**
IP Address **5-26**
IP Filter **5-18**
IP List **5-18**
IPP Spool **5-28**
IPX/SPX **2-5**
IPX/SPX FrameType **5-26**

J

Job History Report **2-11, 5-30, 5-31**

Job Offset Settings **4-23**
Job Owner Settings **4-17**
Job Template List **5-33**
Job Type **4-19**

L

Landscape **4-16, 5-5**
Layout tab **4-14, 4-28**
local printer **2-2**
Long Edge Flip **5-6**
LPD **5-18**
LPD Spool **5-28, 6-5**
LPR **2-4**

M

Machine Mail Address **5-40, 5-43**
Mail Notice **5-40**
Mail Notice Settings **5-40, 5-43**
Mail Reject Notice **5-40**
mode menu **1-8, 5-2, 5-4**
MS Messaging System Address Book **3-29**
Multi-Up **4-29**

N

NetBEUI **2-3**
NetWare **2-5, 5-19**
NetWork/Port **5-16**
Network/Port menu **5-3**
No Rotation on Same Sheet **4-29**
No. of Search
 NetWare **5-19**
No. of Sets **5-9**
NVM **5-29**

O

Offset Catch Tray **4-16**
Offset Per Job **4-23**
Offset Per Set **4-23**
online Help **3-6**
Orientation **5-5**
Output **5-5**
Output Destination **4-22**
Output Options tab **4-14, 4-23**
Output Size **4-31**
Overlap **4-32**
overlay **3-16**
Overlays tab **4-14, 4-33**

P

Page Border **4-29, 4-32**
Page Position **4-31, 4-33**
Pages Per Sheet **4-29**
Pages Per Split **4-30**

Panel Lock **5-15**
 Paper Output Options **4-15**
 Paper Size **4-20**
 Paper Source **4-21**
 Paper Source Options **4-15**
 paper tray **1-4, 5-5**
 paper tray priority **3-4**
 Paper Type (Bypass Tray) **4-23**
 Paper/Output tab **4-14, 4-19**
 parallel interface **2-2, 2-7**
 parallel port **5-16**
 Pause/Resume button **1-4**
 PCL Fonts List **5-30, 5-32**
 PCL Memory **5-27**
 PCL Settings List **5-30**
 PCL Settings menu **5-5**
 PJL
 EtherTalk **5-24**
 LPD **5-18**
 NetWare **5-19**
 parallel **5-16**
 Port9100 **5-23**
 SMB **5-20**
 USB **5-22**
 Port No.
 Port9100 **5-23**
 Port Status
 EtherTalk **5-24**
 FTP Client **5-24**
 IPP **5-21**
 LPD **5-18**
 NetWare **5-19**
 parallel **5-16**
 Port9100 **5-23**
 SMB **5-20**
 SNMP **5-25**
 USB **5-22**
 Port9100 **5-23**
 Portrait **4-16, 5-5**
 Poster **4-28, 4-32**
 PostScript **5-27**
 PostScript Fonts List **5-30, 5-32**
 PostScript Kit **2-5, 2-14, 2-24, 2-25, 6-3**
 PostScript Logical Printer List **5-30**
 Primary IP **5-26**
 Print Area **5-16**
 Print as Graphics **4-27**
 Print Meter **5-29**
 Print Mode
 IPP **5-21**
 LPD **5-18**
 NetWare **5-19**
 parallel **5-16**
 Port9100 **5-23**
 SMB **5-20**
 USB **5-22**
 Print Reject Notice **5-40**
 printer
 local **2-2**
 printer control panel **1-4, 1-6**

printer driver
 configuring **4-12**
 installing **4-3**
 overview **4-2**
 Printer HDD Kit **3-19**
 Printer Meter Report **5-30**
 Printer Settings List **2-16, 5-30**
 Printer Settings menu **5-3, 5-29**
 Printer tab **4-14, 4-15**

Q

Quick Setup menu **2-11, 5-3**

R

Raster **4-26**
 Receive buffer **2-24**
 Receive E-mail/iFax **5-40**
 Recipient List **3-26, 3-28**
 Regular Notice **5-40**
 Relay Send **4-39**
 Report/List menu **5-3**

S

Salutation **2-11, 5-24**
 Sample Print **3-19, 4-19**
 Secondary IP **5-26**
 Secure Print **3-19, 4-19**
 Secure Send **4-38**
 Select Substitute Tray **4-16**
 Send E-mail/iFax **5-40**
 Send Header **4-36**
 Server Message Block (SMB) **2-3, 2-4, 2-19, 2-22**
 Short Edge Flip **5-6**
 side output tray **1-4, 4-15, 4-22**
 Side Tray **5-5**
 SMB **5-20**
 SMB Spool **5-28**
 SMTP Server Address **5-40, 5-43**
 SNMP **2-11, 2-21, 5-25**
 Speed Dial Data EWS-CSV **3-31**
 Speed Dial Number **3-28**
 Stapling **4-24**
 Stored Documents List **5-30**
 Style **4-32**
 Subnet Mask **5-26**
 Substitute Tray **5-29**
 switch **1-4**
 Symbol Set **5-8**
 System Clock **5-15**
 System Settings menu **5-3, 5-15**

T

TBCP Filter

IPP **5-21**
LPD **5-18**
NetWare **5-19**
Port9100 **5-23**
SMB **5-20**
TCP/IP **2-3, 2-4, 2-5, 7-17**
TCP/IP (LPD) **2-19, 2-22**
TCP/IP Settings **5-26**
Transmission Report **4-36**
Transparency **4-23**
Transparency Separators **4-25**
Transpt Protocol
 NetWare **5-19**
 SMB **5-20**
 SNMP **5-25**
tray 4 **1-4, 4-15, 5-5**
TrueType Font Mode **4-27**

U

UNIX **2-4**

USB **2-2, 2-8, 5-22**
Use Booklet Paper Size **4-30**
Use Larger Size (No Zoom) **4-16**
Use Printer Settings **4-16**
Use Printer TrueType Fonts **4-28**

V

Vector **4-26**

W

Watermarks tab **4-14, 4-34**
Windows Address Book (WAB) **3-30**
Windows Internet Name Service (WINS) **2-15**
WINS Server **5-26**

Z

Zoom **4-28, 4-31**

Free Manuals Download Website

<http://myh66.com>

<http://usermanuals.us>

<http://www.somanuals.com>

<http://www.4manuals.cc>

<http://www.manual-lib.com>

<http://www.404manual.com>

<http://www.luxmanual.com>

<http://aubethermostatmanual.com>

Golf course search by state

<http://golfingnear.com>

Email search by domain

<http://emailbydomain.com>

Auto manuals search

<http://auto.somanuals.com>

TV manuals search

<http://tv.somanuals.com>