



XC353/355/356

Table of Contents

Safety Notes	1
Unpacking	4
Getting to Know Your Copier	5
Rear View	6
Underside View.....	6
Installation	7
XC351.....	7
XC353/ XC355/ XC356.....	7
Control Panel	10
XC351.....	10
XC353/ XC355/ XC356.....	10
Paper Specifications	11
Paper Storage.....	11
Specification Chart.....	11
Making Copies on the XC351	12
Making Copies on the XC353, XC355 and XC356	13
Copy Quality	15
Two-Sided Copying	16
Setting Copy Exposure Range	17
 Paper Supply Indicator (XC353, XC355 and XC356)	18
 Misfeed Removal	19
Paper Feed Slot.....	19
Exit Area.....	19
Internal Area	20
 Toner Cartridge	22
Toner Cartridge Replacement	22
Toner Cartridge Yield	24
Drum Cartridge Replacement	25

Problem Solving	28
Problem Solving Chart.....	28
Status Code Chart	30
Copier Maintenance	31
Document Glass and Cover	31
Lens.....	31
Packing the Copier	32
Technical Data	34

Safety Notes

Your copier and supplies have been designed and tested to meet strict safety requirements. These include safety agency examination and approval, and compliance to established environmental standards. Please read the following instructions carefully before operating the copier and refer to them as needed to ensure the continued safe operation of your copier.

Follow all warnings and instructions marked on or supplied with the product.

Symbology:  = High Voltage,  = Heated Surface.

Unplug this copier from the wall outlet before cleaning. Always use materials specifically designated for this copier. Use of other materials may result in poor performance and could create a hazardous situation.

Do not use aerosol cleaners. Follow the instructions in this User Guide for proper cleaning methods.

Never use supplies or cleaning materials for purposes other than what they were intended. Keep all supplies and materials out of reach of children.

Do not use this copier near water, wet locations, or outdoors.

Do not place this copier on an unstable cart, stand, or table. The copier may fall, causing personal injury or serious damage to the copier.

This product is equipped with a 3-wire grounding type plug (e.g., a plug having a third grounding pin). This plug will fit only into a grounding-type power outlet. This is a safety feature. To avoid risk of electric shock, contact your electrician to replace the receptacle if you are unable to insert the plug into the outlet. Never use a grounding adapter plug to connect the copier to a power source receptacle that lacks a ground connection terminal.

This copier should be operated from the type of power source indicated on the marking label. If you are not sure of the type of power available, consult your local power company.

Safety Notes

Do not allow anything to rest on the power cord. Do not locate the copier where persons will step on the cord.

The power supply cord is the disconnect device for this equipment. Insure that installation is near the outlet and is easily accessible.

Your machine is equipped with an energy saving device to conserve power when the machine is not in use. The machine may be left on continuously.

Slots and Openings in the cabinet and in the back and sides of the copier are provided for ventilation. To ensure reliable operation of the copier and to protect it from overheating, these openings must not be blocked or covered. The copier should never be located near or over a radiator or heat register. This copier should not be placed in a built-in installation unless proper ventilation is provided.

Never push objects of any kind into the slots of the copier as they may touch dangerous voltage points or short out parts which could result in a fire or electric shock.

Never spill liquid of any kind on the copier.

Never remove covers or guards that require a tool for removal. There are no casual operator serviceable areas within these covers.

Never defeat interlock switches. Machines are designed to restrict operator access to unsafe areas. Covers, guards, and interlock switches are provided to ensure that the machine will not operate with covers opened.

Use of an extension cord with this copier is not recommended or authorized. Users should check building codes and insurance requirements if an extension cord is to be used. Ensure that the total ampere ratings of the products plugged into the extension cord do not exceed the extension cord ampere rating. Also, make sure that the total amperage of all products plugged into the wall outlet does not exceed the outlet rating.

Safety Notes

Avoid direct viewing of the document lights. The lamps are bright and, while not harmful, they may cause an annoying afterimage. Always keep the document cover closed during operation and storage.

Avoid exposing the drum cartridge to light for extended periods of time.

Do not touch the red photoreceptor. Scratches or smudges that appear on the photoreceptor will result in poor copy quality and may shorten the service life.

Do not put your hands into the fuser area, located just inside the exit tray area, as you may be burned.

Ozone: This product produces ozone during normal operation. The ozone produced is dependent on copy volume and is heavier than air. Providing the correct environmental parameters, as specified in the Xerox installation procedures, will ensure that concentration levels meet safe limits.



This equipment complies with Council Directive 89/336/EEC, approximation of the laws of the Member States related to electromagnetic compatibility and Council Directive 73/23/EEC amended by Council Directive 93/68/EEC, approximation of the laws of the Member States related to low voltage equipment.

Unpacking

IMPORTANT: Save the carton and packing materials for future use.

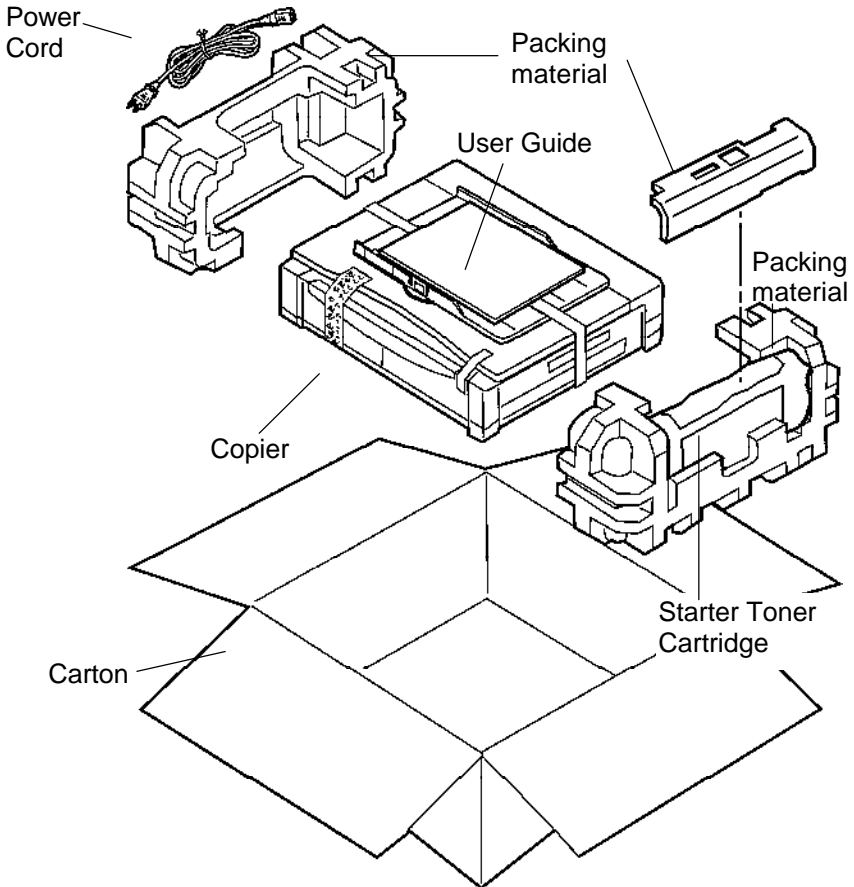

Getting to Know Your Copier

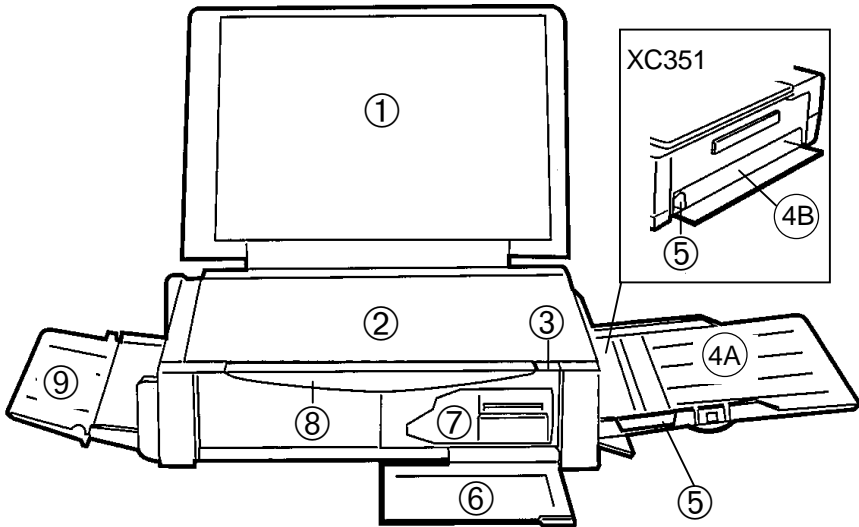

- ① Document Cover
- ② Document Glass
- ③ Front Cover Open Button
- ④A Paper Tray (XC353/ XC355/ XC356)
- ④B Paper Feed Slot (XC351)
- ⑤ Paper Guide
- ⑥ Front Cover
- ⑦ Starter Toner Cartridge
- ⑧ Control Panel
- ⑨ Exit Tray (XC353/ XC355/ XC356)

Getting to Know Your Copier

Rear View

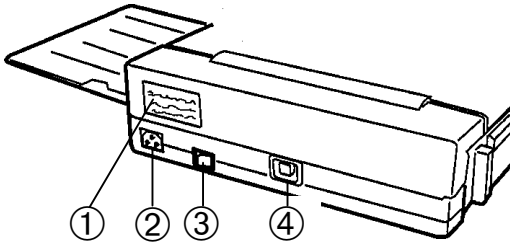

- ① Serial Number
- ② Power Cord Socket
- ③ On/Off Switch
- ④ Document Glass Release Button

Underside View

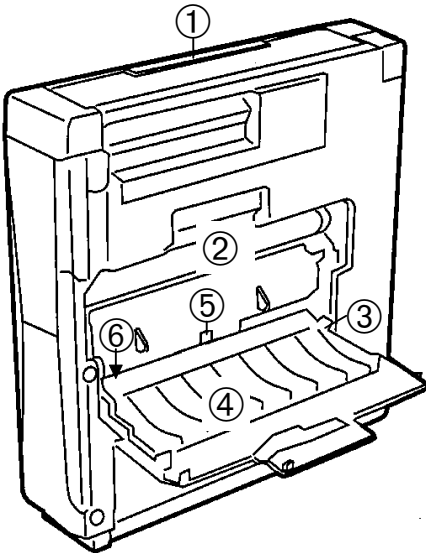

- ① Handle
- ② Drum Cartridge
- ③ Bottom Cover Release Lever
- ④ Bottom Cover
- ⑤ Drum Cartridge Release Lever
- ⑥ Fusing Area

Installation

For reliable copier operation and copy quality, Xerox recommends:

- Place your copier in a well-ventilated room.
- Recommended environment:
 - Temperature: 50° to 90°F / 10° to 32°C.
 - Humidity: 20% to 85%.
- Place the copier on a flat, level surface.
- Avoid locations that subject the copier to:
 - Direct sunlight.
 - Extreme changes in temperature or humidity.

After selecting a location that meets the conditions, ensure that there is sufficient space around the copier.

XC351

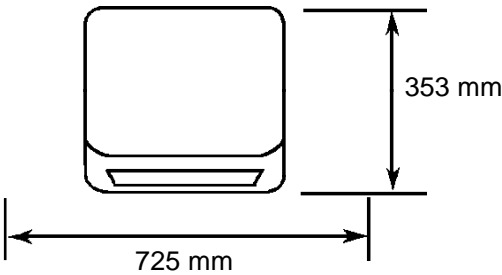

XC353/ XC355/ XC356

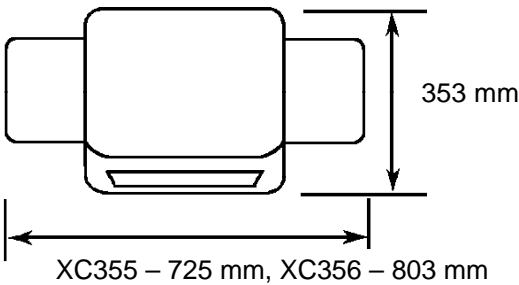

Installation

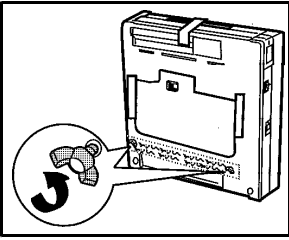

1. Remove the copier from the bag.
2. Remove the thumbscrews, tape and the label from the bottom of the copier.

Note: Failure to remove the thumbscrew will cause a paper jam when operating the copier.

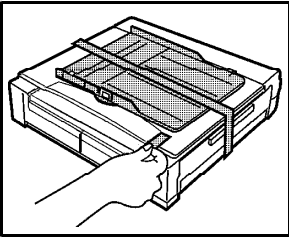

3. Remove all the pieces of tape from the copier and then place the copier on a level surface.

XC351 skip to step 5

4. Remove the paper tray from the top of the copier.

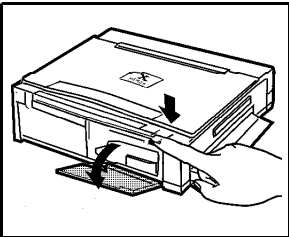

5. Press the button to open the front cover.

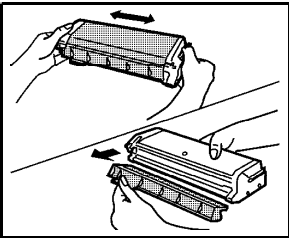

6. Vigorously shake the toner cartridge horizontally several times.
7. Remove the toner cartridge cover.

Installation

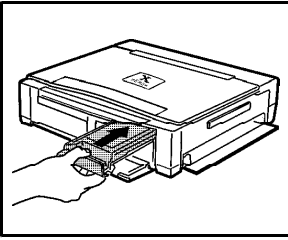

8. Slide the toner cartridge in until it locks in place.
9. Close the front cover.

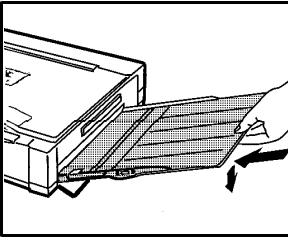

- XC351 skip to step 12**
10. Install the paper tray by inserting it at an upward angle into the grooves on the side of the paper feed slot.

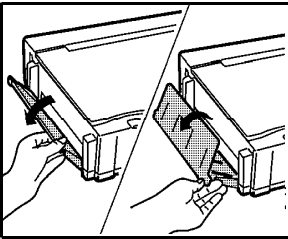

11. Open and unfold the exit tray.

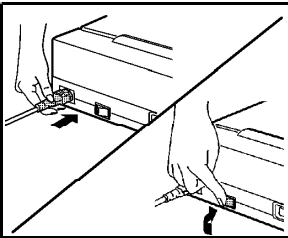

12. Plug the power cord into the copier and then into an earthed outlet.

Note: Ensure that the power cord is inserted firmly.

13. Turn the power on.

Note: Wait approximately 1 minute for the Ready indicator to light.

CAUTION: Ensure that the areas to the right and left sides of the copier are free of obstructions which may prevent movement of the document glass.

Control Panel

XC351

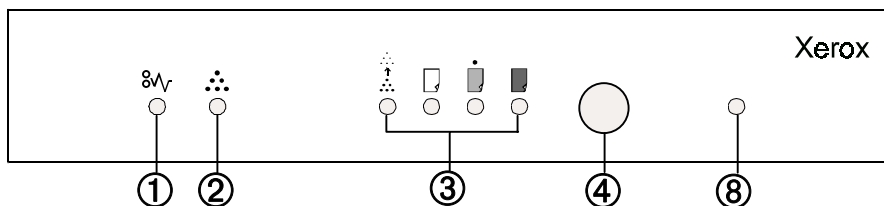

XC353/ XC355/ XC356

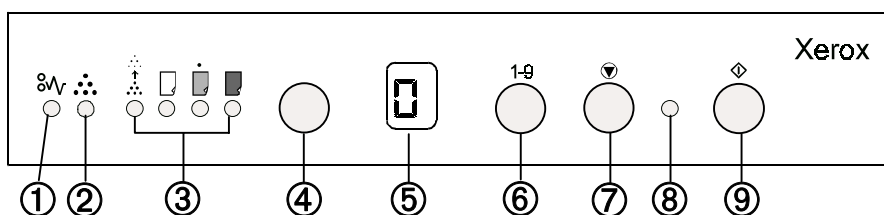

- ① **Misfeed indicator:** Lights when a misfeed occurs. Refer to the **Misfeed Removal** section.
- ② **Toner Cartridge Replacement Indicator:** Refer to **Toner Cartridge Replacement** section.
- ③ **Exposure Settings:** There are five exposure settings: Auto, Toner Save (not XC353), Light, Manual or Dark.
- ④ **Exposure Button:** Successive pushes of the button will change the selected exposure setting.
- ⑤ **Quantity Display:** Copy quantity or status codes appear in this area.
- ⑥ **Copy Quantity Button:** Select up to 9 copies, or “C” mode for up to 20 copies.
- ⑦ **Clear/Stop Button:** Press this key to stop the copier or to clear copy quantity. If the key is pressed twice, all programming will be cleared.
- ⑧ **Ready Indicator:** When the light is ON (not flashing), the copier is ready to make copies. When the light is flashing, after Start is pressed, the copier is warming up and copying will begin automatically.
- ⑨ **Start Button:** Press this key to begin copying.

Paper Specifications

Paper Storage

For reliable copier operation and copy quality, Xerox recommends that the paper be stored:

- On a flat surface
- In a closed container
- In a low humidity area
- Tightly wrapped, if the ream is partially used.

Note: Paper affected by humidity, and curled paper can cause jams and copy quality problems.

Specification Chart

Copy Paper Input	Paper Tray
Paper sizes	XC351, XC353 and XC355: A6 to A4 XC356: A6 to 216x356 mm
Paper weights	Optimum: 75 gsm Range: 60 to 90 gsm
Capacity (75 gsm)	XC351: Single sheet feed XC353: 30 sheets XC355/ XC356: Approximately 50 sheets
Letterhead Paper	Yes
Predrilled Paper	Yes
Labels *	Yes (Max 1)
Transparencies *	Yes (Max 1)

* Use labels and transparencies specifically designed for copiers.

Making Copies on the XC351

The Auto Start feature allows you to program the copier while it is warming up. You can select the exposure setting, insert a sheet of paper, and walk away from the copier. Copying will start automatically as soon as the copier is warmed up.

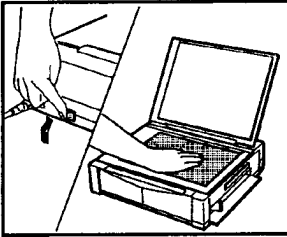

1. Turn the power on.
2. Open the document cover.
3. Place the original **face down** in the **upper right corner** of the document glass.

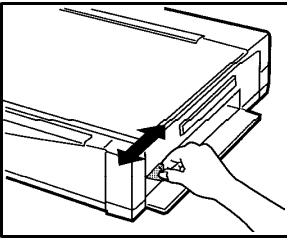

4. Set the paper guide to the width of the copy paper.

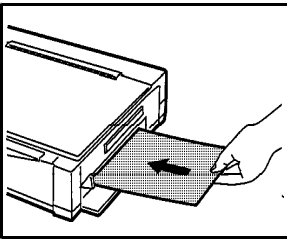

5. Insert a sheet of paper into the paper feed slot.
 - Copying will start automatically.
 - 90 seconds after the last copy is made the copier enters Auto Power Saver Mode and the Ready indicator starts flashing. Copying is possible in the Auto Power Saver Mode, but the first copy may take a few seconds longer than usual.

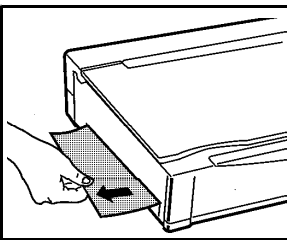

6. Remove the copies one at a time.
 - Wait for the ready indicator to light before inserting the next sheet of paper.
 - 1 minute after the last copy is made, the exposure setting will return to the auto mode.

Making Copies on the XC353, XC355 and XC356

The Auto Start feature allows you to programme any feature while the copier is warming up. You can programme all the features, press the Start button, and walk away from the copier. Copying will start automatically as soon as the copier is ready.

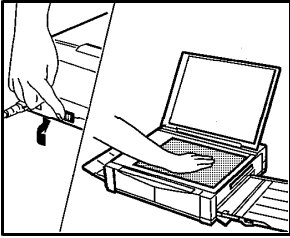

1. Turn the power on.
2. Open the document cover.
3. Place the original **face down** in the **upper right corner** of the document glass.

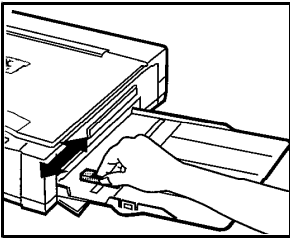

4. Set the paper guide to the width of the copy paper.

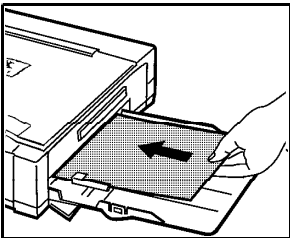

5. Place paper in the paper tray.
 - Do not fill above the MAX line.
 - Special paper and heavy paper must be fed individually.

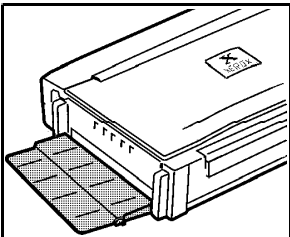

6. Ensure that the exit tray is fully opened.

Making Copies on the XC353, XC355 and XC356

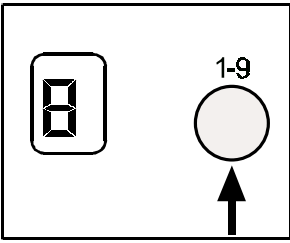

7. To make 1 to 9 copies, press the Copy Quantity button to set the number of copies.

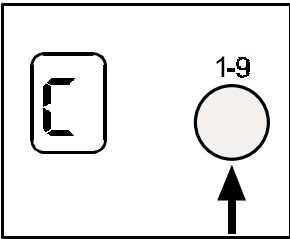

8. To make more than 9 copies, press the Copy Quantity button until C is displayed. The copier will now make up to 20 copies. If there are less than 20 sheets of paper in the paper tray, the copier will make copies until the tray is empty and the P appears in the copy quantity display.

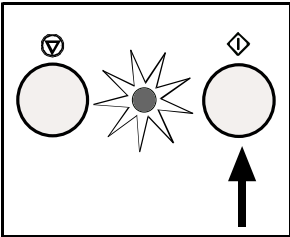

9. Press Start when the Ready indicator lights.
- When making the first copies after turning the power switch on, copying will start a few seconds after pressing Start.
 - To stop copying, press the Stop/Clear button.
 - 1 minute after the last copy is made, the exposure setting will return to the auto mode, and the copy quantity will return to 1.
 - 90 seconds after the last copy is made the copier enters Auto Power Saver Mode and the Ready indicator starts flashing. Copying is possible in the Auto Power Saver Mode, but the first copy may take a few seconds longer than usual.

Copy Quality

Copy Contrast

To compensate for light or dark originals there are five copy contrast settings to choose from (4 for XC353). Each time the Exposure button is pressed, the selection will scroll to the next selection:

1 – Auto, 2– Manual, 3 – Light, 4 – Dark, 5 – Toner Save (not XC353).

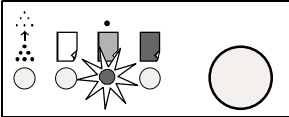

In **Auto** mode, the copier automatically selects the exposure based on the original darkness and background.

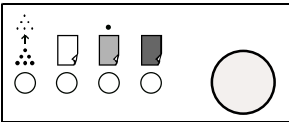

Select **Manual** mode (no indicators will light) to cancel the Auto mode. Manual is useful for copying originals with text and photos.

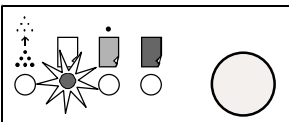

Select **Light** mode to lighten the overall copy quality.

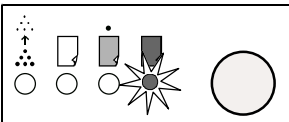

Select **Dark** mode to darken the overall copy quality.

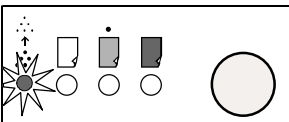

Select **Toner Save** (not XC353) mode to lower the cost of copying by decreasing overall copy density on each page.

Two-Sided Copying

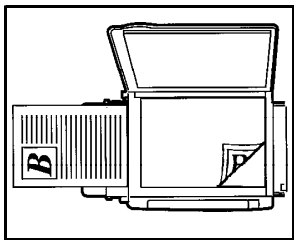

1. Place side 1 original **face down** on the document glass and make a copy.

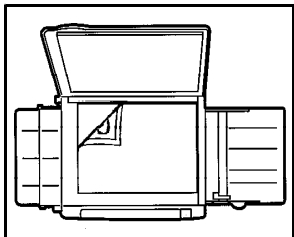

2. Place side 2 original **face down** on the document glass in the **opposite** orientation from side 1 original.

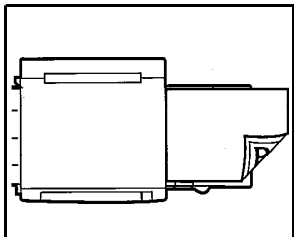

3. Place the copy of side 1 **face down** in the paper tray/ paper feed slot.
 - Remove each two-sided copy promptly.
Do not let the copies stack up.

Setting Copy Exposure Range

The exposure settings, Light, Auto and Dark can be adjusted. This can be useful when copies are consistently too dark or too light. These new settings will remain until they are manually changed again.

Note: In the following procedure, it is important to complete step 2 immediately after step 1, as the copier will return to the ready mode in approximately 10 seconds.

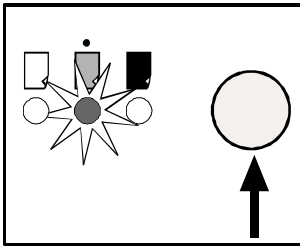

1. Press and hold the Exposure button until the indicator for the current exposure setting starts to flash (approximately 10 seconds).
2. Press and release the Exposure button until the flashing light is under the indicator for the appropriate exposure range.

Approximately 5 seconds after selecting the appropriate indicator the exposure indicator will go out, the auto and ready indicators will light, and the new copy exposure range will be set.

XC353, XC355 and XC356 Copiers only

Note: Pressing the Stop/Clear button will have no effect during this procedure.

P Paper Supply Indicator (XC353, XC355 and XC356)

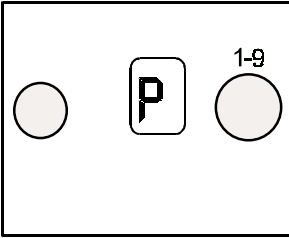

1. **P** will flash in the **Copy Quantity** display when the paper tray is empty or the paper has not fed correctly.

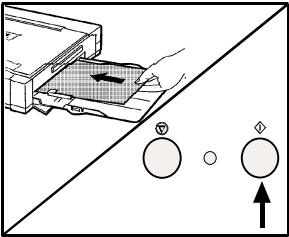

2. If there is no paper in the paper tray, add paper and press **Start** to finish copying.

Note: If you turn the power off, all settings will be cleared.

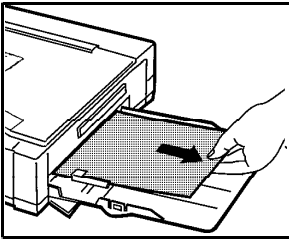

3. If the paper has not fed correctly, carefully remove it and press **Start** to finish copying.
 - If the misfed paper is difficult to remove, remove the paper tray first (XC353/ XC355/ XC356).
 - Do not reuse paper that has misfed.

⊘V Misfeed Removal

If the ⊘V **Misfeed** indicator flashes, follow the steps below to clear the misfeed.

Note: The ⊘V **Misfeed** indicator will light if the copier is not on a level surface.

Paper Feed Slot

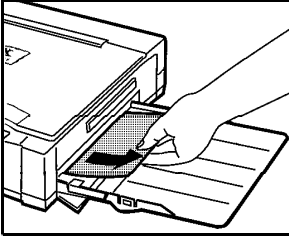

1. Carefully remove the misfed paper.
 - If the misfed paper is difficult to remove, remove the paper tray first (XC353/ XC355/ XC356).
2. Turn the power off and then on to clear the misfeed indicator.

Exit Area

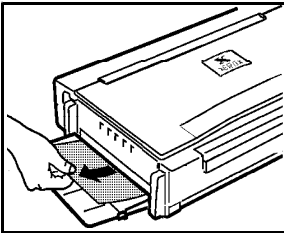

1. Carefully remove the misfed paper.
2. Turn the power off and then on to clear the Misfeed indicator.

Note: Do not use paper that has misfed.



Misfeed Removal

Internal Area

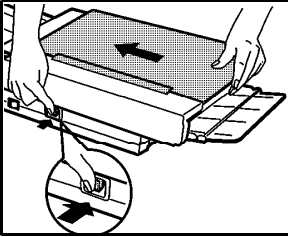

1. Turn the power off.
2. Press and hold the document glass release button on the rear of the copier and return the document glass to the centre of the copier.

XC351 skip to step 5

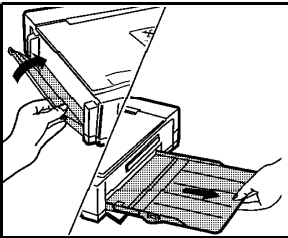

3. Fold up the exit tray.
4. Remove the paper tray.

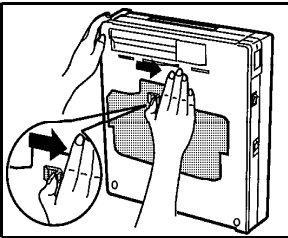

5. Lift the copier by the handle and stand it on the exit area.
 - The document cover should be closed to prevent damage.
6. Push the tab to the right to open the bottom cover.



Misfeed Removal

Internal Area

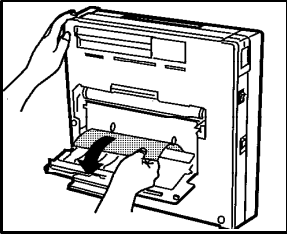

CAUTION:

Be careful not to touch any parts inside the bottom cover.

Be careful not to touch the shiny surface of the copy cartridge or expose it to the light for an extended period of time.

7. Carefully remove the misfed paper.
 - If the paper accidentally tears, be sure to remove all of the pieces.
8. Close the bottom cover securely.
9. Return the copier to the normal position.

Note: If the power is turned on whilst the copier is in the vertical position the misfeed indicator may flash.

10. Turn the power on.
11. If the misfeed indicator still flashes, repeat steps 1 to 10.

⋮ Toner Cartridge

When insufficient toner is detected at the start of copying, the toner cartridge replacement indicator will light and the copier searches for toner for up to 1 minute. During this time the document glass will slide back and forth. If the copier still detects insufficient toner, the indicator will start flashing. The copier will not operate until the toner cartridge is replaced.

During multiple sheet copying of a dark original, the toner cartridge replacement indicator may flash and the copier may stop even though toner remains in the cartridge. If this occurs, turn the power off and on again, and restart copying.

Note: A few more copies may be made by using the following procedure. Vigorously shake the cartridge horizontally several times, tap the top of the cartridge (label side), with your hand then reinsert the cartridge into the copier.

Toner Cartridge Replacement

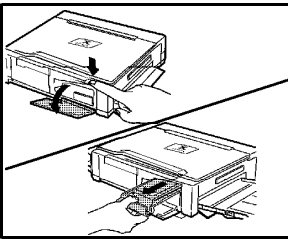

1. Turn the power off.
2. Press the front cover open button and open the front cover.
3. Press down on the catch and remove the toner cartridge.

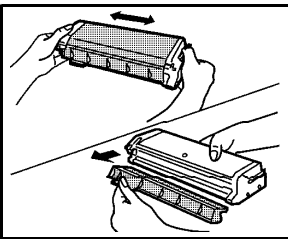

4. Vigorously shake the new toner cartridge horizontally several times and then remove the cover.
 - Return the empty cartridge to Xerox for recycling.

⋮ Toner Cartridge Replacement

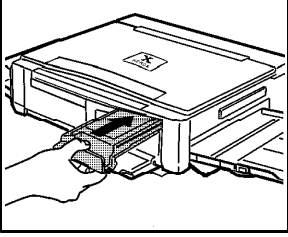

4. Slide the new toner cartridge in until it locks in place.
5. Close the front cover.
6. Turn the power on.
 - After installing a new toner cartridge and pressing the start button, the document glass will move back and forth, and the toner cartridge replacement indicator will light for up to 1 minute before copying starts.

Toner Cartridge Yield

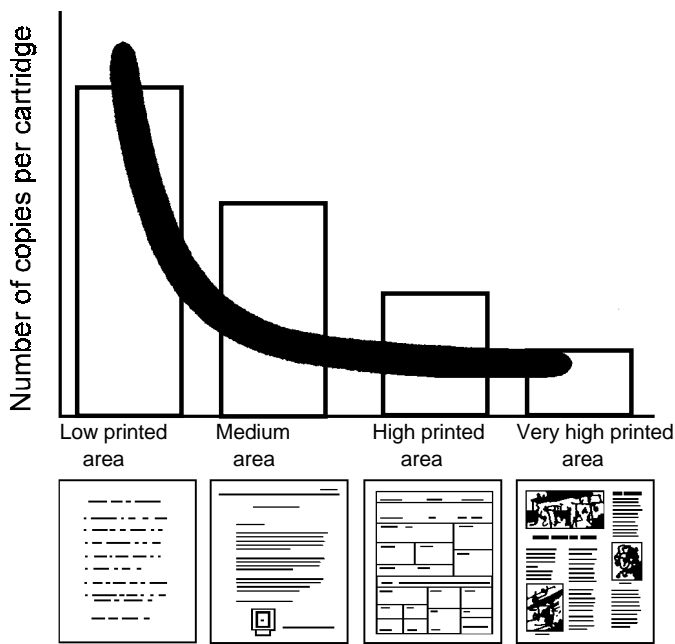

The main factor affecting toner cartridge yield is the printed area of a document. The graph is a sample representation of how the number of copies per cartridge decreases as the printed area increases.

Other factors which can affect the toner cartridge yield are:

- The size of the document being copied.
- Dark backgrounds.
- Leaving the platen cover open.
- Double sided copying.
- High humidity.

To get the most from your toner cartridge:

- Always copy with the document cover closed.
- Leave the copier on during the day. Switch off the copier at the end of the working day.
- Copy with the exposure control set to Auto exposure unless you need to adjust for the background of your original.
- Operate the copier in a dry environment whenever possible.

Drum Cartridge Replacement

The useful life of the drum cartridge is approximately 10,000 copies. At 9,700 copies, the Toner Save, Exposure settings, and Ready indicators will flash slowly when the power is turned on, indicating that the replacement cartridge will be needed soon. Copies can still be made. After a further 300 copies, the Ready Indicator will go out, the Toner Save and Contrast Indicators will flash, and the copier will stop operating until the cartridge is replaced.

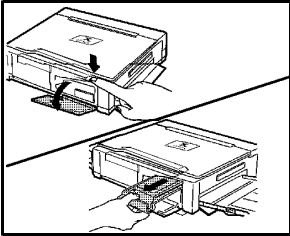

1. Turn the power off.
2. Press the front cover open button and open the front cover.
3. Press down on the catch and remove the toner cartridge.

XC351 skip to step 6

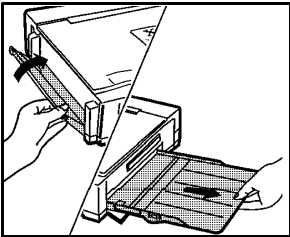

4. Fold up the exit tray.
5. Remove the paper tray.

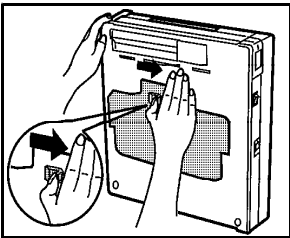

6. Lift the copier by the handle and stand it on the exit area on the bottom.
7. Push the bottom cover tab to the right to open the cover.

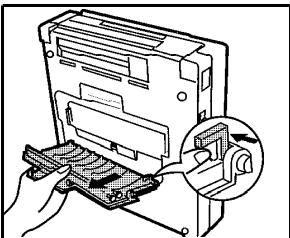

8. Push the release lever to the left and remove the bottom cover.

Drum Cartridge Replacement

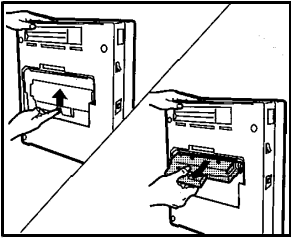

9. Push the drum cartridge release lever up to release the drum cartridge.
10. Remove the drum cartridge.

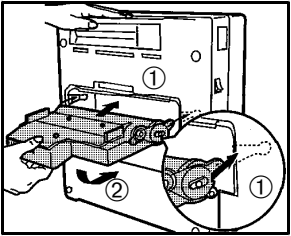

11. ① Install the top of the new drum cartridge along the grooves on both sides.
12. ② Rotate the drum cartridge in until it clicks into position.

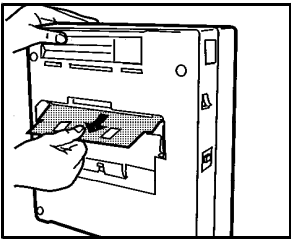

13. Remove the black cover from the drum cartridge.

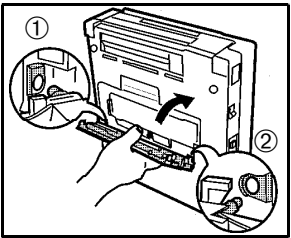

14. Reinstall the bottom cover by placing the tab at the lower left into the hole in the copier as shown ①, and by inserting the right side at a angle ②.

15. Close the bottom cover.

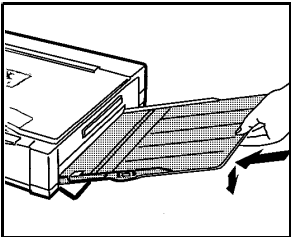

16. Return the copier to the normal position.

XC351 skip to step 19

17. Reinstall the paper tray.

Drum Cartridge Replacement

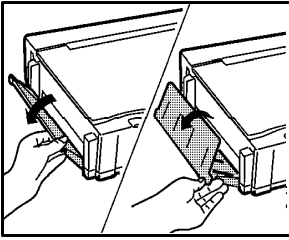

18. Unfold and open the exit tray.

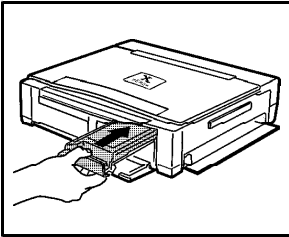

19. Push the toner cartridge in until it locks in place. Close the front cover.

Perform the following steps to reset the copier.

20. While holding the Exposure button, turn the power on.

- All indicators, except the Ready indicator, will light.

21. Release and then press and hold the exposure button until the three exposure indicators light.

Note: If the three exposure indicators do not light, turn the power off and repeat steps 20 and 21.

The centre exposure indicator will stay lit (the outside lights will go out) and the Ready indicator will light. The reset is complete.

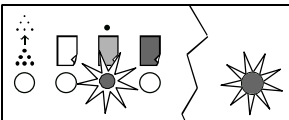
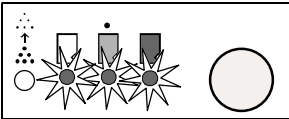

Problem Solving

Problem Solving Chart

The following chart lists some conditions that may occur and the recommended solutions. Follow the suggested solutions until the problem is corrected. Refer to the **Status Code Chart** in this section for status code information. If the problem persists, please call your local Xerox helpline or representative for assistance.

Condition	Possible Causes
Copier does not work.	Is the copier plugged in? Is the power switch on? Is the toner cartridge installed correctly?
Copier is on, but does not copy	Are any of the indicators lit? (Refer to Status Code Chart .) Is the copier out of paper?
Blank copies	Is the original face down on the document glass?
Light or dark copies	Is the exposure control adjusted correctly? (Refer to Copy Quality .)
Copies are striped or lined or poor quality.	Is the document glass or the document cover dirty? Is the lens dirty? (Refer to Copier Maintenance .)
Copy paper misfeeds frequently.	Is the paper exit blocked? Is the paper guide adjusted to the correct paper width? Does the paper level in the paper tray exceed the maximum height line? (XC353/ XC355/ XC356) Is the copy paper damp? Is special copy paper being used? Is there a small piece of paper caught in the copier?







Problem Solving

Problem Solving Chart

Condition	Possible Causes
Image rubs off the copy easily.	Is the copy paper too heavy? Is the copy paper damp? Is there a misfeed in the fusing area? (Refer to Misfeed Removal .) Have the two thumbscrews been removed from the bottom of the copier? (Refer to Installation .)
There are fewer copies from the toner cartridge than expected.	Originals contain pictures, solids, or heavy lines. Originals are forms, newsletters, books etc. The copier is being turned on and off frequently. The document cover is being left open while making copies.
Copier takes longer than usual to make the first copy and/or makes a clicking sound.	Toner supply may be low. Shake the toner cartridge.
The document cover moves back and forth but no copies are made.	The copier is searching for toner. Refer to the Toner Cartridge Replacement section.

Problem Solving

Status Code Chart

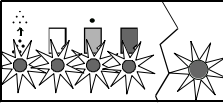
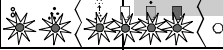
Status Code	Suggested Solution
	<p style="text-align: center;">XC353, XC355 and XC356 Only</p> <p>Ensure that there is paper in the tray.</p> <p>Paper may not have fed correctly. (Refer to  Paper Supply Indicator.)</p>
<p>L1 – L8 H2 – H4</p>	<p style="text-align: center;">XC353, XC355 and XC356 Only</p> <p>Switch the power OFF. Wait approximately 5 seconds. Then switch the power ON. If the status code continues, call for service.</p>
	<p>Copy paper has misfed. (Refer to  Misfeed Removal.)</p>
	<p>When the toner cartridge replacement indicator appears, the toner cartridge will need to be replaced soon. (Refer to  Toner Cartridge.)</p>
	<p>The Toner Save (not XC353), Copy Contrast, and Ready indicators flash to warn you that the drum cartridge will need to be replaced soon. (Refer to Drum Cartridge Replacement.)</p>
	<p style="text-align: center;">XC351 Only</p> <p>All lights, except the Ready indicator light. Switch the power OFF. Wait approximately 5 seconds. Switch the power ON. If the status code remains, call for service.</p>

Copier Maintenance

Correct care is essential in order to get good quality copies.

Document Glass and Cover

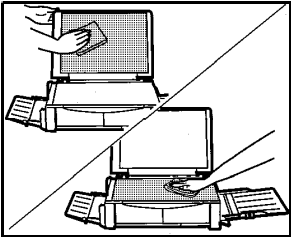

Note: Marks on the document glass or inside the document cover will appear on the copy.

1. Wipe the document glass and cover with a soft, clean cloth.

Note: If necessary, dampen the cloth with water or glass cleaner. **DO NOT** use thinner, benzene, or any other volatile cleaning agents.

Lens

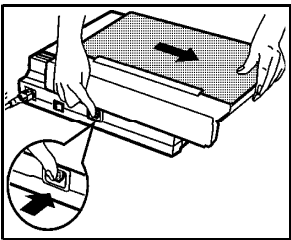

Note: If the copies have streaks or blotches, the lens may be dirty.

1. Turn the power switch off.
2. Press and hold the document glass release button and slide the document glass all the way to the left.
3. Using a standard cotton swab wipe the full length of the lens.

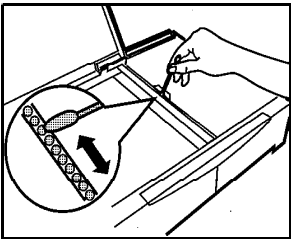

Packing the Copier

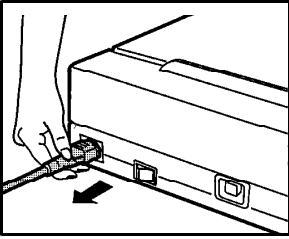

1. Turn the power off.
2. Disconnect the power cord.

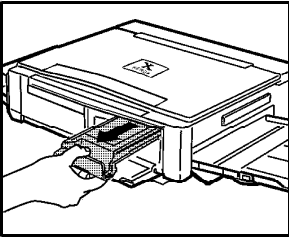

3. Open the cover and remove the toner cartridge.
 - Reinstall the cover on the toner cartridge and place it in the box.
4. Close the front cover.

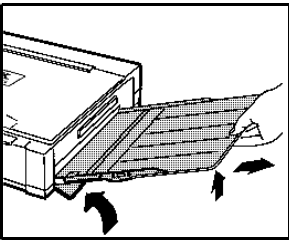

XC351 skip to step 7

5. Remove the paper tray.

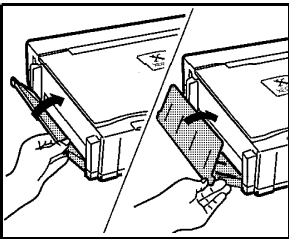

6. Fold up the exit tray.

Packing the Copier

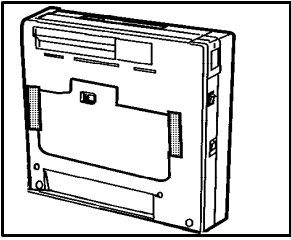

7. Use the handle to stand the copier upright.
8. Never position the copier with the handle facing the side or bottom. This will cause toner to leak. Tape the bottom cover closed.

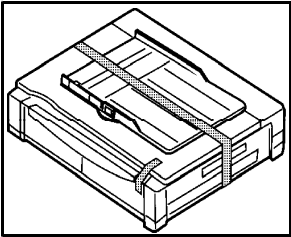

9. Lower the copier. Place the paper tray on top of the copier (XC353/ XC355/ XC356).
10. Tape the document cover, paper tray, and exit tray, closed.
 - Only the XC353, XC355 and XC356 will have a paper tray and exit tray.
11. Using the original packaging, pack the copier in the carton as shown in the **Unpacking** section.

Technical Data

Type	Portable desktop			
Copy Speed	Approximately 3 copies per minute			
First Copy Out Time	19 seconds (warm) 24 seconds (cold)			
Copy Ratio	1:1 ±1%			
Original Size	XC351/ XC353/ XC355: Maximum A4 XC356: Maximum 216 mm 356 mm			
Copy Size	XC351/ XC353/ XC355: A6 to A4 XC356: A6 to 216x356mm			
Exposure System	Slit exposure with moving Document Glass			
Paper Capacity	XC351: Single copy XC353: 30 sheets @ 90 gsm XC355/ XC356: 50 sheets @ 75 gsm			
Multicopy	XC351: Single copy XC353/ XC355/ XC356: 1 to 9 copies +C (up to 20), with auto repeat function			
Power Supply	220 - 240v			
Ozone	0.002 ppmas			
Power Consumption	0.7 KW Maximum			
Weight	XC351: 6.5 kg XC353 XC355: 7 kg XC356: 7.25 kg			
Copier dimensions	Copier	Width	Depth	Height
	XC351	362 mm	353 mm	98 mm
	XC353/ XC355	378 mm	353 mm	98 mm
	XC356	455 mm	353 mm	98 mm

Xerox Limited
Multimedia Professional Services
P.O. Box 17
Bessemer Road
Welwyn Garden City
Hertfordshire AL7 1HE
UK

602P24430

Free Manuals Download Website

<http://myh66.com>

<http://usermanuals.us>

<http://www.somanuals.com>

<http://www.4manuals.cc>

<http://www.manual-lib.com>

<http://www.404manual.com>

<http://www.luxmanual.com>

<http://aubethermostatmanual.com>

Golf course search by state

<http://golfingnear.com>

Email search by domain

<http://emailbydomain.com>

Auto manuals search

<http://auto.somanuals.com>

TV manuals search

<http://tv.somanuals.com>