



 Read this manual carefully before operating this vehicle.

OWNER'S MANUAL

PW50

PW50Y

LIT-11626-22-24

5PG-28199-18

EAU10042

 **WARNING**

The engine exhaust from this product contains chemicals known to the State of California to cause cancer, birth defects or other reproductive harm.

YAMAHA

LIT-CALIF-65-01

 **Read this manual carefully before operating this vehicle. This manual should stay with this vehicle if it is sold.**

Congratulations on your purchase of the Yamaha PW50(Y). This model is the result of Yamaha's vast experience in the production of fine sporting, touring, and pacesetter racing machines. It represents the high degree of craftsmanship and reliability that have made Yamaha a leader in these fields.

This manual will give you an understanding of the operation, inspection, and basic maintenance of this motorcycle. If you have any questions concerning the operation or maintenance of your motorcycle, please consult a Yamaha dealer.

The design and manufacture of this Yamaha motorcycle fully comply with the emissions standards for clean air applicable at the date of manufacture. Yamaha has met these standards without reducing the performance or economy of operation of the motorcycle. To maintain these high standards, it is important that you and your Yamaha dealer pay close attention to the recommended maintenance schedules and operating instructions contained within this manual.

Yamaha continually seeks advancements in product design and quality. Therefore, while this manual contains the most current product information available at the time of printing, there may be minor discrepancies between your motorcycle and this manual. If there is any question concerning this manual, please consult a Yamaha dealer.

 WARNING

Please read this manual, the “TIPS AND PRACTICE GUIDE FOR THE OFF HIGHWAY MOTORCYCLIST” and the “PARENTS, YOUNGSTERS AND OFF-HIGHWAY MOTORCYCLES” booklets carefully and completely before operating or allowing your child to operate this motorcycle. Do not attempt to operate this motorcycle until you have attained adequate knowledge of its controls and operating features and until you have been trained in safe and proper riding techniques. Regular inspections and careful maintenance, along with good riding skills, will ensure that you safely enjoy the capabilities and the reliability of this motorcycle.

 WARNING

This motorcycle is designed and manufactured for off-road use only. It is illegal to operate this motorcycle on any public street, road or highway. Such use is prohibited by law. This motorcycle complies with almost all state off-highway noise level and spark arrester laws and regulations. Please check your local riding laws and regulations before operating this motorcycle.

INTRODUCTION

AN IMPORTANT SAFETY MESSAGE:

- Read this manual, the “PARENTS, YOUNGSTERS AND OFF-HIGHWAY MOTORCYCLES” booklet, and the “TIPS AND PRACTICE GUIDE FOR THE OFF HIGHWAY MOTORCYCLIST” booklet carefully and completely before operating this motorcycle. Make sure you understand all instructions.
- Pay close attention to the warning and notice labels on the motorcycle.
- Never operate a motorcycle without proper training or instruction.
- Weight of the rider should not exceed 25 kg (55 lb).

AN IMPORTANT NOTE TO PARENTS:

This motorcycle is not a toy. Before you let your child ride this motorcycle, you should understand the instructions and warnings in this Owner’s Manual. Then be sure your child understands and will follow them. Also read the “PARENTS, YOUNGSTERS AND OFF-HIGHWAY MOTORCYCLES” and the “TIPS AND PRACTICE GUIDE FOR THE OFF HIGHWAY MOTORCYCLIST” booklets supplied with this motorcycle when new or available from your Yamaha dealer. Children differ in skills, physical abilities, and judgment. Some children may not be able to operate a motorcycle safely. Parents should supervise their child’s use of the motorcycle at all times. Parents should permit continued use only if they determine that the child has the ability to operate the motorcycle safely.

Your motorcycle was delivered with an adjustable speed limiter and power reduction plate. Yamaha recommends that all beginners start off with the speed limiter adjusting screw turned in and the power reduction plate installed in the exhaust manifold to limit the power available while they learn. The limiter screw may be gradually turned out to increase maximum speed as the beginner becomes more familiar with operating the motorcycle. Parents should decide when to adjust the motorcycle for more power as their youngster’s riding skills improve. Once the rider can operate with skill at the top speed permitted by adjusting the speed limiter alone, the power reduction plate can be removed. Since removal of this plate will result in a significant increase in power, turn the speed limiter back in again; adjust it out in stages as you did before.

Motorcycles are single track vehicles. Their safe use and operation are dependent upon the use of proper riding techniques as well as the expertise of the operator. Every operator should know the following requirements before riding this motorcycle.

He or she should:

- Obtain thorough instructions from a competent source on all aspects of motorcycle operation.
- Observe the warnings and maintenance requirements in this Owner’s Manual.



INTRODUCTION

- Obtain qualified training in safe and proper riding techniques.
- Obtain professional technical service as indicated in this Owner's Manual and/or when made necessary by mechanical conditions.

IMPORTANT MANUAL INFORMATION

EAU10132

Particularly important information is distinguished in this manual by the following notations:

	This is the safety alert symbol. It is used to alert you to potential personal injury hazards. Obey all safety messages that follow this symbol to avoid possible injury or death.
 WARNING	A WARNING indicates a hazardous situation which, if not avoided, could result in death or serious injury.
NOTICE	A NOTICE indicates special precautions that must be taken to avoid damage to the vehicle or other property.
TIP	A TIP provides key information to make procedures easier or clearer.

IMPORTANT MANUAL INFORMATION

EAU10193

**PW50(Y)
OWNER'S MANUAL
©2008 by Yamaha Motor Corporation, U.S.A.
1st edition, March 2008
All rights reserved.
Any reprinting or unauthorized use
without the written permission of
Yamaha Motor Corporation, U.S.A.
is expressly prohibited.
Printed in Japan.
P/N LIT-11626-22-24**

TABLE OF CONTENTS

LOCATION OF IMPORTANT

LABELS 1-1

SAFETY INFORMATION 2-1

DESCRIPTION 3-1

Left view 3-1

Right view 3-2

Controls and instruments 3-3

INSTRUMENT AND CONTROL

FUNCTIONS 4-1

Handlebar switch 4-1

Speed limiter and power reduction
plate 4-1

Front brake lever 4-2

Rear brake lever 4-3

Fuel tank cap 4-3

Fuel 4-3

Fuel tank breather hose 4-5

2-stroke engine oil 4-5

Fuel cock 4-5

Starter (choke) lever "1 2" 4-6

Kickstarter 4-6

Seat 4-7

FOR YOUR SAFETY –

PRE-OPERATION CHECKS 5-1

Pre-operation check list 5-2

OPERATION AND IMPORTANT

RIDING POINTS 6-1

Starting and warming up a cold
engine 6-1

Starting a warm engine 6-1

Starting off 6-2

Acceleration and deceleration 6-2

Braking 6-2

Engine break-in 6-3

Parking 6-4

PERIODIC MAINTENANCE AND

ADJUSTMENT 7-1

Owner's tool kit 7-2

Periodic maintenance chart for the
emission control system 7-3

General maintenance and lubrication
chart 7-4

Checking the spark plug 7-6

Removing the power reduction
plate 7-7

Transmission oil 7-8

Middle and final gear cases 7-9

Cleaning the air filter element 7-9

Cleaning the spark arrester 7-10

Adjusting the carburetor 7-11

Adjusting the engine idling
speed 7-11

Checking the throttle cable free
play 7-12

Tires 7-12

Panel wheels 7-14

Adjusting the front and rear brake
lever free play 7-15

Checking the front and rear brake
shoes 7-16

Checking and lubricating the
cables 7-16

Checking and lubricating the throttle
grip and cable 7-17

Adjusting the Autolube pump 7-17

Lubricating the front and rear brake
levers 7-17

Checking and lubricating the
centerstand 7-18

Checking the front fork 7-18

Checking the steering 7-19

Checking the wheel bearings 7-19

Front wheel 7-19

Rear wheel 7-21

Troubleshooting 7-24

Troubleshooting chart 7-25

MOTORCYCLE CARE AND

STORAGE 8-1

Matte color caution 8-1

Care 8-1

Storage 8-3

SPECIFICATIONS 9-1

TABLE OF CONTENTS

CONSUMER INFORMATION	10-1
Identification numbers	10-1
Motorcycle noise regulation	10-2
YAMAHA MOTOR CORPORATION, U.S.A. OFF-ROAD MOTORCYCLE LIMITED WARRANTY	10-3
YAMAHA EXTENDED SERVICE (Y.E.S.)	10-5

LOCATION OF IMPORTANT LABELS

EAU41371

Read and understand all of the labels on your vehicle. They contain important information for safe and proper operation of your vehicle. Never remove any labels from your vehicle. If a label becomes difficult to read or comes off, a replacement label is available from your Yamaha dealer.

1

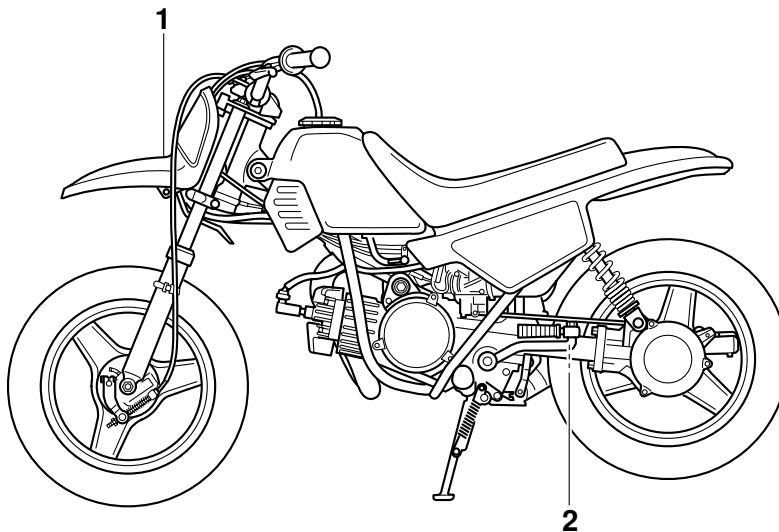

1

⚠ WARNING

- **BEFORE YOU OPERATE THIS VEHICLE, READ THE OWNER'S MANUAL AND ALL LABELS.**
- **NEVER CARRY A PASSENGER.** You increase your risk of losing control if you carry a passenger.
- **NEVER OPERATE THIS VEHICLE ON PUBLIC ROADS.** You can collide with another vehicle if you operate this vehicle on a public road.
- **ALWAYS WEAR AN APPROVED MOTORCYCLE HELMET,** eye protection, and protective clothing.

3PT-2118K-AD

2

TIRE INFORMATION

Cold tire normal pressure should be set as follows.

FRONT : 100 kPa,{1.00 kgf/cm²}, 15 psi
REAR : 100 kPa,{1.00 kgf/cm²}, 15 psi

3RV-2166B-AD

1

SAFETY INFORMATION

EAU40933

Be a Responsible Owner

As the vehicle's owner, you are responsible for the safe and proper operation of your motorcycle.

Motorcycles are single-track vehicles. Their safe use and operation are dependent upon the use of proper riding techniques as well as the expertise of the operator. Every operator should know the following requirements before riding this motorcycle.

He or she should:

- Obtain thorough instructions from a competent source on all aspects of motorcycle operation.
- Observe the warnings and maintenance requirements in this Owner's Manual.
- Obtain qualified training in safe and proper riding techniques.
- Obtain professional technical service as indicated in this Owner's Manual and/or when made necessary by mechanical conditions.

Safe Riding

Perform the pre-operation checks each

time you use the vehicle to make sure it is in safe operating condition. Failure to inspect or maintain the vehicle properly increases the possibility of an accident or equipment damage. See page 5-1 for a list of pre-operation checks.

- This motorcycle is designed for off-road use only, therefore, it is illegal to operate it on public streets, roads, or highways, even a dirt or gravel one. Off-road use on public lands may be illegal. Please check local regulations before riding.
- This motorcycle is designed to carry the operator only. No passengers.
- The failure of motorists to detect and recognize motorcycles in traffic is the predominating cause of automobile/motorcycle accidents. Many accidents have been caused by an automobile driver who did not see the motorcycle. Making yourself conspicuous appears to be very effective in reducing the chance of this type of accident.

Therefore:

- Wear a brightly colored jacket.

- Use extra caution when you are approaching and passing through intersections, since intersections are the most likely places for motorcycle accidents to occur.
- Ride where other motorists can see you. Avoid riding in another motorist's blind spot.
- Many accidents involve inexperienced operators.
- Make sure that you are qualified and that you only lend your motorcycle to other qualified operators.
- Know your skills and limits. Staying within your limits may help you to avoid an accident.
- We recommend that you practice riding your motorcycle until you have become thoroughly familiar with the motorcycle and all of its controls.
- Many accidents have been caused by error of the motorcycle operator. A typical error made by the operator is veering wide on a turn due to excessive speed or under-

cornering (insufficient lean angle for the speed). Never travel faster than warranted by conditions.

- Ride cautiously in unfamiliar areas. You may encounter hidden obstacles that could cause an accident.
- The posture of the operator is important for proper control. The operator should keep both hands on the handlebar and both feet on the operator footrests during operation to maintain control of the motorcycle.
- Never ride under the influence of alcohol or other drugs.

Protective apparel

The majority of fatalities from motorcycle accidents are the result of head injuries. The use of a safety helmet is the single most critical factor in the prevention or reduction of head injuries.

- Always wear an approved helmet.
- Wear a face shield or goggles. Wind in your unprotected eyes could contribute to an impairment of vision that could delay seeing a

hazard.

- The use of a jacket, heavy boots, trousers, gloves, etc., is effective in preventing or reducing abrasions or lacerations.
- Never wear loose-fitting clothes, otherwise they could catch on the control levers, footrests, or wheels and cause injury or an accident.
- Always wear protective clothing that covers your legs, ankles, and feet. The engine or exhaust system become very hot during or after operation and can cause burns.

Avoid Carbon Monoxide Poisoning

All engine exhaust contains carbon monoxide, a deadly gas. Breathing carbon monoxide can cause headaches, dizziness, drowsiness, nausea, confusion, and eventually death.

Carbon Monoxide is a colorless, odorless, tasteless gas which may be present even if you do not see or smell any engine exhaust. Deadly levels of carbon monoxide can collect rapidly and you can quickly be overcome and unable to save yourself. Also, deadly

levels of carbon monoxide can linger for hours or days in enclosed or poorly ventilated areas. If you experience any symptoms of carbon monoxide poisoning, leave the area immediately, get fresh air, and **SEEK MEDICAL TREATMENT**.

- Do not run engine indoors. Even if you try to ventilate engine exhaust with fans or open windows and doors, carbon monoxide can rapidly reach dangerous levels.
- Do not run engine in poorly ventilated or partially enclosed areas such as barns, garages, or carports.
- Do not run engine outdoors where engine exhaust can be drawn into a building through openings such as windows and doors.

Loading

Adding accessories to your motorcycle can adversely affect stability and handling if the weight distribution of the motorcycle is changed. To avoid the possibility of an accident, use extreme caution when adding accessories to

SAFETY INFORMATION

your motorcycle. Use extra care when riding a motorcycle that has added accessories. Here are some general guidelines to follow if adding accessories to your motorcycle:

2

Operation of an overloaded vehicle could cause an accident.

- The weight of the operator must not exceed 25 kg (55 lb).
- Accessory weight should be kept as low and close to the motorcycle as possible. Securely pack your heaviest items as close to the center of the vehicle as possible and make sure to distribute the weight as evenly as possible on both sides of the motorcycle to minimize imbalance or instability.
- Shifting weights can create a sudden imbalance. Make sure that accessories are securely attached to the motorcycle before riding. Check accessory mounts frequently.
- Properly adjust the suspension for your load, and check the condition and pressure of your tires.

- Never attach any large or heavy items to the handlebar, front fork, or front fender.

Genuine Yamaha Accessories

Choosing accessories for your vehicle is an important decision. Genuine Yamaha accessories, which are available only from a Yamaha dealer, have been designed, tested, and approved by Yamaha for use on your vehicle.

Many companies with no connection to Yamaha manufacture parts and accessories or offer other modifications for Yamaha vehicles. Yamaha is not in a position to test the products that these aftermarket companies produce. Therefore, Yamaha can neither endorse nor recommend the use of accessories not sold by Yamaha or modifications not specifically recommended by Yamaha, even if sold and installed by a Yamaha dealer.

Aftermarket Parts, Accessories, and Modifications

While you may find aftermarket products similar in design and quality to

genuine Yamaha accessories, recognize that some aftermarket accessories or modifications are not suitable because of potential safety hazards to you or others. Installing aftermarket products or having other modifications performed to your vehicle that change any of the vehicle's design or operation characteristics can put you and others at greater risk of serious injury or death. You are responsible for injuries related to changes in the vehicle.

Keep the following guidelines in mind, as well as those provided under "Loading" when mounting accessories.

- Never install accessories that would impair the performance of your motorcycle. Carefully inspect the accessory before using it to make sure that it does not in any way reduce ground clearance or cornering clearance, limit suspension travel, steering travel or control operation.
- Accessories fitted to the handlebar or the front fork area can create instability due to improper weight distribution. If accesso-

ries are added to the handlebar or front fork area, they must be as lightweight as possible and should be kept to a minimum.

- Bulky or large accessories may seriously affect the stability of the motorcycle. Wind may attempt to lift the motorcycle, or the motorcycle may become unstable in cross winds.
- Certain accessories can displace the operator from his or her normal riding position. This improper position limits the freedom of movement of the operator and may limit control ability, therefore, such accessories are not recommended.
- Use caution when adding electrical accessories. If electrical accessories exceed the capacity of the motorcycle's electrical system, an electric failure could result, which could cause a dangerous loss of lights or engine power.

motorcycle were designed to match the performance capabilities and to provide the best combination of handling, braking, and comfort. Other tires, rims, sizes, and combinations may not be appropriate. Refer to page 7-12 for tire specifications and more information on replacing your tires.

Aftermarket Tires and Rims

The tires and rims that came with your

DESCRIPTION

EAU10410

Left view

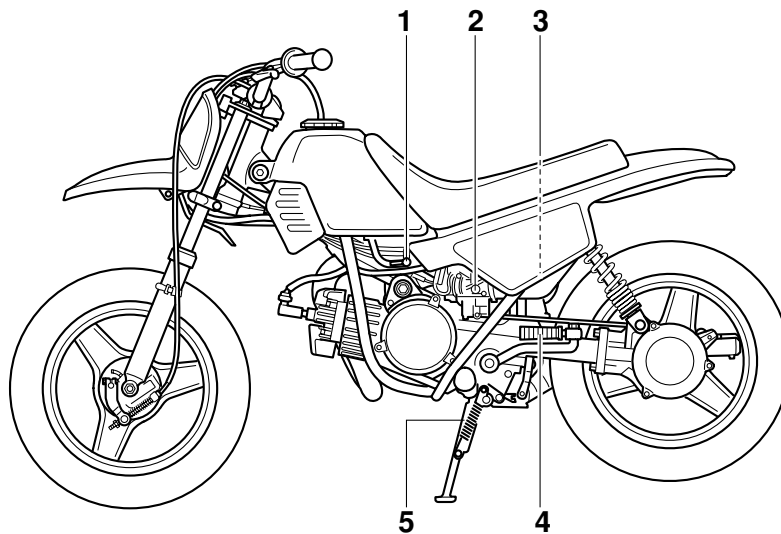

- 1. Fuel cock (page 4-5)
- 2. Throttle stop screw (page 7-11)
- 3. Air filter element (page 7-9)
- 4. Kickstarter (page 4-6)
- 5. Centerstand (page 7-18)

Right view

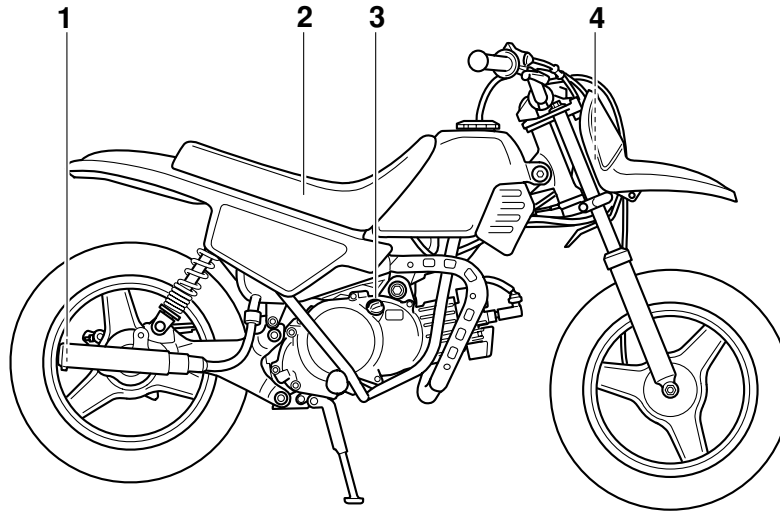

1. Spark arrester (page 7-10)
2. Seat (page 4-7)
3. Transmission oil filler cap (page 7-8)
4. 2-stroke engine oil tank (page 4-5)

DESCRIPTION

EAU10430

Controls and instruments

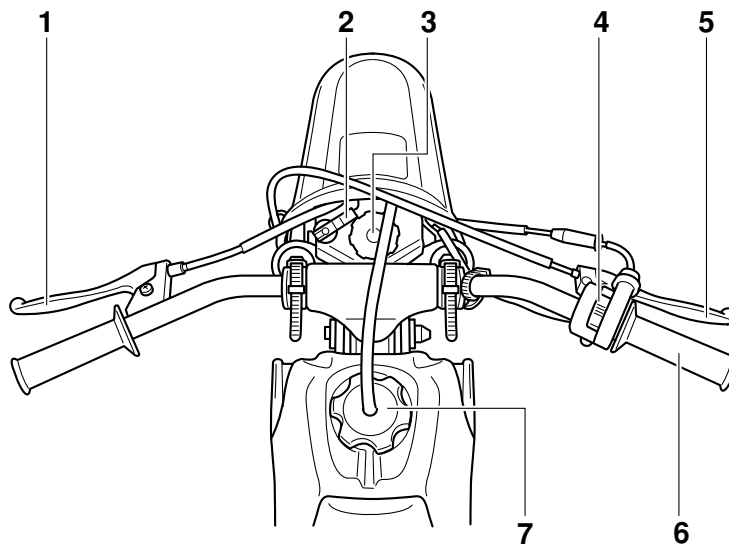

- 1. Rear brake lever (page 4-3)
- 2. Starter (choke) lever (page 4-6)
- 3. 2-stroke engine oil tank cap (page 4-5)
- 4. Right handlebar switch (page 4-1)
- 5. Front brake lever (page 4-2)
- 6. Throttle grip (page 7-12)
- 7. Fuel tank cap (page 4-3)

EAU40660

Handlebar switch

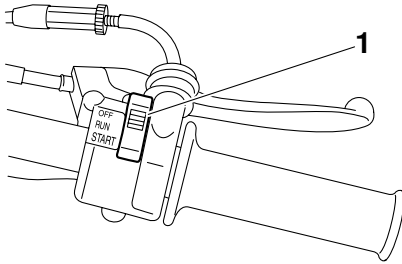

1. Engine stop switch “OFF/RUN/START”

EAU40674

Engine stop switch “OFF/RUN/START”

Set this switch to “START” before starting the engine. Set this switch to “RUN” after warming up the engine or before starting off. Set this switch to “OFF” to stop the engine.

TIP

- The engine cannot be started with this switch set to the “RUN” position.
- The engine speed is limited while this switch is set to the “START” position, therefore the motorcycle

cannot be ridden in that switch position.

EAU41041

Speed limiter and power reduction plate

Your motorcycle was delivered with an adjustable speed limiter and a power reduction plate. The speed limiter keeps the throttle from fully opening, even when the throttle grip is turned to the maximum. The power reduction plate is installed in the exhaust manifold to limit the amount of power available while they learn.

Speed limiter

1. Loosen the locknut.
2. To increase the maximum engine power available and the maximum speed of the motorcycle, turn the adjusting screw in direction (a). To decrease the maximum engine power available and the maximum speed of the motorcycle, turn the adjusting screw in direction (b).

INSTRUMENT AND CONTROL FUNCTIONS

EAU12900

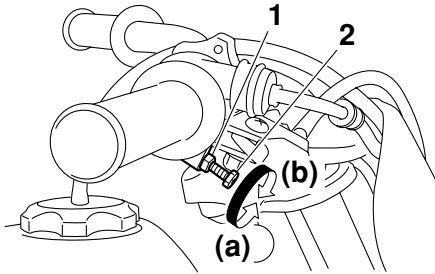

1. Locknut
2. Adjusting screw
3. Tighten the locknut.

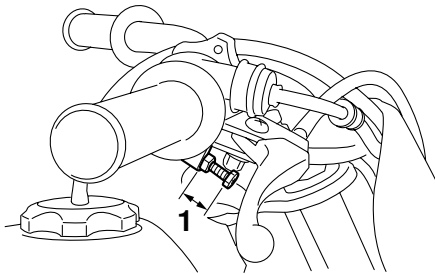

1. No more than 7 mm (0.28 in)

TIP

The adjusting range of the speed limiter screw is from the fully turned-in position to 7 mm (0.28 in) turned out. When the

screw is turned out to 7 mm (0.28 in), the throttle grip can only be opened approximately halfway. If more power is required, please consult a Yamaha dealer.

EWA14630

⚠ WARNING

Improper adjustment of the speed limiter could cause improper throttle operation. You could lose control, have an accident or be injured. Do not turn the adjusting screw out more than 7 mm (0.28 in) before consulting a Yamaha dealer. Always make sure the throttle cable free play is adjusted to 1.5–3.5 mm (0.06–0.14 in). (See page 7-12.)

Power reduction plate

Once the rider can operate with skill at the top speed permitted by adjusting the speed limiter alone, the power reduction plate can be removed. (See page 7-7.)

Front brake lever

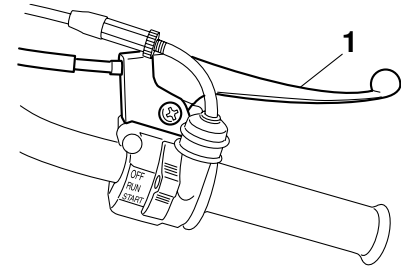

1. Front brake lever

The front brake lever is located on the right handlebar grip. To apply the front brake, pull this lever toward the handlebar grip.

INSTRUMENT AND CONTROL FUNCTIONS

Rear brake lever

EAU12950

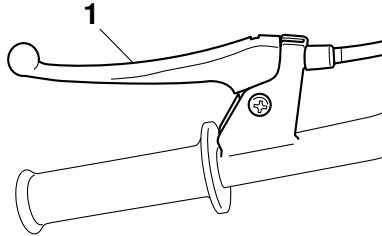

1. Rear brake lever

The rear brake lever is located on the left handlebar grip. To apply the rear brake, pull this lever toward the handlebar grip.

Fuel tank cap

EAU13182

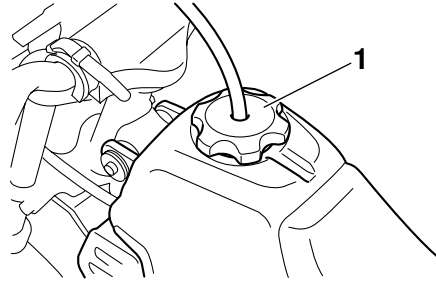

1. Fuel tank cap

To remove the fuel tank cap, turn it counterclockwise, and then pull it off. To install the fuel tank cap, insert it into the tank opening, and then turn it clockwise.

⚠ WARNING

Make sure that the fuel tank cap is properly closed after filling fuel. Leaking fuel is a fire hazard.

EWA11091

Fuel

EAU13221

Make sure there is sufficient gasoline in the tank.

EWA10881

⚠ WARNING

Gasoline and gasoline vapors are extremely flammable. To avoid fires and explosions and to reduce the risk of injury when refueling, follow these instructions.

1. Before refueling, turn off the engine and be sure that no one is sitting on the vehicle. Never refuel while smoking, or while in the vicinity of sparks, open flames, or other sources of ignition such as the pilot lights of water heaters and clothes dryers.
2. Do not overfill the fuel tank. When refueling, be sure to insert the pump nozzle into the fuel tank filler hole. Stop filling when the fuel reaches the bottom of the filler tube. Because fuel expands when it heats up, heat from the engine or the sun can cause fuel to spill out of the fuel tank.

INSTRUMENT AND CONTROL FUNCTIONS

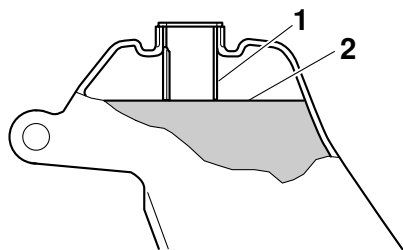

1. Fuel tank filler tube
2. Fuel level

4

3. Wipe up any spilled fuel immediately. **NOTICE: Immediately wipe off spilled fuel with a clean, dry, soft cloth, since fuel may deteriorate painted surfaces or plastic parts.**^[ECA10071]
4. Be sure to securely close the fuel tank cap.

EWA15151

WARNING

Gasoline is poisonous and can cause injury or death. Handle gasoline with care. Never siphon gasoline by mouth. If you should swallow some gasoline or inhale a lot of gasoline vapor, or get some gasoline in

your eyes, see your doctor immediately. If gasoline spills on your skin, wash with soap and water. If gasoline spills on your clothing, change your clothes.

EAU40681

Recommended fuel:
UNLEADED GASOLINE ONLY
Fuel tank capacity:
2.0 L (0.53 US gal, 0.44 Imp.gal)

Your Yamaha engine has been designed to use regular unleaded gasoline with a pump octane number $[(R+M)/2]$ of 86 or higher, or a research octane number of 91 or higher. If knocking (or pinging) occurs, use a gasoline of a different brand or premium unleaded fuel. Use of unleaded fuel will extend spark plug life and reduce maintenance costs.

Gasohol

There are two types of gasohol: gasohol containing ethanol and that containing methanol. Gasohol containing ethanol can be used if the ethanol con-

tent does not exceed 10% (E10). Gasohol containing methanol is not recommended by Yamaha because it can cause damage to the fuel system or vehicle performance problems.

EAU13412

Fuel tank breather hose

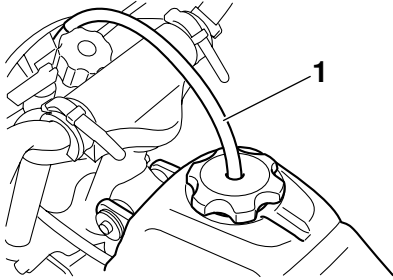

1. Fuel tank breather hose

Before operating the motorcycle:

- Check the fuel tank breather hose connection.
- Check the fuel tank breather hose for cracks or damage, and replace it if damaged.
- Make sure that the fuel tank breather hose is not blocked, and clean it if necessary.

EAU13452

2-stroke engine oil

Make sure that there is sufficient 2-stroke engine oil in the oil tank. Add the recommended 2-stroke engine oil as necessary.

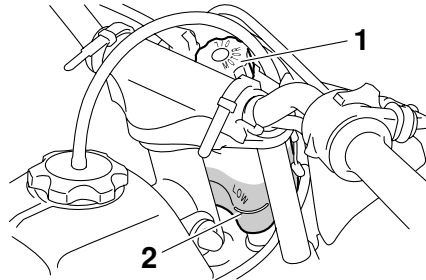

1. 2-stroke engine oil tank cap
2. Minimum level mark

Recommended oil:

See page 9-1.

Oil quantity:

0.30 L (0.32 US qt, 0.26 Imp.qt)

TIP

Make sure that the 2-stroke engine oil tank cap is properly installed.

EAU40701

Fuel cock

The fuel cock supplies fuel from the tank to the carburetor while filtering it also.

The fuel cock has two positions:

S (stop)

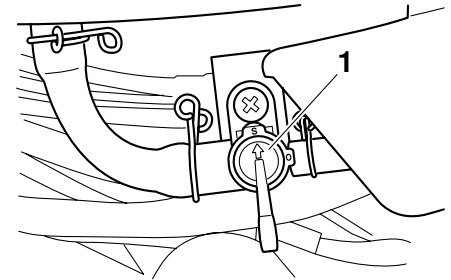

1. Arrow mark pointing to "S" (stop)

With the lever in this position, fuel will not flow. Always return the lever to this position when the engine is not running.

INSTRUMENT AND CONTROL FUNCTIONS

O (on)

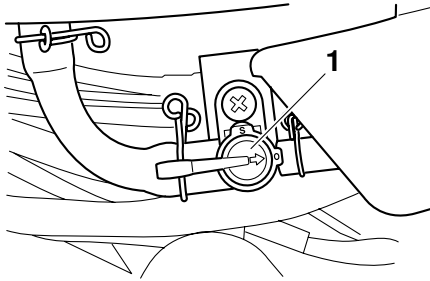



1. Arrow mark pointing to "O" (on)

With the lever in this position, fuel flows to the carburetor. Normal riding is done with the lever in this position.

Starter (choke) lever “”

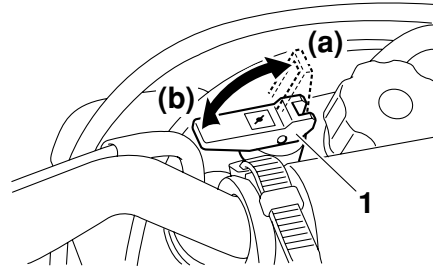
EAU13590



1. Starter (choke) lever “”

Starting a cold engine requires a richer air-fuel mixture, which is supplied by the starter (choke). Move the lever in direction (a) to turn on the starter (choke). Move the lever in direction (b) to turn off the starter (choke).

Kickstarter

EAU13680

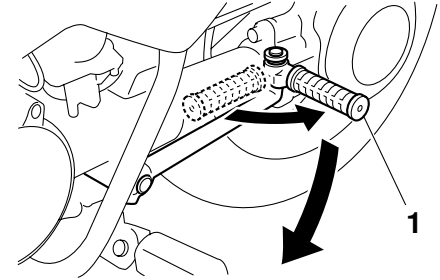

1. Kickstarter

To start the engine, fold out the kickstarter lever, move it down lightly with your foot until the gears engage, and then push it down smoothly but forcefully.

EAU40920

Seat

To remove the seat

1. Remove the mudguard by removing the bolts and washers.

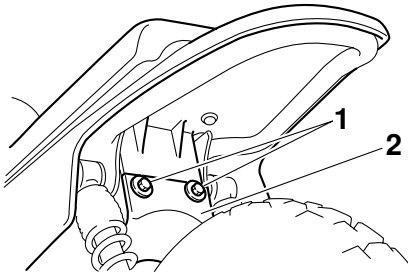

1. Bolt
2. Mudguard

2. Pull the seat off.

To install the seat

1. Insert the projection on the front of the seat into the seat holder as shown.

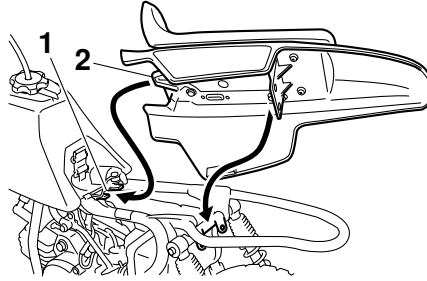

1. Seat holder
2. Projection

2. Place the seat in the original position.
3. Install the mudguard by installing the washers and bolts.

TIP

Make sure that the seat is properly secured before riding.

FOR YOUR SAFETY – PRE-OPERATION CHECKS

EAU15595

Inspect your vehicle each time you use it to make sure the vehicle is in safe operating condition. Always follow the inspection and maintenance procedures and schedules described in the Owner's Manual.

EWA11151

WARNING

Failure to inspect or maintain the vehicle properly increases the possibility of an accident or equipment damage. Do not operate the vehicle if you find any problem. If a problem cannot be corrected by the procedures provided in this manual, have the vehicle inspected by a Yamaha dealer.

Before using this vehicle, check the following points:

FOR YOUR SAFETY – PRE-OPERATION CHECKS

EAU15605

Pre-operation check list

ITEM	CHECKS	PAGE
Fuel	<ul style="list-style-type: none">• Check fuel level in fuel tank.• Refuel if necessary.• Check fuel line for leakage.	4-3
2-stroke engine oil	<ul style="list-style-type: none">• Check oil level in oil tank.• If necessary, add recommended oil to specified level.• Check vehicle for oil leakage.	4-5
Transmission oil	<ul style="list-style-type: none">• Check oil level in transmission case.• If necessary, add recommended oil to specified level.	7-8
Middle and final gear cases	<ul style="list-style-type: none">• Check vehicle for grease leakage.	7-9
Front brake	<ul style="list-style-type: none">• Check operation.• Lubricate cable if necessary.• Check lever free play.• Adjust if necessary.	7-15, 7-16
Rear brake	<ul style="list-style-type: none">• Check operation.• Lubricate cable if necessary.• Check lever free play.• Adjust if necessary.	7-15, 7-16
Throttle grip	<ul style="list-style-type: none">• Make sure that operation is smooth.• Check cable free play.• If necessary, have Yamaha dealer adjust cable free play and lubricate cable and grip housing.	7-12, 7-17
Control cables	<ul style="list-style-type: none">• Make sure that operation is smooth.• Lubricate if necessary.	7-16
Wheels and tires	<ul style="list-style-type: none">• Check for damage.• Check tire condition and tread depth.• Check air pressure.• Correct if necessary.	7-12, 7-14
Brake levers	<ul style="list-style-type: none">• Make sure that operation is smooth.• Lubricate lever pivoting points if necessary.	7-17

FOR YOUR SAFETY – PRE-OPERATION CHECKS

ITEM	CHECKS	PAGE
Centerstand	<ul style="list-style-type: none">• Make sure that operation is smooth.• Lubricate pivot if necessary.	7-18
Chassis fasteners	<ul style="list-style-type: none">• Make sure that all nuts, bolts and screws are properly tightened.• Tighten if necessary.	—
Engine stop switch	<ul style="list-style-type: none">• Check operation.	4-1

EAU40771

EAU40886

EAU16660

EWA14531

WARNING

- This model is designed for off-road use only. Become thoroughly familiar with all operating controls and their functions before riding. Consult a Yamaha dealer regarding any control or function that you do not thoroughly understand.
- Never start the engine or operate it in a closed area for any length of time. Exhaust fumes are poisonous, and inhaling them can cause loss of consciousness and death within a short time. Always make sure that there is adequate ventilation.

Starting and warming up a cold engine

1. Turn the fuel cock lever to “O” (on).
2. Set the engine stop switch to “START”.
3. Turn the starter (choke) on and completely close the throttle. (See page 4-6.)
4. While applying the front or rear brake, start the engine by pushing the kickstarter lever down.
5. After starting the engine, move the starter (choke) back halfway.
NOTICE: For maximum engine life, always warm the engine up before starting off. Never accelerate hard when the engine is cold!^[ECA11131]
6. When the engine is warm, turn the starter (choke) off and set the engine stop switch to “RUN”.

TIP

The engine is warm when it responds normally to the throttle with the starter (choke) turned off.

Starting a warm engine

Follow the same procedure as for starting a cold engine with the exception that the starter (choke) is not required when the engine is warm. Instead, start the engine with the throttle slightly open.

TIP

If the engine does not start after several kicks, try again with the throttle 1/4 to 1/2 open.

OPERATION AND IMPORTANT RIDING POINTS

Starting off

EAU41001

TIP

Before starting off, allow the engine to warm up.

1. While applying the rear brake lever, push the motorcycle off the centerstand.
2. Completely close the throttle.
3. Set the engine stop switch to "RUN".
4. Check for oncoming off-road vehicles, and then slowly turn the throttle grip in order to take off.

Acceleration and deceleration

EAU16780

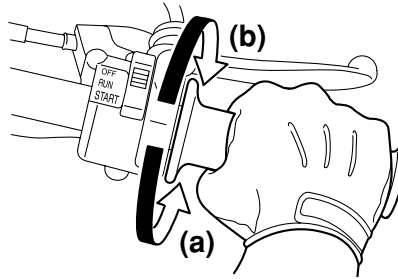

The speed can be adjusted by opening and closing the throttle. To increase the speed, turn the throttle grip in direction (a). To reduce the speed, turn the throttle grip in direction (b).

Braking

EAU41012

EWA14571

! WARNING

- Avoid braking hard or suddenly (especially when leaning over to one side), otherwise the motorcycle may skid or overturn.
- Keep in mind that braking on wet surfaces is much more difficult.
- Ride slowly down a hill, as braking downhill can be very difficult.

1. Close the throttle completely.
2. Apply both front and rear brakes simultaneously while gradually increasing the pressure.

OPERATION AND IMPORTANT RIDING POINTS

Front

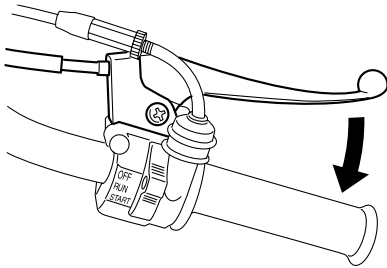

Rear

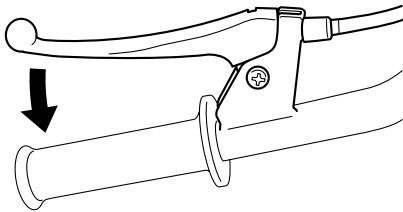

EAU42030

Engine break-in

There is never a more important period in the life of your engine than the first 5 hours of riding. It is also important to acustom the rider to the motorcycle during this time. Please read the following information carefully.

Since the engine is brand new, do not put an excessive load on it for the first 5 hours of operation. The various parts in the engine wear and polish themselves to the correct operating clearances. During this period, prolonged full-throttle operation or any condition that might result in engine overheating must be avoided. However, momentary full-throttle operation under load (i.e., two to three seconds maximum) does not harm the engine. Each full-throttle acceleration should be followed with a substantial rest period for the engine. To allow the engine to cool down from the temporary buildup of heat, cruise at a lower engine speed.

After the first 5 hours of operation, thoroughly check the motorcycle for loose parts, oil leakage and any other problems. Be sure to inspect and make ad-

justments thoroughly, especially cables. In addition, check all fittings and fasteners for looseness, and tighten if necessary.

ECA10270

NOTICE

If any engine trouble should occur during the engine break-in period, immediately have a Yamaha dealer check the vehicle.

OPERATION AND IMPORTANT RIDING POINTS

EAU40722

Parking

When parking, stop the engine, and then turn the fuel cock lever to “S” (stop).

EWA10311

WARNING

- Since the engine and exhaust system can become very hot, park in a place where pedestrians or children are not likely to touch them and be burned.
 - Do not park on a slope or on soft ground, otherwise the vehicle may overturn, increasing the risk of a fuel leak and fire.
 - Do not park near grass or other flammable materials which might catch fire.
-

PERIODIC MAINTENANCE AND ADJUSTMENT

EAU41951

Periodic inspection, adjustment, and lubrication will keep your vehicle in the safest and most efficient condition possible. Safety is an obligation of the vehicle owner/operator. The most important points of vehicle inspection, adjustment, and lubrication are explained on the following pages.

EWA10321

WARNING

Failure to properly maintain the vehicle or performing maintenance activities incorrectly may increase your risk of injury or death during service or while using the vehicle. If you are not familiar with vehicle service, have a Yamaha dealer perform service.

EWA15121

WARNING

Turn off the engine when performing maintenance unless otherwise specified.

- **A running engine has moving parts that can catch on body parts or clothing and electrical**

parts that can cause shocks or fires.

- **Running the engine while servicing can lead to eye injury, burns, fire, or carbon monoxide poisoning – possibly leading to death. See page 2-1 for more information about carbon monoxide.**

EAU17302

Emission controls not only function to ensure cleaner air, but are also vital to proper engine operation and maximum performance. In the following periodic maintenance charts, the services related to emissions control are grouped separately. These services require specialized data, knowledge, and equipment. Maintenance, replacement, or repair of the emission control devices and systems may be performed by any repair establishment or individual that is certified (if applicable). Yamaha dealers are trained and equipped to perform these particular services.

PERIODIC MAINTENANCE AND ADJUSTMENT

EAU17311

Owner's tool kit

The service information included in this manual and the tools provided in the owner's tool kit are intended to assist you in the performance of preventive maintenance and minor repairs. However, additional tools such as a torque wrench may be necessary to perform certain maintenance work correctly.

TIP

If you do not have the tools or experience required for a particular job, have a Yamaha dealer perform it for you.

PERIODIC MAINTENANCE AND ADJUSTMENT

EAU41741

Periodic maintenance chart for the emission control system

TIP

- From 18 months, repeat the maintenance intervals starting from 6 months.
- Items marked with an asterisk should be performed by a Yamaha dealer as they require special tools, data and technical skills.

NO.	ITEM	CHECK OR MAINTENANCE JOB	INITIAL			THEREAFTER EVERY	
			1 month	3 months	6 months	6 months	12 months
1	* Fuel line	<ul style="list-style-type: none"> ● Check fuel hoses for cracks or damage. ● Replace if necessary. 	√	√	√	√	
2	Spark plug	<ul style="list-style-type: none"> ● Check condition. ● Adjust gap and clean. ● Replace if necessary. 	√	√	√	√	
3	Air filter element	<ul style="list-style-type: none"> ● Clean with solvent. ● Replace if necessary. 		√	√	√	
4	* Carburetor	<ul style="list-style-type: none"> ● Check engine idling speed and starter operation. 		√	√	√	
		<ul style="list-style-type: none"> ● Adjust if necessary. ● Clean. 			√		√
5	* Cylinder head and exhaust system	<ul style="list-style-type: none"> ● Check for leakage. ● Tighten if necessary. ● Decarbonize if necessary. 		√	√	√	
6	* Spark arrester	<ul style="list-style-type: none"> ● Clean. 			√	√	

PERIODIC MAINTENANCE AND ADJUSTMENT

EAU41753

General maintenance and lubrication chart

NO.	ITEM	CHECK OR MAINTENANCE JOB	INITIAL			THEREAFTER EVERY		
			1 month	3 months	6 months	6 months	12 months	
1	*	Front brake	<ul style="list-style-type: none"> • Check operation. • Adjust brake lever free play. 	√	√	√	√	
			<ul style="list-style-type: none"> • Replace brake shoes. 	Whenever worn to the limit				
2	*	Rear brake	<ul style="list-style-type: none"> • Check operation. • Adjust brake lever free play. 	√	√	√	√	
			<ul style="list-style-type: none"> • Replace brake shoes. 	Whenever worn to the limit				
3	*	Wheels	<ul style="list-style-type: none"> • Check runout and for damage. • Replace if necessary. 	√	√	√	√	
4	*	Tires	<ul style="list-style-type: none"> • Check tread depth and for damage. • Replace if necessary. • Check air pressure. • Correct if necessary. 	√	√	√	√	
5	*	Wheel bearings	<ul style="list-style-type: none"> • Check bearings for smooth operation. • Replace if necessary. 					√
6	*	Steering bearings	<ul style="list-style-type: none"> • Check bearing assemblies for looseness. • Moderately repack with lithium-soap-based grease every 2 years. 			√		√
7	*	Middle and final gear cases	<ul style="list-style-type: none"> • Check for grease leakage. 	√	√	√	√	√
			<ul style="list-style-type: none"> • Check gears for damage and wear. • Lubricate gears with lithium-soap-based grease. 	Every 2 years				
8	*	Chassis fasteners	<ul style="list-style-type: none"> • Check all chassis fitting and fasteners. • Correct if necessary. 	√	√	√	√	
9	*	Autolube pump	<ul style="list-style-type: none"> • Check operation. • Correct if necessary. • Bleed. 	√	√	√	√	

7

PERIODIC MAINTENANCE AND ADJUSTMENT

NO.	ITEM	CHECK OR MAINTENANCE JOB	INITIAL			THEREAFTER EVERY		
			1 month	3 months	6 months	6 months	12 months	
10	*	Transmission oil	<ul style="list-style-type: none"> ● Check for oil leakage. ● Correct if necessary. 	√	√	√	√	
			<ul style="list-style-type: none"> ● Change. 	√		√		√
11	*	Front and rear brake lever pivot	<ul style="list-style-type: none"> ● Apply lithium-soap-based grease lightly. 		√	√	√	
12	*	Centerstand pivot	<ul style="list-style-type: none"> ● Check operation. ● Apply lithium-soap-based grease lightly. 		√	√	√	
13	*	Shock absorber assemblies	<ul style="list-style-type: none"> ● Check operation and for oil leakage. ● Replace if necessary. 	√	√	√	√	
14	*	Control cable	<ul style="list-style-type: none"> ● Apply Yamaha chain and cable lube or engine oil 10W-30 lightly. 		√	√		√
15	*	Throttle grip housing and cable	<ul style="list-style-type: none"> ● Check operation and free play. ● Apply Yamaha chain and cable lube or engine oil 10W-30 lightly. 	√	√	√	√	

TIP

The air filter needs more frequent service if you are riding in unusually wet or dusty areas.

PERIODIC MAINTENANCE AND ADJUSTMENT

EAU19603

Checking the spark plug

The spark plug is an important engine component, which is easy to check. Since heat and deposits will cause any spark plug to slowly erode, the spark plug should be removed and checked in accordance with the periodic maintenance and lubrication chart. In addition, the condition of the spark plug can reveal the condition of the engine.

To remove the spark plug

1. Remove the spark plug cap.

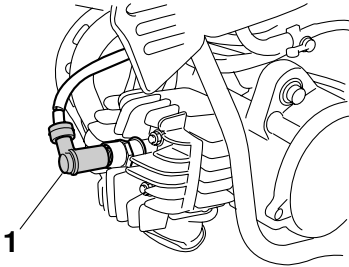

1. Spark plug cap

2. Remove the spark plug as shown, with the spark plug wrench included in the owner's tool kit.

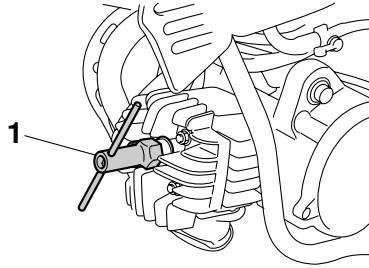

1. Spark plug wrench

To check the spark plug

1. Check that the porcelain insulator around the center electrode of the spark plug is a medium-to-light tan (the ideal color when the vehicle is ridden normally).

TIP

If the spark plug shows a distinctly different color, the engine could be operating improperly. Do not attempt to diagnose such problems yourself. Instead, have a Yamaha dealer check the vehicle.

2. Check the spark plug for electrode erosion and excessive carbon or

other deposits, and replace it if necessary.

Specified spark plug:

NGK/BP4HS
DENSO/W14FPL

To install the spark plug

1. Measure the spark plug gap with a wire thickness gauge and, if necessary, adjust the gap to specification.

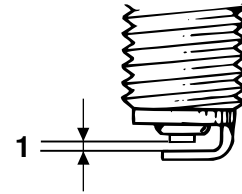

1. Spark plug gap

Spark plug gap:

0.6–0.7 mm (0.024–0.028 in)

2. Clean the surface of the spark plug gasket and its mating surface, and

PERIODIC MAINTENANCE AND ADJUSTMENT

then wipe off any grime from the spark plug threads.

3. Install the spark plug with the spark plug wrench, and then tighten it to the specified torque.

Tightening torque:

Spark plug:
20 Nm (2.0 m·kgf, 14.5 ft·lbf)

TIP

If a torque wrench is not available when installing a spark plug, a good estimate of the correct torque is 1/4–1/2 turn past finger tight. However, the spark plug should be tightened to the specified torque as soon as possible.

4. Install the spark plug cap.

EAU41102

Removing the power reduction plate

To obtain full engine performance capability, removing the power reduction plate is required.

1. Remove the exhaust manifold by removing the bolts. **WARNING! Always let the exhaust system cool prior to touching exhaust components.**^[EWA14581]

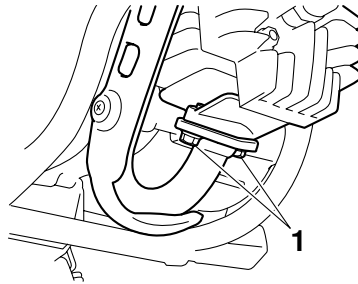

1. Exhaust manifold bolt
2. Remove the gasket.
3. Remove the power reduction plate.

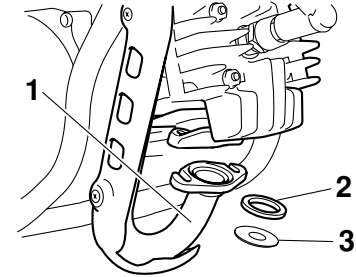

1. Exhaust manifold
2. Gasket
3. Power reduction plate

TIP

Store the power reduction plate with the Owner's Manual so that it is readily available whenever you want to reduce the engine power.

4. Install the exhaust manifold by installing the bolts.

Tightening torque:

Exhaust manifold bolt:
8.5 Nm (0.9 m·kgf, 6.1 ft·lbf)

PERIODIC MAINTENANCE AND ADJUSTMENT

EAU40892

Transmission oil

The transmission oil must be checked for oil leakage before each ride. If any leakage is found, have a Yamaha dealer check and repair the motorcycle. In addition, the transmission oil must be changed at the intervals specified in the periodic maintenance and lubrication chart.

1. Place the motorcycle on the centerstand.
2. Place an oil pan under the transmission to collect the used oil.
3. Remove the oil filler cap and drain bolt to drain the oil from the transmission.

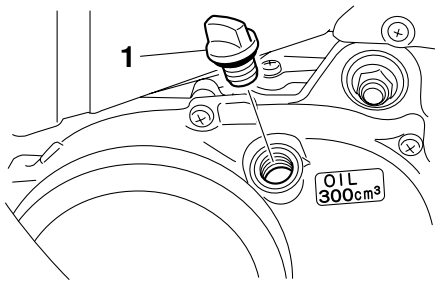

1. Transmission oil filler cap

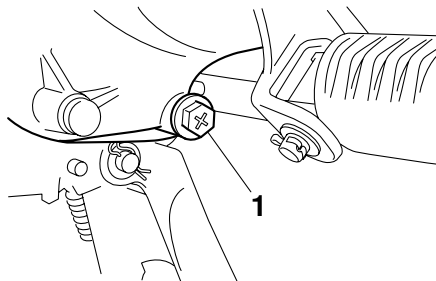

1. Transmission oil drain bolt

4. Install the transmission oil drain bolt, and then tighten it to the specified torque.

Tightening torque:

Transmission oil drain bolt:
14 Nm (1.4 m·kgf, 10.1 ft·lbf)

5. Refill with the specified amount of the recommended transmission oil, and then install and tighten the oil filler cap.

Recommended transmission oil:

See page 9-1.

Oil change quantity:

0.30 L (0.32 US qt, 0.26 Imp.qt)

ECA10452

NOTICE

- In order to prevent clutch slippage (since the transmission oil also lubricates the clutch), do not mix any chemical additives. Do not use oils with a diesel specification of “CD” or oils of a higher quality than specified. In addition, do not use oils labeled “ENERGY CONSERVING II” or higher.
 - Make sure that no foreign material enters the transmission.
6. Start the engine, and then let it idle for several minutes while checking the transmission for oil leakage. If oil is leaking, immediately turn the engine off and check for the cause.

PERIODIC MAINTENANCE AND ADJUSTMENT

EAU41711

Middle and final gear cases

The middle and final gear cases must be checked for grease leakage before each ride. If any leakage is found, have a Yamaha dealer check and repair the motorcycle. In addition, have a Yamaha dealer check and lubricate the middle and final gears at the intervals specified in the periodic maintenance and lubrication chart.

EAU40902

Cleaning the air filter element

The air filter element should be cleaned at the intervals specified in the periodic maintenance and lubrication chart. Clean the air filter element more frequently if you are riding in unusually wet or dusty areas.

1. Remove the seat. (See page 4-7.)
2. Remove the air filter case cover by removing the screw.

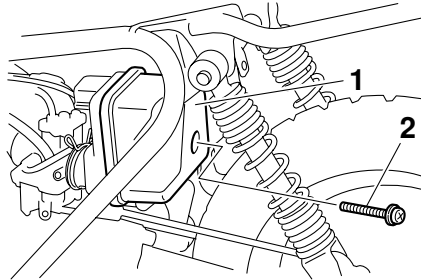

1. Air filter case cover
2. Screw

3. Pull the sponge material out, clean it with solvent, and then squeeze the remaining solvent out.

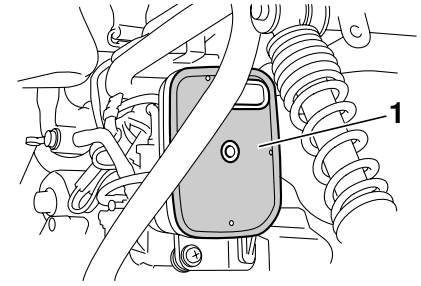

1. Sponge material

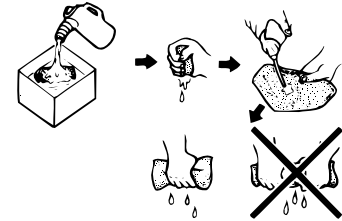

4. Apply oil of the recommended type to the entire surface of the sponge material, and then squeeze the excess oil out.

TIP

The sponge material should be wet but

PERIODIC MAINTENANCE AND ADJUSTMENT

not dripping.

Recommended oil:

Yamaha foam air filter oil or other quality foam air filter oil

5. Insert the sponge material into the air filter case. **NOTICE: Make sure that the sponge material is properly seated in the air filter case. The engine should never be operated without the sponge material installed, otherwise the piston(s) and/or cylinder(s) may become excessively worn.**^[ECA15621]
6. Install the air filter case cover by installing the screw.
7. Install the seat.

7

Cleaning the spark arrester

The spark arrester should be cleaned at the intervals specified in the periodic maintenance and lubrication chart.

EAU41220

EWA10980

WARNING

- Always let the exhaust system cool prior to touching exhaust components.
- Do not start the engine when cleaning the exhaust system.

TIP

Make sure to select a well-ventilated area free of combustible materials to clean the spark arrester.

1. Remove the tailpipe by removing the screw, and then pulling it out of the muffler.

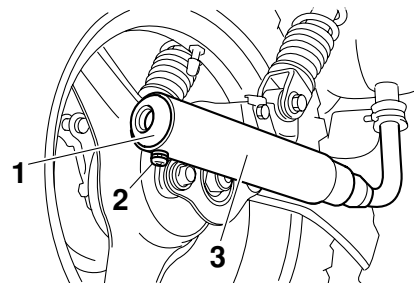

1. Tailpipe
2. Screw
3. Muffler

2. Tap the tailpipe lightly, and then use a wire brush to remove any carbon deposits from the spark arrester portion of the tailpipe and inside of the tailpipe housing.

PERIODIC MAINTENANCE AND ADJUSTMENT

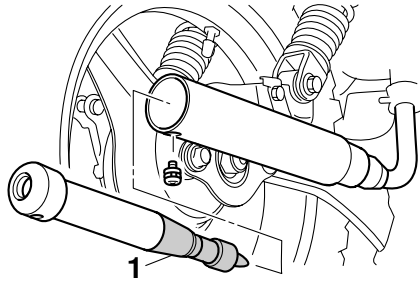

1. Spark arrester

3. Insert the tailpipe into the muffler, and then install and tighten the screw.

TIP _____
Make sure to align the screw hole when inserting the tailpipe.

EAU39930

Adjusting the carburetor

The carburetor is an important part of the engine and requires very sophisticated adjustment. Therefore, most carburetor adjustments should be left to a Yamaha dealer, who has the necessary professional knowledge and experience. The adjustment described in the following section, however, may be serviced by the owner as part of routine maintenance.

ECA10550

NOTICE _____

The carburetor has been set and extensively tested at the Yamaha factory. Changing these settings without sufficient technical knowledge may result in poor performance of or damage to the engine.

EAU21362

Adjusting the engine idling speed

The engine idling speed must be checked and, if necessary, adjusted as follows at the intervals specified in the periodic maintenance and lubrication chart.

TIP _____
A diagnostic tachometer is needed to make this adjustment.

1. Attach the tachometer to the spark plug lead.
2. Start the engine and warm it up for several minutes at 1000–2000 r/min while occasionally revving it to 4000–5000 r/min.

TIP _____
The engine is warm when it quickly responds to the throttle.

3. Check the engine idling speed and, if necessary, adjust it to specification by turning the throttle stop screw. To increase the engine idling speed, turn the screw in direction (a). To decrease the engine idling speed, turn the screw in

PERIODIC MAINTENANCE AND ADJUSTMENT

direction (b).

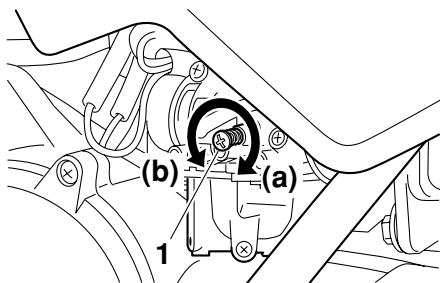

1. Throttle stop screw

Engine idling speed:
1650–1750 r/min

TIP

If the specified idling speed cannot be obtained as described above, have a Yamaha dealer make the adjustment.

7

EAU21382

Checking the throttle cable free play

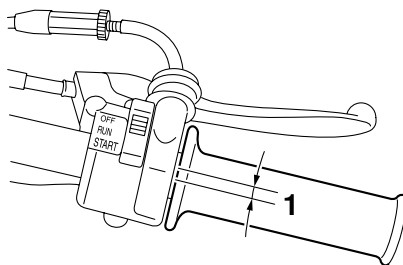

1. Throttle cable free play

The throttle cable free play should measure 1.5–3.5 mm (0.06–0.14 in) at the throttle grip. Periodically check the throttle cable free play and, if necessary, have a Yamaha dealer adjust it.

EAU40911

Tires

To maximize the performance, durability, and safe operation of your motorcycle, note the following points regarding the specified tires.

Tire air pressure

The tire air pressure should be checked and, if necessary, adjusted before each ride.

EWA14381

WARNING

Operation of this vehicle with improper tire pressure may cause severe injury or death from loss of control.

- The tire air pressure must be checked and adjusted on cold tires (i.e., when the temperature of the tires equals the ambient temperature).
- The tire air pressure must be adjusted in accordance with the weight of the rider, the riding speed, and the riding conditions.

PERIODIC MAINTENANCE AND ADJUSTMENT

Standard tire air pressure:

Front:

100 kPa (1.00 kgf/cm², 15 psi)

Rear:

100 kPa (1.00 kgf/cm², 15 psi)

Minimum tire tread depth (front and rear):

4.0 mm (0.16 in)

Front tire:

Size:

2.50-10 4PR

Manufacturer/model:

BRIDGESTONE/KNOBBY
IRC/KNOBBY

Rear tire:

Size:

2.50-10 4PR

Manufacturer/model:

BRIDGESTONE/KNOBBY
IRC/KNOBBY

EWA10461

EWA14390

Tire inspection

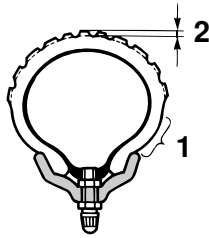

1. Tire sidewall
2. Tire tread depth

The tires must be checked before each ride. If the center tread depth reaches the specified limit, if the tire has a nail or glass fragments in it, or if the sidewall is cracked, have a Yamaha dealer replace the tire immediately.

Tire information

This motorcycle is equipped with panel wheels and tube tires.

WARNING

The front and rear tires should be of the same make and design, otherwise the handling characteristics of the vehicle may be different, which could lead to an accident.

After extensive tests, only the tires listed below have been approved for this model by Yamaha Motor Co., Ltd.

WARNING

- Have a Yamaha dealer replace excessively worn tires. Operating the motorcycle with excessively worn tires decreases riding stability and can lead to loss of control.
- The replacement of all wheel-and brake-related parts, including the tires, should be left to a Yamaha dealer, who has the necessary professional knowledge and experience.
- It is not recommended to patch a punctured tube. If unavoidable, however, patch the tube

PERIODIC MAINTENANCE AND ADJUSTMENT

very carefully and replace it as soon as possible with a high-quality product.

Panel wheels

EAU40780

EWA10610



The wheels on this model are not designed for use with tubeless tires. Do not attempt to use tubeless tires on this model.

To maximize the performance, durability, and safe operation of your motorcycle, note the following points regarding the specified wheels.

- The wheel rims should be checked for cracks, bends, warpage or damage before each ride. If any damage is found, have a Yamaha dealer replace the wheel. Do not attempt even the smallest repair to the wheel. A deformed or cracked wheel must be replaced.
- The wheel should be balanced whenever either the tire or wheel has been changed or replaced. An unbalanced wheel can result in poor performance, adverse handling characteristics, and a shortened tire life.
- Ride conservatively after changing

a tire since the tire must seat itself on the rim properly. Failure to allow proper seating may cause tire failure, which may result in damage to the motorcycle and injury to the rider.

PERIODIC MAINTENANCE AND ADJUSTMENT

EAU22151

Adjusting the front and rear brake lever free play

Front

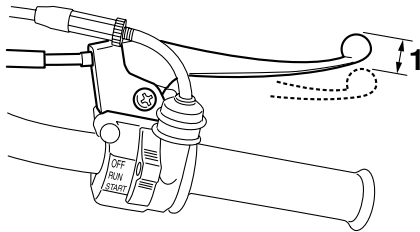

1. Front brake lever free play

Rear

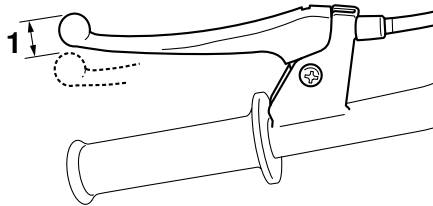

1. Rear brake lever free play

The front and rear brake lever free play should be measured at the positions as shown.

Front brake lever free play:

10.0–20.0 mm (0.39–0.79 in)

Rear brake lever free play:

10.0–20.0 mm (0.39–0.79 in)

Periodically check the front and rear brake lever free play and, if necessary, adjust them as follows.

To increase the brake lever free play, turn the adjusting nut at the brake shoe plate in direction (a). To decrease the brake lever free play, turn the adjusting nut in direction (b).

Front

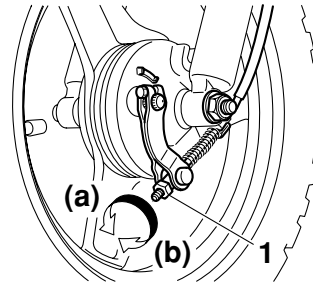

1. Brake lever free play adjusting nut

Rear

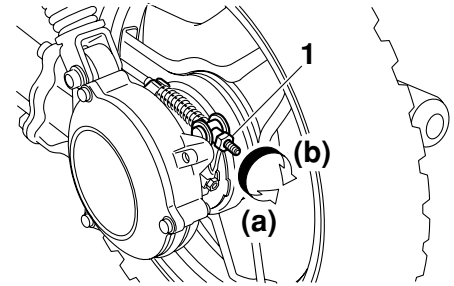

1. Brake lever free play adjusting nut

EWA10650

WARNING

If proper adjustment cannot be obtained as described, have a Yamaha dealer make this adjustment.

PERIODIC MAINTENANCE AND ADJUSTMENT

EAU41052

Checking the front and rear brake shoes

The front and rear brake shoes must be checked for wear at the intervals specified in the periodic maintenance and lubrication chart.

TIP

The wheels must be removed to check brake shoe lining thickness.

- To remove the front wheel: See page 7-19.
- To remove the rear wheel: See page 7-21.

Front

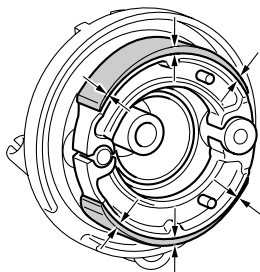

Rear

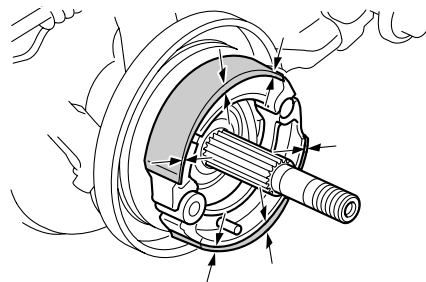

If the lining thickness of a brake shoe is less than 1.5 mm (0.06 in), have a Yamaha dealer replace the brake shoes as a set.

TIP

Be sure to measure the brake lining at the thinnest portion.

EAU41842

Checking and lubricating the cables

The operation of all control cables and the condition of the cables should be checked before each ride, and the cables and cable ends should be lubricated if necessary. If a cable is damaged or does not move smoothly, have a Yamaha dealer check or replace it. **WARNING! Damage to the outer housing of cables may result in internal rusting and cause interference with cable movement. Replace damaged cables as soon as possible to prevent unsafe conditions.**^[EWA10711]

Recommended lubricant:

Yamaha Chain and Cable Lube or
4-stroke engine oil

PERIODIC MAINTENANCE AND ADJUSTMENT

EAU23111

Checking and lubricating the throttle grip and cable

The operation of the throttle grip should be checked before each ride. In addition, the cable should be lubricated at the intervals specified in the periodic maintenance chart.

EAU23120

Adjusting the Autolube pump

The Autolube pump is a vital and sophisticated component of the engine, which must be adjusted by a Yamaha dealer at the intervals specified in the periodic maintenance and lubrication chart.

EAU43631

Lubricating the front and rear brake levers

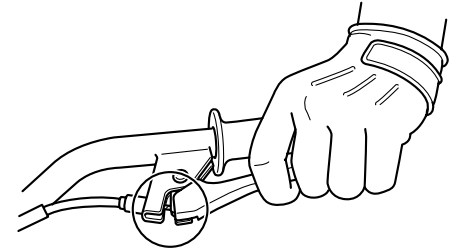

The pivoting points of the front and rear brake levers must be lubricated at the intervals specified in the periodic maintenance and lubrication chart.

Recommended lubricant:
Lithium-soap-based grease

PERIODIC MAINTENANCE AND ADJUSTMENT

EAU23192

Checking and lubricating the centerstand

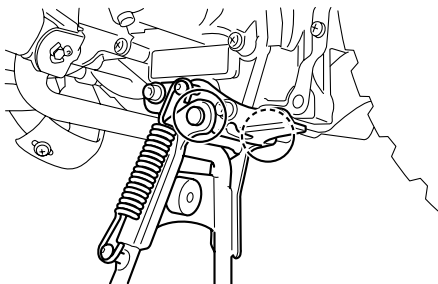

The operation of the centerstand should be checked before each ride, and the pivots and metal-to-metal contact surfaces should be lubricated if necessary.

EWA11301

WARNING

If the centerstand does not move up and down smoothly, have a Yamaha dealer check or repair it. Otherwise, the centerstand could contact the ground and distract the operator, resulting in a possible loss of control.

Recommended lubricant:
Lithium-soap-based grease

EAU42081

Checking the front fork

The condition and operation of the front fork must be checked as follows at the intervals specified in the periodic maintenance and lubrication chart.

To check the condition

Check the inner tubes for scratches and damage.

To check the operation

1. Place the vehicle on a level surface and hold it in an upright position. **WARNING! To avoid injury, securely support the vehicle so there is no danger of it falling over.** [EWA10751]
2. While applying the front brake, push down hard on the handlebars several times to check if the front fork compresses and rebounds smoothly.

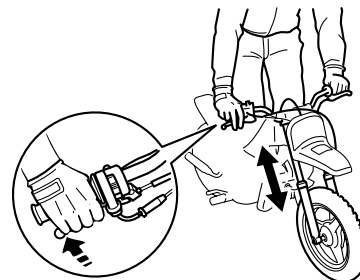

ECA10590

NOTICE

If any damage is found or the front fork does not operate smoothly, have a Yamaha dealer check or repair it.

PERIODIC MAINTENANCE AND ADJUSTMENT

EAU45511

Checking the steering

Worn or loose steering bearings may cause danger. Therefore, the operation of the steering must be checked as follows at the intervals specified in the periodic maintenance and lubrication chart.

1. Place the vehicle on the centerstand. **WARNING! To avoid injury, securely support the vehicle so there is no danger of it falling over.**^[EWA10751]
2. Hold the lower ends of the front fork legs and try to move them forward and backward. If any free play can be felt, have a Yamaha dealer check or repair the steering.

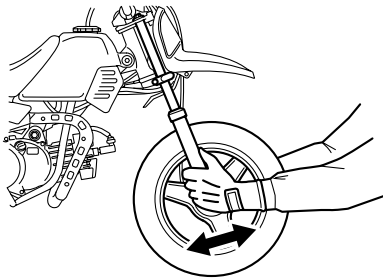

EAU23290

Checking the wheel bearings

The front and rear wheel bearings must be checked at the intervals specified in the periodic maintenance and lubrication chart. If there is play in the wheel hub or if the wheel does not turn smoothly, have a Yamaha dealer check the wheel bearings.

EAU24360

Front wheel

EAU41022

To remove the front wheel

EWA10821



WARNING
To avoid injury, securely support the vehicle so there is no danger of it falling over.

1. Place the motorcycle on the centerstand.
2. Disconnect the brake cable at the wheel by removing the brake lever free play adjusting nut, then removing the cable from the brake camshaft lever and brake shoe plate.

PERIODIC MAINTENANCE AND ADJUSTMENT

EAU41031

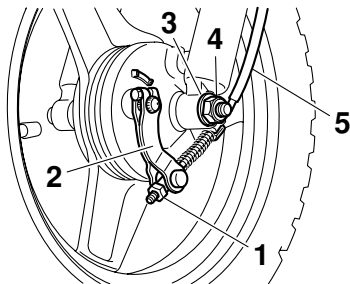

1. Brake lever free play adjusting nut
2. Brake camshaft lever
3. Washer
4. Axle nut
5. Brake cable

3. Remove the axle nut and washer.
4. Pull the wheel axle out, and then remove the wheel.

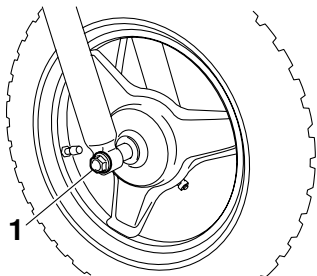

1. Wheel axle

To install the front wheel

1. Install the brake shoe plate into the wheel hub as shown.

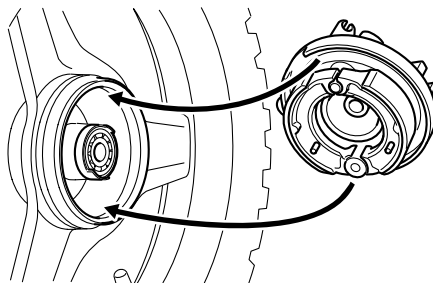

2. Lift the wheel up between the fork legs.

TIP

Make sure that the slot in the brake shoe plate fits over the retainer on the fork leg.

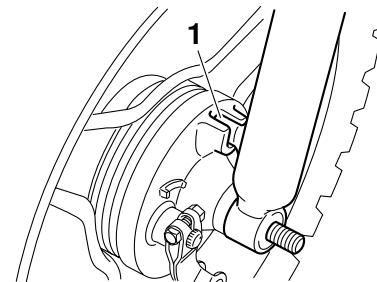

1. Retainer

3. Insert the wheel axle from the right side.
4. Install the washer and axle nut, and then tighten the axle nut to the specified torque.

Tightening torque:

Axle nut:

40 Nm (4.0 m·kgf, 28.9 ft·lbf)

5. Connect the brake cable at the wheel hub, and then install the brake cable free play adjusting nut.
6. Adjust the brake lever free play. (See page 7-15.)
7. Take the motorcycle off the centerstand so that the front wheel is on the ground.

PERIODIC MAINTENANCE AND ADJUSTMENT

8. Push down hard on the handlebar several times to check for proper fork operation.

Rear wheel

EAU25080

To remove the rear wheel

EAU41082

EWA10821

! WARNING

To avoid injury, securely support the vehicle so there is no danger of it falling over.

1. Place the motorcycle on the centerstand.
2. Remove the seat. (See page 4-7.)
3. Remove the muffler bolt and washers. **WARNING! Always let the exhaust system cool prior to touching exhaust components.**^[EWA14581]

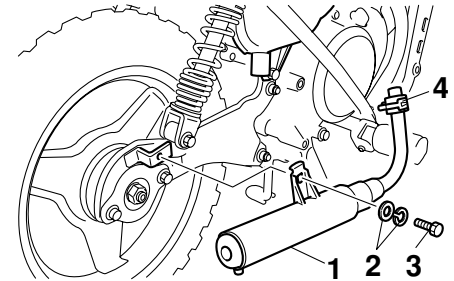

1. Muffler
2. Washer
3. Muffler bolt
4. Spring clamp

4. Slide the spring clamp down, and then remove the muffler.

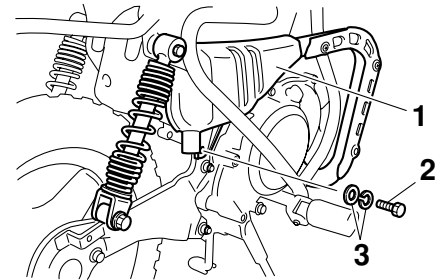

1. Exhaust chamber
2. Exhaust chamber bolt
3. Washer

PERIODIC MAINTENANCE AND ADJUSTMENT

5. Remove the exhaust chamber bolt and washers.
6. Remove the exhaust manifold bolts, and then remove the exhaust chamber.

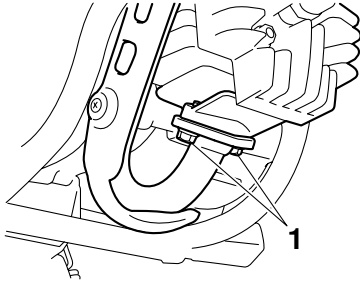

1. Exhaust manifold bolt

7. Remove the right-side rear shock absorber mounting bolt and then tilt the rear shock absorber upward as shown.

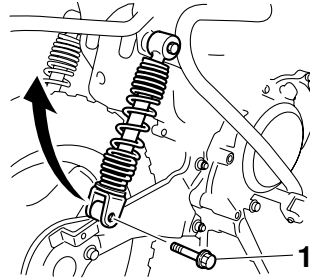

1. Rear shock absorber mounting bolt

8. Remove the axle nut while applying the rear brake.

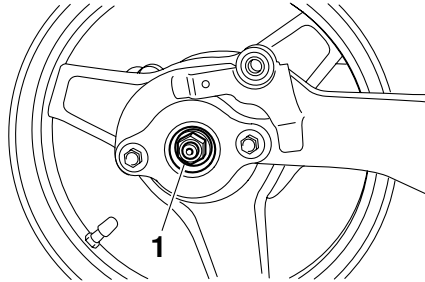

1. Axle nut

9. Remove the rear arm by removing the nuts and washers.

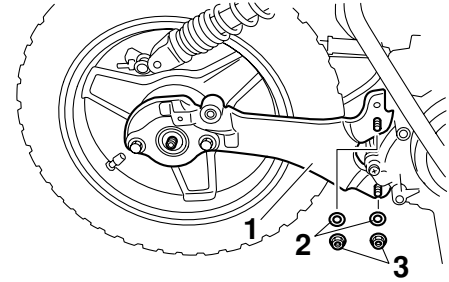

1. Rear arm
2. Washer
3. Rear arm nut

10. Pull the wheel to the right to separate it from the final gear case, and then remove the wheel.

EAU41521

To install the rear wheel

1. Apply a light coating of lithium-soap-based grease to the splines of the final gear case and wheel hub.
2. Install the wheel by inserting it into the wheel hub.
3. Install the rear arm by installing the washers and nuts.
4. Install the axle nut.
5. Install the right-side rear shock ab-

PERIODIC MAINTENANCE AND ADJUSTMENT

- sorber by installing the mounting bolt.
- While applying the rear brake, tighten the axle nut to the specified torque.
 - Tighten the rear arm nuts and rear shock absorber mounting bolt to the specified torques.

Tightening torques:

Axle nut:

60 Nm (6.0 m·kgf, 43.4 ft·lbf)

Rear arm nut:

28.5 Nm (2.9 m·kgf, 20.6 ft·lbf)

Rear shock absorber mounting bolt:

22.5 Nm (2.3 m·kgf, 16.3 ft·lbf)

- Install the exhaust chamber and then install the exhaust manifold bolts.
- Install the washers and exhaust chamber bolt.
- Tighten the exhaust manifold bolts and exhaust chamber bolt to the specified torques.

Tightening torques:

Exhaust manifold bolt:

8.5 Nm (0.9 m·kgf, 6.1 ft·lbf)

Exhaust chamber bolt:

17.5 Nm (1.8 m·kgf, 12.7 ft·lbf)

- Install the muffler by sliding the spring clamp up to its original position, and then installing the washers and muffler bolt.

TIP

Make sure that the spring clamp is positioned with the projection side facing inward.

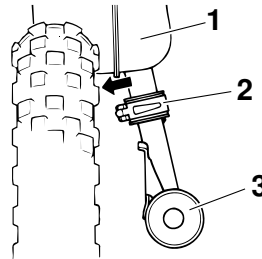

1. Exhaust chamber

2. Spring clamp

3. Muffler

- Tighten the muffler bolt to the specified torque.

Tightening torque:

Muffler bolt:

17.5 Nm (1.8 m·kgf, 12.7 ft·lbf)

- Adjust the brake lever free play. (See page 7-15.)
- Install the seat.

PERIODIC MAINTENANCE AND ADJUSTMENT

EAU25851

Troubleshooting

Although Yamaha motorcycles receive a thorough inspection before shipment from the factory, trouble may occur during operation. Any problem in the fuel, compression, or ignition systems, for example, can cause poor starting and loss of power.

The following troubleshooting chart represents a quick and easy procedure for checking these vital systems yourself. However, should your motorcycle require any repair, take it to a Yamaha dealer, whose skilled technicians have the necessary tools, experience, and know-how to service the motorcycle properly.

Use only genuine Yamaha replacement parts. Imitation parts may look like Yamaha parts, but they are often inferior, have a shorter service life and can lead to expensive repair bills.

EWA15141



When checking the fuel system, do not smoke, and make sure there are no open flames or sparks in the area, including pilot lights from water

heaters or furnaces. Gasoline or gasoline vapors can ignite or explode, causing severe injury or property damage.

PERIODIC MAINTENANCE AND ADJUSTMENT

EAU25972

Troubleshooting chart

1. Fuel

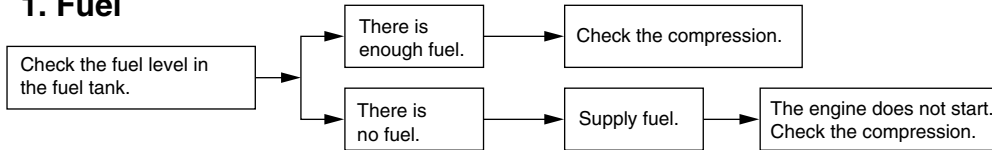

2. Compression

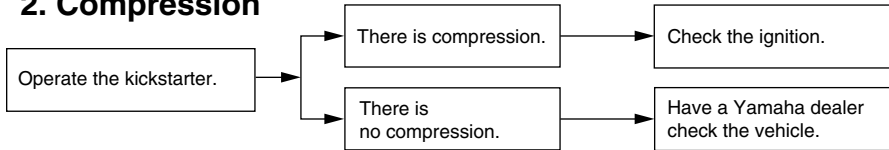

3. Ignition

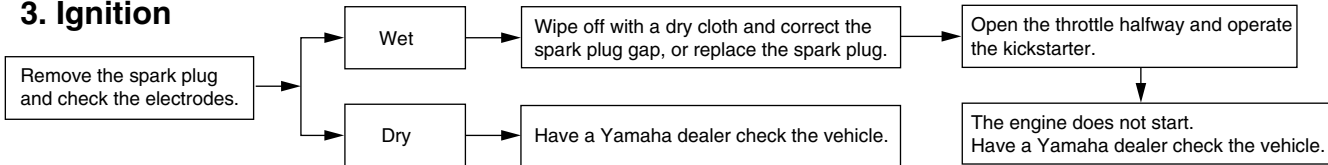

MOTORCYCLE CARE AND STORAGE

Matte color caution

EAU37833

EAU40633

NOTICE

Some models are equipped with matte colored finished parts. Be sure to consult a Yamaha dealer for advice on what products to use before cleaning the vehicle. Using a brush, harsh chemical products or cleaning compounds when cleaning these parts will scratch or damage their surface. Wax also should not be applied to any matte colored finished parts.

ECA15192

Care

While the open design of a motorcycle reveals the attractiveness of the technology, it also makes it more vulnerable. Rust and corrosion can develop even if high-quality components are used. A rusty exhaust pipe may go unnoticed on a car, however, it detracts from the overall appearance of a motorcycle. Frequent and proper care does not only comply with the terms of the warranty, but it will also keep your motorcycle looking good, extend its life and optimize its performance.

Before cleaning

1. Cover the muffler outlet with a plastic bag after the engine has cooled down.
2. Make sure that all caps and covers as well as all electrical couplers and connectors, including the spark plug cap, are tightly installed.
3. Remove extremely stubborn dirt, like oil burnt onto the crankcase, with a degreasing agent and a brush, but never apply such prod-

ucts onto seals, gaskets and wheel axles. Always rinse the dirt and degreaser off with water.

Cleaning

ECA10771

NOTICE

- **Avoid using strong acidic wheel cleaners, especially on spoked wheels. If such products are used on hard-to-remove dirt, do not leave the cleaner on the affected area any longer than instructed. Also, thoroughly rinse the area off with water, immediately dry it, and then apply a corrosion protection spray.**
- **Improper cleaning can damage plastic parts such as cowlings, panels, windshields, headlight lenses, meter lenses, etc. Use only a soft, clean cloth or sponge with mild detergent and water to clean plastic.**
- **Do not use any harsh chemical products on plastic parts. Be sure to avoid using cloths or sponges which have been in contact with strong or abrasive**

MOTORCYCLE CARE AND STORAGE

cleaning products, solvent or thinner, fuel (gasoline), rust removers or inhibitors, brake fluid, antifreeze or electrolyte.

- Do not use high-pressure washers or steam-jet cleaners since they cause water seepage and deterioration in the following areas: seals (of wheel and swing-arm bearings, fork and brakes), electric components (couplers, connectors, instruments, switches and lights), breather hoses and vents.
- For motorcycles equipped with a windshield: Do not use strong cleaners or hard sponges as they will cause dulling or scratching. Some cleaning compounds for plastic may leave scratches on the windshield. Test the product on a small hidden part of the windshield to make sure that it does not leave any marks. If the windshield is scratched, use a quality plastic polishing compound after washing.

After normal use

Remove dirt with warm water, a mild detergent, and a soft, clean sponge, and then rinse thoroughly with clean water. Use a toothbrush or bottlebrush for hard-to-reach areas. Stubborn dirt and insects will come off more easily if the area is covered with a wet cloth for a few minutes before cleaning.

After riding in the rain or near the sea

Since sea salt is extremely corrosive, carry out the following steps after each ride in the rain or near the sea.

1. Clean the motorcycle with cold water and a mild detergent, after the engine has cooled down.
NOTICE: Do not use warm water since it increases the corrosive action of the salt.^[ECA10791]
2. Apply a corrosion protection spray on all metal, including chrome- and nickel-plated, surfaces to prevent corrosion.

After cleaning

1. Dry the motorcycle with a chamois or an absorbing cloth.

2. Use a chrome polish to shine chrome, aluminum and stainless-steel parts, including the exhaust system. (Even the thermally induced discoloring of stainless-steel exhaust systems can be removed through polishing.)
3. To prevent corrosion, it is recommended to apply a corrosion protection spray on all metal, including chrome- and nickel-plated, surfaces.
4. Use spray oil as a universal cleaner to remove any remaining dirt.
5. Touch up minor paint damage caused by stones, etc.
6. Wax all painted surfaces.
7. Let the motorcycle dry completely before storing or covering it.

EWA14501



WARNING

Contaminants on the brakes or tires can cause loss of control.

- Make sure that there is no oil or wax on the tires.
- If necessary, wash the tires with warm water and a mild detergent. Before riding at higher speeds, test the motorcycle's

MOTORCYCLE CARE AND STORAGE

braking performance and cornering behavior.

ECA10800

NOTICE

- Apply spray oil and wax sparingly and make sure to wipe off any excess.
 - Never apply oil or wax to any rubber and plastic parts, but treat them with a suitable care product.
 - Avoid using abrasive polishing compounds as they will wear away the paint.
-

TIP

Consult a Yamaha dealer for advice on what products to use.

EAU40643

Storage

Short-term

Always store your motorcycle in a cool, dry place and, if necessary, protect it against dust with a porous cover.

ECA10810

NOTICE

- Storing the motorcycle in a poorly ventilated room or covering it with a tarp, while it is still wet, will allow water and humidity to seep in and cause rust.
 - To prevent corrosion, avoid damp cellars, stables (because of the presence of ammonia) and areas where strong chemicals are stored.
-

Long-term

Before storing your motorcycle for several months:

1. Follow all the instructions in the “Care” section of this chapter.
2. For motorcycles equipped with a fuel cock that has an “S” (stop) position: Turn the fuel cock lever to

“S”.

3. Drain the carburetor float chamber by loosening the drain bolt; this will prevent fuel deposits from building up. Pour the drained fuel into the fuel tank.
4. Fill up the fuel tank and add fuel stabilizer (if available) to prevent the fuel tank from rusting and the fuel from deteriorating.
5. Perform the following steps to protect the cylinder, piston rings, etc. from corrosion.
 - a. Remove the spark plug cap and spark plug.
 - b. Pour a teaspoonful of engine oil into the spark plug bore.
 - c. Install the spark plug cap onto the spark plug, and then place the spark plug on the cylinder head so that the electrodes are grounded. (This will limit sparking during the next step.)
 - d. Turn the engine over several times with the starter. (This will coat the cylinder wall with oil.)
 - e. Remove the spark plug cap from the spark plug, and then

install the spark plug and the spark plug cap. **WARNING! To prevent damage or injury from sparking, make sure to ground the spark plug electrodes while turning the engine over.**^[EWA10951]

6. Lubricate all control cables and the pivoting points of all levers and pedals as well as of the center-stand.
7. Check and, if necessary, correct the tire air pressure, and then lift the motorcycle so that both of its wheels are off the ground. Alternatively, turn the wheels a little every month in order to prevent the tires from becoming degraded in one spot.
8. Cover the muffler outlet with a plastic bag to prevent moisture from entering it.

TIP

Make any necessary repairs before storing the motorcycle.

SPECIFICATIONS

EAU2633N

Dimensions:

- Overall length:
1245 mm (49.0 in)
- Overall width:
575 mm (22.6 in)
- Overall height:
715 mm (28.1 in)
- Seat height:
485 mm (19.1 in)
- Wheelbase:
855 mm (33.7 in)
- Ground clearance:
105 mm (4.13 in)
- Minimum turning radius:
1300 mm (51.2 in)

Weight:

- With oil and fuel:
39.0 kg (86 lb)

Engine:

- Engine type:
Air cooled 2-stroke
- Cylinder arrangement:
Forward-inclined single cylinder
- Displacement:
49.0 cm³
- Bore × stroke:
40.0 × 39.2 mm (1.57 × 1.54 in)
- Compression ratio:
6.00 :1
- Starting system:
Kickstarter

- Lubrication system:
Separate lubrication (Yamaha autolube)

Engine oil:

- Type:
YAMALUBE 2 or 2-stroke engine oil (JASO FC grade) or (ISO EG-C or EG-D grade)

Engine oil quantity:

- Quantity:
0.30 L (0.32 US qt, 0.26 Imp.qt)

Transmission oil:

- Type:
YAMALUBE 4 (10W-40) or SAE 10W-40
- Oil change quantity:
0.30 L (0.32 US qt, 0.26 Imp.qt)

Air filter:

- Air filter element:
Wet element

Fuel:

- Recommended fuel:
Unleaded gasoline only
- Fuel tank capacity:
2.0 L (0.53 US gal, 0.44 Imp.gal)

Carburetor:

- Manufacturer:
MIKUNI
- Type × quantity:
VM12SC x 1

Spark plug (s):

- Manufacturer/model:
NGK/BP4HS
- Manufacturer/model:
DENSO/W14FPL

- Spark plug gap:
0.6–0.7 mm (0.024–0.028 in)

Clutch:

- Clutch type:
Wet, centrifugal automatic

Transmission:

- Primary reduction system:
Spur gear
- Primary reduction ratio:
63/33 (1.909)
- Secondary reduction system:
Shaft drive
- Secondary reduction ratio:
19/15 × 54/11 (6.218)

Chassis:

- Frame type:
Steel tube backbone
- Caster angle:
25.50 °
- Trail:
50.0 mm (1.97 in)

Front tire:

- Type:
With tube
- Size:
2.50-10 4PR
- Manufacturer/model:
BRIDGESTONE/KNOBBY
- Manufacturer/model:
IRC/KNOBBY

Rear tire:

- Type:
With tube

Size:

2.50-10 4PR

Manufacturer/model:

BRIDGESTONE/KNOBBY

Manufacturer/model:

IRC/KNOBBY

Loading:**Maximum rider weight:**

25.0 kg (55 lb)

* (Total weight of rider, cargo and accessories)

Tire air pressure (measured on cold tires):**Front:**

100 kPa (1.00 kgf/cm², 15 psi)

Rear:

100 kPa (1.00 kgf/cm², 15 psi)

Front wheel:**Wheel type:**

Panel wheel

Rim size:

10x1.50

Rear wheel:**Wheel type:**

Panel wheel

Rim size:

10x1.50

Front brake:**Type:**

Drum brake

Operation:

Right hand operation

Rear brake:**Type:**

Drum brake

Operation:

Left hand operation

Front suspension:**Type:**

Telescopic fork

Spring/shock absorber type:

Coil spring/oil damper

Wheel travel:

60.0 mm (2.36 in)

Rear suspension:**Type:**

Unit swing

Spring/shock absorber type:

Coil spring/oil damper

Wheel travel:

50.0 mm (1.97 in)

Electrical system:**Ignition system:**

CDI

CONSUMER INFORMATION

EAU40790

Identification numbers

Record the vehicle identification number and model label information in the spaces provided below for assistance when ordering spare parts from a Yamaha dealer or for reference in case the vehicle is stolen.

VEHICLE IDENTIFICATION
NUMBER:

MODEL LABEL INFORMATION:

EAU26400

Vehicle identification number

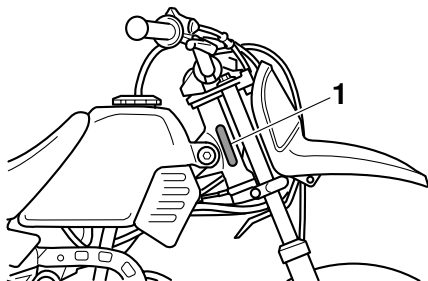

1. Vehicle identification number

The vehicle identification number is stamped into the steering head pipe. Record this number in the space provided.

TIP

The vehicle identification number is used to identify your motorcycle and may be used to register your motorcycle with the licensing authority in your area.

EAU26480

Model label

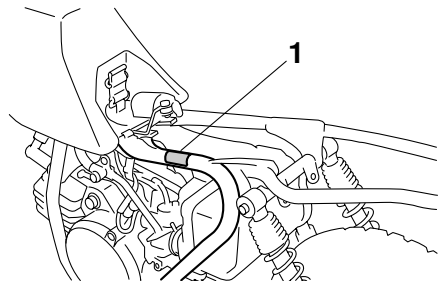

1. Model label

The model label is affixed to the frame under the seat. (See page 4-7.) Record the information on this label in the space provided. This information will be needed when ordering spare parts from a Yamaha dealer.

Motorcycle noise regulation

TAMPERING WITH NOISE CONTROL SYSTEM PROHIBITED:

Federal law prohibits the following acts or the causing thereof: (1) The removal or rendering inoperative by any person other than for purposes of maintenance, repair, or replacement of any device or element of design incorporated into any new vehicle for the purpose of noise control prior to its sale or delivery to the ultimate purchaser or while it is in use or (2) the use of the vehicle after such device or element of design has been removed or rendered inoperative by any person.

“AMONG THOSE ACTS PRESUMED TO CONSTITUTE TAMPERING ARE THE ACTS LISTED BELOW”.

These acts include tampering with the following systems; i.e., modification, removal, etc.

Exhaust system

- Muffler
- Exhaust pipe
- Silencer

Intake system

- Air cleaner case
- Air cleaner element
- Intake duct

CONSUMER INFORMATION

EAU38051

YAMAHA MOTOR CORPORATION, U.S.A. OFF-ROAD MOTORCYCLE LIMITED WARRANTY

Yamaha Motor Corporation, USA hereby warrants that new Yamaha off-road motorcycles purchased from an authorized Yamaha motorcycle dealer in the continental United States will be free from defects in material and workmanship for the period of time stated herein, subject to certain stated limitations. Covered off-road motorcycles are those units certified by Yamaha to EPA noise regulations and come equipped from the factory with USDA-FS approved spark arresters.

THE PERIOD OF WARRANTY for Yamaha off-road motorcycles shall be ninety (90) days from the date of purchase, with no mileage limitation.

PRODUCT EXCLUDED FROM WARRANTY include those used for non-Yamaha-authorized renting, leasing, or other commercial purposes.

DURING THE PERIOD OF WARRANTY any authorized Yamaha motorcycle dealer will free of charge, repair or replace, at Yamaha's option, any part adjudged defective by Yamaha due to faulty workmanship or material from the factory. Parts used in warranty repairs will be warranted for the balance of the product's warranty period. All parts replaced under warranty become property of Yamaha Motor Corporation, USA.

GENERAL EXCLUSIONS from this warranty shall include any failures caused by:

- a. Competition or racing use.
- b. Installation of parts or accessories that are not qualitatively equivalent to genuine Yamaha parts.
- c. Abnormal strain, neglect, or abuse.
- d. Lack of proper maintenance.
- e. Accident or collision damage.
- f. Modification to original parts.
- g. Damage due to improper transportation.

SPECIFIC EXCLUSIONS from this warranty shall include parts replaced due to normal wear or routine maintenance.

THE CUSTOMER'S RESPONSIBILITY under this warranty shall be to:

1. Operate and maintain the motorcycle as specified in the appropriate Owner's Manual, and
2. Give notice to an authorized Yamaha motorcycle dealer of any and all apparent defects within ten (10) days after discovery, and make the motorcycle available at that time for inspection and repairs at such dealer's place of business.

WARRANTY TRANSFER: To transfer the warranty from the original purchaser to any subsequent purchaser(s), it is imperative that the motorcycle be inspected and registered for warranty by an authorized Yamaha motorcycle dealer. In order for this warranty to remain in effect, this inspection and registration must take place within ten (10) days after transfer of ownership to the subsequent purchaser. A reasonable dealer imposed fee may be charged for this inspection.

EMISSION CONTROL SYSTEM WARRANTY

Yamaha Motor Corporation, USA also warrants to the ultimate purchaser and each subsequent purchaser of each 2006 and later model Yamaha motorcycle covered by this warranty that the vehicle is designed, built, and equipped so as to conform at the time of sale with all U.S. emissions standards applicable at the time of manufacture and that it is free from defects in materials and workmanship which would cause it not to meet these standards within the period listed immediately below. Failures other than those resulting from defects in material or workmanship which

arise solely as a result of owner abuse and/or lack of proper maintenance are not covered by this warranty.

All Off-Road Models

Thirty (30) months from the original purchase date

YAMAHA MOTOR CORPORATION, USA MAKES NO OTHER WARRANTY OF ANY KIND, EXPRESSED OR IMPLIED. ALL IMPLIED WARRANTIES OF MERCHANTABILITY AND FITNESS FOR A PARTICULAR PURPOSE WHICH EXCEED THE OBLIGATIONS AND TIME LIMITS STATED IN THIS WARRANTY ARE HEREBY DISCLAIMED BY YAMAHA MOTOR CORPORATION, USA AND EXCLUDED FROM THIS WARRANTY.

SOME STATES DO NOT ALLOW LIMITATIONS ON HOW LONG AN IMPLIED WARRANTY LASTS, SO THE ABOVE LIMITATION MAY NOT APPLY TO YOU. ALSO EXCLUDED FROM THIS WARRANTY ARE ANY INCIDENTAL OR CONSEQUENTIAL DAMAGES INCLUDING LOSS OF USE. SOME STATES DO NOT ALLOW THE EXCLUSION OR LIMITATION OF INCIDENTAL OR CONSEQUENTIAL DAMAGES, SO THE ABOVE EXCLUSION MAY NOT APPLY TO YOU.

THIS WARRANTY GIVES YOU SPECIFIC LEGAL RIGHTS, AND YOU MAY ALSO HAVE OTHER RIGHTS WHICH VARY FROM STATE TO STATE.

YAMAHA MOTOR CORPORATION, USA
Post Office Box 6555
Cypress, California 90630

WARRANTY QUESTIONS AND ANSWERS

- Q. What costs are my responsibility during the warranty period?
- A. The customer's responsibility includes all costs of normal maintenance services, non-warranty repairs, accident and collision damages, and oil, oil filters, air filters, spark plugs, and brake shoes.
- Q. What are some examples of "abnormal" strain, neglect, or abuse?
- A. These terms are general and overlap each other in areas. Specific examples include: Running the machine out of oil, sustained high-rpm, full-throttle, operating the machine with a broken or damaged part which causes another part to fail, damage or failure due to improper or careless transportation and or tie down. If you have any specific questions on operation or maintenance, please contact your dealer for advice.
- Q. Does the warranty cover incidental costs such as towing or transportation due to a failure?
- A. No. The warranty is limited to repair of the machine itself.
- Q. May I perform any or all of the recommended maintenance shown in the Owner's Manual instead of having the dealer do them?
- A. Yes, if you are a qualified mechanic and follow the procedures specified in the Owner's and Service Manual. We do recommend, however, that items requiring special tools or equipment be done by Yamaha Motorcycle dealer.
- Q. Will the warranty be void or cancelled if I do not operate or maintain my new motorcycle exactly as specified in the Owner's Manual?
- A. No. The warranty on a new motorcycle cannot be "voided" or "cancelled." **However, if a particular failure is caused by operation or maintenance other than as shown in the Owner's Manual, that failure may not be covered under warranty.**
- Q. What responsibility does my dealer have under this warranty?
- A. Each Yamaha Motorcycle dealer is expected to:
1. Completely set up every new machine before sale.
 2. Explain the operation, maintenance, and warranty requirements to your satisfaction at the time of sale, and upon your request at any later date.
 3. Each Yamaha Motorcycle dealer is held responsible for his setup, service and warranty repair work.
- Q. Is the warranty transferable to second owners?
- A. Yes. The remainder of the existing warranty can be transferred upon request. The unit has to be inspected and re-registered by an authorized Yamaha Motorcycle dealer for the policy to remain effective.

CUSTOMER SERVICE

If your machine requires warranty service, you must take it to any authorized Yamaha Motorcycle dealer within the continental United States. Be sure to bring your warranty registration card or other valid proof of the original date of purchase. If a question or problem arises regarding warranty, first contact the owner of the dealership. Since all warranty matters are handled at the dealer level, this person is in the best position to help you. If you are still not satisfied and require additional assistance, please write:

YAMAHA MOTOR CORPORATION U.S.A.
CUSTOMER RELATIONS DEPARTMENT
P.O. Box 6555
Cypress, California 90630

When contacting Yamaha Motor Corporation, U.S.A. don't forget to include any important information such as names, addresses, model, V.I.N. (frame number), dates, and receipts.

CHANGE OF ADDRESS

The federal government requires each manufacturer of a motor vehicle to maintain a complete, up-to-date list of all first purchasers against the possibility of a safety-related defect and recall. This list is compiled from the purchase registrations sent to Yamaha Motor Corporation, U.S.A. by the selling dealer at the time of your purchase.

If you should move after you have purchased your new motorcycle, please advise us of your new address by sending a postcard listing your motorcycle model name, V.I.N. (frame number), dealer number (or dealer's name) as it is shown on your warranty card, your name and new mailing address. Mail to:

YAMAHA MOTOR CORPORATION, U.S.A.
P.O. Box 6555
Cypress, California 90630
Attention: Warranty Department

This will ensure that Yamaha Motor Corporation, U.S.A. has an up-to-date registration record in accordance with federal law.

YAMAHA EXTENDED SERVICE (Y.E.S.)

Keep your Yamaha protected even after your warranty expires with genuine Yamaha Extended Service (Y.E.S.).

- Y.E.S. is designed and administered by Yamaha Motor Corporation to provide maximum owner satisfaction. You get uninterrupted factory-backed coverage for extra peace of mind.
- Y.E.S. is flexible. You choose the plan that's right for you: 12 months, 24 months, 36 months or, on certain models, even 48 months beyond your warranty period.
- Y.E.S. is designed and administered by the same Yamaha people who handle your warranty – and it shows in the comprehensive coverage benefits. There are no mileage limitations. Coverage isn't limited to “moving parts” or the “drive train” like many other plans. And Y.E.S. covers manufacturing defects just like the warranty. See the sample contract at your Yamaha dealer to see how comforting uninterrupted factory-backed protection can be.
- You don't have to pay anything for covered repairs. There's no deductible to pay, and repairs aren't “pro-rated.” You don't have any “out-of-pocket” expenses for covered repairs.
- In addition, Travel and Recreation Interruption Protection (TRIP) is included at no extra cost. TRIP gives you up to \$150 reimbursement per occurrence for any reasonable expenses you incur because your Yamaha needs covered service: replacement vehicle rental, emergency towing, phone calls, even food and lodging when you are away from home. This superb coverage goes into effect when you purchase Y.E.S., so it applies to any warranty repairs as well as covered repairs during your entire Y.E.S. plan period.
- Y.E.S. coverage is honored at any authorized Yamaha dealer nationwide.
- Y.E.S. coverage is transferable to a new owner if you sell or trade-in. That can make your Yamaha much more valuable!

This excellent Y.E.S. plan coverage is only available to Yamaha owners like you, and only while your Yamaha is still within the Yamaha Limited Warranty period. So visit your authorized Yamaha dealer to get all the facts. He can show you how easy it is to protect your investment with Yamaha Extended Service.

CONSUMER INFORMATION

We urge you to act now. You'll get the excellent benefits of TRIP coverage right away, and you'll rest easy knowing you'll have strong factory-backed protection even after your Yamaha Limited Warranty expires.

A special note:

If visiting your dealer isn't convenient, contact Yamaha with your Primary ID number (your frame number). We'll be happy to help you get the Y.E.S. coverage you need.

Yamaha Service Marketing
P.O. Box 6555
Cypress, CA 90630
1-(866)-YES-EXTD (1-866-937-3983)



YAMAHA



EXTENDED



SERVICE

INDEX

A

- Acceleration and deceleration..... 6-2
- Air filter element, cleaning..... 7-9
- Autolube pump, adjusting 7-17

B

- Brake lever, front..... 4-2
- Brake lever, rear 4-3
- Brake levers, lubricating..... 7-17
- Brake shoes, checking..... 7-16
- Braking..... 6-2

C

- Cables, checking and lubricating 7-16
- Carburetor, adjusting 7-11
- Care 8-1
- Centerstand, checking and lubricating.... 7-18

E

- Engine break-in..... 6-3
- Engine idling speed..... 7-11
- Engine oil 4-5
- Engine, starting a warm 6-1
- Engine stop switch..... 4-1

F

- Front and rear brake lever free play,
adjusting 7-15
- Front fork, checking 7-18
- Fuel 4-3
- Fuel cock..... 4-5
- Fuel tank breather hose 4-5
- Fuel tank cap 4-3

H

- Handlebar switch 4-1

I

- Identification numbers..... 10-1

K

- Kickstarter..... 4-6

L

- Location of important labels..... 1-1

M

- Maintenance and lubrication, periodic 7-4
- Maintenance, emission control system..... 7-3
- Matte color, caution 8-1
- Middle and final gear cases 7-9
- Model label 10-1

N

- Noise regulation..... 10-2

P

- Parking..... 6-4
- Part locations 3-1
- Power reduction plate, removing 7-7
- Pre-operation check list 5-2

S

- Safety information..... 2-1
- Seat 4-7
- Spark arrester, cleaning..... 7-10
- Spark plug, checking 7-6
- Specifications..... 9-1
- Speed limiter and power reduction plate ... 4-1
- Starter (choke) lever 4-6
- Starting and warming up a cold engine 6-1
- Starting off 6-2
- Steering, checking 7-19
- Storage 8-3

T

- Throttle cable free play, checking 7-12
- Throttle grip and cable, checking and
lubricating..... 7-17
- Tires..... 7-12

- Tool kit..... 7-2
- Transmission oil 7-8
- Troubleshooting..... 7-24
- Troubleshooting chart..... 7-25

V

- Vehicle identification number 10-1

W

- Warranty, extended 10-5
- Warranty, limited 10-3
- Wheel bearings, checking 7-19
- Wheel (front)..... 7-19
- Wheel (rear) 7-21
- Wheels 7-14

PROTECT YOUR INVESTMENT
Use Genuine YAMAHA Parts And Accessories.

***See your Authorized YAMAHA Dealer for a Genuine YAMAHA
Service Manual.***



YAMAHA MOTOR CO., LTD.

PRINTED ON RECYCLED PAPER

PRINTED IN JAPAN
2008.4-0.7x1 
(E)

Free Manuals Download Website

<http://myh66.com>

<http://usermanuals.us>

<http://www.somanuals.com>

<http://www.4manuals.cc>

<http://www.manual-lib.com>

<http://www.404manual.com>

<http://www.luxmanual.com>

<http://aubethermostatmanual.com>

Golf course search by state

<http://golfingnear.com>

Email search by domain

<http://emailbydomain.com>

Auto manuals search

<http://auto.somanuals.com>

TV manuals search

<http://tv.somanuals.com>