



POWER AMPLIFIER

PX10

PX8

PX5

PX3

Reference Manual

Contents

Introduction **3**

Features	3
Manuals for PX amplifier	3
Usage examples	4
Use with two full-range speakers	4
Use with a full-range speaker and subwoofer	4
Use with a full-range speaker driven in bi-amp mode	5
Use for driving a subwoofer with a stereo signal	5
PX amplifier available system configurations	6
Signal processing in PX amplifier	7
Input sensitivity and amplifier gain	7

Controls and functions **8**

Front panel	8
Rear panel	9

Setup **10**

Setup procedure	10
Rack mounting	11
Speaker connection	11
Connecting to the [SPEAKERS] terminal	11

Panel Operation **12**

Basic operation	12
Basic mode and Advanced mode	12
Screen structure	13
Alert messages	14
Panel lock	14
HOME screen	15

CONFIG VIEW screen	16
MENU screen	17
MENU screen types	17
Operation	17
Operation tree	18
CONFIG WIZARD screen (Basic mode)	20
SP TYPE (speaker type)	20
SP SERIES (speaker series)	20
SP MODEL (speaker model)	20
HPF (high pass filter)	21
LPF (low pass filter)	21
X-OVER (crossover)	21
CONFIRMATION	21
CONFIG WIZARD screen (Advanced mode)	22
WIZARD MODE	22
SP TYPE (speaker type)	22
ROUTING	23
SENS./GAIN (input sensitivity/amplifier gain)	24
SP SERIES (speaker series)	24
SP MODEL (speaker model)	24
SP IMPEDANCE (speaker impedance)	24
CONFIRMATION	24
TUNING screen	25
D-CONTOUR	25
DELAY	26
X-OVER (crossover)	26
HPF (high pass filter)	27
LPF (low pass filter)	27
POLARITY (speaker polarity)	28
SP DELAY	28
EQ (6 Band PEQ)	29
LEVEL (output level)	29
LIMITER	30

CHANNEL LINK	30
CHANNEL COPY	30
SAVE/LOAD	31
AMP PRESET screen	32
RECALL	32
STORE	32
CLEAR	32
TITLE	33
PROTECT	33
UTILITY screen	34
PANEL SETUP	34
PANEL LOCK	34
HOME SCREEN (HOME screen)	35
IMPORT SP PRESET (import speaker preset)	35
DEVICE BACKUP	36
DEVICE INFORMATION	36
INITIALIZE	36
LOG	37
Initializing the PX amplifier	37

Reference **39**

Function list	39
Message list	42
Troubleshooting	44
General specifications	46
Block diagram	48
Dimensions	49
Current draw and thermal dissipation	50
Index	54

Introduction

Thank you for your purchase of the Yamaha PX10, PX8, PX5 or PX3 power amplifier. Please read through this manual carefully before using for the first time, in order to take full advantage of your PX power amplifier's superlative features and enjoy trouble-free operation for years to come.

- Please read the Precautions in the PX10/PX8/PX5/PX3 Owner's Manual before use.
- The illustrations as shown in this manual are for instructional purposes only.
- The company names and product names used in this manual are the trademarks or registered trademarks of their respective companies.
- In this manual, the PX10, PX8, PX5 and PX3 power amplifier models are referred to collectively as "PX amplifier."
- Unless specified otherwise, the example illustrations used in this manual are taken from the PX10.
- The bitmap fonts used in this instrument have been provided by and are the property of Ricoh Co., Ltd.

Features

- Maximum output of 1,000W (PX10), from an exceptionally lightweight chassis.
- Yamaha's proprietary Class-D and processing technologies provide superb sound quality and high reliability.
- Speaker presets that allow you to get the best possible performance from Yamaha speakers.
- A wide variety of DSP functions, including D-CONTOUR processing.
- Configuration Wizard that allows easy, optimal configuration for any speaker system.
- Broad range of input/output connectors.

Manuals for PX amplifier

- **Owner's Manual (included with the product)**
Explains installation and basic operation.
- **Reference Manual (this file)**
Explains all required matters for setup and operation.
- **Technical Specifications (included with the product)**
Describes detailed specifications such as numerical values, dimensions, etc.

Usage examples

PX amplifiers can be used for various applications.

■ Use with two full-range speakers

This conventional application inputs stereo L/R signals to each channel (A/B) for stereo reproduction with two speakers.

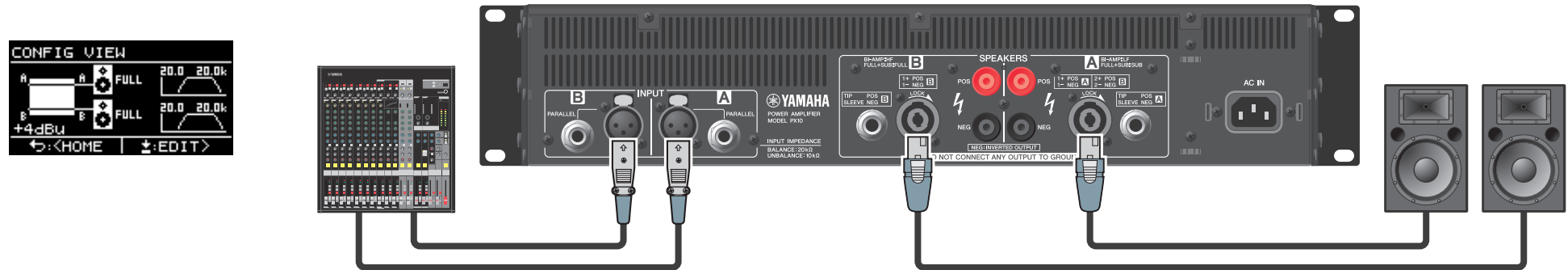

■ Use with a full-range speaker and subwoofer

The input signal is divided into separate frequency ranges for driving a full-range speaker and subwoofer.

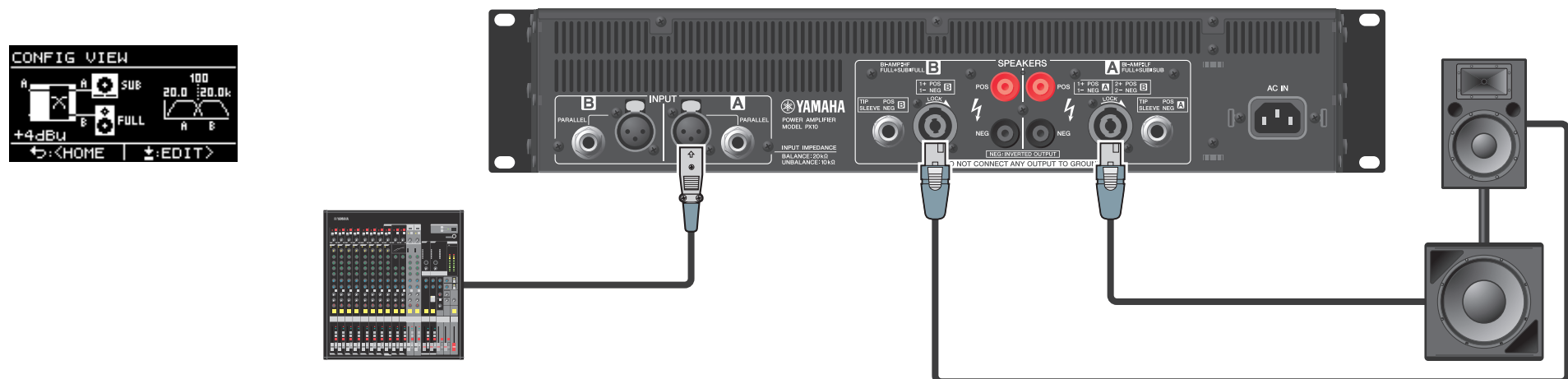

■ Use with a full-range speaker driven in bi-amp mode

The input signal is divided into separate frequency ranges for driving a two-way full-range speaker in bi-amp mode.

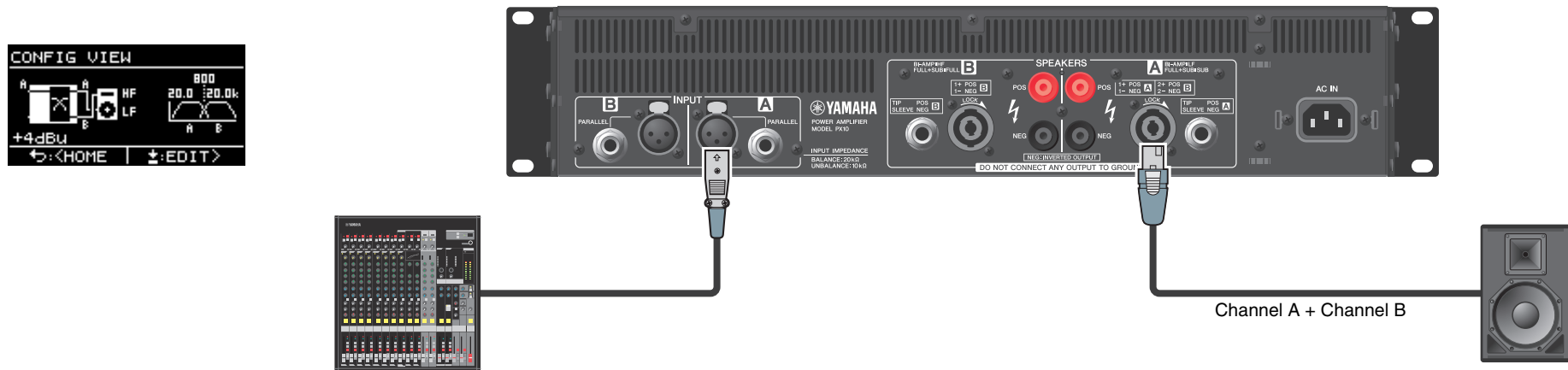

■ Use for driving a subwoofer with a stereo signal

Stereo input signals drive a subwoofer in Power Boost mode (PX5 and PX3 only)

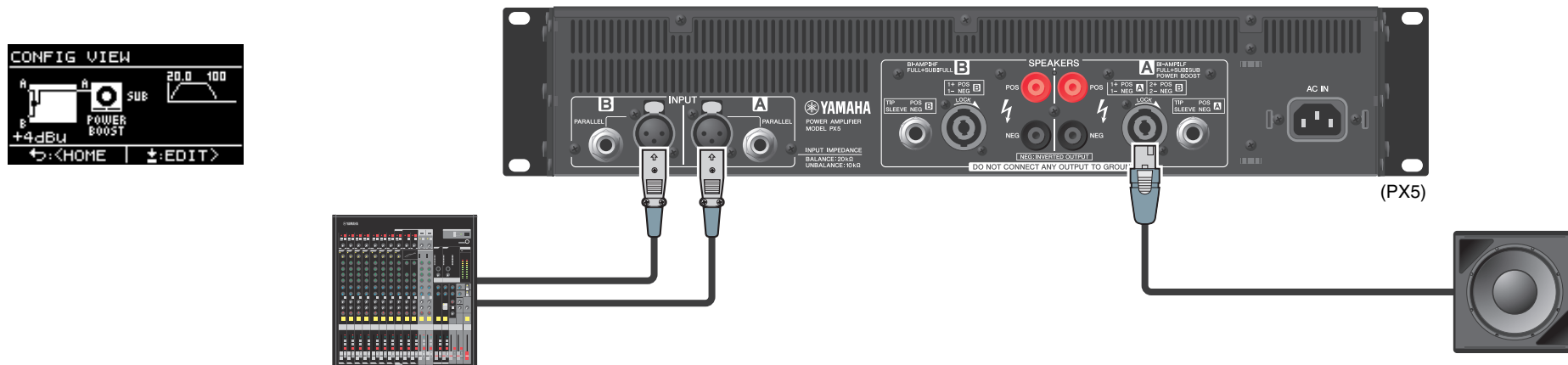

■ PX amplifier available system configurations

PX amplifier can be used with the following 15 types of system configurations, including the examples above.

		Input configuration (routing)				
		Dual mode DUAL	Parallel mode PARALLEL	Single mode SINGLE	Sum mode SUM	
		Channel A and channel B are independent.	After dividing channel A input signal to channel A and channel B, the signal is processed.	After processing channel A input signal, the signal is divided to A and channel B.	Mixes input signals from channel A and channel B.	
Output combination (speaker type)	Two full-range speakers FULL+FULL					
	Two subwoofers SUB+SUB					
	A full-range speaker and a subwoofer FULL+SUB					
	A full-range speaker driven in bi-amp mode BI-AMP					
	Full-range speaker FULL (MONO)	Power Boost mode				
	Subwoofer SUB (MONO)					

NOTE

In Power Boost mode, the two-channel amplifiers are used as one-channel, high-power amplifier (PX5 and PX3 only).

■ Signal processing in PX amplifier

The PX amplifier gives you comprehensive control over the sound with input processors and speaker processors. The signals from the input connectors are processed in input processors equipped in each input connectors. The processed signals are added or divided depending on the set routing, processed finally with the speaker processor in each channel, and output from the [SPEAKERS] terminals.

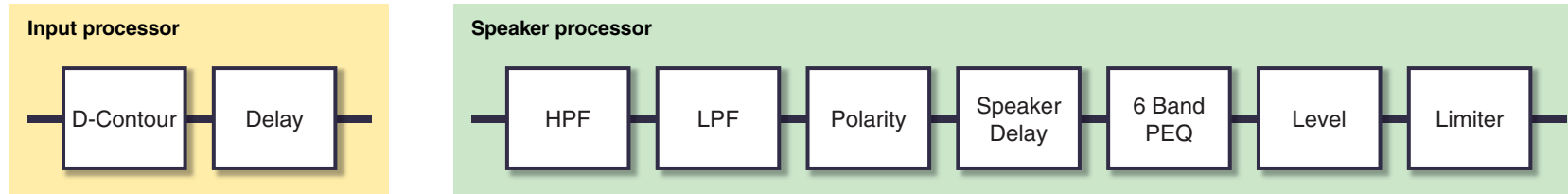

Refer to “TUNING screen” (page 25) in “Panel Operation” for details on the processing.

■ Input sensitivity and amplifier gain

The PX amplifier specifies the input sensitivity/amplifier gain from two input sensitivities or two amplifier gains. Input sensitivity controls the input signal level so that the amplifier can output the maximum power. If signals over the input sensitivity are input, the built-in limiter of the PX amplifier is activated. If the volume is lowered, the input sensitivity rises and the amplifier gain declines. Maximum power is constant if the volume is lowered.

For example, if the amplifier gain on the PX10 is set to 32 dB, the input sensitivity is +9.3 dBu and the maximum output power is 1,000 W (if speaker impedance is 8Ω). When the volume is not lowered (0 dB), output power of 1,000 W results with +9.3 dBu input.

When the volume on the PX10 is lowered to 6 dB, the input sensitivity is +15.3 dBu (9.3 dBu + 6 dBu) and the amplifier gain is 26 dB (32 dB - 6 dB). If a +15.3 dBu signal is input, maximum output power of 1,000 W is gained.

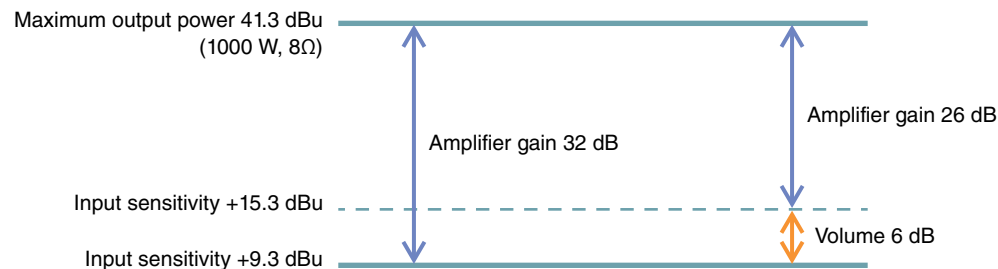

Controls and functions

Front panel



1 Power button

Turns the power to the unit on or off.

⚠ WARNING

To ensure that high-volume noise is not output from the speakers, power-on the equipment starting with the audio sources, then the mixer and processors, and finally the amplifiers. Reverse this order when turning the system off.

2 [POWER] indicator

Lights when the power is on.

3 [ALERT] indicator

Lights when a problem in the device is detected, and continues to light until the cause of the problem is solved.

NOTE

Details of the problem are shown on the display (8).

Selecting the [I] icon on the “HOME screen” (page 15) with the main knob calls up the operating log.

4 [USB] indicator

Lights when a compatible USB flash drive is inserted into the [USB] terminal.

Flashes when the USB flash drive is being accessed.

NOTICE

Do not unplug the USB flash drive while the [USB] indicator is flashing. Doing so may cause data in the PX amplifier or USB flash drive to be corrupted or lost.

5 [CLIP/LIMIT] indicator

Lights when the limiter is operating to protect the amplifier and the speaker, or when the input signal overflows in the digital circuit or clips at the amplifier output.

6 [SIGNAL] indicator

Lights when the output is greater than -60 dB of maximum output level (8 ohms).

7 [PROTECT] indicator

Lights when the protection circuit is operating.

8 Display

Displays the status of the PX amplifier and setting menus. For details, refer to “Screen structure” (page 13).

9 [MENU] key

Press this to move to the top MENU screen.

10 [↶] (Back) key

Press this to move up to the immediately higher menu level or previous display. Press and briefly hold the key to return the HOME screen.

11 Main knob

Rotate this to change the value of parameters and move the position of cursor. Press the knob to actually enter the set value or enable the selected item.

12 [A]/[B] key

Press this to change the values of parameters and move the cursor position.

NOTE

Press the main knob and [A] key to change the mute status of channel A. Press the main knob and [B] key to change the mute status of channel B.

13 [USB] terminal

Insert a USB flash drive to read/load the data from/to the PX amplifier.

NOTICE

When the [USB] terminal is not used, attach the included USB cap to protect the terminal.

NOTE

The [USB] terminal is used in the following cases:

- Loading speaker preset: [IMPORT SP PRESET \(page 35\)](#)
- Writing operation log: [LOG \(page 37\)](#)
- Device backup: [DEVICE BACKUP \(page 36\)](#)
- Saving/loading SP TUNING DATA: [SAVE/LOAD \(page 31\)](#)

14 Volume knob

Adjusts the level from -∞ dB to 0 dB.

If “ROUTING” is set to something other than “DUAL,” adjust the output balance with the volume knob of channel B.

15 Intake ports

Air intakes for the cooling fan. Make sure to not block these ports.

NOTE

- The settings can be changed so that the display and indicators turn off automatically when panel is not operated (Black-out mode). To activate the Black-out mode, select “ON” in [UTILITY screen—PANEL SETUP screen—BLACKOUT screen \(page 34\)](#). Keep in mind that the [POWER] indicator, [ALERT] indicator, [CLIP/LIMIT] indicator, and [PROTECT] indicator all remain lit even if the device is in the Black-out mode.
- For the protection of the display, even if the Black-out mode is not active, the display automatically turns off if the PX amplifier has not been operated for 20 minutes. To turn on the display again, simply press any key on the front panel or rotate the main knob.

Rear panel

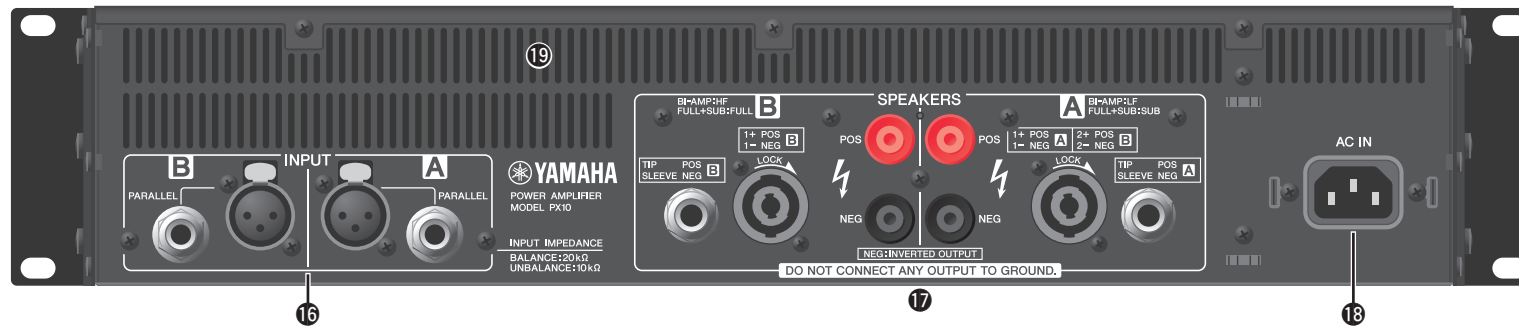

16 [INPUT] A/B connectors

Two types of input connectors are provided for both channels A and B. In Single mode or Parallel mode, the input connectors of channel A are used.

• XLR jack

XLR type 3-31 jack.

The polarity is shown below (IEC60268).

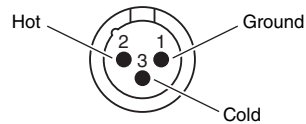

• Phone jack

Balanced TRS phone jack.

The polarity of the connections is shown below.

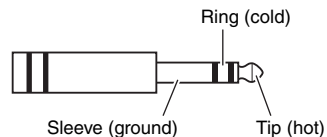

NOTE

The XLR input jack and the phones input jack of each channel are connected in parallel. The signal input from an XLR jack can be output from the phone jack and input to another amplifier. Only one of the jacks can be used as an input jack at one time; the signals from the jacks cannot be mixed.

17 [SPEAKERS] A/B terminals

Output terminals for speakers. Three types are available (below).

- Neutrik NL4MD speakON connector
- Binding post connector
- Phone jack

NOTICE

- Do not touch the terminals or metal parts of cords connected to the terminal. If connecting speakers to multiple connectors of the same channel results in a parallel connection, make sure that the total impedance of the speakers to be connected is not excessively low.
- The PX amplifier adopts BTL (Balanced Transformer Less) amplifier circuits. Connecting both terminals of channel A and channel B and contact between the terminal and the chassis may cause a failure or malfunction. Be careful not to connect or contact the two by mistake.

NOTE

In Power Boost mode, the output terminals of channel A are used (PX5/PX3 only).

18 [AC IN] connector

Connect the supplied AC power cord. First connect the AC power cord to the connector on the amplifier, and then plug it into an appropriate AC power outlet. Secure the AC power cord with the AC plug clamp to prevent accidental disconnection from the connector.

Installing the AC plug clamp

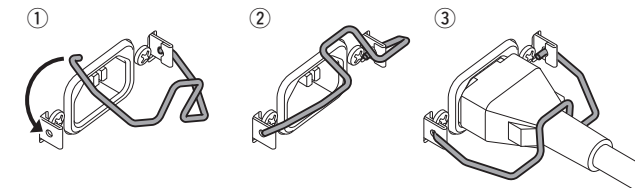

19 Exhaust ports

Exhaust vents for the cooling fan. Make sure to not block these ports.

Setup

Setup procedure

1. Set the PX amplifier in the desired location.

If the device is to be mounted in a rack, refer to “[Rack mounting](#)” (page 11).

2. Lower the two volume knobs to the minimum.

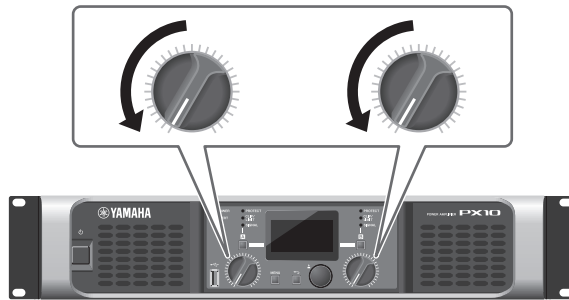

3. Connect speakers to the [SPEAKERS] terminals.

Refer to “[Speaker connection](#)” (page 11).

4. Connect outputs from sources, such as a mixer, to the [INPUT] connectors.

5. Connect the power cord to the [AC IN] connector.

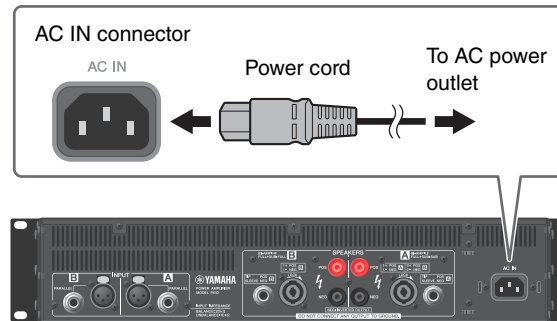

Secure the AC power cord with the AC plug clamp to prevent accidental disconnection from the connector.

Installing the AC plug clamp

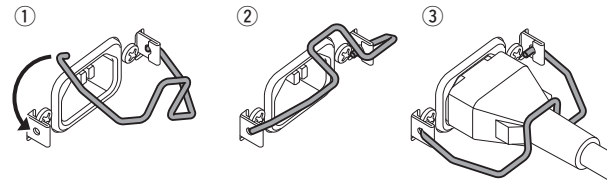

6. Turn on the device.

⚠ WARNING

To ensure that high-volume noise is not output from the speakers, power-on the equipment starting with the audio sources, then the mixer and processors, and finally the amplifiers. Reverse this order when turning the system off.

7. Set up the system configuration with the Configuration Wizard.

Though the PX amplifier can be used as a normal amplifier by simply setting the volume knobs properly, using the Configuration Wizard to make settings enhances the performance of speakers.

Refer to “[CONFIG WIZARD screen \(Basic mode\)](#)” (page 20) or “[CONFIG WIZARD screen \(Advanced mode\)](#)” (page 22).

8. Rotate the volume knob to adjust the volume.

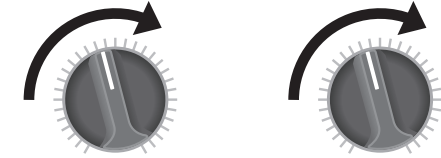

9. Control the tone in TUNING screen.

Refer to “[TUNING screen](#)” (page 25). In this condition, the device is available.

Rack mounting

The PX amplifier can be mounted in an EIA standard rack (2U size).

Precautions for rack mounting

This device is rated for operation at ambient temperatures ranging from 0° to 40°C. When mounting the device with other device(s) in an EIA standard equipment rack, internal temperatures can exceed the specified upper limit, resulting in impaired performance or failure. When rack mounting the device, always observe the following requirements to avoid heat buildup:

- When mounting the unit in a rack with devices such as power amplifiers that generate a significant amount of heat, leave more than 1U of space between the device and other equipment. Also, either leave the open spaces uncovered or install appropriate ventilating panels to minimize the possibility of heat buildup. Multiple PX amplifiers can be mounted by stacking vertically.
- To ensure sufficient airflow, leave the rear of the rack open and position it at least 10 centimeters from walls or other surfaces. If the rear of the rack cannot be left open, install a commercially available fan or similar ventilating option to secure sufficient airflow. If you have installed a fan kit, there may be cases in which closing the rear of the rack will produce a greater cooling effect. Refer to the rack and/or fan unit manual for details.

Speaker connection

■ Connecting to the [SPEAKERS] terminal

⚠ CAUTION

Make sure that the power is turned off, to avoid the danger of electrical shock.

● Binding post connector

• Without plugs

Remove about 15 mm of insulation from the end of each speaker cable, pass the bare wire through the holes in the appropriate speaker terminals, and tighten the terminals to securely clamp the wires. Make sure that the bare wire ends do not jut out from the terminals and touch the chassis.

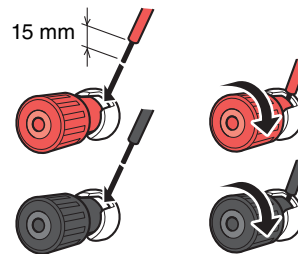

• Y-plugs

From above, insert the Y-plugs all the way into the opening, and tighten the terminal.

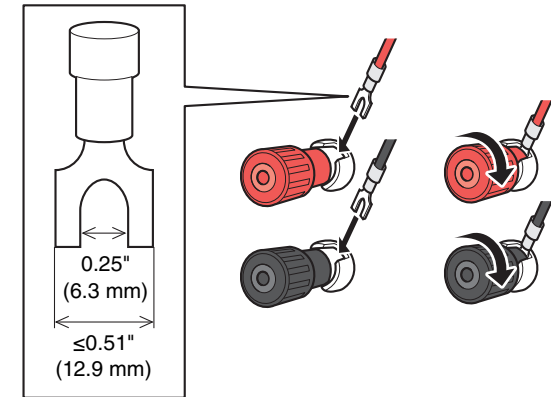

● speakON connector

Insert the speakON cable plug (Neutrik NL4) into the connector, and turn it to the right to lock it.

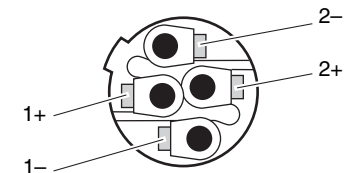

Channel A

Neutrik NL4	PX amplifier
1+	A+
1-	A-
2+	B+
2-	B-

Channel B

Neutrik NL4	PX amplifier
1+	B+
1-	B-
2+	(not connected)
2-	(not connected)

Panel Operation

Basic operation

Basic mode and Advanced mode

The PX amplifier provides two setting methods: Basic mode and Advanced mode. Basic mode is convenient since it lets you use the device quickly and easily with minimum settings. Advanced mode is used when you want to set parameters in detail. Each mode has a HOME screen and MENU screen.

Example of screens

HOME screen (Basic mode)



MENU screen (Advanced mode)



- To switch between Basic mode and Advanced mode

1. Press the [MENU] key to enter the MENU screen.



2. Rotate the main knob to select the tab of the desired mode, and then press the main knob.

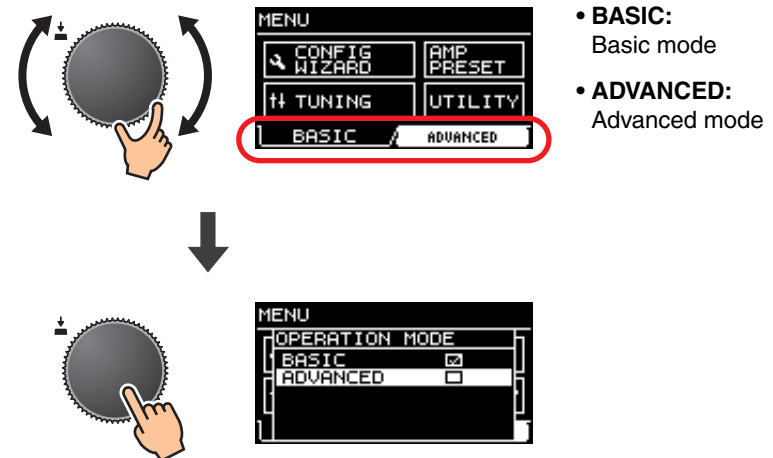

Screen structure

The screens of the PX amplifier differ depending on the selected mode, Basic or Advanced. The HOME screen and the CONFIG WIZARD screen in the MENU screen are in both modes, but displayed items differ. To switch between the modes, use the OPERATION MODE screen in the MENU screen.

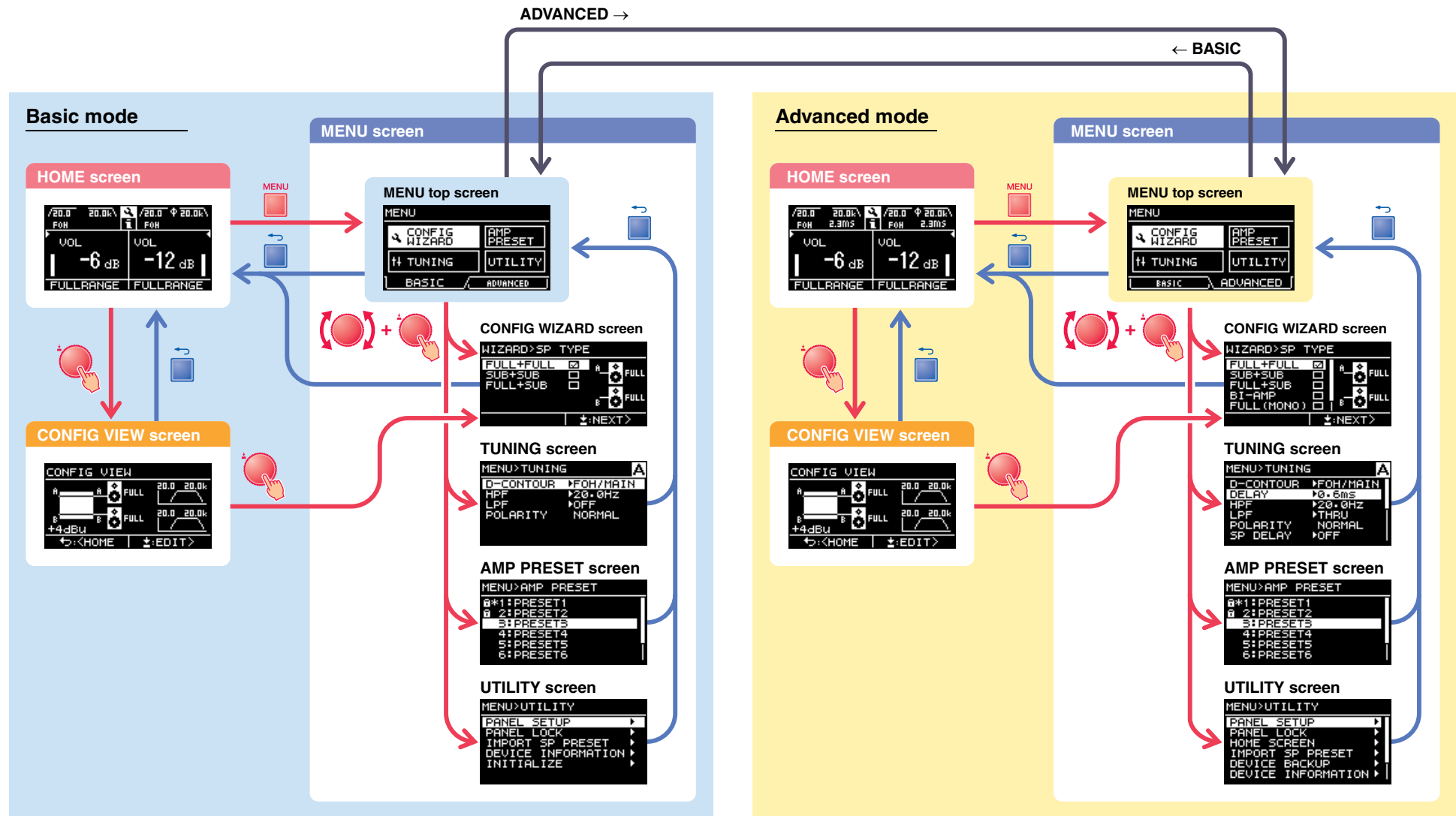

Alert messages

If an abnormality occurs in the PX amplifier, the [ALERT] indicator lights and an alert message appear on the display. Refer to the “Message list” (page 42) at the end of the book for details on each alert.



Panel lock

To prevent changes being made to the PX amplifier by mistake, use the panel lock function. This allows you to set a PIN code (a 4-digit identification number).

Refer to “UTILITY screen” – “PANEL LOCK” (page 34) for instructions.

● To release the panel lock

If the panel controls are operated while the panel is locked, the following message appears in the display.

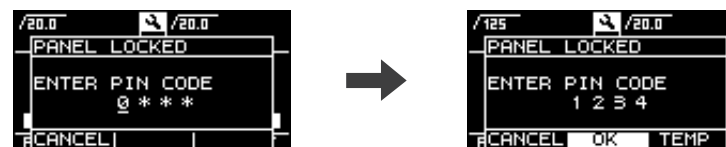

To release the panel lock, input the PIN code by rotating the main knob, select “OK,” and then press the main knob.

NOTE

- To release the panel lock temporarily, select “TEMP.” If “TEMP” is selected, the panel will be locked after turning off and turning on again.
- If a PIN code has been set, input the appropriate PIN code (set previously).

NOTE

If the volume knob is operated when the panel is locked with “ALL,” the following screen appears when the lock is released. Rotate the volume knob to match the actual value. The value of the volume cannot be changed unless the values match.

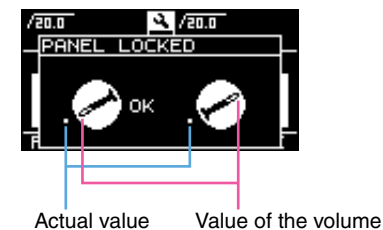

HOME screen

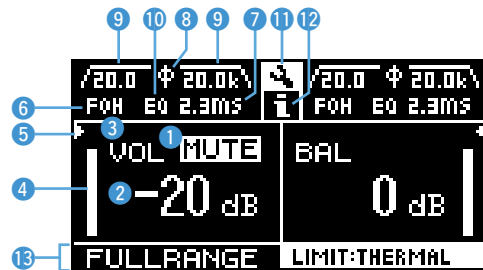

① Mute indication

Appears when the signal is muted.

② Volume indication

Shows the settings of the volume knobs.

In Power Boost mode, only channel A setting is shown.

③ VOL/BAL/GAIN indication

Shows what appears at the volume indications (②).

- **VOL:** Input volume
- **BAL:** Output balance
- **GAIN:** Total level (gain from the input jack to the speaker output terminal)

NOTE

Displayed content depends on the input configuration (routing).

- In Dual mode: Input volume at both channels A and B.
- Other than Dual mode: Input volume at channel A, output balance at channel B. (In Power Boost mode, only channel A is shown.)

Set at “dB VALUE” (page 35) in UTILITY screen—HOME SCREEN screen, which is shown in VOL/BAL/GAIN indication, input volume or total gain.

④ Level meter

Shows input or output level.

NOTE

Input and output can be switched from [HOME SCREEN] (page 35) in the UTILITY screen.

⑤ Threshold indication

Indicates the thresholds of the limiter on the output level of the speaker processors with “▶” and “◀” while the level meter shows the input level.

⑥ D-CONTOUR indication

Shows the status of D-CONTOUR.

- **OFF:** Nothing appears.
- **FOH/MAIN:** “FOH” appears.
- **MONITOR:** “MONI” appears.

⑦ Delay indication

Shows the delay time. When delay is off, nothing appears.

⑧ Polarity indication

Appears when the polarity is inverted.

⑨ Filter indication

Shows the cutoff frequency of the filter. When the filter is off, nothing appears.

⑩ EQ indication

Appears when the EQ is on.

⑪ CONFIG VIEW icon

CONFIG VIEW screen appears when selecting the icon by rotating the main knob and pressing it.

⑫ [F] icon

Operation log appears when selecting the icon by rotating the main knob and pressing it. Refer to “Operation log indication” (page 37) for details on the operation log.

⑬ Speaker name, clipping/limiting message

Normally, this shows the name of the speaker that is connected, along with a related message if clipping or limiting has occurred.

NOTE

The displayed speaker name is the speaker preset recalled with the Configuration Wizard.

NOTE

Rotate the main knob to select the group of D-CONTOUR, delay, polarity and filter indications, and then press the main knob to call up the TUNING screen.

CONFIG VIEW screen

Called up by pressing the main knob when the HOME screen is shown.
The current settings are listed.

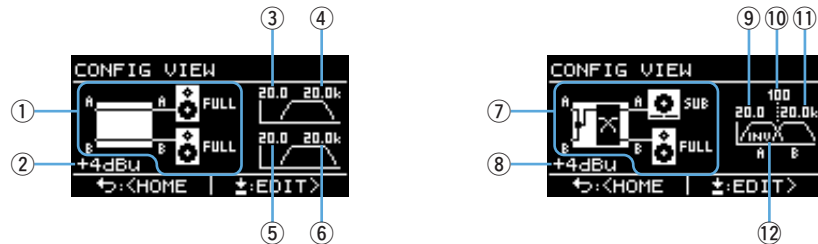

- ① **System configuration:** [page 6](#)
- ② **Input sensitivity/amplifier gain:** [page 24](#)
- ③ **HPF cutoff frequency for channel A:** [pages 21, 27](#)
- ④ **LPF cutoff frequency for channel A:** [pages 21, 27](#)
- ⑤ **HPF cutoff frequency for channel B:** [pages 21, 27](#)
- ⑥ **LPF cutoff frequency for channel B:** [pages 21, 27](#)
- ⑦ **System configuration:** [page 6](#)
- ⑧ **Input sensitivity/amplifier gain:** [page 24](#)
- ⑨ **HPF cutoff frequency for channel A:** [pages 21, 27](#)
- ⑩ **Crossover frequency:** [pages 21, 26](#)
- ⑪ **LPF cutoff frequency for channel B:** [pages 21, 27](#)
- ⑫ **Polarity:** [page 28](#)

To return to the HOME screen, press the [↶] (back) key.

To call up the CONFIG WIZARD screen, press the main knob when the CONFIG VIEW screen appears.

MENU screen

Sets the basic condition of the device.



■ MENU screen types

The following MENU screens are available.

- CONFIG WIZARD screen (Basic mode) (Advanced mode)
- TUNING screen
- AMP PRESET screen
- UTILITY screen

NOTE

Refer to the "Function list" (page 39) for details on configurable items in each MENU screen.

■ Operation

● To display the MENU screen:

Press the [MENU] key in the HOME screen.



● To move to the lower layer in MENU screens, or to select a parameter or other item:

Rotate the main knob to move to the desired item, and then press the main knob.

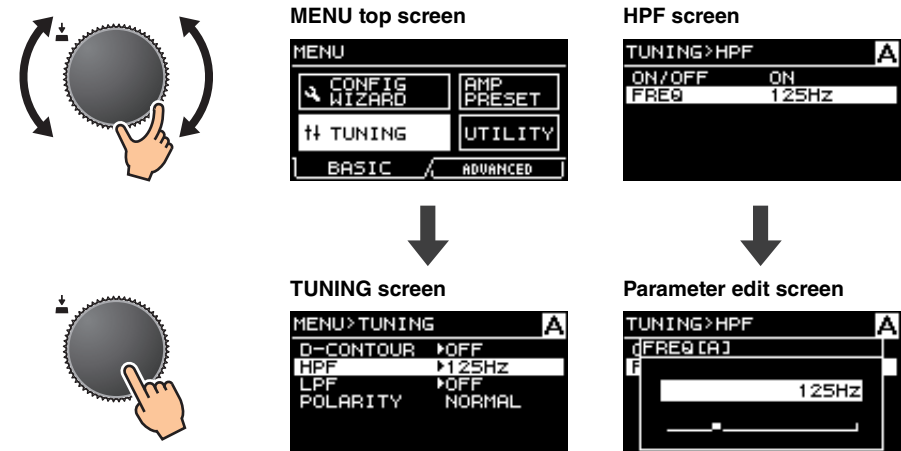

● To move to the upper layer in MENU screens:

Press the [↶] (back) key.



NOTE

The layer of the displayed screen is shown at the top of the screen.

● To return to the HOME screen:

Press and hold the [↶] (back) key.



■ Operation tree

Category	Subcategory	Function	Basic mode	Advanced mode	Details
CONFIG WIZARD (Basic mode)	SP TYPE	Selects a combination of speakers for connection.	✓		page 20
	SP SERIES	Selects a series of speakers for connection.	✓		page 20
	SP MODEL	Selects a speaker for connection.	✓		page 20
	HPF	Selects the cutoff frequency of the HPF. Common to channels A and B.	✓		page 21
	LPF	Selects a cutoff frequency of the LPF. Common to channels A and B.	✓		page 21
	X-OVER	Selects a crossover frequency of the full-range speaker and the subwoofer.	✓		page 21
	CONFIRMATION	Applies the set value.	✓		page 21
CONFIG WIZARD (Advanced mode)	WIZARD MODE	Selects the editing method: changing the current setting or making a new setting.		✓	page 22
	SP TYPE	Selects a combination of speakers for connection.		✓	page 22
	ROUTING	Selects the route of the input signal.		✓	page 23
	SENS./GAIN	Sets the input sensitivity or the amplifier gain.		✓	page 24
	SP SERIES	Selects a series of speakers for connection.		✓	page 24
	SP MODEL	Selects a speaker for connection.		✓	page 24
	SP IMPEDANCE	Sets the impedance of the speaker for connection.		✓	page 24
	CONFIRMATION	Applies the set value.		✓	page 24
TUNING	D-CONTOUR	Sets the frequency character appropriately for usage of the speaker for connection.	✓	✓	page 25
	DELAY	Sets the delay time to compensate the distance between speakers.		✓	page 26
	X-OVER	Sets the crossover frequency.	✓	✓	page 26
	HPF	Sets the high pass filter.	*	✓	page 27
	LPF	Sets the low pass filter	*	✓	page 27
	POLARITY	Set the polarity.	✓	✓	page 28
	SP DELAY	Sets the delay time of the speaker processor.		✓	page 28
	EQ	Edits 6 Band PEQ settings.		✓	page 29
	LEVEL	Sets the output level.		✓	page 29
	LIMITER	Sets the limiter.		✓	page 30
	CHANNEL LINK	Links the parameter setting of channels A and B.		✓	page 30
	CHANNEL COPY	Copies settings between channels.		✓	page 30
	SAVE/LOAD	Saves or loads SP TUNING DATA via a USB flash drive.		✓	page 31

* Only for some functions.

Category	Subcategory	Function	Basic mode	Advanced mode	Details
AMP PRESET	RECALL	Recalls a setting.	✓	✓	page 32
	STORE	Stores the setting.	✓	✓	page 32
	CLEAR	Clears the setting.	✓	✓	page 32
	TITLE	Edits the title of the setting.	✓	✓	page 33
	PROTECT	Protects the setting against inadvertent changes.	✓	✓	page 33
UTILITY	PANEL SETUP	Sets the front panel indication method.	*	✓	page 34
	PANEL LOCK	Sets the panel lock.	✓	✓	page 34
	HOME SCREEN	Sets contents of the HOME screen.		✓	page 35
	IMPORT SP PRESET	Loads speaker preset data stored in the USB flash drive to the PX amplifier.	✓	✓	page 35
	DEVICE BACKUP	Stores all the settings of the PX amplifier or restore the stored settings.		✓	page 36
	DEVICE INFORMATION	Displays the condition in the device.	✓	✓	page 36
	INITIALIZE	Displays how to initialize the data in the PX amplifier on the display.	✓	✓	page 36
LOG	Displays or writes the operating log.		✓	page 37	

* Only for some functions.

CONFIG WIZARD screen (Basic mode)

Using the Configuration Wizard enables you to easily set basic functions.

WARNING

The volume changes depending on the setting. Carry this out with the volume lowered for safety.

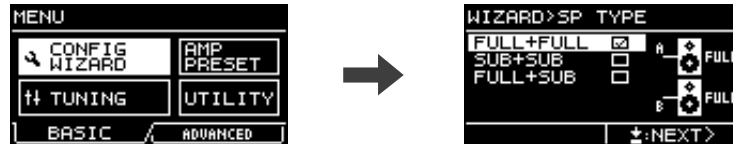

NOTE

Items that can be set differ between Basic mode and Advanced mode. To make detailed settings, switch to Advanced mode. Refer to “[To switch between Basic mode and Advanced mode](#)” (page 12) for switching the mode.

■ SP TYPE (speaker type)

Selects the combination of the speakers for connection.



• **FULL + FULL:**

When connecting full-range speakers to the [SPEAKERS] terminals of both channels A and B.

• **SUB + SUB:**

When connecting subwoofers to the [SPEAKERS] terminals of both channels A and B.

• **FULL + SUB:**

When connecting a full-range speaker to the [SPEAKER] terminal of channel B and a subwoofer to the [SPEAKER] terminal of channel A.

■ SP SERIES (speaker series)

Selects a speaker series for connection from models registered in the PX amplifier.



NOTE

When a speaker is selected, filters, speaker impedance, and threshold of the limiter are set automatically. If the speaker for connection is not in the menu, select “GENERIC.”

■ SP MODEL (speaker model)

Specifies a speaker for connection from the speaker series selected in the SP SERIES screen.

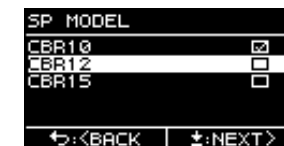

■ HPF (high pass filter) (If “SP SERIES” is “GENERIC”)

Selects the cutoff frequency of the HPF. Common to both channels A and B.



NOTE

In Basic mode, the filter type is fixed to 24 dB/Oct., Butterworth type.

■ LPF (low pass filter) (If “AMP MODE” is “SUB+SUB” and “SP SERIES” is “GENERIC”)

Selects the cutoff frequency of the LPF. Common to both channels A and B.



NOTE

In Basic mode, the filter type is fixed to 24 dB/Oct., Butterworth type.

■ X-OVER (crossover) (If “AMP MODE” is “FULL+SUB” and “SP SERIES” is “GENERIC”)

Selects the crossover frequency of the full-range speaker and subwoofer.



NOTE

In Basic mode, the filter type is fixed to 24 dB/Oct., Linkwitz Riley type.

■ CONFIRMATION

Applies the set value.



After confirming the setting is appropriate, press the main knob to actually apply the set value.

To correct the setting, press the [↶] (back) key to return to the screen to be corrected.

To cancel the setting, press the [MENU] key or press and hold the [↶] (back) key until a confirmation screen appears.

CONFIG WIZARD screen (Advanced mode)

Using the Configuration Wizard here enables you to easily set more advanced functions.

⚠ WARNING

The volume changes depending on the setting. Carry this out with the volume lowered for safety.

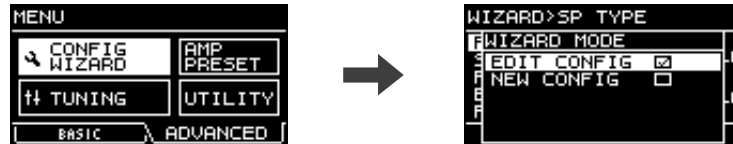

NOTE

To return to a previous parameter setting, press the [↶] (back) key.

■ WIZARD MODE

Select a parameter status to start settings.



- **EDIT CONFIG:**
Changing the current setting
- **NEW CONFIG:**
Making a new setting

■ SP TYPE (speaker type)

Selects a combination of speakers for connection.

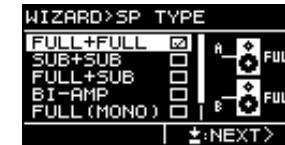

- **FULL+FULL:**
When connecting full-range speakers to the [SPEAKERS] terminals of both channels A and B.
- **SUB+SUB:**
When connecting subwoofers to the [SPEAKERS] terminals of both channels A and B.
- **FULL+SUB:**
When connecting a full-range speaker to the [SPEAKERS] of channel B and a subwoofer to channel A.
- **BI-AMP:**
When connecting low range of a bi-amp speaker to the [SPEAKERS] of channel A and high range to channel B.
- **FULL (MONO):**
When connecting a full-range speaker driven in Power Boost mode to the [SPEAKERS] terminal of channel A (PX5 and PX3 only).
- **SUB (MONO):**
When connecting a subwoofer driven in Power Boost mode to the [SPEAKERS] terminal of channel A (PX5 and PX3 only).

NOTE

Refer to “PX amplifier available system configurations” (page 6) for details on combinations listed in “ROUTING” (page 23).

ROUTING

Selects the route of the input signal from four types: DUAL, PARALLEL, SINGLE, and SUM.



DUAL (Dual mode):

Sends the input signal from channel A to speaker A, and sends the input signal from channel B to speaker B.

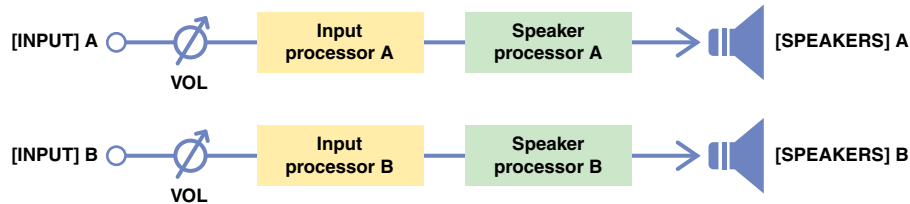

PARALLEL (Parallel mode):

Sends the input signal from channel A to both speaker A and speaker B. Channel A and channel B can be set differently.

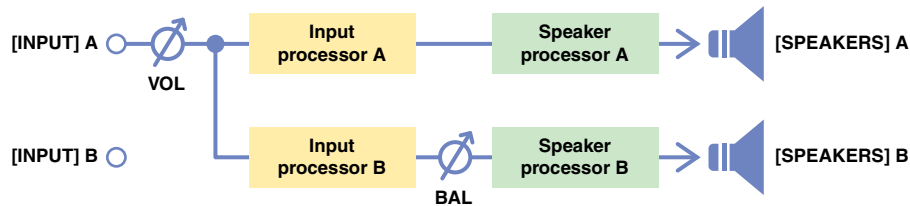

SINGLE (Single mode):

Sends only the input signal from channel A.

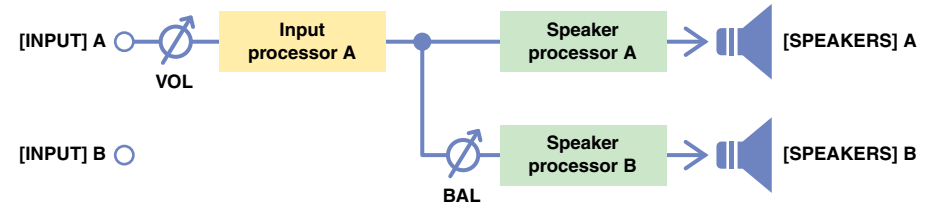

SUM (Sum mode):

Mixes and sends the input signals from channel A and channel B.

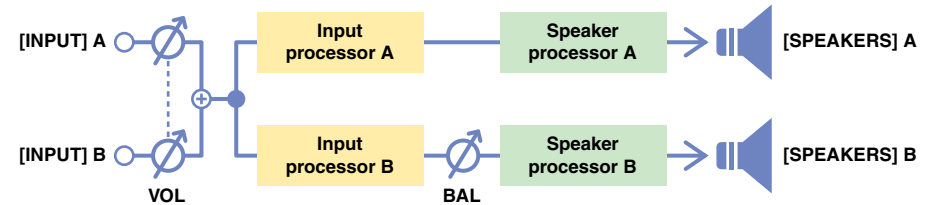

NOTE

The volume knob is available only for control of channel A. The volume of channel B is linked to that of channel A.

NOTE

- Depending on the SP TYPE (speaker type, [page 22](#)), the menu choices may be limited. For details, refer to “PX amplifier available system configurations” ([page 6](#)).
- Regarding input processors and speaker processors, refer to “Signal processing in PX amplifier” ([page 7](#)). For setting instructions, refer to “TUNING screen” ([page 25](#)).

■ SENS./GAIN (input sensitivity/amplifier gain)

Sets the input sensitivity or the amplifier gain.

You can select the input sensitivity(+4 dBu or +14 dBu), or the amplifier gain (26 dB or 32 dB).



NOTE

Refer to “Input sensitivity and amplifier gain” (page 7) for details on input sensitivity and amplifier gain.

■ SP SERIES (speaker series)

Selects a speaker series for connection from models registered in the PX amplifier.



NOTE

When a speaker is selected, filters, speaker impedance, and threshold of the limiter are set automatically. If the speaker for connection is not in the menu, select “GENERIC.”

■ SP MODEL (speaker model)

Specifies a speaker for connection from the speaker series selected in SP SERIES screen.

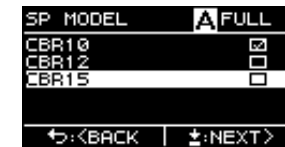

■ SP IMPEDANCE (speaker impedance) (If “SP SERIES” is “GENERIC”)

Sets the impedance of the speaker for connection.

When connecting speakers in parallel, set this parameter by a single speaker's impedance.



■ CONFIRMATION

Applies the set value.



After confirming the setting is appropriate, press the main knob to actually apply the set value.

To change or correct the setting, press the [↶] (back) key to return to the previous screen.

To cancel the setting, press the [MENU] key or press and hold the [↶] (back) key until a confirmation screen appears.

TUNING screen

Set input processors and speaker processors for acoustic adjustment.

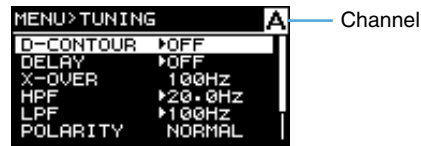

● Input processor and speaker processor

Input processor



Speaker processor



NOTE

- If “A” or “B” appears in a parameter setting screen at the upper side in TUNING screen, the parameter is for the respective channel, A or B.
- Press the [A] key or [B] key to select the desired channel for setting.

■ D-CONTOUR

Sets the frequency character appropriately for usage of the speaker for connection.



Input processor

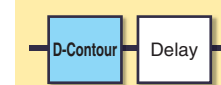

Speaker processor



① MODE

Switches presets of D-CONTOUR. Selects from the following items:

- **OFF:**
Turns off D-CONTOUR.
- **FOH/MAIN:**
Boosts the high and low frequency components so that the frequency response is suitable for main speaker use.
- **MONITOR:**
Reduces the low frequency range, which could otherwise tend to be boomy if the speaker is set directly on the floor. This enables you to hear mid and high frequency ranges clearly when using as a floor monitor.

② DEPTH

Sets the degree of the effect. The larger the value, the deeper the effect.

■ DELAY

(Advanced mode only)

Sets the delay time to compensate the distance between speakers. Sets according to ether time or distance.

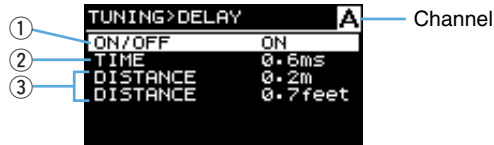

Input processor



Speaker processor

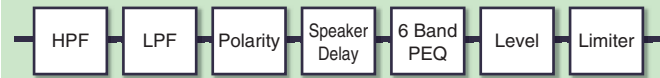

① ON/OFF

Turns the delay on/off.

② TIME [ms]

Sets the delay time in milliseconds.

③ DISTANCE [m / feet]

Sets the delay time by physical distance (in meters or in feet).

NOTE

Three delay time indications change in conjunction.

■ X-OVER (crossover)

(If “SP TYPE” is “FULL+SUB” or “BI-AMP”)

Sets the crossover frequency of channel A and channel B.

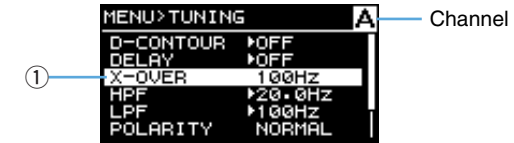

Input processor

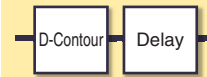

Speaker processor



① X-OVER FREQ.

Sets the crossover frequency. The crossover frequency to be set is the cutoff frequencies of the LPF of channel A and the HPF of channel B.

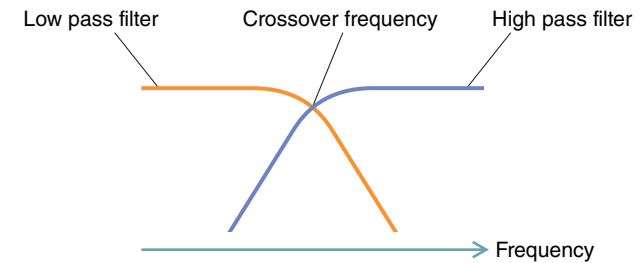

■ HPF (high pass filter)

Sets the high pass filter.

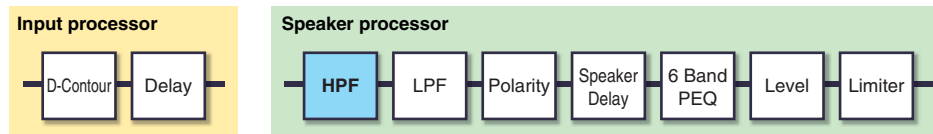
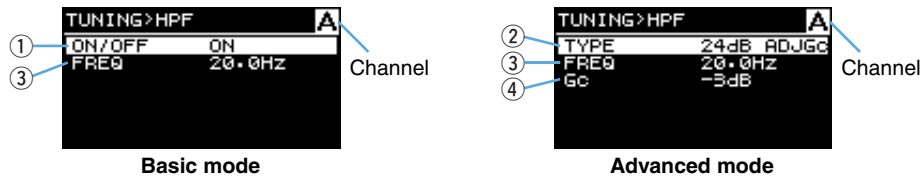

- ① **ON/OFF**
(Basic mode only)
Turn on/off the filter.
- ② **TYPE (filter type)**
(Advanced mode only)
Selects the attenuation per octave and the filter type.

NOTE

- If "THRU" is selected, filter is off.
- A filter on 12 dB/Oct or more can be selected from four types (below): Adjustable Gain Control, Butterworth, Bessel, and Linkwitz Riley.

Filter type	Display
Adjustable Gain Control	ADJGc
Butterworth	BUT
Bessel	BESSL
Linkwitz Riley	L-R

For example, the 12 dB/Oct. Butterworth type is displayed as "12dB BUT."

- ③ **FREQ (Cutoff frequency)**
Sets the cutoff frequency of the HPF.
- ④ **Gc (Cutoff gain)**
(Advanced mode only)
Sets the gain at the cutoff frequency if "AdjustGc" (Adjustable Gc) is selected in "HPF TYPE."

■ LPF (low pass filter)

Sets the low pass filter.

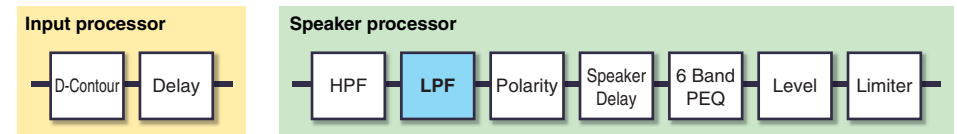
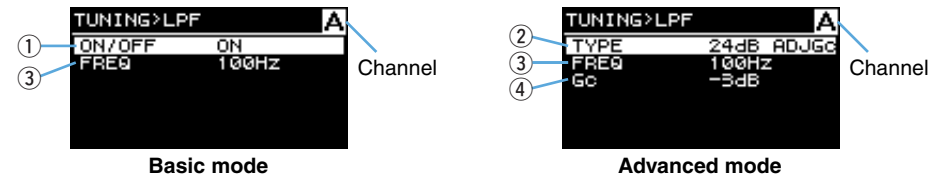

- ① **ON/OFF**
(Basic mode only)
Turns the filter on/off.
- ② **TYPE (filter type)**
(Advanced mode only)
Selects the attenuation per octave and the filter type.

NOTE

- If "THRU" is selected, filter is off.
- A filter of 12 dB/Oct or more can be selected from four types (below): Adjustable Gain Control, Butterworth, Bessel, and Linkwitz Riley.

Filter type	Display
Adjustable Gain Control	ADJGc
Butterworth	BUT
Bessel	BESSL
Linkwitz Riley	L-R

For example, the 12 dB/Oct. Butterworth type is displayed as "12dB BUT."

- ③ **FREQ (Cutoff frequency)**
Sets the cutoff frequency of the LPF.
- ④ **Gc (Cutoff gain)**
(Advanced mode only)
Sets the gain at the cutoff frequency if "AdjustGc" (Adjustable Gc) is selected in "LPF TYPE."

■ POLARITY (speaker polarity)

Sets the polarity in order to avoid volume problems due to phase interference between the speakers.

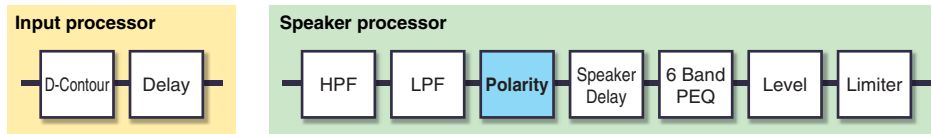

① POLARITY

When “NORMAL” is selected, the polarity is normal; when “INVERTED” is selected, the polarity is inverted.

■ SP DELAY

(Advanced mode only)

Edits the speaker delay time of the speaker processor.
Sets according to either time or distance.

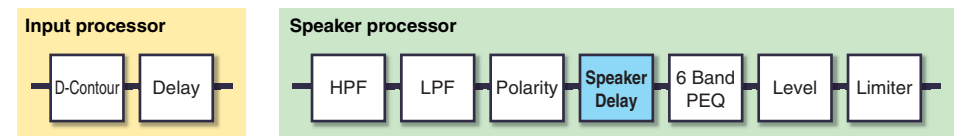
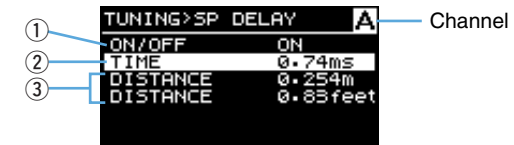

① ON/OFF

Turns the speaker delay on/off.

② TIME [ms]

Sets the delay time in milliseconds.

③ DISTANCE [m / feet]

Sets the delay time by physical distance (in meters or in feet).

NOTE

Three delay time indications change in conjunction.

■ EQ (6 Band PEQ) (Advanced mode only)

Edits 6 Band PEQ parameters of the speaker processor.

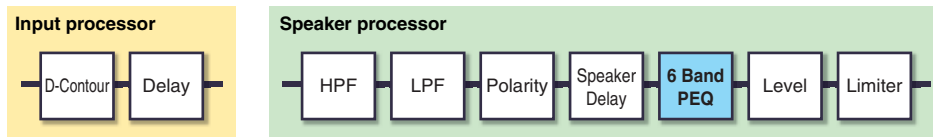
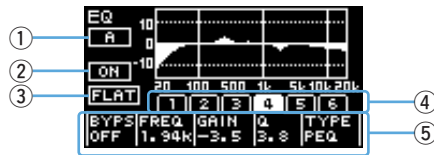

① CHANNEL button

Shows the target channel of the EQ. Use the [A] / [B] keys to select the target channel. When EQ settings are linked, it shows A+B.



Move the cursor to the button and then press the knob to link the EQ settings.

NOTE

The EQ link works independently from the channel link. The EQ link is available for any channel type.

② ON/OFF

Turns the 6 Band PEQ on/off. When set to off, the EQ characteristics display is shown only in outline.

③ FLAT

Sets the gain parameter of all bands to 0 dB.

④ Band 1 – 6

Selects a single Band for calling up the corresponding parameters. Press the knob on the selected band to move the cursor to a parameter area.

⑤ Parameter area

Displays parameters of each Band. Move the cursor to a parameter name, and press the knob to edit the parameter value. Press the [↵] (back) key to return the cursor to the parameter name. Press again to return the cursor to the Band.

■ LEVEL (output level) (Advanced mode only)

Sets the output level to balance the output levels of channels.

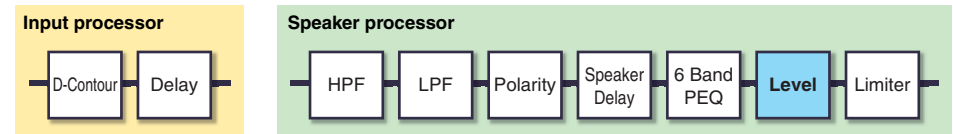

① LEVEL

Sets the output levels in 0.1 dB increments.

■ LIMITER

(Advanced mode only)

For changing the settings of the limiter depending on the speaker specifications, in order to protect the speaker.

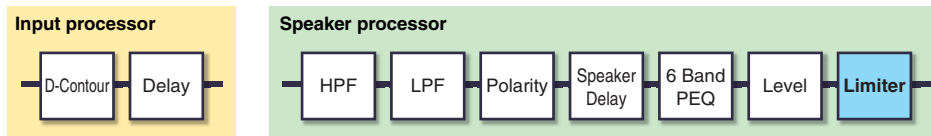

① ON/OFF

Turns the limiter on/off.

② THRESHOLD

Sets the threshold beyond which the limiter is activated according to output power (Watt).

NOTE

- When a speaker is selected with Configuration Wizard, "THRESHOLD" is automatically set.
- When connecting speakers in parallel, set this parameter according to the specified output power for a single speaker.

③ IMPEDANCE (Ω/UNIT)

Sets the impedance of the speaker for connection (8Ω or 4Ω).

When connecting speakers in parallel, set this parameter by a single speaker's impedance.

■ CHANNEL LINK

(Advanced mode only, if "SP TYPE" is "FULL+FULL" or "SUB+SUB")

Links the parameter setting of channel A and channel B.



① ON/OFF

When the setting is changed from off to on, the device initially makes the settings of channel A and channel B identical. If a setting is operated for channel A, the settings of channel A are copied to the settings of channel B. If a setting is operated for channel B, the settings of channel B are copied to the settings of channel A.

■ CHANNEL COPY

(Advanced mode only; when "SP TYPE" is set to "FULL+FULL" or "SUB+SUB")

Copies settings between channels.

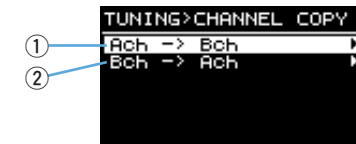

① Ach → Bch

Copies the settings of channel A to channel B.

② Bch → Ach

Copies the settings of channel B to channel A.

■ SAVE/LOAD (Advanced mode only)

You can save/load SP TUNING DATA by using a USB flash drive.

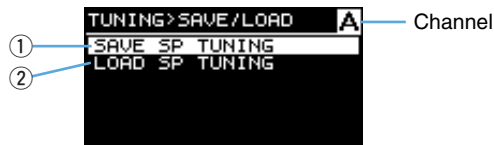

① SAVE SP TUNING

Saves the setting file to the USB flash drive.

Select this menu to display the file name screen. Rotate the main knob to select the position for inputting the character and press the main knob to switch to character entry. Then rotate the main knob to select the character to be input and press the main knob to actually enter it. By pressing the [↵] (back) key in the character entry mode, you can return to position selection. Selecting “OK” in this state confirms the title. Selecting “OK” in the confirmation screen saves the setting file. Finally select “OK” to return to the previous screen.

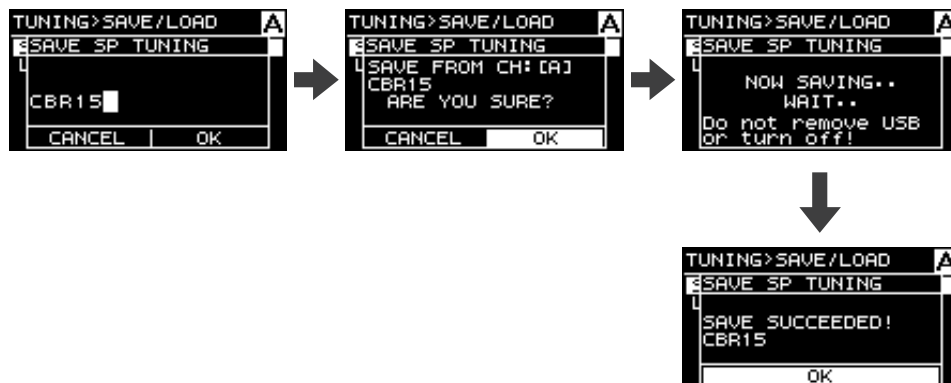

NOTE

- You can enter up to sixteen alphanumeric characters.
- Available characters include ASCII types and some symbols.

② LOAD SP TUNING

Loads the setting file in the USB flash drive.

Select this menu to display the list of files. Rotate the main knob to select a file, and then press the main knob to display the confirmation. Press “OK” to start loading. After loading is complete, a confirmation message will appear. Press “OK” to return to the previous screen.

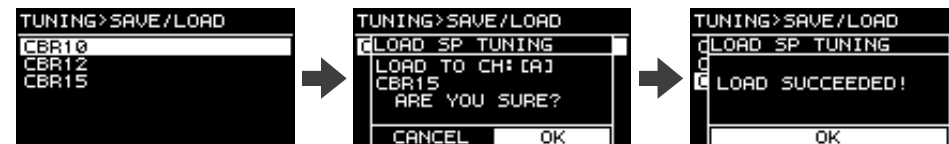

NOTE

- Files which have file name over sixteen characters are not shown in the list.
- File names containing unavailable characters on the PX unit are not displayed.

AMP PRESET screen

PX amplifier settings that are set in CONFIG WIZARD screen and D-CONTOUR screen can be stored as amplifier preset. Eight amplifier presets can be stored in a PX amplifier.

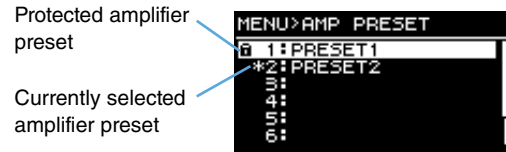

Select the number of the desired amplifier preset by rotating the main knob and pressing it. The operation selection screen appears.



■ RECALL

Recalls a stored amplifier preset. The current speaker preset and the speaker preset of the selected amplifier preset appear.

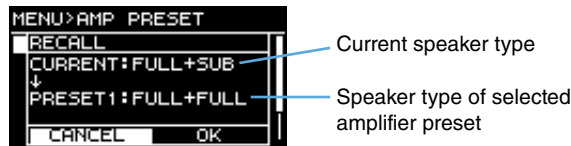

⚠ WARNING

If a speaker type different from the current one is recalled, the volume will change significantly. Carry this out with the volume lowered for safety.

NOTE

The PX10/PX8 cannot recall an amplifier preset stored on the PX5/PX3 in the Power Boost mode.

■ STORE

Stores the current PX amplifier setting to an amplifier preset, and allows you to name it.

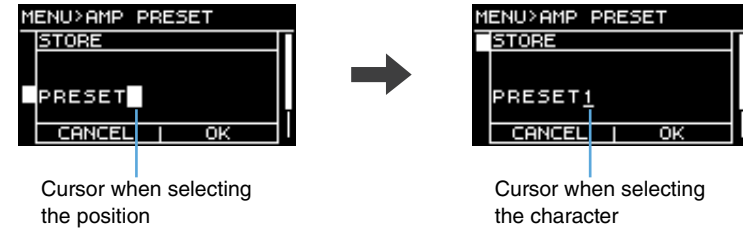

Rotate the main knob to select the position to input the character and press the main knob to switch to character entry. Then rotate the main knob to select the character to be input and press the main knob to actually enter it.

By pressing the [↶] (back) key in the character entry mode, you can return to selecting the position. Selecting “OK” in this state confirms the title.

NOTE

A protected amplifier preset cannot be overwritten.

■ CLEAR

Clears a stored amplifier preset.



NOTE

A protected amplifier preset or the currently selected amplifier preset cannot be cleared.

■ TITLE

Edits a title of a stored amplifier preset.

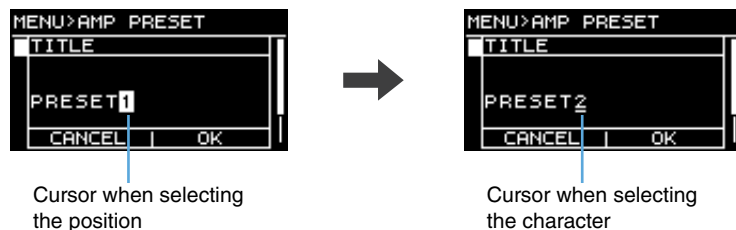

Rotate the main knob to select the position to input the character and press the main knob to switch to character entry. Then rotate the main knob to select the character to be input and press the main knob to actually enter it.

By pressing the [↶] (back) key when selecting the character, you can return to selecting the position. Selecting “OK” in this state confirms the title.

NOTE

The title of a protected amplifier preset cannot be edited.

■ PROTECT

Protects a stored amplifier preset against inadvertent changes. If the parameter is on, the amplifier preset cannot be with the TITLE, CLEAR, and overwriting STORE operations.



UTILITY screen

Sets up the status of PX amplifier, stores data to the USB flash drive, and loads data from the USB flash drive.



■ PANEL SETUP

Sets the front panel indication method.



① BRIGHTNESS

Sets the brightness of the back light of the display.

② BLACKOUT

(Advanced mode only)

If the panel is not operated for 10 seconds, the indication of the display turns off (black out status).

NOTE

- Even if “BLACKOUT” is on, the [POWER], [ALERT], [PROTECT], and [LIMIT] indicators light as usual.
- For the protection of the display, even if “BLACKOUT” is off, the display automatically turns off if the PX amplifier has not been operated for 20 minutes. To turn on the display again, simply press any key on the front panel or rotate the main knob.

■ PANEL LOCK

Sets the panel lock not to operate the PX amplifier by mistake. At that time, a PIN code, 4-digit identification number, can be set.



① PANEL LOCK

Locks the front panel (panel lock). There are three available settings.

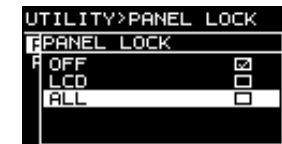

- **OFF:** Panel lock is off.
- **LCD:** Locks operations for indications of the display. Operation of the volume knob and muting are available.
- **ALL:** No operations, except for release of the panel lock, are available.

NOTE

- Refer to “Panel Operation” – “Panel lock” (page 14) for instructions on releasing the panel lock.
- If a PIN code has been set, the PIN code must be entered even when the setting of the panel lock is changed “OFF” to “LCD” or “ALL.”

② PIN CODE

Sets a PIN code (any four digits) for the panel lock. Once a PIN code has been set, the PIN code must be entered to release the panel lock.

NOTE

- If you have forgotten the PIN code, you will need to initialize the device to release the PIN code. Refer to “Initializing the PX amplifier” (page 37) for instructions on initializing.
- In the initialized state, the PIN code is set to “0000.” When the PIN code is set to “0000,” the PIN code input is not needed to release the panel lock.

● To set a PIN code

1. Open the PIN code input screen.

In MENU screen–UTILITY screen–PANEL LOCK screen, select “PIN CODE” (page 34).

The cursor is on the first digit of the PIN code.

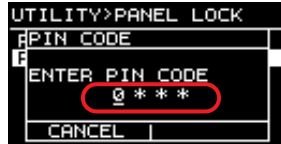

2. Rotate the main knob to select a digit, and then press the main knob to enter it.

After the digit is entered, the cursor moves to the next digit.

3. Enter the subsequent digits in the same way.

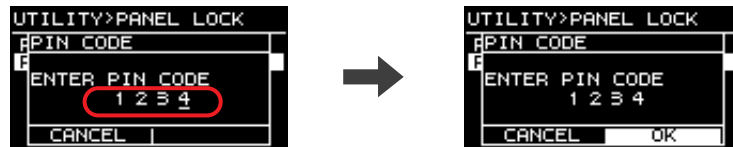

NOTE

While the PIN code is being input, you can correct it by pressing the [↶] (back) key and selecting the desired digit with the main knob.

4. After inputting four digits, press the [OK] key.

The PIN code is entered.



NOTE

If the PIN code is changed to “0000,” the PIN code is not set. In this state, PIN code input is not needed to set or release the panel lock.

■ HOME SCREEN (HOME screen)

(Advanced mode only)

Sets contents of the HOME screen.

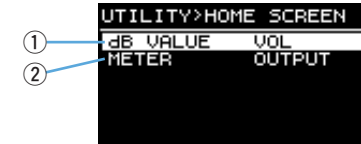

① dB VALUE

Select the value type in the VOL/BAL/GAIN indication in HOME screen (page 15).

- VOL: Input volume
- GAIN: Total level (gain from the input jack to the speaker output terminal)

② METER

Selects the level indicated in the level meter, input signal or output signal.

- INPUT: Input signal level
- OUTPUT: Output signal level

■ IMPORT SP PRESET (import speaker preset)

Imports a speaker preset downloaded and stored in a USB flash drive to the PX amplifier.

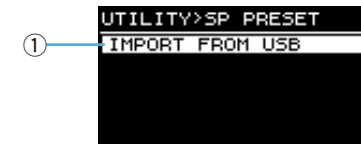

① IMPORT FROM USB

Imports a speaker preset from a USB flash drive.

NOTE

Speaker presets can be downloaded from the Yamaha Pro Audio global website.

■ DEVICE BACKUP

(Advanced mode only)

Save and restore all the settings in a PX amplifier to/from a USB flash drive. Use the function when you want to set multiple PX amplifiers to the same setting, or change to another PX amplifier and keep the same settings.



⚠ WARNING

If a speaker type different from the current one is recalled, the volume will change significantly. Carry this out with the volume lowered for safety.

① SAVE TO USB

Saves all the setting data in the device to a USB flash drive.

② RESTORE FROM USB

Restores setting data stored in a USB flash drive.

NOTE

The PX10/PX8 cannot recall settings stored on the PX5/PX3 in the Power Boost mode.

■ DEVICE INFORMATION

Indicates the internal status of the PX amplifier.

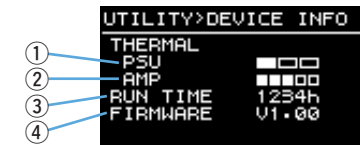

① THERMAL PSU

Indicates the temperature of the power supply unit in three grades. If maximum is indicated, the limiter is active.

② THERMAL AMP

Indicates the temperature of the amplifier unit in five grades. The limiter is active depending on the temperature.

③ RUN TIME

Indicates the total operating time of the device.

④ FIRMWARE

Indicates the version of the firmware.

■ INITIALIZE

Indicates how to initialize the internal data of the PX amplifier.

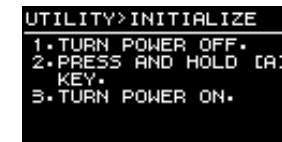

NOTE

Refer to “Initializing the PX amplifier” (page 37) for instructions on initializing.

LOG

(Advanced mode only)

Indicates or saves the operation log in the PX amplifier.

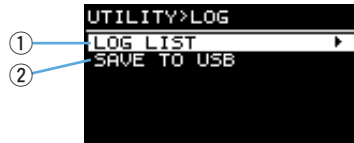

1 LOG LIST

Indicates the overall operation log stored in the PX amplifier.

The log is displayed in the order that events have occurred. The time information is displayed in “NNNN HHH:MM:SS” format, where the format represents the number of hours (HHH)/minutes (MM)/seconds (SS) have elapsed since the (NNNN)th power-on.

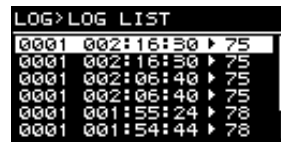

• Operation log indication

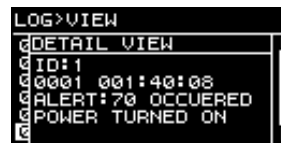

Rotating the main knob (to select an event) and pressing the knob (to actually determine the event) show the detailed view.



NOTE

The Operation log can also be called up by selecting and determining the  icon by using the main knob when the  icon is shown in the HOME screen.

2 SAVE TO USB

Save the latest operation log to a USB flash drive. The function is for user support reference.

Initializing the PX amplifier

There are three ways to initialize the PX amplifier.

• To initialize the current parameters

1. Turn on while pressing the [A] key.



2. Rotate the main knob to select “CONFIG+TUNING” and press the main knob.

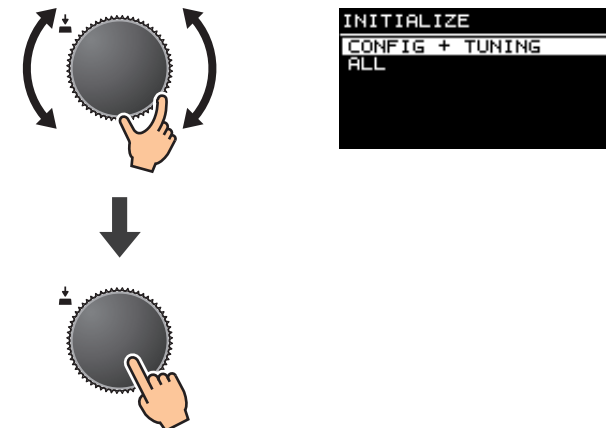

NOTE

Current parameters are parameters set in the CONFIG WIZARD, AMP PRESET, and TUNING screens. For details, refer to “Function list” (page 39).

● To initialize all the user data

1. Turn on while pressing the [A] key.

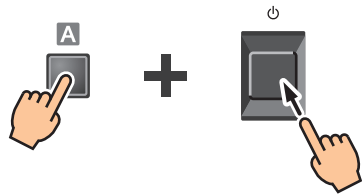

2. Rotate the main knob to select “ALL” and press the main knob.

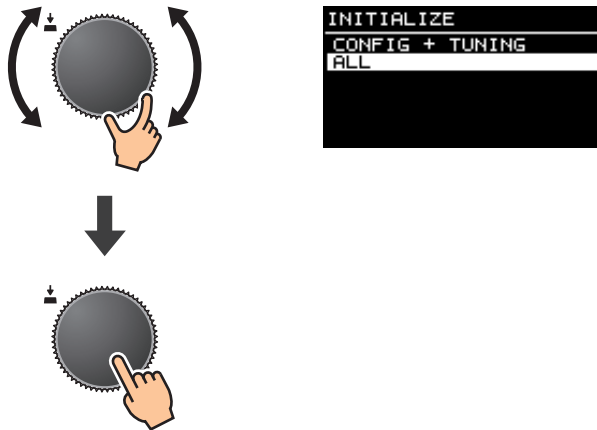

NOTE

- User data are parameters set in the CONFIG WIZARD, AMP PRESET, TUNING, and UTILITY screens. For parameters, refer to “Function list” (page 39).
- PIN code is also initialized.

● To initialize all the user data and speaker preset

Turn on while pressing the [B] key and the [↶] (back) key simultaneously. Screens to confirm the initialization do not appear.

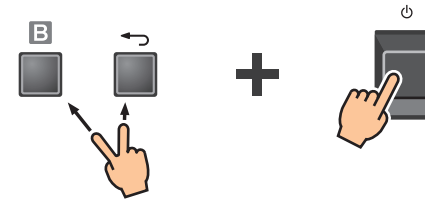

NOTE

The operation log is not deleted.

Reference

Function list

Parameter		Initial value	Basic mode	Advanced mode	Amplifier preset applied	CH LINK/ CH COPY applied	SP TUNING DATA applied	
Configuration	INPUT SENSITIVITY/GAIN		+4 dBu	(Not configurable)	Sensitivity: +4 dBu, +14 dBu Gain: 32 dB, 26 dB	✓	—	
	AMP MODE	SP TYPE	FULL+FULL	<ul style="list-style-type: none"> • FULL+FULL • SUB+SUB • FULL+SUB • FULL+SUB 	<ul style="list-style-type: none"> • FULL+FULL • SUB+SUB • FULL+SUB • BI-AMP • FULL (MONO) POWER BOOST • SUB (MONO) POWER BOOST 			
		ROUTING	DUAL	(Not configurable)	<ul style="list-style-type: none"> • DUAL • PARALLEL • SINGLE • SUM 			
	SPEAKER	IMPEDANCE	8Ω	(Not configurable)	8Ω, 4Ω			
Device	ATT		—	-∞ – 0 dB (31 steps)		—	—	
	MUTE		OFF	OFF, ON				
Input processor	D-CONTOUR	MODE	OFF	OFF, FOH/MAIN, MONITOR		✓	✓	
		DEPTH	5	1 – 10				
	DELAY	ON/OFF	OFF	(Not configurable)	OFF, ON			
		TIME (msec)	0 msec		0 – 74.0 msec			
DISTANCE (meters)		0 m	0 – 25.4 m					
		DISTANCE (feet)	0 ft	0 – 83.4 ft				

Parameter		Initial value	Basic mode	Advanced mode	Amplifier preset applied	CH LINK/ CH COPY applied	SP TUNING DATA applied	
Speaker processor	X-OVER	FREQ.	100 Hz	20.0 Hz – 20.0 kHz		✓	✓	
	HPF	TYPE	24 dB BUT	OFF(THRU), ON (24 dB BUT)	20 types *1			✓
		FREQ.	20 Hz	20.0 Hz – 20.0 kHz				
		Gc	-3 dB	(Not configurable)	-6 dB – +6 dB			
	LPF	TYPE	THRU	OFF(THRU), ON (24 dB BUT)	20 types *1			✓
		FREQ.	20 kHz	20.0 Hz – 20.0 kHz				
		Gc	-3 dB	(Not configurable)	-6 dB – +6 dB			
	POLARITY		NORMAL	NORMAL, INVERTED				✓ (CH COPY only)
	SPEAKER DELAY		OFF	(Not configurable)	0.00 – 5.00 ms 0.000 – 1.716 meter 0.00 – 5.64 feet			✓
	EQ	EQ ON	ON	(Not configurable)	OFF, ON			
		TYPE (x6)	PEQ		10 types *2			
		BYPASS (x6)	OFF		OFF, ON			
		FREQ. (x6)	Each Band *3		20.0 Hz – 20.0 kHz			
		GAIN (x6)	0 dB		-18.0 dB – +18.0 dB			
Q (x6)		4.2	63.0 – 0.1					
LEVEL		0 dB	(Not configurable)	-10 dB – +10 dB	✓ (CH COPY only)			
LIMITER	ON/OFF	OFF	(Not configurable)	OFF, ON	✓			
	THRESHOLD	1500 W		10 – 1500 W				
	SP IMPEDANCE	8Ω		8Ω, 4Ω				
	ATTACK/RELEASE	—		Set in speaker preset				
Utility	PANEL SETUP	BRIGHTNESS	6	1 – 10	—	—		
		BLACKOUT	OFF	(Not configurable)			OFF, ON	
	PANEL LOCK	LOCK	OFF	OFF, ON				
		PIN CODE	0000	4-digit (“0000” if not set)				
	HOME SCREEN	dB VALUE	VOL	(Not configurable)			VOL, GAIN	
	LEVEL METER	OUTPUT	(Not configurable)	INPUT, OUTPUT				

*1: THRU, 6dB/OCT, 12dB ADJGc, 12dB BUT, 12dB BESSL, 12dB L-R, 18dB ADJGc, 18dB BUT, 18dB BESSL, 24dB ADJGc, 24dB BUT, 24dB BESSL, 24dB L-R, 36dB ADJGc, 36dB BUT, 36dB BESSL, 48dB ADJGc, 48dB BUT, 48dB BESSL, 48dB L-R

*2: PEQ, L.SHELF (6dB/Oct), L.SHELF (12dB/Oct), H.SHELF (6dB/Oct), H.SHELF (12dB/Oct), HPF, LPF, APF (1st), APF (2nd), Horn EQ

*3: 31.5 Hz, 100 Hz, 315 Hz, 1.0 kHz, 3.15 kHz, 10.0 kHz

Parameter		Initial value	Basic mode	Advanced mode	Amplifier preset applied	CH LINK/ CH COPY applied	SP TUNING DATA applied	
Others	CH LINK	—	(Not available)	✓	—	—	—	
	AMP PRE- SET	RECALL	—	✓ (Total is 8)		—	—	—
		STORE						
		CLEAR						
		TITLE						
		PROTECT						
	SP PRESET	RECALL (WIZARD)	—	✓		—	—	—
		IMPORT FROM USB						
	DEVICE BACKUP	SAVE TO USB	—	(Not available)	✓	—	—	—
		RESTORE FROM USB						
	DEVICE INFORMA- TION	THERMAL PSU	—	✓		—	—	—
		THERMAL AMP						
		FIRMWARE VERSION						
	LOG	LOGGING	—	✓ (4096)		—	—	—
		LOG LIST		✓				
SAVE TO USB		(Not available)		✓				
INITIALIZE	CONFIG+TUNING	—	✓		—	—	—	
	ALL							
	FACTORY DATA RESET							
FIRMWARE UPDATE	—	—	✓		—	—	—	

Message list

Number	Message	Symptom	Possible solution
01–06	SYSTEM ERROR	The device has not started up correctly.	Turn the power off, and then turn back on after waiting at least 6 seconds. If this does not solve the problem, initialize the memory (page 37). Should this also fail, contact your Yamaha dealer.
07	SP PRESET DATA LOST	The speaker preset file is corrupted.	Load the preset file again from a USB flash drive. If this does not solve the problem, initialize the memory (page 37). Should this also fail, contact your Yamaha dealer.
08	WRONG SP PRESET DATA	The speaker preset data in the device are corrupted. Failure might have occurred in loading a speaker preset file from the USB flash drive.	Load the preset file again from a USB flash drive. If this does not solve the problem, initialize the memory (page 37). Should this also fail, contact your Yamaha dealer.
20	OUTPUT CURRENT OVER [*]	Protection of the circuitry has been enabled in the device because there is: 1) a short at a speaker terminal, amplifier terminal, or wire; or 2) the amplifier load is excessive. (*: channel name)	Make sure that the speakers are not damaged and the total impedance is not too low, and inspect the connection of the speaker cables.
21	AMP TEMP TOO HIGH	The temperature in the amplifier unit of has exceeded the allowed limit. The output load is excessively high. This tends to occur when the load of only channel A is high.	Since continuous high-power output causes high temperatures, lower the output level. If the load is biased on the channel A, disperse the load by connecting to the channel B or other amplifiers. Also, check whether dirt or a foreign object could have clogged the cooling fan, and clean the fan itself if necessary.
22–24	LIMITED BY OVERHEAT	The amplifier temperature is excessively high, and so the limiter for the output has been activated.	Since continuous high-power output causes high temperatures, lower the output level. Also, check whether dirt or a foreign object could have clogged the cooling fan, and clean the fan itself if necessary.
25	MUTED BY OVERHEAT	The amplifier temperature is excessively high, and so the output level has been lowered.	Since continuous high-power output causes high temperatures, lower the output level. Also, check whether dirt or a foreign object could have clogged the cooling fan, and clean the fan itself if necessary.
26–27	POWER SUPPLY TEMP TOO HIGH	The amplifier temperature is excessively high, and so the cooling fan has been set to the maximum speed and the limiter has been activated.	Since continuous use may cause malfunction in the power supply unit, stop using immediately, or lower the output level. Also, check whether dirt or a foreign object could have clogged the cooling fan, and clean the fan itself if necessary.
33	SPEAKER IMPEDANCE TOO LOW [*]	The speaker impedance is excessively low. (*: channel name)	Make sure that the speakers are not damaged and the total impedance is not too low, and inspect the connection of the speaker cables.
50	USB:COMPATIBLE DEVICES NOT FOUND	A USB flash drive has not been installed.	Install an appropriate USB flash drive. Refer to Yamaha Pro Audio global website (http://www.yamahaproaudio.com/) for tested USB flash drive.
51	USB:NO FILE SYSTEM	The file system of the USB flash drive is unreadable.	Use a USB flash drive formatted properly to FAT32 or FAT16.
52	USB:FILE NOT FOUND	The object file has not been found.	Make sure the relevant file is contained in the USB flash drive and try again.
53	USB:ILLEGAL FILE	Illegal file.	Replace with an appropriate file and try again.
54	USB:INCOMPATIBLE FORMAT	Incompatible file format.	Replace with an appropriate file and try again.

Number	Message	Symptom	Possible solution
55	USB:I/O ERROR	Cannot read/write the USB flash drive properly.	Confirm that the USB flash drive you are using works properly with a computer. Use a tested USB flash drive. Refer to Yamaha Pro Audio global website (http://www.yamahaproaudio.com/) for tested USB flash drive. Should this also fail, contact your Yamaha dealer.
56	USB:STORAGE FULL!	The remaining capacity of the USB flash drive is not sufficient.	Make sure the USB flash drive has enough free space.
58	USB:LOAD ERROR	The USB flash drive has been unplugged during access. A failure has occurred in reading files from the USB flash drive. Data in the PX amplifier may be corrupted or lost.	Try again. The [USB] indicator flashes when the USB flash drive is being accessed. Do not unplug the USB flash drive during this time.
65	INCOMPATIBLE DATA LOADED	The recalled preset includes incompatible settings, so the setting has reverted to the default. This also results when a file stored from PX5/PX3 in Power Boost mode has been restored.	—
70	POWER TURNED ON	The device has been turned on.	—
71	POWER TURNED OFF	The device has been turned off.	—
72	SHORT INTERRUPTION	An instantaneous power failure occurred, causing the device to shut down and start up again.	Connect to a stable power supply.
73	FIRMWARE UPDATE COMPLETED	Completed the update of the firmware.	—
74	PANEL UNLOCKED	Released the panel lock.	—
75	SP PRESET RECALLED[*]	Recalled a speaker preset. (*: speaker preset number)	—
76	SP PRESET LOADED	Loaded a speaker preset from the USB flash drive.	—
77	AMP PRESET RECALLED[*]	Recalled an amplifier preset. (*: amplifier preset number)	—
78	AMP PRESET STORED[*]	Stored an amplifier preset. (*: amplifier preset number)	—
79	AMP PRESET CLEARED[*]	Cleared an amplifier preset. (*: amplifier preset number)	—
80	BACKUP DATA LOADED	Loaded setting data from a USB flash drive with "RESTORE FROM USB" in DEVICE BACKUP screen.	—
90	CONFIG+TUNING DATA INITIALIZED	Initialized the configuration and tuning data.	—
91	ALL DATA INITIALIZED	Initialized all the parameter settings.	—
92	FACTORY DATA RESET	Initialized all the speaker presets and parameter settings.	—

Troubleshooting

Symptom	Possible causes	Possible solution
The display automatically turns off if the PX amplifier has not been operated for a while.	For the protection of the display, the display automatically turns off if the PX amplifier has not been operated for 20 minutes.	Press any key on the front panel or rotate the main knob to turn on the display again.
	If the Black-out mode is on, the back light of the display automatically turns off when PX amplifier has not been operated for around 10 seconds.	Press any key on the front panel to turn on the back light of the display. If the Black-out mode is set to off, the back light does not turn off even if the PX amplifier is not operated.
[PROTECT] indicator lights and an "OUTPUT CURRENT OVER" message appears on the display.	There is a short at the speaker terminal, amplifier terminal or wire, and circuit protection has been engaged.	Turn the power off and check for a short in the speaker terminal or amplifier, wire, etc., and turn it on again.
	Since the impedance of the connected speaker is excessively low and the amplifier is overloaded, circuit protection has been engaged.	Check that the speaker has not been damaged and that total impedance is not excessively low, and review the speaker connection.
[PROTECT] indicator lights and "AMP TEMP TOO HIGH" message appears on the display.	Because the internal temperature is excessively high, thermal protection has been engaged to protect the circuit.	Check the amplifier ventilation conditions and take appropriate measures to improve the airflow around the amplifier. Leave the amplifier off until the internal temperature goes down, and then turn it on again.
[CLIP/LIMIT] indicator lights.	Because the input signal is excessive or the output exceeds the rated voltage, the signal is clipped or the limiter has been engaged to protect the circuit.	Lower the output level of the device connected to the input connector, or lower the volume of the amplifier.
Power does not turn on. Power suddenly turned off, and immediately turned off even when turning on again.	The power supply connected outlet is significantly different from the rated range.	Check the source voltage.
	Because the internal temperature is excessively high, thermal protection has been engaged to protect the circuit.	Check the amplifier ventilation conditions and take appropriate measures to improve the airflow around the amplifier. Leave the amplifier off until the internal temperature goes down, and then turn it on again.
	The output level is excessively high.	Lower the output level.
	The device is broken.	After disconnecting the speakers, turn on the device without inputting any signal, or lower the volume completely, turn on the device. If the symptoms do not improve, the device is broken. Contact your Yamaha dealer.
Sound from speakers is distorted.	The input level exceeds the setting of the input sensitivity.	Adjust the input sensitivity to match the input level with the CONFIG WIZARD screen.
The sound is muffled. No high-frequency sound.	The sound is filtered. The filter status can be checked in the HOME screen.	Change the setting of the filters in the MENU screen (TUNING screen).
When "ROUTING" is set to something other than "DUAL," the level of channel B is low.	The volume knob of channel B, with which the output balance to channel A is adjusted, has been lowered.	Raise the volume knob of channel B.

Symptom	Possible causes	Possible solution
No sound from speakers.	Cables are not connected appropriately. If the meter does not rise even if raising the volume knob, there may be problems in connectivity at the input side. If the meter rises, there may problems at the output side.	Connect to input jacks and output terminals appropriately. At the output side, make sure that terminals outputting signals are connected. Refer to “Usage examples” (page 4) for connection instructions.
	The outputs of the mixer connected to the input jacks are lowered. There is a possibility that the meter does not rise even if the volume knob is raised.	Raise the output of the mixer.
	Level has been lowered with the volume knob.	Adjust the volume knob accordingly.
	The mute is on. When the mute is on, “MUTE” appears in the HOME screen.	Turn off the mute.
	The protection circuit has been engaged and the output is muted. When the protection circuit is engaged, the [PROTECTION] indicator lights.	Identify what is causing the protection circuit to engage and solve it.
	The speaker type is Power Boost mode (PX5 and PX3 only).	In Power Boost mode, audio signals are not output from channel B. Cancel Power Boost mode or reconnect the cables.
The panel controls cannot be operated.	The panel lock is turned on.	Turn off the panel lock. Refer to “Panel lock”(page 14) for instructions on turning off the panel lock.
The parameter settings need to be returned to their initial values.	—	Return the settings to the initial values. To do this, refer to “Initializing the PX amplifier” (page 37).
An indicator does not light in a condition in which it normally should light. The display is blank.	The Black-out mode is on.	To temporarily make the indicators light and the display work, operate the panel. To make the indicators light and the display work regularly, turn off the Black-out mode. Refer to “PANEL SETUP” (page 34) in UTILITY screen.
The display is dark.	The “BRIGHTNESS” in PANEL SETUP screen is set to low value.	Set the “BRIGHTNESS” to a higher value.
After starting up again, parameters you’ve edited have returned to the values before editing.	The device was shut down before the current parameters were stored automatically.	When the device is shut down, wait more than 3 seconds after editing current parameters.
Reading or writing from/to a USB flash drive takes a long time.	The USB flash drive contains a number of files. The more files that are contained, the longer time is required.	Delete files the PX amplifier does not need.

* If any specific problem should persist, contact your Yamaha dealer.

General specifications

		PX10	PX8	PX5	PX3
Output Power		120 V 60 Hz, 220 V-240 V 50 Hz/60 Hz			
1 kHz, non-clip, 20 msec burst, both channels driven	8Ω	1000 W × 2	800 W × 2	500 W × 2	300 W × 2
	4Ω	1200 W × 2	1050 W × 2	800 W × 2	500 W × 2
	2Ω	700 W × 2	600 W × 2	500 W × 2	300 W × 2
1 kHz, non-clip, 20 msec burst	8Ω/Power Boost Mode	—	—	800 W × 1	600 W × 1
	4Ω/Power Boost Mode	—	—	1400 W × 1	1000 W × 1
Output Power		100 V 50 Hz/60 Hz			
1 kHz, non-clip, 20 msec burst, both channels driven	8Ω	1000 W × 2	800 W × 2	500 W × 2	300 W × 2
	4Ω	1200 W × 2	1050 W × 2	800 W × 2	500 W × 2
	2Ω	700 W × 2	600 W × 2	500 W × 2	300 W × 2
1 kHz, non-clip, 20 msec burst	8Ω/Power Boost Mode	—	—	800 W × 1	600 W × 1
	4Ω/Power Boost Mode	—	—	1200 W × 1	1000 W × 1
Amplifier Type (Output Circuitry)		Class D, balanced output circuit (BTL)			
THD+N	1 kHz, 10 W	0.1%			
	1 kHz, half power	0.3%			
Frequency Response	1 W, 8Ω, 20 Hz to 20 kHz	±1.0 dB			
Crosstalk	Half power, 8Ω, 1 kHz, vol. max., input 150Ω shunt	≤ -60 dB			
S/N Ratio	A-weighted, 8Ω, gain setting = +14 dBu	101 dB	101 dB	100 dB	100 dB
Voltage Gain/Sensitivity					
8Ω, volume max.	Gain setting: 32 dB	32.0 dB/+9.3 dBu	32.0 dB/+8.3 dBu	32.0 dB/+6.3 dBu	32.0 dB/+4.1 dBu
	Gain setting: 26 dB	26.0 dB/+15.3 dBu	26.0 dB/+14.3 dBu	26.0 dB/+12.3 dBu	26.0 dB/+10.1 dBu
	Gain setting: +4 dBu	37.3 dB/+4 dBu	36.3 dB/+4 dBu	34.3 dB/+4 dBu	32.1 dB/+4 dBu
	Gain setting: +14 dBu	27.3 dB/+14 dBu	26.3 dB/+14 dBu	24.3 dB/+14 dBu	22.1 dB/+14 dBu
8Ω, volume max., Power Boost mode	Gain setting: 32 dB	—	—	34.0 dB/+6.3 dBu	35.0 dB/+4.1 dBu
	Gain setting: 26 dB	—	—	28.0 dB/+12.3 dBu	29.0 dB/+10.1 dBu
	Gain setting: +4 dBu	—	—	36.3 dB/+4 dBu	35.1 dB/+4 dBu
	Gain setting: +14 dBu	—	—	26.3 dB/+14 dBu	25.1 dB/+14 dBu
Load Protection	POWER switch on/off	Output mute			
	Output voltage protection	Over voltage limiter, user configurable by wattage and speaker preset			
	DC-fault	Power supply shutdown (NOT restored automatically)			
Amplifier Protection	Thermal	Output limiter (Restored automatically) → Output mute (Restored automatically)			
	Over current	Output mute (Restored automatically)			
	Over voltage	Output limiter (Restored automatically)			
	Integrated Power Limit	Output limiter (Restored automatically)			

		PX10	PX8	PX5	PX3
Power Supply Protection	Thermal	Output limiter (Restored automatically) → Power supply shutdown			
	Over voltage	Power supply shutdown			
	Over current	Power supply shutdown			
Cooling		16 step variable speed fan × 2, front to rear airflow			
Maximum Input Voltage		+24 dBu			
Input Impedance		20 kΩ (Balance), 10 kΩ (Unbalance)			
Sampling Frequency		48 kHz			
A/D, D/A Converters		AD: 24-bit linear, 128 times over sampling DA: 24-bit linear, 128 times over sampling			
Signal Processing		Input summing D-CONTOUR: FOH/MAIN, MONITOR, OFF Delay: 0–74msec HPF/LPF: cutoff frequency 20 Hz–20 kHz with polarity control Speaker processor: 6 band PEQ + Limiter + Delay			
Latency	Analog input to speakers	1.5 msec			
User Amplifier Preset		8 user amplifier presets			
Factory Speaker Preset		Speaker presets for Yamaha passive speakers			
Connectors	Analog input	XLR-3-31 × 2, 1/4" PHONE(TRS) × 2			
	Speakers	Neutrik speakON NL4 × 2, binding post × 2 pairs, 1/4" PHONE(TS) × 2			
	AC IN	AC inlet × 1 with AC cord clamp			
	USB	USB 2.0 Standard-A connector (female) for save/load, speaker preset update, firmware update with USB flash drive			
Controls	Front Panel	POWER switch, 31 step volume knob × 2, rotary encoder and switches for GUI control Operation lock feature (Full lock or Lock except volume and mute)			
	Display	128 × 64 pixel, mono color with brightness adjustment Auto display off feature			
Indicators		POWER × 1 (green), ALERT × 1 (red), USB × 1 (green), PROTECT × 2 (red), CLIP/LIMIT × 2 (red), SIGNAL × 2 (green) Auto LED off feature			
AC Power Requirement		Depending on area of purchase; 100 V 50 Hz/60 Hz, 120 V 60 Hz, 220 V-240 V 50 Hz/60 Hz *1			
Power Consumption	1/8 MAX power, 4Ω, Pink noise at all channels	310 W	280 W	230 W	160 W
	Idle, 4Ω	60 W	60 W	55 W	55 W
Operating Temperature		0°C to +40°C			
Storage Temperature		-20°C to +60°C			
Dimensions (W × H × D)		480 × 88 × 388 mm (18.90 × 3.46 × 15.28 inch)			
Net Weight		7.4 kg (16.31 lbs)	7.2 kg (15.87 lbs)	6.9 kg (15.21 lbs)	6.9 kg (15.21 lbs)

*1 Device operation has been confirmed within ±10% of the rated power supply voltage.

*The contents of this manual apply to the latest specifications as of the publishing date. To obtain the latest manual, access the Yamaha website then download the manual file.

Block diagram

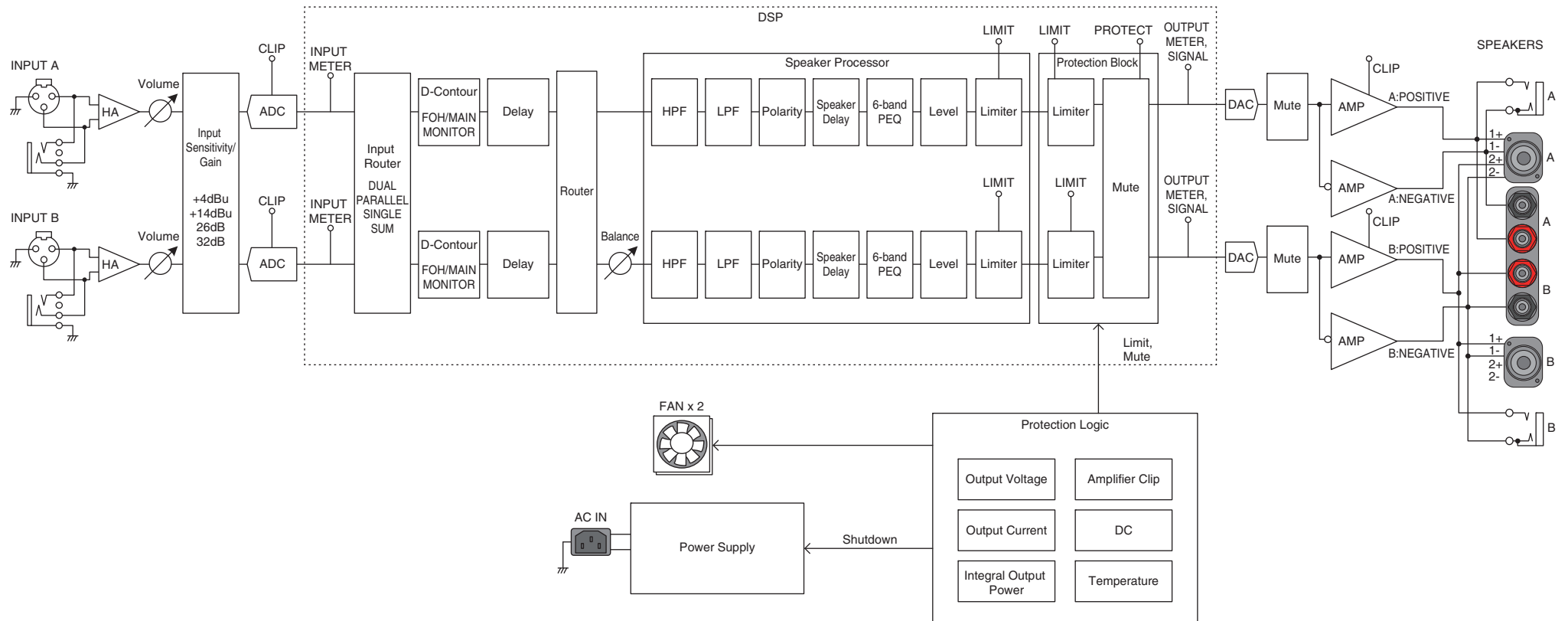

Dimensions

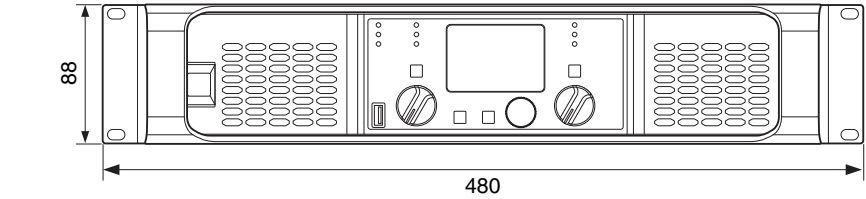
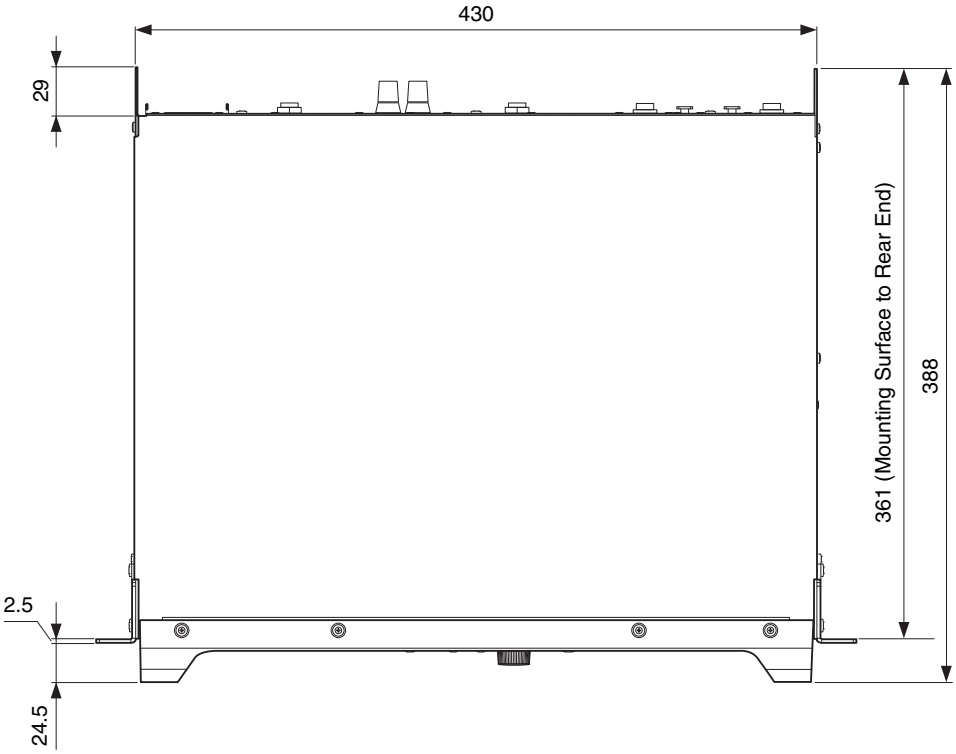

unit: mm

Current draw and thermal dissipation

Test signal: Pink noise (bandwidth limited from 22 Hz to 22 kHz), 1 Btu = 1,055.06 J = 0.252 kcal, (W) × 0.86 = kcal

● PX10

100 V/50 Hz		Line current (A)	Watt (W)			Thermal dissipation	
		100 V	Power consumption (In)	Power consumption (Out)	Watts dissipated	Btu/h	kcal/h
Idle		0.8	57	0	57	195	49
1/8 out	8Ω/ch	2.6	213	125	88	300	76
	4Ω/ch	3.1	261	150	111	379	95
1/3 out	8Ω/ch	5.6	472	333	139	474	120
	4Ω/ch	7.2	608	400	208	710	179

110 V-120 V/60 Hz		Line current (A)	Watt (W)			Thermal dissipation	
		120 V	Power consumption (In)	Power consumption (Out)	Watts dissipated	Btu/h	kcal/h
Idle		0.7	60	0	60	205	52
1/8 out	8Ω/ch	2.2	213	125	88	300	76
	4Ω/ch	2.7	263	150	113	386	97
1/3 out	8Ω/ch	4.6	466	333	133	454	114
	4Ω/ch	5.9	597	400	197	672	169

220 V-240 V/50 Hz		Line current (A)	Watt (W)			Thermal dissipation	
		230 V	Power consumption (In)	Power consumption (Out)	Watts dissipated	Btu/h	kcal/h
Idle		0.5	62	0	62	212	53
1/8 out	8Ω/ch	1.4	219	125	94	321	81
	4Ω/ch	1.6	271	150	121	413	104
1/3 out	8Ω/ch	2.7	471	333	138	471	119
	4Ω/ch	3.3	602	400	202	689	174

● PX8

100 V/50 Hz		Line current (A)	Watt (W)			Thermal dissipation	
		100 V	Power consumption (In)	Power consumption (Out)	Watts dissipated	Btu/h	kcal/h
Idle		0.8	57	0	57	195	49
1/8 out	8Ω/ch	2.2	178	100	78	266	67
	4Ω/ch	2.9	237	131	106	362	91
1/3 out	8Ω/ch	4.6	386	267	119	406	102
	4Ω/ch	6.4	543	350	193	659	166

110 V-120 V/60 Hz		Line current (A)	Watt (W)			Thermal dissipation	
		120 V	Power consumption (In)	Power consumption (Out)	Watts dissipated	Btu/h	kcal/h
Idle		0.7	60	0	60	205	52
1/8 out	8Ω/ch	1.9	182	100	82	280	71
	4Ω/ch	2.5	237	131	106	362	91
1/3 out	8Ω/ch	3.8	385	267	118	403	101
	4Ω/ch	5.4	542	350	192	655	165

220 V-240 V/50 Hz		Line current (A)	Watt (W)			Thermal dissipation	
		230 V	Power consumption (In)	Power consumption (Out)	Watts dissipated	Btu/h	kcal/h
Idle		0.5	62	0	62	212	53
1/8 out	8Ω/ch	1.2	184	100	84	287	72
	4Ω/ch	1.5	242	131	111	379	95
1/3 out	8Ω/ch	2.2	385	267	118	403	101
	4Ω/ch	3.0	544	350	194	662	167

● PX5

100 V/50 Hz		Line current (A)	Watt (W)			Thermal dissipation	
		100 V	Power consumption (In)	Power consumption (Out)	Watts dissipated	Btu/h	kcal/h
Idle		0.8	46	0	46	157	40
1/8 out	8Ω/ch	1.9	122	63	59	201	51
	4Ω/ch	2.7	189	100	89	304	77
1/3 out	8Ω/ch	3.6	253	167	86	293	74
	4Ω/ch	5.6	424	267	157	536	135

110 V-120 V/60 Hz		Line current (A)	Watt (W)			Thermal dissipation	
		120 V	Power consumption (In)	Power consumption (Out)	Watts dissipated	Btu/h	kcal/h
Idle		0.8	54	0	54	184	46
1/8 out	8Ω/ch	1.7	130	63	67	229	58
	4Ω/ch	2.4	196	100	96	328	83
1/3 out	8Ω/ch	3.1	259	167	92	314	79
	4Ω/ch	4.8	428	267	161	549	138

220 V-240 V/50 Hz		Line current (A)	Watt (W)			Thermal dissipation	
		230 V	Power consumption (In)	Power consumption (Out)	Watts dissipated	Btu/h	kcal/h
Idle		0.5	57	0	57	195	49
1/8 out	8Ω/ch	1.0	130	63	67	229	58
	4Ω/ch	1.4	197	100	97	331	83
1/3 out	8Ω/ch	1.9	259	167	92	314	79
	4Ω/ch	2.9	434	267	167	570	144

● PX3

100 V/50 Hz		Line current (A)	Watt (W)			Thermal dissipation	
		100 V	Power consumption (In)	Power consumption (Out)	Watts dissipated	Btu/h	kcal/h
Idle		0.8	46	0	46	157	40
1/8 out	8Ω/ch	1.5	94	38	56	191	48
	4Ω/ch	2.0	137	63	74	253	64
1/3 out	8Ω/ch	2.6	174	100	74	253	64
	4Ω/ch	3.9	285	167	118	403	101

110 V-120 V/60 Hz		Line current (A)	Watt (W)			Thermal dissipation	
		120 V	Power consumption (In)	Power consumption (Out)	Watts dissipated	Btu/h	kcal/h
Idle		0.8	54	0	54	184	46
1/8 out	8Ω/ch	1.3	100	38	62	212	53
	4Ω/ch	1.8	140	63	77	263	66
1/3 out	8Ω/ch	2.3	183	100	83	283	71
	4Ω/ch	3.4	291	167	124	423	107

220 V-240 V/50 Hz		Line current (A)	Watt (W)			Thermal dissipation	
		230 V	Power consumption (In)	Power consumption (Out)	Watts dissipated	Btu/h	kcal/h
Idle		0.5	57	0	57	195	49
1/8 out	8Ω/ch	0.8	101	38	63	215	54
	4Ω/ch	1.1	142	63	79	270	68
1/3 out	8Ω/ch	1.4	181	100	81	276	70
	4Ω/ch	2.1	293	167	126	430	108

Index

A			
[A] key	8		
[AC IN] connector	9		
AC plug clamp	9		
Advanced mode	12		
[ALERT] indicator	8		
Alert messages	14		
AMP PRESET screen	32		
amplifier gain	7		
B			
[B] key	8		
[↵] (back) key	8		
Basic mode	12		
basic operation	12		
BI-AMP	22		
binding post connector	11		
Black-out mode	34		
Block diagram	48		
C			
CHANNEL COPY	30		
CHANNEL LINK	30		
CLEAR	32		
[CLIP/LIMIT] indicator	8		
Clipping/limiting message	15		
CONFIG VIEW icon	15		
CONFIG VIEW screen	16		
CONFIG WIZARD screen (Advanced mode)	22		
CONFIG WIZARD screen (Basic mode)	20		
CONFIRMATION (Advanced mode)	24		
CONFIRMATION (Basic mode)	21		
Connecting to [SPEAKERS] terminal	11		
connection, speaker	11		
		crossover	26
		Current draw	50
		Current parameter	37
		D	
		D-CONTOUR	25
		D-CONTOUR indication	15
		DELAY	26
		Delay indication	15
		DEVICE BACKUP	36
		DEVICE INFORMATION	36
		Dimensions	49
		Display	8
		DUAL	23
		Dual mode	23
		E	
		EQ (6 Band PEQ)	29
		EQ indication	15
		Exhaust ports	9
		F	
		Filter indication	15
		Front panel	8
		FULL (MONO)	22
		FULL+FULL	22
		FULL+SUB	22
		G	
		General specifications	46
		H	
		High pass filter	27
		HOME SCREEN	35
		HOME screen	15
		HPF	27
		I	
		[] icon	15
		IMPORT SP PRESET	35
		Import speaker preset	35
		initialization	37
		INITIALIZE	36
		input configuration	6
		[INPUT] connectors	9
		Input processor	7
		input sensitivity	7
		Input sensitivity/amplifier gain	24
		Intake ports	8
		L	
		LEVEL	29
		Level meter	15
		LIMITER	30
		LOG	37
		Low pass filter	27
		LPF	27
		M	
		Main knob	8
		[MENU] key	8
		MENU screen	17
		MENU screen operation	17
		Message list	42
		Mute indication	15

O

operation, MENU screen	17
operation tree (MENU screen)	18
output combination	6
Output level	29

P

PANEL LOCK	34
panel lock	14
PANEL SETUP	34
PARALLEL	23
Parallel mode	23
phone jack	9
PIN code	34
POLARITY	28
Polarity indication	15
power button	8
[POWER] indicator	8
PROTECT	33
[PROTECT] indicator	8

R

rack mounting	11
rear panel	9
RECALL	32
ROUTING	23
routing	6

S

SAVE/LOAD	31
screen structure	13
SENS./GAIN	24
setup	10
[SIGNAL] indicator	8
SINGLE	23
Single mode	23

SP DELAY	28
SP IMPEDANCE	24
SP MODEL (Advanced mode)	24
SP MODEL (Basic mode)	20
SP SERIES (Advanced mode)	24
SP SERIES (Basic mode)	20
SP TYPE (Advanced mode)	22
SP TYPE (Basic mode)	20
speaker connection	11
Speaker impedance	24
Speaker model (Advanced mode)	24
Speaker model (Basic mode)	20
speaker name	15
Speaker polarity	28
Speaker processor	7
Speaker series (Advanced mode)	24
Speaker series (Basic mode)	20
speaker type	6
Speaker type (Advanced mode)	22
Speaker type (Basic mode)	20
[SPEAKERS] connection	11
[SPEAKERS] terminals	9
speakON connector	11
STORE	32
SUB (MONO)	22
SUB+SUB	22
SUM	23
Sum mode	23

T

Thermal dissipation	50
Threshold indication	15
TITLE	33
Troubleshooting	44
TUNING screen	25

U

[USB] indicator	8
[USB] terminal	8
User data	38
UTILITY screen	34

V

VOL/BAL/GAIN indication	15
Volume indication	15
Volume knob	8

W

WIZARD MODE	22
-------------------	----

X

XLR jack	9
X-OVER	26

Y

Y-plugs	11
---------------	----

Free Manuals Download Website

<http://myh66.com>

<http://usermanuals.us>

<http://www.somanuals.com>

<http://www.4manuals.cc>

<http://www.manual-lib.com>

<http://www.404manual.com>

<http://www.luxmanual.com>

<http://aubethermostatmanual.com>

Golf course search by state

<http://golfingnear.com>

Email search by domain

<http://emailbydomain.com>

Auto manuals search

<http://auto.somanuals.com>

TV manuals search

<http://tv.somanuals.com>