

YAMAHA R-100

Natural Sound AM/FM Stereo Synthesizer Receiver

Computer Controlled Sound System

Zero Distortion Rule and "X" Power Amplifier Circuit

New Computer Servo Lock Synthesizer Tuning System

Full Function Remote Control

Spatial Expander and Dynamic Noise Canceller

Auto Phono, 10-Station Random-Access Programmable Station Memory, RX Mode Selector

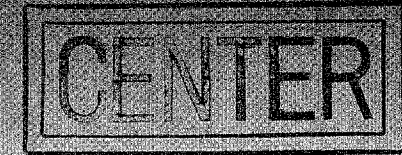

OWNER'S MANUAL

Thank you for purchasing the YAMAHA R-100 AM/FM stereo receiver.

CONTENTS

CAUTION : READ THIS BEFORE OPERATING YOUR R-100	1/2
CONNECTION DIAGRAM	3
CONNECTIONS	4/5
FRONT PANEL PARTS AND FUNCTIONS	6/7/8/9/10
LISTENING TO A PROGRAM SOURCE	11
TROUBLESHOOTING	12
SPECIFICATIONS	13

IMPORTANT

Please record the serial number of your unit in the space below.

Model: R-100

Serial No.:

The serial number is located on the rear of the cabinet.
Retain this Owner's Manual in a safe place for future reference.

WARNING

To prevent fire or shock hazard, do not expose this appliance to rain or moisture.

CAUTION (PREPARED IN ACCORDANCE WITH UL STANDARD 1270)

1 Read Instructions — All the safety and operating instructions should be read before the appliance is operated.

2 Retain Instructions — The safety and operating instructions should be retained for future reference.

3 Heed Warnings — All warnings on the appliance and in the operating instructions should be adhered to.

4 Follow Instructions — All operating and other instructions should be followed.

5 Water and Moisture — The appliance should not be used near water — for example, near a bathtub, washbowl, kitchen sink, laundry tub, in a wet basement, or near swimming pool, etc.

6 Carts and Stands — The appliance should be used only with a cart or stand that is recommended by the manufacturer.

7 Wall or Ceiling Mounting — The appliance should be mounted to a wall or ceiling only as recommended by the manufacturer.

8 Ventilation — The appliance should be situated so that its location or position does not interfere with its proper ventilation. For example, the appliance should not be situated on a bed, sofa, rug, or similar surface that may block the ventilation openings; or placed in a built-in installation, such as a bookcase or cabinet that may impede the flow of air through the ventilation openings.

9 Heat — The appliance should be situated away from heat sources such as radiators, stoves, or other appliances that produce heat.

10 Power Sources — The appliance should be connected to a power supply only of the type described in the operating instructions or as marked on the appliance.

11 Power-Cord Protection — Power-supply cords should be routed so that they are not likely to be walked on or pinched by items placed upon or against them, paying particular attention to cords at plugs, convenience receptacles, and the point where they exit from the appliance.

12 Cleaning — The appliance should be cleaned only as recommended by the manufacturer.

13 Nonuse Periods — The power cord of the appliance should be unplugged from the outlet when left unused for a long period of time.

14 Object and Liquid Entry — Care should be taken so that objects do not fall into and liquids not spilled into the inside of the appliance.

15 Damage Requiring Service — The appliance should be serviced by qualified service personnel when:

- A. The power-supply cord or the plug has been damaged; or
- B. Objects have fallen, or liquid has been spilled into the appliance; or
- C. The appliance has been exposed to rain; or
- D. The appliance does not appear to operate normally or exhibits a marked change in performance; or
- E. The appliance has been dropped, or the cabinet damaged.

16 Servicing — The user should not attempt to service the appliance beyond those means described in the operating instructions. All other servicing should be referred to qualified service personnel.

17 Power Lines — An outdoor antenna should be located away from power lines.

18 Outdoor antenna grounding — If an outside antenna is connected to the tuner, be sure the antenna system is grounded so as to provide some protection against voltage surges and built up static charges. Section 810 of the National Electrical Code, ANSI/NFPA No. 70 — 1981, provides information with respect to proper grounding of the mast and supporting structure, grounding of the lead-in wire to an antenna discharge unit, size of grounding conductors, location of antenna-discharge unit, connection to grounding electrodes, and requirements for the grounding electrode.

EXAMPLE OF ANTENNA GROUNDING AS PER NATIONAL ELECTRICAL CODE INSTRUCTIONS

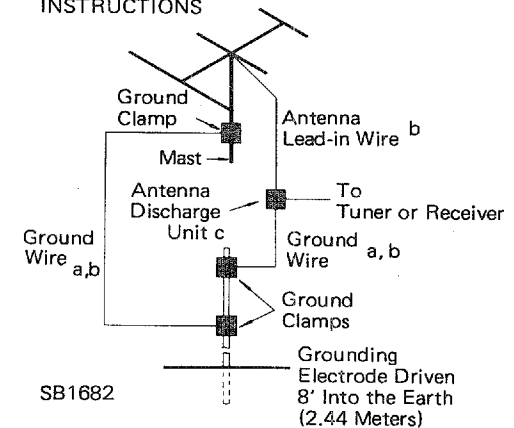

- a. Use No. 10 AWG (5.3 mm²) copper, No. 8 AWG (8.4 mm²) aluminium, No. 17 AWG (1.0 mm²) copper-clad steel or bronze wire, or larger, as ground wire.
- b. Secure antenna lead-in and ground wire to house with stand-off insulators spaced from 4 feet (1.22 meters) to 6 feet (1.83 meters) apart.
- c. Mount antenna discharge unit as closely as possible to where lead-in enters house.

**CAUTION: READ THIS BEFORE
OPERATING YOUR R-100**

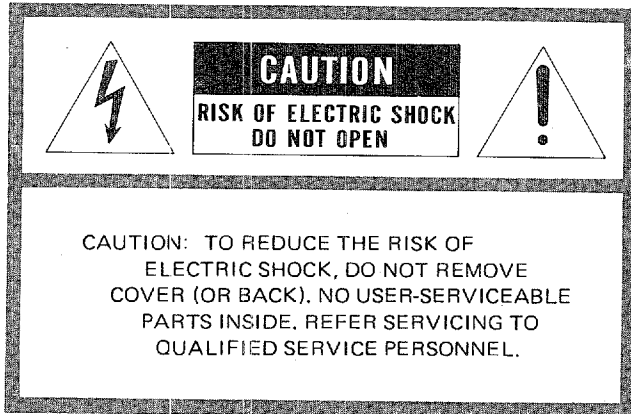

• Explanation of Graphical Symbols

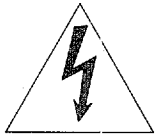

The lightning flash with arrowhead symbol, within an equilateral triangle, is intended to alert you to the presence of uninsulated "dangerous voltage" within the product's enclosure that may be of sufficient magnitude to constitute a risk of electric shock to persons.



The exclamation point within an equilateral triangle is intended to alert you to the presence of important operating and maintenance (servicing) instructions in the literature accompanying the appliance.

1

The R-100 is a sophisticated stereo receiver. To ensure proper operating for the best possible performance, please read this manual carefully.

2

Choose the installation of your R-100 carefully. Avoid placing it in direct sunlight or close to a source of heat. Also avoid locations subject to vibration and excessive dust, heat, cold or moisture. Keep away from such sources of hum as transformers or motors.

3

To ensure that the unit operates properly, be sure to set it on a level surface, and do not cover the heat vents on the top. If temperature becomes too high, a thermal protector cut off the power. Wait for a unit to cool down, and the unit will operate normally.

4

If speaker impedance is too low, a protection relay circuit cut off the output signal. Use speakers inside the rated impedance range.

5

Use only the supplied AM loop antenna in the AM antenna terminal.

6

The back-up power supply will keep the preset stations memorized for one week if power fails or the set is unplugged. In order to keep the back-up power supply fully charged, turn the power switch on once a week even if you are not using the unit.

Even if the preset stations are erased, the memory is still functional; merely preset the stations again.

7

Do not open the cabinet as this might result in damage to the set or electrical shock. If a foreign object should get into the set, contact your dealer.

8

Do not place records or other objects on top of the receiver so that the ventilation holes are blocked. This will cause the internal temperature to rise and may result in a failure.

9

When removing the power plug from the wall outlet, always pull directly on the plug; never yank the cord.

10

To prevent lightning damage, pull out the power cord and remove the antenna cable in case of an electrical storm.

11

Do not use force when using the switches and knobs.

12

When moving the set be sure to first pull out the power plug and remove cords connecting to other equipment.

13

Always set the volume control to "0" while lowering the tonearm to play a record, then turn the volume up after the stylus is seated in the record groove.

14

Do not attempt to clean the R-100 with chemical solvents as this might damage the finish. Use a clean, dry cloth.

15

Do not input more than the maximum allowable level to the Input (Video/Aux), Tape 1 (Tape PB), and Tape 2 (Tape PB) terminals.

16

Do not connect audio equipment to the AC outlets on the rear panel if that equipment requires more power than the outlets are rated to provide.

17

Be sure to read the "troubleshooting" section for advice on common operating errors before concluding that your R-100 is faulty.

18

Keep this manual in a safe place for future reference.

R-100

CONNECTION DIAGRAM

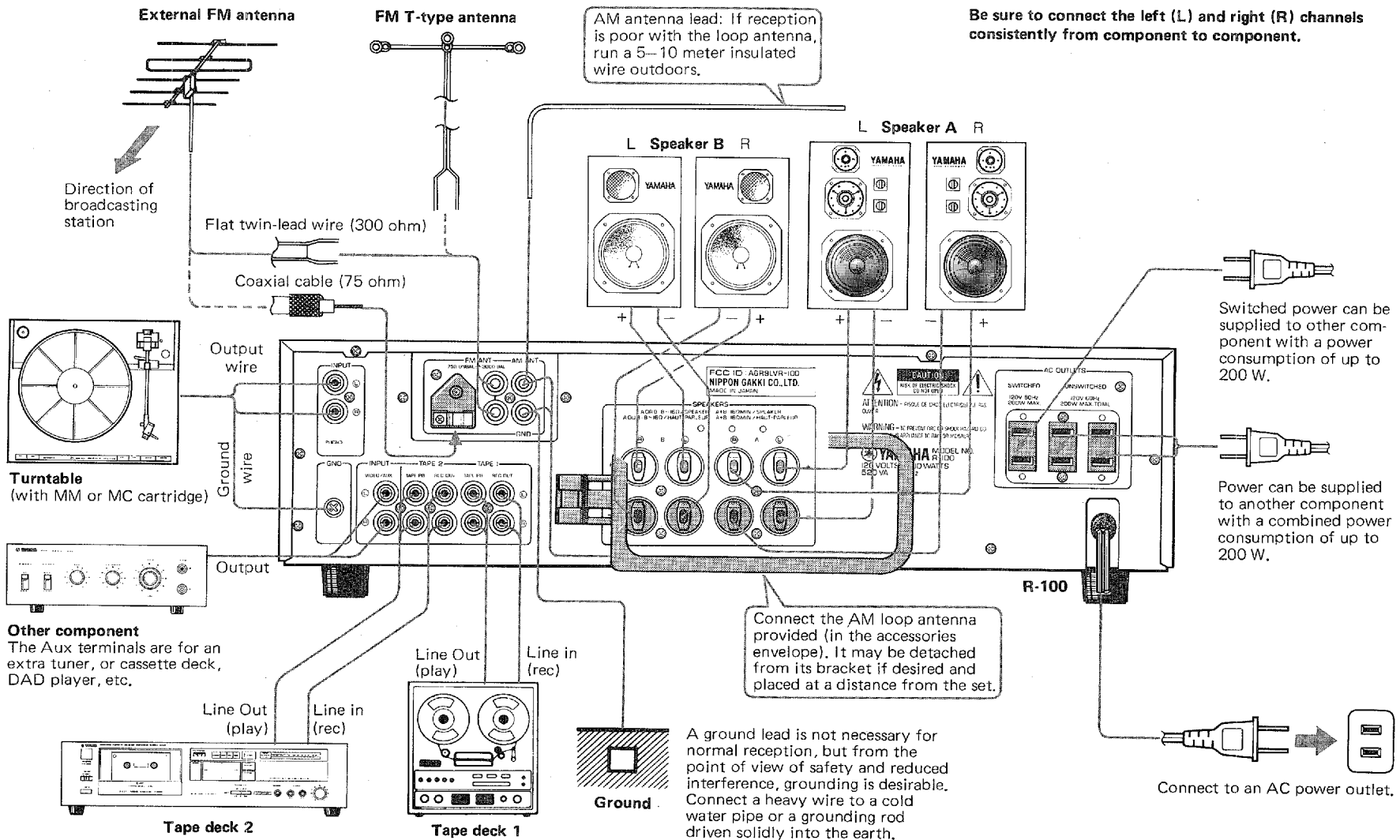

CONNECTIONS

■ CONNECTING THE SPEAKERS

The matching impedance of this amplifier is 8 ohms.

Either one or two pairs of speakers may be connected. If only one pair is connected the recommended speaker impedance may be anywhere between 4 and 16 ohms. If two pairs are connected, however, it is advisable to use speakers with at least an 8 ohm impedance for optimum performance.

Connecting two pairs of 4 ohm speakers is not recommended.

Connect the cords going to the left speakers to the L terminals and the right speaker cords to the R terminals, making sure that the "+" and "-" markings are observed. If the "+" and "-" wires are reversed at either speaker, the sound will be unnatural and will lack bass. Speaker cords should be cut as short as possible; do not coil up excess wire on the floor. Also, do not bundle with cords from other system components.

Turn the speaker terminal to the left, insert the exposed wire of the speaker cord into the hole and then turn to the right. The cord will be locked into position. If these connections are faulty, no sound will be heard from the speakers.

Speaker terminals

Turn the terminal to the left, insert the speaker cord and then turn to the right.

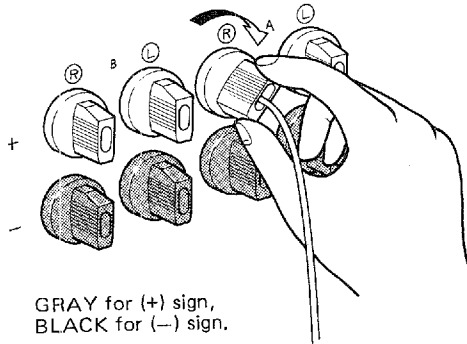

■ CONNECTING A TURNTABLE

Connect the output cords of the turntable to the receiver's Phono Jacks, and connect the ground wire to the Gnd terminal. Normally, connecting the ground wire produces minimum hum, but in some cases better results are obtained with the ground wire disconnected. The cartridge and the turntable's output cords should be positioned well away from such sources of hum as power cords or power transformers of other system components.

■ CONNECTING A TAPE DECK

Two tape decks can be connected to this receiver as it has two sets of jacks (Tape 1 and Tape 2). Connect the Tape PB jacks to the tape deck's Line Out jacks, and the Rec Out jacks to the tape deck's Line In jacks.

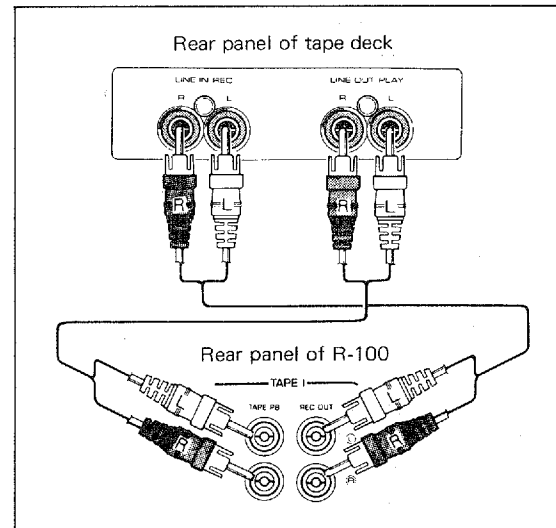

■ CONNECTING THE AM ANTENNA

In many cases it will be possible to get excellent AM reception with the provided AM loop antenna. Attach the antenna leads to the Gnd and AM Ant terminals and rotate the antenna in its bracket for best reception. The loop antenna may also be removed and hung on the wall. If necessary, an outdoor antenna may be used for improved AM reception. Connect a 5-10 meter length of insulated wire to the AM Ant terminal and run it outdoors.

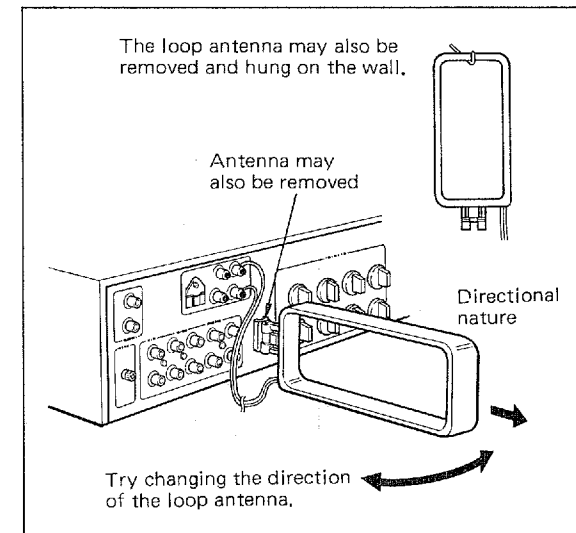

R-100

■ CONNECTING THE FM ANTENNA

Choose an FM antenna that is appropriate to the local reception conditions. Consider the distance from the broadcast station and possible interfering objects such as surrounding tall buildings. In cases where there is a strong signal from a local station, a portable T-type antenna is usually adequate. Connect the feeder wire to the 300 ohm terminal, stretch the wire out tight, and turn to obtain optimum reception. Attach to a suitable support such as a wall.

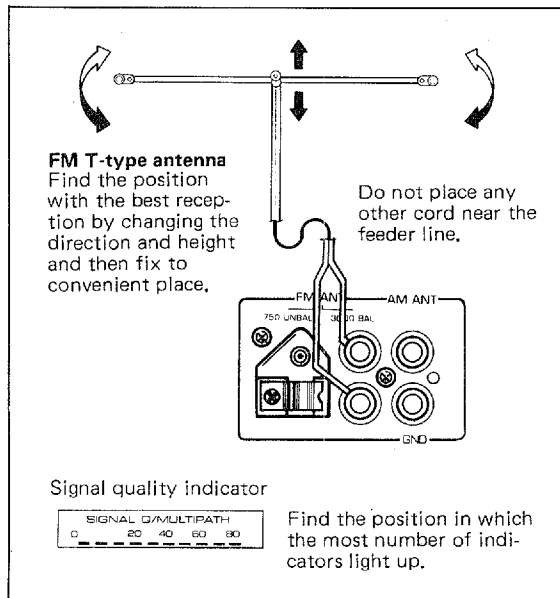

In all but the best reception conditions, an outdoor FM antenna is necessary for best results. Either 300 ohm flat twin-lead wire or 75 ohm coaxial cable may be used. In locations where electrical interference is a problem, coaxial cable is preferable. Refer to figure for instructions on installing the coaxial cable.

Note: Connect either an indoor FM T-type antenna or outdoor FM antenna but not both.

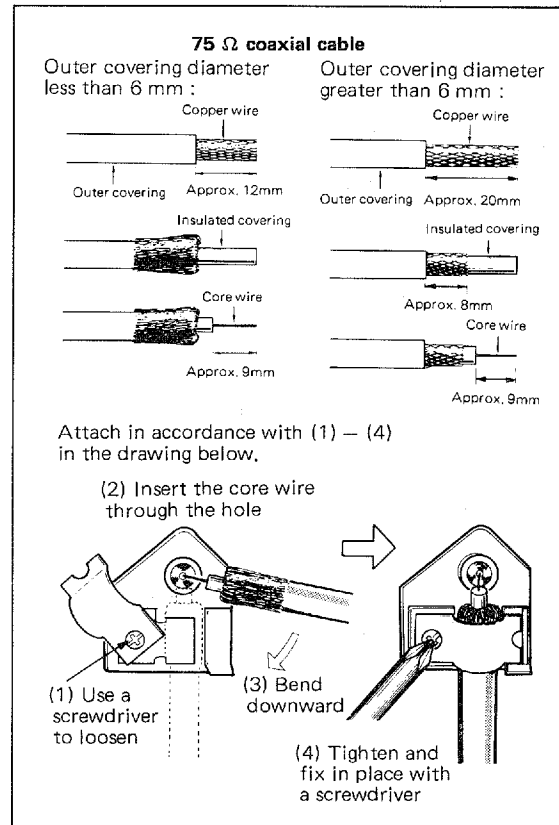

■ AC OUTLETS

Provided for connecting other audio equipment. The left outlet, with a maximum power capacity of 200 W, is switched on and off by the receiver's power switch; the center and right outlets supply continuous unswitched power up to a combined maximum of 200 W.

*

FRONT PANEL PARTS AND FUNCTIONS

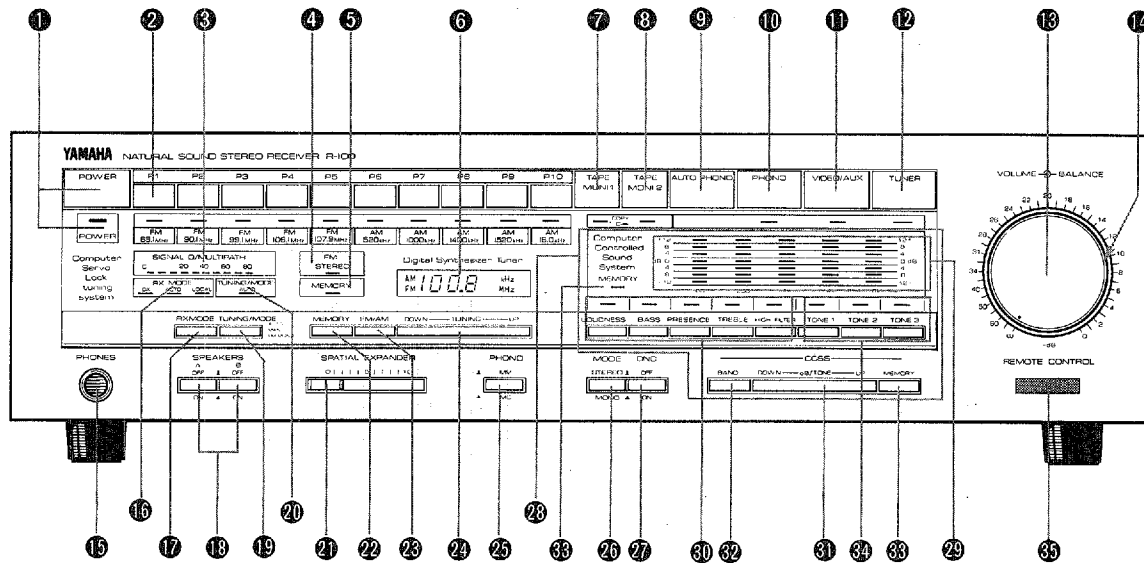

1 POWER SWITCH

This is a "push-on, push-off" power switch. When power is turned on, the power indicator, digital frequency display and other relevant indicators will light.

2 PRESET TUNING BUTTONS

10 FM and AM stations can be preset. First tune in the station you want to preset. Then push the Memory button. The Memory LED will glow continuously. While it is lit, push one of the preset buttons. The LED beneath it will light. Thereafter, whenever that button is pushed, the preset station will be immediately tuned in. Each of the buttons can be used to preset one AM or one FM station.

* When the Memory button is pushed, the LED beneath the last button which was preset will flash, so you should push the next button.

* It is not necessary to select the proper band (FM or AM) before using one of the preset buttons to tune in a station. The band is memorized together with the station.

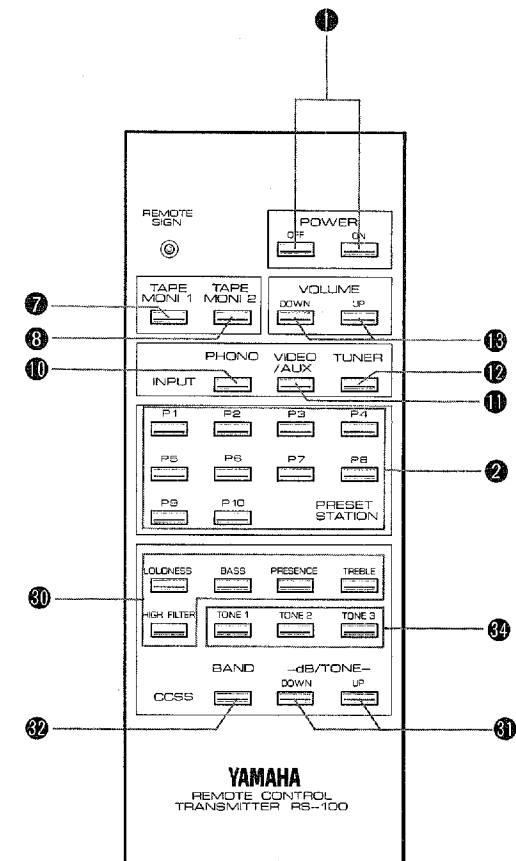
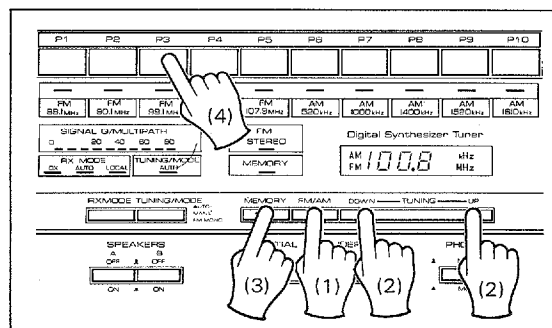

• Accessory

Wireless Remote Control Transmitter RS-100

- * The station notations below the LEDs are removable. Pull out the plastic holder from the left side of the front panel. Push the notation cards from the back to pop them out. The reverse side is blank, so you can write the station call letters and then insert that side facing out.

● FM AM STATION CARD

These cards can be used to mark preset station. Slip out the holder (under the preset buttons) and change the cards as desired.

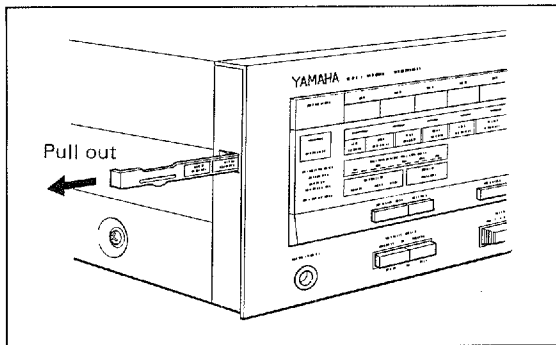
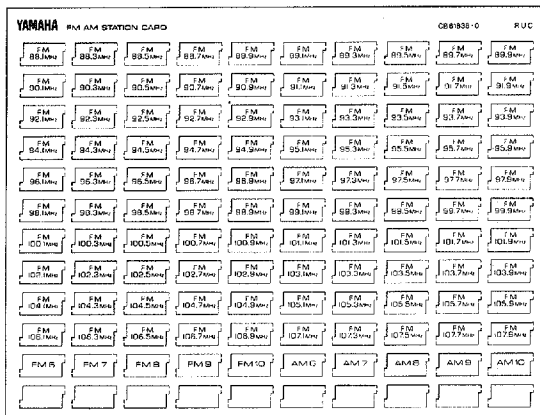

③ SIGNAL QUALITY INDICATION

These ten indicators show the relative quality of the received station. In the case of FM reception, a slight flickering indicates the presence of multipath interference. This can be eliminated by using a directional FM antenna and adjusting its height and direction until the indicators glow steadily.

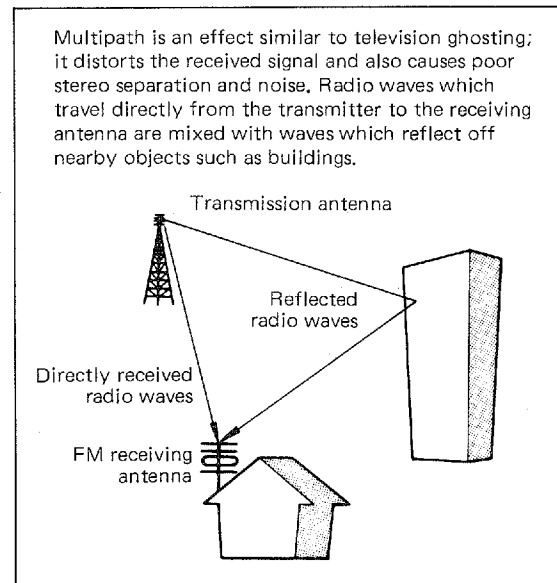

④ FM STEREO INDICATOR

Indicates when the received FM station is in stereo.

⑤ MEMORY

When the Memory button ④ is pushed, this LED lights to indicate that one of the preset buttons should be pushed.

⑥ DIGITAL FREQUENCY READOUT

Displays tuner frequency and band (AM – kHz or FM – MHz).

⑦ TAPE MONITOR 1

Depress this switch to listen to the sound from the tape recorder connected to the Tape 1 terminals. The red LED beneath it will light.

⑧ TAPE MONITOR 2

Depress this switch to listen to the sound from the tape recorder connected to the Tape 2 terminals. The red LED beneath it will light.

- * Pressing both buttons at the same time enables you to dub from tape deck 1 to tape deck 2.

⑨ AUTO PHONO SELECTOR

Touch this button to put the receiver in the Auto Phono mode. The red LED beneath it will light. In this mode, the receiver automatically monitors the turntable input signal and selects the turntable as the input source when its play button is pushed, overriding the currently selected input source. This means that if you are listening to an FM station, for example, you can play a record without having to touch the receiver at all. The turntable will be automatically selected as play starts, and the tuner will once again be selected when play finishes.

- * When a low-output phono cartridge is used, playing a low-signal-level portion of a record may under some circumstances cause the Auto Phono circuit to switch from phono input to the alternately selected program source. This condition can be avoided by manually selecting phono input with the Phono button.

⑩ PHONO

Depress this switch to listen to the turntable. The green LED will light.

⑪ VIDEO/AUX

Depress this switch to listen to a video deck or other auxiliary sound source—an extra tape deck or tuner (not turntable), DAD (Digital Audio Disc) player, etc. The green LED will light.

⑫ TUNER

Depress this switch to listen to the tuner. The green LED will light.

R-100

13 VOLUME

Used to adjust overall sound volume.

14 BALANCE CONTROL

Used to adjust the relative volume of the left and right speakers. You can thus compensate for imbalances caused by speaker placement, room furniture, or your listening position.

15 PHONES JACK

Used for plugging in headphones. When you want to listen to headphones only, speaker switches A and B should be in the off position.

16 RX MODE INDICATORS

Indicates which RX mode (reception mode) the tuner is in.

17 RX MODE SELECTOR

Pushing this button allows you to switch between DX (distant), Local, and Auto tuner reception modes. In the Auto position, the strength of the received signal is continuously monitored, and if it falls below a certain level a high gain, high selectivity circuit is switched in to provide the best possible reception of weak, noisy stations. When the signal is strong, this circuit is deactivated, for lower distortion and better stereo separation. The Local position provides best reception from strong, local stations. Accurate music reproduction with low distortion and good stereo separation will be achieved. In the DX position, the high selectivity circuit is switched in for best possible reception from weak, distant stations.

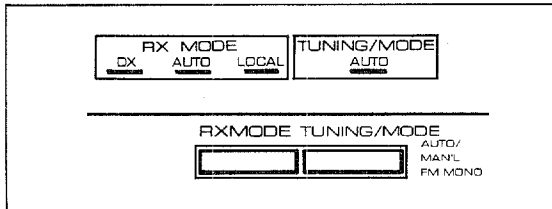

18 SPEAKER SELECTORS

With these switches you can select either or both of two pairs of speakers. The in position is the on position.

19 TUNING MODE SELECTOR

In the Auto mode, the tuner will automatically scan the frequency band when the Up or Down side of the tuning button is pushed, and the Auto LED indicator will light up. In the Manual mode, the tuner will advance one step at a time when the tuning button is pushed once, and continuously when it is pushed continuously. In addition, when set to the Auto position, any stereo FM broadcast will be received in stereo. If the station is weak, however, and interference is heard, setting the selector to the Mono position will help to bring the station in clearer—without, of course, the stereo effect.

20 TUNING MODE AUTO INDICATOR

Lights to show that the tuner is in the automatic search tuning mode.

21 SPATIAL EXPANDER

Crossfeeds signals from the left and right channels to produce an expanded "wide stereo" effect. Continuously variable from 0 to 10 (maximum). There is almost no effect when headphones are used. (Please refer to page 11)

22 MEMORY

As explained above under 2, pushing this button allows a station to be preset into the memory. Do not confuse this memory button with the CCSS memory button.

23 FM AND AM SELECTORS

Push to select FM or AM. The selected band will be indicated next to the digital frequency display.

24 TUNING

This button is used to scan the FM or AM band for stations. In the Auto mode, pushing the Up side of the button causes the tuner to scan to progressively higher frequencies until a station is found and then to lock the station in.

Pushing the Down side causes it to scan down the band. If the end of the band is reached without finding a station, the auto-search circuit instantly shifts to the opposite end of the band and the search continues in the same direction. In the Manual mode, pushing the tuning button once will cause the tuner to move one step in the up or down direction (one step equals 0.1 MHz in FM and 10 kHz in AM). Pushing continuously will cause the tuner to scan continuously.

- * Push the button firmly on one end or the other, not in the middle.
- * This tuner incorporates a last station memory. When turned on, it will tune to the last station that was tuned in before it was turned off.

25 PHONO BUTTON

Set to MM (moving magnet) or MC (moving coil) to match the type of cartridge you are using.

26 MODE SELECTOR

Allows switching between stereo and mono operation. Normally it should be set to the stereo position; mono is useful for setting the balance between speakers, checking speaker phasing, checking stereo effect, etc.

27 DNC SELECTOR

The DNC (Dynamic Noise Canceller) can be used to greatly reduce the noise in poor quality music sources such as distant radio stations or tapes recorded at a low recording level.

28 COMPUTER CONTROLLED SOUND SYSTEM (CCSS)

The CCSS consists of 5 Preset buttons: Loudness, Bass, Presence, Treble, and High Filter, plus 3 Programmable buttons (Tone 1, Tone 2, Tone 3) which you can set yourself. The CCSS is a new concept in tone control, replacing conventional tone controls, filters, and loudness controls. Its most outstanding feature is that it enables you to get the desired tone or sound effect by a single operation.

R-100

29 CCSS FREQUENCY CURVE INDICATORS

Each Preset button is initially set at the ideal position, but can be varied in 5 steps. As the display indicates, each button varies the tone through 5 frequency ranges, from lower (left) to higher (right). A red LED indicates the level in each range. The middle (0) position is the flat position. If the indicator is above (below) the central line, this means the volume has increased (decreased).

30 PRESET BUTTONS AND INDICATORS

Pressing one of the Preset buttons causes the following:

- * Activates CCSS to produce the chosen effect. For instance, pressing Bass boosts the sound by emphasizing the bass tones.
- * The LED immediately above the button lights to show which setting is activated.

LOUDNESS

Compensates for our ears' reduced sensitivity to high and low frequencies at low volumes. Pushing this button adjusts the five tone ranges so the bass and treble are emphasized, as the five LEDs show. The contour can be adjusted by pushing the CCSS Tone button.

- * All five LEDs lined up on the 0 dB line is the flat position.

BASS

Emphasizes low frequencies for a more powerful bass sound. Can be adjusted with the CCSS Tone button.

- * 60 Hz do not go below 0 dB.

PRESENCE

Emphasizes the midrange frequencies—great for bringing out vocals. Can be adjusted with the CCSS Tone button.

TREBLE

Emphasizes high frequencies for a brighter tone. Can be adjusted with the CCSS Tone button.

HIGH FILTER

De-emphasizes the high frequencies—use to remove tape hiss, record surface noise, FM noise, etc.—to obtain a softer tone. Can be adjusted with the CCSS Tone button.

31 CCSS TONE BUTTON

First select one of the five Preset buttons. This setting can then be adjusted using the CCSS Tone button. Pressing the Up key increases the volume, and pressing the Down key decreases the volume. Pressing this button changes the degree of the effect, not the effect itself. Refer to the below chart.

32 CCSS BAND BUTTON

This button is used when CCSS is used as a graphic equalizer.

- * Pressing this button causes one LED in the CCSS frequency curve indicators to blink.
- * Pressing this button consecutively moves the blinking LED to the right according to the number of times the button is pressed.
- * If the CCSS Tone button is pressed while an LED is blinking, the LED will move up or down.
- * Repeat this operation to create your desired curve.
- * Pressing the CCSS Tone button after creating a curve and the LED has stopped blinking, changes the degree without changing the tonal effect.
- * Curves created by the above procedure can be memorized in Tone 1 to Tone 3.

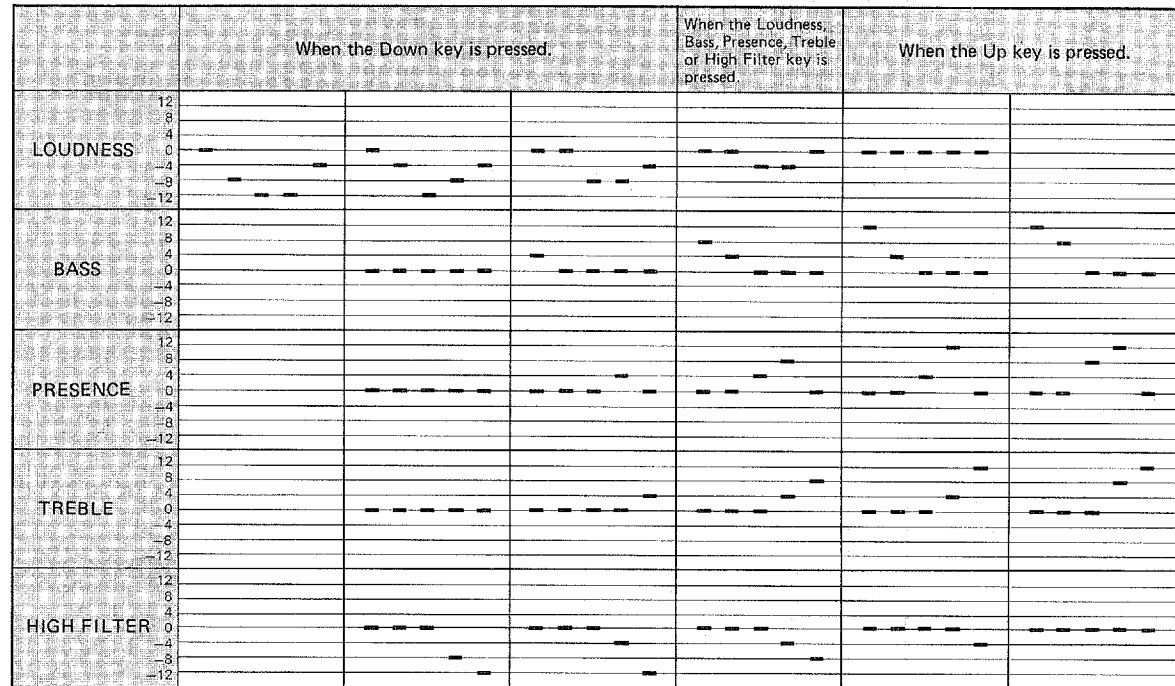

- Use this chart as reference in order to use CCSS to emphasize various sounds.

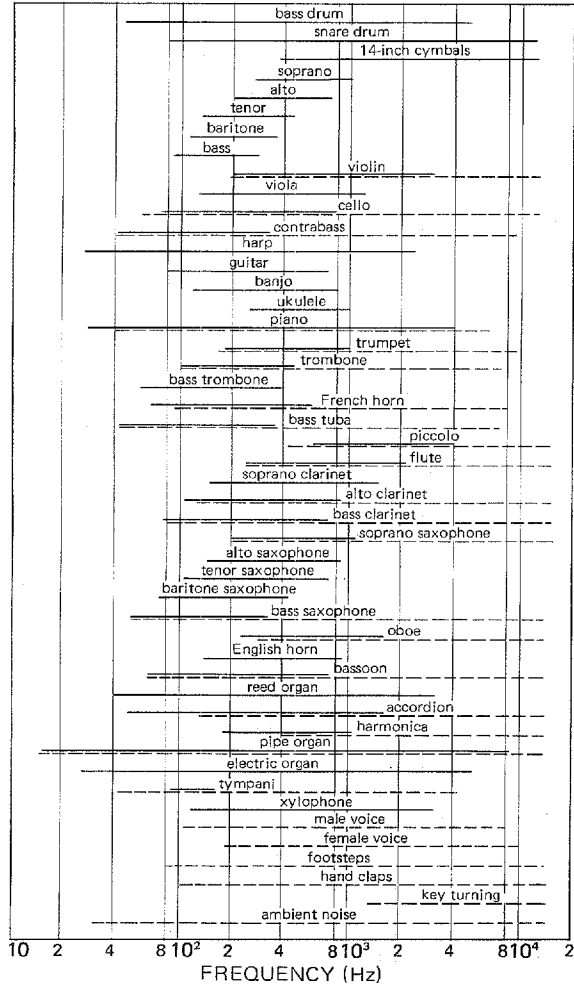

MEMORY BUTTON AND MEMORY INDICATOR

Used for memorizing tonal settings. Memory button is pushed the LED lights to indicate that one of the Programmable buttons should be pushed. Be sure not to confuse this button with the tuner's preset station memory button.

PROGRAMMABLE BUTTONS AND INDICATORS (TONE 1, TONE 2, TONE 3)

These buttons are used to memorize any frequency curve pattern and to call out memorized curve patterns. For example, one can be used to preset the Flat (0 dB) position. This is useful as a reference for the various tonal effects. Another could be used if, for example, you prefer more emphasis at the treble setting.

Operating steps:

- 1) Create a curve pattern to be memorized using the Preset buttons and CCSS Tone button.
- 2) Press the Memory button. The Memory LED indicator will light.

Solid lines :

Frequency ranges of basic frequencies of voice and various musical instruments

Dotted lines :

Frequency ranges necessary for playing back voice, sounds of musical instruments, or noise without audible distortion

- 3) While it is lit, push one of the Programmable buttons. The curve pattern is now memorized and can be recalled at any time by pushing that Programmable button. For example, if you want to change the pattern to the one memorized in Tone 1 while the Loudness button is depressed, press the Tone 1 button. The CCSS Tone button can also be used when the memorized pattern is called out. Operate the set in the order shown in the illustration.

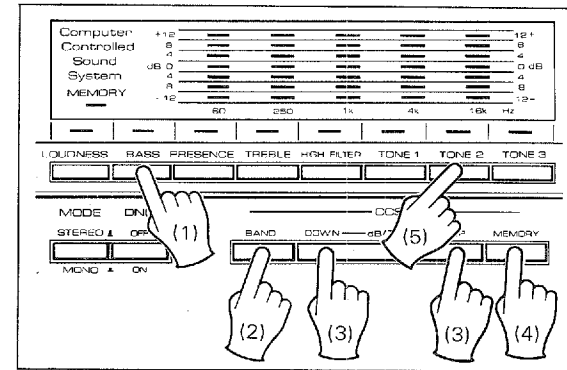

REMOTE CONTROL

Receives signal from the wireless remote control unit (RS-100).

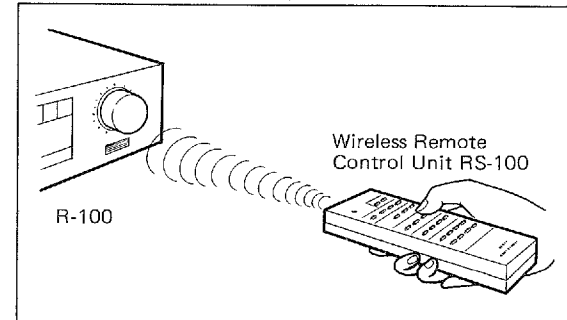

R-100

LISTENING TO A PROGRAM SOURCE

■ SPATIAL EXPANDER

Yamaha's advanced technology makes listening to a dynamic stereo music program even more exciting. At your command, the stereo sound field is expanded beyond the physical locations of your speakers, filling your room with incredibly realistic sound. Be sure to choose a listening position equidistant from the two speakers to enjoy the optimum expanded stereo effect. The Spatial Expander control is continuously variable from 0 (minimum) to 10 (maximum), and it should be set for the most pleasing results depending on the particular program source. The best effect is produced by music sources with excellent separation, and for these high-quality sources a setting of 5 - 7 is best.

- * The signal output at the Rec Out terminals is unaffected by the Spatial Expander.
- * No effect is produced with monophonic sources or mono mode, and when headphones are used.

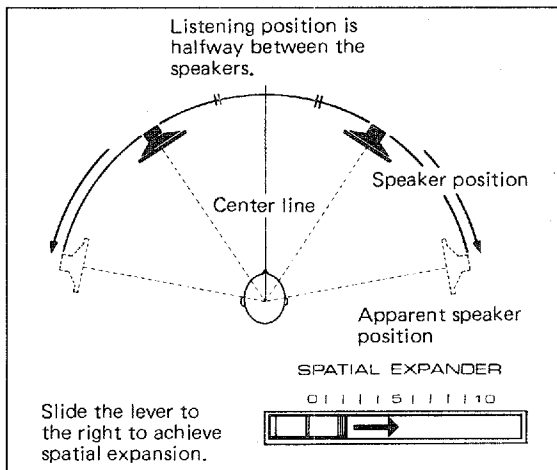

■ LISTENING TO FM BROADCASTS

1. Set the Input selector to Tuner.
 2. Set the FM and AM Selectors to FM.
 3. Set the Tuning/Mode switch to Auto.
 4. Press either the Up or the Down side of the Tuning button. The receiver will automatically scan the FM band in the selected direction. When a station is found, the scan will stop and the station will be locked in automatically. Use the Tuning button repeatedly to tune in your desired station. Stations may also be selected with the preset tuning buttons.
 5. When the station is in stereo the FM Stereo indicator will light, while for mono stations the indicator will remain off.
- * When listening to a weak, distant station or when there is interference from another station, setting the Tuning/Mode switch to the Manual position will cause the station to be received in mono and considerably reduce noise.
 - * The RX Mode selector should also be used to obtain optimum reception.

■ LISTENING TO AM BROADCASTS

1. Set the Input selector to Tuner.
2. Set the FM and AM Selectors to AM.
3. Set the Tuning/Mode switch to Auto.
4. Press either the Up or the Down side of the Tuning button. The receiver will automatically scan the AM band in the selected direction. When a station is found, the scan will stop and the station will be locked in automatically. Use the Tuning button repeatedly to tune in your desired station. Stations may also be selected with the preset tuning buttons.

■ PRESET TUNING

In addition to the auto-search tuning feature, a convenient programmable preset tuning system allows you to tune in your favorite stations with the touch of a button. To preset a station into the memory, first tune the station in. After pressing the Memory button, press one of the numbered preset tuning buttons. The tuner will then memorize the station's frequency. Any time the appropriate numbered button is pressed, the station will be automatically tuned in. After you have preset a station, it is a good

idea to manually change to another frequency and then push the newly memorized station's button again to see that it is tuned in correctly. Up to 10 stations can be preset - 10 AM, 10 FM, or any combination of AM and FM. The band is memorized together with the station.

To tune in a previously memorized station, press the numbered button corresponding to the desired station. The station will be automatically tuned in. The preset tuning button will light to indicate automatic station selection. There may be cases where static electricity or electrical noise from fluorescent lamps or television sets prevents successful preset tuning. Set the tuner away from such sources of interference.

■ LISTENING TO RECORDS

1. Set the Input selector to Phono or Auto Phono.
 2. Set the Phono button to MM or MC to match your cartridge.
 3. Place a record on the turntable and start it playing.
- * When lowering the stylus to the record or raising the stylus from the record, turn the volume control all the way to "0".

■ RECORDING TAPES

1. Select the source to be recorded (Phono, Video/Aux, or Tuner).
 2. Start the music from the selected source.
 3. Set the recording level, etc. of the tape deck, and begin recording.
 4. If your tape deck has three heads, pushing the appropriate Tape Monitor button will allow you to monitor the recorded material.
- * Adjusting the tone controls or the volume control during recording has no effect on the material being recorded.
 - * Tapes can be dubbed from deck 1 to deck 2 by setting deck 1 to play and deck 2 to record. Press both Tape Monitor buttons at the same time to begin dubbing.

■ PLAYING BACK TAPES

1. Push the Tape Monitor 1 or 2 button.
 2. Set the tape deck to Play.
- * Pressing both button at the same time enables you to dub from tape deck 1 to tape deck 2.

TROUBLESHOOTING

Before assuming that your receiver is faulty, check the following troubleshooting list which details the corrective action you can take yourself without having to call a service engineer. If you have any doubts or questions, get in touch with your nearest Yamaha dealer.

	FAULT	CAUSE	CURE
AUDIO	Power is not applied even though the Power switch is turned on.	The power cord is not plugged in.	Plug in the power cord.
	There is no sound with any position of the Input selector.	The Speaker switches are not set correctly.	Set them correctly.
		The input cords are not connected securely.	Plug them in securely.
	There is no sound from one speaker.	The speaker connections are not secure.	Secure the connections.
		The Balance control is set all the way to the left or right.	Adjust the Balance control correctly.
	There is a lack of bass and no ambience.	The + and - cords have been reversed at the amp or the speakers.	Connect the speaker wires in the correct phase (+ and -).
There is a humming sound when playing records.	The input cords are not connected securely.	Plug the input cords in securely.	
	The turntable's ground wire is not connected.	Connect the ground wire.	
There is a howling sound when playing records at high volume.	The turntable and the speakers are too close together or the turntable is not mounted on a firm surface.	Change the location of the turntable or the speakers.	
FM	Crackling sounds from time to time (especially in weak signal areas).	Ignition noise from vehicles.	The FM antenna should be put up as high as possible, away from the road, and a coaxial cable used.
		Noise from thermostats and other electrical equipment.	Attach a noise suppressor to the equipment causing the noise.
	FM stereo reception is noisy.	Because of the characteristics of FM stereo broadcasts, this is limited to cases where the transmitter is far away or the antenna input is poor.	Check the antenna connections.
			Try using a multiple element FM antenna.
	The FM Stereo indicator flickers on and off and reception is noisy.	Insufficient antenna input.	Set the RX Mode switch to the Local position.
			Use an antenna appropriate for the reception conditions in your area.
	There is distortion and clear reception cannot be obtained even with a good FM antenna.	Not tuned correctly.	Tune again.
			Adjust antenna placement to eliminate multipath interference.
No stereo effect even with a stereo broadcast.	The Mode switch is set to Mono or the Tuning/Mode switch is set to FM Mono.	Set these switches properly.	
A desired station can not be tuned in with Auto Tuning.	The station is too weak.	Use a high-quality directional FM antenna.	
Previously preset stations can no longer be tuned in.	The tuner has been unplugged for a long period.	Repeat the preset procedure.	
AM	Insufficient sensitivity.	Weak signal or loose antenna connections.	Tighten the AM loop antenna connections and rotate it for best reception.
	There are continuous crackling and hissing noises.		Use an outdoor antenna.
		There are buzzing and whining noises.	These noises result from lightning, fluorescent lamps, motors, thermostats and other electrical equipment.
There are buzzing and whining noises.	Another station is interfering with the received station.		This is impossible to remedy.
		A television set is being used nearby.	Move the television a distance away.

R-100

SPECIFICATIONS

AUDIO SECTION

Minimum RMS Output Power per Channel

8 ohms, 20 Hz to 20 kHz, 0.01% THD	100 W
4 ohms, 1 kHz, IHF Signal (Dynamic Power)	130 W
2 ohms, 1 kHz, IHF Signal (Dynamic Power)	130 W

Dynamic Headroom

(IHF, 8 ohms)	1.5 dB
---------------	--------

Power Bandwidth

8 ohms, 0.012% THD, 50 W	10 Hz to 30 kHz
--------------------------	-----------------

Damping Factor

(8 ohms, 1 kHz)	45
-----------------	----

Input Sensitivity/Impedance

Phono MM	2.5 mV/47 k-ohms
Phono MC	160 μ V/100 ohms
Aux/Tape/Tuner	120 mV/47 k-ohms

Input Sensitivity (New IHF)

Phono MM	0.3 mV
Phono MC	16 μ V
Aux/Tape/Tuner	12 mV

Maximum Input Level

(1 kHz, 0.02% THD)	
Phono MM	110 mV
Phono MC	7 mV

Output Level/Impedance

Rec Out	120 mV/4.7 k-ohms
---------	-------------------

Headphone Output/Impedance

(0.02% THD)	0.81 V/270 ohms
-------------	-----------------

Frequency Response

Aux/Tape/Tuner (20 Hz to 20 kHz)	+0, -1 dB
-------------------------------------	-----------

RIAA Deviation

Phono MM (20 Hz to 20 kHz)	\pm 0.5 dB
Phono MC (50 Hz to 20 kHz)	\pm 0.5 dB

Total Harmonic Distortion (20 Hz to 20 kHz)

Phono MM to Rec Out (1 V)	0.008%
Phono MC to Rec Out (1 V)	0.008%
Aux/Tape/Tuner to Sp Out (1 W/8 ohms)	0.008%

Intermodulation Distortion

Aux/Tape/Tuner (Rated Power/8 ohms)	0.01%
--	-------

Signal-to-Noise Ratio (IHF A Network)

Phono MM (5 mV, Input Shorted)	88 dB
Phono MC (500 μ V, Input Shorted)	75 dB
Aux/Tape/Tuner (AM position, Input Shorted)	100 dB

Signal-to-Noise Ratio (New IHF)

Phono MM	72 dB
Phono MC	74 dB
Aux/Tape/Tuner (AM Position)	81 dB

Residual Noise

(IHF A Net work)	140 μ V
------------------	-------------

Channel Separation (1 kHz)

Phono MM (Input Shorted)	60 dB
Aux/Tape (5.1 k-ohms Shorted)	60 dB

Filter Characteristics

Low (Subsonic, Built-in)	15 Hz, -12 dB/oct
--------------------------	-------------------

CCSS Tone Control Characteristics

Loudness	
Preset 60/250/1k/4k/16kHz	0/-1/-2/-2/-1 dB
Max. 60/250/1k/4k/16kHz	-1/-5/-12/-12/-5 dB
Bass	
Preset 60/250/1k/4k/16kHz	4/3/1/0/0 dB
Max. 60/250/1k/4k/16kHz	10/6/1/0/-1 dB
Presence	
Preset 60/250/1k/4k/16kHz	0/0/2/4/2 dB
Max. 60/250/1k/4k/16kHz	-2/0/6/9/5 dB
Treble	
Preset 60/250/1k/4k/16kHz	0/0/0/3/6 dB
Max. 60/250/1k/4k/16kHz	0/0/1/7/11 dB
High Filter	
Preset 60/250/1k/4k/16kHz	0/0/0/-2/-2 dB
Max. 60/250/1k/4k/16kHz	0/0/-2/-7/-13 dB

FM SECTION

Tuning Range

	87.5 to 108.0 MHz
50 dB Quieting Sensitivity (IHF, 75 ohms)	
Mono/Stereo	1.5 μ V (14.8 dBf)/ 20 μ V (37.3 dB)

Usable Sensitivity (30 dB Quieting,

75 ohms, Mono)	0.75 μ V (8.8 dBf)
Image Response Ratio	75 dB
IF Response Ratio	95 dB
Spurious Response Ratio	95 dB
AM Suppression Ratio	66 dB
Capture Ratio	1.2 dB (Local) 2.5 dB (DX)

Alternate Channel Selectivity

(IHF)	35 dB (Local)/85 dB (DX)
-------	--------------------------

Signal-to-Noise Ratio (IHF)

Mono/Stereo	88 dB/83 dB
-------------	-------------

Harmonic Distortion (Local)

Mono	
(100 Hz/1 kHz/6 kHz)	0.05%/0.05%/0.1%
Stereo	
(100 Hz/1 kHz/6 kHz)	0.07%/0.07%/0.15%

Stereo Separation (IHF, Local)

50 Hz/1 kHz/10 kHz	50 dB/50 dB/45 dB
--------------------	-------------------

Frequency Response

50 Hz to 10 kHz	\pm 0.3 dB
30 Hz to 15 kHz	+0.3, -0.5 dB

Subcarrier Product Ratio (IHF)

	55 dB
--	-------

AM SECTION

Tuning Range

	510 kHz to 1,620 kHz
--	----------------------

Usable Sensitivity

	250 μ V/m
--	---------------

Selectivity

	25 dB
--	-------

Signal-to-Noise Ratio

	52 dB
--	-------

Image Response Ratio

	40 dB
--	-------

Spurious Response Ratio

	50 dB
--	-------

Harmonic Distortion (400 Hz)

	0.3%
--	------

Output Level/Impedance (Fixed)

FM 100% mod, 1 kHz	500 mV/5 k-ohms
AM 30% mod, 400 Hz	150 mV/5 k-ohms

GENERAL

Power Supply

	120 V/60 Hz
--	-------------

Power Consumption

	410 W
--	-------

AC Outlet

Switched x 1	200 W max.
Unswitched x 2	200 W max. total

Dimensions (W x H x D)

	435 x 122 x 386 mm (17-1/8" x 4-13/16" x 15-3/16")
--	--

Weight

	11 kg (24 lbs. 3 oz.)
--	-----------------------

Specifications subject to change without notice.



SINCE 1887

NIPPON GAKKI CO., LTD. HAMAMATSU, JAPAN

Printed in Japan 832

Free Manuals Download Website

<http://myh66.com>

<http://usermanuals.us>

<http://www.somanuals.com>

<http://www.4manuals.cc>

<http://www.manual-lib.com>

<http://www.404manual.com>

<http://www.luxmanual.com>

<http://aubethermostatmanual.com>

Golf course search by state

<http://golfingnear.com>

Email search by domain

<http://emailbydomain.com>

Auto manuals search

<http://auto.somanuals.com>

TV manuals search

<http://tv.somanuals.com>