

RDX-E700

*DVD RECEIVER
AMPLI-TUNER DVD*



OWNER'S MANUAL
MODE D'EMPLOI
BEDIENUNGSANLEITUNG
BRUKSANVISNING
MANUALE DI ISTRUZIONI
MANUAL DE INSTRUCCIONES
GEBRUIKSAANWIJZING
ИНСТРУКЦИЯ ПО ЭКСПЛУАТАЦИИ

CAUTION: READ THIS BEFORE OPERATING YOUR UNIT.

- 1 To assure the finest performance, please read this manual carefully. Keep it in a safe place for future reference.
- 2 Install this sound system in a well ventilated, cool, dry, clean place with at least 10 cm on the top, 10 cm on the left and right, and 10 cm at the back of RDX-E700 — away from direct sunlight, heat sources, vibration, dust, moisture, and/or cold.
- 3 Locate this unit away from other electrical appliances, motors, or transformers to avoid humming sounds.
- 4 Do not expose this unit to sudden temperature changes from cold to hot, and do not locate this unit in an environment with high humidity (i.e. a room with a humidifier) to prevent condensation inside this unit, which may cause an electrical shock, fire, damage to this unit, and/or personal injury.
- 5 Avoid installing this unit where foreign object may fall onto this unit and/or this unit may be exposed to liquid dripping or splashing. On the top of this unit, do not place:
 - Other components, as they may cause damage and/or discoloration on the surface of this unit.
 - Burning objects (i.e. candles), as they may cause fire, damage to this unit, and/or personal injury.
 - Containers with liquid in them, as they may fall and liquid may cause electrical shock to the user and/or damage to this unit.
- 6 Do not cover this unit with a newspaper, tablecloth, curtain, etc. in order not to obstruct heat radiation. If the temperature inside this unit rises, it may cause fire, damage to this unit, and/or personal injury.
- 7 Do not plug in this unit to a wall outlet until all connections are complete.
- 8 Do not operate this unit upside-down. It may overheat, possibly causing damage.
- 9 Do not use force on switches, knobs and/or cords.
- 10 When disconnecting the power cable from the wall outlet, grasp the plug; do not pull the cable.
- 11 Do not clean this unit with chemical solvents; this might damage the finish. Use a clean, dry cloth.
- 12 Only voltage specified on this unit must be used. Using this unit with a higher voltage than specified is dangerous and may cause fire, damage to this unit, and/or personal injury. YAMAHA will not be held responsible for any damage resulting from use of this unit with a voltage other than specified.
- 13 To prevent damage by lightning, keep the power cord and outdoor antennas disconnected from a wall outlet or the unit during a lightning storm.
- 14 Do not attempt to modify or fix this unit. Contact qualified YAMAHA service personnel when any service is needed. The cabinet should never be opened for any reasons.
- 15 When not planning to use this unit for long periods of time (i.e. vacation), disconnect the AC power plug from the wall outlet.
- 16 Be sure to read the “TROUBLESHOOTING” section on common operating errors before concluding that this unit is faulty.
- 17 Before moving this unit, press STANDBY/ON to set this unit in standby mode, and disconnect the AC power plug from the wall outlet.
- 18 Condensation will form when the surrounding temperature changes suddenly. Disconnect the power cable from the outlet, then leave the unit alone.
- 19 When using the unit for a long time, the unit may become warm. Turn the power off, then leave the unit alone for cooling.

This unit is not disconnected from the AC power source as long as it is connected to the wall outlet, even if this unit itself is turned off. This state is called the standby mode. In this state, this unit is designed to consume a very small quantity of power.

FOR CANADIAN CUSTOMERS

To prevent electric shock, match wide blade of plug to wide slot and fully insert.
This Class B digital apparatus complies with Canadian ICES-003.

DANGER

When this unit is plugged to the wall outlet, do not place your eyes close to the opening of the disc tray and other openings to look into inside.

The laser component in this product is capable of emitting radiation exceeding the limit for Class 1.

WARNING

TO REDUCE THE RISK OF FIRE OR ELECTRIC SHOCK, DO NOT EXPOSE THIS APPLIANCE TO RAIN OR MOISTURE.

■ For U.K. customers

If the socket outlets in the home are not suitable for the plug supplied with this appliance, it should be cut off and an appropriate 3 pin plug fitted. For details, refer to the instructions described below.

Note

The plug severed from the mains lead must be destroyed, as a plug with bared flexible cord is hazardous if engaged in a live socket outlet.

■ Special Instructions for U.K. Model

IMPORTANT

THE WIRES IN MAINS LEAD ARE COLOURED IN ACCORDANCE WITH THE FOLLOWING CODE:

Blue: NEUTRAL

Brown: LIVE

As the colours of the wires in the mains lead of this apparatus may not correspond with the coloured markings identifying the terminals in your plug, proceed as follows: The wire which is coloured BLUE must be connected to the terminal which is marked with the letter N or coloured BLACK. The wire which is coloured BROWN must be connected to the terminal which is marked with the letter L or coloured RED.

Making sure that neither core is connected to the earth terminal of the three pin plug.

CONTENTS

INTRODUCTION

FEATURES	2
About this manual.....	2
SUPPLIED ACCESSORIES	2
CONTROLS AND FUNCTIONS	3
Front panel.....	3
Display.....	4
Remote control.....	5

PREPARATION

CONNECTING SPEAKERS	7
Connecting speakers.....	8
Connecting a subwoofer.....	8
CONNECTING A TV	9
CONNECTING ANTENNAS	10
Connecting the AM loop antenna.....	10
Connecting the FM antenna.....	10
CONNECTING EXTERNAL COMPONENTS	11
Connecting a CD recorder or MD recorder.....	11
Connecting the Power Cables.....	12
INSTALLING BATTERIES IN THE REMOTE CONTROL	13
USING THE REMOTE CONTROL	13

BASIC OPERATION

TURNING THE POWER TO ON/STANDBY	14
SELECTING AN INPUT SOURCE	14
ADJUSTING THE VOLUME LEVEL	15
MUTING THE SOUND (MUTE)	15
ADJUSTING THE CLOCK	16
SETTING THE TIMER	16
SETTING THE SLEEP TIMER	17
CHANGING THE BRIGHTNESS OF THE DISPLAY	18
CHANGING DVD SETTING ON THE TV (OSD MENU)	19
Operating the OSD menu.....	19
OSD guide.....	20
SUPPORTED DISC TYPES	21
BASIC PLAYBACK OPERATIONS	22
USEFUL PLAYBACK OPERATIONS	23
Customizing playback order (Program Play).....	23
Playing back randomly (Random Play).....	24
Playing back repeatedly (Repeat Play).....	25
Operating disc menus (DVD menu/Video CD Playback Control).....	27
SELECTING AUDIO, SUBTITLE AND ANGLE	28
Selecting Audio and Subtitle Languages.....	28
Selecting a Viewing Angle.....	28

ZOOMING IMAGES	29
USING GUI	30
ENJOYING HIGH-QUALITY VIDEO (NTSC/PROGRESSIVE SCAN)	31
ENJOYING MULTIMEDIA FILES ON DISCS	32
TUNING RADIO STATIONS	33
Tuning radio stations automatically (Auto Tuning).....	33
Tuning radio stations manually (Manual Tuning).....	33
Selecting preset radio stations (Preset Tuning).....	34
Receiving FM Radio Data System stations (U.K. and Europe models only).....	34
PRESETTING RADIO STATIONS	36
Presetting radio stations automatically (Auto Preset).....	36
Presetting radio stations manually (Manual Preset).....	36
Editing the name of preset radio stations.....	37

ADVANCED OPERATION

PLAYING BACK EXTERNAL SOURCES	38
TV playback.....	38
Other component playback.....	38
RECORDING SOURCES WITH EXTERNAL COMPONENTS	39
Recording audio sources with the DVD receiver.....	39
ADJUSTING SOUNDS	40
Adjusting Sound Settings.....	40
Night listening mode.....	41
CONTROLLING EXTERNAL COMPONENTS	42
Setting remote control codes.....	42
Available operations.....	43

ADDITIONAL INFORMATION

TROUBLESHOOTING	44
General.....	44
Remote control.....	45
Disc playback.....	46
Radio reception.....	47
ADDITIONAL INFORMATION	48
Disc Information.....	48
Handling a disc.....	49
GLOSSARY	50
Audio formats.....	50
Audio information.....	50
Video signal information.....	51
Copyright and logo marks.....	51
SPECIFICATIONS	52

INTRODUCTION

PREPARATION

BASIC OPERATION

ADVANCED OPERATION

ADDITIONAL INFORMATION

English

FEATURES

- Plays DVDs, Video CDs, Audio CDs, MP3 CDs, WMA CDs, DivX CDs and JPEG CDs.
- Easy operation with the MULTI JOG
- Full function remote control
- On Screen Display (OSD) Menu
- DIGITAL OPTICAL OUT jack

About this manual

- In this manual, operations that can be performed using either the DVD receiver or its remote control are explained using the remote control.
- Remote control descriptions and illustrations in this manual are based on the U.K. and Europe models unless otherwise specified.
-  indicates a tip for your operation.
- Notes contain important information about safety and operating instructions.
- This manual is printed prior to production. Design and specifications are subject to change in part as a result of improvements, etc. In case of differences between the manual and the product, the product has priority.

SUPPLIED ACCESSORIES

This product includes the following accessories. Before connecting speakers or a TV to this product, make sure you received all of the following parts.

Remote control

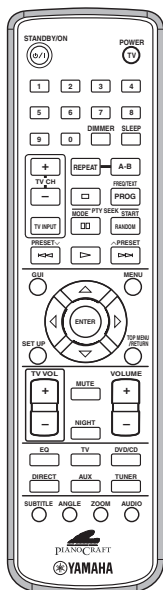

**Batteries (x2)
(AA, R06, UM-3)**

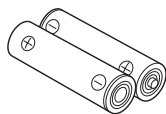

Indoor FM antenna

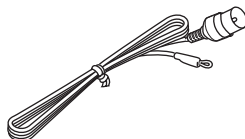

Video pin cable

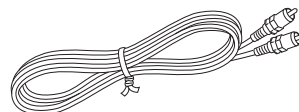

AM loop antenna

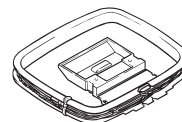

CONTROLS AND FUNCTIONS

Front panel

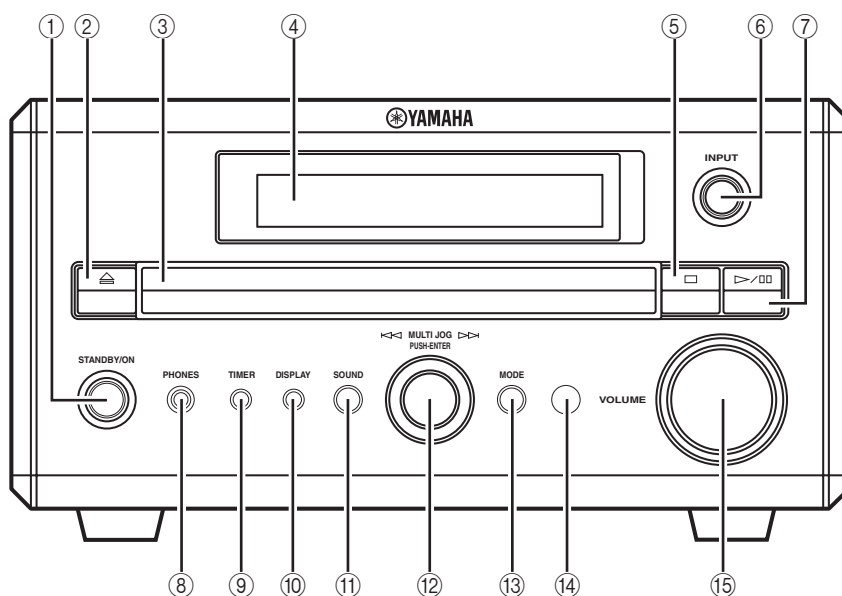

① **STANDBY/ON**

Turns this unit on. Press this button again to set the unit to the standby mode (page 14).

②

Opens and closes the disc tray. Pressing  during standby mode turns on the DVD receiver and sets the input source to DVD/CD.

③ **Disc tray**

Holds a disc to be played.

④ **Display**

Displays playback information or settings (page 4).

⑤

Stops disc playback.

⑥ **INPUT**

Selects an input source.

⑦

Starts and pauses disc playback.

⑧ **PHONES jack**

Connects headphones.

⑨ **TIMER**

Sets the DVD receiver to the timer play mode or sleep mode.

⑩ **DISPLAY**

Displays the status information such as the elapsed time of current track/chapter.

⑪ **SOUND**

Switches the sound settings to be adjusted.

⑫ **MULTI JOG**

Adjusts various settings and the frequency when tuning radio station. You can also skip chapters or tracks when the input source is set to DVD/CD.

⑬ **MODE**

Supports MULTI JOG and enables various operations.

⑭ **Remote control sensor**

Receives signals from the remote control.

⑮ **VOLUME**

Adjusts the volume level.

Display

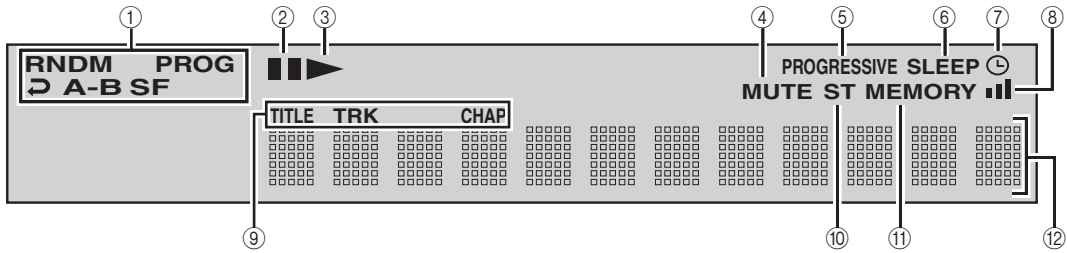

① **Playback mode indicator**

Displays the icon for the selected playback mode.

② **Pause icon**

Lights up when disc playback is paused.

③ **Playback icon**

Lights up during disc playback.

④ **MUTE**

Lights up when the mute function is activated.

⑤ **PROGRESSIVE**

Lights up when the progressive scan function is activated.

⑥ **SLEEP**

Lights up when the sleep timer function is activated.

⑦ **⌚**

Lights up when the timer play function is activated.

⑧ **▬▬▬**

Lights up when receiving a strong radio signal when the input source is set to AM or FM.

⑨ **Display mode indicator**

Lights up depending on the disc type.

⑩ **ST**

Lights up when receiving a strong FM radio signal in the FM stereo mode.

⑪ **MEMORY**

Lights up or blinks when presetting an FM/AM radio station.

⑫ **Display**

Displays various information such as a title, chapter or track number, or elapsed playing time.

Remote control

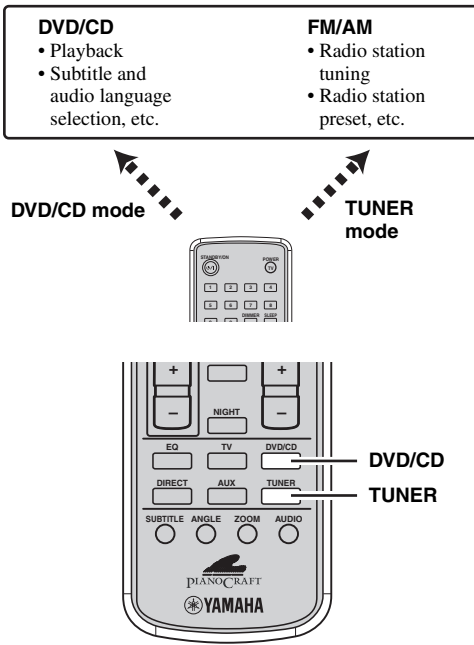

Note

Remote control descriptions and illustrations in this manual are based on the U.K. and Europe models unless otherwise specified.

The DVD receiver has two main operation modes. Before operating functions in each mode, you need to select a mode to change the remote control button assignments.

To switch the operation mode

- **DVD/CD mode:** Press DVD/CD.
- **TUNER mode:** Press TUNER. For details on tuner operations, refer to “TUNING RADIO STATIONS” (page 33).



You can also operate the TV and other components connected to the DVD receiver using the remote control. For details, refer to “CONTROLLING EXTERNAL COMPONENTS” (page 42).

Common functions

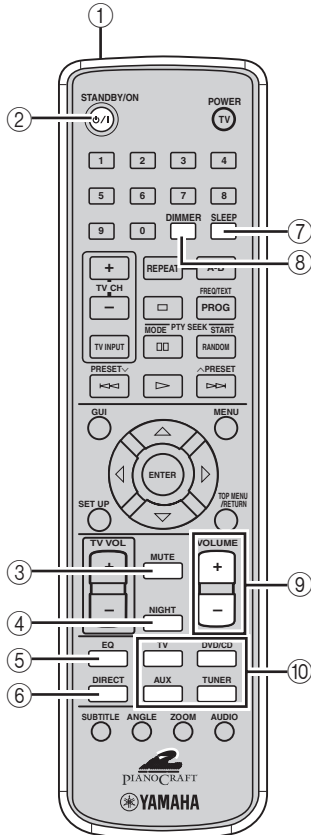

Operations common to all modes

① Infrared signal transmitter

Sends signals to the DVD receiver.

② STANDBY/ON (⏻/⏻)

Turn the DVD receiver on, or set it to the standby mode (page 14).

③ MUTE

Turns off the volume. Press again to resume the volume.

④ NIGHT

Switches the night listening mode on or off (page 41).

⑤ EQ

Switches the EQ MODE (page 40).

⑥ DIRECT

Switches the DIRECT mode on or off.

⑦ SLEEP

Sets the sleep timer (page 17).

⑧ DIMMER

Changes the brightness of the display (page 18).

⑨ VOLUME +/-

Adjusts the overall volume level.



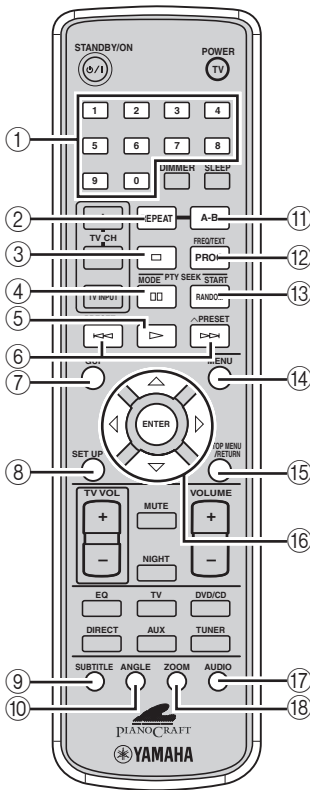

⑩ Input selection buttons

Selects the input source of the DVD receiver (page 14).

■ DVD/CD mode

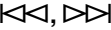

Operations available only in DVD/CD mode

- ① **Number buttons (1 to 9, 0)**
Press these buttons to enter numbers.
- ② **REPEAT**
Enables the Repeat Play mode (page 25).
- ③ 
Stops disc playback.
- ④ 
Pauses disc playback.
- ⑤ 
Starts disc playback.
- ⑥ 
Skips to the start of the current chapter/track or next chapter/track.
- ⑦ **GUI**
Displays the status information such as the elapsed time of current track/chapter on the TV screen.
- ⑧ **SET UP**
Displays the OSD menu on the TV screen (page 19).
- ⑨ **SUBTITLE**
Selects subtitle language (page 28).
- ⑩ **ANGLE**
Selects a viewing angle (page 28).
- ⑪ **A-B**
Enables the A-B Repeat mode (page 26).
- ⑫ **PROG**
Enables the Program Play mode (page 23).
- ⑬ **RANDOM**
Enables the Random Play mode (page 24).
- ⑭ **MENU**
Displays the DVD menu on the TV screen (page 27).
- ⑮ **TOP MENU/RETURN**
Returns the DVD menu to the previous screen (page 27).
- ⑯  **ENTER**
Operates the OSD menu (page 19).
- ⑰ **AUDIO**
Selects audio language (page 28).
- ⑱ **ZOOM**
Zooms in a specified part of picture (page 29).

CONNECTING SPEAKERS

Follow the procedure below to connect speakers to the DVD receiver. Here, the connection example uses the YAMAHA NX-E700 (consisting of two speakers) and its supplied cables. For information on your speakers, refer to the owner's manual for the speakers.



You can also use commercially available speakers (see page 8).

Notes

- Do not connect the power cable of the DVD receiver until all cable connections are completed.
- Be sure to connect the left channel (L), right channel (R), “+” (red) and “-” (black) properly. If the connections are faulty, no sound will be heard from the speakers, and if the polarity of the speaker connections is incorrect, the sound will be unnatural and lack bass.
- Do not let the bare speaker wires touch each other or do not let them touch any metal part of this unit. This could damage the DVD receiver and/or the speakers.
- Use speakers with the specified impedance shown on the rear panel of this unit.
- Use magnetically shielded speakers. If this type of speakers still creates the interference with the monitor, place the speakers away from the monitor.

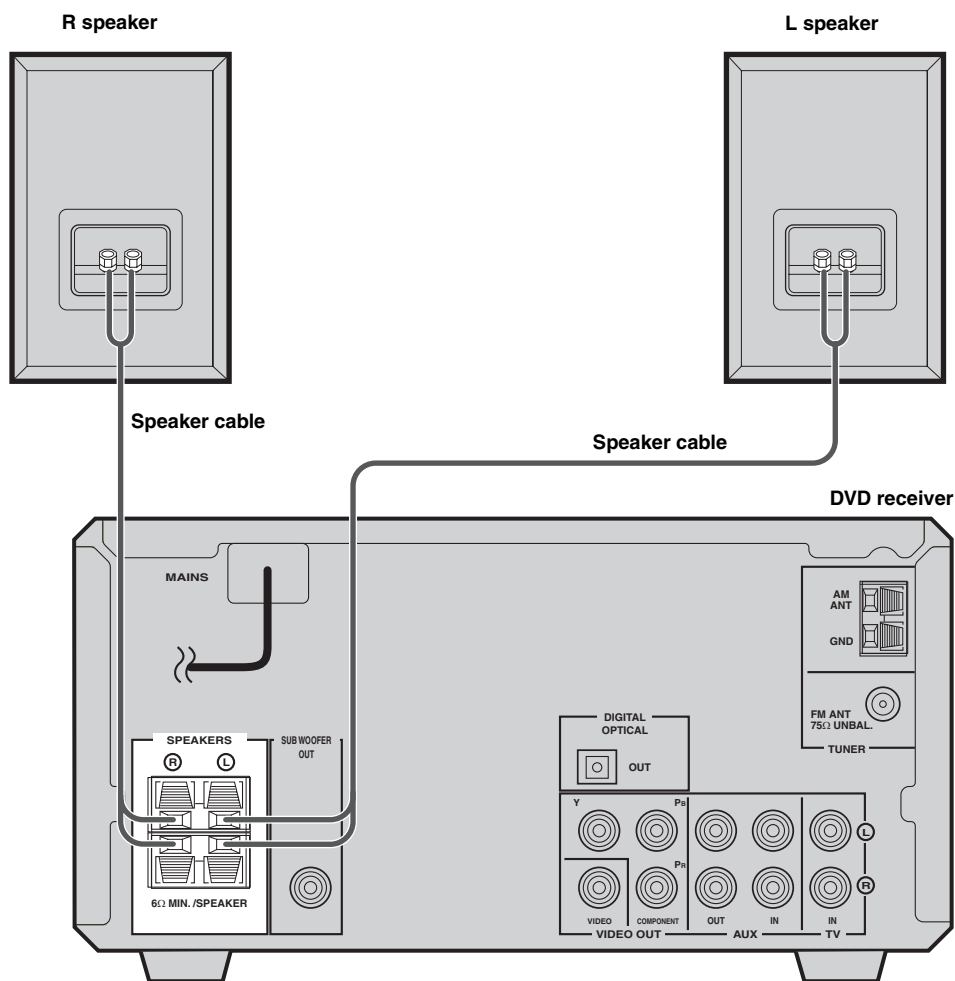

Connecting speakers

- 1 Remove approximately 10 mm (3/8 in) of insulation from the end of each speaker cable and twist the exposed wires of the cable together to prevent short circuits.

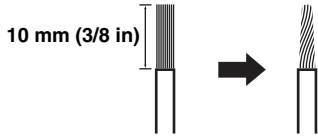

- 2 Press and hold the lever.

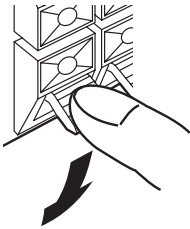

Red: positive (+)
Black: negative (-)

- 3 Insert one bare wire. By releasing the lever, the lever is replaced.

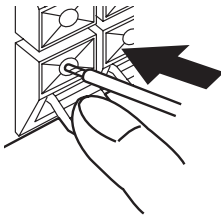

Red: positive (+)
Black: negative (-)

■ Notes on the speaker cord

A speaker cord is actually a pair of insulated cables running side by side. One cable is colored or shaped differently, perhaps with a stripe, groove or ridge. Connect the striped (grooved, etc.) cable to the “+” (red) terminals on the DVD receiver and your speaker. Connect the plain cable to the “-” (black) terminals on the DVD receiver and your speaker.

Connecting a subwoofer

Connect the SUBWOOFER OUT jack on the DVD receiver to the INPUT jack on the subwoofer using the subwoofer cable.

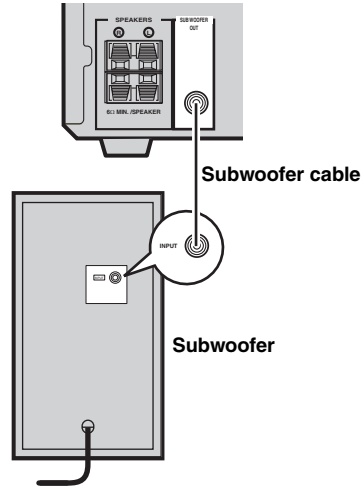

Notes

- Do not connect the power cable of the DVD receiver or subwoofer until all cable connections are completed.
- The low frequency range of the downmixed sound is output at the SUBWOOFER OUT jack.

CONNECTING A TV

Follow the procedure below to connect your TV to the DVD receiver using the supplied video pin cable and audio cables (sold separately). Also, you can enjoy high-quality pictures with a component video connection or a scart connection (U.K. and Europe models only). For information about your TV, refer to the supplied manual.

Notes

- Do not connect the power cable of the DVD receiver until all cable connections are completed.
- Turn off the TV before connecting it to the DVD receiver.

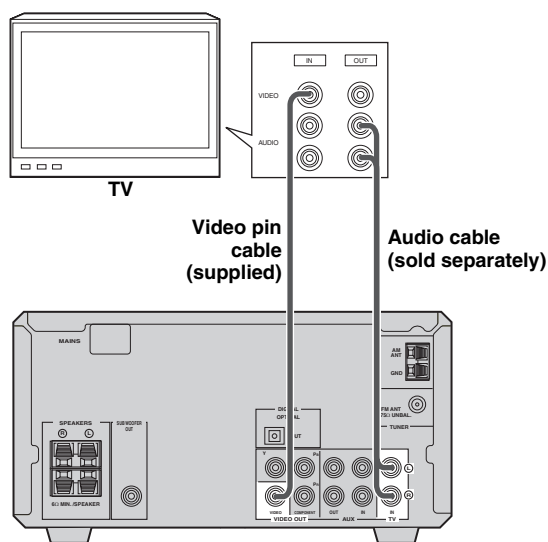

1 Connect the VIDEO jack on the DVD receiver to the video input jack on your TV using the supplied video pin cable.

2 To output sound from the speakers connected to the DVD receiver, connect the TV IN jacks on the DVD receiver to the audio output jacks on your TV using an audio pin cable (sold separately).

Other connection methods

To make a component video connection or a scart connection (U.K. and Europe models only), a corresponding cable is required.

Component video connection

Connect the VIDEO OUT COMPONENT jacks on the DVD receiver to the component video input jacks on your TV using a commercially available component video cable.

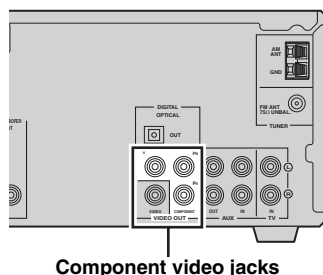

Scart connection (for U.K. and Europe models)

Connect the AV terminal on the DVD receiver to the scart input terminal on your TV using a commercially available scart cable.

(U.K. and Europe models)

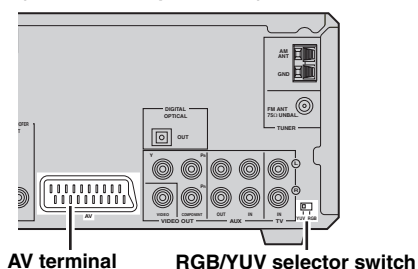

RGB/YUV selector switch

Selects the terminal where the video signals are output at. Slide this switch to the YUV position to output the component signals at the COMPONENT jacks. Slide this switch to the RGB position to output the RGB signals at the AV terminal.

Note

When the RGB/YUV selector switch is set to "RGB", Progressive Scan (page 31) is not available.

CONNECTING ANTENNAS

To enjoy radio on the DVD receiver, you need to connect AM and FM antennas to the DVD receiver. This product includes an AM loop antenna and indoor FM antenna. If there is a problem of weak radio wave reception in your area or you want to improve radio reception, we recommend that you use optional outdoor antennas. For details, consult the nearest authorized YAMAHA dealer or service center.

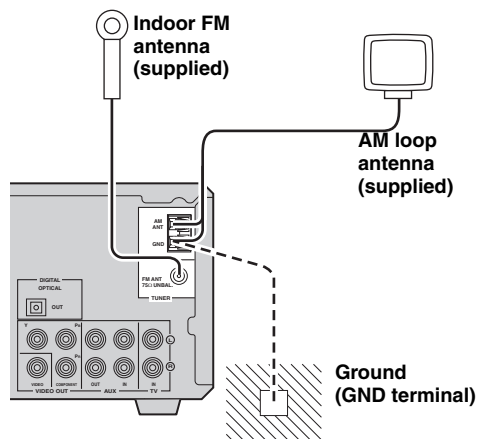

■ About grounding

For maximum safety and minimum interference, connect the antenna GND terminal to a good earth ground. A good earth ground is a metal stake driven into moist earth.

Connecting the AM loop antenna

1 Attach the antenna stand to the antenna.

When attaching the antenna to the wall, you do not need to use the antenna stand.

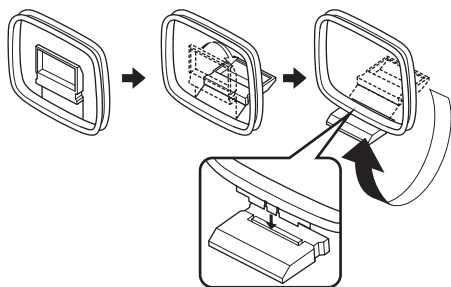

2 Press and hold the tab.

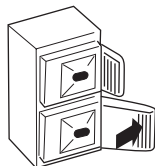

3 Insert the AM loop antenna lead wires into the AM ANT terminal.

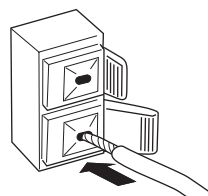

4 Release the tab.

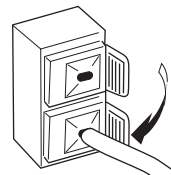

5 Repeat steps 2 to 4 to insert the AM loop antenna lead wires into the GND terminal.

6 Place the antenna away from the DVD receiver and speaker cables.

While listening to the radio, rotate the antenna head to find the best angle for reception.

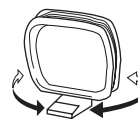

Connecting the FM antenna

1 Connect the supplied indoor FM antenna to the FM ANT jack on the DVD receiver.

2 Place the antenna away from the DVD receiver and speaker cables.

CONNECTING EXTERNAL COMPONENTS

You can connect external components such as a CD recorder or MD recorder to the following jacks on the DVD receiver. This section provides an example of other equipment connections. For information on your equipments, refer to the manuals for them.

Connecting a CD recorder or MD recorder

If you connect a CD recorder or MD recorder to the DVD receiver using optical cables, you can record audio sources played on the DVD receiver digitally. Also, you can enjoy audio sources played on the recorder with the DVD receiver.



AM/FM broadcasts cannot be output from this unit's DIGITAL OPTICAL OUT jack. To record AM/FM broadcasts, use a commercially available audio cable to connect the AUX OUT jack on the DVD receiver to the analog input jack on your recorder.

Notes

- Turn off the component before connecting it to the DVD receiver.
- Do not connect the power cable of the DVD receiver until all cable connections are completed.

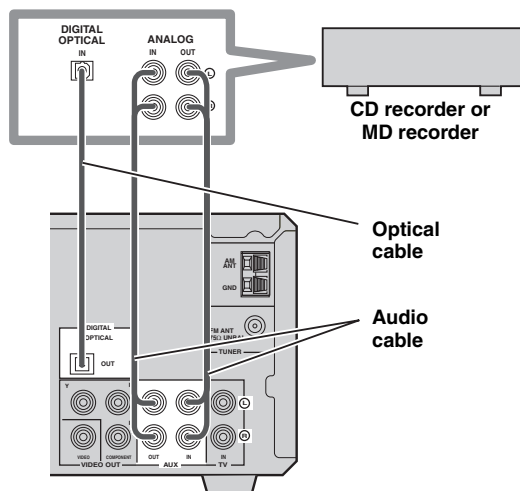

- 1** Connect the **DIGITAL OPTICAL OUT** jack on the DVD receiver to the digital input jack on the recorder using an optical cable.
- 2** Connect the **AUX OUT** jacks on the DVD receiver to the analog input jacks on the recorder using an audio cable.
- 3** Connect the **AUX IN** jacks on the DVD receiver to the analog output jacks on the recorder using an audio cable.

■ **About the AUX jacks**

- The signal input from the AUX IN jack is not output from the AUX OUT jack.
- The DVD receiver's digital and analog signal circuits are independent of each other. Analog input signals are output only from analog output jacks.

■ **About the DIGITAL jack**

- The digital jack is compatible with PCM, Dolby Digital and DTS signals.
- The digital jack is designed based on EIA standards. To make a digital connection, use an optical cable that meets EIA standards.



This unit can output a DTS signal digitally. To reproduce a DTS encoded source, connect the DIGITAL OPTICAL OUT jack on the DVD receiver to the digital input jack on a component that features a DTS decoder.

Connecting the Power Cables

After you made all connections, connect the power cables of the DVD receiver and subwoofer (optional).

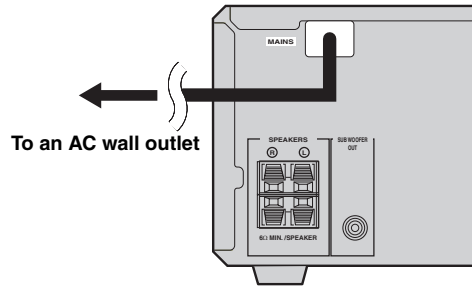

INSTALLING BATTERIES IN THE REMOTE CONTROL

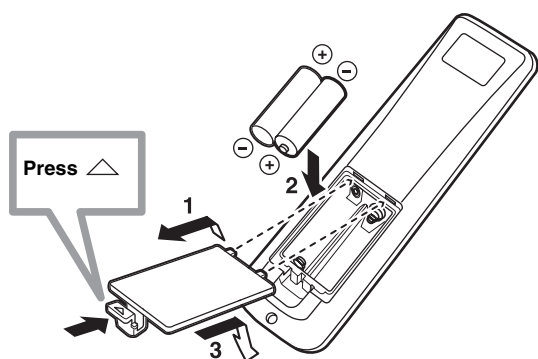

■ To replace the batteries

Change all of the batteries if the operation range of the remote controls decreases.

Notes

- Do not use an old battery together with new one.
- Do not use different types of batteries (for example, alkaline and manganese) together. Each type of battery has its own characteristics even if they are similar in shape.
- If the batteries run out, immediately remove them from the remote control to prevent an explosion or acid leak.
- Dispose of the batteries according to the regional regulations.
- If a battery starts leaking, dispose of it immediately. Be careful not to let leaking battery acid come into contact with your skin or clothing. Before inserting new batteries, wipe the compartment clean.
- Replace the batteries within two minutes to preserve the memory in the remote control.

1 Press the \triangle mark on the battery cover and open the cover.

2 Insert the two supplied batteries (AA, R06, UM-3) into the battery compartment.

Make sure you insert the batteries according to the polarity markings (+ and -).

3 Close the battery cover.

USING THE REMOTE CONTROL

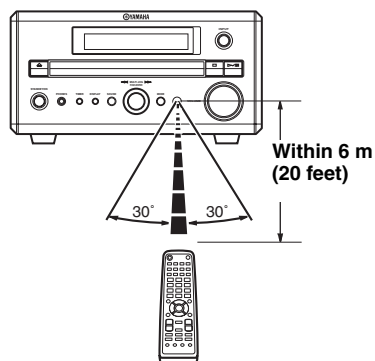

Use the remote control within 6 m (20 feet) of the DVD receiver and point it toward the remote control sensor (page 3).

Notes

- Be careful not to spill liquid on the remote control.
- Be careful not to drop the remote control.
- Do not leave the remote control in the following places:
 - hot or humid places, such as near a heater or in a bathroom
 - extremely cold places
 - dusty places

TURNING THE POWER TO ON/STANDBY

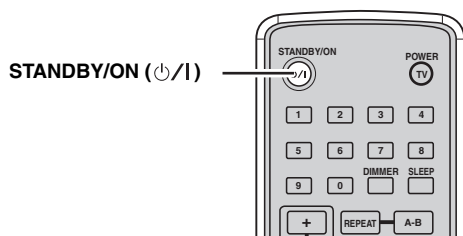

Press **STANDBY/ON** once to turn on the DVD receiver.

Press **STANDBY/ON** again to set the DVD receiver to the standby mode.



You can set the DVD receiver to the eco standby mode by pressing **DISPLAY** on the front panel during standby mode. In this mode, all display in the DVD receiver turns off. To cancel the eco standby mode, press **DISPLAY** during eco mode.

SELECTING AN INPUT SOURCE

You can enjoy various sources with the DVD receiver. After connecting the TV, speakers, antennas, or other equipment, follow the procedure below to select an input source you want to play on the DVD receiver. For information on connection methods, refer to pages 8 to 12.

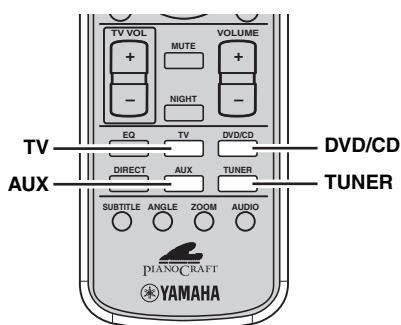

Perform one of the following operations

To switch to DVD/CD input:

Press DVD/CD.

To switch to external source input (external equipment connected to the DVD receiver):

Press AUX.

To switch to TV input:

Press TV.

U.K. and Europe models only

You can switch the input signals between signals input at the TV IN jacks and signals input at AV terminal (page 20).

To switch to tuner input (AM/FM radio):

Press TUNER.

Each time you press TUNER, the input source switches between AM and FM.

■ To select an input source using INPUT on the front panel

Press **INPUT** repeatedly.

Each time you press **INPUT**, the input source changes as follows:

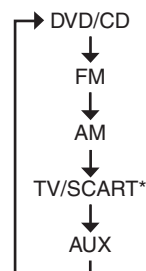

* SCART is applicable only for U.K and Europe models.

ADJUSTING THE VOLUME LEVEL

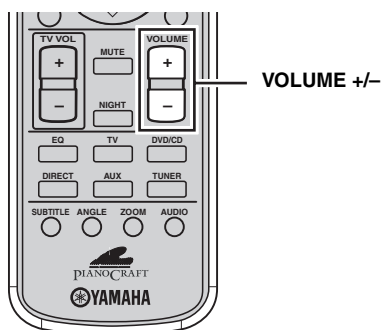

Press **VOLUME +** to increase the volume level and **VOLUME -** to decrease.

MUTING THE SOUND (MUTE)

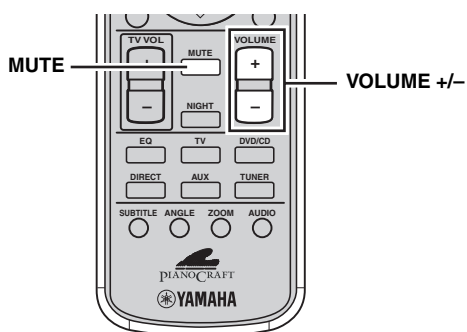

Press **MUTE** to mute the sound.

To restore audio output to the previous volume level, press **MUTE** again or press **VOLUME +/-**.

ADJUSTING THE CLOCK

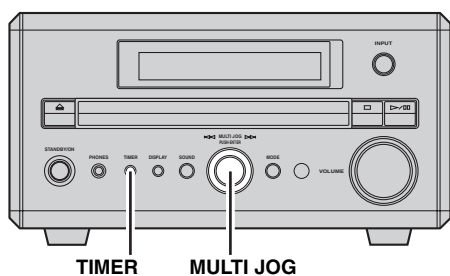

- 1 Press **TIMER** on the front panel to select “**TIME**” and then press **MULTI JOG**.
- 2 Rotate **MULTI JOG** to adjust the hour and then press **MULTI JOG**.
- 3 Rotate **MULTI JOG** to adjust the minute and then press **MULTI JOG**.
- 4 Press **MULTI JOG** again to set the time.

Note

You cannot set timer unless you adjust the clock.

SETTING THE TIMER

You can set the timer function so that the DVD receiver turns on at the specified time and begins to play the selected input source automatically.

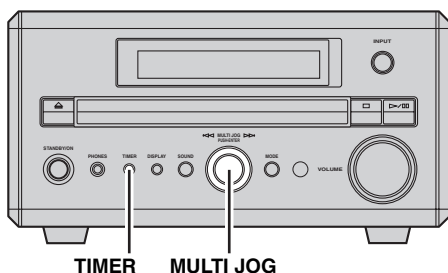

- 1 Press **TIMER** on the front panel to select “**TIMER**” and then press **MULTI JOG**.
- 2 Rotate **MULTI JOG** clockwise to select “**TIMER ON**” and then press **MULTI JOG**.
The current timer setting is displayed.
- 3 Set the time that timer play begins using the **MULTI JOG**, and then press **MULTI JOG**.
- 4 Rotate **MULTI JOG** to select the input source to be played and then press **MULTI JOG**.
- 5 Rotate **MULTI JOG** to set the duration (30 to 90 min) and then press **MULTI JOG**.
You can set the duration in 10 minutes steps.

■ To cancel the timer

Select “**TIMER OFF**” in step 2.

SETTING THE SLEEP TIMER

If you set the sleep timer, the DVD receiver automatically turns to the Standby mode after the specified time.

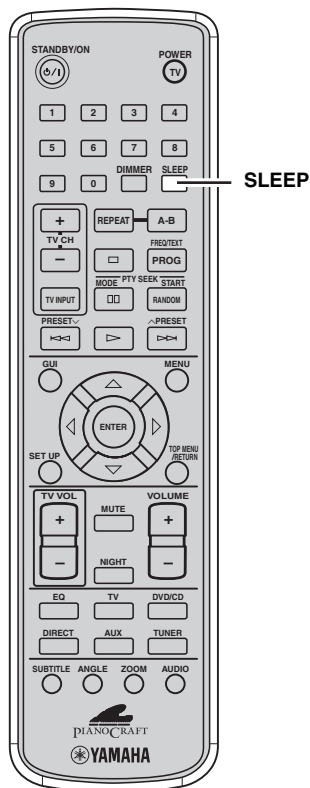

Press SLEEP repeatedly to set the duration for the sleep timer.

Each time you press SLEEP, the duration changes as follows:

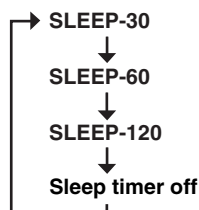

- The DVD receiver automatically turns to the dimmer mode.

Notes

- The sleep timer only works for the DVD receiver. It does not turn off other equipment connected to the DVD receiver.
- The sleep timer is canceled if you turn the DVD receiver to the Standby mode.
- The DVD receiver stores the mode or playback settings in its memory when it automatically turns to the Standby mode. You can use those settings when you turn on the DVD receiver next time.

■ To set the sleep timer using MULTI JOG

Press TIMER on the front panel repeatedly until “SLEEP” appears in the DVD receiver display.

Rotate MULTI JOG to set the duration (5 to 240 min).

You can set the duration in 5 minutes steps (5 to 60 min), 10 minutes steps (60 to 120 min), or 30 minutes steps (120 to 240 min).

■ To cancel the sleep timer

Press SLEEP repeatedly until “SLEEP” disappears from the DVD receiver display.

You can also cancel the sleep timer using MULTI JOG.

Press TIMER on the front panel repeatedly until “SLEEP” appears in the DVD receiver display, and then rotate MULTI JOG to select “SLEEP-00”.

CHANGING THE BRIGHTNESS OF THE DISPLAY

You can change the brightness of the DVD receiver display.

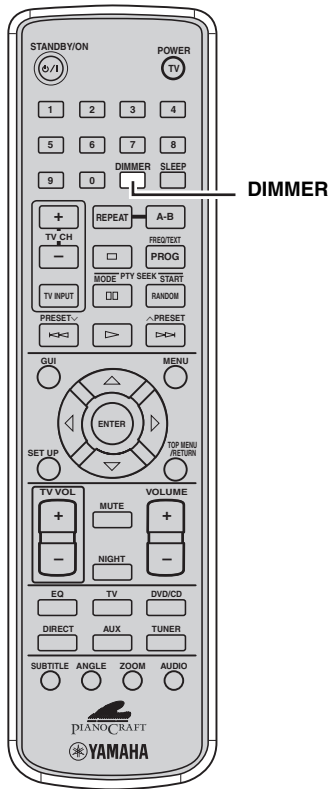

Press DIMMER.

Each time you press DIMMER, the brightness of the display switches between Dimmer on and Dimmer off.

■ To cancel the dimmer mode

Press DIMMER again.

CHANGING DVD SETTING ON THE TV (OSD MENU)

You can change various settings for DVD playback using the OSD (on-screen display) menu displayed on the TV screen connected to the DVD receiver. For details on the available menu items, refer to “OSD guide” (page 20).

Operating the OSD menu

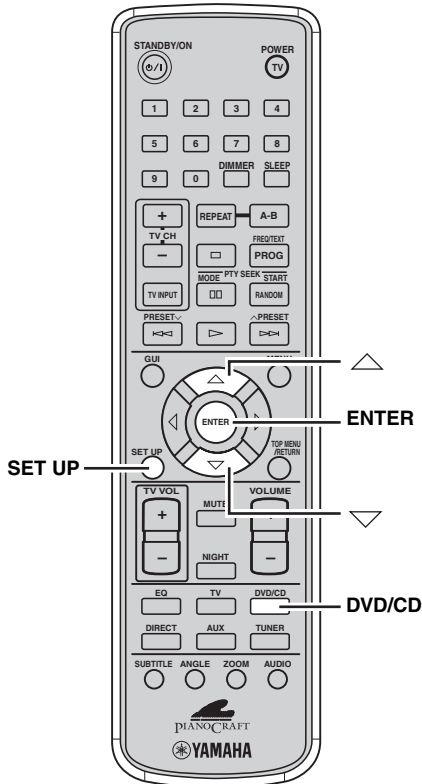

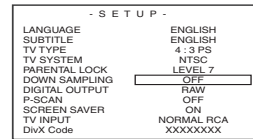

- 1 Press DVD/CD and then press SET UP to display the OSD menu on the TV screen.
- 2 Press \triangle or ∇ to select a menu item, then press ENTER repeatedly to select the setting for the item.



- 3 Press SET UP to exit the OSD menu.

OSD guide

Menu	Function
LANGUAGE	Sets the language for the OSD menu and messages. Select a setting from English, German, French, Spanish, Italian, and Simplified Chinese. Simplified Chinese is available only for General model. This setting also changes the language for audio. If the selected language is not available on the DVD, one of the actual recorded language is automatically selected.
SUBTITLE	Sets the language for subtitle. Select a setting from off, English, German, French, Spanish, Italian, etc. If the selected language is not available on the DVD, one of the actual recorded language is automatically selected.
TV TYPE	Sets the screen aspect of your TV. Select a setting from "4:3 PS" (4:3 Pan&Scan), "4:3 LB" (4:3 Letter Box) and "16:9".
TV SYSTEM	<p>Sets the video signal system of your TV to "PAL", "NTSC" or "AUTO". When using a TV compatible with both NTSC and PAL, set this to "AUTO".</p>  <p>You can change the video signal system by pressing GUI when the OSD menu is displayed.</p> <p>Notes</p> <ul style="list-style-type: none"> • If you play a PAL-formatted disc with the "NTSC" setting or an NTSC-formatted disc with the "PAL" setting, the video quality may deteriorate. • Depending on the video format, the "AUTO" setting may not work properly. In this case, try the "NTSC" or "PAL" setting.
PARENTAL LOCK	<p>Sets the restriction level for the DVD playback. Some DVD discs contain a restriction level which enables parents to remove scenes or prevent playback of discs by children. You can change a password to prevent children from changing a level. <PASSWORD> Use the number buttons to change the "PARENTAL LOCK" settings. The default password is set to "1234". <RATING> UNLOCK: "PARENTAL LOCK" is disabled. LEVEL 1 to 7: The lower the level, the stricter the restrictions. ADULT: Select this when you want to play all DVDs. <CHANGE PASSWORD> Enter a new password in both the "NEW PASSWORD" field and the "CONFIRM PASSWORD" field.</p>
DOWN SAMPLING	<p>Sets the LPCM 48 kHz down sampling to "OFF" or "ON". OFF: The audio signal output from the DIGITAL OPTICAL OUT jack is not down sampled. ON: The audio signal output from the DIGITAL OPTICAL OUT jack is down sampled to LPCM 48 kHz.</p>
DIGITAL OUTPUT	<p>Sets the output signal of the DIGITAL OPTICAL OUT jack to "RAW" or "PCM". RAW: Outputs all types of digital signal that the DVD receiver can produce. PCM: Converts the signal (except for DTS sources) to PCM before outputting it.</p> <p>Note</p> <p>Signals are not output from the speakers or AUX OUT jacks during playback of DTS sources.</p>
P-SCAN	<p>Sets the output signal of the VIDEO OUT COMPONENT jacks. OFF: Interlace signals are output from the VIDEO OUT COMPONENT jacks. ON: Progressive signals are output from the VIDEO OUT COMPONENT jacks.</p>  <p>You can turn on or off the Progressive Scan mode by pressing ZOOM when the OSD menu is displayed.</p>
SCREEN SAVER	<p>Sets the screen saver function (page 22). ON: The screen saver works. OFF: The screen saver does not work.</p>
TV INPUT	<p>(U.K and Europe models only) Switches the input signals when the input source is set to TV between signals input at the TV IN jacks and signals input at AV terminal. NORMAL RCA: Signals input at the TV IN jacks are reproduced. SCART: Signals input at the AV terminal are reproduced.</p>
DivX Code	<p>The DivX®VOD (Video On Demand) registration code appears. Use this registration code to purchase or rent the videos from DivX®VOD service at www.divx.com/vod. Follow the instructions and download the video onto a CD-R/RW for playback on this receiver. Note that all the videos downloaded from DivX®VOD can only be played back on this receiver. For more information, go to www.divx.com/vod.</p>

SUPPORTED DISC TYPES

You can enjoy movie or music discs with the DVD receiver. Since some DVD receiver disc operations are limited to specific disc types, the supported disc types are indicated using the icons shown below. Each icon means that the operation is limited to the corresponding disc type. For information on supported disc standards and disc usage notes, refer to “Disc Information” (page 48) and “Handling a disc” (page 49). Operations with no icon indicated are available for all disc types.

DVD video	Video CD	Music CD
DVD-V	VCD	CD

About MP3, WMA, DivX® and JPEG discs

You can play MP3, WMA and DivX® files recorded on a CD-R or CD-RW with similar uses as a music CD or a DVD. The DVD receiver regards folders in the disc as albums, and files as tracks (as shown below). Also you can play JPEG picture files recorded on a CD-R or CD-RW. For details about how to play these files, refer to “ENJOYING MULTIMEDIA FILES ON DISCS” (page 32).

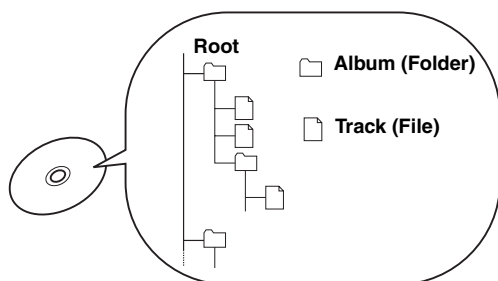

What is MP3?

“MP3 (MPEG-1 Audio Layer-3)” is a standard technology and format for compressing an audio sequence into a small-sized file. However it preserves the original level of sound quality when it is played.

Notes

- Depending on recording conditions such as recording software settings, the DVD receiver may not be able to play the disc or play tracks in the order they were recorded.
- The DVD receiver is compatible with a bit rate range of 32, 64, 96, 128, 192, 256 or 320 kbps and variable bit encoded MP3 files.
- The DVD receiver is compatible with a sampling frequency of 16, 32, 44.1, or 48 kHz.

What is WMA?

“WMA (Windows Media Audio)” is a Microsoft file format for encoding digital audio files similar to MP3 though can compress files at a higher rate than MP3.

What is JPEG?

“JPEG” is a compression format for still images. With only a slight drop in image quality (part of the data is removed), still image data can be compressed to approximately 1/10 to 1/100 of its original size.

Note

This unit does not support the progressive JPEG format.

What is DivX®?

“DivX®” is a video compression technology developed by DivX® Networks, Inc. It compresses digital video data to sizes small enough to be transported over the Internet without reducing the original video quality. You need DivX® codec software to play back DivX® movies or convert data to the DivX® format.

BASIC PLAYBACK OPERATIONS

Follow the procedures below to carry out basic disc playback operations. The DVD receiver also provides various useful functions for disc playback. For details, refer to “USEFUL PLAYBACK OPERATIONS” (page 23).

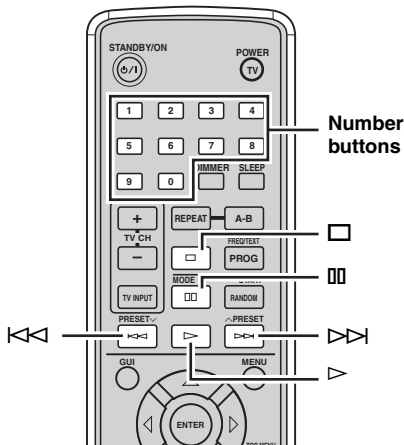

■ To start playback

Press \triangleright .



• If you do not perform any operations for 180 minutes after a menu screen appears on your TV, the DVD receiver turns into the screen saver mode. To cancel the screen saver mode, press any button. If you do not perform any operations for 30 minutes after the DVD receiver turns into the screen saver mode, the DVD receiver turns into the standby mode.

- **CD** You can play back the first 10 seconds of each track by pressing and holding \triangleright . Press \triangleright again to play back the current track.

■ To stop playback

Press \square .



Whenever you stop playback, the DVD receiver automatically memorizes the stopping position, and “RESUME” appears in the front panel display. If you press \triangleright , playback resumes from where it left off.

■ To pause playback

Press \square .

To return to normal playback, press \triangleright .



If you do not perform any operations for 15 minutes after you stop or pause the disc playback, the DVD receiver turns into the screen saver mode. To cancel the screen saver mode, press any button. If you do not perform any operations for 30 minutes after the DVD receiver turns into the screen saver mode, the DVD receiver turns into the standby mode.

■ To fast reverse or fast forward



To fast reverse, press and hold \lll . To fast forward, press and hold \ggg .

Once fast reverse or fast forward starts, you can change the speed (2X, 4X, 8X, or 20X) by pressing \lll or \ggg repeatedly. Press \triangleright to resume the normal playback.

Note

The speakers do not produce any sound if you fast forward/reverse while playing a Dolby Digital disc.

■ To skip chapters (tracks)

To skip to the start of the current chapter (track), press \lll .

To skip to the next chapter (track), press \ggg .

To skip to the previous chapter (track), quickly press \lll twice.

Note

The Skip feature may not work properly when using Playback Control (page 27) to play a video CD.

■ To specify a track for playback

VCD **CD**

Use the number buttons to enter the track number you want to play and then press \triangleright .

To enter 2-digit number, press a number button for the second digit place, then press a number button for the first digit place.

USEFUL PLAYBACK OPERATIONS

You can enjoy movie or music discs with various useful features on the DVD receiver. For information on basic disc playback operations, refer to “BASIC PLAYBACK OPERATIONS” (page 22).

Customizing playback order (Program Play)

You can customize the playback order. You can also display the playback order or clear all Program Play contents after customizing the playback order.

Note

To customize playback order, turn on the TV connected to the DVD receiver.

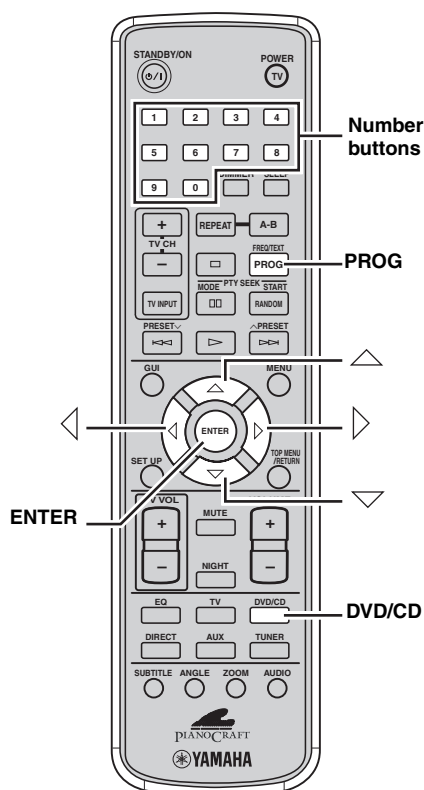

- 1 Press **DVD/CD**, then press **PROG** while the disc playback is stopped.

The “Program Input” screen appears on the TV screen.

- 2 Press number buttons to enter a track or title/ chapter pair to be programmed.

- 3 $\triangle / \nabla / \blacktriangleleft / \blacktriangleright$ to move the cursor to the next field.

- 4 Repeat steps 2 and 3 until you store all desired tracks.

You can store up to 12 tracks or title/chapter pairs.

- 5 Press $\triangle / \nabla / \blacktriangleleft / \blacktriangleright$ to select “Play Program” and then press **ENTER**.

The “PROG” indicator lights up in the DVD receiver display, the OSD menu disappears, and Program Play starts automatically. If playback does not start automatically, press \blacktriangleright .

Note

The program play function is not available when the video CD Playback control feature is turned on.





You can play the programmed tracks repeatedly (page 25).

Playing back randomly (Random Play)

You can shuffle tracks or chapters.

Notes

- Random Play may not work depending on DVD disc types.
- If you press  during random playback, the next track or chapter will be randomly selected and played. If you press , the currently played track or chapter will be played from the beginning. A track or chapter cannot be replayed during random playback.

Press RANDOM.

The “RANDOM” indicator lights up in the DVD receiver display.

■ To cancel Random Play

Press RANDOM again.

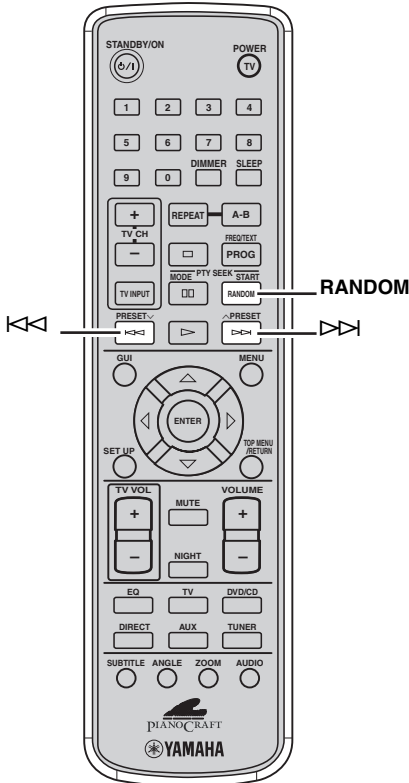

Playing back repeatedly (Repeat Play)

You can repeat single chapter (track), single title, or entire disc. Also, you can set two points (start and end points) to repeat the specified section of a title (track) with A-B Repeat (page 26).

Notes

- Repeat Play may not work depending on DVD disc types.
- Repeat Play does not work while playing back a video CD using the Playback control feature (page 27).

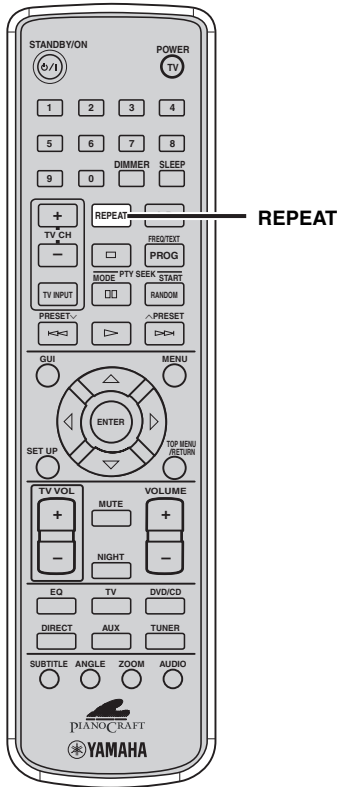

1 Play back the disc, title, chapter or track you want to repeat.

For details, refer to “BASIC PLAYBACK OPERATIONS” (page 22).

2 Press REPEAT repeatedly.

The REPEAT indicator (↷) lights up in the DVD receiver display.

Each time you press REPEAT, the indicator in the DVD receiver display changes as follows:

DVD-V

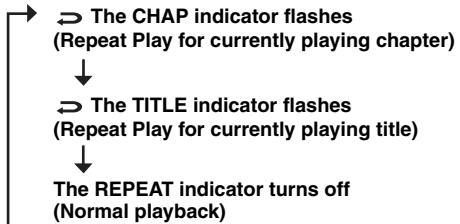

VCD CD

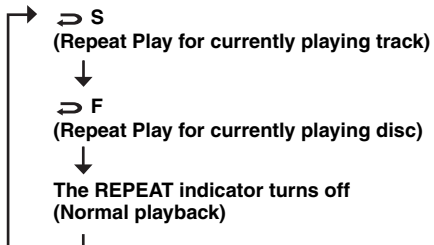

■ To cancel Repeat Play

Press REPEAT repeatedly until the REPEAT indicator turns off.

■ **To repeat between two points (A-B Repeat)**

You can repeat the specified section of a title (track) by setting two points (start and end points).

Notes

- A-B Repeat may not work depending on DVD disc types.
- You can use A-B Repeat only within one title (track).

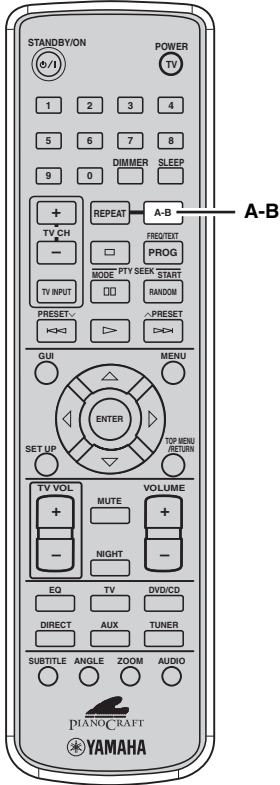

1 Play back the title or track that includes the section you want to repeat.

For details, refer to “BASIC PLAYBACK OPERATIONS” (page 22).

2 At the position where you want to set as the start point of the repeat section, press A-B.

The “➡ A-” indicator lights up in the DVD receiver display.

3 At the position where you want to set as the end point of the repeat section, press A-B again.

A-B Repeat starts.

The “➡ A-B” indicator lights up in the DVD receiver display.

■ **To cancel A-B Repeat**

Press A-B again.

The “➡ A-B” indicator turns off, and A-B Repeat is canceled.

Operating disc menus (DVD menu/ Video CD Playback Control)

Many DVDs and video CDs include original navigational menus called “DVD menus” and “video CD Playback Control menus”. These menus provide a convenient way to operate the disc. Follow the procedure below to use a DVD menu or video CD Playback Control with the DVD receiver.

Note

Menu contents or operation method of each disc may vary. For information about the disc you are using, refer to the operating instructions in the disc’s menu or on its jacket.

To operate the DVD menu **DVD-V**

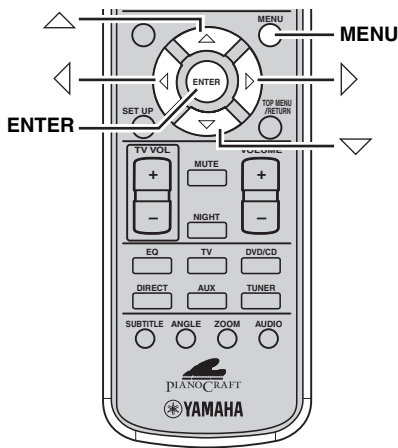

To operate the video CD Playback Control menu **VCD**

If you play back a video CD that includes the Playback Control feature, the menu automatically appears on the TV screen. To operate the Playback Control feature with the remote control, use the following buttons.

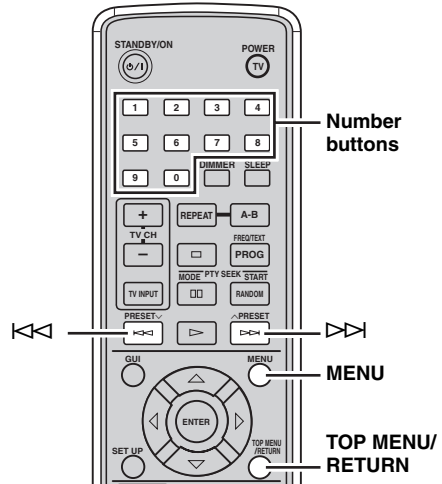

MENU: Turns on or off the Playback Control feature.

Number buttons: Selects an item.

▶▶: Moves to the next screen.

◀◀ or TOP MENU/RETURN: Returns to the previous screen.

1 Press MENU.

The DVD menu appears on the TV screen.



Depending on the disc, the DVD menu may automatically appear after the disc is loaded.

2 Press **▲ / ▼ / ◀ / ▶** to select a menu item, then press ENTER.

SELECTING AUDIO, SUBTITLE AND ANGLE DVD-V

You can select audio and subtitle languages for DVD playback. You can also select a viewing angle for DVD playback.

Note

This selection is available only with multi-language or multi-angle compatible discs. For information about the disc you are using, refer to the operating instructions in the disc's menu or on its jacket.

Selecting Audio and Subtitle Languages

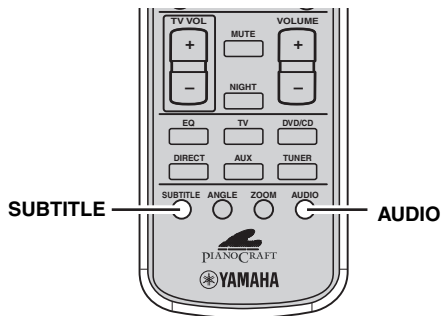

Selecting a Viewing Angle

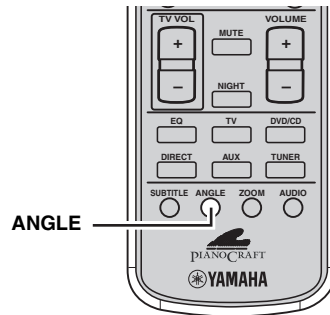

While playing a disc, press **ANGLE** repeatedly to select the viewing angle.

While playing a disc or pausing, press **AUDIO** or **SUBTITLE** repeatedly to select the language you want to use for audio or subtitle.

The audio language or subtitle language appears on the TV screen.

■ To turn off the subtitle

Select "Off".

ZOOMING IMAGES DVD-V

You can zoom in a specified part of picture during DVD or video CD playback.

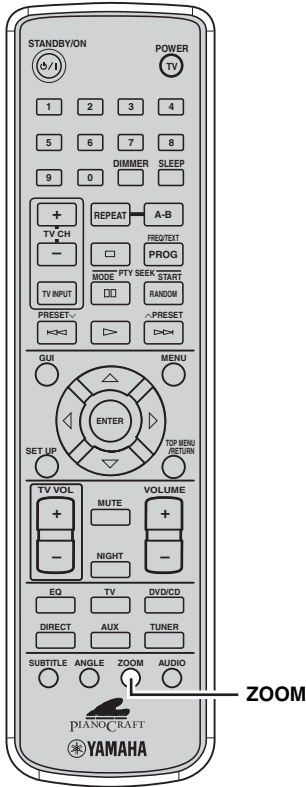

1 While playing a disc or pausing, press **ZOOM**.

The current zoom setting appears on the TV screen.

2 Press **ZOOM** repeatedly to select the zooming scale.

Each time you press ZOOM, the zooming changes as follows:

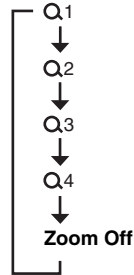

■ To return to the original scale

Select “Zoom Off”.



You can also zoom VCD, JPEG and DivX® images.

USING GUI

You can view various information of the currently played disc on the TV screen and specify an elapsed time where you want to start playback.

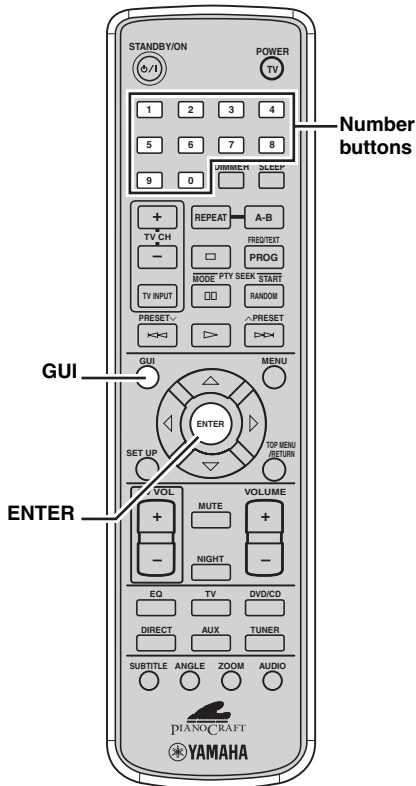

1 While playing a disc or pausing, press GUI.

The disc type, elapsed time, remaining time, title/chapter/track information, angle information, audio information, subtitle information and bitrate are displayed.

```
DVD VIDEO          00:08:32  02:07:27
Title 1/5          CHAPTER 4/52 Angle 1/1
Audio              1/3       6ch Eng
Preferred Sub      Off
Bitrate            7.168Mbps
```

2 Press GUI again.

The elapsed time input screen appears.

3 Use the number buttons to enter the elapsed time where you want to start playback and then press ENTER.

If you press GUI without pressing the number buttons, the elapsed time input screen disappears.

ENJOYING HIGH-QUALITY VIDEO (NTSC/PROGRESSIVE SCAN) **DVD-V**

Progressive Scan is video that represent a frame with one pass of sequential scan lines whereas interlace output video, which is usually adopted for most TVs, represents a frame with two passes. Progressive Scan provides better video quality by reducing picture noises. To enjoy DVDs with Progressive Scan, you need to connect the DVD receiver to a TV that has component video input jacks compatible with Progressive Scan. For details on connections, refer to “Other connection methods” (page 9).

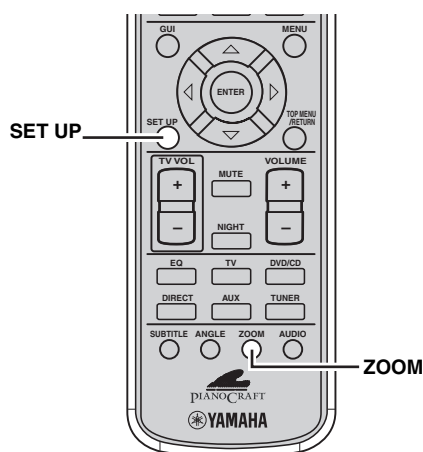

■ To turn on the Progressive Scan mode

While disc playback is stopped, press SET UP to display the OSD menu and then press ZOOM. The Progressive Scan mode is activated and the “PROGRESSIVE” indicator lights up in the DVD receiver display.

■ To turn off the Progressive Scan mode

While disc playback is stopped, press SET UP to display the OSD menu and then press ZOOM.



- When the Progressive Scan mode is off, the DVD receiver provides video with interlace output mode.
- During playback, you cannot switch between the Progressive Scan mode and the interlace output mode.

Notes

- If you play video with a 4:3 aspect ratio on a 16:9 wide television screen, Progressive Scan may fill the screen top to bottom. In this case, change the screen aspect setting of your TV with the OSD menu (page 19). If you cannot adjust the ratio, press SET UP to display the OSD menu and then press ZOOM to turn off the Progressive Scan mode (use the interlace output mode).
- CONSUMERS SHOULD NOTE THAT NOT ALL HIGH DEFINITION TELEVISION SETS ARE FULLY COMPATIBLE WITH THIS PRODUCT AND MAY CAUSE ARTIFACTS TO BE DISPLAYED IN THE PICTURE. IN CASE OF 525 PROGRESSIVE SCAN PICTURE PROBLEMS, IT IS RECOMMENDED THAT YOU SWITCH THE CONNECTION TO THE “STANDARD DEFINITION” OUTPUT. IF THERE ARE QUESTIONS REGARDING YOUR VIDEO MONITOR COMPATIBILITY WITH THIS UNIT, PLEASE CONTACT OUR CUSTOMER SERVICE CENTER.
- This unit is compatible with the complete line of projectors and plasma displays made by YAMAHA.

For U.K. and Europe models only

When the RGB/YUV selector switch (page 9) is set to “RGB”, Progressive Scan is not available.

ENJOYING MULTIMEDIA FILES ON DISCS

This DVD receiver can play MP3, WMA, DivX® and JPEG files on a personally recorded CD-R/RW disc or commercial CD.

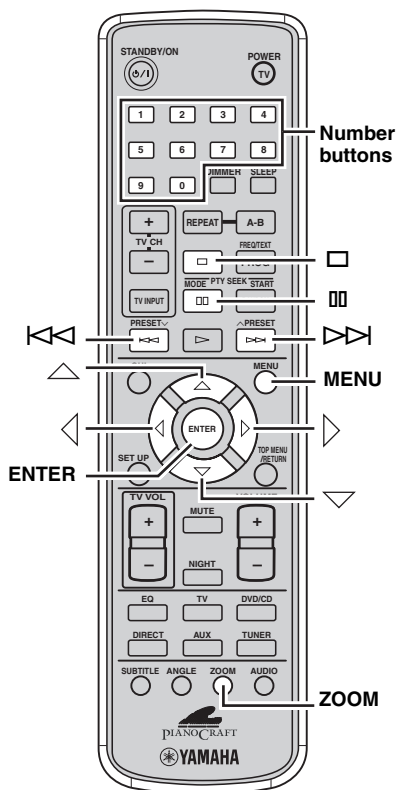

1 Load a disc in the disc tray.

The disc menu appears on the TV screen.

00:00:06															
<table border="1"> <tr> <td>ROOT</td> <td>..</td> <td></td> </tr> <tr> <td>JPEG</td> <td>Pat</td> <td>1</td> </tr> <tr> <td>MP3</td> <td>impressions.MP3</td> <td>2</td> </tr> <tr> <td>WMA</td> <td>one_for_rose.MP3</td> <td>3</td> </tr> <tr> <td></td> <td>sunny.MP3</td> <td>4</td> </tr> </table>	ROOT	..		JPEG	Pat	1	MP3	impressions.MP3	2	WMA	one_for_rose.MP3	3		sunny.MP3	4
ROOT	..														
JPEG	Pat	1													
MP3	impressions.MP3	2													
WMA	one_for_rose.MP3	3													
	sunny.MP3	4													
<table border="0"> <tr> <td>Song: Impressions</td> <td>Artist: Baiyina</td> </tr> <tr> <td>Album: Blueprint</td> <td>Year: 2005</td> </tr> <tr> <td>Genre: Jazz</td> <td>Comment: Fast</td> </tr> </table>	Song: Impressions	Artist: Baiyina	Album: Blueprint	Year: 2005	Genre: Jazz	Comment: Fast									
Song: Impressions	Artist: Baiyina														
Album: Blueprint	Year: 2005														
Genre: Jazz	Comment: Fast														

The disc reading time may exceed 30 seconds due to the complexity of the directory/file configuration.

2 Press \triangle / ∇ to select a desired folder and press ENTER to open the folder.

To move to the upper folder, select the folder icon with two dots.

3 Press \triangle / ∇ to select a file and press ENTER to confirm.

Playback will start from the selected file to the end of the folder.

When you select a JPEG file, a slide show of the current folder automatically begins. Press \square to pause the slide show or press \square to display the list screen. To select the previous/next file, press \lll / \ggg .



- You can select a file by pressing number buttons.
- Depending on the JPEG CD, you can display the thumbnail screen by pressing MENU. Press \lll / \ggg to move to the previous/next pages, and then press \triangle / ∇ / \triangleleft / \triangleright and ENTER to select a picture to be displayed in full screen.
- You can rotate the displayed image by pressing \triangle / \triangleleft / \triangleright when a picture is displayed in full screen.
- You can zoom and pan the displayed image by pressing ZOOM and then \triangle / ∇ / \triangleleft / \triangleright when the slide show is paused.

TUNING RADIO STATIONS

The DVD receiver provides several methods for tuning AM/FM radio stations, such as Auto Tuning, Manual Tuning and Preset Tuning. Follow the procedure below to tune your favorite radio stations.

About the display

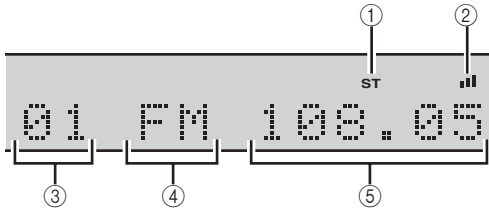



- ① ST indicator**
Lights up when receiving a strong FM radio signal.
- ② ■■■ indicator**
Lights up when receiving a strong radio signal.
- ③ Preset number**
Displays the preset number (page 36).
- ④ Band**
Displays the band (AM or FM).
- ⑤ Frequency**
Displays the frequency.

Tuning radio stations automatically (Auto Tuning)

If the radio wave reception is strong in your area, Auto Tuning is a quick and useful way to tune radio stations.

- 1 Press INPUT on the front panel repeatedly to select AM or FM.**
Each time you press the button, the mode changes between "AM" and "FM".
- 2 Press MODE to select "TUNING MODE" and then rotate MULTI JOG clockwise quickly.**
The DVD receiver automatically detects radio stations that have strong signals for your selection.

 You can switch the tuning mode for FM radio stations. Press  on the remote control to switch the tuning mode between stereo and mono.

■ To switch the frequency step (General model only)

Because the interstation frequency spacing differs in different areas, you may need to switch the frequency step mode.

North, Central and South America: 100 kHz/10 kHz

Follow the procedures below to set the frequency steps. While the DVD receiver is set to the standby mode, press and hold both SOUND and INPUT on the front panel, then press and hold STANDBY/ON on the front panel for 4 seconds or longer. The frequency step mode will be set to 100 kHz/10 kHz.

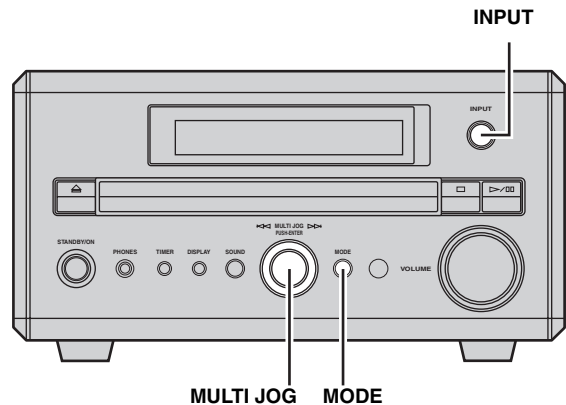

Tuning radio stations manually (Manual Tuning)

If the radio wave reception is weak in your area, tune radio stations manually.

- 1 Press INPUT on the front panel repeatedly to select "AM" or "FM".**
- 2 Press MODE to select "TUNING MODE" and then rotate MULTI JOG to adjust the frequency.**

Selecting preset radio stations (Preset Tuning)

If you preset your favorite radio stations with Auto Preset (page 36) or Manual Preset (page 36) on the DVD receiver, you can tune the radio stations simply by selecting the preset number.

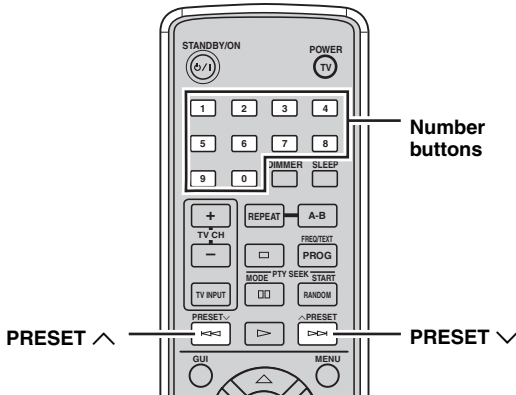

Use the number buttons or press **PRESET ^ / v** repeatedly to select the preset number of the radio station you want to listen to.



You can also select preset radio stations by rotating MULTI JOG on the front panel.

Receiving FM Radio Data System stations (U.K. and Europe models only)

The Radio Data System is a transmission system for FM stations used mainly in the U.K. and Europe. The Radio Data System transmissions include various types of information such as PS (Program Service), PTY (Program Type), RT (Radio Text), and CT (Clock Time). Follow the procedure below to receive FM stations by the Radio Data System transmissions on the DVD receiver.

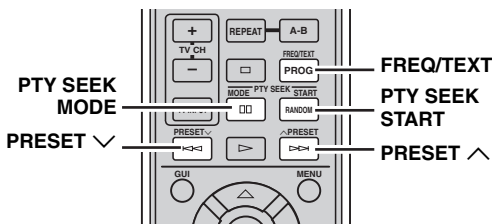

■ To switch frequency and Radio Data System modes

While receiving an FM Radio Data System station, press **DISPLAY**.

Each time you press the button, the mode changes as follows:

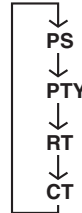

About information type

The Radio Data System includes the following types of information.

- **PS (Program Service)**
Displays the station name.
- **PTY (Program Type)**
Displays the program type (genre).
- **RT (Radio Text)**
Displays text information related to the Radio Data System broadcast. (Shows an under bar for a non-identifiable character.)
- **CT (Clock Time)**
Displays the current time. (Shows the message “CT WAIT” when time data cannot be received properly.)

Notes

- The available Radio Data System information types vary depending on the station.
- If the FM Radio Data System station’s signal transmission is too weak, the DVD receiver may not be able to receive Radio Data System information completely. In particular, RT (Radio Text) information uses a lot of bandwidth, so it may not be available even when other modes are selectable.
- The Radio Data System information may not transmit under weak radio wave conditions. In this case, press **III** on the remote control to let the DVD receiver’s radio wave reception mode automatically change to the monaural mode to increase the signal quality.

■ To select stations by program type (genre)

You can tune FM Radio Data System stations by selecting a program type (genre). Once you select a program type, the DVD receiver automatically searches for FM Radio Data System stations currently broadcasting the corresponding programs.

1 Press **FREQ/TEXT (PROG)** repeatedly to select **PTY**.

Each time you press **FREQ/TEXT**, the display changes as follows:

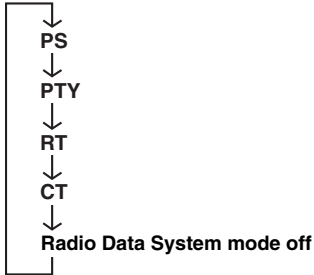

2 Press **PTY SEEK MODE**.

The program type you selected last time appears in the DVD receiver display.

3 Press **PRESET** \wedge / \vee to select the program type you want to listen to.

4 Press **PTY SEEK START**.

The DVD receiver starts searching for preset Radio Data System stations.

■ To cancel **PTY SEEK MODE**

Press **PTY SEEK START**.

PRESETTING RADIO STATIONS

You can preset your favorite radio stations to tune the stations simply by selecting the preset number. The DVD receiver can store up to 20 AM stations and 30 FM stations in its memory.

Presetting radio stations automatically (Auto Preset)

Follow the procedure below to preset radio stations automatically.

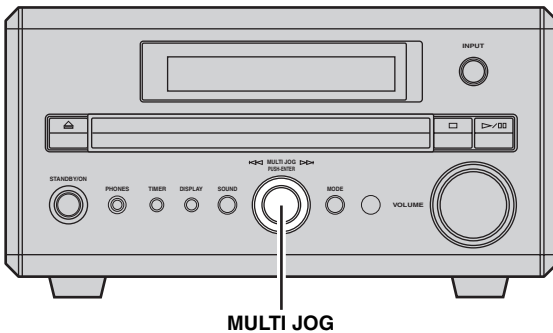

MULTI JOG

Press and hold MULTI JOG for 3 seconds or longer.

Auto preset starts at the lowest frequency toward the highest frequency.

The DVD receiver automatically applies a preset number to each detected stations.

Note

You can preset up to 20 AM stations and 30 FM stations with Auto Preset.



You can delete the currently selected preset station by pressing . You can also delete all the preset stations by pressing and holding for 3 seconds or longer.

Presetting radio stations manually (Manual Preset)

Follow the procedure below to preset radio stations manually.

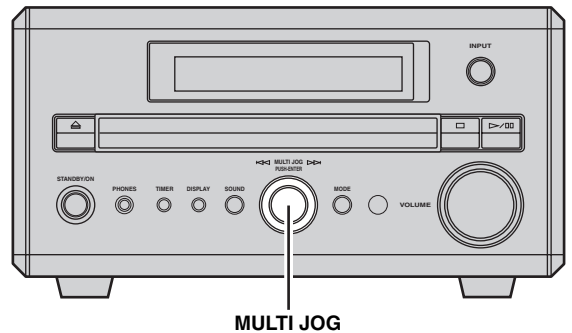

MULTI JOG

1 Tune the radio station you want to preset.

For details, refer to “TUNING RADIO STATIONS” (page 33).

2 Press MULTI JOG.

The MEMORY indicator blinks in the DVD receiver display for about 5 seconds.

3 Within 4 seconds, rotate MULTI JOG to select the preset number (1 to 20 for AM, 1 to 30 for FM) to where you want to store the currently selected station.

4 Press MULTI JOG.



You can delete the currently selected preset station by pressing . You can also delete all the preset stations by pressing and holding for 3 seconds or longer.

Editing the name of preset radio stations

Follow the procedure below to edit the name of preset radio stations.

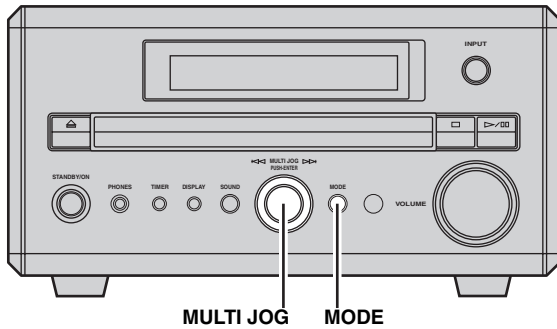

- 1 Select the preset radio station you want to edit the name.**
For details, refer to “Selecting preset radio stations (Preset Tuning)” (page 34).
- 2 Press and hold MODE for more than 4 seconds.**
The cursor flashes in the DVD receiver display.
- 3 Rotate MULTI JOG to select a character, then press MULTI JOG to enter the character.**
The cursor moves to the next.
You can enter alphabets (A to Z) and numbers (0 to 9).
To enter a blank space, select “ ” between “Z” and “0”.
To delete the previously input character, press . To delete all the characters, press for more than 3 seconds.
- 4 Repeat step 3 until you finish entering.**
- 5 Press MODE.**
The name of the preset station is stored.

PLAYING BACK EXTERNAL SOURCES

If you connect an external component to DVD receiver, you can enjoy sources played back on that component with DVD receiver. For details on connection methods, refer to “CONNECTING A TV” (page 9) and “CONNECTING EXTERNAL COMPONENTS” (page 11). Also, you can operate your TV using the remote control by setting a remote control code (page 42).

Note

Make sure you read the owner’s manual for your external component before making any connections or operating it.

TV playback

If you connect the TV L/R jacks on the DVD receiver to the audio output L/R jacks on your TV using an audio pin cable (page 9), you can enjoy TV sounds with the DVD receiver.

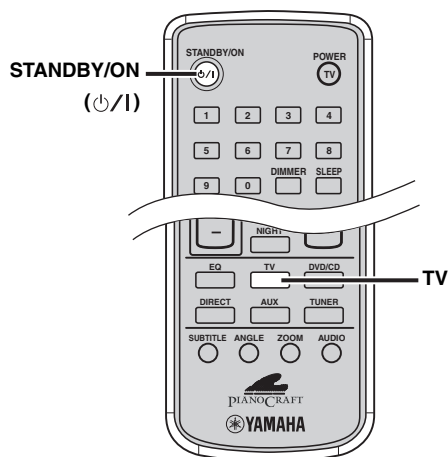

- 1 Turn on the TV, then press **STANDBY/ON** (⏻/⏪) to turn on the DVD receiver.
- 2 Press **TV**.

Other component playback

If you connect the AUX IN L/R jacks on the DVD receiver to the audio output L/R jacks on your component using an audio cable (page 11), you can enjoy the sources played back on the component with the DVD receiver.

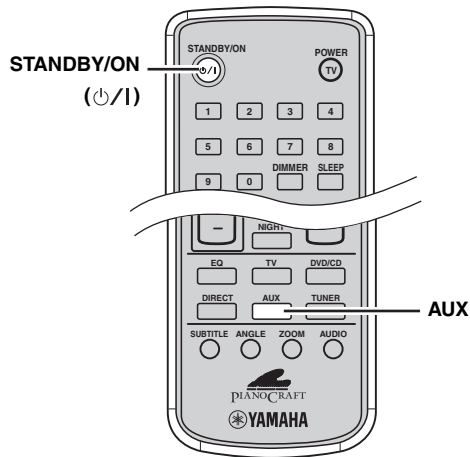

- 1 Turn on the component, then press **STANDBY/ON** (⏻/⏪) to turn on the DVD receiver.
- 2 Press **AUX**.
- 3 Start playback on the connected component.

RECORDING SOURCES WITH EXTERNAL COMPONENTS

If you connect an external recorder to the DVD receiver, you can record sources played back on the DVD receiver. For details on the connection methods, refer to “CONNECTING EXTERNAL COMPONENTS” (page 11).

Note

Make sure you read the manuals for your equipment to operate them.

Recording audio sources with the DVD receiver

If you connect the DIGITAL OPTICAL OUT jack on the DVD receiver to the optical digital input jack on an external recorder such as a CD recorder or MD recorder using optical cables (page 11), you can record audio sources from the DVD receiver.

Notes

- Radio stations are not output from the DIGITAL OPTICAL OUT jack. To record AM/FM broadcasts, use a commercially available audio cable to connect the AUX OUT L/R jack on the DVD receiver to the analog input jack on your recorder.
- Be sure to perform a test recording before an actual recording.
- Turning off the external recorder connected to the DVD receiver may distort playback sounds or reduce the volume. In this case, turn on the external recorder.
- The volume level and audio quality have no effect on the recorded sound during recording. However, if the input source is set to DVD/CD, the output sound for recording may cut off if the headphones are connected/disconnected.
- Depending on the recorder, some DTS software audio signals may not record properly.
- Audio recordings that you make cannot be used for any purpose other than private enjoyment without the consent of the copyright holder.

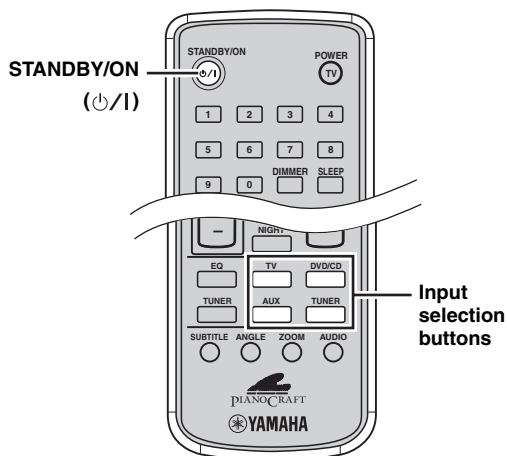

- 1 Turn on the recorder, then press STANDBY/ON (⏻/I) to turn on the DVD receiver.**
- 2 Use the Input selection buttons to select the input source.**
- 3 Start recording on the recorder, then start playback.**

ADJUSTING SOUNDS

You can adjust following sound settings: BASS, TREBLE, L/R BALANCE, EQ MODE, and the DIRECT mode.

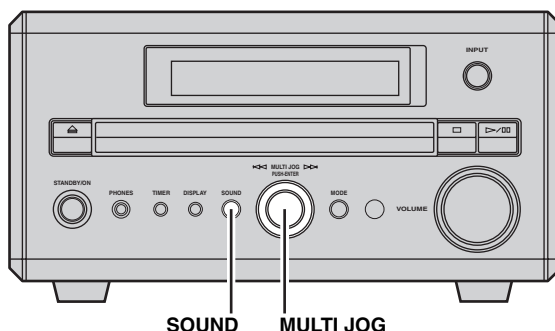

Note

These settings have no effect on the recorded sound during recording.

Adjusting Sound Settings

1 Press SOUND repeatedly to select the setting you want to adjust.

Each time you press SOUND, the display changes as follows:

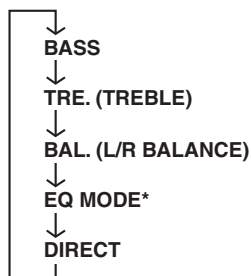

* The currently selected EQ mode is displayed in the DVD receiver display.

2 Rotate MULTI JOG to adjust each setting.

- BASS:** Adjusts the BASS level.
(-10 to +10 dB)
- TREBLE:** Adjusts the TREBLE level.
(-10 to +10 dB)
- L/R BALANCE:** Adjusts the speaker balance.
(L+6 dB to R+6 dB)
- EQ MODE:** Selects the equalizer mode.
(ROCK, POP, JAZZ, CLASSIC, FLAT)
- DIRECT:** Turns on/off the DIRECT mode.
When this is set to ON, a sound comes directly without Digital Signal Processor (DSP) processing.

3 Press MULTI JOG.



- You can select the EQ MODE by pressing EQ on the remote control repeatedly.
- You can turn on/off the DIRECT mode by pressing DIRECT on the remote control.

Night listening mode

Since night listening mode tones down large sound effect and clears speech or vocal sounds, you can enjoy sources even at low volume.

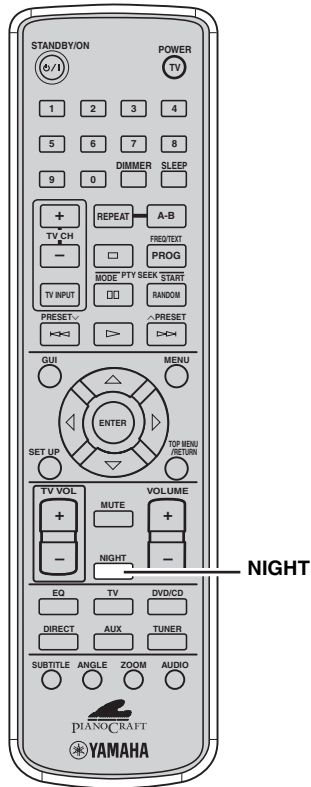

Press NIGHT.

Each time you press NIGHT, the night listening mode changes as follows:



■ To cancel the Night listening mode

Press NIGHT repeatedly to select “NIGHT OFF”.

CONTROLLING EXTERNAL COMPONENTS

In addition to controlling this unit, you can operate external components with the remote control for the DVD receiver by selecting the appropriate remote control code (refer to “LIST OF REMOTE CONTROL CODES” at the end of this manual).

Note

Depending on the product, the remote control may not be able to operate the external component. In this case, use the remote control supplied with the product.

Setting remote control codes

You can set a remote control code for TV on the TV button on the remote control, and a remote control code for Cable TV or Digital Broadcast Satellite tuner on the AUX button on the remote control.

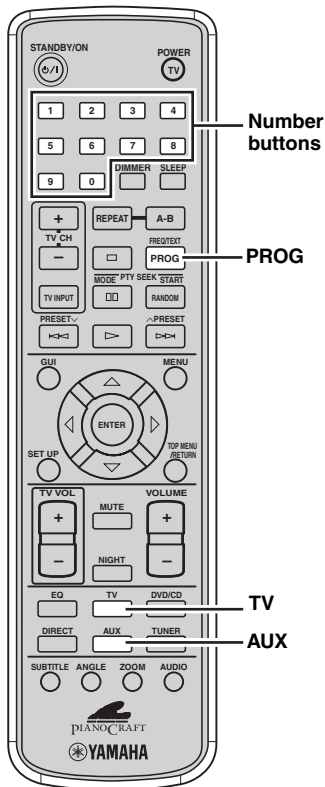

1 Press TV or AUX to set the input source of the DVD receiver to the component you want to operate with the remote control.

2 While holding down PROG, press TV or AUX, then while still holding down PROG, press the number buttons to enter the three-digit remote control code (refer to “LIST OF REMOTE CONTROL CODES” at the end of this manual) for the manufacturer of your component.

3 Refer to “Available operations” (page 43) and try one of the button operations for your component to check that the setting is working properly.

If the button operation does not work properly, the remote control code may be incorrect. In this case, perform step 1 again.

Notes

- Even if you set a remote control code, it will be cleared about two minutes after the remote control batteries run out. In this case, store remote control codes again after replacing the batteries. (Be careful not to press the remote control buttons while replacing the batteries. Doing so may clear the settings.)
- If the manufacturer of your component has more than one code, try each of them until you find the correct one.

Available operations

By carrying out step 1 in “Setting remote control codes” (page 42), you can operate the following functions on the external components using the remote control.

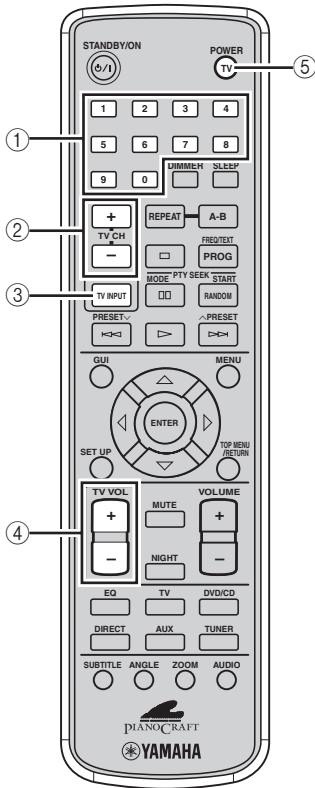

Functions for TV operation (TV)

- ① **Number buttons**
Enters a channel number.
- ② **TV CH +/-**
Switches the TV channels.
- ③ **TV INPUT**
Switches the TV inputs.
- ④ **TV VOL +/-**
Adjusts the TV volume level.
- ⑤ **POWER TV**
Turn the TV on, or set it to the standby mode.

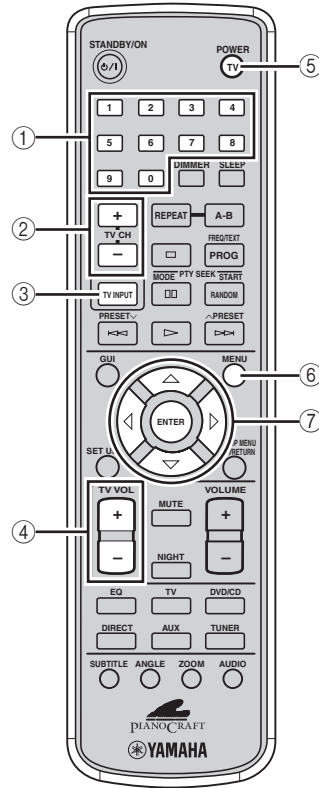

Functions for Cable TV and Digital Broadcast Satellite tuner operation (AUX)

- ① **Number buttons**
Enters a channel number.
- ② **TV CH +/-**
Switches the channels.
- ③ **TV INPUT**
Switches the TV inputs.
- ④ **TV VOL +/-**
Adjusts the TV volume level.
- ⑤ **POWER TV**
Turns the Cable TV or Digital Broadcast Satellite tuner on, or set it to the standby mode.
- ⑥ **MENU**
Displays the OSD menu (Digital Broadcast Satellite tuner only).
- ⑦ **▲ / ▼ / ◀ / ▶, ENTER**
Operates the OSD menu.

TROUBLESHOOTING

If there is any problem with your DVD receiver system, check the following items. If you cannot solve your problem with the following remedies or if your problem is not listed below, turn off and unplug the DVD receiver, then consult the nearest authorized YAMAHA dealer or service center.

General

Problem	Cause	Solution
Power turns on but immediately shuts off.	The power cable may be connected improperly.	Make sure the power cable is plugged into the outlet firmly (page 12).
	The speaker cable may be shorted.	Make sure all speaker cables are connected properly (page 8).
	The DVD receiver may receive a strong electrical shock such as from a lightning bolt or excessive static electricity.	Set the DVD receiver to the Standby mode, then disconnect the power cable. Wait for about 30 seconds, then connect the power cable and turn on the DVD receiver.
The speakers make no sound.	The volume may be set to minimum level.	Adjust the volume level (page 15).
	The Mute function may be enabled.	Cancel the Mute function (page 15).
	The input source may be incorrect.	Select the correct input source (page 14).
	The cables may be connected improperly.	Make sure all cables are connected properly (page 7).
	The disc loaded into the DVD receiver may be not compatible.	Make sure you use a disc supported by the DVD receiver (page 21).
	You are playing a DTS source.	Make a digital connection to a component that features a DTS decoder and select "RAW" for "DIGITAL OUTPUT" with OSD menu (pages 12 and 20).
The TV shows no picture.	The cables may be connected improperly.	Make sure all cables are connected properly (page 9).
Sound suddenly turns off.	The sleep timer (page 17) might be set.	Turn on the DVD receiver and play the source again.
Sound is too low on one side.	The cables may be connected improperly.	Make sure all cables are connected properly (page 7).
The volume does not increase or sounds are distorted.	The power of the equipment connected to the DVD receiver's output jack may be turned off.	Turn on the power of the equipment connected to the DVD receiver's output jack.
A source being played back on the DVD receiver (DVD, CD, AM/FM broadcast, etc.) does not record when using an external component.	You may be trying to make a digital recording of an AM/FM broadcast.	Use the analog recording method (pages 11 and 39).

Problem	Cause	Solution
The DVD receiver does not operate properly.	The DVD receiver may receive a strong electrical shock, such as from a lightning bolt or excessive static electricity, or drop in power supply.	Set the DVD receiver to the Standby mode, then disconnect the power cable. Wait for about 30 seconds, then connect the power cable and turn on the DVD receiver.
A digital equipment or high-frequency equipment produces noises.	The DVD receiver may be placed close to the digital equipment or high-frequency equipment.	Place the DVD receiver further away from such equipment.
Sound played on the DVD receiver cannot be recorded with an external recorder.	You may be trying to make a digital recording with an analog source.	Use proper audio sources.
The clock setting has been cleared.	The power to the DVD receiver may be lost more than a week.	Make sure the power cable is plugged into outlet firmly, then set the clock again (page 16).

Remote control

Problem	Cause	Solution
The remote control does not work for operating the DVD receiver.	The remote control may be operated outside the remote control operation range.	For information on the remote control operation range, refer to "USING THE REMOTE CONTROL" (page 13).
	The remote control sensor on the DVD receiver may be exposed to direct sunlight or lighting (inverted fluorescent lamps).	Change the lighting or DVD receiver's orientation.
	The remote control mode selection may be improper.	Select the mode that suits your purpose (page 5).
	The batteries may be worn out.	Replace the batteries with new ones. (page 13).
The remote control does not work for operating TV.	The remote control code may be incorrect.	Set the correct remote control code (page 42). Depending on the model and year of the product, the remote control may not be able to operate it partly or wholly. In this case, use the remote control supplied for the product.

Disc playback

Problem	Cause	Solution
Some button operations do not work.	Some discs do not support certain DVD receiver functions.	
Playback does not start immediately when pressing ▶.	The disc may not be set in the disc tray properly.	Set the disc in the disc tray properly.
	The disc may be dirty.	Wipe the disc clean.
	The disc loaded into the DVD receiver may be not compatible.	Make sure you use a disc supported by the DVD receiver (page 21).
	When moved the DVD receiver from a cold place to warm one, condensation may be form on the disc reading lens.	Wait for one to two hours, then try again.
An audio or subtitle language does not switch.	The disc may not support the multi-language feature.	Make sure you use a disc that supports the multi-language feature.
No subtitles appear.	The subtitle may be set to "Off".	Select a subtitle language you want to display (page 28).
	The disc may not contain subtitle data.	Make sure you use a disc with subtitle data.
	When using the A-B Repeat function, the subtitle may not appear at the parts other than the selected section.	Cancel the A-B Repeat function (page 26).
A viewing angle does not switch.	The disc may not support the multi-angle feature.	Make sure you use a disc that supports the multi-angle feature.
DVD videos cannot be copied with the VCR.	You may be trying to copy a copy-protected DVD.	Most commercially available DVDs include copy protect features. You cannot make a copy of these DVDs.
Picture looks poor.	In some cases, picture may look poor while fast forwarding or reversing, but this is not a defect.	
The TV (monitor) does not show the picture properly.	The picture settings may be improper.	Adjust the picture settings with the OSD menu (page 19).
	The Progressive Scan mode may be used with a TV that does not support it.	Turn off the Progressive Scan mode (page 31).
The screen size of the TV (monitor) looks strange.	The picture settings may be improper.	Adjust the picture settings with the OSD menu (page 19).
	When the Progressive Scan mode is activated, image with a 4:3 aspect ratio are played on a 16:9 wide television screen.	Change "TV TYPE" with the OSD menu (page 19). If you cannot adjust the ratio, turn off the Progressive Scan mode and use the interlace output mode (page 31).
The TV shows overlapped picture partly.	The disc content does not match the Progressive Scan mode due to the editing method or other conditions.	Turn off the Progressive Scan mode (page 31).
The disc is ejected without an operation.	The disc loaded into the DVD receiver may be not compatible.	Make sure you use a disc supported by the DVD receiver (page 21).
The message "No Disc" appears in the DVD receiver display even though a disc is inserted.	The disc may not be set in the disc tray.	Set the disc in the disc tray properly.

Radio reception

■ FM/AM

Problem	Cause	Solution
The Preset Tuning function (page 34) does not work.	The preset (memory) may have been erased.	Preset radio stations again (page 36).
The preset station settings have been cleared.	The power to the DVD receiver may be lost more than a week.	Make sure the power cable is plugged into outlet firmly, then preset the stations again (page 36).

■ FM

Problem	Cause	Solution
Too much noise is generated during stereo broadcast.	The FM antenna may be connected improperly.	Make sure the FM antenna is connected properly (page 10).
	The radio station you selected may be far away from your area or radio wave reception is weak in your area.	Try Manual Tuning to increase the signal quality (page 33) or use a multi-channel outdoor antenna.
Even with an outdoor antenna, radio wave reception is weak (audio is distorted).	Multipath reflection or other radio interferences may occur.	Change the antenna's height, direction, or placement.
The Auto Tuning function (page 33) does not work.	The radio station you selected may be far away from your area or radio wave reception is weak in your area.	Try Manual Tuning to increase the signal quality (page 33) or use a multi-channel outdoor antenna.

■ AM







Problem	Cause	Solution
Too much noise is generated.	The noises may be generated from atmospheric electricity, lightening, fluorescent lights, motors, or thermostat electric devices.	Connect an outdoor antenna and establish better grounding to decrease noises. However, it is difficult to eliminate these types of noises.
	If too much noise is generated especially in the evening, the DVD receiver may be placed close to a TV.	Place the DVD receiver further away from a TV.
The Auto Tuning function (page 33) does not work.	The AM loop antenna may be connected improperly.	Make sure the AM loop antenna is connected properly (page 10).
	The radio station you selected may be far away from your area or radio wave reception is weak in your area.	Try Manual Tuning to increase the signal quality (page 33).

ADDITIONAL INFORMATION

Disc Information

The following tables explain the disc types supported by the DVD receiver.

Video Discs













Type of Disc	Disc Logo Mark
DVD Video	
SVCD (Super Video CD)	
Video CD	 
	  Video CDs made by copying an MPEG movie file onto a CD-R or CD-RW

This DVD receiver can play:



- MP3, WMA and picture (Kodak, JPEG) files recorded on CD-R(W).
- JPEG/ISO 9660 format
- DivX® recorded on CD-R[W]/DVD+R[W]/DVD-R[W](3.11, 4.x and 5.x)

DVD region codes

The region code (an ID number assigned to each market region) is set for normal DVD players and DVD video discs. The DVD receiver supports the discs with the region codes shown in the right table. For details, read the information on the disc jacket.

Destination	Region code of DVD receiver	Playable discs
U.S.A. Canada		 
U.K. Europe		 
Australia		 
Korea General Asia		 

Music Discs

Type of Disc	Disc Logo Mark
Music CD (Compact disc digital audio)	
	  Music CDs made by copying onto a CD-R or CD-RW (including MP3 or WMA format files)



Disc logo marks are printed on the disc and the disc jacket.

Notes

- The following discs cannot be played on the DVD receiver. CD-ROM, DVD-ROM, DVD-RAM, CDV. (This product can play some types of DVD-R (Video format only), DVD-RW (Video format only), DVD+R or DVD+RW discs.)
- The DVD receiver cannot play a CD-R, CD-RW, DVD-R, DVD-RW, DVD+R or DVD+RW disc that has not been finalized. Finalizing is a process that prepares a disc for playback on a compatible device.
- Only use discs from a reputable manufacturer. Some discs cannot be played back, depending on recording conditions and disc characteristics.
- Do not use discs with non-standard shapes or sizes.



- Some DVD video or video CD discs may operate and function differently than noted in this manual. That is by manufacturer design and not a defect in this unit. For details read the information on the disc jacket.
- This unit can play the disc types associated with the logos shown on page 48. (Do not attempt to load any other type of disc into the unit, or the unit may be damaged.)
- Some discs cannot be played depending on the recording conditions such as PC environment and application software. Failure can also result from disc characteristics and condition, like material quality, scratches or curvature.

Handling a disc

- Do not touch the surface of the disc. Hold a disc by its edge and center hole.
- Do not leave a disc in the tray when you are not playing it.
- Do not write on the disc with a pencil or other marker.
- Do not stick tape, seals or other attachments to a disc, and do not bring into contact with glue.
- Do not use a protective cover to prevent scratches.
- Do not use a disc whose surface can be printed with a commercially available label printer.
- Do not put a disc in a place with direct sunlight, high temperature, high humidity or a lot of dust.

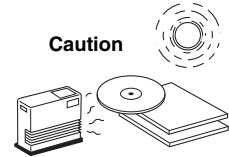
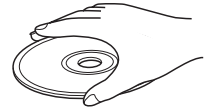

- If a disc becomes dirty, wipe it with a clean, dry cloth from the center out to the edge. Do not use record cleaner or paint thinner.
- To avoid malfunction, do not use a commercially available lens cleaner.

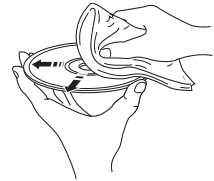

GLOSSARY

Audio formats

■ **Dolby Digital**

Dolby Digital is a digital surround sound system that gives you completely independent multi-channel audio. With 3 front channels (left, center, and right), and 2 surround stereo channels, Dolby Digital provides 5 full-range audio channels. With an additional channel especially for bass effects, called LFE (low frequency effect), the system has a total of 5.1-channels (LFE is counted as 0.1 channel). The DVD receiver downmixes the multi-channel audio to 2 channel so that you can enjoy Dolby Digital sources easily.

■ **Linear PCM (LPCM)**

A signal that is changed to digital format without compression. A CD is recorded with 16-bit sound at 44.1 kHz, while DVD recording is anywhere from 16 bits at 48 kHz to 24 bits at 192 kHz, which makes it a higher quality sound than CD. This signal also has a type called Packed PCM (P.PCM) that can be compressed without any loss of data.

Audio information

■ **Dynamic range**

The difference between the smallest sound that can be heard above the equipment noise and the biggest sound that can be heard without distortion is the dynamic range.

■ **Sampling frequency and quantized bit rate**

When converting an analog signal to digital, the number of times the signal is sampled per second is called the sampling frequency, while the degree of fineness when converting the sound level into a numeric value is called the quantized bit rate.

The frequency band that can be played back is determined by the sampling rate, while the dynamic range expressing the difference in sound level is determined by the quantized bit rate. In principle, the higher the sampling rate, the wider the frequency range that can be played back, and the higher the quantized bit rate, the finer the sound that can be reproduced.

■ **Track (CD/Video CD)**

A CD or Video CD can be divided into a number of segments (tracks). Each division is called a title number.

Video signal information

■ Component video signal

With the component video signal system, the video signal is separated into the Y signal for the luminance and the P_b and P_r signals for the chrominance. Color can be reproduced more faithfully with this system because each of these signals is independent. The component signal is also called the “color difference signal” because the luminance signal is subtracted from the color signal.

■ Decoder

A device that converts encoded data on DVD and other media back to its original audio or video signal.

■ Film and video data

In general, DVD media can be classified into the 2 types below.

- **Film Data**
Video recorded at 24 frames/second. (The film used for shooting movies is recorded at 24 frames/second.) Recently 30 frames/second progressive video has made its debut.
- **Video Data**
Video recorded at 30 frames/second.

DVD receiver will automatically recognize whether the source recorded on DVD is film or video, then select the best method to convert it into progressive output.

■ Interlace and progressive outputs

Up to now the standard video signal has been NTSC with 525i (i: interlaced) scan lines. In contrast, 525p (p: progressive) is a high-density signal with double the number of scan lines.

■ NTSC

NTSC is a video signal system (525 lines, 30 frames per second) used in North America, Central America, a number of South American countries, and some Asian countries, including Japan.

■ PAL

PAL is a video signal system (625 lines, 25 frames per second) used in the United Kingdom, much of the rest of western Europe, several South American countries, some Middle East and Asian countries, several African countries, Australia, New Zealand, and other Pacific island countries.

■ Title, Chapter (DVD Video)

DVD video lets you divide a disc in a big way by titles or a small way by chapters. Each division is either called a title number or a chapter number.

Copyright and logo marks

This product incorporates copyright protection technology that is protected by method claims of certain U.S. patents and other intellectual property rights owned by Macrovision Corporation and other rights owners. Use of this copyright protection technology must be authorized by Macrovision Corporation, and is intended for home and other limited viewing uses only unless otherwise authorized by Macrovision Corporation. Reverse engineering or disassembly is prohibited.



Manufactured under license from Dolby Laboratories. “Dolby” and the double-D symbol are trademarks of Dolby Laboratories.



“DTS” and “DTS DIGITAL OUT” are trademarks of Digital Theater Systems, Inc.

MPEG Layer-3 audio decoding technology licensed from Fraunhofer IIS and Thomson multimedia.



“DivX”, “DivX Certified”, and associated logos are trademarks of DivX Networks, Inc and are used under license.

SPECIFICATIONS

AMPLIFIER SECTION

- Minimum RMS output power per channel (20 kHz Factory LPF)
(6 Ω , 1 kHz, 0.18% THD)..... 20 W + 20 W
- Maximum RMS output power per channel (20 kHz Factory LPF)
(6 Ω , 1 kHz, 10% THD)..... 30 W + 30 W
- Total Harmonic Distortion
AUX etc (1 Channel Driven, 1 kHz)..... less than 0.08%
- Input sensitivity/Impedance
AUX etc..... 300 mV/47 k Ω
- Frequency Response
AUX etc..... 10 Hz to 22 kHz \pm 3dB
- Signal to Noise ratio
(20 kHz Factory LPF, IHF-A network, Shorted)
AUX etc (0 dB Input).....93 dB

VIDEO SECTION

- Video Signal Level
Video 1 Vp-p/75 Ω
Component 1 Vp-p/75 Ω (Y)
0.7 Vp-p/75 Ω (PB, PR)
Signal to Noise ratio..... 72 dB

TUNER SECTION

FM Section

- Tuning Range 87.50 to 108.00 MHz
- Signal to Noise ratio (Mono)..... 75 dB
- Sensitivity (S/N 30 dB) 1.0 μ V

AM Section

- Tuning Range
U.S.A. and Canada models 530 to 1700 kHz
Other models 522 to 1629 kHz
- Signal to Noise ratio..... 32 dB
- Sensitivity (S/N 20 dB) 700 μ V

CD/DVD PLAYER SECTION

- Signal to Noise ratio.....95 dB
- Total Harmonic Distortion0.007%
- Separation.....90 dB

AUDIO FORMAT

- Dolby Digital/MPEG decode (not decode DTS)
- PCM DATA: 16 bit
- LPCM DATA: 20/24 bit
Fs: 44.1, 48 kHz support/88.2, 96 kHz downmix support
- MP3: 32 kbps to 320 kbps, 16 kHz to 48 kHz sampling rate
- WMA: Up to 192 kbps (not support 32 kbps),
32 kHz, 44.1 kHz, 48 kHz sampling rate
- Support mono and stereo WMA/MP3 and VBR files

GENERAL

- Power Supply
U.S.A. and Canada models AC 120 V, 60 Hz
Australia model AC 240 V, 50 Hz
U.K. and Europe models AC 230 V, 50 Hz
Korea model..... AC 220 V, 60 Hz
Asia model AC 220–240 V, 50/60 Hz
General model AC 110–120 V, 50/60 Hz
- Power consumption 30 W
- Standby Power consumption
U.S.A. and Canada models 0.9 W
Australia model 1.1 W
U.K. and Europe models 1.0 W
Korea model..... 1.0 W
Asia model 1.1 W
General model 0.9 W
- Laser Pickup
Type Semiconductor laser GaAlAs
Wave length 650 nm (DVD), 790 nm (VCD/CD)
Output Power 1.45 mW (DVD), 1.13 mW (VCD/CD)
- Dimensions (W x H x D).....215 x 112.8 x 295.9 mm
(8.46 x 4.44 x 11.65 inch)
- Weight.....2.65 kg
(5.84 lbs)
- Operating Temperature Range +5 to +35°C (41 to 95°F)
- Operating Humidity Range 5 to 90% (No Condensation)

Specifications are subject to change without notice.

**LIST OF REMOTE CONTROL CODES
 LISTE DES CODES DE COMMANDE
 LISTE DER FERNBEDIENUNGSCODES
 LISTA ÖVER FJÄRRSTYRNINGSKODER
 LISTA DEI CODICI DI TELECOMANDO
 LISTA DE CÓDIGOS DE MANDO A DISTANCIA
 LIJST MET AFSTANDSBEDIENINGSCODES
 СПИСОК КОДОВ ДИСТАНЦИОННОГО УПРАВЛЕНИЯ**

		Panasonic	234/235/236/253/ 288/211				
TV		Philco	297/225/239/298	Cable TV		Digital Broadcast Satellite tuner	
YAMAHA	299/292/242/285/ 287/253	Philips	225/205/298	ABC	739/752/753/755/ 758/759/762	Echostar	822
Admiral	292/293/216	Pioneer	226/235/254/255/ 268	General Instrument	722	GE	837/838/839
Aiwa	294/276/283/284	Portland	297/256	Hamlin	723/724/725/726/ 727	General Instrument	823
Akai	295/296	Proscan	293/221/231/241/ 251	Hitachi	722	Hitachi	824
Alba	296	Proton	297/250/260/270	Jerrold	722/728/729/732/ 733/734/735/736/ 737	Hughes	843/844/845/846
AOC	297	Quasar	234/235	Magnavox	738	JVC (Victor)	822
Audiovox	285	Radio Shack	299/293/297	Motorola	748	Magnavox	825
Belcor	297	RCA	293/297/234/256/ 257/258/221	Oak	739/742/743	Panasonic	826/829
Bell & Howell	292	SABA	223/269/265/266	Panasonic	744/745/746/747/ 783/784	Philips	825/843/844/845/ 846/847/848/849
Bestar	298	Sampo	281/297/280	Philips	763/764/765/766/ 767/768	Primestar	827
Blaupunkt	229/222	Samsung	297/239/248/262/ 275	Pioneer	748/785/747	Proscan	837/838/839/842
Blue sky	298	Sanyo	295/233/279/272/ 273/274/212	Radio Shack	749	Radio Shack	828
Brandt	223	Schneider	296	Scientific Atlanta	752/753/754	RCA	837/838/839/842
Brocosonic	297	Scott	297	Sony	756/757	Samsung	852
Bush	296	Sharp	292/239/232/213	Tocom	755	Sony	832/835
By Design	201/202	Siemens	229	Universal	769/772/773/774/ 775	Toshiba	833/836
Clatronic	298	Signature	216/292	Viewstar	764/766/776/777/ 778/779/782	Uniden	825
Craig	224	Sony	263/214			Zenith	834
Croslex	225/298	Sylvania	297/225/298				
Curtis Mathis	297/226	Symphonic	217/218/219				
Daewoo	297/298/224/227/ 228	Telefunken	269/264/265/266				
Dayton	239	Thomson	223/266				
Dwin	293/281	Toshiba	292/226/267/215				
Emerson	297/224/239/232	Videch	297/242				
Ferguson	223/265/266	Wards	297/239/232/216				
First line	298						
Fisher	295/233						
Fraba	298						
Fujitsu	289						
Funai	277/278						
GE	293/297/234/235/ 236						
Goodmans	296/298/223						
Grundig	229/238/249						
Hitachi	297/239/242/243/ 285						
ICE	296						
Irradio	296						
Itt/Nokia	244/245						
JC Penny	293/297/234/237						
JVC (Victor)	296/246/247						
Kendo	298						
KTV	297/239/285						
LG/Goldstar	297/298/239/237						
Loewe	298/248						
LXI	293/297/225/226/ 233/298						
Magnavox	297/225/239/298						
Marantz	286/210						
Matsui	295						
Medion	203/204/298						
Memorex	297/216						
Mitsubishi	299/297/259/287						
Nad	226/255						
NEC	297/252/282						
Nokia	244/245						
Nokia Oceanic	245						
Nordmende	265/266						
Onwa	296						

<p>CAUTION Use of controls or adjustments or performance of procedures other than those specified herein may result in hazardous radiation exposure.</p>
<p>AVERTISSEMENT L'utilisation de commandes et l'emploi de réglages ou de méthodes autres que ceux décrits ci-dessous, peuvent entraîner une exposition à un rayonnement dangereux.</p>
<p>VORSICHT Die Verwendung von Bedienelementen oder die Einstellung bzw. die Ausführung von anderen als in dieser Anleitung beschriebenen Vorgängen kann zu Gefährdung durch gefährliche Strahlung führen.</p>
<p>OBSERVERA Användning av reglage eller justeringar eller utförande av åtgärder på annat sätt än så som beskrivs häri kan resultera i farlig strålning.</p>
<p>ATTENZIONE L'uso di controlli, regolazioni, operazioni o procedure non specificati in questo manuale possono risultare in esposizione a radiazioni pericolose.</p>
<p>PRECAUCIÓN El uso de los controles, los ajustes o los procedimientos que no se especifican en este manual pueden causar una exposición peligrosa a la radiación.</p>
<p>LET OP Gebruik van bedieningsorganen, instellingen of procedures anders dan beschreven in dit document kan leiden tot blootstelling aan gevaarlijke stralen.</p>
<p>ПРЕДОСТЕРЕЖЕНИЕ Использование органов управления или произведение настроек или выполнение процедур, не указанных в данной инструкции, может отразиться на выделении опасной радиации.</p>

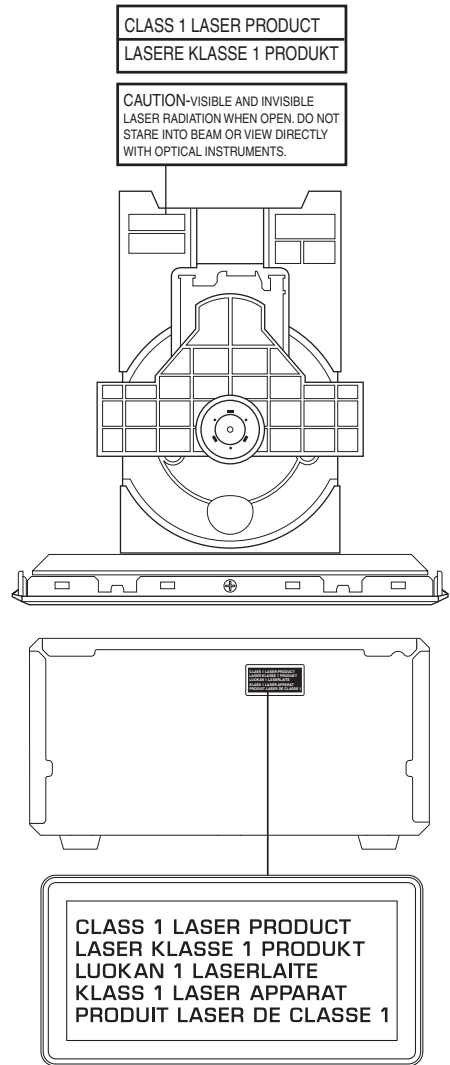



© 2005 YAMAHA CORPORATION All rights reserved.

YAMAHA ELECTRONICS CORPORATION, USA 6660 ORANGETHORPE AVE., BUENA PARK, CALIF. 90620, U.S.A.
YAMAHA CANADA MUSIC LTD. 135 MILNER AVE., SCARBOROUGH, ONTARIO M1S 3R1, CANADA
YAMAHA ELECTRONIK EUROPA G.m.b.H. SIEMENSSTR. 22-34, 25462 RELLINGEN BEI HAMBURG, GERMANY
YAMAHA ELECTRONIQUE FRANCE S.A. RUE AMBROISE CROIZAT BP70 CROISSY-BEAUBOURG 77312 MARNE-LA-VALLEE CEDEX02, FRANCE
YAMAHA ELECTRONICS (UK) LTD. YAMAHA HOUSE, 200 RICKMANSWORTH ROAD WATFORD, HERTS WD18 7GQ, ENGLAND
YAMAHA SCANDINAVIA A.B. J A WETTERGRENS GATA 1, BOX 30053, 400 43 VÄSTRA FRÖLUNDA, SWEDEN
YAMAHA MUSIC AUSTRALIA PTY, LTD. 17-33 MARKET ST., SOUTH MELBOURNE, 3205 VIC., AUSTRALIA

YAMAHA CORPORATION
Printed in China ◀ CQX1A1058Z

Free Manuals Download Website

<http://myh66.com>

<http://usermanuals.us>

<http://www.somanuals.com>

<http://www.4manuals.cc>

<http://www.manual-lib.com>

<http://www.404manual.com>

<http://www.luxmanual.com>

<http://aubethermostatmanual.com>

Golf course search by state

<http://golfingnear.com>

Email search by domain

<http://emailbydomain.com>

Auto manuals search

<http://auto.somanuals.com>

TV manuals search

<http://tv.somanuals.com>