



RX-V463

AV Receiver

OWNER'S MANUAL

IMPORTANT SAFETY INSTRUCTIONS

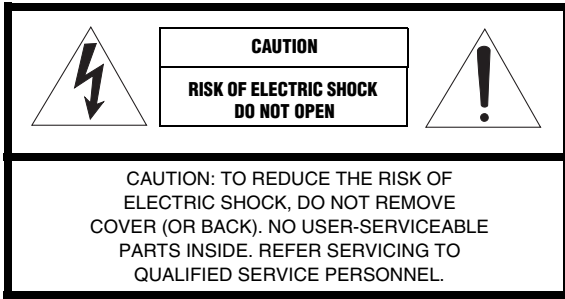

• Explanation of Graphical Symbols



The lightning flash with arrowhead symbol, within an equilateral triangle, is intended to alert you to the presence of uninsulated “dangerous voltage” within the product’s enclosure that may be of sufficient magnitude to constitute a risk of electric shock to persons.



The exclamation point within an equilateral triangle is intended to alert you to the presence of important operating and maintenance (servicing) instructions in the literature accompanying the appliance.

- 1 Read Instructions – All the safety and operating instructions should be read before the product is operated.
- 2 Retain Instructions – The safety and operating instructions should be retained for future reference.
- 3 Heed Warnings – All warnings on the product and in the operating instructions should be adhered to.
- 4 Follow Instructions – All operating and use instructions should be followed.
- 5 Cleaning – Unplug this product from the wall outlet before cleaning. Do not use liquid cleaners or aerosol cleaners.
- 6 Attachments – Do not use attachments not recommended by the product manufacturer as they may cause hazards.
- 7 Water and Moisture – Do not use this product near water – for example, near a bath tub, wash bowl, kitchen sink, or laundry tub; in a wet basement; or near a swimming pool; and the like.
- 8 Accessories – Do not place this product on an unstable cart, stand, tripod, bracket, or table. The product may fall, causing serious injury to a child or adult, and serious damage to the product. Use only with a cart, stand, tripod, bracket, or table recommended by the manufacturer, or sold with the product. Any mounting of the product should follow the manufacturer’s instructions, and should use a mounting accessory recommended by the manufacturer.
- 9 A product and cart combination should be moved with care. Quick stops, excessive force, and uneven surfaces may cause the product and cart combination to overturn.



- 10 Ventilation – Slots and openings in the cabinet are provided for ventilation and to ensure reliable operation of the product and to protect it from overheating, and these openings must not be blocked or covered. The openings should never be blocked by placing the product on a bed, sofa, rug, or other similar surface. This product should not be placed in a built-in installation such as a bookcase or rack unless proper ventilation is provided or the manufacturer’s instructions have been adhered to.
- 11 Power Sources – This product should be operated only from the type of power source indicated on the marking label. If you are not sure of the type of power supply to your home, consult your product dealer or local power company. For products intended to operate from battery power, or other sources, refer to the operating instructions.
- 12 Grounding or Polarization – This product may be equipped with a polarized alternating current line plug (a plug having one blade wider than the other). This plug will fit into the power outlet only one way. This is a safety feature. If you are unable to insert the plug fully into the outlet, try reversing the plug. If the plug should still fail to fit, contact your electrician to replace your obsolete outlet. Do not defeat the safety purpose of the polarized plug.
- 13 Power-Cord Protection – Power-supply cords should be routed so that they are not likely to be walked on or pinched by items placed upon or against them, paying particular attention to cords at plugs, convenience receptacles, and the point where they exit from the product.
- 14 Lightning – For added protection for this product during a lightning storm, or when it is left unattended and unused for long periods of time, unplug it from the wall outlet and disconnect the antenna or cable system. This will prevent damage to the product due to lightning and power-line surges.
- 15 Power Lines – An outside antenna system should not be located in the vicinity of overhead power lines or other electric light or power circuits, or where it can fall into such power lines or circuits. When installing an outside antenna system, extreme care should be taken to keep from touching such power lines or circuits as contact with them might be fatal.
- 16 Overloading – Do not overload wall outlets, extension cords, or integral convenience receptacles as this can result in a risk of fire or electric shock.
- 17 Object and Liquid Entry – Never push objects of any kind into this product through openings as they may touch dangerous voltage points or short-out parts that could result in a fire or electric shock. Never spill liquid of any kind on the product.
- 18 Servicing – Do not attempt to service this product yourself as opening or removing covers may expose you to dangerous voltage or other hazards. Refer all servicing to qualified service personnel.
- 19 Damage Requiring Service – Unplug this product from the wall outlet and refer servicing to qualified service personnel under the following conditions:
 - a) When the power-supply cord or plug is damaged,
 - b) If liquid has been spilled, or objects have fallen into the product,
 - c) If the product has been exposed to rain or water,

- d) If the product does not operate normally by following the operating instructions. Adjust only those controls that are covered by the operating instructions as an improper adjustment of other controls may result in damage and will often require extensive work by a qualified technician to restore the product to its normal operation,
 - e) If the product has been dropped or damaged in any way, and
 - f) When the product exhibits a distinct change in performance - this indicates a need for service.
- 20 Replacement Parts** – When replacement parts are required, be sure the service technician has used replacement parts specified by the manufacturer or have the same characteristics as the original part. Unauthorized substitutions may result in fire, electric shock, or other hazards.
- 21 Safety Check** – Upon completion of any service or repairs to this product, ask the service technician to perform safety checks to determine that the product is in proper operating condition.
- 22 Wall or Ceiling Mounting** – The unit should be mounted to a wall or ceiling only as recommended by the manufacturer.
- 23 Heat** – The product should be situated away from heat sources such as radiators, heat registers, stoves, or other products (including amplifiers) that produce heat.

24 Outdoor Antenna Grounding – If an outside antenna or cable system is connected to the product, be sure the antenna or cable system is grounded so as to provide some protection against voltage surges and built-up static charges. Article 810 of the National Electrical Code, ANSI/NFPA 70, provides information with regard to proper grounding of the mast and supporting structure, grounding of the lead-in wire to an antenna discharge unit, size of grounding conductors, location of antenna discharge unit, connection to grounding electrodes, and requirements for the grounding electrode.

EXAMPLE OF ANTENNA GROUNDING

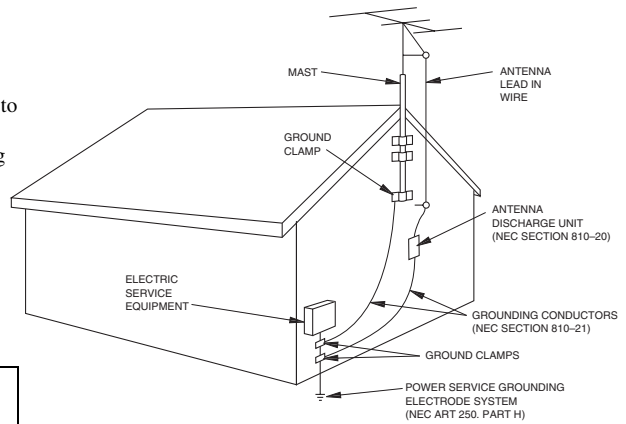

NEC – NATIONAL ELECTRICAL CODE

Note to CATV system installer:

This reminder is provided to call the CATV system installer’s attention to Article 820-40 of the NEC that provides guidelines for proper grounding and, in particular, specifies that the cable ground shall be connected to the grounding system of the building, as close to the point of cable entry as practical.

FCC INFORMATION (for US customers)

1 IMPORTANT NOTICE: DO NOT MODIFY THIS UNIT!

This product, when installed as indicated in the instructions contained in this manual, meets FCC requirements. Modifications not expressly approved by Yamaha may void your authority, granted by the FCC, to use the product.

2 IMPORTANT: When connecting this product to accessories and/or another product use only high quality shielded cables. Cable/s supplied with this product **MUST** be used. Follow all installation instructions. Failure to follow instructions could void your FCC authorization to use this product in the USA.

3 NOTE: This product has been tested and found to comply with the requirements listed in FCC Regulations, Part 15 for Class “B” digital devices. Compliance with these requirements provides a reasonable level of assurance that your use of this product in a residential environment will not result in harmful interference with other electronic devices.

This equipment generates/uses radio frequencies and, if not installed and used according to the instructions found in the users manual, may cause interference harmful to the operation of other electronic devices.

Compliance with FCC regulations does not guarantee that interference will not occur in all installations. If this product is found to be the source of interference, which can be determined by turning the unit “OFF” and “ON”, please try to eliminate the problem by using one of the following measures:

Relocate either this product or the device that is being affected by the interference.

Utilize power outlets that are on different branch (circuit breaker or fuse) circuits or install AC line filter/s.

In the case of radio or TV interference, relocate/reorient the antenna. If the antenna lead-in is 300 ohm ribbon lead, change the lead-in to coaxial type cable.

If these corrective measures do not produce satisfactory results, please contact the local retailer authorized to distribute this type of product. If you can not locate the appropriate retailer, please contact Yamaha Electronics Corp., U.S.A. 6660 Orangethorpe Ave., Buena Park, CA 90620.

The above statements apply **ONLY** to those products distributed by Yamaha Corporation of America or its subsidiaries.

Caution: Read this before operating your unit.

- 1 To assure the finest performance, please read this manual carefully. Keep it in a safe place for future reference.
- 2 Install this sound system in a well ventilated, cool, dry, clean place – away from direct sunlight, heat sources, vibration, dust, moisture, and/or cold. Allow ventilation space of at least 30 cm on the top, 20 cm on the left and right, and 20 cm on the back of this unit.
- 3 Locate this unit away from other electrical appliances, motors, or transformers to avoid humming sounds.
- 4 Do not expose this unit to sudden temperature changes from cold to hot, and do not locate this unit in an environment with high humidity (i.e. a room with a humidifier) to prevent condensation inside this unit, which may cause an electrical shock, fire, damage to this unit, and/or personal injury.
- 5 Avoid installing this unit where foreign object may fall onto this unit and/or this unit may be exposed to liquid dripping or splashing. On the top of this unit, do not place:
 - other components, as they may cause damage and/or discoloration on the surface of this unit.
 - burning objects (i.e. candles), as they may cause fire, damage to this unit, and/or personal injury.
 - containers with liquid in them, as they may fall and liquid may cause electrical shock to the user and/or damage to this unit.
- 6 Do not cover this unit with a newspaper, tablecloth, curtain, etc. in order not to obstruct heat radiation. If the temperature inside this unit rises, it may cause fire, damage to this unit, and/or personal injury.
- 7 Do not plug in this unit to a wall outlet until all connections are complete.
- 8 Do not operate this unit upside-down. It may overheat, possibly causing damage.
- 9 Do not use force on switches, knobs and/or cords.
- 10 When disconnecting the power cable from the wall outlet, grasp the plug; do not pull the cord.
- 11 Do not clean this unit with chemical solvents; this might damage the finish. Use a clean, dry cloth.
- 12 Only voltage specified on this unit must be used. Using this unit with a higher voltage than specified is dangerous and may cause fire, damage to this unit, and/or personal injury. Yamaha will not be held responsible for any damage resulting from use of this unit with a voltage other than specified.
- 13 To prevent damage by lightning, keep the power cord and outdoor antennas disconnected from a wall outlet or the unit during a lightning storm.
- 14 Do not attempt to modify or fix this unit. Contact qualified Yamaha service personnel when any service is needed. The cabinet should never be opened for any reasons.
- 15 When not planning to use this unit for long periods of time (i.e. vacation), disconnect the AC power plug from the wall outlet.
- 16 Install this unit near the AC outlet and where the AC power plug can be reached easily.
- 17 Be sure to read the “Troubleshooting” section on common operating errors before concluding that this unit is faulty.
- 18 Before moving this unit, press **ⒶSTANDBY/ON** to set this unit in the standby mode, and disconnect the AC power plug from the wall outlet.
- 19 **VOLTAGE SELECTOR** (Asia and General models only)
The VOLTAGE SELECTOR on the rear panel of this unit must be set for your local main voltage BEFORE plugging into the AC wall outlet.
Voltages are 110–120/220–240 V AC, 50/60 Hz.
- 20 The batteries shall not be exposed to excessive heat such as sunshine, fire or like.
- 21 Excessive sound pressure from earphones and headphones can cause hearing loss.

WARNING

TO REDUCE THE RISK OF FIRE OR ELECTRIC SHOCK, DO NOT EXPOSE THIS UNIT TO RAIN OR MOISTURE.

This unit is not disconnected from the AC power source as long as it is connected to the wall outlet, even if this unit itself is turned off by **ⒶSTANDBY/ON**. This state is called the standby mode. In this state, this unit is designed to consume a very small quantity of power.

FOR CANADIAN CUSTOMERS

To prevent electric shock, match wide blade of plug to wide slot and fully insert.
This Class B digital apparatus complies with Canadian ICES-003.

POUR LES CONSOMMATEURS CANADIENS

Pour éviter les chocs électriques, introduire la lame la plus large de la fiche dans la borne correspondante de la prise et pousser jusqu'au fond.
Cet appareil numérique de la classe B est conforme à la norme NMB-003 du Canada.

IMPORTANT

Please record the serial number of this unit in the space below.

MODEL:

Serial No.:

The serial number is located on the rear of the unit. Retain this Owner's Manual in a safe place for future reference.

Contents

INTRODUCTION

| | |
|--|---|
| Features | 2 |
| Getting started | 3 |
| Quick start guide | 4 |
| Preparation: Check the items | 4 |
| Step 1: Set up your speakers | 5 |
| Step 2: Connect your DVD player and other components | 6 |
| Step 3: Press SCENE 1 button | 7 |
| What do you want to do with this unit? | 8 |

PREPARATION

| | |
|--|----|
| Connections | 9 |
| Rear panel | 9 |
| Placing speakers | 10 |
| Connecting speakers | 11 |
| Information on jacks and cable plugs | 13 |
| Information on HDMI™ | 14 |
| Audio and video signal flow | 14 |
| Connecting video components | 15 |
| Connecting other components | 16 |
| Connecting audio components | 18 |
| Connecting a Yamaha iPod™ universal dock or Bluetooth™ adapter | 19 |
| Using the VIDEO AUX jacks on the front panel | 19 |
| Connecting the FM and AM antennas | 20 |
| Connecting the power cable | 20 |
| Setting the speaker impedance | 21 |
| Turning on and off the power | 21 |
| Front panel display | 22 |
| Optimizing the speaker setting for your listening room | 24 |
| Using AUTO SETUP | 24 |

BASIC OPERATION

| | |
|---|----|
| Selecting the SCENE templates | 28 |
| Selecting the desired SCENE template | 28 |
| Creating your original SCENE templates | 31 |
| Using remote control on the SCENE feature | 32 |
| Playback | 33 |
| Basic operations | 33 |
| Selecting audio input jacks (AUDIO SELECT) | 34 |
| Selecting the MULTI CH INPUT component | 34 |
| Displaying the current status of this unit on a video monitor | 35 |
| Using your headphones | 35 |
| Muting the audio output | 35 |
| Playing video sources in the background of an audio source | 36 |
| Displaying the input source information | 36 |
| Using the sleep timer | 37 |
| Sound field programs | 38 |
| Sound field program descriptions | 38 |
| Using audio features | 41 |
| Enjoying high quality sound | 41 |
| Adjusting the tonal quality | 41 |
| Adjusting the speaker level | 41 |
| Selecting the night listening mode | 42 |
| FM/AM tuning | 43 |
| Automatic tuning | 43 |
| Manual tuning | 43 |
| Automatic preset tuning | 44 |
| Manual preset tuning | 44 |
| Selecting preset stations | 45 |
| Exchanging preset station | 45 |

| | |
|---|----|
| XM Satellite Radio tuning | 46 |
| Connecting the XM Mini-Tuner Dock | 46 |
| Activating XM Satellite Radio | 47 |
| Basic XM Satellite Radio operations | 47 |
| Setting XM Satellite Radio preset channels | 49 |
| Displaying the XM Satellite Radio information | 50 |
| SIRIUS Satellite Radio™ tuning | 51 |
| Connecting the SiriusConnect™ tuner | 51 |
| Activating SIRIUS Satellite Radio™ subscription .. | 52 |
| Basic SIRIUS Satellite Radio™ operations | 52 |
| Setting the SIRIUS Satellite Radio™ preset channels | 54 |
| Setting the Parental Lock | 54 |
| Displaying the SIRIUS Satellite Radio™ information | 56 |
| Using iPod™ | 57 |
| Controlling iPod™ | 57 |
| Using Bluetooth™ components | 59 |
| Pairing the Bluetooth™ adapter and your Bluetooth component | 59 |
| Playback of the Bluetooth™ component | 59 |
| Recording | 60 |

ADVANCED OPERATION

| | |
|---|----|
| SET MENU | 61 |
| Using SET MENU | 62 |
| 1 SOUND MENU | 63 |
| 2 INPUT MENU | 68 |
| 3 OPTION MENU | 70 |
| Remote control features | 73 |
| Controlling this unit, a TV, or other components .. | 73 |
| Setting remote control codes | 75 |
| Advanced setup | 76 |

ADDITIONAL INFORMATION

| | |
|------------------------------|----|
| Troubleshooting | 78 |
| Glossary | 88 |
| Specifications | 90 |
| Index | 91 |

APPENDIX

(at the end of this manual)

| | |
|---|-----|
| Front panel | i |
| Remote control | ii |
| List of remote control codes | iii |

About this manual

- * indicates a tip for your operation.
- Some operations can be performed by using either the buttons on the front panel or the ones on the remote control. In case the button names differ between the front panel and the remote control, the button name on the remote control is given in parentheses.
- This manual is printed prior to production. Design and specifications are subject to change in part as a result of improvements, etc. In case of differences between the manual and product, the product has priority.
- “**OSPEAKERS**” or “**ODVD**” (example) indicates the name of the parts on the front panel or the remote control. Refer to the attached sheet or the pages at the end of this manual for the information about each position of the parts.
- The symbol “**☞**” with page number(s) indicates the corresponding reference page(s).

INTRODUCTION

PREPARATION

BASIC OPERATION

ADVANCED OPERATION

ADDITIONAL INFORMATION

APPENDIX

English

Features

Built-in 5-channel power amplifier

- ◆ Minimum RMS output power
[U.S.A. and Canada models]
(1 kHz, 0.9% THD, 8 Ω)
105 W/ch
[Other models]
(1 kHz, 0.9% THD, 6 Ω)
105 W/ch

SCENE select function

- ◆ Preset SCENE templates for various situations
- ◆ SCENE template customizing capability

Decoders and DSP circuits

- ◆ Proprietary Yamaha technology for the creation of multi-channel surround sound
- ◆ Compressed Music Enhancer mode
- ◆ Dolby Digital decoder
- ◆ Dolby Pro Logic/Dolby Pro Logic II decoder
- ◆ DTS decoder
- ◆ Neural Surround decoder
(U.S.A. and Canada models only)
- ◆ Virtual CINEMA DSP
- ◆ SILENT CINEMA™



Manufactured under license from Dolby Laboratories. "Dolby", "Pro Logic", and the double-D symbol are trademarks of Dolby Laboratories.

SILENT™ CINEMA

"SILENT CINEMA" is a trademark of YAMAHA CORPORATION.

iPod™

"iPod" is a trademark of Apple, Inc., registered in the U.S. and other countries.

Bluetooth™

Bluetooth is a registered trademark of the Bluetooth SIG and is used by Yamaha in accordance with a license agreement.

HDMI

"HDMI", the "HDMI" logo and "High-Definition Multimedia Interface" are trademarks or registered trademarks of HDMI Licensing LLC.

Radio tuners

- ◆ FM/AM tuning capability
- ◆ XM Satellite Radio tuning capability (using XM Mini-Tuner and Home Dock, sold separately)
- ◆ SIRIUS Satellite Radio™ tuning capability (using SIRIUS Connect tuner, sold separately)

HDMI (High-Definition Multimedia Interface)

- ◆ HDMI interface for standard, enhanced or high-definition video (includes 1080p video signal transmission) as well as multi-channel digital audio

DOCK terminal

- ◆ DOCK terminal to connect a Yamaha iPod universal dock (such as YDS-10, sold separately) or Bluetooth adapter (such as YBA-10, sold separately).

Other features

- ◆ YPAO (Yamaha Parametric Room Acoustic Optimizer) for automatic speaker setup
- ◆ 192-kHz/24-bit D/A converter
- ◆ DIRECT mode for high quality sound for all sources
- ◆ 6 additional input jacks for discrete multi-channel input
- ◆ OSD (on-screen display) menus that allow you to optimize this unit to suit your individual audiovisual system
- ◆ Component video input/output capability (3 COMPONENT VIDEO INs and 1 MONITOR OUT)
- ◆ Optical and coaxial digital audio signal jacks
- ◆ Sleep timer
- ◆ Cinema and music night listening modes
- ◆ iPod controlling capability
- ◆ Remote control with preset remote control codes



"DTS" and "DTS Digital Surround" are registered trademarks of DTS, Inc.



The XM name and related logos are registered trademarks of XM Satellite Radio Inc.



Neural Surround™ name and related logos are trademarks owned by Neural Audio Corporation.



©2006 SIRIUS Satellite Radio Inc. "SIRIUS", "Sirius Connect", the SIRIUS dog logo, channel names and logos are trademarks of SIRIUS Satellite Radio Inc.

Getting started

■ Supplied accessories

Check that you received all of the following parts.

- Remote control
- Batteries (2) (AAA, R03, UM-4)
- Optimizer microphone
- AM loop antenna
- Indoor FM antenna

■ VOLTAGE SELECTOR (Asia and General models only)

Caution

The VOLTAGE SELECTOR on the rear panel of this unit must be set for your local voltage BEFORE plugging the power cable into the AC wall outlet. Improper setting of the VOLTAGE SELECTOR may cause damage to this unit and create a potential fire hazard.

Rotate the VOLTAGE SELECTOR clockwise or counterclockwise to the correct position using a straight slot screwdriver.

Voltages are as follows:

Asia model 220/230–240 V AC, 50/60 Hz

General model

..... 110/120/220/230–240 V AC, 50/60 Hz

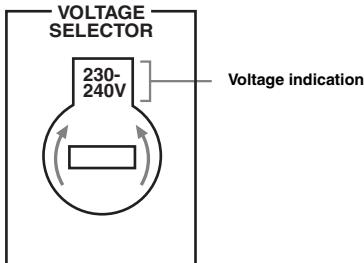

■ Installing batteries in the remote control

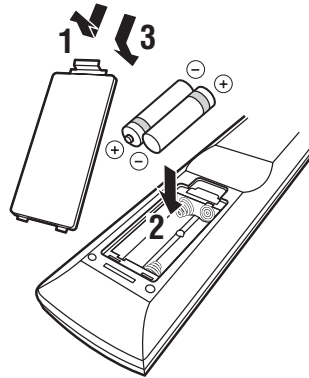

1 Take off the battery compartment cover.

2 Insert the two supplied batteries (AAA, R03, UM-4) according to the polarity markings (+ and –) on the inside of the battery compartment.

3 Snap the battery compartment cover back into place.

Notes

- Change all of the batteries if you notice that the operation range of the remote control decreases.
- Do not use an old battery and a new one together.
- Do not use different types of batteries (such as alkaline and manganese batteries) together. Read the packaging carefully as these different types of batteries may have the same shape and color.
- If the batteries have leaked, dispose of them immediately. Avoid touching the leaked material or letting it come into contact with clothing, etc. Clean the battery compartment thoroughly before installing new batteries.
- Do not throw away batteries with general house waste; dispose of them correctly in accordance with your local regulations.
- If the remote control is without batteries for more than 2 minutes, or if exhausted batteries remain in the remote control, the contents of the memory may be cleared. When the memory is cleared, insert new batteries and set up the remote control code.

We Want You Listening For A Lifetime

Yamaha and the Electronic Industries Association's Consumer Electronics Group want you to get the most out of your equipment by playing it at a safe level. One that lets the sound come through loud and clear without annoying blaring or distortion – and, most importantly, without affecting your sensitive hearing.

Since hearing damage from loud sounds is often undetectable until it is too late, Yamaha and the Electronic Industries Association's Consumer Electronics Group recommend you to avoid prolonged exposure from excessive volume levels.



Quick start guide

The following steps describe the easiest way to enjoy DVD movie playback in your home theater.

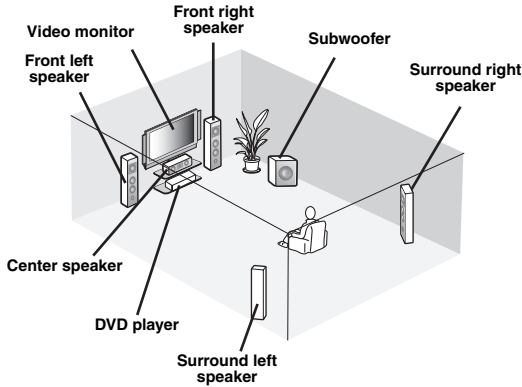

Step 1: Set up your speakers

P. 5

Step 2: Connect your DVD player and other components

P. 6

Step 3: Press SCENE 1 button

P. 7

Enjoy DVD playback!

Preparation: Check the items

Prepare the following items.

Speakers

- Front speakerx 2
- Center speakerx 1
- Surround speakerx 2

Select magnetically shielded speakers. The minimum required speakers are two front speakers. The priority of the requirement of other speakers is as follows:

1. Two surround speakers
2. Center speaker

Active subwooferx 1

Select an active subwoofer equipped with an RCA input jack.

Speaker cablex 5

Subwoofer cablex 1

Select a monaural RCA cable.

DVD playerx 1

Select DVD player equipped with coaxial digital audio output jack and composite video output jack.

Video monitorx 1

Select a TV monitor, video monitor or projector equipped with a composite video input jack.

Video cablex 2

Select an RCA composite video cable.

Digital coaxial audio cablex 1

Step 1: Set up your speakers

Place your speakers in the room and connect them to this unit.

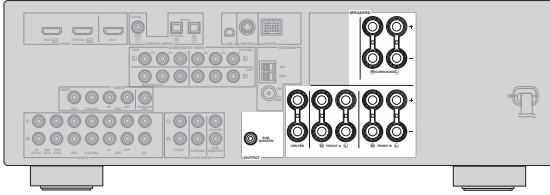

1 Place your speakers and subwoofer in the room.

2 Connect speaker cables to each speaker.

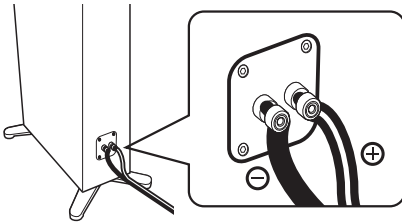

Cables are colored or shaped differently, perhaps with a stripe, groove or ridge. Connect the striped (grooved, etc.) cable to the “+” (red) terminals of your speaker. Connect the plain cable to the “-” (black) terminals.

3 Connect each speaker cable to the corresponding speaker terminal of this unit.

- ① Make sure that this unit and the subwoofer are unplugged from the AC wall outlets.
- ② Twist the exposed wires of the speaker cables together to prevent short circuits.
- ③ Do not let the bare speaker wires touch each other.
- ④ Do not let the bare speaker wires touch any metal part of this unit.

Be sure to connect the left channel (L), right channel (R), “+” (red) and “-” (black) properly.

Front and center speakers

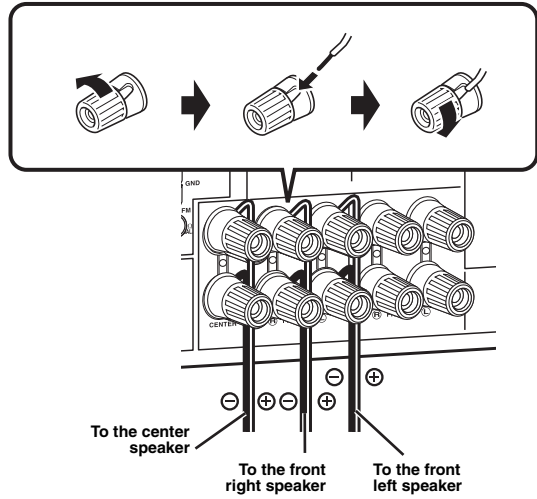

Surround speakers

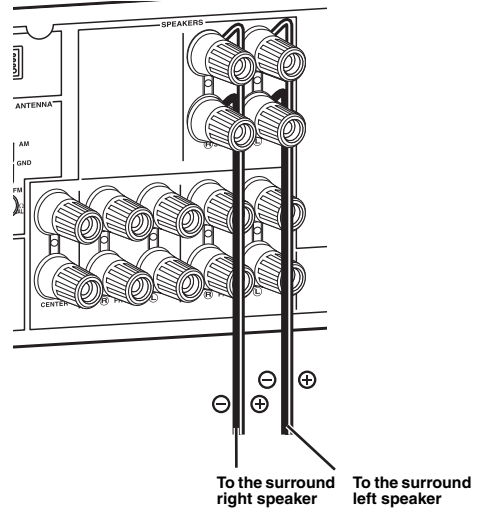

4 Connect the subwoofer cable to the input jack of the subwoofer and the SUBWOOFER OUTPUT jack of this unit.

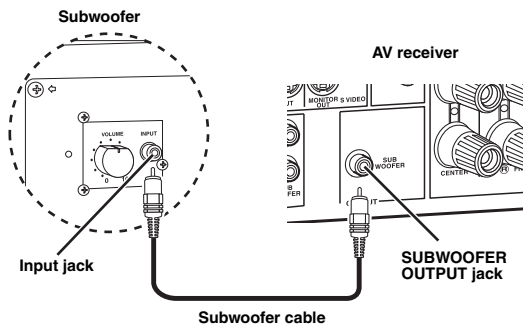

Step 2: Connect your DVD player and other components

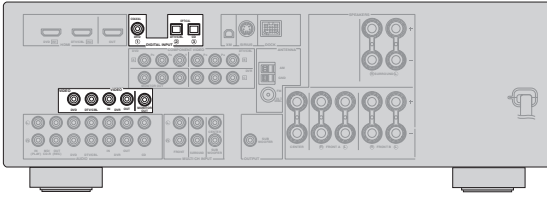

Make sure that this unit and the DVD player are unplugged from the AC wall outlets.

- 1 Connect the digital coaxial audio cable to the digital coaxial audio output jack of your DVD player and the DVD DIGITAL INPUT COAXIAL jack of this unit.

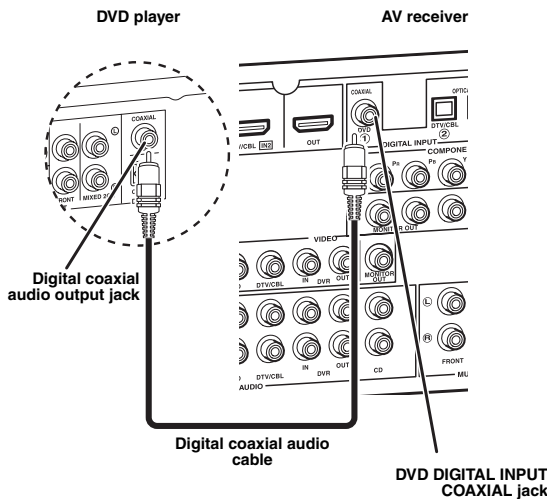

- 2 Connect the video cable to the composite video output jack of your DVD player and the DVD VIDEO jack of this unit.

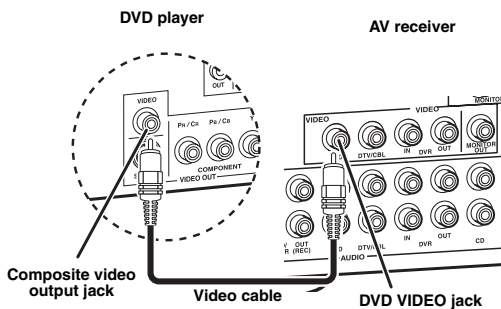

- 3 Connect the video cable to the video input jack of your video monitor and the VIDEO MONITOR OUT jack of this unit.

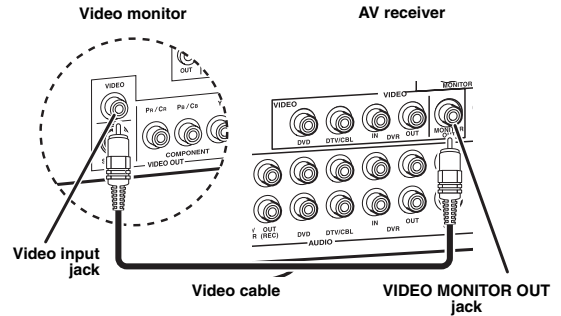

- 4 Connect the power plug of this unit and other components into the AC wall outlet.

■ For further connections

- Using the other kind of speaker combinations P. 11
- Connecting a video components P. 15
- Connecting a DVD player P. 16
- Connecting a DVD recorder P. 17
- Connecting a set-top boxes P. 17
- Connecting a CD player and a CD recorder/ MD recorder P. 18
- Connecting a multi-format player or an external decoder P. 18
- Connecting an Yamaha iPod/Bluetooth dock P. 19
- Using the VIDEO AUX jacks on the front panel P. 19
- Connecting an FM/AM antenna P. 20
- Connecting the XM Mini-Tuner Dock P. 46
- Connecting the SIRIUS Connect tuner P. 51

Step 3: Press SCENE 1 button

Check the type of the connected speakers.
If the speakers are 6 ohm speakers, set “SP IMP.” to “6Ω MIN” before using this unit (see page 21).

- 1 Turn on the video monitor and then set the input source selector of the video monitor to this unit.

- 2 Press **SCENE 1**.

This unit is turned on. “DVD Viewing” appears in the front panel display, and this unit automatically optimize own status for the DVD playback.

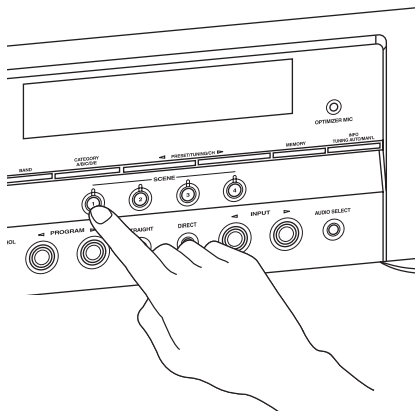

The indicator on the selected SCENE button lights up while this unit is in the SCENE mode.

- 3 Start playback of the desired DVD on your player.

- 4 Rotate **VOLUME** to adjust the volume.

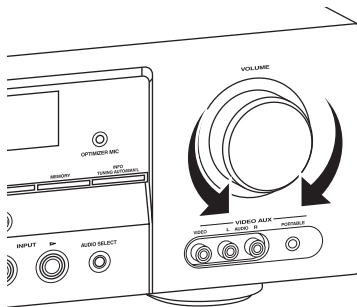

Note

When you change the input source or sound field program, the SCENE mode is deactivated.

About SCENE function

Just by pressing one SCENE button, you can turn on this unit and recall your favorite input source and sound field program according to the SCENE template that has been assigned to the SCENE button. The SCENE templates are built combinations of input sources and sound field programs.



If you connect a Yamaha product that has capability of the SCENE control signals, this unit can automatically activate the component and start playback. Refer to the instruction manual of the DVD player for further information.

The default assigned SCENE templates

| Default SCENE button | The name of the SCENE template and its description |
|----------------------|---|
| SCENE 1 | DVD Viewing – input source: DVD – sound field program: STRAIGHT For when you want to enjoy a DVD playback. |
| SCENE 2 | Disc Listening – input source: DVD – sound field program: 5ch Stereo For when you want to listen to a music disc from the connected DVD player as the background music for this room. |
| SCENE 3 | TV Viewing *1 – input source: DTV/CBL – sound field program: STRAIGHT For when you want to watch a TV program. |
| SCENE 4 | Radio Listening *2, *3, *4 – input source: TUNER – sound field program: 5ch Enhancer For when you want to listen to a music program from the FM radio station. |

Note

*1 You must connect a cable TV or a satellite tuner to this unit in advance. See page 17 for details.

*2 You need to connect the supplied FM and AM antennas to this unit in advance. See page 20 for details.

*3 You must tune into the desired radio station in advance. See pages 43 to 45 for tuning information.

*4 To achieve the best possible reception, orient the connected AM loop antenna, or adjust the position of the end of the indoor FM antenna.



You can change the assigned SCENE template for the SCENE buttons. See page 28 for details.

■ After using this unit...

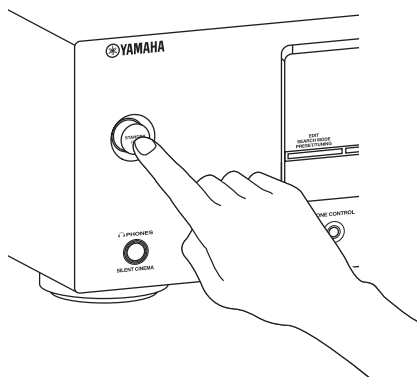

Press **(A)STANDBY/ON** on the front panel to set this unit to the standby mode.









This unit is set to the standby mode. In the standby mode, this unit consumes a small amount of power in order to receive infrared signals from the remote control. To turn on this unit from the standby mode, press **(A)STANDBY/ON** (or **(B)POWER**). See page 21 for details.

What do you want to do with this unit?



■ Customizing the SCENE templates

- Using various SCENE templates  P. 28
- Creating your original SCENE templates  P. 31





■ Using various input sources

- Basic controls of this unit  P. 33
- Enjoying FM/AM radio programs  P. 43
- Enjoying XM Satellite Radio programs  P. 46
- Enjoying SIRIUS Satellite Radio programs  P. 51
- Using your iPod with this unit.  P. 57
- Using your Bluetooth components with this unit.  P. 59

■ Using various sound features

- Using various sound field programs  P. 38
- Using the direct mode for the high quality sound  P. 41
- Customizing the sound field programs  P. 40

■ Adjusting the parameters of this unit

- Automatically optimizing the speaker parameters for your listening room (AUTO SETUP)  P. 24
- Manually adjusting various parameters of this unit  P. 61
- Setting the remote control  P. 73
- Adjusting the advanced parameters  P. 76

■ Additional features

- Automatically turning off this unit  P. 37

Connections

Rear panel

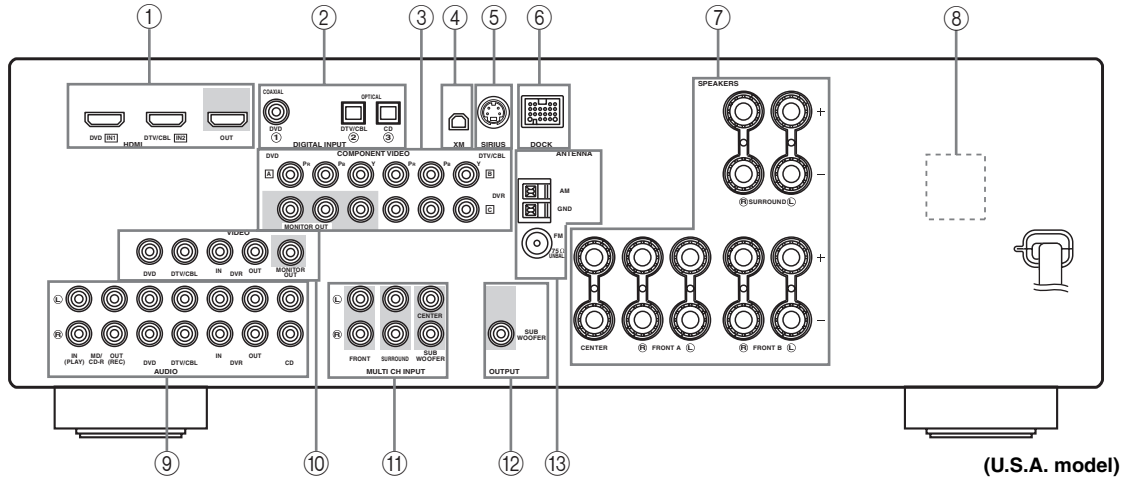

| Name | Page |
|---|------|
| ① HDMI jacks | 14 |
| ② DIGITAL INPUT jacks | 13 |
| ③ COMPONENT VIDEO jacks | 13 |
| ④ XM jack (U.S.A. and Canada models only) | 46 |
| ⑤ SIRIUS jack (U.S.A. and Canada models only) | 51 |
| ⑥ DOCK terminal | 19 |
| ⑦ Speaker terminals | 11 |
| ⑧ VOLTAGE SELECTOR (Asia and General models only) | 3 |
| ⑨ AUDIO jacks | 13 |
| ⑩ VIDEO jacks | 13 |
| ⑪ MULTI CH INPUT jacks | 18 |
| ⑫ SUBWOOFER OUTPUT jack | 11 |
| ⑬ ANTENNA terminals | 20 |

Placing speakers

The speaker layout below shows the speaker setting we recommend. You can use it to enjoy CINEMA DSP and multi-channel audio sources.

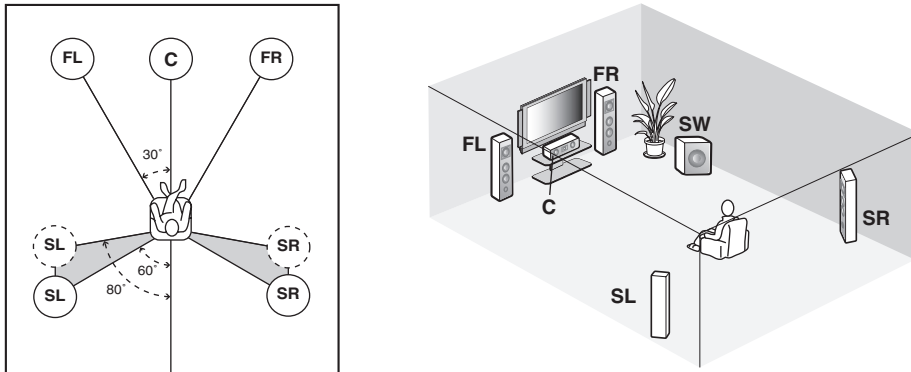

Front left and right speakers (FL and FR)

The front speakers are used for the main source sound plus effect sounds. Place these speakers at an equal distance from the ideal listening position. The distance of each speaker from each side of the video monitor should be the same.

Center speaker (C)

The center speaker is for the center channel sounds (dialog, vocals, etc.). If for some reason it is not practical to use a center speaker, you can do without it. Best results, however, are obtained with the full system.

Surround left and right speakers (SL and SR)

The surround speakers are used for effect and surround sounds.

Subwoofer (SW)

The use of a subwoofer with a built-in amplifier, such as the Yamaha Active Servo Processing Subwoofer System, is effective not only for reinforcing bass frequencies from any or all channels, but also for high fidelity sound reproduction of the LFE (low-frequency effect) channel included in Dolby Digital and DTS sources. The position of the subwoofer is not so critical, because low bass sounds are not highly directional. But it is better to place the subwoofer near the front speakers. Turn it slightly toward the center of the room to reduce wall reflections.

Connecting speakers

Be sure to connect the left channel (L), right channel (R), “+” (red) and “-” (black) properly. If the connections are faulty, this unit cannot reproduce the input sources accurately.

Caution

- Before connecting the speakers, make sure that the AC power plug is disconnected from the AC wall outlet.
- Do not let the bare speaker wires touch each other or let them touch any metal part of this unit. This could damage this unit and/or the speakers. If the speaker wires are short-circuited, “CHECK SP WIRES” appears in the front panel display when you turn on this unit.
- Use the magnetically shielded speakers. If this type of speaker still creates interference with the monitor, place the speakers away from the monitor.
- If you are to use 6 ohm speakers, be sure to set “SP IMP.” to “6Ω MIN” before using this unit. For details about the speaker impedance setting, see page 21.

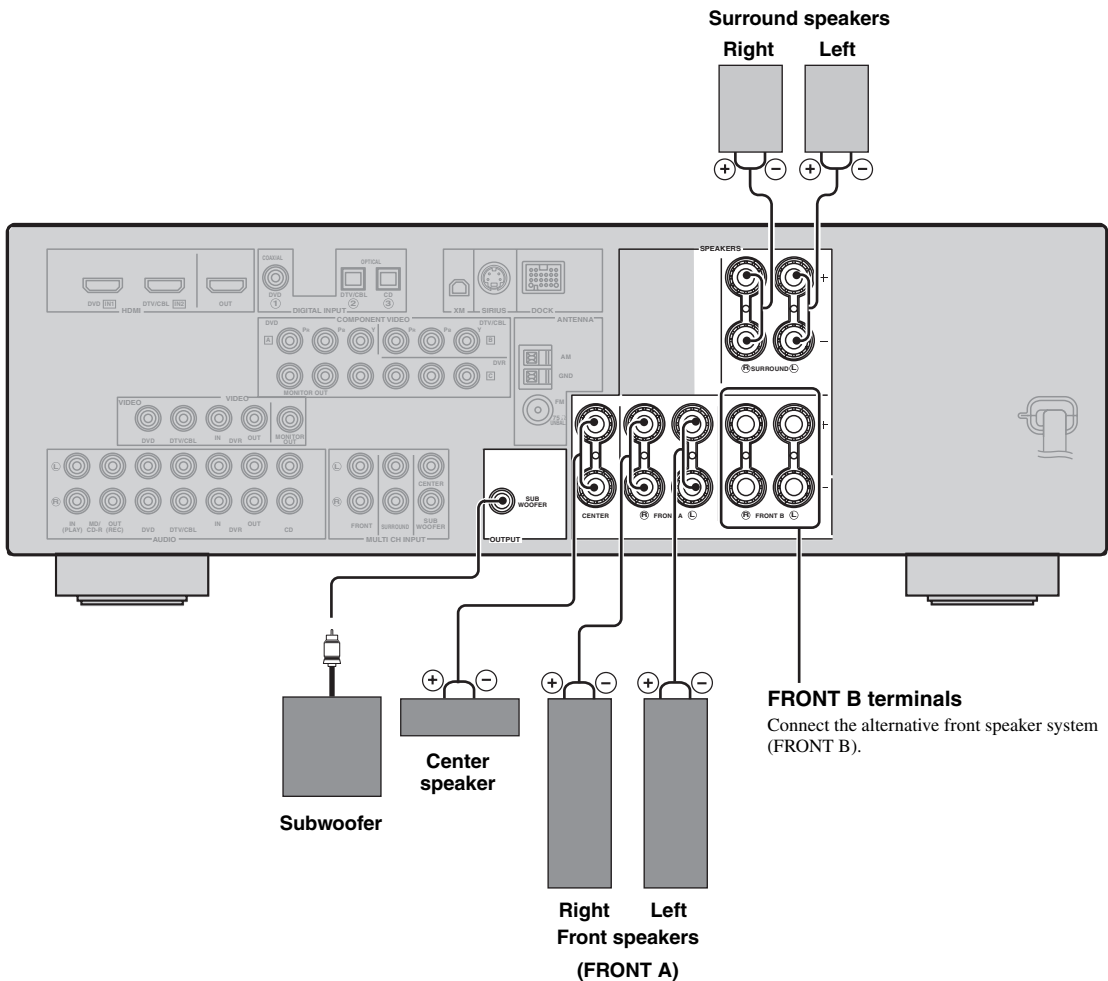

■ Before connecting to the SPEAKERS terminal

A speaker cord is actually a pair of insulated cables running side by side. Cables are colored or shaped differently, perhaps with a stripe, groove or ridges. Connect the striped (grooved, etc.) cable to the “+” (red) terminals of this unit and your speaker. Connect the plain cable to the “-” (black) terminals.

Remove approximately 10 mm (3/8”) of insulation from the end of each speaker cable and then twist the bare wires of the cable together to prevent short circuits.

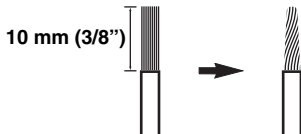

■ Connecting to the SPEAKER terminals

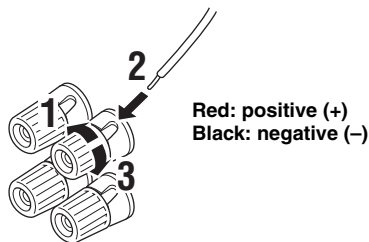

1 Loosen the knob.

2 Insert the bare end of the speaker wire into the hole on the terminal.

3 Tighten the knob to secure the wire.

Connecting the banana plug (except Europe, Russia, Korea, and Asia models)

The banana plug is a single-pole electrical connector widely used to terminate speaker cables. First, tighten the knob and then insert the banana plug connector into the end of the corresponding terminal.

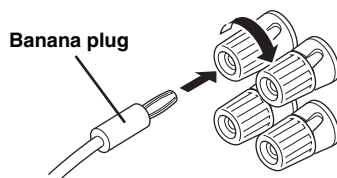

Information on jacks and cable plugs

Connect one of the type of the audio jack(s) and/or video jack(s) that your input components are equipped with.

Audio jacks and cable plugs

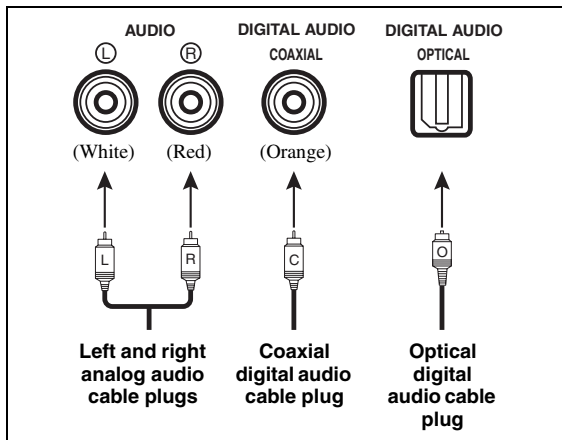

Video jacks and cable plugs

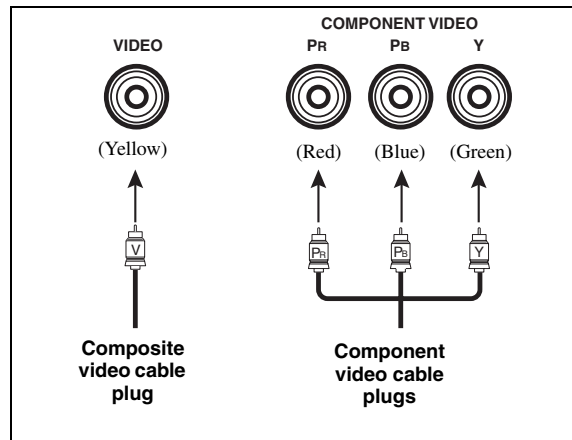

■ Audio jacks

This unit has three types of audio jacks. Connection depends on the availability of audio jacks on your other components.

AUDIO jacks

For conventional analog audio signals transmitted via left and right analog audio cables. Connect red plugs to the right jacks and white plugs to the left jacks.

DIGITAL AUDIO COAXIAL jacks

For digital audio signals transmitted via coaxial digital audio cables.

DIGITAL AUDIO OPTICAL jacks

For digital audio signals transmitted via optical digital audio cables.

Notes

- You can use the digital jacks to input PCM, Dolby Digital and DTS bitstreams. Optical input jacks are compatible with digital signals with up to 96 kHz of sampling frequency.
- This unit handles digital and analog signals independently. Thus audio signals input at the digital jacks are not output at the analog AUDIO OUT (REC) jacks.

■ Video jacks

This unit has two types of video jacks. Connection depends on the availability of input jacks on your video monitor.

VIDEO jacks

For conventional composite video signals transmitted via composite video cables.

COMPONENT VIDEO jacks

For component signals, separated into the luminance (Y) and chrominance (Pb, Pr) video signals transmitted on separate wires of component video cables.

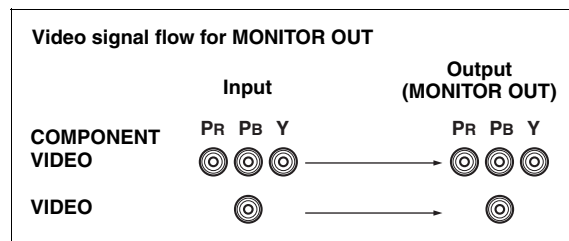

Note

The OSD signal is not output at the DVR OUT (REC) jacks.

Information on HDMI™

HDMI compatibility with this unit

| Audio signal types | Audio signal formats | Compatible HDMI components |
|---------------------|-------------------------------|--------------------------------|
| 2ch Linear PCM | 2ch, 32-192 kHz, 16/20/24 bit | CD, DVD-Video, DVD-Audio, etc. |
| Multi-ch Linear PCM | 6ch, 32-192 kHz, 16/20/24 bit | DVD-Audio, etc. |
| Bitstream | Dolby Digital, DTS | DVD-Video, etc. |

This unit's HDMI interface is based on the following standards:

- HDMI Version 1.2a (High-Definition Multimedia Interface Specification Version 1.2a) licensed by HDMI Licensing, LLC.
- HDCP (High-bandwidth Digital Content Protection System) licensed by Digital Content Protection, LLC.

Notes

- When CPPM copy-protected DVD audio is played back, video and audio signals may not be output depending on the type of the DVD player.
- This unit is not compatible with HDCP-incompatible HDMI or DVI components.
- You can check the potential problem about the HDMI connection (see page 36).

HDMI jack and cable plug

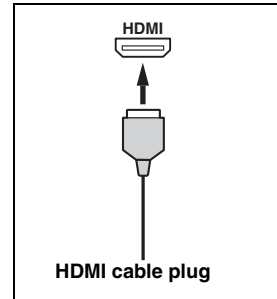

- We recommend using an HDMI cable shorter than 5 meters (16 feet) with the HDMI logo printed on it.
- Use a conversion cable (HDMI jack ↔ DVI-D jack) to connect this unit to other DVI components.

Notes

- Do not disconnect or connect the cable or turn off the power of the HDMI components connected to the HDMI OUT jack of this unit while data is being transferred. Doing so may disrupt playback or cause noise.
- Audio signals input at input jacks other than the HDMI IN DVD or HDMI IN DTV/CBL jack of this unit cannot be digitally output at the HDMI OUT jack.
- If you turn off the power of the video monitor connected to the HDMI OUT jack via a DVI connection, this unit may fail to establish the connection to the component.

Audio and video signal flow

Audio signal flow

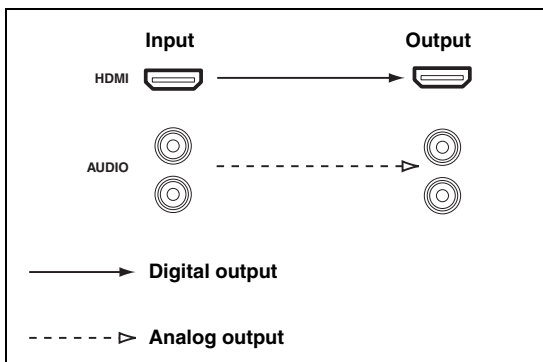

Notes

- 2-channel as well as multi-channel PCM, Dolby Digital and DTS signals input at the HDMI IN DVD or HDMI IN DTV/CBL jack can be output at the HDMI OUT jack only when "SUPPORT AUDIO" is set to "Other" (see page 67).
- Audio signals input at the HDMI IN jacks are not output at the AUDIO output jacks.

Video signal flow

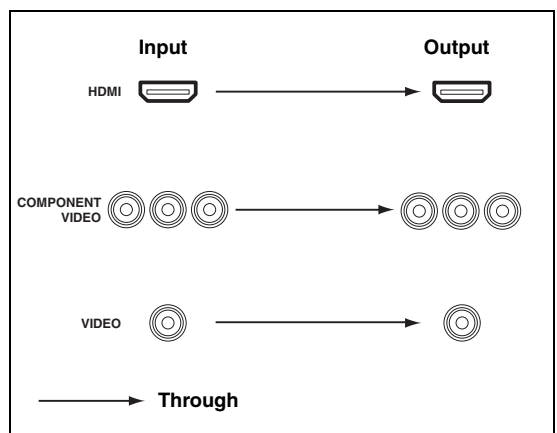

Connecting video components

Connect your TV (or projector) to the HDMI OUT jack, the COMPONENT VIDEO MONITOR OUT jacks, or the VIDEO MONITOR OUT jack of this unit.



Make sure that this unit and other components are unplugged from the AC wall outlets.



You can choose to play back HDMI audio signals on this unit or on another HDMI component connected to the HDMI OUT jack of this unit. Use the “SUPPORT AUDIO” parameter in “SOUND MENU” to select the component to play back HDMI audio signals (see page 67).

Notes

- Some video monitors connected to this unit via a DVI connection fail to recognize the HDMI audio/video signals being input if they are in the standby mode. In this case, the HDMI indicator flashes irregularly.
- When you connect your TV monitor or projector via HDMI connection, the OSD does not appear. In such cases, connect the TV monitor or projector via component, or video connection.
- Connect the input source components to the HDMI IN DVD or HDMI IN DTV/CBL jack to display the video images on the video monitor connected to the HDMI OUT jack.

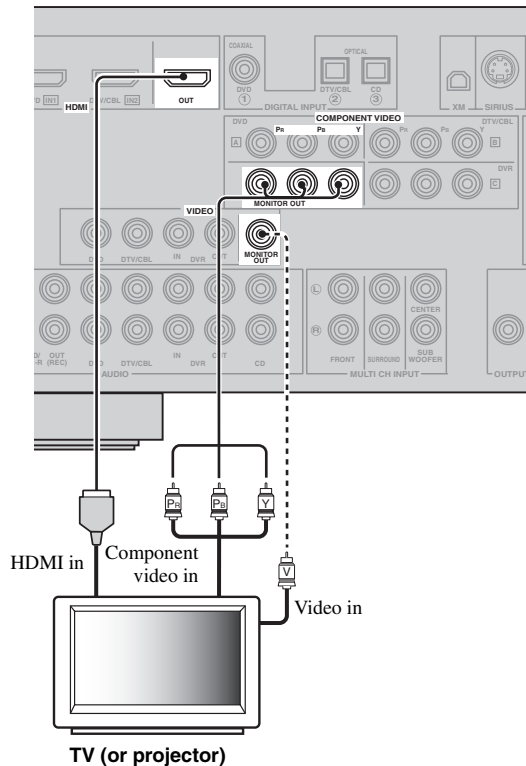

———— indicates recommended connections

----- indicates alternative connections

Connecting other components



Make sure that this unit and other components are unplugged from the AC wall outlets.

Notes

- Be sure to make the same type of video connections as those made for your TV (see page 15).
- To make a digital connection to a component other than the default component assigned to DIGITAL INPUT jack, select the corresponding setting for “OPTICAL IN” or “COAXIAL IN” in “INPUT ASSIGNMENT” (see page 68).

■ Connecting a DVD player

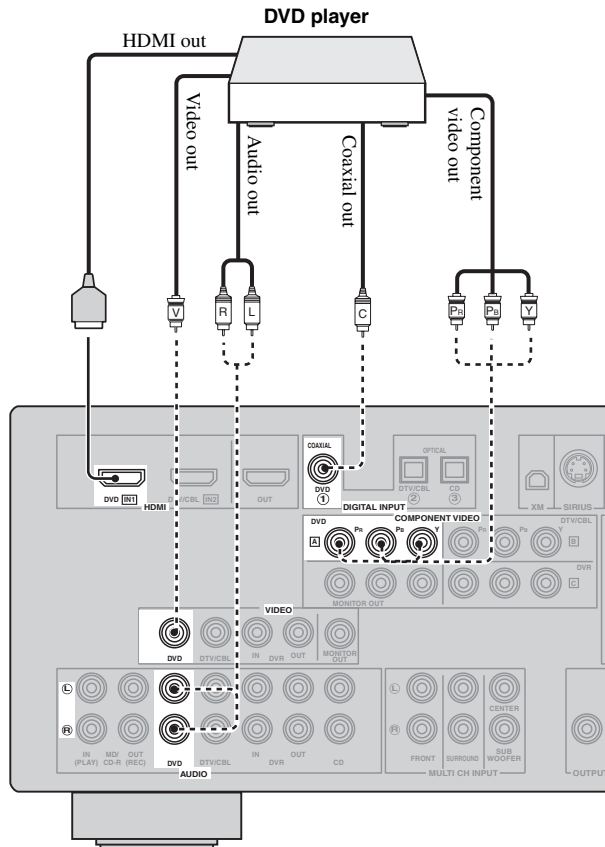

———— indicates recommended connections
 - - - - indicates alternative connections
 (One for the video connection,
 and one for the audio connection)

■ Connecting a DVD recorder, PVR or VCR

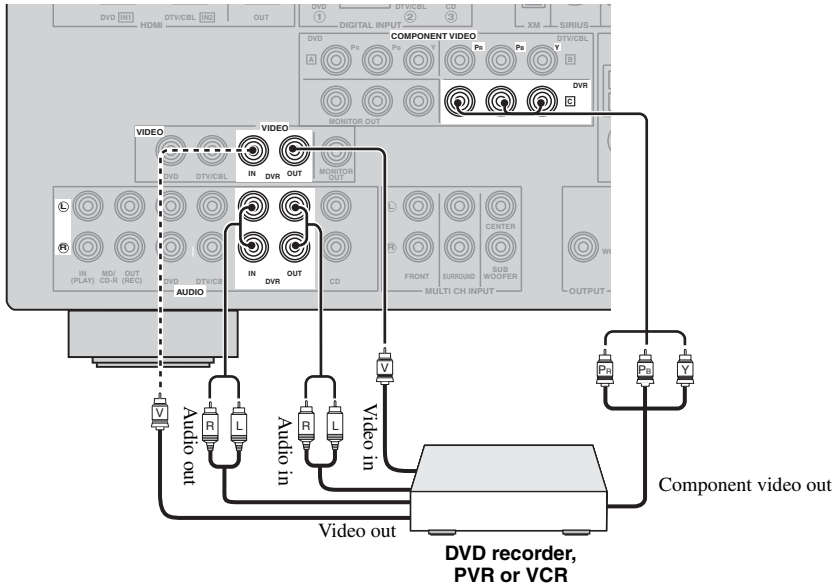

PREPARATION

■ Connecting a set-top box

Satellite receiver, cable TV receiver or HDTV decoder

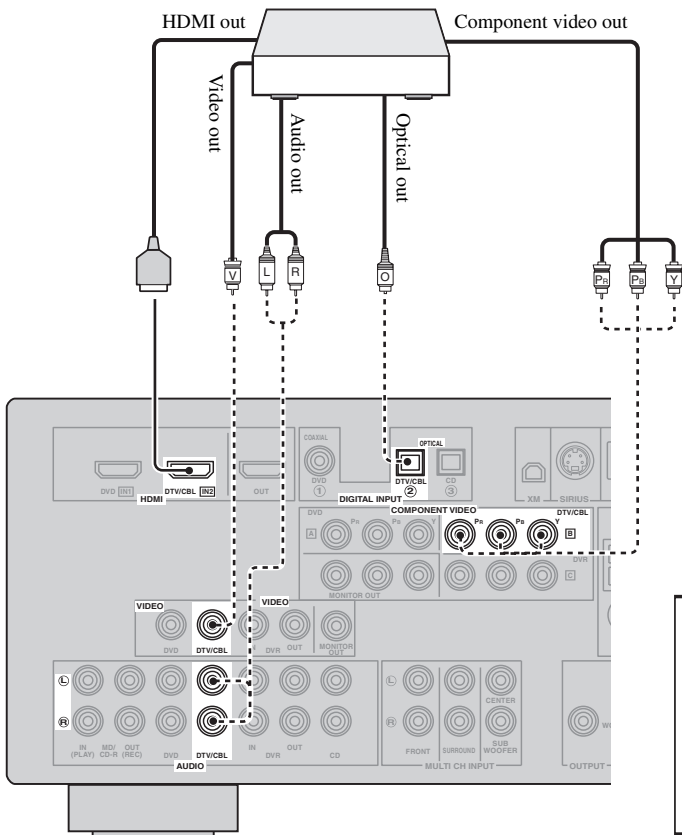

— indicates recommended connections
 indicates alternative connections (One for the video connection, and one for the audio connection)

English

Connecting audio components

Connect the audio components as follows.

■ Connecting a CD player and a CD recorder/MD recorder

Notes

- When you connect your CD player via analog and digital connection, priority is given to the signal input at the DIGITAL INPUT jack.
- To make a digital connection to a component other than the default component assigned to each DIGITAL INPUT jack, select the corresponding setting in "INPUT ASSIGNMENT" (see page 68).



Make sure that this unit and other components are unplugged from the AC wall outlets.

— indicates recommended connections
 - - - - - indicates alternative connections

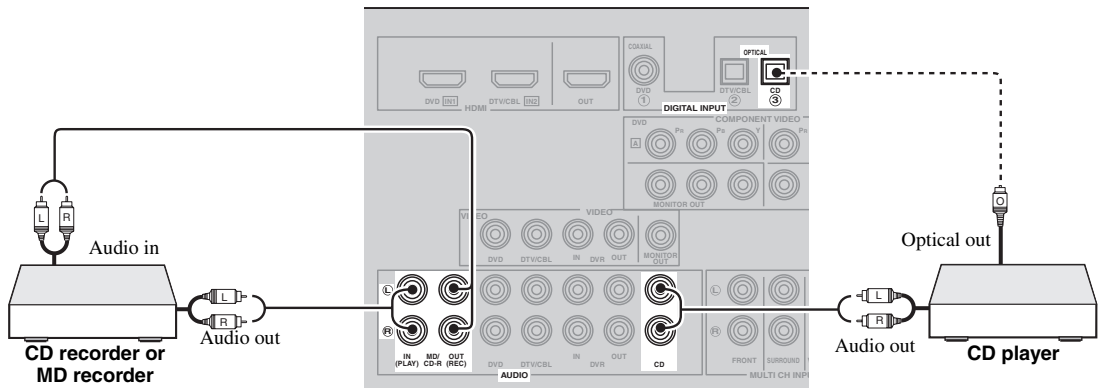

■ Connecting a multi-format player or an external decoder

This unit is equipped with 6 additional input jacks (FRONT L/R, SURROUND L/R, CENTER and SUBWOOFER) for discrete multi-channel input from a multi-format player, external decoder or sound processor. Connect the output jacks on your multi-format player or external decoder to the MULTI CH INPUT jacks. Be sure to match the left and right input jacks to the left and right input jacks for the front and surround channels.

Notes

- When you select the component connected to the MULTI CH INPUT jacks as the input source (see page 34), this unit automatically turns off the digital sound field processor, and you cannot select sound field programs.
- This unit does not redirect signals input at the MULTI CH INPUT jacks to accommodate for missing speakers. We recommend that you connect a 5.1-channel speaker system before using this feature.

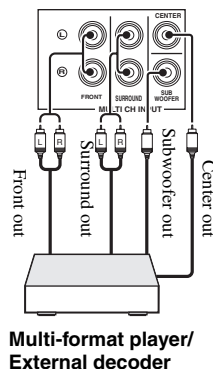

Connecting a Yamaha iPod™ universal dock or Bluetooth™ adapter



Make sure that this unit and other components are unplugged from the AC wall outlets.

This unit is equipped with the DOCK terminal on the rear panel that allows you to connect a Yamaha iPod universal dock (such as YDS-10, sold separately) or Bluetooth adapter (such as YBA-10, sold separately). Connect a Yamaha iPod universal dock or Bluetooth adapter to the DOCK terminal on the rear panel of this unit using its dedicated cable.

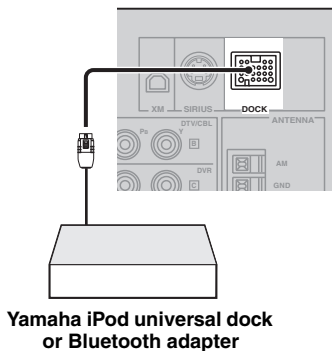

Using the VIDEO AUX jacks on the front panel

Use the VIDEO AUX jacks on the front panel to connect a game console or a video camera to this unit.

Caution

Be sure to turn down the volume of this unit and other components before making connections.

Notes

- To reproduce the source signals input at these jacks, select “V-AUX” as the input source.
- When audio signals are input at the AUDIO jacks, PORTABLE jack and the DOCK terminal on the rear panel, the priority order of the input signal is as follows:
 - DOCK
 - PORTABLE
 - AUDIO

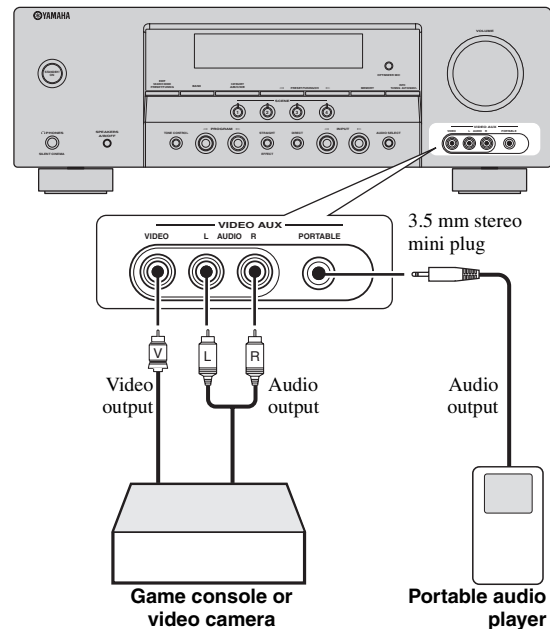

Connecting the FM and AM antennas

Both FM and AM indoor antennas are supplied with this unit. Connect each antenna correctly to the designated terminals. In general, these antennas should provide sufficient signal strength.



See right for connection information of the supplied AM loop antenna.

Notes

- The AM loop antenna should be placed away from this unit.
- The AM loop antenna should always be connected, even if an outdoor AM antenna is connected to this unit.
- A properly installed outdoor antenna provides clearer reception than an indoor one. If you experience poor reception quality, install an outdoor antenna. Consult the nearest authorized Yamaha dealer or service center about outdoor antennas.

Outdoor AM antenna

Use a 5 to 10 m (16 to 33 ft) vinyl-covered wire extended outdoors from a window.

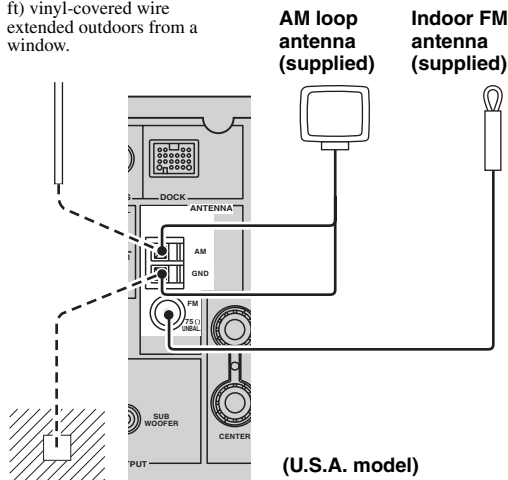

Ground (GND terminal)

For maximum safety and minimum interference, connect the antenna GND terminal to a good earth ground. A good earth ground is a metal stake driven into moist earth.

Connecting the wire of the AM loop antenna

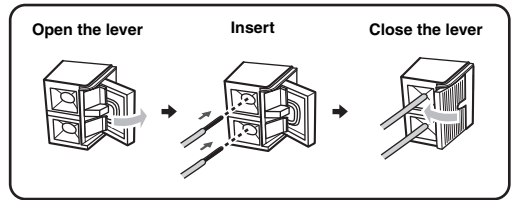

The wire of the AM loop antenna does not have any polarity and you can connect either end of the wire to AM or GND terminal.

Assembling the supplied AM loop antenna

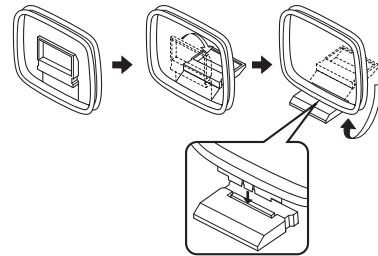

Note

The types of the supplied AM loop antenna is different depending on the models.

Connecting the power cable

Once all connections are complete, plug the power cable into the AC wall outlet.

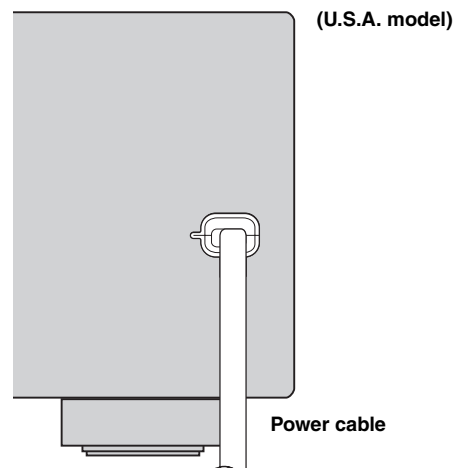

Setting the speaker impedance

Caution

If you are to use 6 ohm speakers, set “SP IMP.” to “6Ω MIN” as follows BEFORE using this unit.

- 1 Press **(A) STANDBY/ON** on the front panel to set this unit to the standby mode.

Refer to the right column for details.

- 2 Press and hold **(K) TONE CONTROL** and then press **(A) STANDBY/ON** to turn on this unit.

This unit turns on, and the advanced setup menu appears in the front panel display.



- 3 Press **(L) PROGRAM** **</>** to select “SP IMP.”.

“SP IMP.” and the current speaker impedance setting (“8Ω MIN”) appear in the front panel display.

- 4 Press **(M) STRAIGHT** repeatedly to select “6Ω MIN”.

- 5 Press **(A) STANDBY/ON** to save the new setting and turn off this unit.

Note

The setting you made is reflected next time you turn on this unit.

Turning on and off the power

Turning on this unit

Press **(A) STANDBY/ON** (or **(B) POWER**) to turn on this unit.



When you turn on this unit, there will be a 4 to 5-second delay before this unit can reproduce sound.

Set this unit to the standby mode

Press **(A) STANDBY/ON** (or **(B) STANDBY**) to set this unit to the standby mode.

In the standby mode, this unit consumes a small amount of power in order to receive infrared signals from the remote control.

Front panel display

Note

The XM and SIRIUS indicator is only applicable to the U.S.A. and Canada models and the cursor on the left of the XM indicator or SIRIUS indicator lights up only when “XM” or “SIRIUS” is selected as the input source.

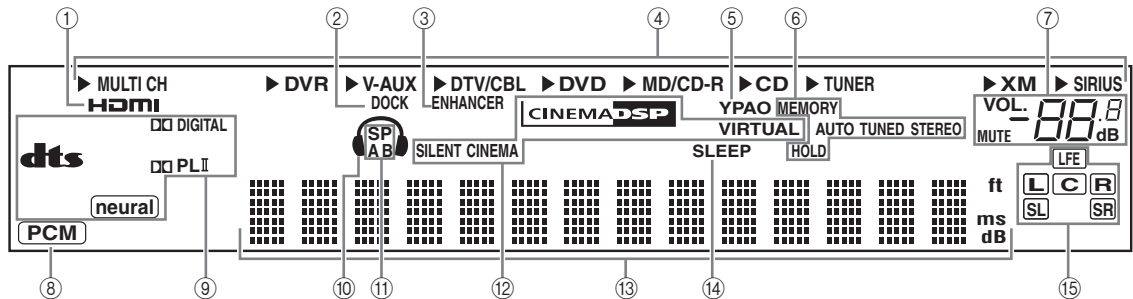

① HDMI indicator

Lights up when the signal of the selected input source is input at the HDMI IN jacks (see page 14).

② DOCK indicator

- Lights up when you station your iPod in a Yamaha iPod universal dock (such as YDS-10, sold separately) connected to the DOCK terminal of this unit (see page 19) and V-AUX is selected as the input source.
- Flashes while the connected Yamaha Bluetooth adaptor (such as YBA-10, sold separately) and the Bluetooth component is in the pairing (see page 59) or the Bluetooth adaptor is searching the Bluetooth component (see page 59).
- Lights up while the connected Yamaha Bluetooth adaptor is connected to the Bluetooth component (see page 19).

③ ENHANCER indicator

Lights up when the Compressed Music Enhancer mode is selected (see page 38).

④ Input source indicators

The corresponding cursor lights up to show the currently selected input source.

⑤ YPAO indicator

Lights up when you run “AUTO SETUP” and when the speaker settings set in “AUTO SETUP” are used without any modifications (see page 24).

⑥ Tuner indicators

Lights up when this unit is in the FM, AM, XM Satellite Radio or SIRIUS Satellite Radio tuning mode (see pages 43 to 56).

⑦ MUTE indicator and VOLUME level indicator

- The MUTE indicator flashes while the MUTE function is on (see page 35).
- Indicates the current volume level.

⑧ PCM indicator

Lights up when this unit is reproducing PCM (Pulse Code Modulation) digital audio signals.

⑨ Decoder indicators

The respective indicator lights up when any of the decoders of this unit function.

⑩ Headphone indicator

Lights up when headphones are connected (see page 35).

⑪ SP A B indicators

Light up according to the set of front speakers activated (see page 33).

SP A: The FRONT A speakers are activated.

SP B: The FRONT B speakers are activated.

⑫ CINEMA DSP indicator

Lights up when you select a CINEMA DSP sound field program (see page 39).

VIRTUAL indicator

Lights up when Virtual CINEMA DSP is active (see page 39).

SILENT CINEMA indicator

Lights up when headphones are connected and a sound field program is selected (see page 39).

⑬ Multi-information display

Shows the name of the current sound field program and other information when adjusting or changing settings.

⑭ SLEEP indicator

Lights up while the sleep timer is on (see page 37).

⑮ Input channel and speaker indicators

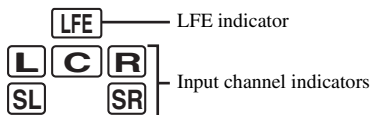

Input channel indicators

- Indicate the channel components of the current digital input signal.
- Light up or flash according to the settings of the speakers when this unit is in the automatic setup procedure (see page 24) or the speaker level setting procedure in the “SP LEVEL” (see page 65).

■ Using the remote control

The remote control transmits a directional infrared ray. Be sure to aim the remote control directly at the remote control sensor on this unit during operation.

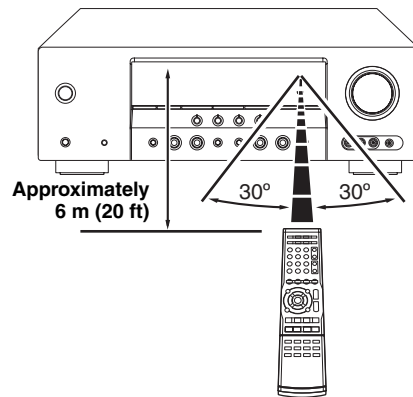

① Infrared window

Outputs infrared control signals. Aim this window at the component you want to operate.



To set the remote control codes for other components, see page 75.

Notes

- Do not spill water or other liquids on the remote control.
- Do not drop the remote control.
- Do not leave or store the remote control in the following types of conditions:
 - places of high humidity, such as near a bath
 - places of high temperature, such as near a heater or stove
 - places of extremely low temperatures
 - dusty places

Optimizing the speaker setting for your listening room

This unit employs the YPAO (Yamaha Parametric Room Acoustic Optimizer) technology which lets you avoid troublesome listening-based speaker setup and achieves highly accurate sound adjustments automatically. The supplied optimizer microphone collects and this unit analyzes the sound your speakers produce in your actual listening environment.

Using AUTO SETUP

Notes

- Be advised that it is normal for loud test tones to be output during the “AUTO SETUP” procedure.
- To achieve the best results, make sure the room is as quiet as possible while the “AUTO SETUP” procedure is in progress. If there is too much ambient noise, the results may not be satisfactory.



You can run “AUTO SETUP” using the system menu that appears in the OSD or in the front panel display. This manual uses the OSD illustrations to explain the “AUTO SETUP” procedure.

1 Make sure of the following check points.

Note

Before starting the automatic setup, check the following check points.

- Speakers are connected appropriately.
- Headphones are disconnected from this unit.
- This unit and the video monitor are turned on.
- This unit is selected as the video input source of the video monitor.
- The connected subwoofer is turned on and the volume level is set to about half way (or slightly less).
- The crossover frequency controls of the connected subwoofer is set to the maximum.

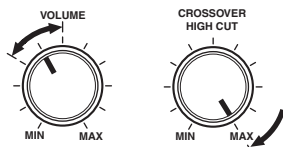

Controls of a subwoofer (example)

- FRONT A speakers are selected as the front speaker system (see page 33).
- The room is sufficiently quiet.

2 Connect the supplied optimizer microphone to the OPTIMIZER MIC jack on the front panel.

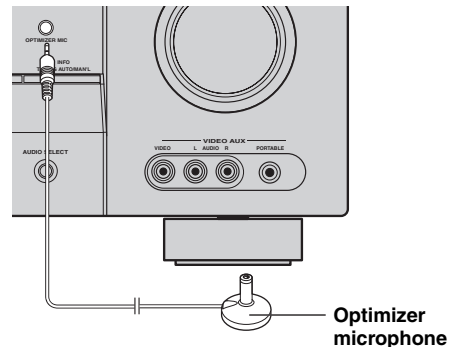

The following display appears in the OSD.

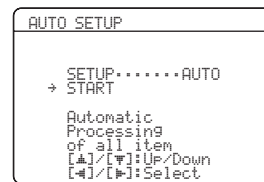

3 Place the optimizer microphone at your normal listening position on a flat level surface with the microphone heading upward.

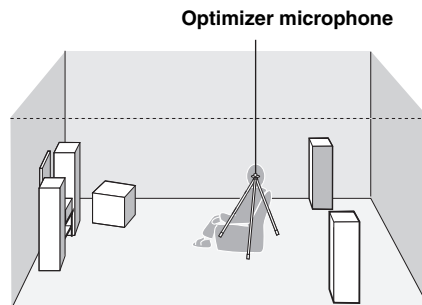

It is recommended that you use a tripod (etc.) to affix the optimizer microphone at the same height as your ears would be when you are seated in your listening position. You can use the attached screw of a tripod (etc.) to fix the optimizer microphone to the tripod (etc.).

4 Make sure that “SETUP” is set to “AUTO” and the pointer is pointing at “START”.



You can also select the following setup methods. In this case, press **Ⓢ** **△** to select “SETUP”, press **Ⓢ** **</>** to select the one of the following choices and then select “START”.

Choices: **AUTO**, RELOAD, UNDO, DEFAULT

- Select “AUTO” to automatically run the entire “AUTO SETUP” procedure.
- Select “RELOAD” to reload the last “AUTO SETUP” settings and override the previous settings.
- Select “UNDO” to undo the last “AUTO SETUP” settings and restore the previous settings.
- Select “DEFAULT” to reset the “AUTO SETUP” parameters to the initial factory settings.

Note

“RELOAD” or “UNDO” is available only when you have previously run “AUTO SETUP” and confirmed the results.

5 Press **Ⓢ** **▽** to select “START” and then press **Ⓢ** **ENTER** to start the setup procedure.

The following message appears in the OSD.

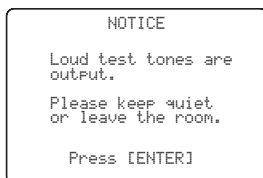

Before proceeding next operation

Once you perform the next operation, this unit starts the automatic setup procedure. For more accurate measurements, keep quiet and move to the wall where speakers are not around. We recommend that you leave the listening room during the automatic setup procedure.

6 Press **Ⓢ** **ENTER** to start the setup procedure.

This unit starts the auto setup procedure. Loud test tones are output from each speaker during the auto setup procedure. Once all items are set, the result display appears in the OSD.

Notes

- During the auto setup procedure, do not perform any operation on this unit.
- We recommend getting out of the room while this unit is in the auto setup procedure. It takes approximately 3 minutes for this unit to complete the auto setup procedure.

This unit performs the following checks:

Speaker wiring/volume level WIRING/LEVEL

Checks which speakers are connected and the polarity of each speaker. Also checks and adjusts the volume level of each speaker.

Speaker distance DISTANCE

Checks the distance of each speaker from the listening position and adjusts the timing of each channel.

Speaker size SIZE

Checks the frequency response of each speaker and sets the appropriate low-frequency crossover for each channel.

The display changes as follows.



The results displayed under “RESULT” are as follows.

Number of speakers SP

Displays the number of speakers connected to this unit in the following order:
Front/Back/Subwoofer

Speaker distance DIST

Displays the speaker distance from the listening position in the following order:
Closest speaker distance/Farthest speaker distance

Speaker level LVL

Displays the speaker output level in the following order:
Lowest speaker output level/Highest speaker output level

Notes

- If “E-9:INTERNAL ERROR” appears during the testing procedure, restart from step 4.
- If you selected “RELOAD” in step 4, no test tones are output.
- If an error occurs during the “AUTO SETUP” procedure, the setup procedure is canceled and an error screen appears. For details, see “If an error screen appears” on page 27.
- When this unit detects potential problems during the “AUTO SETUP” procedure, “WARNING” and the number of warning messages appears (see page 27).

7 Press **Ⓢ**▲ and **Ⓢ**ENTER to display the setup results in detail.

8 Press **Ⓢ**◀/▶ repeatedly to toggle between the setup result displays.

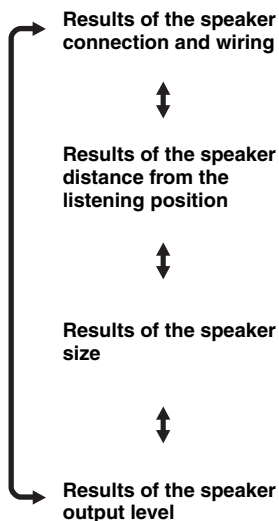

If you are not satisfied with the results or want to manually adjust each parameter, run “MANUAL SETUP” (see page 61).

Note

The distances displayed in the “DISTANCE” results may be longer than the actual distance depending on the characteristics of your speakers.

9 Press **Ⓢ**ENTER to return to the result display.

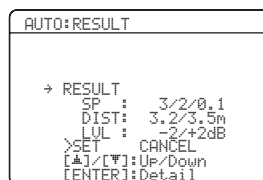

10 Press **Ⓢ** **▽** and then press **Ⓢ** **</>** to select “SET” or “CANCEL”.

Choices: **SET**, **CANCEL**

- Select “SET” to confirm the “AUTO SETUP” results.
- Select “CANCEL” to cancel the “AUTO SETUP” results.

11 Press **Ⓢ** **ENTER** to confirm your selection.

The top “SET MENU” display appears in the OSD.

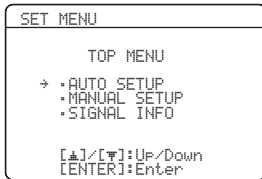

12 Press **Ⓢ** **MENU** to exit from “SET MENU”.

13 Disconnect the optimizer microphone from this unit.

The optimizer microphone is sensitive to heat. Keep it away from direct sunlight and do not place it on top of this unit.



If you change speakers, speaker positions, or the layout of your listening environment, run “AUTO SETUP” again to recalibrate your system.

■ If an error screen appears

Press **Ⓢ** **△** / **▽** / **</>** to select “RETRY” or “EXIT” and then press **Ⓢ** **ENTER**.

The following display is an example where “E-8:USER CANCEL” appears in the OSD.

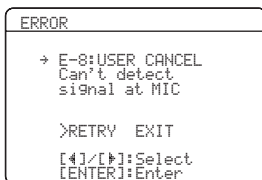

Choices: **RETRY**, **EXIT**

- Select “RETRY” to retry the “AUTO SETUP” procedure.
- Select “EXIT” to exit from the “AUTO SETUP” procedure.

■ If “WARNING” appears

When this unit detects potential problems during the “AUTO SETUP” procedure, “WARNING” appears in the result display. Check the warning messages to correct your speaker settings.

Note

Warnings differ from errors in that warnings do not cancel the “AUTO SETUP” procedure.

1 Make sure the pointer is pointing at “WARNING” and then press **Ⓢ** **ENTER** to display the detailed information about the warning.

The number on the right of “WARNING” indicates the number of warning messages.

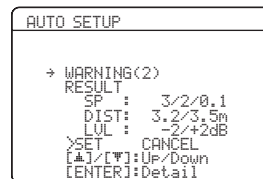

2 Press **Ⓢ** **</>** repeatedly to toggle between the warning displays.

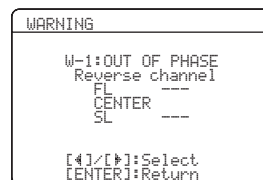

- For details about each warning message, see the “AUTO SETUP” section in “Troubleshooting” on page 84.
- When the corresponding warning message is not applicable to a speaker, “—” is displayed instead.

3 Press **Ⓢ** **ENTER** to return to the result display.

Selecting the SCENE templates

This unit is equipped with 17 preset SCENE templates for various situations of using this unit. As the initial factory setting, the following SCENE templates are assigned to each SCENE button:

- SCENE 1:** DVD Viewing
- SCENE 2:** Disc Listening
- SCENE 3:** TV Viewing
- SCENE 4:** Radio Listening

If you want to use other SCENE templates, you can select the desired SCENE templates from the SCENE template library and assign the templates to the selected SCENE buttons on the front panel and the remote control.

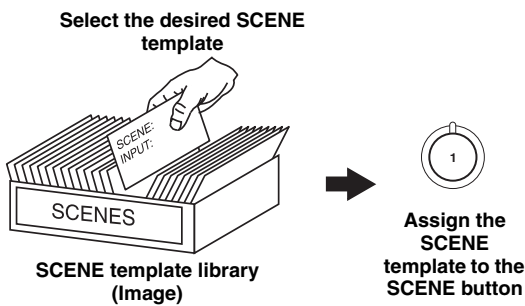

- 2** Press **ⓐINPUT** </> (or press **ⓑAMP** and then press **ⓓ</>**) to select the desired template.

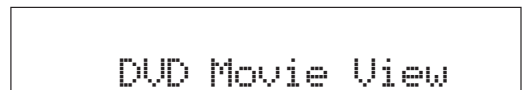
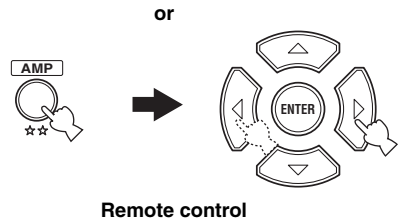
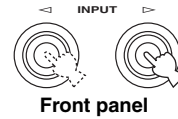

- 3** Press the **ⓐSCENE** (or **ⓑSCENE**) button again to confirm the selection.

The selected SCENE template is assigned to the button.



or



Selecting the desired SCENE template

- 1** Press and hold the desired **ⓐSCENE** (or **ⓑSCENE**) button for 3 seconds.

The indicator on the selected SCENE button on the front panel starts to flash, and the name of the currently assigned SCENE template appears in the front panel display.

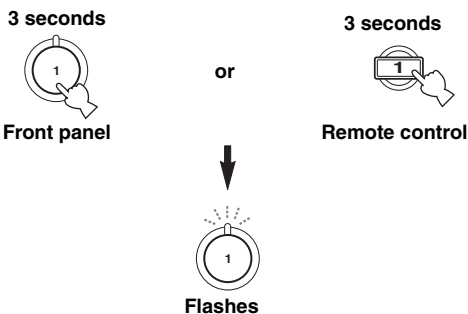

Note

Once the desired SCENE templates are assigned to the corresponding SCENE buttons, you may need to set the input source of the SCENE template on the remote control. See page 32 for details.

■ Which SCENE template would you like to select?

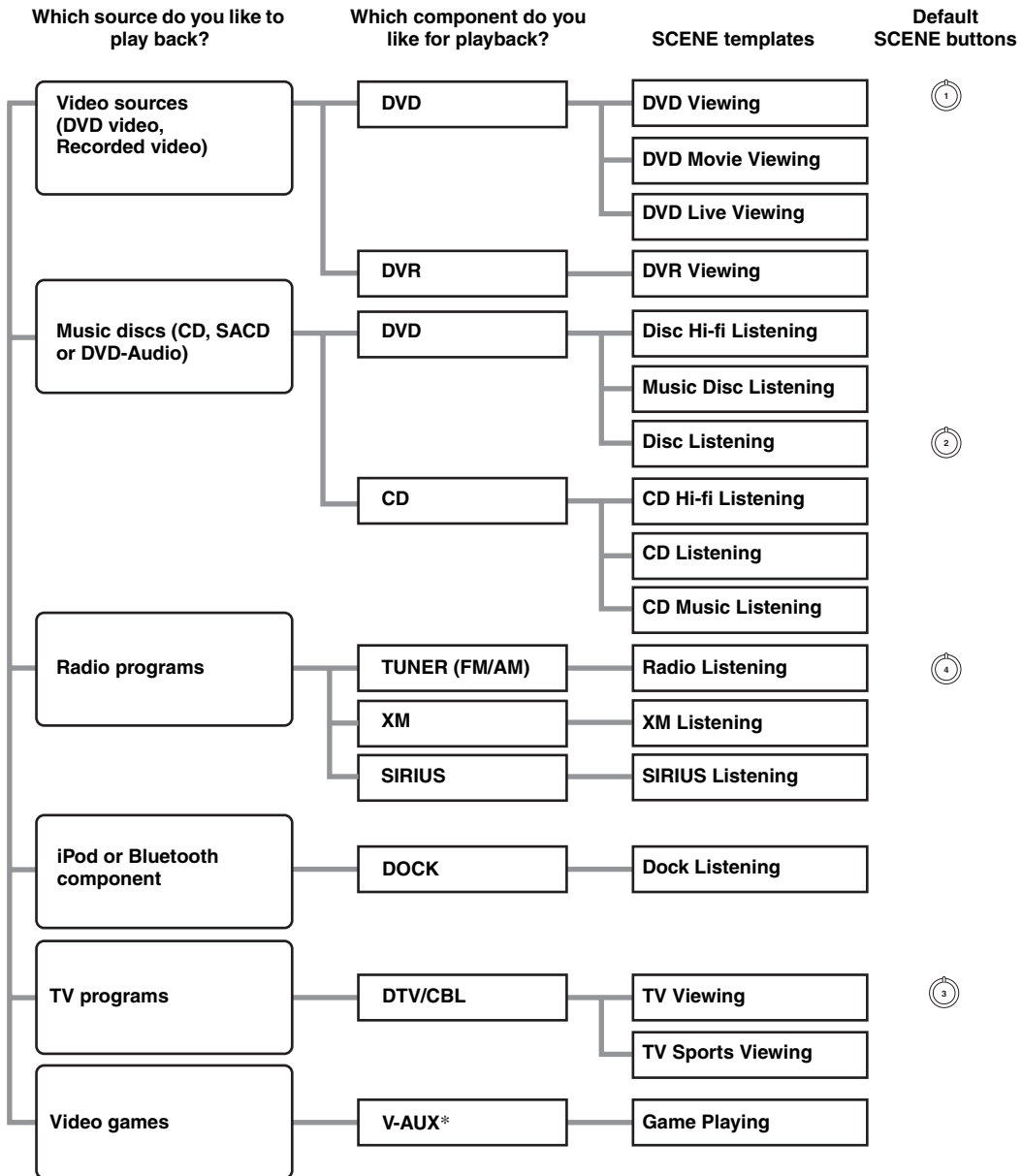

Note





* When iPod is connected to the Yamaha iPod universal dock or a Bluetooth component is connected to the Bluetooth adapter, this unit plays back the audio sources input at the DOCK terminal.



You can create your original SCENE templates by editing the preset SCENE templates. See page 31 for details.

■ Preset SCENE templates descriptions

The illustrations of the SCENE button in the following table indicate the assigned SCENE buttons in the default setting.

| SCENE template | Input source | Playback mode | Features |
|---|--------------|--|---|
| DVD Viewing  | DVD | STRAIGHT | Select this SCENE template when you play back general contents on the DVD player. |
| DVD Movie Viewing | DVD | MOVIE Movie Dramatic | Select this SCENE template when you play back movies on your DVD player. |
| DVD Live Viewing | DVD | MUSIC Pop/Rock | Select this SCENE template when you enjoy the music live video on your DVD player. |
| DVR Viewing | DVR | MOVIE Movie Dramatic | Select this SCENE template when you play back movies on your digital video recorder. |
| Disc Hi-fi Listening | DVD | DIRECT | Select this SCENE template when you enjoy the high fidelity sound of the music discs on your DVD player. |
| Music Disc Listening | DVD | STEREO 2ch Stereo | Select this SCENE template when you play back music discs on your DVD player. |
| Disc Listening  | DVD | STEREO 5ch Stereo | Select this SCENE template when you play back music sources on your DVD player as the background music. |
| CD Hi-fi Listening | CD | DIRECT | Select this SCENE template when you enjoy the high fidelity sound of the music discs on your CD player. |
| CD Listening | CD | STEREO 5ch Stereo | Select this SCENE template when you play back music discs on your CD player as the background music. |
| CD Music Listening | CD | STEREO 2ch Stereo | Select this SCENE template when you play back music source on your CD player. |
| Radio Listening  | TUNER | MUSIC ENHANCER 5ch Enhancer | Select this SCENE template when you enjoy FM or AM radio programs. |
| XM Listening | XM | MUSIC ENHANCER 5ch Enhancer | Select this SCENE template when you enjoy XM Satellite Radio programs. |
| SIRIUS Listening | SIRIUS | MUSIC ENHANCER 5ch Enhancer | Select this SCENE template when you enjoy SIRIUS Satellite Radio programs. |
| Dock Listening | DOCK | MUSIC ENHANCER 5ch Enhancer | Select this SCENE template when you play back music on your iPod stationed in a Yamaha iPod universal dock or Bluetooth component that is connected to the Bluetooth adapter. |
| TV Viewing  | DTV/CBL | STRAIGHT | Select this SCENE template when you enjoy general programs on your TV. |
| TV Sports Viewing | DTV/CBL | ENTERTAINMENT TV Sports | Select this SCENE template when you enjoy sports programs on your TV. |
| Game Playing | V-AUX | ENTERTAINMENT Game | Select this SCENE template when you play video games. |

Creating your original SCENE templates

You can create your original SCENE templates for each SCENE button. You can refer to the preset 17 SCENE templates to create the original SCENE templates.

■ Customizing the preset SCENE templates

Use this feature to customize the preset SCENE templates.

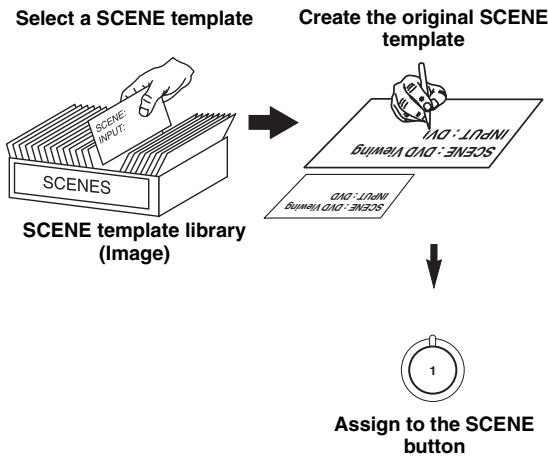

1 Turn on the video monitor connected to this unit.

2 Press and hold the desired **⑥SCENE** button for 3 seconds.

The SCENE template customizing screen appears on the video monitor.



Note

When the SCENE template you want to customize is not assigned to any of the **⑥SCENE** buttons, press **⑤AMP** and then press **④◀/▶** repeatedly to recall the desired SCENE template on the menu screen.

3 Press **⑤AMP** and then **⑧Δ/∇** to select the desired parameter of the SCENE template and then **⑧◀/▶** to select the desired value of the selected parameter.

You can adjust the following parameters for a SCENE template:

- **INPUT:** The input source component
- **MODE:** The active sound field programs, STRAIGHT or DIRECT mode (see pages 39 and 41)
- **NIGHT:** The night listening mode setting (see page 42)
 - **SYSTEM:** Keeps the current night listening mode.
 - **CINEMA:** Sets the night listening mode to the CINEMA mode.
 - **MUSIC:** Sets the night listening mode to the MUSIC mode.

4 Press the **⑥SCENE** button again to confirm the edit.



An asterisk mark (*) appears by the name of the original SCENE template.

Notes

- Once the desired SCENE templates are assigned to the corresponding **⑥SCENE** buttons, you may need to set the input source of the SCENE template on the remote control. See page 32 for details.
- You can create a customized SCENE template for each **⑥SCENE** button, and if you create another customized SCENE template, this unit overwrites the old customized SCENE template with the new one.
- The newly created template is only available for the assigned **⑥SCENE** button.

■ Renaming the SCENE templates

Select the name of the SCENE template at step 3 of “Customizing the preset SCENE templates” and then press **⑧ENTER**.

- Press **⑧Δ/∇** to select the desired character.
- Press **⑧◀/▶** to place “_” (underscore) under the space or the desired character.
- Press **⑨RETURN** to cancel the new name.
- Press **⑧ENTER** to confirm the new name.

Using remote control on the SCENE feature

Controlling the input source components in the SCENE mode

You can operate both this unit and the input source component by using the remote control. You must set the appropriate remote control code for each input source in advance (see page 75).

- 1 Press the desired **⑥ SCENE** button on the remote control.
- 2 Press the desired buttons in the * area below to control the input source component of the selected SCENE template.

Setting input source of the customized SCENE template on the remote control

If you customize the input source of the selected SCENE template, you must set the input source of the SCENE template on the remote control to operate the input source component correctly.

- 1 Press and hold the **⑥ SCENE** button and the desired input selector button (**④**) for 3 seconds.



Press the **⑥ SCENE** button again to operate the input source component.

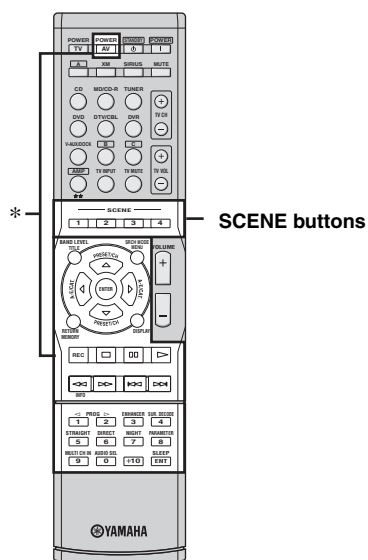

Note

- * These buttons control the input source component. See page 74 for details of the function of each button.

Playback

Caution

Extreme caution should be exercised when you play back CDs encoded in DTS. If you play back a CD encoded in DTS on a DTS-incompatible CD player, you will only hear some unwanted noise that may damage your speakers. Check whether your CD player supports CDs encoded in DTS. Also, check the sound output level of your CD player before you play back a CD encoded in DTS.

Basic operations

1 Turn on the video monitor connected to this unit.

2 Press SPEAKERS repeatedly to select the front speakers you want to use.

The respective speaker indicators lights up in the front panel display.

3 Press INPUT $\triangleleft/\triangleright$ repeatedly (or press one of the input selector buttons (4)) to select the desired input source.

The name of the currently selected input source appears in the front panel display for a few seconds.

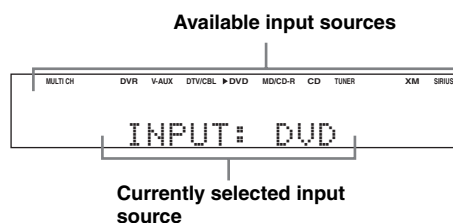

4 Start playback on the selected component or select a broadcast station.

- Refer to the operating instructions for the source component.
- See page 43 for details about FM/AM tuning instructions.
- See page 46 for details about XM Satellite Radio tuning instructions.
- See page 51 for details about SIRIUS Satellite Radio tuning instructions.

5 Rotate VOLUME (or press VOLUME +/-) to adjust the volume to the desired output level.

6 Press PROGRAM $\triangleleft/\triangleright$ repeatedly (or press AMP and then PROG $\triangleleft/\triangleright$ repeatedly) to select the desired sound field program.

The name of the selected sound field program appears in the front panel display.

See page 38 for details about sound field programs.



Notes

- Choose a sound field program based on your listening preference, not merely on the name of the program.
- When you select an input source, this unit automatically selects the last sound field program used with the corresponding input source.
- Sound field programs cannot be selected when the component connected to the MULTI CH INPUT jacks is selected as the input source (see page 34).
- When PCM signals with a sampling frequency higher than 48 kHz are input, this unit is automatically set to the "STRAIGHT" mode (see page 39).
- To display information about the currently selected input source in the OSD, see page 36 for details.

■ A quick guide to contents

| When you want to... | See page |
|--|----------|
| Enjoy high quality sound | 41 |
| Adjust the tonal quality of the front speakers | 41 |
| Adjust the parameters of sound field programs | 40 |
| Enjoy the sources with a wide dynamic range at night | 42 |
| Use headphones | 35 |
| Select a decoder to play back sources with | 39 |
| Automatically set this unit to the standby mode | 37 |

Selecting audio input jacks (AUDIO SELECT)

This unit comes with a variety of input jacks. Use this feature (audio input jack select) to switch between input jacks when more than one input jack is assigned to as the same input source.



- We recommend setting the audio input jack select to “AUTO” in most cases.
- You can adjust the default audio input jack select of this unit by using “AUDIO SELECT” in “OPTION MENU” (see page 71).

Press **ⓅAUDIO SELECT** (or press **ⓅAMP** and then **ⓆAUDIO SEL**) repeatedly to select the desired audio input jack select setting.

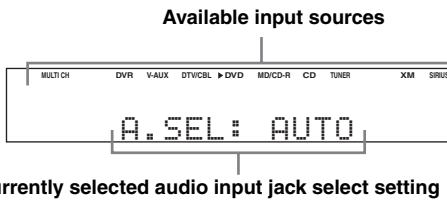

| AUDIO SELECT | Function |
|--------------|---|
| AUTO | Automatically selects input signals in the following order: (1) HDMI (2) Digital signals (3) Analog signals |
| HDMI | Selects only HDMI signals. When HDMI signals are not input, no sound is output. |
| COAX/OPT | Selects only digital signals. When no signals are input, no sound is output. |
| ANALOG | Selects only analog signals. If no analog signals are input, no sound is output. |

Note

This feature is not available when no digital input jacks (OPTICAL, COAXIAL and HDMI) are assigned. In addition, HDMI is not available as an audio input jack select setting when the HDMI IN DVD and HDMI IN DTV/CBL jacks are not used. Use “INPUT ASSIGNMENT” in “INPUT MENU” to reassign the respective input jack (see page 68).

Selecting the MULTI CH INPUT component

Use this feature to select the component connected to the MULTI CH INPUT jacks (see page 18) as the input source.

Press **ⓈINPUT** **◀/▶** repeatedly (or press **ⓅAMP** and then **ⓆMULTI CH IN**) to select **MULTI CH**.

“MULTI CH” appears in the front panel display.



Use “MULTI CH SET” menu in “INPUT MENU” to set the parameters for MULTI CH INPUT (see page 69).

Note

The input signals are amplified and output directly without sound processing. Therefore, you cannot activate sound field programs, the night listening mode, etc. while MULTI CH is selected as the input source.

Displaying the current status of this unit on a video monitor

You can display the operating information of this unit on a video monitor.

1 Turn on the video monitor connected to this unit.

2 Press **DISPLAY**.

The current status screen appears in the OSD.

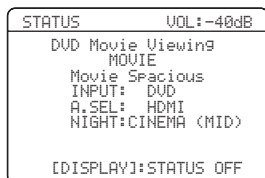

You can select the amount of time that the current status is displayed in the OSD by using the “OSD-AMP” parameter in “OPTION MENU” (see page 70).

Note

The OSD signal is not output at the DVR VIDEO OUT jacks and will not be recorded.

Using your headphones

Connect a pair of headphones with a stereo analog audio cable plug to the PHONES jack on the front panel.

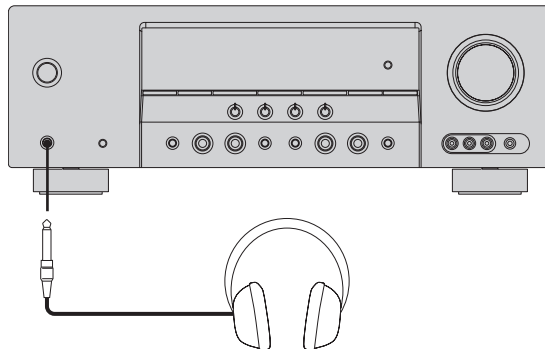

When you select a sound field program, SILENT CINEMA mode is automatically activated (see page 39).

Notes

- When you connect headphones, no signals are output at the speaker terminals.
- All Dolby Digital and DTS audio signals are mixed down to the left and right headphone channels.

Muting the audio output

Press **MUTE** to mute the audio output. Press **MUTE** again to resume the audio output.



- You can also rotate **VOLUME** or press **VOLUME +/-** to resume the audio output.
- You can adjust the muting level by using the “MUTE TYPE” parameter in “SOUND MENU” (see page 66).
- The MUTE indicator flashes in the front panel display when the audio output is muted and disappears from the front panel display when the audio output is resumed.

Playing video sources in the background of an audio source

You can combine a video image from a video source with sound from an audio source. For example, you can enjoy listening to classical music while viewing beautiful scenery from the video source on the video monitor.

Press the input selector buttons (4) control to select a video source and then an audio source.

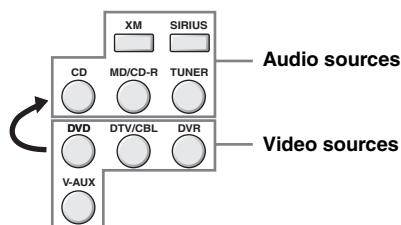

- You can also select “MULTI CH” as the audio source (see page 34). Press **5 AMP** and then press **15 MULTI CH IN**.
- Set the “BGV” parameter in the “MULTI CH SET” menu to the desired setting to select the default background video input source of the MULTI CH INPUT sources (see page 69).

Displaying the input source information

You can display the format, sampling frequency, channel, bit rate and flag data of the current input signal.

- Press **5 AMP** and then **20 MENU**.
The top “SET MENU” display appears in the OSD.

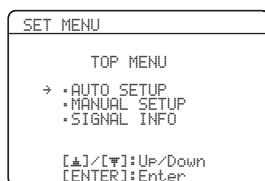

- Press **8 ∇** repeatedly to select “SIGNAL INFO” and then press **8 ENTER**.
The audio information about the input source appears in the OSD.

- Press **8 ◀/▶** to toggle between the audio and video information displays.

- Press **20 MENU** again to exit from “SET MENU”.

Audio information

| Information | Descriptions |
|-------------|--|
| FORMAT | Signal format. When this unit cannot detect a digital signal, it automatically switches to analog input. |
| SAMPLING | The number of samples per second taken from a continuous signal to make a discrete signal. |
| CHANNEL | The number of source channels in the input signal (front/surround/LFE). For example, a multi-channel soundtrack with 3 front channels, 2 surround channels and LFE, is displayed as “3/2/0.1”. |
| BITRATE | The number of bits passing a given point per second. |
| FLAG | Flag data encoded in DTS, Dolby Digital, or PCM signals that cue this unit to automatically switch decoders. |

Note

“—” appears when this unit cannot display the corresponding information.

Video information

| Information | Descriptions |
|--|---|
| HDMI SIGNAL | Type of the source video signals and the video signals output at the HDMI OUT jack of this unit. |
| HDMI RES. | Resolution of the HDMI signals input or output at the HDMI IN/OUT jacks of this unit. |
| HDMI ERROR (Only when error is detected) | Error message for HDMI sources or connected HDMI devices. See “HDMI error and message” for details. |

Note

“—” appears when this unit cannot display the corresponding information.

HDMI error and message

| Message | Cause |
|-------------|--|
| DEVICE OVER | The number of the connected HDMI components is over the limit. |
| HDCP ERROR | HDCP authentication failed. |
| OUT OF RES. | The connected monitor is not compatible with the resolution of the input video signal. |

Using the sleep timer

Use this feature to automatically set this unit to the standby mode after a certain amount of time.

Press **ⓂAMP** and then press **ⓂSLEEP** repeatedly to set the amount of time.

Each time you press **ⓂSLEEP**, the front panel display changes as shown below.



The SLEEP indicator flashes while you are switching the amount of time for the sleep timer. Once the sleep timer is set, the SLEEP indicator lights up in the front panel display, and the display returns to the selected sound field program.



- To cancel the sleep timer, press **ⓂAMP** and then press **ⓂSLEEP** repeatedly until “SLEEP OFF” appears in the front panel display.
- The sleep timer setting can also be canceled by pressing **ⓂSTANDBY/ON** (or **ⓂSTANDBY**) to set this unit to the standby mode.

Sound field programs

This unit is equipped with a variety of precise digital decoders that allow you to enjoy multi-channel playback from almost any stereo or multi-channel sound source.

Press **L PROGRAM** $\triangleleft/\triangleright$ (or press **5 AMP** and then press **12 PROG** $\triangleleft/\triangleright$ repeatedly).

The name of the selected sound field program appears in the front panel display.

Notes

- When you select an input source, this unit automatically selects the last sound field program used with the corresponding input source.
- Sound field programs cannot be selected when the component connected to the MULTI CH INPUT jacks is selected as the input source (see page 34).
- When PCM signals with a sampling frequency higher than 48 kHz are input, this unit is automatically set to the “STRAIGHT” mode (see page 39).



Choose a sound field program based on your listening preference, not merely on the name of the program itself.

Sound field program descriptions

| Category | Program | Features |
|----------------|------------------------------|---|
| MUSIC | Pop/Rock | CINEMA DSP processing. This program presents an image of pop, rock, or jazz live concert. The sound field reproduces the spaciousness of a massive pavilion with an emphasis on the vividness of vocals on the stage and solo instruments and the beats of rhythm instruments. |
| | Hall | CINEMA DSP processing. This sound field is suitable for classic and orchestral music. The program uses data collected in a large concert hall in Munich. You can enjoy delicate and beautiful reverberation and a majestic atmosphere. |
| | Jazz | CINEMA DSP processing. The sound field is suitable for jazz and fusion music. It uses data collected in a famous jazz club in New York. You can enjoy clear reverberation. |
| ENTERTAINMENT | Game | CINEMA DSP processing. You can enjoy dynamic and thrilling sound effects as you play games. The program lets you feel the depth and three-dimensional surrounding sounds of the field where you are playing, and offers cinema-like surrounding sound effects for the scenes of movies. |
| | TV Sports | CINEMA DSP processing. You can enjoy sports relays broadcast in stereo and variety shows with a live sound environment. For sports relays, the voices of commentators and announcers come clearly from the center; the cheers and atmosphere in the stadium spread around within a comfortable range, and you can feel like as if you are in the stadium. |
| MOVIE | Movie Spacious | CINEMA DSP processing. The sound field is suitable for movies with an emphasis on spectacular sound effects, and is a perfect fit with a wide screen. The program reproduces a wide dynamic range from minimum sound effects to powerful sounds. |
| | Movie Dramatic | CINEMA DSP processing. This sound field is also suitable for movies with an emphasis on three-dimensional sound effects. It restrains reverberation to an moderate extent, but reproduces sound effects and background music in a soft, three-dimensional manner with clarity and center orientation of voices as pivots. |
| STEREO | 2ch Stereo | Downmixes multi-channel sources to 2 channel or plays back 2-channel sources as they are. |
| | 5ch Stereo | CINEMA DSP processing. Using this program increases the listening position range. This is a sound field suitable for background music at parties. |
| MUSIC ENHANCER | 2ch Enhancer 5ch Enhancer | Select these programs to play back compression artifacts (such as the MP3 format) in 2-channel or 5-channel stereo. This program enhances your listening experience by regenerating the missing harmonics in a compression artifact. |

Note

The sound field programs of this unit are recreations of real-world acoustic environments made from precise measurements taken in the actual concert hall, music venue, movie theater, etc. Thus, you may notice variations in the strength of the reflections coming from each direction.

■ Enjoying 2-channel sources using the standard decoders

Signals input from 2-channel sources can also be played back on multi-channels.

Press **⑤AMP** and then press **⑳SUR. DECODE** repeatedly to select a decoder.

You can select from the following decoders depending on the type of source you are playing and your personal preference.

| Decoder | Functions |
|-------------|---|
| Pro Logic | Dolby Pro Logic processing for any sources |
| PLII Movie | Dolby Pro Logic II processing for movie sources |
| PLII Music | Dolby Pro Logic II processing for music sources |
| PLII Game | Dolby Pro Logic II processing for game sources |
| Neural Sur. | Neural Surround processing for any sources |

■ Using sound field programs without surround speakers (Virtual CINEMA DSP)

Virtual CINEMA DSP allows you to enjoy the CINEMA DSP programs without surround speakers by creating virtual speakers.

If you set “SUR. L/R SP” to “NONE” (see page 64), Virtual CINEMA DSP is automatically activated whenever you select a CINEMA DSP program (see page 38).

Note

Virtual CINEMA DSP will not be activated even when “SUR. L/R SP” is set to “NONE” (see page 64) in the following cases:

- when “5ch Stereo” (see page 38) is selected.
- when headphones are connected to the PHONES jack.

■ Enjoying multi-channel sources and sound field programs with headphones (SILENT CINEMA)

SILENT CINEMA allows you to enjoy multi-channel music or movie sound, including Dolby Digital and DTS sources, through ordinary headphones. SILENT CINEMA is automatically activated whenever you connect headphones to the PHONES jack while listening to CINEMA DSP sound field programs (except for 5ch Stereo) (see page 38). When activated, the SILENT CINEMA indicator lights up in the front panel display.

■ Enjoying unprocessed input sources (Straight decoding mode)

When this unit is in the “STRAIGHT” mode, multi-channel sources are decoded straight into the appropriate channels without any additional effect processing. 2-channel stereo sources are output from only the front left and right speakers.

Press **ⓂSTRAIGHT** (or press **⑤AMP** and then press **ⓅSTRAIGHT**) to select “STRAIGHT”.

To deactivate the “STRAIGHT” mode, press **ⓂSTRAIGHT** (or press **⑤AMP** and then **ⓅSTRAIGHT**) again so that “STRAIGHT” disappears from the front panel display.

■ Editing sound fields parameters

You can enjoy good quality sound with the factory default parameters. Although you do not have to change the initial settings, you can change some of the parameters to better suit the input source or your listening room.

- 1 While listening to a source, press **Ⓢ**AMP and then press **Ⓜ**PARAMETER.
- 2 Press **Ⓢ**△ / ▽ to select the desired parameter you want to change.
- 3 Press **Ⓢ**◀ / ▶ to change the parameter value.

Note

You cannot change parameter values when “MEMORY GUARD” in “OPTION MENU” is set to “ON” (see page 70).



Initial settings are indicated in bold under each parameter.

For Pop/Rock, Hall, Jazz, Game, TV Sports, Movie Spacious and Movie Dramatic:

DSP level **DSP LEVEL**

Function: Adjusts the effect level.

Choices: MIN, **MID**, MAX

For 2ch Enhancer and 5ch Enhancer:

Effect level **EFFECT LEVEL**

Function: Adjusts the effect level.

Choices: LOW, **HIGH**

For Pro Logic II Music:

Panorama **PANORAMA**

Function: Sends stereo signals to the surround speakers as well as the front speakers for a wraparound effect.

Choices: **OFF**, ON

Dimension **DIMENSION**

Function: Gradually adjusts the sound field either towards the front or towards the rear.

Control range: -3 (towards the rear) to +3 (towards the front), initial setting is STD (standard).

Center width **CT WIDTH**

Function: Adjusts the center image from all three front speakers to varying degrees. A larger value adjusts the center image towards the front left and right speakers.

Control range: 0 (center channel sound is output only from center speaker) to 7 (center channel sound is output only from front left and right speakers), initial setting is 3.

Using audio features

Enjoying high quality sound

Use the DIRECT mode to enjoy the high quality sounds of the selected source. When the DIRECT mode is activated, this unit plays back the selected source with the least circuitry.

Press **ⓃDIRECT** (or press **ⓂAMP** and then **ⓃDIRECT**) to select “DIRECT”.

Notes

- “TONE CONTROL” and “SOUND MENU” (see page 63) settings (except for speaker level settings) are not effective.
- The front panel display automatically dims.



While DIRECT mode is activated, the front panel display turns on momentarily when an operation is performed.

Adjusting the tonal quality

Use this feature to adjust the balance of bass and treble for the front left and right speaker channels.



Speaker and headphone adjustments are stored independently.

1 Press **ⓃTONE CONTROL** repeatedly to select the high-frequency response (TREBLE) or the low-frequency response (BASS).

2 Press **ⓂPROGRAM** **</>** repeatedly to adjust the high-frequency response (TREBLE) or the low-frequency response (BASS).

Notes

- If you increase or decrease the high-frequency or the low-frequency sound to an extreme level, the tonal quality of the surround speakers may not match.
- TONE CONTROL is not effective when this unit is in the DIRECT mode, or when MULTI CH is selected as the input source.

Adjusting the speaker level

You can adjust the output level of each speaker while listening to a music source. This is also possible when playing sources input at the MULTI CH INPUT jacks.

Note

This operation will override the level adjustments made in “AUTO SETUP” (see page 24) and “SP LEVEL” (see page 65).

1 Press **ⓂAMP** and then press **ⓃLEVEL** on the remote control and then **ⓂΔ/∇** to select the speaker you want to adjust.

| Display | Adjusted speaker |
|---------|------------------------|
| FRONT L | Front left speaker |
| FRONT R | Front right speaker |
| CENTER | Center speaker |
| SWFR | Subwoofer |
| SUR. L | Surround left speaker |
| SUR. R | Surround right speaker |



- The available speaker channels differ depending on the setting of the speakers.
- When the video monitor is turned on, the “SPEAKER LEVEL” adjustment menu appears in the video monitor.

2 Press **Ⓜ</>** to adjust the speaker output level.

- Press **Ⓜ>** to increase the value.
- Press **Ⓜ<** to decrease the value.
- Control range: -10 dB to +10 dB

3 Press **ⓃLEVEL** to turn off the speaker level adjustment display.

Selecting the night listening mode

The night listening modes are designed to improve listenability at lower volumes or at night.

- 1 Press **Ⓜ** **AMP** and then **Ⓜ** **NIGHT** repeatedly to select “NIGHT:CINEMA” or “NIGHT:MUSIC”.

Choices: NIGHT:CINEMA, NIGHT:MUSIC, OFF

- Select “NIGHT:CINEMA” when watching films to reduce the dynamic range of film soundtracks and make dialog easier to hear at lower volumes.
- Select “NIGHT:MUSIC” when listening to music sources to preserve ease-of-listening for all sounds.
- Select “OFF” if you do not want to use this feature.



When a night listening mode is selected, the NIGHT indicator lights up in the front panel display.

- 2 Press **Ⓜ** **</>** to adjust the effect level while “NIGHT:CINEMA” or “NIGHT:MUSIC” is displayed in the front panel display.

Effect.Lvl: MID

Choices: MIN, **MID**, MAX

- Select “MIN” for minimum compression.
- Select “MID” for standard compression.
- Select “MAX” for maximum compression.



“NIGHT:CINEMA” and “NIGHT:MUSIC” adjustments are stored independently.

Notes

- You cannot use the night listening modes in the following cases:
 - when the DIRECT mode (see page 41) is selected.
 - when the component connected to the MULTI CH INPUT jacks is selected as the input source (see page 34).
 - when headphones are connected to the PHONES jack.
- The night listening modes may vary in effectiveness depending on the input source and surround sound settings you use.

FM/AM tuning

There are 2 tuning methods: automatic and manual. Automatic tuning is effective when station signals are strong and there is no interference. If the signal from the station you want to select is weak, tune into it manually. You can also use the automatic and manual preset tuning features to store up to 40 stations.

Automatic tuning

Automatic tuning is effective when station signals are strong and there is no interference.

- 1 Press **Ⓢ**INPUT $\triangleleft/\triangleright$ repeatedly so that “TUNER” is displayed in the front panel display.
- 2 Press **Ⓢ**BAND to select the reception band (FM or AM).
- 3 Press **Ⓢ**TUNING AUTO/MAN'L so that the AUTO indicator lights up in the front panel display.

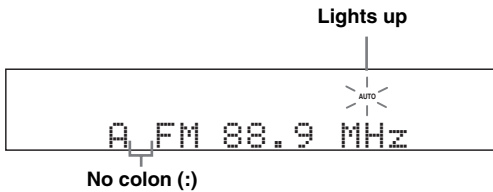

If a colon (:) appears in the front panel display, automatic tuning is not possible. Press **Ⓢ**PRESET/TUNING to turn the colon (:) off.

- 4 Press **Ⓢ**PRESET/TUNING/CH $\triangleleft/\triangleright$ once to begin automatic tuning.
When this unit is tuned into a station, the TUNED indicator lights up and the frequency of the received station is shown in the front panel display.

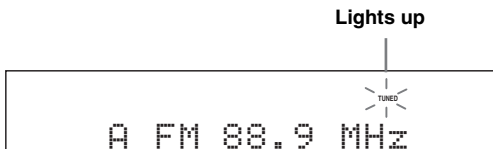

Manual tuning

If the signal received from the station you want to select is weak, tune into it manually.

Note

Manually tuning into an FM station automatically switches the tuner to monaural reception to increase the signal quality.

- 1 Press **Ⓢ**INPUT $\triangleleft/\triangleright$ repeatedly so that “TUNER” is displayed in the front panel display.
- 2 Press **Ⓢ**BAND to select the reception band (FM or AM).
- 3 Press **Ⓢ**TUNING AUTO/MAN'L so that the AUTO indicator disappears from the front panel display.

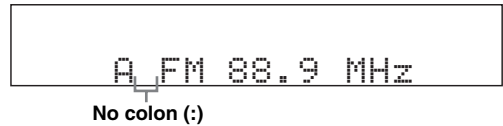

If a colon (:) appears in the front panel display, manual tuning is not possible. Press **Ⓢ**PRESET/TUNING to turn the colon (:) off.

- 4 Press **Ⓢ**PRESET/TUNING/CH $\triangleleft/\triangleright$ to tune into the desired station manually.



Hold down the button to continue searching.

Automatic preset tuning

You can use the automatic preset tuning feature to store FM stations with strong signals up to 40 (A1 to E8: 8 preset station numbers in each of the 5 preset station groups) of those stations in order. You can then recall any preset station easily by selecting the preset station number.

- 1 Press **ⓈINPUT** $\triangleleft / \triangleright$ repeatedly so that “TUNER” is displayed in the front panel display.
- 2 Press **ⓈBAND** to select “FM” as the reception band.
- 3 Press and hold **ⓈMEMORY** for more than 3 seconds.
The preset station number as well as the MEMORY and AUTO indicators flashes. After approximately 5 seconds, automatic presetting starts from the current frequency and proceeds toward the higher frequencies.

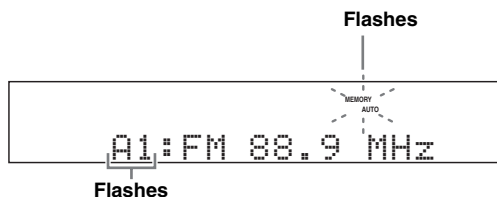

When automatic preset tuning is completed, the front panel display shows the frequency of the last preset station.



You can select the preset station group and the preset station number where the first received station will be stored by pressing **ⓈA/B/C/D/E** and then **ⓈPRESET/TUNING/CH** $\triangleleft / \triangleright$.

Notes

- Any stored station data existing under a preset station number is cleared when you store a new station under the same preset station number.
- Only FM stations with sufficient signal strength are stored automatically by automatic preset tuning. If the station you want to store is weak in signal strength, tune into it manually and store it as described in “Manual preset tuning” on this page.

Manual preset tuning

You can also store up to 40 stations (A1 to E8: 8 preset station numbers in each of the 5 preset station groups) manually.

- 1 Tune into a station automatically or manually.
See page 43 for tuning instructions.
- 2 Press **ⓈMEMORY**.
The MEMORY indicator flashes in the front panel display for approximately 30 seconds.
- 3 Press **ⓈA/B/C/D/E** and **ⓈPRESET/TUNING/CH** $\triangleleft / \triangleright$ repeatedly to select a preset station group (A1 to E8) while the MEMORY indicator is flashing.
Check that the colon (:) appears in the front panel display.

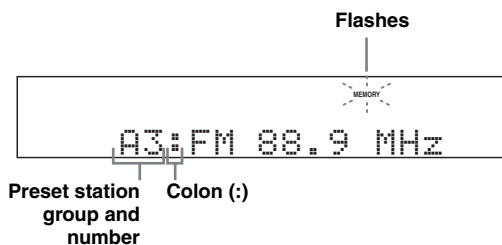

- 4 Press **ⓈMEMORY** while the MEMORY indicator is flashing.
The station band and frequency appear in the front panel display with the preset station group and number you have selected.

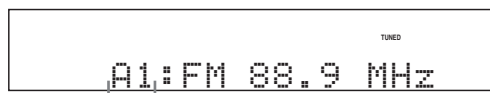

The displayed station has been stored as A1.

Notes

- Any stored station data existing under a preset station number is cleared when you store a new station under the same preset station number.
- The reception mode (stereo or monaural) is stored along with the station frequency.

Selecting preset stations

You can tune into any desired station simply by selecting the preset station group and number under which it was stored.



When performing this operation with the remote control, press **TUNER** to select "TUNER" as the input source.

- 1 Press **A/B/C/D/E** (or **A-E/CAT.** $\triangleleft/\triangleright$) repeatedly to select the desired preset station group (A to E).

The preset station group letter appears in the front panel display and changes each time you press the button.

- 2 Press **PRESET/TUNING/CH** $\triangleleft/\triangleright$ (or **PRESET/CH** \triangle/∇) to select the desired preset station number (1 to 8).

The preset station group and number appear in the front panel display along with the station band and frequency.



You can select the desired preset station number (1 to 8) directly by pressing the numeric buttons on the remote control.

Exchanging preset station

You can exchange the assignments of two preset stations with each other. The example below describes the procedure to exchange preset station "E1" with "A5".

- 1 Select preset station "E1" using **A/B/C/D/E** and **PRESET/TUNING/CH** $\triangleleft/\triangleright$. See "Selecting preset stations" on this page.

- 2 Press and hold **PRESET/TUNING** for more than 3 seconds.

"E1" and the MEMORY indicator flash in the front panel display.

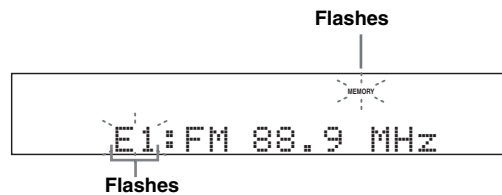

- 3 Select preset station "A5" using **A/B/C/D/E** and **PRESET/TUNING/CH** $\triangleleft/\triangleright$.

"A5" and the MEMORY indicator flash in the front panel display.

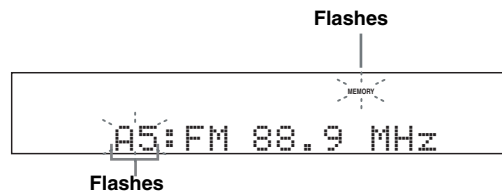

- 4 Press **PRESET/TUNING** again.

"EXCHANGE E1-A5" appears in the front panel display and the assignments of the two preset stations are exchanged.

XM Satellite Radio tuning

XM Radio offers an extraordinary variety of commercial-free music, plus the best in premier sports, news, talk radio, stand-up comedy, children's and entertainment programming. XM is broadcast in superior digital audio quality from coast to coast. From rock to reggae, from classical to hip hop, XM has something for every music fan.

XM Satellite Radio online information

For U.S. customers: <http://www.xmradio.com/>

For Canadian customers: <http://www.xmradio.ca/>

Note

The XM Satellite Radio service is only available in the 48 contiguous United States (not available in Alaska and Hawaii) and Canada.

XM READY legal disclaimer

XM monthly service subscription sold separately. XM Mini-Tuner and Home Dock required (each sold separately) to receive XM service. It is prohibited to copy, decompile, disassemble, reverse engineer, hack, manipulate or otherwise make available any technology or software incorporated in receivers compatible with the XM Satellite Radio System. Installation costs and other fees and taxes, including a one-time activation fee may apply. All fees and programming subject to change. Channels with frequent explicit language are indicated with an XL. Channel blocking is available for XM radio receivers by calling 1-800-XM-RADIO (US residents) and 1-877-GET-XMSR (Canadian residents). For a full listing of the XM commercial-free channels and advertising-supported channels, visit lineup.xmradio.com (US residents) or xmradio.ca (Canadian residents). Subscriptions subject to Customer Agreement available at www.xmradio.com (US residents) and www.xmradio.ca (Canadian residents). Only available in the 48 contiguous United States and Canada. ©2008 XM Satellite Radio Inc. All rights reserved. All other trademarks are the property of their respective owners.

Connecting the XM Mini-Tuner Dock

Connect XM Mini-Tuner and XM Mini-Tuner Dock (sold separately) to the XM jack on the rear panel of this unit. For details, see the operating instructions provided with XM Mini-Tuner Dock.

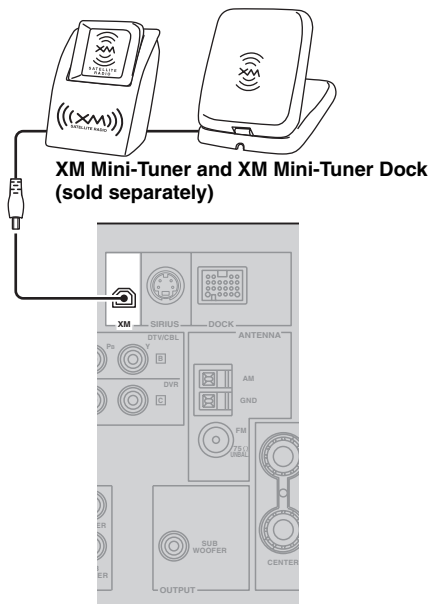

To ensure optimal reception of the XM Satellite Radio signals, the XM Mini-Tuner Dock must be placed at or near a southerly facing window with no obstacles in the path to the sky. You can mount it indoors or outdoors. Use the "XM RADIO SET" screen in the video monitor (see page 72) to check the antenna reception level and adjust the orientation of the antenna.

Note

If "CHECK ANTENNA" or "CHECK XM TUNER" appears in the front panel display, the connection and setting of the antenna, Home Dock, or XM Mini-Tuner may not correct (see page 82).

Activating XM Satellite Radio

Once you have installed the XM Mini-Tuner Dock, inserted the XM Mini-Tuner, connected the XM Mini-Tuner Dock to your XM Ready® home audio system, and installed the antenna, you are ready to subscribe and begin receiving XM programming. There are three places to find your eight character XM Radio ID: on the XM Mini-Tuner, on the XM Mini-Tuner package, and on XM Channel 0. Record the Radio ID in the following eight squares for reference.



Note

The XM Radio ID does not use the letters “I”, “O”, “S” or “F”. Activate your XM Satellite Radio service in the U.S. online at <http://www.xmradio.com/> or call 1-800-XM-RADIO (1-800-967-2346). You will need a major credit card. XM will send a signal from the satellites to activate the full channel lineup. Activation normally takes 10 to 15 minutes, but during peak busy periods you may need to keep your XM Ready home audio system on for up to an hour. When you can access the full channel lineup on your XM Ready home audio system you are done. For more information or to subscribe in Canada, visit XM on the Web at www.xmradio.ca or call XM’s Listener Care at 1-877-GET-XMSR (1-877-438-9677).

Basic XM Satellite Radio operations

1 Press **⊙** **INPUT** **</>** repeatedly (or press **Ⓝ** **XM**) to select “XM” as the input source.

The cursor on the left of the XM indicator lights up in the front panel display and the XM Satellite Radio information (such as channel number, channel name, category, artist name, or song title) for the currently selected channel appears in the front panel display.



When you select “XM” as the input source, this unit automatically recalls the previously selected channel.

Notes

- The XM Satellite Radio signals cannot be output at the AUDIO OUT (REC) jacks.
- If a status message or an error message appears in the front panel display or in the OSD, see the “XM Satellite Radio” section in “Troubleshooting” on page 78 for appropriate remedies.

2 Search for a channel by using one of the XM Satellite Radio search modes.

- To select a channel from the all channel list, see “All Channel Search mode” on page 48.
- To select a channel by category, see “Category Search mode” on page 48.
- To select a channel from the preset channels, see “Preset Search mode” on page 48.
- To select the desired channel directly by entering the channel number, see “Direct Number Access mode” on page 48.



- You can use the Neural Surround decoder to enjoy the XM HD surround sound content of the XM Satellite Radio broadcasts in multi-channels (see page 39).
- You can set the XM Satellite Radio preset channels (see page 49).
- You can display the XM Satellite Radio information in the front panel display or in the OSD (see page 50).



Before performing operations, press **Ⓜ**XM to select “XM” as the input source.

■ All Channel Search mode

1 Press **Ⓜ**SEARCH MODE (or **Ⓜ**SRCH MODE) repeatedly to select “ALL CH SEARCH”.

2 Press **Ⓜ**PRESET/TUNING/CH $\triangleleft/\triangleright$ (or **Ⓜ**PRESET/CH \triangle/∇) repeatedly to search for a channel within all channels.



- You can search for a channel quickly by pressing and holding **Ⓜ**PRESET/TUNING/CH $\triangleleft/\triangleright$ (or **Ⓜ**PRESET/CH \triangle/∇).
- To display the XM Radio ID number displayed in the front panel display, select channel “0”.

■ Category Search mode

1 Press **Ⓜ**SEARCH MODE (or **Ⓜ**SRCH MODE) repeatedly to select “CAT SEARCH”.

2 Press **Ⓜ**CATEGORY (or **Ⓜ**A-E/CAT. $\triangleleft/\triangleright$) repeatedly to change the channel category.

3 Press **Ⓜ**PRESET/TUNING/CH $\triangleleft/\triangleright$ (or **Ⓜ**PRESET/CH \triangle/∇) repeatedly to search for a channel within the selected channel category.



You can search for a channel quickly by pressing and holding **Ⓜ**PRESET/TUNING/CH $\triangleleft/\triangleright$ (or **Ⓜ**PRESET/CH \triangle/∇).

■ Preset Search mode

Prior to selecting a preset channel in the Preset Search mode, you must preset XM Satellite Radio channels. For details, see “Setting XM Satellite Radio preset channels” on page 49.



All preset channels (A1 to E8) recalls “001 Preview” by the initial factory setting.

1 Press **Ⓜ**SEARCH MODE (or **Ⓜ**SRCH MODE) repeatedly to select “PRESET SEARCH”.

2 Press **Ⓜ**CATEGORY (or **Ⓜ**A-E/CAT. $\triangleleft/\triangleright$) repeatedly to change the preset channel group (A to E).

3 Press **Ⓜ**PRESET/TUNING/CH $\triangleleft/\triangleright$ (or **Ⓜ**PRESET/CH \triangle/∇) repeatedly to change the preset channel number (1 to 8).



You can also select the preset channel number directly by pressing the numeric buttons (1 to 8) on the remote control.

■ Direct Number Access mode

1 Press **Ⓜ**SRCH MODE repeatedly to select “ALL CH SEARCH” or “CAT SEARCH”.

2 Press the numeric buttons (**Ⓜ**) to enter the desired three-digit channel number.

For example, to enter the number 123, press the numeric buttons as shown below.



The display changes as follows.

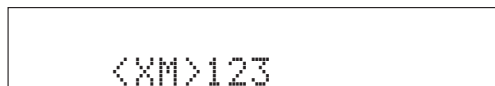
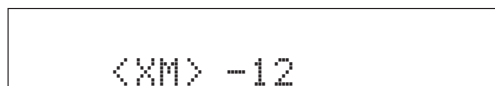
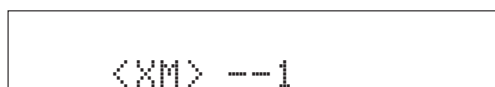

- To enter a one-digit or two-digit channel number, press the numeric buttons (**Ⓜ**) and then press **Ⓜ**ENT to confirm the input number. Instead of pressing **Ⓜ**ENT to tune into the channel immediately, you can wait a few seconds until this unit confirms the entered channel number.
- Pressing a button other than the numeric buttons (**Ⓜ**) or **Ⓜ**ENT cancels the Direct Number Access mode procedure.

Setting XM Satellite Radio preset channels

You can use this feature to store up to 40 XM Satellite Radio channels (A1 to E8: 8 preset channel numbers in each of the 5 preset channel groups). You can then recall any preset channel easily by selecting the preset channel group and number as described in “Preset Search mode” on page 48.

1 Search for a channel you want to set as a preset channel by using one of the XM Satellite Radio search modes.

See “Basic XM Satellite Radio operations” on page 47 for details.

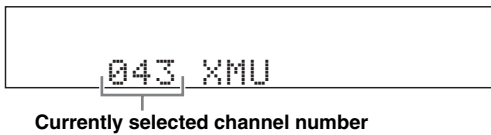

2 Press **MEMORY** (or **MEMORY**).

The MEMORY indicator flashes in the front panel display for approximately 30 seconds.

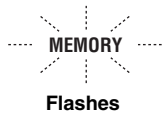

Note

You must proceed to and carry out steps 3 through 5 while the MEMORY indicator is flashing in the front panel display.

3 Press **CATEGORY** (or **A-E/CAT.** $\triangleleft/\triangleright$) repeatedly to select a preset channel group (A to E) while the MEMORY indicator is flashing.

The preset channel group letter appears in the front panel display.

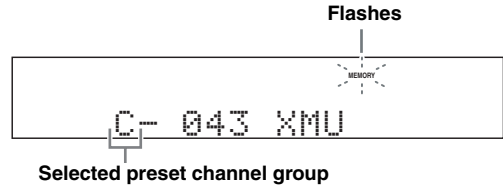

4 Press **PRESET/TUNING/CH** $\triangleleft/\triangleright$ (or **PRESET/CH** \triangle/∇) repeatedly to select a preset channel number (1 to 8) while the MEMORY indicator is flashing.

The preset channel number appears in the front panel display.

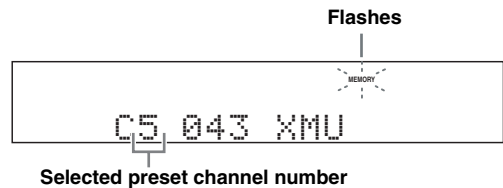

5 Press **MEMORY** (or **MEMORY**) to set the selected XM Satellite Radio channel as a preset channel while the MEMORY indicator is flashing.

A colon (:) appears next to the preset channel number for confirmation, and the MEMORY indicator turns off in the front panel display.

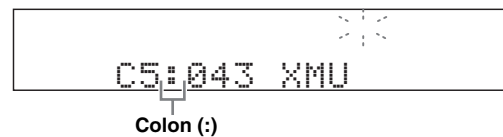

Note

Once you set a new preset channel, the one previously stored in the same preset channel group and number is cleared.

Displaying the XM Satellite Radio information

You can display the XM Satellite Radio information (such as channel number, channel name, category, artist name, or song title) for the currently selected channel in the front panel display or in the OSD.

Note

If a status message or an error message appears in the front panel display or in the OSD, see the “XM Satellite Radio” section in “Troubleshooting” on page 82 for appropriate remedies.

■ Displaying the XM Satellite Radio information in the front panel display

Press **Ⓜ**INFO (or **Ⓜ**INFO) repeatedly to toggle between the following XM Satellite Radio information display modes.

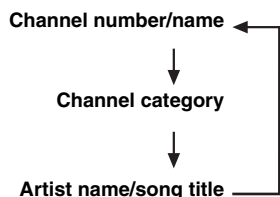

When the channel number / name is displayed:

[043] XMU

When the channel category is displayed:

<CAT>ROCK

When the artist name / song title is displayed:

Coldplay / Clo



- The front panel display can indicate up to 14 alphanumeric characters at once. You can set whether to display the XM Satellite Radio information in the front panel display in a continuous manner or by 14 alphanumeric characters at once by using the “FL SCROLL” parameter in “OPTION MENU” (see page 70).
- If the XM Satellite Radio information contains a character that cannot be recognized by this unit, the character will be displayed with a space.
- To hold the current XM Radio information, press **Ⓜ**ENTER on the remote control while it is being displayed. Press **Ⓜ**ENTER again to release the held information.
- When the antenna of the XM Mini-Tuner Dock cannot receive the signals, “NO SIGNAL” appears in the front panel display.

■ Displaying the XM Satellite Radio information in the OSD

Press **Ⓜ**DISPLAY.

The following screen is displayed in the OSD.



[1] Search mode (see page 48)

[2] Channel category

[3] Song title

[4] Channel number/name

[5] Artist name



- To turn off the OSD, press **Ⓜ**DISPLAY again.
- XM status messages also appear in the OSD.
- You can select the amount of time the XM Satellite Radio information is displayed in the OSD by using the “OSD-SOURCE” parameter in “OPTION MENU” (see page 70).
- To hold the XM Satellite Radio information, press **Ⓜ**ENTER on the remote control while it is being displayed in the OSD. The HOLD indicator flashes in the front panel display while you are holding the XM information. Press **Ⓜ**ENTER again or change the XM Satellite Radio channel to release the held information.

SIRIUS Satellite Radio™ tuning

SIRIUS Satellite Radio provides over 130 channels of exclusive entertainment and 100% commercial-free music. Only SIRIUS has more than 65 original music channels, from today's hits to R&B, oldies and classical masterpieces. From authentic country and real bluegrass to cool jazz, hot latin, reggae, rock and many more. Best of all, it's all 100% commercial-free.

SIRIUS also has more than 55 channels of world-class sports, news and entertainment. Included as part of your subscription, you get up to 16 NFL games a week, up to 40 NBA games a week and up to 40 NHL games a week. (Games are broadcast during their respective seasons.)

Coupled with great sports news from ESPN, the SIRIUS sports offering is unrivaled. And don't forget a host of other great news and entertainment, like NPR, CNBC, Fox News, Radio Disney and E! Entertainment Radio. For more information, visit <http://www.sirius.com/>.

SIRIUS Satellite Radio legal disclaimer

SIRIUS is available in the U.S. for subscribers with addresses in the continental U.S. and is available in Canada for subscribers with a Canadian address. To get SIRIUS Satellite Radio, a subscription and compatible tuner and antenna are required (sold separately).

Visit sirius.com for the most complete and up-to-date channel lineup and information.

"SIRIUS" and the SIRIUS dog logo and related marks are trademarks of SIRIUS Satellite Radio Inc.

Connecting the SiriusConnect™ tuner

Connect the SiriusConnect tuner (sold separately) to the SIRIUS jack on the rear panel of this unit. For details, see the operating instructions provided with the SiriusConnect tuner.

SiriusConnect tuner and the antenna
(sold separately)

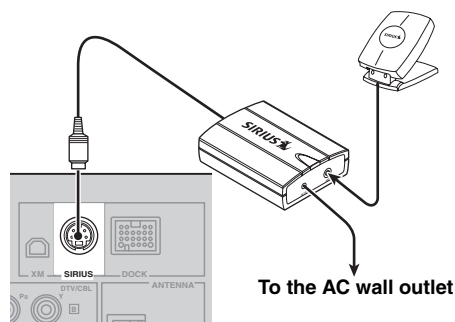

- To ensure optimal reception of the SIRIUS Satellite Radio signals, the antenna of the SiriusConnect tuner must be placed at or near a window with no obstacles in the path to the sky. The orientation of the antenna for the best reception differs depending on the area. Refer to the instruction manuals supplied with the SiriusConnect tuner for the installation of the antenna. You can mount it indoors or outdoors.
- Use the "ANTENNA INFO" information in the front panel or "SIRIUS Information" screen in the video monitor (see page 56) to check the antenna reception level and adjust the orientation of the antenna.
- You will need to connect the SiriusConnect tuner to the AC wall outlet.

Notes

- If "CHECK SR TUNER" or "ANTENNA ERROR" appears in the front panel display, the connection of the SiriusConnect tuner or antenna is incorrect. In such cases, check the connection of the SiriusConnect tuner and the antenna (see page 83).
- If "NOT SUPPORTED" appears in the front panel display, this unit does not support the connected SiriusConnect tuner.

Activating SIRIUS Satellite Radio™ subscription

Before using the SIRIUS Satellite feature, you need to activate your SIRIUS Satellite Radio subscription. To activate the subscription, you need the Sirius ID, which is uniquely assigned to the SiriusConnect tuner. Sirius ID is 12-digit number and it appears on the package of the SiriusConnect tuner, on the label of the SiriusConnect tuner and when you tune into the SIRIUS Satellite Radio Channel “0” (see below).

■ Displaying the Sirius ID of your SiriusConnect tuner

1 Press **ⓂSIRIUS**.

2 Press **Ⓜ0** and then **ⓂENT** to display the Sirius ID of your SiriusConnect tuner.

“000 Sirius IDxxxxxxxxxx” (“xxxxxxxxxx” indicates the 12-digit Sirius ID of your SiriusConnect tuner) appears in the front panel display.



To scroll the message again, press **ⓂINFO** (or **ⓂINFO**).

Write the Sirius ID below.

ID: _____

SIRIUS Satellite Radio online information

Contact for activation

URL: <https://activate.siriusradio.com/>

Phone: 1-888-539-SIRIUS (1-888-539-7474)

Basic SIRIUS Satellite Radio™ operations

1 Press **ⓂINPUT** **◀/▶** (or press **ⓂSIRIUS**) to select “SIRIUS” as the input source.

The cursor on the left of the SIRIUS indicator lights up in the front panel display and the SIRIUS Satellite Radio information (such as channel number, channel name, category, artist name, or song title) for the currently selected channel appears in the front panel display.

Lights up



When you select “SIRIUS” as the input source, this unit automatically recalls the previously selected channel.

Notes

- The SIRIUS Satellite Radio signals cannot be output at the AUDIO OUT (REC) jacks.
- When you have not activated your subscription yet, you can only select “184” or “000”.

2 Search for a channel by using one of the SIRIUS Satellite Radio search modes.

- To select a channel from the all channel list, see “All Channel Search mode” on page 53.
- To select a channel by category, see “Category Search mode” on page 53.
- To select a channel from the preset channels, see “Preset Search mode” on page 53.
- To select the desired channel directly by entering the channel number, see “Direct Number Access mode” on page 53.



- You can set the SIRIUS Satellite Radio preset channels (see page 54).
- You can display the SIRIUS Satellite Radio information in the front panel display or in the OSD (see page 56).

Before performing the following operations, press
 ② **SIRIUS**.

■ All Channel Search mode

- 1 Press ⑥ **SEARCH MODE** (or ⑳ **SRCH MODE**) repeatedly to select “ALL CH SEARCH”.
- 2 Press ⑥ **PRESET/TUNING/CH** </> (or ⑧ **PRESET/CH** △ / ▽) repeatedly to search for a channel within all channels.



- You can search for a channel quickly by pressing and holding ⑥ **PRESET/TUNING/CH** </> (or ⑧ **PRESET/CH** △ / ▽).
- You can skip channels to the previous or next category by pressing ① **CATEGORY** (or ⑧ **A-E/CAT.** </>).

■ Category Search mode

- 1 Press ⑥ **SEARCH MODE** (or ⑳ **SRCH MODE**) repeatedly to select “CAT SEARCH”.
- 2 Press ① **CATEGORY** (or ⑧ **A-E/CAT.** </>) repeatedly to change the channel category.
- 3 Press ⑥ **PRESET/TUNING/CH** </> (or ⑧ **PRESET/CH** △ / ▽) repeatedly to search for a channel within the selected channel category.



You can search for a channel quickly by pressing and holding ⑥ **PRESET/TUNING/CH** </> (or ⑧ **PRESET/CH** △ / ▽).

Note

This unit skips the channels when this unit is All Channel Search mode or Category Search mode in the following cases (it is not malfunction of this unit):

- the channel is locked (see page 54).
- the channel is out of service.
- you do not subscribe to the channel.

■ Preset Search mode

Prior to selecting a preset channel in the Preset Search mode, you must preset SIRIUS channels. For details, see “Setting the SIRIUS Satellite Radio™ preset channels” on page 54.

- 1 Press ⑥ **SEARCH MODE** (or ⑳ **SRCH MODE**) repeatedly to select “PRESET SEARCH”.
- 2 Press ① **CATEGORY** (or ⑧ **A-E/CAT.** </>) repeatedly to change the preset channel group (A to E).
- 3 Press ⑥ **PRESET/TUNING/CH** </> (or ⑧ **PRESET/CH** △ / ▽) repeatedly to change the preset channel number (1 to 8).



You can also select the preset channel number directly by pressing the numeric buttons (1 to 8) (⑰).

■ Direct Number Access mode

- 1 Press ⑳ **SRCH MODE** on the remote control repeatedly to select “ALL CH SEARCH” or “CAT SEARCH”.
- 2 Press the numeric buttons (⑰) to enter the desired three-digit channel number.
For example, to enter the number 123, press the numeric buttons (⑰) as shown below.

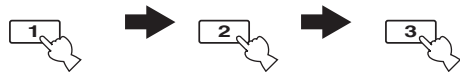

- To display the SIRIUS Radio ID (SID) number displayed in the front panel display, select channel “0”.
- To enter a one-digit or two-digit channel number, press the numeric buttons (⑰) on the remote control and then press ⑳ **ENT** to confirm the input number.
- Instead of pressing ⑳ **ENT** to tune into the channel immediately, you can wait a few seconds until this unit confirms the entered channel number.
- Pressing a button other than the numeric buttons (⑰) or ⑳ **ENT** cancels the Direct Number Access mode procedure.
- If the selected channel is locked, “PIN:___” appears in the front panel display. Enter the four-digit Parental Lock code number by using the numeric buttons (⑰) or press ⑳ **ENT** to cancel.

Before performing the following operations, press **ⓂSIRIUS**.

Setting the SIRIUS Satellite Radio™ preset channels

You can use this feature to store up to 40 SIRIUS Satellite Radio channels (A1 to E8: 8 preset channel numbers in each of the 5 preset channel groups). You can then recall any preset channel easily by selecting the preset channel group and number as described in “Preset Search mode” on page 53.

1 Search for a channel you want to set as a preset channel by using one of the SIRIUS Satellite Radio search modes.

See “Basic SIRIUS Satellite Radio™ operations” on page 52 for details.



Currently selected channel number

2 Press **ⓂMEMORY** (or **ⓂMEMORY**).

The MEMORY indicator flashes in the front panel display for approximately 30 seconds.



Flashes

Note

You must proceed to and carry out steps 3 through 5 while the MEMORY indicator is flashing in the front panel display.

3 Press **ⓂCATEGORY** (or **ⓂA-E/CAT**. **</>**) repeatedly to select a preset channel group (A to E) while the MEMORY indicator is flashing.

The preset channel group letter appears in the front panel display.

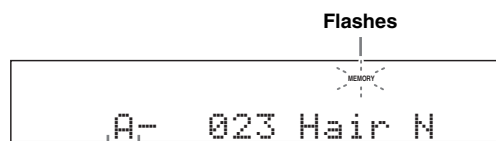

Currently selected preset channel group

4 Press **ⓂPRESET/TUNING/CH** **</>** (or **ⓂPRESET/CH** **Δ/∇**) repeatedly to select a preset channel number (1 to 8) while the MEMORY indicator is flashing.

The preset channel number appears in the front panel display.

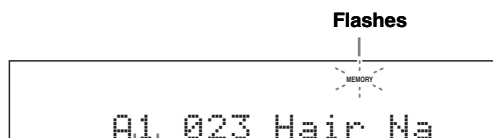

Currently selected preset channel number

5 Press **ⓂMEMORY** (or **ⓂMEMORY**) to set the selected SIRIUS Satellite Radio channel as a preset channel while the MEMORY indicator is flashing.

A colon (:) appears next to the preset channel number for confirmation, and the MEMORY indicator turns off in the front panel display.

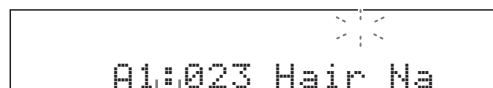

Colon (:)

Note

Once you set a new preset channel, the one previously stored in the same preset channel group and number is cleared.

Setting the Parental Lock

You can use the Parental Lock feature to limit the access to the desired SIRIUS Satellite channels. This unit automatically skips the locked channels when this unit is in the All Channel Search mode or Category Search mode and you search a channel by pressing

ⓂPRESET/TUNING/CH **</>** (or **ⓂPRESET/CH** **Δ/∇**).

■ Setting the code number and the locked channels

Use this feature to set the Parental Lock code number (PIN) and select the channels to be locked.

1 Press **ⓂAMP** on the remote control and then press **ⓂMENU** to display.

2 Press **Ⓜ∇** to select “MANUAL SETUP” and then press **ⓂENTER**.

3 Press Ⓢ repeatedly to select “OPTION MENU” and then press Ⓢ ENTER.

4 Press Ⓢ Δ / ∇ repeatedly to select “G)SIRIUS SET” and then press Ⓢ ENTER.

The following menu screen appears.

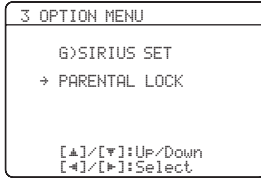

5 Press Ⓢ ENTER.

“NEW PIN:0000” appears.

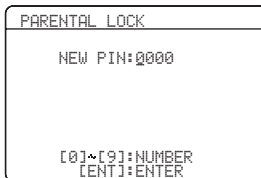

Note

If a SiriusConnect tuner is not connected to this unit, “Not Available” appears.



If the Parental Lock code number is already set, “PIN:___” appears instead of “NEW PIN:0000”. Refer to step 8 and then proceed the operations.

6 Enter the desired 4-digit code number by using the numeric buttons (Ⓢ).



Press Ⓢ RETURN to return the previous menu level without setting the code number.

7 Press Ⓢ ENTER to confirm the code number.
“OK” appears and then “PIN:___” appears.

8 Enter the 4-digit code number you set at step 6 above to unlock the protection.

When the code number is correct, “OK” and then the SIRIUS Satellite Radio channel list appears.

9 Press Ⓢ \triangleleft / \triangleright repeatedly to select the desired channel category and then press Ⓢ Δ / ∇ repeatedly to select the channel you want to lock.

Note

In the SIRIUS Satellite Radio channel list screen, this unit outputs the sound of the selected channel even if the channel is locked. Only the first eight characters of each channel name are displayed in the list.

10 Press Ⓢ ENTER to lock the selected channel.

Check mark appears before the selected channel.



When you select the locked channel and press Ⓢ ENTER, this unit unlocks the selected channel.

11 Repeat steps 9 and 10 to lock the channels you want.

12 Press Ⓢ RETURN repeatedly to exit from the “PARENTAL LOCK” screen.

13 Press Ⓢ MENU to exit from the setup menu.

This unit is tuned into the last channel you select in the “PARENTAL LOCK” screen. If the channel is locked, this unit is tuned into “184 SIRIUS Weather & Emergency” or “000 Sirius IDxxxxxxxxxx” (“xxxxxxxxxx” indicates the Sirius ID of your SiriusConnect tuner).



If you forget or want to change the Parental lock code number, use “SSR PIN” in “ADVANCED SETUP” to reset the Parental Lock code number.

■ Tuning into the locked channels

You can tune into the locked channels by the Direct number access mode or preset channel mode. When you tune into the locked channel, following message appears in the front panel display. Enter the code number you set for the Parental Lock feature by using the numeric buttons (Ⓢ) or press Ⓢ ENT to cancel the tuning.

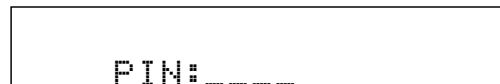

Note

If the entered code number is incorrect, “Wrong” appears in the front panel display and this unit is tuned into the previously selected channel.

Before performing the following operations, press **ⓂSIRIUS**.

Displaying the SIRIUS Satellite Radio™ information

You can display the SIRIUS Satellite Radio information (such as channel number, channel name, category, artist name, composer name, or song title) for the currently selected channel in the front panel display or in the OSD.

Note

If a status message or an error message appears in the front panel display or in the OSD, see the “SIRIUS Satellite Radio” section in “Troubleshooting” on page 83 for appropriate remedies.

■ Displaying the SIRIUS Satellite Radio information in the front panel display

Press **ⓂINFO** (or **ⓂINFO**) repeatedly to toggle between the following SIRIUS Satellite Radio information display modes.

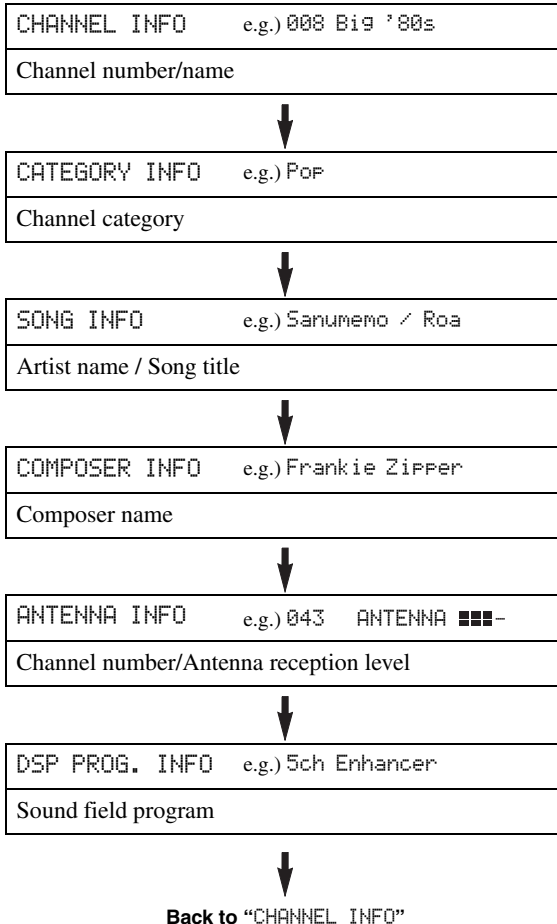

- The front panel display can indicate up to 14 alphanumeric characters at once. You can set whether to display the SIRIUS Satellite Radio information in the front panel display in a continuous manner or by 14 alphanumeric characters at once by using the “FL SCROLL” parameter in “OPTION MENU” (see page 70).
- If the SIRIUS Satellite Radio information contains a character that cannot be recognized by this unit, the character will be displayed with a space.
- To hold the current SIRIUS Satellite Radio information, press **ⓂENTER** while it is being displayed.

■ Displaying the SIRIUS Satellite Radio information in the OSD

Press **ⓂINFO** (or **ⓂDISPLAY**).

The following screen is displayed in the OSD.

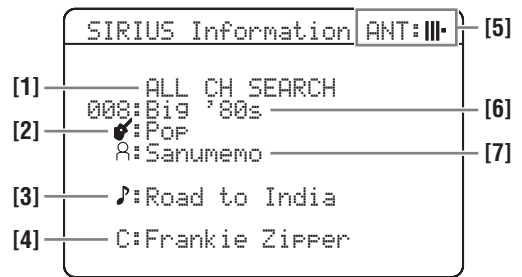

[1] Search mode (see page 52)

[2] Channel category

[3] Song title

[4] Composer name

[5] Antenna reception level

[6] Channel number/name

[7] Artist name



- To turn off the OSD, press **ⓂDISPLAY** again.
- SIRIUS status messages also appear in the OSD.
- You can select the amount of time the SIRIUS Satellite Radio information is displayed in the OSD by using the “OSD-SOURCE” parameter in “OPTION MENU” (see page 70).
- To hold the SIRIUS Satellite Radio information, press **ⓂENTER** while it is being displayed in the OSD. While this unit is holding the information screen, “HOLD” appears in the OSD.
- The HOLD indicator flashes in the front panel display while you are holding the SIRIUS information. Press **ⓂENTER** again or change the SIRIUS Satellite Radio channel to release the held information. When an information is unavailable, “----” appears.

Using iPod™

Once you have stationed your iPod in a Yamaha iPod universal dock (such as YDS-10, sold separately) connected to the DOCK terminal of this unit (see page 19), you can enjoy playback of your iPod using the supplied remote control. You can also use the Compressed Music Enhancer mode of this unit to improve the sound quality of the compression artifacts (such as the MP3 format) stored on your iPod (see page 19).

Notes

- Only iPod (Click and Wheel), iPod nano, and iPod mini are supported.
- Some features may not be compatible depending on the model or the software version of your iPod.



- For a complete list of status messages that appear in the front panel display and in the OSD, see the “iPod” section in “Troubleshooting” on page 85.
- Once your iPod is stationed in a Yamaha iPod universal dock, this unit begins signal transmission with your iPod.
- Once the connection between your iPod and this unit is complete, “iPod connected” appears in the front panel display and the DOCK indicator lights up in the front panel display.
- Only the analog audio and video signals of your iPod are input at the DOCK terminal, and the analog audio signals can be output at the analog AUDIO OUT (REC) jacks for recording.
- Your iPod battery is automatically charged when your iPod is stationed in a Yamaha iPod universal dock connected to the DOCK terminal of this unit as long as this unit is turned on.

Controlling iPod™

You can control your iPod when “V-AUX” is selected as the input source. The operations of your iPod can be done with the aid of the OSD of this unit (menu browse mode) or without it (simple remote mode).

■ Remote control operation

Before performing the following operations, press
④ **V-AUX/DOCK**.

| Button | Function |
|-----------|---|
| ③ ENTER | Subsequent menu |
| △ | Menu up |
| ▽ | Menu down |
| ◀ | Previous menu |
| ▶ | Subsequent menu |
| ⑩ ◀◀ | Search backward (Press and hold) |
| ▶▶ | Search forward (Press and hold) |
| ◀◀ | Skip backward |
| ▶▶ | Skip forward |
| ⏸ | Pause (Menu browse mode) Play/Pause (Simple remote mode) |
| ▶ | Play (Menu browse mode) Play/Pause (Simple remote mode) |
| Ⓜ MENU | Previous menu |
| Ⓜ DISPLAY | Display |

■ Controlling iPod in the simple remote mode

You can perform the basic operations of your iPod (play, stop, skip, etc.) using the supplied remote control without the aid of the OSD of this unit.



- You can view the photos or video clips stored on your iPod (some models only).
- Operations can be also done with the controls on your iPod.

■ Controlling iPod in the menu browse mode

You can perform the advanced operations of your iPod using the supplied remote control when you connect this unit and a monitor using the VIDEO connection. You can browse the songs stored on your iPod in the OSD. Further, you can change or adjust settings for your iPod to suit your personal preferences.



- The name of the song being played also appears in the front panel display according to the “FL SCROLL” parameter in “OPTION MENU” (see page 70).
- You can select the amount of time the iPod menu and play information is displayed in the OSD by using the “OSD-SOURCE” in “OPTION MENU” (see page 70)

Notes

- Operations cannot be done with the controls on your iPod.
- The Yamaha logo appears in the display window of your iPod.
- There are some characters that cannot be displayed in the front panel display or in the OSD of this unit. Those characters are replaced with underscores “_”.
- The “Settings” parameters can be changed or adjusted only in the OSD. Press **Ⓢ** ENTER repeatedly to toggle between the “Settings” parameter settings.
- You cannot browse the photos or video clips stored on your iPod in the OSD. Use the simple remote mode to enjoy watching the photos or video clips stored on your iPod.

1 Press **Ⓢ** V-AUX/DOCK and then **Ⓢ** DISPLAY.

The following display appears in the OSD.



2 Press **Ⓢ** Δ / ∇ / \triangleleft / \triangleright to navigate the iPod menu and then press **Ⓢ** ENTER to begin playback of the selected song.

Choices: Playlists (playlists), Artists (artists), Albums (albums), Songs (songs), Genres (genres), Composers (composers), Settings (settings)

- Playlists > Songs
- Artists > Albums > Songs
- Albums > Songs
- Songs
- Genres > Artists > Albums > Songs
- Composers > Albums > Songs
- Settings > Shuffle, Repeat

Shuffle Shuffle

Use this feature to set this unit to play songs or albums in random order.

Choices: Off, Songs, Albums

- Select “Off” to deactivate this feature.
- Select “Songs” to set this unit to play songs in random order.
- Select “Albums” to set this unit to play albums in random order.



When “Shuffle” is set to a setting other than “Off”, “ \square ” appears in the top right corner while songs or albums are being shuffled.

Repeat Repeat

Use this feature to set this unit to repeat one song or a sequence of songs.

Choices: Off, One, All

- Select “Off” to deactivate this feature.
- Select “One” to set this unit to repeat one song.
- Select “All” to set this unit to repeat a sequence of songs.



When “Repeat” is set to a setting other than “Off”, “ \square ” or “ \square ” appears in the top right corner while one song or a sequence of songs are being repeated.

■ The function of the play information display

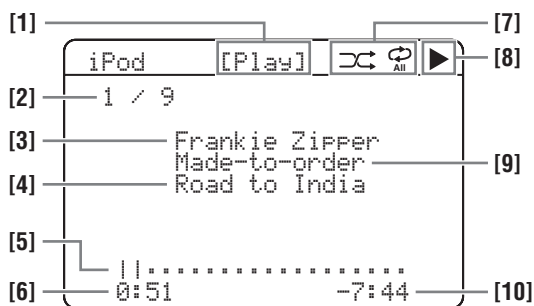

[1] Playback status

[2] Track number/total tracks

[3] Artist name

[4] Song title

[5] Progress bar

[6] Elapsed time

[7] Shuffle and repeat icons

[8] \blacktriangleright (playback), \parallel (pausing), $\blacktriangleright\blacktriangleright$ (search forward) and $\blacktriangleleft\blacktriangleleft$ (search backward)

[9] Name of the album

[10] Remaining time

Using Bluetooth™ components

You can connect a Yamaha Bluetooth adapter (such as YBA-10, sold separately) to the DOCK terminal of this unit and enjoy the music contents stored in your Bluetooth component (such as a portable music player) without wiring between this unit and the Bluetooth component. You need to perform “pairing” the connected Bluetooth adapter and your Bluetooth component in advance.

Pairing the Bluetooth™ adapter and your Bluetooth component

Pairing must be performed when using a Bluetooth component with the Bluetooth adapter connected to this unit for the first time or if the pairing data has been deleted. “Pairing” refers to the operation of registering a Bluetooth component for Bluetooth communications.



- You only need the pairing operation for the first time that you use the Bluetooth component with the Bluetooth adapter.
- Pairing requires operations on this unit and on the other component with which Bluetooth communications are to be established. If necessary, refer to the other component’s operating instructions.

There are two pairing methods: pairing by using “START PAIRING” in “SET MENU” and quick pairing.

■ Pairing by using “SET MENU”

Use this feature to perform pairing with the video monitor. Select “START PAIRING” in “INPUT MENU”. See page 71 for details.

■ Quick pairing

To ensure security, a time limit of 8 minutes is set for the pairing operation. You are recommended to read and fully understand all the instructions before starting.

- 1 Press INPUT / repeatedly (or press V-AUX/DOCK) to select “V-AUX” as the input source.**
- 2 Turn on the Bluetooth component you want to pair with.**
- 3 Press and hold BAND (or BAND) for 3 seconds to start pairing.**

Once the Bluetooth adapter starts pairing, “Searching...” appears for a moment. While the Bluetooth adapter is in the pairing mode, DOCK indicator flashes in the front panel display.



To cancel the pairing, press BAND (or BAND) again.

Note

If the Bluetooth adapter is not connected to the DOCK terminal of this unit, “No BT adapter” appears in the front panel display.

4 Check that the Bluetooth component detects the Bluetooth adapter.

If the Bluetooth component detects the Bluetooth adapter, “YBA-10 YAMAHA” (example) appears in the Bluetooth device list.

5 Select the Bluetooth adapter in the Bluetooth device list and then enter the pass key “0000” on the Bluetooth component.

When the pairing procedure is successful, “Completed” appears in the front panel display.

Note

The Yamaha Bluetooth adapter can be paired with up to eight Bluetooth components. When pairing is conducted successfully with a ninth component and the pairing data is registered, the pairing data for the least recently used other component is cleared.

Playback of the Bluetooth™ component

- 1 Press INPUT / repeatedly (or press V-AUX/DOCK) to select “V-AUX” as the input source.**
- 2 Start playback of your Bluetooth component.**

When the connected Bluetooth adapter detects the Bluetooth component, “BT connected” and the DOCK indicator appears in the front panel display.



- When you press ENTER, the connected Bluetooth adapter searches and connect to the last connected Bluetooth component. If the Bluetooth adapter cannot find the Bluetooth component, “Not found” appears in the front panel display.
- To disconnect the Bluetooth adapter from the Bluetooth component, press RETURN.

Recording

Recording adjustments and other operations are performed from the recording components. Refer to the operating instructions for those components.

Notes

- When this unit is set to the standby mode, you cannot record between other components connected to this unit.
- TONE CONTROL (see page 41) and VOLUME settings, speaker levels (see page 41) and the sound field programs (see page 38) do not affect recorded material.
- The source connected to the MULTI CH INPUT jacks of this unit cannot be recorded.
- The XM Satellite Radio signals cannot be output at the AUDIO OUT (REC) jacks.
- The SIRIUS Satellite Radio signals cannot be output at the AUDIO OUT (REC) jacks.
- Digital signals input at the DIGITAL INPUT jacks are not output at the analog AUDIO OUT (REC) jacks for recording. Therefore, if your source component is connected to provide only digital signals, you cannot record the source.
- A given input source is not output on the same OUT (REC) channel.
- The analog audio signals input at the DOCK terminal can be output at the analog AUDIO OUT (REC) jacks for recording.
- Once you have connected a recording component to this unit, keep the component turned on while using this unit. If the component is turned off, this unit may distort the sound from other components.
- Check the copyright laws in your country to record from CDs, radio, etc. Recording of copyrighted material may infringe copyright laws.



Do a test recording before you start an actual recording.

If you play back a video source that uses scrambled or encoded signals to prevent it from being dubbed, the picture itself may be disturbed due to those signals.

1 Turn on all the connected components.

2 Press **Ⓢ INPUT </> repeatedly (or press one of the input selector buttons (④)) to select the source component you want to record from.**

3 Start playback on the selected source component or select a broadcast station.

4 Start recording on the recording component.

SET MENU

You can use the following parameters in “SET MENU” to adjust a variety of system settings and customize the way this unit operates. Change the initial settings (indicated in bold under each parameter) to reflect the needs of your listening environment.

■ Auto setup **AUTO SETUP**

Use this feature to automatically adjust speaker and system parameters (see page 24).

■ Manual setup **MANUAL SETUP**

Use this feature to manually adjust speaker and system parameters.

Sound menu 1 **SOUND MENU**

| Parameter | Features | Page |
|-----------------|---|------|
| A)SPEAKER SET | Selects the size of each speaker, the speakers for low-frequency signal output, and the crossover frequency, and the location of the front speakers connected to the FRONT B terminals. | 63 |
| B)SP LEVEL | Adjusts the output level of each speaker. | 65 |
| C)SP DISTANCE | Adjusts the delay time of each speaker. | 65 |
| D)CENTER GEQ | Adjusts the tonal quality of the center speaker. | 66 |
| E)LFE LEVEL | Adjusts the output level of the LFE channel for Dolby Digital or DTS signals. | 66 |
| F)DYNAMIC RANGE | Adjusts the dynamic range of Dolby Digital or DTS signals. | 66 |
| G)AUDIO SET | Adjusts the muting level, audio delay, maximum volume level and initial volume level. | 66 |
| H)HDMI SET | Selects whether to play back HDMI audio signals on this unit or on another HDMI component connected to the HDMI OUT jack. | 67 |

Input menu 2 **INPUT MENU**

| Parameter | Features | Page |
|--------------------|---|------|
| A)INPUT ASSIGNMENT | Assigns the input jacks of this unit according to the component to be used. | 68 |
| B)INPUT RENAME | Changes the name of the input source. | 68 |
| C)VOLUME TRIM | Adjusts the output volume of each input source. | 69 |
| D)DECODER MODE | Selects the decoder mode for the sources connected to the DIGITAL INPUT jacks on the rear panel of this unit. | 69 |
| E)MULTI CH SET | Selects the video source played in the background of the sources input from the MULTI CH INPUT jacks. | 69 |

Option menu 3 OPTION MENU

| Parameter | Features | Page |
|-----------------|--|------|
| A)DISPLAY SET | Adjusts the brightness of the front panel display and the way in which the XM and iPod information is displayed. | 70 |
| B)MEMORY GUARD | Locks sound field program parameters and other “SET MENU” settings. | 70 |
| C)AUDIO SELECT | Designates the default audio input jack select setting for the input sources connected to the DIGITAL INPUT jacks when you turn on the power of this unit. | 71 |
| D)PARAM. INI | Initializes the parameters of a group of sound field programs. | 71 |
| E)BLUETOOTH SET | Pair the connected Yamaha Bluetooth adapter (such as YBA-10, sold separately) with a Bluetooth component (see page 59). | 71 |
| F)XM RADIO SET | Displays the current reception level of the XM Satellite Radio signals. | 72 |
| G)SIRIUS SET | Sets the SIRIUS Parental Lock code number and the channel lock configuration (see page 54). | 72 |

Note

The “XM RADIO SET” and “SIRIUS SET” parameters are only applicable to the U.S.A. and Canada models.

■ **Signal information** SIGNAL INFO

Use this feature to check audio signal information (see page 36).

Using SET MENU

Use the remote control to access and adjust each parameter.



You can change the “SET MENU” parameters while this unit is reproducing sound.

- 1 Press **5 AMP** and then press **23 MENU** to enter “SET MENU”.

The top “SET MENU” display appears in the OSD.

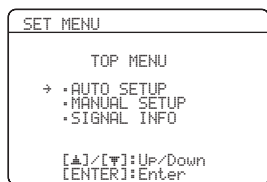

- 2 Press **8 Δ / ∇** to select “MANUAL SETUP”.



- 3 Press **8 ENTER** to enter “MANUAL SETUP”.

The “MANUAL SETUP” display appears in the OSD.

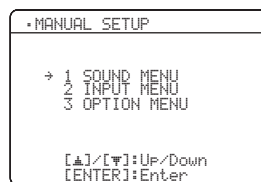

- 4 Press **8 Δ / ∇ / ◀ / ▶** and **8 ENTER** to select and change the parameter.

- Press **8 Δ / ∇** to select the desired menu or parameter.
- Press **8 ◀ / ▶** to change the parameter value.
- Press **8 ENTER** to enter the selected menu or to confirm the parameter.
- Press **9 RETURN** to return to the previous menu level.

- 5 Press **23 MENU** to exit from “SET MENU”.

1 SOUND MENU

Use this menu to manually adjust any speaker settings or compensate for video signal processing delays when using LCD monitors or projectors.

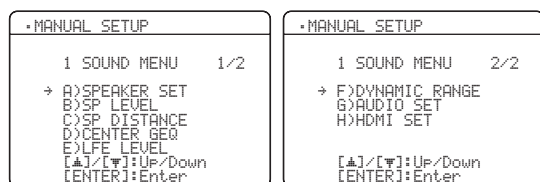

■ Speaker settings A) SPEAKER SET

Use this feature to manually adjust any speaker settings.

FRONT B speaker setting FRONT B

Use this feature to select the location of the front speakers connected to the FRONT B terminals.

Choices: **FRONT**, ZONE B

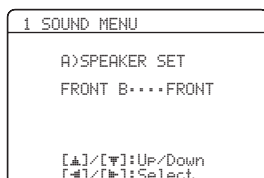

- Select "FRONT" to turn on or off SPEAKERS A and B when the speakers connected to the FRONT B terminals are set in the main zone.
- Select "ZONE B" if the speakers connected to the FRONT B terminals are set in another zone. If SPEAKERS A is turned off and SPEAKERS B is turned on, all the speakers including the subwoofer in the main zone are muted and this unit outputs sound at the FRONT B terminals only.

Notes

- If you connect headphones to the PHONES jack of this unit, the sound is output from both headphones and the FRONT B terminals when "FRONT B" is set to "ZONE B".
- If a DSP program is selected when "FRONT B" is set to "ZONE B", this unit automatically enters the Virtual CINEMA DSP mode (see page 39).

Woofer section of a speaker is 16 cm (6.5 in) or larger:
large

Woofer section of a speaker is smaller than 16 cm (6.5 in): small

Front speakers FRONT SP

Choices: SMALL, **LARGE**

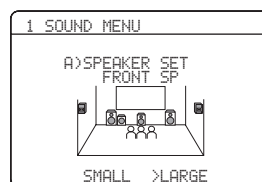

When the front speakers are large

Select "LARGE" (large).

When the front speakers are small

Select "SMALL" (small).

Note

When "LFE/BASS OUT" is set to "FRONT" (see page 64), you can select only "LARGE" in "FRONT SP". If the value of "FRONT SP" is set to a setting other than "LARGE" in advance, this unit automatically changes the value to "LARGE".

Center speaker CENTER SP

Choices: NONE, **SML**, LRG



When the center speaker is large

Select "LRG" (large).

When the center speaker is small

Select "SML" (small).

When you do not use the center speaker

Select "NONE" (none). The center channel signals are directed to the front left and right speakers.

Surround left/right speakers SUR. L/R SP

Choices: NONE, **SML**, LRG

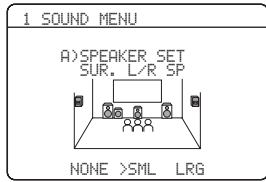

When the surround speakers are large

Select "LRG" (large).

When the surround speakers are small

Select "SML" (small).

When you do not use the surround speakers

Select "NONE" (none). This unit is set to the Virtual CINEMA DSP mode (see page 39).

LFE Bass out LFE/BASS OUT

Use this feature to select the speakers that output the LFE (low-frequency effect) and the low-frequency signals.

Choices: SWFR, FRNT, **BOTH**

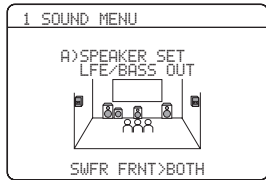

When a subwoofer is connected to this unit and you want to get natural bass sound

Select "SWFR" (subwoofer). The LFE signals as well as the low-frequency signals of other speakers set to "SML" (or "SMALL") are directed to the subwoofer.

When a subwoofer is connected to this unit and you want to get rich bass sound

Select "BOTH" (both). The low-frequency signals of any source are output from the subwoofer. The LFE signals as well as the low-frequency signals of other speakers set to "SML" (or "SMALL") are directed to the subwoofer. The low-frequency signals of the front left and right channels are directed to the front left and right speakers and the subwoofer regardless of the "FRONT SP" setting (see page 63).

When you do not use a subwoofer

Select "FRNT" (front). The LFE signals, the low-frequency signals of the front left and right channels, and the low-frequency signals of other speakers set to "SML" (or "SMALL") are all directed to the front left and right speakers regardless of the "FRONT SP" setting (see page 63).

Crossover CROSSOVER

Use this feature to select the crossover frequency of all the speakers set to "SML" (or "SMALL") in "SPEAKER SET" (see page 63). All frequencies below the selected frequency will be sent to the subwoofer or front speakers depending on the setting of "LFE/BASS OUT" in "SPEAKER SET" (see page 63).

Choices: 40Hz, 60Hz, **80Hz**, 90Hz, 100Hz, 110Hz, 120Hz, 160Hz, 200Hz



Subwoofer phase SUBWOOFER PHASE

Use this feature to switch the phase of your subwoofer if bass sounds are lacking or unclear.

Choices: **NORMAL**, REVERSE



- Select "NORMAL" if you do not want to reverse the phase of your subwoofer.
- Select "REVERSE" to reverse the phase of your subwoofer.

■ Speaker level B)SP LEVEL

Use this feature to manually adjust the output level of each speaker.

Control range: -10 to +10 dB

Control step: 1 dB

Initial setting: 0 dB

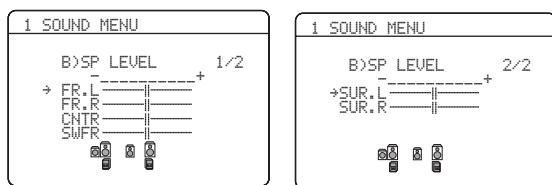

| SP LEVEL | Adjusted speaker |
|----------|------------------------|
| FR.L | Front left speaker |
| FR.R | Front right speaker |
| CNTR | Center speaker |
| SWFR | Subwoofer |
| SUR.L | Surround left speaker |
| SUR.R | Surround right speaker |

Note

The available speaker channels differ depending on the setting of the speakers.

■ Speaker distance C)SP DISTANCE

Use this feature to manually adjust the distance of each speaker and the delay applied to the respective channel. Ideally, each speaker should be the same distance from the main listening position. However, this is not possible in most home situations. Thus, a certain amount of delay must be applied to the sound from each speaker so that all sounds will arrive at the listening position at the same time.

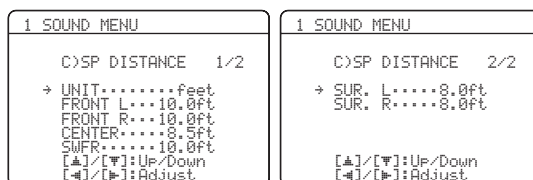

Unit UNIT

Choices: meters (m), feet (ft)

Initial setting:

[U.S.A. and Canada models]: feet (ft)

[Other models]: meters (m)

- Select “meters” to adjust speaker distances in meters.
- Select “feet” to adjust speaker distances in feet.

Speaker distances

Control range: 0.30 to 24.00 m (1.0 to 80.0 ft)

Control step: 0.10 m (0.5 ft)

Initial setting:

FRONT L/FRONT R/SWFR: 3.00 m (10.0 ft)

CENTER: 2.60 m (8.5 ft)

SUR. L/SUR. R: 2.40 m (8.0 ft)

| SP DISTANCE | Adjusted speaker |
|-------------|------------------------|
| FRONT L | Front left speaker |
| FRONT R | Front right speaker |
| CENTER | Center speaker |
| SWFR | Subwoofer |
| SUR. L | Surround left speaker |
| SUR. R | Surround right speaker |

Note

The available speaker channels differ depending on the setting of the speakers.

■ **Center speaker equalizer** D>CENTER GEQ

Use this feature to adjust the built-in 5-frequency band (100Hz, 300Hz, 1kHz, 3kHz and 10kHz) graphic equalizer for the center channel so that the tonal quality of the center speaker matches that of the front speakers. You can make adjustments while listening to the currently selected source component or a test tone.

Control range: -6.0 to +6.0 dB

Control step: 0.5 dB

Initial setting: 0 dB

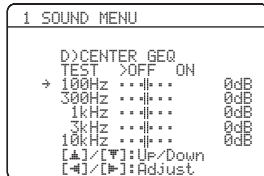

Test tone TEST

Use this feature to make adjustments for “CENTER GEQ” while listening to a test tone.

Choices: **OFF**, **ON**

- Select “OFF” to stop test tones and output the currently selected source component.
- Select “ON” to output test tones from the center and front left speakers.

■ **Low-frequency effect level** E>LFE LEVEL

Use this feature to adjust the output level of the LFE (low-frequency effect) channel according to the capacity of your subwoofer or headphones. The LFE channel carries low-frequency special effects which are only added to certain scenes. This setting is effective when the input signal contains the LFE channel.

Control range: -20 to **0** dB

Control step: 1 dB



Speaker SPEAKER

Adjusts the speaker LFE level.

Headphone HEADPHONE

Adjusts the headphone LFE level.

Note

Depending on the settings of “LFE/BASS OUT” (see page 64), some signals may not be output at the SUBWOOFER OUTPUT jack.

■ **Dynamic range** F>DYNAMIC RANGE

Use this feature to select the amount of dynamic range compression to be applied to your speakers or headphones. This setting is effective only when this unit is decoding Dolby Digital and DTS signals.



Speaker SPEAKER

Adjusts the speaker compression.

Headphone HEADPHONE

Adjusts the headphone compression.

Choices: **MIN**, **STD**, **MAX**

- Select “MIN” (minimum) if you regularly listen at low volume levels.
- Select “STD” (standard) for general use.
- Select “MAX” (maximum) to preserve the greatest amount of dynamic range.

■ **Audio settings** G>AUDIO SET

Use this feature to adjust the overall audio settings of this unit.

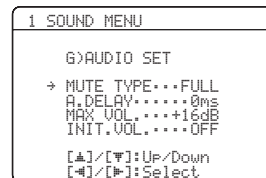

Mute type MUTE TYPE

Use this feature to adjust how much the mute function reduces the output volume (see page 35).

Choices: **FULL**, -20dB

- Select “FULL” to completely mute all the audio output.
- Select “-20dB” to reduce the current volume by 20 dB.

Audio delay A.DELAY

Use this feature to delay the sound output and synchronize it with the video image. This may be necessary when using certain LCD monitors or projectors.

Control range: **0** to 160 ms

Control step: 1 ms

Maximum volume MAX VOL.

Use this feature to set the maximum volume level. This feature is useful to avoid the unexpected loud sound by mistake. For example, the original volume range is +16 dB to -80 dB. However, when "MAX VOL." is set to -5 dB, the volume range becomes -5 dB to -80 dB.

Control range: **+16 dB**, +10 dB to -30 dB

Control step: 5 dB

Note

The "MAX VOL." setting takes priority over the "Initial Volume" setting. For example, if "INIT.VOL." is set to -20 dB and "MAX VOL." is set to -30 dB, the volume level is automatically set to -30 dB when you turn on the power of this unit next time.

Initial volume INIT. VOL.

Use this feature to set the volume level when the power of this unit is turned on.

Choices: **Off**, MUTE, -80 dB to +16 dB

Control step: 1 dB

Note

The "MAX VOL." setting takes priority over the "INIT.VOL." setting.

HDMI set H>HDMI SET

Use this feature to select the component to play back HDMI audio signals.

**Support audio** S. AUDIO

Use this feature to select whether to play back HDMI audio signals on this unit or on another HDMI component connected to the HDMI OUT jack on the rear panel of this unit.

| Choice | Functions |
|---------|---|
| RX-U463 | Plays back HDMI audio signals on this unit. The HDMI audio signals input at the HDMI input jacks of this unit are not output to the HDMI component connected to the HDMI OUT jack on the rear panel of this unit. |
| Other | Plays back HDMI audio signals on another HDMI component connected to the HDMI OUT jack. |

Notes

- This unit transmits audio and video signals input at the HDMI input jacks to the HDMI out jack only when this unit is turned on even if "SUPPORT AUDIO" is set to "Other".
- Available audio/video signals depend on the specification of the connected video monitor. Refer to the instruction manual of each connected component.

2 INPUT MENU

Use this menu to reassign the input jacks, select the decoder mode or rename the input source.

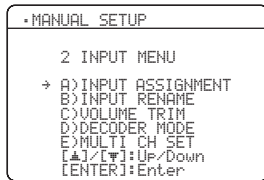

Input assignment

A) INPUT ASSIGNMENT

Use this feature to assign the input jacks according to the component to be used if the initial settings of this unit do not correspond to your needs. Change the following parameters to reassign the respective jacks and effectively connect more components.

Once the input jacks are reassigned, you can select the corresponding component by using **⊙INPUT** \leftarrow/\rightarrow (or the input selector buttons (4)).

For COAXIAL INPUT jack 1

COAXIAL IN (1)

Choices: (1) CD, MD/CD-R, **DVD**, DTV/CBL, V-AUX, DVR

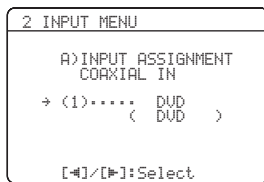

For OPTICAL INPUT jacks 2 and 3

OPTICAL IN (2)

OPTICAL IN (3)

Choices: (2) CD, MD/CD-R, DVD, **DTV/CBL**, V-AUX, DVR
 (3) **CD**, MD/CD-R, DVD, DTV/CBL, V-AUX, DVR

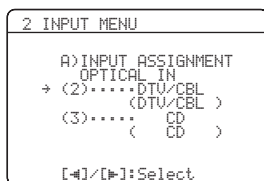

Note

You cannot select a specific item more than once.

For HDMI jacks 1 and 2

HDMI IN [1]

HDMI IN [2]

Choices: (1) **DVD**, DTV/CBL, V-AUX, DVR
 (2) DVD, **DTV/CBL**, V-AUX, DVR

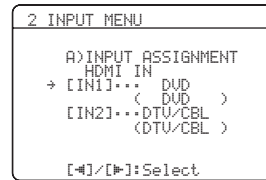

Input rename B) INPUT RENAME

Use this feature to change the name of the input source that appears in the OSD and in the front panel display.

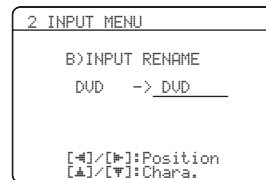

- Press one of the input selector buttons (4) or **ⓂMULTI CH IN** to select the input source you want to change the name of.

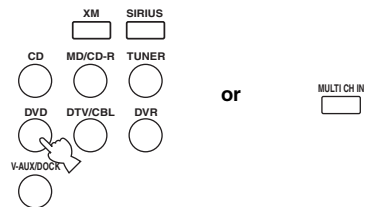

- Press **ⓂAMP** and then press **Ⓢ** \leftarrow/\rightarrow on the remote control to place the “_” (underscore) under the space or the character you want to edit.

- Press **Ⓢ** Δ/∇ to select the character you want to use and then press **Ⓢ** \leftarrow/\rightarrow to move to the next space.

Notes

- You can use up to 8 characters for each input.
- Press **Ⓢ** ∇ to change the character in the following order, or press **Ⓢ** Δ to go in the reverse order:
 A to Z, a space, 0 to 9, a space, a to z, a space, symbols (#, *, -, +, etc.)

4 Repeat steps 1 through 3 to rename each input source.

5 Press **Ⓜ**ENTER to exit from “INPUT RENAME”.

■ Volume trim C>VOLUME TRIM

Use this feature to adjust the output volume of each source. This is useful if you want to balance the level of each input source to avoid sudden changes in volume when switching between input sources.

Choices: CD, MD/CD-R, TUNER, DVD, DTV/CBL, V-AUX, DVR, DOCK, MULTI CH, XM, SIRIUS

Control range: -6.0 to +6.0 dB

Control step: 1.0 dB

Initial setting: 0.0 dB

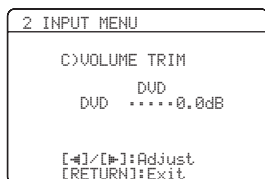

Note

You can only adjust the value for DOCK when your iPod is stationed in the Yamaha Universal Dock connected to this unit.

■ Decoder mode D>DECODER MODE

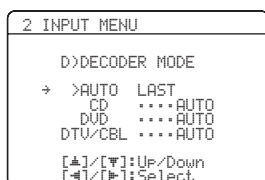

Decoder select mode

Use this feature to designate the default decoder mode for the input sources connected to the DIGITAL INPUT jacks when you turn on the power of this unit.

Choices: **AUTO**, **LAST**

- Select “AUTO” if you want this unit to automatically detect the type of input signals and select the appropriate decoder mode.
- Select “LAST” if you want this unit to automatically select the last decoder mode used the connected input source.

DTS decoder prioritize setting

Choices: **AUTO**, **DTS**

- Select “AUTO” if you want this unit to automatically detect input signal types and select the appropriate input mode.
- Select “DTS” when you play back a DTS-CD.

■ Multi channel input setup

E>MULTI CH SET

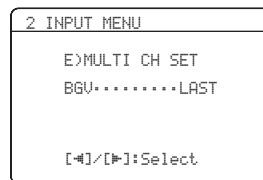

Background Video BGV

Use this feature to select the video source played in the background of the sources input at the MULTI CH INPUT jacks.

Choices: DVD, DTV/CBL, V-AUX, DVR, **LAST**



Select “LAST” to set this unit to automatically select the last selected video source as the background video source.

3 OPTION MENU

Use this menu to adjust the optional system parameters.

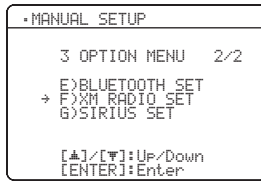
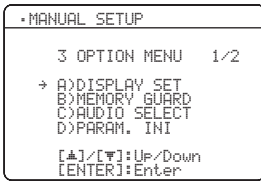

■ Display settings A)DISPLAY SET

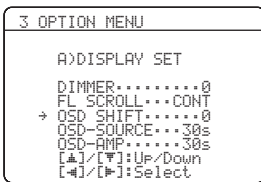

Dimmer DIMMER

Use this feature to adjust the brightness of the front panel display.

Control range: -4 to 0

Control step: 1

- Press **8**◀ to make the front panel display dimmer.
- Press **8**▶ to make the front panel display brighter.

Front panel display scroll FL SCROLL

Use this feature to set whether to display the information (such as a song title or a channel name) in the front panel display in a continuous manner or by the first 14 alphanumeric characters after scrolling all characters once when “XM”, “SIRIUS” or “DOCK” is selected as the input source.

Choices: **CONT**, **ONCE**

- Select “CONT” to display the operation status in the front panel display in a continuous manner.
- Select “ONCE” to display the operation status in the front panel display by the first 14 alphanumeric characters after scrolling all characters once.

OSD shift OSD SHIFT

Use this feature to adjust the vertical position of the OSD.

Control range: -5 (downward) to +5 (upward)

Control step: 1

Initial setting: 0

- Press **8**◀ to lower the position of the OSD.
- Press **8**▶ to raise the position of the OSD.

Source feature OSD display time

OSD-SOURCE

Use this feature to set the amount of time to display the XM Satellite Radio information, SIRIUS Satellite Radio information or iPod menu in the OSD after you perform a certain operation.

Choices: ON, 10s, **30s**

- Select “ON” to display the OSD unceasingly during an operation.
- Select “10s” to turn off the OSD 10 seconds after you perform a certain operation.
- Select “30s” to turn off the OSD 30 seconds after you perform a certain operation.

Amplifier function OSD display time

OSD-AMP

Use this feature to set the amount of time to display the status after you perform a certain operation.

Choices: ON, 10s, **30s**

- Select “ON” to display the OSD constantly during an operation.
- Select “10s” to turn off the OSD 10 seconds after you perform a certain operation.
- Select “30s” to turn off the OSD 30 seconds after you perform a certain operation.

■ Memory guard B)MEMORY GUARD

Use this feature to prevent accidental changes to DSP program parameter values and other system settings.

Choices: **OFF**, ON

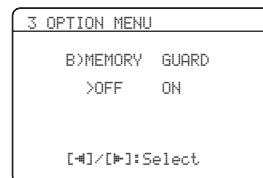

- Select “OFF” to turn off the “MEMORY GUARD” feature.
- Select “ON” to protect:
 - sound field program parameters
 - all “SET MENU” items
 - all speaker levels
 - SCENE template parameters

Note

When “MEMORY GUARD” is set to “ON”, you cannot select and adjust any other “SET MENU” items.

■ Audio select C>AUDIO SELECT

Use this feature to designate the default audio input jack select setting for the input sources when you turn on the power of this unit.

Choices: **AUTO**, **LAST**

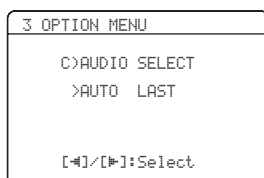

- Select “AUTO” if you want this unit to automatically detect the type of input signals and select the appropriate input mode.
- Select “LAST” if you want this unit to automatically select the last input mode used for the connected input source (see page 34).

■ Parameter initialization D>PARAM. INI

Use this feature to set all the parameters of the sound field programs to the initial factory settings.

Choices: **NO**, **YES**

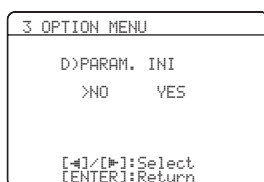

- Select “NO” to cancel the parameter initialization and return to the previous menu screen.
- Select “YES” and press **ⓂENTER** to set all the sound field parameters to the initial factory settings.

Notes

- You cannot automatically revert to the previous parameter settings once you initialize the sound field program parameters.
- You cannot separately initialize individual sound field programs.
- You cannot initialize any sound field program groups when “MEMORY GUARD” is set to “ON”.

■ Bluetooth setting E>BLUETOOTH SET



Use this feature to start pairing the connected Yamaha Bluetooth adapter (such as YBA-10, sold separately) with your Bluetooth component. For details about the pairing, refer to “Pairing the Bluetooth™ adapter and your Bluetooth component” on page 59.

To ensure security, a time limit of 8 minutes is set for the pairing operation. You are recommended to read and fully understand all the instructions before starting.

1 Press **ⓂENTER** to start pairing.

The connected Bluetooth adapter starts searching Bluetooth components. “Searching...” appears in the video monitor.

2 Check that the Bluetooth component detects the Bluetooth adapter.

If the Bluetooth component the Bluetooth adapter, “YBA-10 YAMAHA” (example) appears in the Bluetooth device list.

3 Select the Bluetooth adapter in the Bluetooth device list and then enter the pass key “0000” on the Bluetooth component.

Once this unit completes the pairing successfully, “Pairing completed” appears.



To cancel the pairing, press **ⓂRETURN** to exit from “START PAIRING”.

4 Press **ⓂRETURN** to exit from “START PAIRING”.

Notes

- If the connected Bluetooth adapter cannot find any Bluetooth components, “Not found” appears.
- If a Bluetooth adapter is not connected to this unit, “No Bluetooth Adapter” appears.

■ XM Radio setting F>XM RADIO SET (U.S.A. and Canada models only)

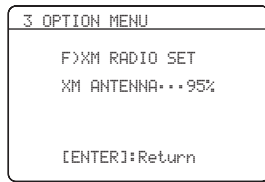

XM Radio antenna XM ANTENNA

Use this feature to check the current reception level of the XM Satellite Radio signals. For the best reception, orient XM Mini-Tuner so that a value of 60% or more is displayed here.

Display status: NONE, 0 to 100%

Note

“NONE” is displayed if XM Mini-Tuner Dock is not connected to this unit. In this case, check the antenna connections (see page 46).

■ SIRIUS Satellite Radio setting G>SIRIUS SET (U.S.A. and Canada models only)

Use this feature to set the code number for locking the desired SIRIUS Satellite Radio channels. Refer to “Setting the Parental Lock” on page 54 for details.

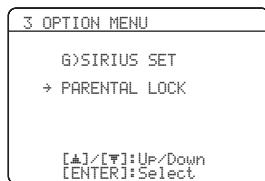

SIRIUS Satellite Radio parental lock

PARENTAL LOCK

Use this feature to set the code number for locking the desired SIRIUS Satellite Radio channels. Refer to “Setting the Parental Lock” on page 54 for details.

Remote control features

In addition to controlling this unit, the remote control can also operate other audiovisual components made by Yamaha and other manufacturers. To control your TV or other components, you must set up the appropriate remote control code for each input source (see page 75).

Controlling this unit, a TV, or other components

Controlling this unit

Press **AMP** to control this unit.

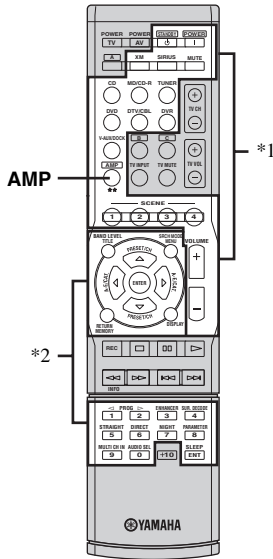

Controlling a TV

Press **DTV/CBL** to control your TV. To control your TV, you must set the appropriate remote control code for DTV/CBL (see page 75).

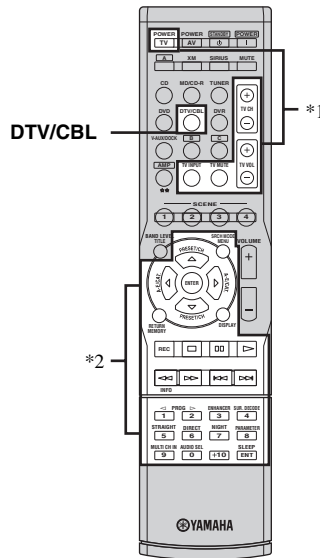

Notes

- *1 These buttons always control this unit.
- *2 These buttons control this unit only when **AMP** is pressed.

Notes

- *1 These buttons always control your TV regardless of whether you press **DTV/CBL** or not.

| Remote control | Digital TV/Cable TV |
|----------------|--|
| TV POWER | Turns on or off the power. |
| TV CH +/- | Changes the channel number. |
| TV VOL +/- | Increases or decreases the volume level. |
| TV INPUT | Changes the input source. |
| TV MUTE | Mutes the audio output. |

- *2 These buttons control your TV only when **DTV/CBL** is pressed. For details, see the “Digital TV/Cable TV” column on page 74.



You can control more than one TV by setting the appropriate remote control code for any input source selector buttons other than **DTV/CBL**. In such a case, you can control the buttons highlighted above (*1 and *2) when you press the input source selector button.

■ Controlling other components

Press one of the input selector buttons (④) or A to C buttons to control other components. You must set the appropriate remote control code for each input source in advance (see page 75). The following table shows the function of each control button used to control other components assigned to each input selector button. Be advised that some buttons may not correctly operate the selected component.



- The remote control has 13 modes (input areas) to control components so that the remote control can operate up to 13 different components.
- When you press one of the optional component control area buttons (A to C), you can control the desired component without changing the input source of this unit.

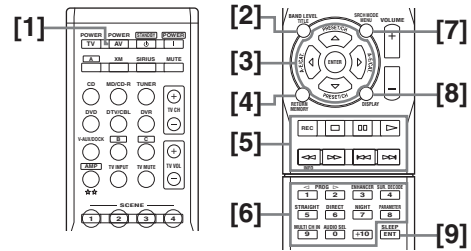

| Remote control | DVD player/ recorder | VCR | Digital TV/ Cable TV | LD player | CD player | MD/CD recorder | Tuner |
|-----------------|--------------------------------------|------------------|-------------------------|-----------------|-----------------|-------------------|-----------------------------------|
| [1] AV POWER | Power *1 | Power *1 | Power *2 | Power *1 | Power *1 | Power *1 | |
| [2] TITLE | Title | | | | | | Band |
| [3] PRESET/CH Δ | Up | VCR channel up | Up | | | | Preset up (1-8)/ Tuning up |
| PRESET/CH ∇ | Down | VCR channel down | Down | | | | Preset down (1-8)/ Tuning down |
| A-E/CAT. < | Left | | Left | | | | Preset down (A-E) |
| A-E/CAT. > | Right | | Right | | | | Preset up (A-E) |
| ENTER | Enter | | Enter | | | | Hold |
| [4] RETURN | Return | | Return | | | | Memory |
| [5] REC | Disc skip (player) Rec (recorder) | Rec | Rec *2 | | Disc skip | Rec | |
| ▷ | Play | Play | Play *2 | Play | Play | Play | |
| ◀◀ | Search backward | Search backward | Search backward *2 | Search backward | Search backward | Search backward | Information |
| ▶▶ | Search forward | Search forward | Search forward *2 | Search forward | Search forward | Search forward | |
| ⏸ | Pause | Pause | Pause *2 | Pause | Pause | Pause | |
| ◀◀◀ | Skip backward | Skip backward | Skip backward *2 | Skip backward | Skip backward | Skip backward | Audio program down |
| ▶▶▶ | Skip forward | Skip forward | Skip forward *2 | Skip forward | Skip forward | Skip forward | Audio program up |
| □ | Stop | Stop | Stop *2 | Stop | Stop | Stop | |
| [6] 1-9, 0, +10 | Numeric buttons | Numeric buttons | Numeric buttons | Numeric buttons | Numeric buttons | Numeric buttons | Preset stations (1-8) |
| [7] MENU | Menu | | Menu | | | | Search mode |
| [8] DISPLAY | Display | Display | Display | Display | Display | Display | Display |
| [9] ENT | Title/Index | Enter | Enter | Chapter/Time | Index | Index | Enter |

Notes

*1 This button is operational only when the original remote control supplied with the component has a POWER button.

*2 These buttons operate your DVD recorder only when you set the appropriate remote control code for DVR (see page 75).

Setting remote control codes

You can control other components by setting the appropriate remote control codes. For a complete list of available remote control codes, refer to “List of remote control codes” at the end of this manual.

Remote control code default settings

| Input source | Component category | Manufacturer | Default code |
|--------------|--------------------|--------------|--------------|
| CD | CD | YAMAHA | 5013 |
| MD/CD-R | CD-R | YAMAHA | 5001 |
| TUNER | TUNER | YAMAHA | 5007 |
| DVD | DVD | YAMAHA | 2000 |
| DTV/CBL | — | — | — |
| V-AUX | TUNER | YAMAHA | 5011 |
| DVR | DVR | YAMAHA | 2011 |
| XM | TUNER | YAMAHA | 5009 |
| SIRIUS | TUNER | YAMAHA | 5017 |
| A | TUNER | YAMAHA | 5012 |
| B | TUNER | YAMAHA | 5009 |
| C | TUNER | YAMAHA | 5017 |

Note

You may not be able to operate your Yamaha component even if a Yamaha remote control code is preset as listed above. In this case, try setting another Yamaha remote control code.

- 1 While pressing and holding one of the input selector buttons (④) on the remote control to select the input area you want to set up, press ② **AV POWER** for more than 3 seconds.

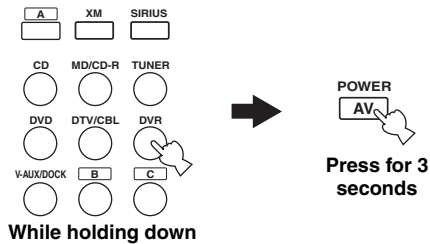

- 2 Press the numeric buttons (0 to 9) (⑰) to enter the four-digit remote control code for the component to be used.

When the setting succeeds, “RemoteSetup OK” appears; however, when it does not, “RemoteSetup NG” appears in the front panel display.

Notes

- If the manufacturer of your component has more than one code, try each of them until you find the correct one.
- If you do not press any buttons within 30 seconds in step 2, the setup process is canceled. If this happens, repeat the setup procedure.

Advanced setup

This unit has additional menus that are displayed in the front panel display. The advanced setup menu offers additional operations to adjust and customize the way this unit operates. Change the initial settings (indicated in bold under each parameter) to reflect the needs of your listening environment.

Notes

- Only **Ⓐ**STANDBY/ON, **Ⓒ**PROGRAM $\triangleleft/\triangleright$, and **Ⓜ**STRAIGHT are effective while you are using the advanced setup menu.
- No other operations can be made while you are using the advanced setup menu.
- The advanced setup menu is only available in the front panel display.

1 Press **ⒶSTANDBY/ON to set this unit to the standby mode.**

2 Press and hold **ⓀTONE CONTROL and then press **Ⓐ**STANDBY/ON to turn on this unit.**

This unit turns on, and the advanced setup menu appears in the front panel display.

3 Press **ⒸPROGRAM $\triangleleft/\triangleright$ to select the parameter you want to adjust.**

The name of the selected parameter appears in the front panel display.

4 Press **ⓂSTRAIGHT repeatedly to change the selected parameter setting.**

5 Press **ⒶSTANDBY/ON to confirm your selection and set this unit to the standby mode.**



The settings you made are reflected next time you turn on this unit.

■ Speaker impedance SP IMP. (U.S.A. and Canada models only)

Use this feature to set the speaker impedance of this unit so that it matches that of your speakers.

Choices: **8Ω MIN**, 6Ω MIN

- Select “8Ω MIN” to set the speaker impedance to 8 Ω.
- Select “6Ω MIN” to set the speaker impedance to 6 Ω.

| SP IMP. | Speaker | Impedance level |
|---------|----------------|--|
| 8Ω MIN | Front (A or B) | The impedance of each speaker must be 8 Ω or higher. |
| | Center | |
| | Surround | |
| 6Ω MIN | Front (A or B) | The impedance of each speaker must be 6 Ω or higher. |
| | Center | |
| | Surround | |

■ SIRIUS Satellite Radio Parental Lock code number reset SSR PIN

Use this feature to set the code number for the SIRIUS Satellite Radio Parental Lock feature to the initial factory setting.

Choices: RESET, **CANCEL**

- Select “RESET” to set the code number to the initial factory setting.
- Select “CANCEL” to set the code number to the initial factory setting.

Note

Even if you set “SSR PIN” to “RESET”, this unit does not unlock the locked channels. The initial factory setting of the Parental Lock code number is “0000”.

■ Tuner frequency step TU (Asia and General models only)

Use this feature to set the tuner frequency step according to the frequency spacing in your area.

Choices: AM10/FM100, **AM9/FM50**

- Select “AM10/FM100” for North, Central and South America.
- Select “AM9/FM50” for all other areas.

■ Initializing INIT.

Use this feature to reset all the parameters of this unit to the initial factory settings (see page 87).

Choices: **CANCEL**, RESET

- Select “CANCEL” not to reset any parameters of this unit.
- Select “RESET” to reset the parameters of this unit.

Notes

- This setting completely resets all the parameters of this unit including the “SET MENU” parameters. However, the advanced setup menu parameters will not be initialized.
- The initial factory settings are activated next time you turn on this unit.

Troubleshooting

Refer to the table below when this unit does not function properly. If the problem you are experiencing is not listed below or if the instruction below does not help, turn off this unit, disconnect the power cable, and contact the nearest authorized Yamaha dealer or service center.

■ General

| Problem | Cause | Remedy | See page |
|---|--|---|----------|
| This unit fails to turn on or enters the standby mode soon after the power is turned on. | The power cable is not connected or the plug is not completely inserted. | Connect the power cable firmly. | — |
| | The speaker impedance setting is incorrect. | Set the speaker impedance to match your speakers. | 21 |
| | The protection circuitry has been activated. | Make sure that all speaker wire connections on this unit and on all speakers are secure and that the wire for each connection does not touch anything other than its respective connection. | 11 |
| | This unit has been exposed to a strong external electric shock (such as lightning or strong static electricity). | Set this unit to the standby mode, disconnect the power cable, plug it back in after 30 seconds and then use it normally. | — |
| No sound. | Incorrect input or output cable connections. | Connect the cables properly. If the problem persists, the cables may be defective. | 13-18 |
| | No appropriate Audio input jack select has been set. | Set an appropriate Audio input jack select. | 34 |
| | Audio input jack select is set to “HDMI”, “COAX/OPT” or “ANALOG”. | Set Audio input jack select to “AUTO”. | 34 |
| | Audio input jack select is set to “ANALOG” while playing a source encoded in Dolby Digital or DTS. | Set Audio input jack select to “AUTO” or “COAX/OPT”. | 34 |
| | No appropriate input source has been selected. | Select an appropriate input source with ⓈINPUT </> (or the input selector buttons(④)). | 33 |
| | Speaker connections are not secure. | Secure the connections. | 11 |
| | The front speakers to be used have not been selected properly. | Select the front speakers with ⓈSPEAKERS . | 33 |
| | The volume is turned down. | Turn up the volume. | — |
| | The sound is muted. | Press ⓈMUTE or ⓈVOLUME +/- to resume audio output and then adjust the volume. | 35 |
| | Signals this unit cannot reproduce are being input from a source component, such as a CD-ROM. | Play a source whose signals can be reproduced by this unit. | — |
| | The HDMI components connected to this unit do not support the HDCP copy protection standards. | Connect HDMI components that support the HDCP copy protection standards. | 14 |
| | “SUPPORT AUDIO” is set to “Other” and “HDMI” audio signals are not being played back on this unit. | Set “SUPPORT AUDIO” to “RX-V463” in “MANUAL SETUP”. | 67 |

| Problem | Cause | Remedy | See page |
|---|--|---|----------|
| The sound suddenly goes off. | The protection circuitry has been activated because of a short circuit, etc. | Check that the impedance setting is correct. | 21 |
| | | Check that the speaker wires are not touching each other and then turn this unit back on. | — |
| | The sleep timer has turned off this unit. | Turn on this unit, and play the source again. | — |
| | The sound is muted. | Press MUTE or VOLUME +/- to resume audio output. | 35 |
| Sound is heard from the speaker on one side only. | Incorrect cable connections. | Connect the cables properly. If the problem persists, the cables may be defective. | 11-18 |
| | Incorrect settings in “SP LEVEL”. | Adjust the “SP LEVEL” settings. | 41 |
| Only the center speaker outputs substantial sound. | When playing a monaural source with a CINEMA DSP program, the source signal is directed to the center channel, and the front and surround speakers output effect sounds. | This is not malfunction. | — |
| No sound is heard from the center speaker. | “CENTER SP” in “SPEAKER SET” is set to “NONE”. | Set “CENTER SP” to “SML” or “LRG”. | 63 |
| | Some sound field programs do not output sounds from the center speaker. | Try another sound field program. | 38 |
| No sound is heard from the surround speakers. | “SUR. L/R SP” in “SPEAKER SET” is set to “NONE”. | Set “SUR. L/R SP” to “SML” or “LRG”. | 64 |
| | This unit is in the “STRAIGHT” mode and a monaural source is being played back. | Press STRAIGHT so that “STRAIGHT” disappears from the front panel display. | 39 |
| No sound from the center, surround speakers when the FRONT B speakers are activated. | “FRONT B” in “SPEAKER SET” is set to “ZONE B”. | Set “FRONT B” to “FRONT”. | 63 |
| No sound is heard from the subwoofer. | “LFE/BASS OUT” in “SPEAKER SET” is set to “FRNT” when a Dolby Digital or DTS signal is being played. | Set “LFE/BASS OUT” to “SWFR” or “BOTH”. | 64 |
| | “LFE/BASS OUT” in “SPEAKER SET” is set to “SWFR” or “FRNT” when a 2-channel source is being played. | Set “LFE/BASS OUT” to “SWFR” or “BOTH”. | 64 |
| | The source does not contain low-frequency bass signals. | This is not malfunction. | — |

| Problem | Cause | Remedy | See page |
|--|---|--|-----------------|
| Dolby Digital or DTS sources cannot be played. (Dolby Digital or DTS indicator in the front panel display does not light up.) | The connected component is not set to output Dolby Digital or DTS digital signals. | Make an appropriate setting following the operating instructions for your component. | — |
| | Audio input jack select is set to “ANALOG”. | Set Audio input jack select to “AUTO”. | 34 |
| A humming sound is heard. | Incorrect cable connections. | Connect the audio cables firmly. If the problem persists, the cables may be defective. | — |
| The volume level cannot be increased, or the sound is distorted. | You are attempting to set the volume level higher than the maximum volume level. | Adjust “MAX VOL.” setting. | 67 |
| | The component connected to the AUDIO OUT (REC) jacks of this unit is turned off. | Turn on the power of the component. | — |
| The sound effect cannot be recorded. | It is not possible to record the sound effect with a recording component. | This is not malfunction. | — |
| A source cannot be recorded by an analog component connected to the AUDIO OUT (REC) jacks. | The source component is not connected to the analog AUDIO IN jacks of this unit. | Connect the source component to the analog AUDIO IN jacks. | 14, 18 |
| The sound field parameters and some other settings of this unit cannot be changed. | “MEMORY GUARD” in “OPTION MENU” is set to “ON”. | Set “MEMORY GUARD” to “OFF”. | 70 |
| This unit does not operate properly. | The internal microcomputer has been frozen by an external electric shock (such as lightning or excessive static electricity) or by a power supply with low voltage. | Disconnect the power cable from the AC wall outlet and then plug it in again after about 30 seconds. | — |
| No sound is heard from the connected HDMI component. | The HDMI component does not accept the multi-channel audio signals. | Convert the multi-channel audio signals to the 2-channel audio signals at the source component such as a DVD player. | — |
| “CHECK SP WIRES” appears in the front panel display. | Speaker cables are short-circuited. | Make sure all speaker cables are connected correctly. | 11 |
| There is noise interference from digital or radio frequency equipment. | This unit is too close to the digital or high-frequency equipment. | Move this unit further away from such equipment. | — |
| The picture is disturbed. | The video source uses scrambled or encoded signals to prevent dubbing. | This is not malfunction. | — |
| This unit suddenly enters the standby mode. | The internal temperature is too high and the overheat protection circuitry has been activated. | Wait about 1 hour for this unit to cool down and then turn it back on. | — |

■ Tuner

| | Problem | Cause | Remedy | See page |
|----|---|---|--|----------|
| FM | FM stereo reception is noisy. | The characteristics of FM stereo broadcasts may cause this problem when the transmitter is too far away or the antenna input is poor. | Check the antenna connections. | 20 |
| | | | Try using a high-quality directional FM antenna. | — |
| | | | Use the manual tuning method. | 43 |
| | There is distortion, and clear reception cannot be obtained even with a good FM antenna. | There is multi-path interference. | Adjust the antenna position to eliminate multi-path interference. | — |
| | The desired station cannot be tuned into with the automatic tuning method. | The signal is too weak. | Use a high-quality directional FM antenna. | — |
| | | | Use the manual tuning method. | 43 |
| | Previously preset stations can no longer be tuned into. | This unit has been disconnected for a long period. | Set preset stations. | 44 |
| AM | The desired station cannot be tuned into with the automatic tuning method. | The signal is weak or the antenna connections are loose. | Tighten the AM loop antenna connections and orient it for the best reception. | — |
| | | | Use the manual tuning method. | 43 |
| | There are continuous crackling and hissing noises. | Noise can result from lightning, fluorescent lamps, motors, thermostats and other electrical equipment. | Use an outdoor antenna and a ground wire. This will help somewhat, but it is difficult to eliminate all noise. | — |
| | There are buzzing and whining noises. | A TV set is being used nearby. | Move this unit away from the TV set. | — |

■ XM Satellite Radio

If an operation takes longer than usual or an error occurs, one of the following messages may appear in the front panel display. In this case, read the cause and follow the corresponding remedies.

| Status message | Cause | Remedy | See page |
|----------------|---|--|----------|
| CHECK XM TUNER | The XM Mini-Tuner is not installed in the XM Mini-Tuner Dock or the XM Mini-Tuner Dock is not connected to this unit. | Confirm the XM Mini-Tuner is fully seated in the dock and check the XM Mini-Tuner Dock cable is connected to this unit. | 46 |
| CHECK ANTENNA | The XM antenna is not connected to the XM Mini-Tuner Dock or the XM antenna cable has become damaged. | Check that the XM antenna is securely connected to the XM Mini-Tuner Dock and check the antenna cable for damage. Replace the XM antenna if the cable is damaged. | 46 |
| CH UNAUTH | You may be attempting to tune to an XM channel that is blocked or that you cannot receive with your XM subscription package. | Consult the latest channel guide at http://www.xmradio.com/ (US residents) and http://www.xmradio.ca/ (Canadian residents) for the current list of channels. For information on receiving this channel, visit http://www.xmradio.com/ (US residents) and http://www.xmradio.ca/ (Canadian residents) or contact XM Satellite Radio at 1-800-967-2346 (US residents) and 1-877-GET XMSR (Canadian residents). | 47 |
| NO SIGNAL | The XM Mini-Tuner is not receiving the XM satellite signal. Something may be blocking the XM antenna's view of the satellites or the antenna is not properly aimed. | Check for antenna obstructions and reposition the XM antenna to get better signal reception. Use the "XM RADIO SET" screen in the video monitor to check the antenna reception level. See instructions supplied with the XM Mini-Tuner and Dock for antenna installation information. | 46,72 |
| LOADING | The XM Mini-Tuner is acquiring audio or program information from the XM satellite signal. This message can also occur in weak XM signal conditions. Note that this unit may not respond to some operations while this message is displayed. | This message should disappear in a few seconds in good signal conditions. If you see this message often, reposition the XM antenna to get better signal reception. Use the "XM RADIO SET" screen in the video monitor to check the antenna reception level. | 72 |
| OFF AIR | The XM channel you selected is not currently broadcasting. | Check back at a later time; in the mean time, select another channel. | — |
| CH UNAVAILABLE | The selected channel is not available. The channel may have been reassigned to a different channel number. This message may occur initially with a new XM Mini-Tuner or a XM Mini-Tuner that has not received XM's signal for an extended period. | Consult the latest channel guide at http://www.xmradio.com/ (US residents) and http://www.xmradio.ca/ (Canadian residents) for the current list of channels. For cases of a new XM Mini-Tuner or a XM Mini-Tuner that has not received XM's signal for an extended period, allow the XM Mini-Tuner to receive the XM satellite signal for at least 5 minutes and then try to select the channel again. | — |
| -- -- -- | No artist name or song title is available for this selection. | No action required. | — |

■ SIRIUS Satellite Radio

If an operation takes longer than usual or an error occurs, one of the following messages may appear in the front panel display. In this case, read the cause and follow the corresponding remedies.

| Status message | Cause | Remedy | See page |
|---|---|---|----------|
| ANTENNA ERROR | The antenna is not connected to the SiriusConnect tuner properly. | Check the connection of the antenna and SiriusConnect tuner. | 51 |
| CHECK SR TUNER | The SiriusConnect tuner is not connected to the SIRIUS jack of this unit correctly. | Check the connection of the SiriusConnect tuner and this unit. | 51 |
| | The SiriusConnect tuner is not connected to the AC wall outlet. | Connect the power cable of the SiriusConnect tuner to the AC wall outlet. | 51 |
| NOT SUPPORTED | This unit does not support the connected SIRIUS Satellite Radio tuner. | Connect the SiriusConnect tuner that this unit supports, | 51 |
| ACQUIRING | The signal is too weak. | Adjust the orientation of the antenna of the SiriusConnect tuner. Use the “ANTENNA INFO” information in the front panel display or “SIRIUS Information” screen in the video monitor to check the antenna reception level. | 51, 56 |
| UPDATING | The SiriusConnect tuner is updating the channel list. | Wait until the updating is complete. | — |
| | The period of the subscription is end. | Contact SIRIUS Satellite Radio to renew the subscription. | 52 |
| F/W UPDATING | The SiriusConnect tuner is updating the firmware. | Wait until the updating is complete. | — |
| CALL SIRIUS (CALL 888-539-SIRIUS TO SUBSCRIBE) | The selected channel is not subscribed. | Contact SIRIUS Satellite Radio to subscribe the selected channel. URL: https://activate.siriusradio.com/ Phone: 1-888-539-SIRIUS (1-888-539-7474) | 52 |
| | | Select another channel. | 52 |
| SUB UPDATED | The subscription information is updated. | | |
| INVALID | The selected channel is currently out of service. | Select another channel. | 52 |
| Not Available | The operation you made is not available. | | |

■ AUTO SETUP

Before AUTO SETUP

| Error message | Cause | Remedy | See page |
|---------------|--|---|----------|
| Connect MIC! | Optimizer microphone is not connected. | Connect the supplied optimizer microphone to the OPTIMIZER MIC jack on the front panel. | 24 |
| Unplug HP! | Headphones are connected. | Unplug the headphones. | — |

During AUTO SETUP

| Error message | Cause | Remedy | See page |
|--------------------|---|--|------------|
| E-1:NO FRONT SP | Front L/R channel signals are not detected. | Check the front L/R speaker connections. | 11 |
| E-2:NO SUR.SP | A surround channel signal is not detected. | Check the surround speaker connections. | 11 |
| E-4:NOISY | Background noise is too loud. | Try running "AUTO SETUP" in a quiet environment. | — |
| | | Turn off noisy electric equipment like air conditioners or move them away from the optimizer microphone. | — |
| E-6:NO MIC | The optimizer microphone was unplugged during the "AUTO SETUP" procedure. | Connect the supplied optimizer microphone to OPTIMIZER MIC jack on the front panel. | 24 |
| E-7:NO SIGNAL | The optimizer microphone does not detect test tones. | Check the microphone setting. | 24 |
| | | Check the speaker connections and placement. | 10, 11, 24 |
| E-8:USER CANCEL | The "AUTO SETUP" procedure was cancelled due to user activity. | Run "AUTO SETUP" again. | 24 |
| E-9:INTERNAL ERROR | An internal error occurred. | Run "AUTO SETUP" again. | 24 |

After AUTO SETUP

| Warning message | Cause | Remedy | See page |
|---------------------|--|--|----------|
| W-1:OUT OF PHASE | Speaker polarity is not correct. This message may appear depending on the speakers even when the speakers are connected correctly. | Check the speaker connections for proper polarity (+ or -). | 12 |
| W-2:OVER 24m (80ft) | The distance between the nearest speaker and the furthest speaker is out of adjustable range. | Bring the speaker closer to the listening position. | — |
| W-3:LEVEL ERROR | The difference of volume level among speakers is excessive. (No level correction is made.) | If “SWFR:TOO LOUD” or “SWFR:TOO LOW” appears, adjust the output volume of the subwoofer. | 24, 65 |
| | | Readjust the speaker installation so that all speakers are set in locations with similar conditions. | — |
| | | Check the speaker connections. | 11 |
| | | Use speakers of similar quality. | — |

Notes

- If the “ERROR” or “WARNING” screens appears, check the cause of the problem, then run “AUTO SETUP” again.
- If a warning message “W-1”, “W-2”, or “W-3” appears, corrections are made, but they may not be optimal.
- If an error message “E-9” occurs repeatedly, please contact a qualified Yamaha service center.

■ iPod

Note

In case of a transmission error without a status message appearing in the front panel and in the OSD, check the connection to your iPod (see page 19).

| Status message | Cause | Remedy | See page |
|----------------|--|--|----------|
| Loading... | This unit is in the middle of recognizing the connection with your iPod. | | |
| | This unit is in the middle of acquiring song lists from your iPod. | | |
| Connect error | There is a problem with the signal path from your iPod to this unit. | Turn off this unit and reconnect the Yamaha iPod universal dock to the DOCK terminal of this unit. Try resetting your iPod. | 19 — |
| Unknown iPod | The iPod being used is not supported by this unit. | Only iPod (Click and Wheel), iPod nano, and iPod mini are supported. | — |
| iPod connected | Your iPod is properly stationed in a Yamaha iPod universal dock (YDS-10, sold separately) connected to the DOCK terminal of this unit, and the connection between your iPod and this unit is complete. | | |
| Disconnected | Your iPod was removed from a Yamaha iPod universal dock (YDS-10, sold separately) connected to the DOCK terminal of this unit. | Station your iPod back in a Yamaha iPod universal dock (YDS-10, sold separately) connected to the DOCK terminal of this unit. | 19 |
| Unable to play | This unit cannot play back the songs currently stored on your iPod. | Check that the songs currently stored on your iPod are playable. | — |
| | | Store some other playable music files on your iPod. | — |

■ Bluetooth

| Status message | Cause | Remedy | See page |
|----------------|---|--|----------|
| Searching... | The Bluetooth adapter and the Bluetooth component is in the middle of the pairing. | | |
| | The Bluetooth adapter and the Bluetooth component is in the middle of establishing the connection. | | |
| Completed | The pairing is completed. | | |
| Canceled | The pairing is canceled. | | |
| BT connected | The connection between the Yamaha Bluetooth adapter (such as YBA-10, sold separately) and the Bluetooth component is established. | | |
| Disconnected | The Bluetooth component is disconnected from the Yamaha Bluetooth adapter (such as YBA-10, sold separately). | | |
| No BT Adapter | The Bluetooth adapter is not connected to the DOCK terminal. | Connect the Yamaha Bluetooth adapter (such as YBA-10, sold separately) to the DOCK terminal. | 19 |

■ Remote control

| Problem | Cause | Remedy | See page |
|--|---|---|----------|
| The remote control does not work nor function properly. | Wrong distance or angle. | The remote control functions within a maximum range of 6 m (20 ft) and no more than 30 degrees off-axis from the front panel. | 23 |
| | Direct sunlight or lighting (from an inverter type of fluorescent lamp, etc.) is striking the remote control sensor of this unit. | Reposition this unit. | — |
| | The batteries are weak. | Replace all batteries. | 3 |
| | The remote control code is not correctly set. | Set the remote control code correctly using “List of remote control codes” at the end of this manual. | 75 |
| | | Try setting another code for the same manufacturer using “List of remote control codes” at the end of this manual. | 75 |
| Even if the remote control code is correctly set, there are some models that do not respond to the remote control. | | | |

■ Resetting the system

Use this feature to reset all the parameters of this unit to the initial factory settings.

1 Press  STANDBY/ON on the front panel to set this unit to the standby mode.

2 Press and hold  TONE CONTROL and then press  STANDBY/ON to turn on this unit.

The advanced setup menu appears in the front panel display.

3 Press  PROGRAM  /  to select “INIT.”.

4 Press  STRAIGHT repeatedly to select “RESET”.



Select “CANCEL” to cancel the initialization procedure without making any changes.

5 Press  STANDBY/ON to confirm your selection and set this unit to the standby mode.

Notes

- This procedure completely resets all the parameters of this unit including the “SET MENU” parameters. However, the advanced setup menu parameters will not be initialized.
- The initial factory settings are activated next time you turn on this unit.



To cancel the initialization procedure at any time without making any changes, press  STRAIGHT repeatedly to select “CANCEL” and then press  STANDBY/ON.

Glossary

■ CINEMA DSP

Since the Dolby Surround and DTS systems were originally designed for use in movie theaters, their effect is best felt in a theater having many speakers designed for acoustic effects. Since home conditions, such as room size, wall material, number of speakers, and so on, can differ so widely, it is inevitable that there are differences in the sound heard. Based on a wealth of actually measured data, Yamaha CINEMA DSP uses Yamaha original sound field technology to combine Dolby Pro Logic, Dolby Digital and DTS systems to provide the audiovisual experience of a movie theater in the listening room of your own home.

■ Component video signal

With the component video signal system, the video signal is separated into the Y signal for the luminance and the P_B and P_R signals for the chrominance. Color can be reproduced more faithfully with this system because each of these signals is independent. The component signal is also called the “color difference signal” because the luminance signal is subtracted from the color signal. A monitor with component input jacks is required in order to output component signals.

■ Composite video signal

With the composite video signal system, the video signal is composed of three basic elements of a video picture: color, brightness and synchronization data. A composite video jack on a video component transmits these three elements combined.

■ Dolby Digital

Dolby Digital is a digital surround sound system that gives you completely independent multi-channel audio. With 3 front channels (front L/R and center), and 2 surround stereo channels, Dolby Digital provides 5 full-range audio channels. With an additional channel especially for bass effects, called LFE (Low Frequency Effect), the system has a total of 5.1-channels (LFE is counted as 0.1 channel). By using 2-channel stereo for the surround speakers, more accurate moving sound effects and surround sound environment are possible than with Dolby Surround. The wide dynamic range from maximum to minimum volume reproduced by the 5 full-range channels and the precise sound orientation generated using digital sound processing provide listeners with unprecedented excitement and realism. With this unit, any sound environment from monaural up to a 5.1-channel configuration can be freely selected for your enjoyment.

■ Dolby Pro Logic II

Dolby Pro Logic II is an improved technique used to decode vast numbers of existing Dolby Surround sources. This new technology enables a discrete 5-channel playback with 2 front left and right channels, 1 center channel, and 2 surround left and right channels instead of only 1 surround channel for conventional Pro Logic technology. There are three modes available: “Music mode” for music sources, “Movie mode” for movie sources and “Game mode” for game sources.

■ Dolby Surround

Dolby Surround uses a 4-channel analog recording system to reproduce realistic and dynamic sound effects: 2 front left and right channels (stereo), a center channel for dialog (monaural), and a surround channel for special sound effects (monaural). The surround channel reproduces sound within a narrow frequency range. Dolby Surround is widely used with nearly all video tapes and laser discs, and in many TV and cable broadcasts as well. The Dolby Pro Logic decoder built into this unit employs a digital signal processing system that automatically stabilizes the volume on each channel to enhance moving sound effects and directionality.

■ DTS Digital Surround

DTS digital surround was developed to replace the analog soundtracks of movies with a 5.1-channel digital sound track, and is now rapidly gaining popularity in movie theaters around the world. DTS, Inc. has developed a home theater system so that you can enjoy the depth of sound and natural spatial representation of DTS digital surround in your home. This system produces practically distortion-free 5.1-channel sound (technically, left, right and center channels, 2 surround channels, plus an LFE 0.1 channel as a subwoofer, for a total of 5.1-channels).

■ HDMI

HDMI (High-Definition Multimedia Interface) is the first industry-supported, uncompressed, all-digital audio/video interface. Providing an interface between any source (such as a set-top box or AV receiver) and an audio/video monitor (such as a digital television), HDMI supports standard, enhanced or high-definition video as well as multi-channel digital audio using a single cable. HDMI transmits all ATSC HDTV standards and supports 8-channel digital audio, with bandwidth to spare to accommodate future enhancements and requirements. When used in combination with HDCP (High-bandwidth Digital Content Protection), HDMI provides a secure audio/video interface that meets the security requirements of content providers and system operators. For further information on HDMI, visit the HDMI website at "<http://www.hdmi.org/>".

■ LFE 0.1 channel

This channel reproduces low-frequency signals. The frequency range of this channel is from 20 Hz to 120 Hz. This channel is counted as 0.1 because it only enforces a low-frequency range compared to the full-range reproduced by the other 5 channels in Dolby Digital or DTS 5.1-channel systems.

■ Neural Surround

Neural Surround™ represents the latest advancement in surround technology and has been adopted by XM Satellite Radio for digital radio broadcast of surround recordings and live events in surround sound. Neural Surround™ employs psychoacoustic frequency domain processing which allows delivery of a more detailed sound stage with superior channel separation and localization of audio elements.

■ PCM (Linear PCM)

Linear PCM is a signal format under which an analog audio signal is digitized, recorded and transmitted without using any compression. This is used as a method of recording CDs and DVD audio. The PCM system uses a technique for sampling the size of the analog signal per very small unit of time. Standing for "Pulse Code Modulation", the analog signal is encoded as pulses and then modulated for recording.

■ Sampling frequency and number of quantized bits

When digitizing an analog audio signal, the number of times the signal is sampled per second is called the sampling frequency, while the degree of fineness when converting the sound level into a numeric value is called the number of quantized bits. The range of rates that can be played back is determined based on the sampling rate, while the dynamic range representing the sound level difference is determined by the number of quantized bits. In principle, the higher the sampling frequency, the wider the range of frequencies that can be played back, and the higher the number of quantized bits, the more finely the sound level can be reproduced.

■ SILENT CINEMA

Yamaha has developed a natural, realistic sound effect DSP algorithm for headphones. Parameters for headphones have been set for each sound field so that accurate representations of all the sound field programs can be enjoyed on headphones.

■ Virtual CINEMA DSP

Yamaha has developed a Virtual CINEMA DSP algorithm that allows you to enjoy DSP sound field surround effects even without any surround speakers by using virtual surround speakers. It is even possible to enjoy Virtual CINEMA DSP using a minimal two-speaker system that does not include a center speaker.

Specifications

AUDIO SECTION

- Minimum RMS Output Power for Front, Center, Surround
[U.S.A. and Canada models]
1 kHz, 0.9% THD, 8 Ω 105 W
[Other models]
1 kHz, 0.9% THD, 6 Ω 105 W
- Maximum Power for Front, Center, Surround (JEITA)
1 kHz, 10% THD, 6 Ω 130 W
- Dynamic Power
[U.S.A. and Canada models]
(IHF, 8/6/4/2 Ω) 90/110/130/150 W
[Other models]
(IHF, 6/4/2 Ω) 100/110/125 W
- Dynamic Headroom [U.S.A. and Canada models]
8 Ω 0.27 dB
- Maximum Input Signal
CD, etc. Effect On, 1 kHz, 0.5% THD 2.0 V or more
- Frequency Response
CD, etc. to Front L/R 10 Hz to 100 kHz, -3 dB
- Total Harmonic Distortion
[U.S.A. and Canada models]
(1 kHz, 45 W, Front L/R, 8 Ω) 0.06% or less
[Other models]
(1 kHz, 50 W, Front L/R, 6 Ω) 0.06% or less
- Signal to Noise Ratio (IHF-A Network)
CD (200 mV) to Front L/R, Effect Off 98 dB or more
CD (250 mV) to Front L/R, Effect Off 100 dB or more
- Residual Noise (IHF-A Network)
Front L/R 150 μV or less
- Channel Separation (1 kHz/10 kHz)
CD, etc. (5.1 kΩ shorted) to Front L/R
..... 60 dB/45 dB or more
- Tone Control (Front L/R)
BASS Boost/Cut ±10 dB/100 Hz
TREBLE Boost/Cut ±10 dB/20 kHz
- Headphone Jack Rated Output/Impedance 400 mV/470 Ω
- Input Sensitivity/Input Impedance
CD, etc. 200 mV/47 kΩ
MULTI CH INPUT 200 mV/47 kΩ
- Output Level/Output Impedance
AUDIO OUT (REC) 200 mV/1.2 kΩ
SUBWOOFER OUTPUT 4 V/1.2 kΩ
- Filter Characteristics (fc=40/60/80/90/100/110/120/160/200 Hz)
H.P.F.
(FRONT SP, CENTER SP, SUR. L/R SP:
SMALL/SML) 12 dB/oct.
L.P.F. (Subwoofer) 24 dB/oct.

VIDEO SECTION

- Video Signal Type (Gray back)
[U.S.A., Canada, Korea and General models] NTSC
[Other models] PAL

- Signal Level
Composite 1 Vp-p/75 Ω
Component 1 Vp-p/75 Ω (Y), 0.7 Vp-p/75 Ω (Pb/Pk)
- Signal to Noise Ratio 50 dB or more
- Maximum Input Level 1.5 Vp-p or more
- Frequency Response (MONITOR OUT)
Component Signal 5 Hz to 60 MHz, -3 dB

FM SECTION

- Tuning Range
[U.S.A. and Canada models] 87.5 to 107.9 MHz
[Asia and General models] 87.5/87.50 to 108.0/108.00 MHz
[Other models] 87.50 to 108.00 MHz
- 50 dB Quieting Sensitivity (IHF, 100% mod.)
Mono 2.8 μV (20.2 dBf)
- Signal to Noise Ratio (IHF)
Mono/Stereo 73 dB/70 dB
- Harmonic Distortion (1 kHz)
Mono/Stereo 0.5%/0.5%
- Antenna Input (unbalanced) 75 Ω

AM SECTION

- Tuning Range
[U.S.A. and Canada models] 530 to 1710 kHz
[Asia and General models] 530/531 to 1710/1611 kHz
[Other models] 531 to 1611 kHz

GENERAL

- Power Supply
[Europe and Russia models] 230 V AC, 50 Hz
[U.S.A. and Canada models] 120 V AC, 60 Hz
[Australia model] 240 V AC, 50 Hz
[Korea model] 220 V AC, 60 Hz
[China model] 220 V AC, 50 Hz
[Asia model] 220-240 V AC, 50/60 Hz
[General model] 110-120/220-240 V AC, 50/60 Hz
- Power Consumption
[U.S.A. and Canada models] 240 W/320 VA
[General model] 260 W
[Other models] 240 W
- Standby Power Consumption 0.8 W
- Maximum Power Consumption [Asia and General models only]
5ch, 10% THD 440 W
- AC Outlets
[Australia model] 1 (100 W maximum)
[U.S.A., Canada and China models]... 2 (Total 100 W maximum)
[Other models] 2 (Total 50 W maximum)
- Dimensions (W x H x D) 435 x 151 x 352 mm
(17-1/8" x 5-15/16" x 13-7/8")
- Weight 8.5 kg (18 lbs 12 oz)

* Specifications are subject to change without notice.

Index

■ Symbols

- <XM> ---, XM tuning status message 82

■ Numerics

- 1 SOUND MENU, Manual setup 61
- 2 INPUT MENU, Manual setup 61
- 2ch Stereo, Sound field program 38
- 3 OPTION MENU 70
- 3 OPTION MENU, Manual setup 62
- 5ch Stereo, Sound field program 38

■ A

- A)DISPLAY SET, Option menu 70
- A)INPUT ASSIGNMENT, Input menu 68
- A)SPEAKER SET, Sound menu 63
- A.DELAY, Audio settings 66
- ACQUIRING, SIRIUS Satellite Radio status message 83
- Activating XM Satellite Radio 47
- ALL CH SEARCH, XM tuning 53
- All Channel Search mode, XM tuning 48, 53
- AM antenna connection 20
- AM tuning 43
- Amplifier function OSD display time, Display settings 70
- ANTENNA ERROR, SIRIUS Satellite Radio status message 83
- Audio components, Connection 18
- Audio delay, Audio settings 66
- Audio information 36
- Audio input jacks selection 34
- AUDIO jacks 13
- Audio jacks 13
- AUDIO SELECT 34
- Audio select, Option menu 71
- Audio settings, Sound menu 66
- Audio signal flow 14
- AUTO SETUP 24
- AUTO SETUP, Error message 84
- Automatic preset tuning, FM/AM tuning 44
- Automatic tuning, FM/AM tuning 43

■ B

- B)INPUT RENAME, Input menu 68
- B)MEMORY GUARD, Option menu 70
- B)SPEAKER LEVEL, Sound menu 65
- Background Video, Multi channel input setup 69
- BGV, Multi channel input setup 69
- Bluetooth setting, Option menu 71
- BT connected, Bluetooth status message 86

■ C

- C)AUDIO SELECT, Option menu 71

- C)SP DISTANCE, Sound menu 65
- C)VOLUME TRIM, Input menu 69
- CALL SIRIUS, SIRIUS Satellite Radio status message 83
- Canceled, Troubleshooting 86
- CAT SEARCH, XM tuning 53
- Category Search mode, XM tuning 48
- CD player, Connection 18
- CD recorder, Connection 18
- CENTER SP, Speaker settings 63
- Center speaker equalizer, Sound menu 66
- Center speaker, Speaker settings 63
- Center width, Sound field parameter ... 40
- CHECK ANTENNA, XM tuning status message 82
- CHECK SR TUNER, SIRIUS Satellite Radio status message 83
- CINEMA DSP indicator 23
- COAXIAL IN (1), Input assignment ... 68
- COAXIAL INPUT assignment, Input assignment 68
- COAXIAL INPUT jacks 68
- Completed, Bluetooth status message .. 86
- COMPONENT VIDEO jacks 13
- Connect error, iPod controlling status message 85
- Connect MIC!, Auto setup error message 84
- Connecting to the FRONT A terminals 12
- Connection, AM antenna connection ... 20
- Connection, Audio components 18
- Connection, CD player 18
- Connection, CD recorder 18
- Connection, DVD player 16
- Connection, DVD recorder 17
- Connection, external decoder 18
- Connection, FM antenna 20
- Connection, HDMI 14
- Connection, MD recorder 18
- Connection, Multi-format player 18
- Connection, Power cable 20
- Connection, PVR 17
- Connection, set-top boxes 17
- Connection, VCR 17
- Connection, Video components 15
- Connection, Yamaha iPod universal dock 19
- Controlling a TV 73
- Controlling other components, Remote control 74
- Controlling this unit, Remote control ... 73
- Creating original SCENE templates 31
- CROSSOVER, Speaker settings 64
- Crossover, Speaker settings 64
- CT WIDTH, Sound field parameter 40
- Current status display 35

■ D

- D)CENTER GEQ, Sound menu 66
- D)DECODER MODE, Input menu 69
- D)PARAM. INI, Option menu 71
- Decoder indicators 22
- Decoder mode, Input menu 69
- Decoder select mode, Decoder mode .. 69
- DIGITAL AUDIO COAXIAL jacks ... 13
- DIGITAL AUDIO OPTICAL jacks 13
- DIMENSION, Sound field parameter 40
- Dimension, Sound field parameter 40
- DIMMER, Display settings 70
- Dimmer, Display settings 70
- DIRECT 41
- Direct Number Access mode, XM tuning 48
- Direct number access mode, XM tuning 53
- Disconnected, Bluetooth status message 86
- Disconnected, iPod controlling status message 85
- Display settings, Option menu 70
- Displaying the XM Satellite Radio information 50
- DIST 26
- DIST, Auto setup result 26
- DISTANCE 25
- DISTANCE, Auto setup 25
- DOCK indicator 22
- DSP LEVEL, Sound field parameter 40
- DSP level, Sound field parameter 40
- DTS decoder prioritize setting, Decoder mode 69
- DVD player connection 16
- DVD recorder connection 17
- Dynamic range, Sound menu 66

■ E

- E)LFE LEVEL, Sound menu 66
- E)MULTI CH SET, Input menu 69
- E)XM RADIO SET, Option menu 71, 72
- E-1:NO FRONT SP, Auto setup error message 84
- E-2:NO SURR.SP, Auto setup error message 84
- E-4:NOISY, Auto setup error message 84
- E-6:NO MIC, Auto setup error message 84
- E-7:NO SIGNAL, Auto setup error message 84
- E-8:USER CANCEL, Auto setup error message 84
- E-9:INTERNAL ERROR, Auto setup error message 84
- Effect level, Sound field parameter 40

- ENHANCER indicator 22
Exchange, Preset station,
FM/AM tuning 45
External decoder connection 18
- **F**
F)DYNAMIC RANGE,
Sound menu 66
F)XM RADIO SET 72
F/W UPDATING, SIRIUS Satellite Radio
status message 83
Factory presets, Advanced setup 77
FL SCROLL, Display settings 70
FM antenna 20
FM antenna connection 20
FM tuning 43
FRONT B speaker setting,
Speaker settings 63
FRONT B, Speaker settings 63
Front panel display 22
Front panel display scroll,
Display settings 70
FRONT SP, Speaker settings 63
Front speakers, Speaker settings 63
- **G**
G)AUDIO SET, Sound menu 66
G)SIRIUS SET 72
G)SIRIUS SET, Option menu 72
Games, Sound field program 38
- **H**
H) HDMI SET, Sound menu 67
Hall, Sound field program 38
HDMI indicator 22
HDMI set, Sound menu 67
HDMI, Connection 14
HEADPHONE, Dynamic range 66
Headphone, Dynamic range 66
HEADPHONE,
Low-frequency effect level 66
Headphone,
Low-frequency effect level 66
Headphones 35
Headphones indicator 22
- **I**
Infrared window, Remote control 23
INI.VOL., Audio settings 67
Initial volume, Audio settings 67
Input assignment, Input menu 68
Input channel and speaker indicators ... 23
Input channel indicators 23
Input menu, Manual setup 61
Input rename, Input menu 68
Input source indicators 22
Input source information display 36
INVALID, SIRIUS Satellite Radio
status message 83
iPod connected, iPod controlling status
message 85
iPod control, Status message 85
iPod using 57
- **J**
Jazz, Sound field program 38
- **L**
LFE/BASS OUT, Speaker settings 64
LFE/Bass out, Speaker settings 64
LOADING,
XM tuning status message 82
Loading...,
iPod controlling status message 85
Low-frequency effect level,
Sound menu 66
LVL 26
LVL, Auto setup result 26
- **M**
Manual preset tuning,
FM/AM tuning 44
MANUAL SETUP, SET MENU 61
Manual setup, SET MENU 61
Manual tuning, FM/AM tuning 43
MAX VOL., Audio settings 67
Maximum volume, Audio settings 67
MD recorder, Connection 18
Memory guard, Option menu 70
Menu browse mode, iPod controlling ..58
Movie Dramatic,
Sound field program 38
Movie Spacious,
Sound field program 38
MULTI CH INPUT component
selection 34
Multi channel input setup,
Input menu 69
Multi-channel source
with headphones 39
Multi-format player connection 18
Multi-information display 23
Music Enh. 2ch,
Sound field program 38
Music Enh. 5ch,
Sound field program 38
MUTE 35
MUTE indicator 22
MUTE TYPE, Audio settings 66
Muting 35
- **N**
Neural Surround 39
Night listening mode 42
No BT Adapter,
Bluetooth status message 86
NO SIGNAL,
XM tuning status message 82
Not Available, SIRIUS Satellite Radio
status message 83
NOT SUPPORTED, SIRIUS Satellite
Radio status message 83
Number of speakers 26
Number of speakers,
Auto setup result 26
- **O**
OFF AIR,
XM tuning status message 82
OPTICAL IN (2), Input assignment 68
OPTICAL IN (3), Input assignment 68
OPTICAL INPUT assignment,
Input assignment 68
OPTIMIZER MIC jack, Auto setup 24
Optimizer microphone 24
Optimizer microphone, Auto setup 24
Optimizing speaker setting 24
Option menu, Manual setup 62
OSD SHIFT, Display settings 70
OSD shift, Display settings 70
OSD-AMP, Display settings 70
OSD-SOURCE, Display settings 70
Other components controlling
by remote control 74
Other components controlling,
Remote control 74
- **P**
PANORAMA,
Sound field parameter 40
Panorama, Sound field parameter 40
Parameter initialization,
Option menu 71
PARENTAL LOCK,
SIRIUS Satellite Radio setting 72
PCM indicator 22
PHONES jack 35
Play information display,
iPod controlling 58
Playing video sources
in the background 36
PLII Game 39
PLII Movie 39
PLII Music 39
Pop/Rock, Sound field program 38
Power cable, Connection 20
Preset channel setting,
XM tuning 49, 54
Preset SCENE templates 30
Preset Search mode,
XM tuning 48, 53
PRESET SEARCH,
XM tuning 53
Preset station exchange,
FM/AM tuning 45
Preset station selection,
FM/AM tuning 45
PRESET, Advanced setup 77
Pro Logic 39
Pure hi-fi sound 41
PVR connection 17
- **R**
Remote control codes iii
Remote control, Troubleshooting 87
Rename, SCENE template 31
Repeat 58
Repeat, iPod controlling 58
Resetting the system 87

■ S

| | |
|---|--------|
| SCENE | 7 |
| SCENE template selection | 28 |
| Searching... | |
| Bluetooth status message | 86 |
| Selection, Audio input jacks | 34 |
| Selection, | |
| MULTI CH INPUT component | 34 |
| Selection, Preset station, | |
| FM/AM tuning | 45 |
| Selection, SCENE template | 28 |
| SET MENU | 61 |
| Setting remote control codes | 75 |
| Setting SCENE template input source, | |
| Remote control | 32 |
| Set-top box connection | 17 |
| Shuffle, iPod controlling | 58 |
| SILENT CINEMA | 39 |
| SILENT CINEMA indicator | 23 |
| Simple remote mode, | |
| iPod controlling | 57 |
| SIRIUS Satellite Radio | 83 |
| SIRIUS Satellite Radio parental lock .. | 72 |
| SIRIUS Satellite Radio Parental Lock, | |
| Advanced setup | 76 |
| SIRIUS Satellite Radio setting | 72 |
| SIRIUS Satellite Radio setting, | |
| Option menu | 72 |
| SIRIUS Satellite Radio tuning | 51 |
| SiriusConnect tuner | 51 |
| SIZE | 25 |
| SIZE, Auto setup | 25 |
| SLEEP indicator | 23 |
| Sleep timer | 37 |
| Sound field programs | |
| with headphones | 39 |
| Sound menu, Manual setup | 61 |
| Source feature OSD display time, | |
| Display settings | 70 |
| SP | 26 |
| SP A B indicators | 22 |
| SP IMP., Advanced setup | 76 |
| SP, Auto setup result | 26 |
| Speaker distance | 25, 26 |
| Speaker distance, Auto setup | 25 |
| Speaker distance, Auto setup result | 26 |
| Speaker distance, Sound menu | 65 |
| Speaker distances, Speaker distance | 65 |
| Speaker impedance setting | 21 |
| Speaker impedance, Advanced setup .. | 76 |
| Speaker level | 26 |
| Speaker level adjustment | 41 |
| Speaker level, Auto setup result | 26 |
| Speaker level, Sound menu | 65 |
| Speaker settings, Sound menu | 63 |
| Speaker size | 25 |
| Speaker size, Auto setup | 25 |
| Speaker wiring | 25 |
| Speaker wiring, Auto setup | 25 |
| Speaker wiring/volume level, | |
| Auto setup | 25 |
| SPEAKER, Dynamic range | 66 |
| Speaker, Dynamic range | 66 |

| | |
|---|----|
| SPEAKER, | |
| Low-frequency effect level | 66 |
| Speaker, Low-frequency effect level ... | 66 |
| Specifications | 90 |
| SSR PIN, Advanced setup | 76 |
| STRAIGHT | 39 |
| Straight | 39 |
| SUB UPDATED, SIRIUS Satellite Radio | |
| status message | 83 |
| SUBWOOFER PHASE, | |
| Speaker settings | 64 |
| Subwoofer phase, Speaker settings | 64 |
| SUPPORT AUDIO, HDMI set | 67 |
| Support audio, HDMI set | 67 |
| SUR. L/R SP, Speaker settings | 64 |
| Surround left/right speakers, | |
| Speaker settings | 64 |

■ T

| | |
|---|----|
| Test tone, Center speaker equalizer | 66 |
| TEST, Center speaker equalizer | 66 |
| Tonal quality adjustment | 41 |
| Troubleshooting | 78 |
| TU, Advanced setup | 77 |
| Tuner (FM/AM), Troubleshooting | 81 |
| Tuner frequency step, | |
| Advanced setup | 77 |
| Tuner indicators | 22 |
| Turning off the power | 21 |
| Turning on the power | 21 |
| TV Sports, Sound field program | 38 |

■ U

| | |
|----------------------------------|----|
| Unable to play, iPod controlling | |
| status message | 85 |
| UNIT, Speaker distance | 65 |
| Unit, Speaker distance | 65 |
| Unknown iPod, iPod controlling | |
| status message | 85 |
| Unplug HP!, | |
| Auto setup error message | 84 |
| UPDATING, SIRIUS Satellite Radio | |
| status message | 83 |
| UPDATING, | |
| XM tuning status message | 82 |

■ V

| | |
|---------------------------------------|----|
| VCR connection | 17 |
| VIDEO AUX jacks, Front panel | 19 |
| Video components, Connection | 15 |
| Video information | 36 |
| VIDEO jacks | 13 |
| Video jacks | 13 |
| Video signal flow | 14 |
| Video sources in the background | 36 |
| Virtual CINEMA DSP | 39 |
| VIRTUAL indicator | 23 |
| VOLTAGE SELECTOR | 3 |
| VOLUME level indicator | 22 |
| Volume Trim, Input menu | 69 |

■ W

| | |
|--------------------------------|----|
| W-1:OUT OF PHASE, | |
| Auto setup error message | 85 |



| | |
|--------------------------------|----|
| W-2:DISTANCE ERROR, | |
| Auto setup error message | 85 |
| W-3:LEVEL ERROR, | |
| Auto setup error message | 85 |
| WIRING/LEVEL | 25 |
| WIRING/LEVEL, Auto setup | 25 |

■ X

| | |
|--|----|
| XM ANTENNA | 72 |
| XM ANTENNA, | |
| XM Radio setting | 72 |
| XM Mini-Tuner Dock | 46 |
| XM Radio antenna | 72 |
| XM Radio antenna, | |
| XM Radio setting | 72 |
| XM Radio setting | 72 |
| XM Radio setting, Option menu | 72 |
| XM Satellite Radio | 82 |
| XM Satellite Radio tuning | 46 |
| XM Satellite Radio, Status message | 82 |

■ Y

| | |
|---------------------------------|----|
| Yamaha iPod universal dock, | |
| Connection | 19 |
| Yamaha Parametric Room Acoustic | |
| Optimizer | 24 |
| YPAO | 24 |
| YPAO (Yamaha Parametric Room | |
| Acoustic Optimizer) | 24 |
| YPAO indicator | 22 |

“SPEAKERS” or “DVD” (example) indicates the name of the parts on the front panel or the remote control. Refer to the attached sheet or the pages at the end of this manual for the information about each position of the parts.

■ Front panel

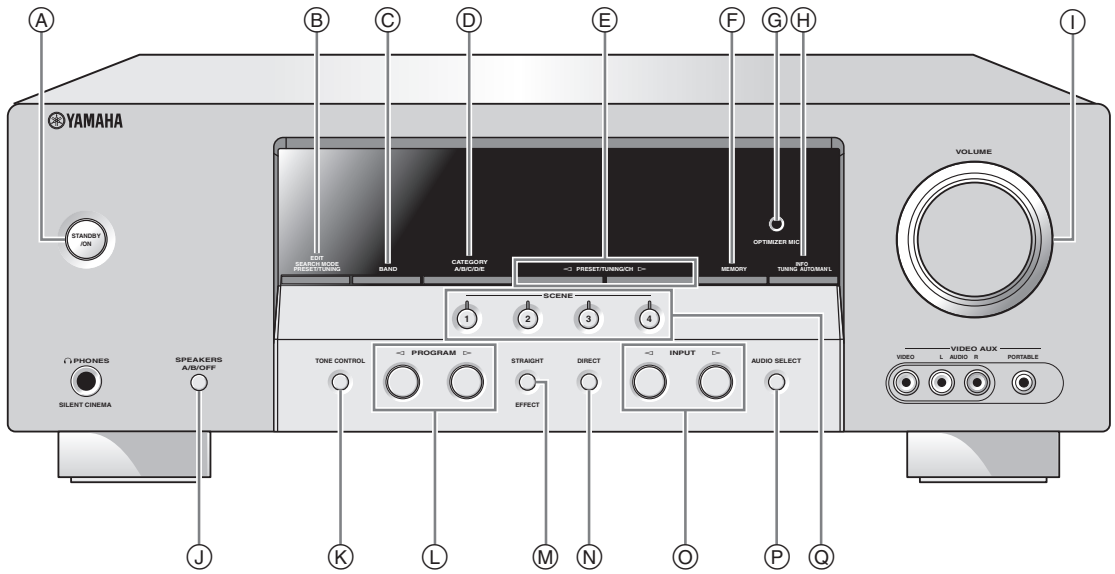

■ Remote control

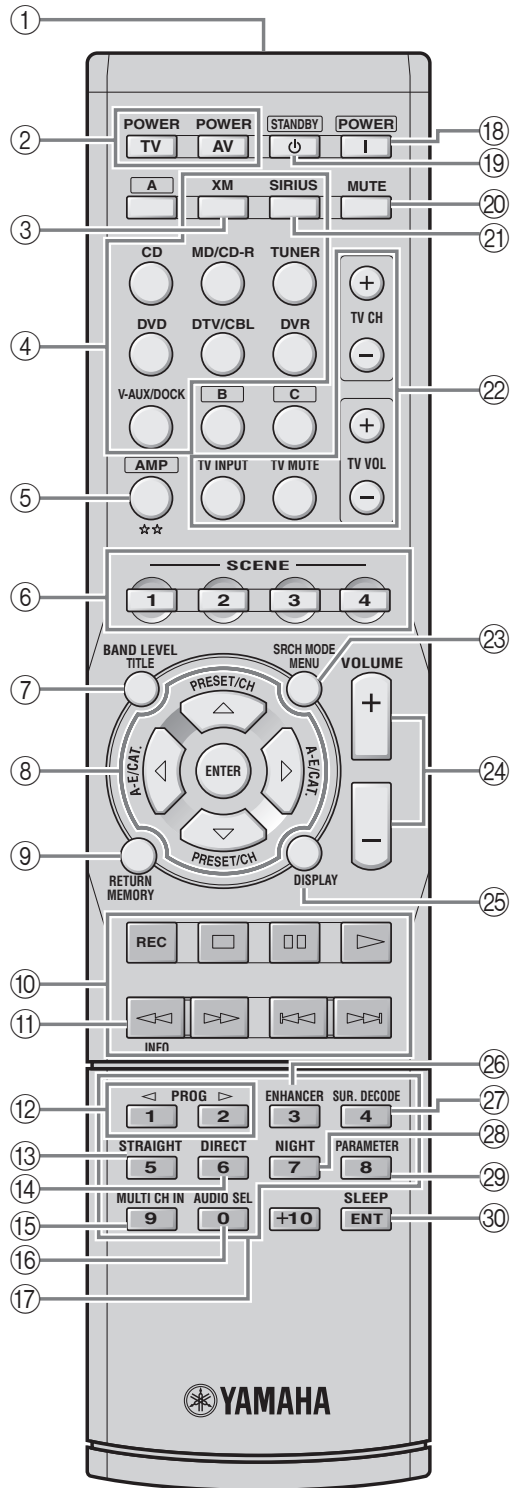

List of remote control codes

Blu-ray player

Samsung 2137

CD player

Yamaha 5000, 5013

CD Recorder

Yamaha 5001

DVD

Acoustic Solutions

2078
 Aiwa 2055, 2100
 Akai 2096
 Akura 2076
 Alba 2078, 2086
 Apex 2027, 2049
 Awa 2078
 Axion 2078
 Brainwave 2096
 Brandt 2073, 2085
 Broksonic 2060
 Bush 2075, 2078, 2112
 Centrex 2077
 Classic 2078
 Clatronic 2075
 Coby 2078
 C-Tech 2074
 CyberHome 2025, 2079, 2091
 Daewoo 2092, 2098
 Dansai 2096
 Daytek 2080, 2089
 DEC 2075
 Denon 2030, 2102, 2103
 Denver 2075, 2076
 Diamond 2074
 DK Digital 2094
 Dual 2078
 D-Vision 2096
 DVX 2074
 Elta 2096
 Euroline 2096
 Funai 2052, 2058
 Global Solutions 2074
 Global Sphere 2074
 Goodmans 2075, 2077, 2078
 Grundig 2077, 2098
 H&B 2075
 Haaz 2074
 HE 2078
 Hitachi 2032, 2072
 Home Electronics
 2078
 Innovation 2072
 Irradio 2134
 JDB 2078
 JVC 2033, 2045, 2053,
 2073, 2099
 Kenwood 2030, 2097
 Kingavon 2075
 Koda 2075
 Lawson 2074
 Lenco 2075
 LG 2084, 2087
 Lifetec 2072
 Limit 2074
 LogicLab 2074
 Luxor 2077
 Magnavox 2037, 2073, 2075
 Magnum 2072

MBO 2078
 Medion 2072
 Micromaxx 2072
 Micromedia 2073
 Microstar 2072
 Mitsubishi 2035
 Mizuda 2075
 Mustek 2078
 Naiko 2077
 Onkyo 2073, 2135
 Orava 2075
 P&B 2075
 Pacific 2074
 Panasonic 2030, 2040, 2054,
 2057, 2105, 2110
 Philips 2019, 2026, 2046,
 2073, 2081, 2090
 Pioneer 2036, 2082
 Proline 2077
 Provision 2075
 RCA 2031, 2042, 2050,
 2051
 Red Star 2076
 Reoc 2074
 Roadstar 2075, 2078, 2086
 Rowa 2077
 Saba 2085
 Sabaki 2074
 Samsung 2032, 2041, 2104,
 2113
 Sansui 2074
 Sanyo 2095
 ScanMagic 2078
 Scientific Labs 2074
 Scott 2088
 SEG 2074, 2086
 Sharp 2034, 2043, 2059,
 2093, 2106
 Silva 2076
 Singer 2074
 Skymaster 2074, 2078
 Skyworth 2076
 SM Electronic 2074, 2078
 Sony 2028, 2029, 2039,
 2083, 2107
 Soundmaster 2074
 Soundmax 2074
 Standard 2074
 Star Cluster 2074
 Starmedia 2075
 Supervision 2074, 2078
 Sylvania 2052, 2058
 Synn 2074
 TCM 2072
 Teac 2074
 Tec 2076
 Technics 2030
 Technika 2096
 Technosonic 2096
 Tevion 2072, 2074
 Thomson 2085, 2109
 Tokai 2076
 Toshiba 2026, 2044, 2048,
 2056, 2073, 2108,
 2111
 United 2078
 Voxson 2078
 Wharfedale 2074
 Xlogic 2074
 Yakumo 2077
 Yamada 2077

Yamaha 2000, 2001, 2003,
 2030, 2101
 Yukai 2078
 Zenith 2038, 2047, 2073

DVD Recorder

Apex 2024
 JVC 2070
 LG 2071
 Panasonic 2020, 2065, 2066,
 2067
 Philips 2019, 2061, 2062,
 2063
 Pioneer 2021
 RCA 2018
 Sony 2022, 2064
 Toshiba 2068
 Yamaha 2023
 Yukai 2069

DVD/LD

Pioneer 2036

DVD/VCR

JVC 1017, 2045
 LG 1071, 2087
 Panasonic 1020, 1072, 2040,
 2105
 Philips 1025
 RCA 1022, 2042
 Samsung 1021, 2041, 2104
 Sharp 1023, 1073, 2043,
 2106
 Sony 1019, 1074, 2039,
 2107
 Toshiba 1024, 1075, 2044,
 2108
 Zenith 1026, 2047

DVD-DVR

Panasonic 2067
 Pioneer 2114
 Samsung 2115
 Toshiba 2068

DVR

ABS 2132
 Alienware 2132
 CyberPower 2132
 Dell 2132
 DIRECTV 2123, 2128, 2129,
 2133
 DISH Network 2126, 2127
 Dishpro 2126
 Echostar 2126, 2127
 Expressvu 2126
 Gateway 2132
 GOI 2126
 Hewlett Packard 2132
 Hitachi 2008
 Howard Computers
 2132
 HTS 2126
 Hughes 2123, 2128
 Humax 2123
 Hush 2132
 iBUYPOWER 2132
 JVC 2126, 2127
 Linksys 2132
 Media Center PC
 2132

Microsoft 2132
 Mind 2132
 Niveus Media 2132
 Northgate 2132
 Panasonic 2015, 2016, 2017,
 2120
 Philips 2117, 2121, 2123,
 2128
 Pioneer 2012, 2013, 2014
 Proscan 2129
 RCA 2116, 2124, 2129,
 2133
 ReplayTV 2118, 2119, 2120
 Sharp 2009, 2010
 Sonic Blue 2119, 2120
 Sony 2005, 2006, 2007,
 2122, 2130, 2131,
 2132
 Stack 10 2132
 Stack 9 2132
 Systemax 2132
 Tagar Systems 2132
 Tivo 2116, 2121, 2122,
 2123, 2130, 2131
 Toshiba 2004, 2125, 2132
 Touch 2132
 UltimateTV 2133
 Viewsonic 2132
 Voodoo 2132
 Yamaha 2011
 ZT Group 2132

HD DVD

Toshiba 2136

iPod

Yamaha 5011

LD player

Yamaha 2002

MD

Yamaha 5002, 5003, 5004

TAPE DECK

Yamaha 5005, 5006

TUNER

Yamaha 5007, 5008, 5009,
 5010, 5012, 5014,
 5015, 5016, 5017,
 5018

TV

Acer 0093
 Acme 0207
 Acura 0208
 ADA 0255
 ADC 0206
 Admiral 0058, 0205, 0206,
 0210, 0211
 Adyson 0200, 0207
 Agashi 0200
 Agazi 0206
 AGB 0204
 Aiko 0127, 0200, 0207,
 0208
 Aiwa 0028, 0139, 0229,
 0237

| | | | | | | | |
|----------------|--|--------------------|--|------------------|--|----------------|--|
| Akai | 0059, 0065, 0127, 0129, 0130, 0200, 0204, 0208, 0209, 0213, 0217, 0218, 0255 | Cascade | 0208 | Envision | 0060, 0061 | Hisawa | 0209, 0218 |
| Akiba | 0209, 0218 | Cathay | 0213, 0217 | Erres | 0213, 0217 | Hitachi | 0006, 0014, 0015, 0061, 0095, 0105, 0127, 0156, 0179, 0180, 0204, 0207, 0210, 0211, 0215, 0216, 0251 |
| Akura | 0206, 0209, 0218 | CCE | 0127 | ESA | 0080 | Hornlyphon | 0213 |
| Alaron | 0200 | Celebrity | 0059 | Etron | 0208 | Hoshai | 0209, 0218 |
| Alba | 0200, 0207, 0208, 0209, 0217, 0218 | Centurion | 0213, 0217 | Euro-Feel | 0206 | Huanyu | 0200, 0207 |
| ALBIRAL | 0212 | Century | 0205 | Euroline | 0217 | Hygashi | 0200, 0207 |
| Allstar | 0213 | CGE | 0214, 0215 | Euroman | 0200 | Hyper | 0200, 0207, 0208, 0214, 0215 |
| Amplivision | 0207 | Cimline | 0208, 0218 | Euromann | 0206, 0207, 0213 | Hypson | 0206, 0207, 0213, 0217 |
| Amstrad | 0204, 0206, 0208, 0209, 0218 | Citizen | 0060, 0061, 0062, 0064 | Europhon | 0200, 0204, 0207, 0213, 0215 | ICE | 0127, 0200, 0206, 0207, 0208, 0209, 0213, 0218 |
| Amtron | 0062 | City | 0208 | Fenner | 0208 | ICeS | 0200, 0218 |
| Anam | 0208 | Clarivox | 0212, 0217 | Ferguson | 0212, 0217, 0226 | IMA | 0062 |
| Anam National | 0062 | Clatronic | 0206, 0207, 0208, 0209, 0213, 0214, 0218 | Fidelity | 0200, 0207, 0210 | Imperial | 0211, 0213, 0214, 0215 |
| Anglo | 0208 | CMS | 0200 | Finlandia | 0210 | Indiana | 0213, 0217 |
| Anitech | 0206, 0208 | Colortyme | 0060, 0061 | Finlux | 0204, 0205, 0207, 0213, 0215, 0217 | Infinity | 0063 |
| Ansonic | 0203, 0208 | Concerto | 0060, 0061 | Firstline | 0200, 0207, 0208, 0213, 0214 | Ingelen | 0211 |
| AOC | 0060, 0061 | Concorde | 0208 | Fisher | 0064, 0127, 0128, 0205, 0207, 0215 | Ingersol | 0208 |
| Apex | 0118, 0122, 0132 | Condor | 0200, 0207, 0213 | Flint | 0213, 0218 | Inno Hit | 0201, 0204, 0207, 0208, 0209, 0213, 0217, 0218 |
| Arc en Ciel | 0216 | Contec | 0200, 0207, 0208 | Formenti | 0200, 0205, 0207, 0215, 0217 | Innovation | 0206, 0208 |
| Arcam | 0200 | Contec/Cony | 0062 | Formenti-Phoenix | 0200 | Interbuy | 0208, 0214 |
| Arcam Delta | 0207 | Continental Edison | 0216 | Fortress | 0205 | Interfunk | 0205, 0211, 0213, 0214, 0216, 0217 |
| Aristona | 0213, 0217 | Cosmel | 0208 | Frontech | 0206, 0208, 0210, 0211, 0214 | International | 0200 |
| ASA | 0205, 0211 | Craig | 0062 | Fujitsu | 0023, 0024, 0025, 0088, 0127 | Intervision | 0206, 0207, 0218 |
| Asberg | 0213 | Crosley | 0205, 0214, 0215 | Funai | 0033, 0034, 0035, 0036, 0037, 0062, 0206 | Irradio | 0201, 0208, 0209, 0213, 0217, 0218 |
| Astra | 0208 | Crown | 0062, 0063, 0128, 0208, 0213, 0217 | Futuretech | 0062 | Isukai | 0209, 0218 |
| Asuka | 0200, 0206, 0207, 0209, 0218 | CS Electronics | 0200, 0207, 0209, 0214, 0218 | Gateway | 0094 | ITC | 0207, 0215 |
| Atlantic | 0200, 0207, 0213, 0217 | CTC | 0214 | GBC | 0208, 0215, 0218 | ITS | 0200, 0209, 0213, 0218 |
| Atori | 0208 | Curtis Mathes | 0057, 0060, 0061, 0064, 0065 | GE | 0057, 0060, 0061, 0122, 0147 | ITT | 0129, 0208, 0211 |
| Audiosonic | 0207, 0208, 0209, 0213, 0216, 0217, 0218 | CXC | 0062 | GEC | 0204, 0207, 0211, 0213, 0217 | ITV | 0208, 0217 |
| AudioTon | 0207 | Cybertron | 0209, 0218 | Geloso | 0208, 0210, 0215 | JBL | 0063 |
| Audiovox | 0062 | Daewoo | 0060, 0061, 0120, 0127, 0155, 0193, 0200, 0207, 0208, 0213, 0218, 0238 | General Technic | 0208 | JC Penney | 0057, 0060, 0061 |
| Autovox | 0205, 0206, 0207 | Dainichi | 0200, 0209, 0218 | Genexxa | 0209, 0211, 0213, 0218 | JCB | 0059 |
| Awa | 0200 | Dansai | 0200, 0206, 0213, 0217 | Gibraltar | 0060 | Jensen | 0060, 0061 |
| Baird | 0216 | Dantax | 0217 | GoldHand | 0200 | JVC | 0017, 0018, 0019, 0108, 0136, 0153, 0178, 0190, 0213, 0218 |
| Bang & Olufsen | 0205 | Daytron | 0060, 0061, 0208 | GoldStar | 0060, 0061, 0127, 0128, 0200, 0201, 0207, 0208, 0210, 0213, 0214, 0215, 0217 | Kaisui | 0200, 0207, 0208, 0209, 0218 |
| Basic Line | 0208, 0209, 0213, 0218 | De Graaf | 0210 | GPM | 0209, 0218 | Kamosonic | 0207 |
| Bastide | 0207 | Decca | 0204, 0207, 0213, 0217 | Graetz | 0211 | Kamp | 0200, 0207 |
| Baur | 0217 | Desmet | 0213, 0217 | Granada | 0204, 0207, 0210, 0213, 0217 | Kapsch | 0211 |
| Beko | 0228 | Diamond | 0200 | Grandin | 0208, 0209, 0217 | Karcher | 0207, 0208, 0212, 0217 |
| Belcor | 0060 | Dimensia | 0057 | Grundig | 0128, 0130, 0222, 0236, 0255 | Kawasho | 0059, 0060, 0061, 0200 |
| Bell & Howell | 0058, 0064 | Dixi | 0208, 0213, 0217 | Grunpy | 0062 | Kendo | 0128, 0210 |
| Benq | 0081 | DTS | 0208 | Halifax | 0200, 0206, 0207 | Kennedy | 0215 |
| Beon | 0213, 0217 | Dual | 0207, 0215, 0216 | Hallmark | 0060, 0061 | Kenwood | 0060, 0061 |
| Bestar | 0213 | Dual-Tec | 0207, 0208, 0215 | Hampton | 0200, 0207 | Kingsley | 0200, 0207 |
| Binatone | 0207 | Dumont | 0060, 0127, 0205, 0207 | Hanseatic | 0203, 0207, 0208, 0213, 0215, 0217 | Kloss Novabeam | 0062 |
| Black Star | 0214 | Durabrand | 0126 | Hantarex | 0204, 0208 | Kneissel | 0203 |
| Blaupunkt | 0255 | Dux | 0217 | Harvard | 0062 | Kolster | 0213 |
| Blue Sky | 0209, 0218 | Dynatron | 0213, 0217 | HCM | 0206, 0207, 0208, 0218 | Konka | 0209, 0218 |
| Bondstec | 0214 | Elbe | 0203, 0204, 0212, 0218 | Hifivox | 0216 | Korpel | 0213, 0217 |
| Boots | 0207 | Elbe-Sharp | 0204 | Higashi | 0200 | Korting | 0205 |
| Bradford | 0062 | Elcit | 0204, 0205 | Hinari | 0208, 0209, 0213, 0217, 0218 | Koyoda | 0208 |
| Brandt | 0216, 0226 | ELECTRO TECH | 0208 | | | KTV | 0062, 0127, 0207 |
| Brionvega | 0205, 0213, 0217 | Electroband | 0059 | | | Kyoto | 0200, 0212 |
| Britannia | 0200, 0207 | Electrohome | 0059, 0060, 0061 | | | | |
| Brockwood | 0060 | Elin | 0200, 0207, 0213, 0217 | | | | |
| Broksonic | 0138 | Elite | 0209, 0213, 0218 | | | | |
| Bruns | 0205 | Elman | 0215 | | | | |
| BSR | 0215 | Elta | 0200, 0208 | | | | |
| BTC | 0209, 0218 | Emerson | 0060, 0061, 0062, 0064, 0128, 0205 | | | | |
| Bush | 0177, 0208, 0209, 0210, 0213, 0215, 0216, 0217, 0218, 0230, 0237 | | | | | | |
| Candle | 0060, 0061 | | | | | | |
| Capsonic | 0206 | | | | | | |

| | | | | | | |
|-----------------|-------------------|------------------|-------------------|-----------------------|----------------|-------------------|
| Lenco | 0208 | NEC | 0026, 0053, 0060, | 0182, 0194, 0195, | Sanyo | 0020, 0021, 0022, |
| Lenoir | 0207, 0208 | | 0061, 0096, 0127 | 0211, 0213, 0216, | | 0049, 0060, 0064, |
| Lesca | 0214 | Neckermann | 0205, 0207, 0210, | 0217, 0250 | | 0127, 0128, 0200, |
| Leyco | 0206, 0213, 0217 | | 0213, 0217, 0255 | 0206, 0213 | | 0203, 0207, 0215 |
| LG | 0016, 0038, 0039, | NEI | 0213, 0217 | Polaroid | SBR | 0217 |
| | 0127, 0128, 0157, | Nesco | 0214 | Poppy | SCHAUB LORENTZ | |
| | 0158, 0163, 0164, | NET-TV | 0082, 0101 | Portland | | 0211 |
| | 0166, 0188, 0189, | New Tech | 0208, 0213 | Prandoni-Prince | Schneider | 0207, 0209, 0213, |
| | 0200, 0201, 0207, | New World | 0209, 0218 | Precision | | 0215, 0216, 0217, |
| | 0208, 0210, 0213, | Nicamagic | 0200, 0207 | Prima | | 0218 |
| | 0214, 0215, 0217 | Nikkai | 0200, 0206, 0207, | Profex | Scotch | 0061 |
| Liesenk | 0217 | | 0209, 0213, 0217, | Profi-Tronic | Scott | 0060, 0061, 0062 |
| Life | 0206, 0208 | | 0218 | Proline | Sears | 0057, 0060, 0061, |
| Lifetec | 0206, 0208, 0218 | Nikko | 0061 | Proscan | | 0064 |
| Loewe | 0063, 0128, 0203, | Noblisko | 0200, 0207 | Prosonic | SEG | 0200, 0206, 0207, |
| | 0204, 0223, 0227 | Nogamatic | 0216 | Protech | | 0214, 0215, 0217 |
| Loewe Opta | 0205, 0213, 0217 | Nokia | 0129, 0211 | | SEI | 0204 |
| Logik | 0058 | Nordmende | 0205, 0211, 0213, | | SEI-Sinudyne | 0204, 0205, 0211 |
| Luma | 0210, 0217 | | 0216 | Proton | Seleco | 0210, 0211, 0215 |
| Lumatron | 0210, 0213, 0217 | Nordvision | 0217 | Provision | Sencora | 0208 |
| Lux May | 0213 | Oceanic | 0211 | Pulsar | Sentra | 0218 |
| Luxman | 0060, 0061 | Olevia | 0084 | Pye | Serino | 0200 |
| Luxor | 0201, 0207, 0210 | ONCEAS | 0207 | Pymi | Sharp | 0009, 0010, 0011, |
| LXI | 0057, 0061, 0063, | Onwa | 0062, 0218 | Quasar | | 0060, 0061, 0066, |
| | 0064 | Orbit | 0213 | Quelle | | 0070, 0087, 0111, |
| Magnadyne | 0204, 0205, 0214, | Orion | 0126, 0204, 0208, | | | 0143, 0145, 0167, |
| | 0215, 0217 | | 0213, 0217, 0235 | | | 0168, 0169, 0198, |
| Magnafon | 0200, 0204, 0207 | Orline | 0218 | Radialva | | 0204, 0224, 0247, |
| Magnavox | 0060, 0061, 0063, | Orsowe | 0204 | Radio Shack | | 0248, 0249 |
| | 0102, 0103, 0150 | Osaki | 0127, 0206, 0207, | Radio Shack/Realistic | Shogun | 0060 |
| Magnum | 0206, 0208 | | 0209, 0218 | | Siarem | 0204, 0205, 0215 |
| Majestic | 0058 | Oso | 0201 | | Sicatel | 0212 |
| Mandor | 0206 | Oso | 0209, 0218 | Radiola | Siemens | 0255 |
| Manesth | 0206, 0207, 0213, | Osume | 0218 | Radiomarelli | Sierra | 0213 |
| | 0217 | Otto Versand | 0204, 0207, 0213, | Radiotone | Signature | 0058 |
| Marantz | 0060, 0061, 0063, | | 0215, 0216, 0217, | RCA | Silva | 0200 |
| | 0090, 0213, 0217 | | 0255 | | Singer | 0205, 0214, 0215 |
| Marelli | 0205 | Pael | 0200, 0207 | | Sinudyne | 0204, 0205, 0215, |
| Mark | 0200, 0213, 0217 | Palladium | 0207 | Realistic | | 0217 |
| Matsui | 0204, 0207, 0208, | Panama | 0200, 0206, 0207, | Revox | Skantic | 0211 |
| | 0210, 0213, 0217 | | 0208 | Rex | Solavox | 0211 |
| Mediator | 0213, 0217 | Panasonic | 0006, 0007, 0063, | RFT | Sonoko | 0206, 0207, 0208, |
| Medion | 0206, 0208 | | 0073, 0074, 0097, | Rhapsody | | 0213, 0217 |
| Megatron | 0061 | | 0110, 0114, 0137, | R-Line | Sonolor | 0211 |
| Melectronic | 0200, 0207, 0208, | | 0141, 0151, 0162, | Roadstar | Sontec | 0213, 0217 |
| | 0211, 0213, 0216, | | 0165, 0186, 0204, | | Sony | 0041, 0059, 0067, |
| | 0217 | | 0211, 0244, 0245, | Robotron | | 0085, 0086, 0174, |
| Memorex | 0058, 0061, 0064, | | 0246, 0254 | Rowa | | 0196, 0199, 0208, |
| | 0208 | Pathe Cinema | 0200, 0203, 0207, | RTF | | 0219, 0234 |
| Memphis | 0208 | | 0212, 0215 | Saba | Sound & Vision | 0209, 0218 |
| Metz | 0205 | Pathe Marconi | 0212, 0216 | | Soundesign | 0060, 0061, 0062 |
| MGA | 0060, 0061 | Pausa | 0208 | saccs | Soundwave | 0213, 0217 |
| Micromaxx | 0206, 0208 | Perdio | 0200 | Saisho | SSS | 0060, 0062 |
| Microstar | 0206, 0208 | Philco | 0060, 0061, 0063, | | Standard | 0207, 0208, 0209, |
| Minerva | 0204 | | 0128, 0205, 0214, | Salora | | 0213, 0218 |
| Minoka | 0213 | | 0215 | | Starlight | 0217 |
| Mitsubishi | 0006, 0015, 0016, | Philharmonic | 0207 | Sambers | Starlite | 0062 |
| | 0048, 0060, 0061, | Philips | 0040, 0060, 0063, | Sampo | Stenway | 0218 |
| | 0104, 0112, 0113, | | 0072, 0115, 0116, | | Stern | 0210, 0211 |
| | 0125, 0205, 0213 | | 0124, 0130, 0150, | Samsung | Sunkai | 0208, 0218 |
| Mivar | 0200, 0201, 0202, | | 0175, 0184, 0187, | | Sunwood | 0208, 0213 |
| | 0203, 0204, 0207 | | 0205, 0207, 0213, | | Superla | 0200, 0204, 0207 |
| Montgomery Ward | | | 0215, 0217, 0220, | | SuperTech | 0200 |
| | 0058 | | 0221, 0232, 0233, | | Supra | 0208 |
| MTC | 0060, 0061, 0128, | | 0252, 0253 | | Supreme | 0059 |
| | 0200 | Philips Magnavox | | | Susumu | 0209 |
| Multi System | 0217 | | 0124 | | Sutron | 0208 |
| Multitech | 0062, 0127, 0128, | Phoenix | 0200, 0205, 0213, | | Sydney | 0200, 0207 |
| | 0200, 0207, 0208, | | 0217 | | Sylvania | 0060, 0061, 0063, |
| | 0210, 0214, 0215, | Phonola | 0200, 0205, 0213, | | | 0080, 0134, 0142, |
| | 0217 | | 0217 | | | 0148 |
| Murphy | 0200, 0207 | Pilot | 0060 | | Symphonic | 0062, 0080 |
| NAD | 0061 | Pioneer | 0012, 0013, 0060, | Sandra | Sysline | 0217 |
| Naonis | 0210 | | 0061, 0098, 0109, | Sansui | Sytong | 0200 |
| | | | 0117, 0128, 0181, | | | |

| | | | | | | | |
|--------------|--|--------------------|--|------------------|------------------------------|------------------------|--|
| Tandy | 0127, 0207, 0209, 0211, 0218 | Weltblick | 0213, 0217 | Alba | 1044, 1050 | GoldHand | 1050 |
| Tashiko | 0200, 0207, 0210 | Weston | 0215 | American High | 1004 | Goldstar | 1000, 1003, 1042, 1045 |
| Tatung | 0127, 0204, 0207, 0213, 0217, 0237 | White Westinghouse | 0200, 0207, 0217 | Amstrad | 1042 | Goodmans | 1042, 1045, 1050, 1069 |
| TCM | 0206, 0208 | Yamaha | 0000, 0001, 0002, 0003, 0004, 0005, 0060, 0061 | Anitech | 1050 | Gradiente | 1005 |
| Teac | 0127 | | | ASA | 1045, 1046 | Graetz | 1043, 1047 |
| Tec | 0207, 0208, 0214, 0215 | Yamishi | 0218 | Asha | 1002, 1014 | Granada | 1046, 1047, 1049 |
| Techwood | 0060, 0061 | Yoko | 0200, 0206, 0207, 0208, 0209, 0213, 0217, 0218 | Asuka | 1042, 1045, 1046, 1050 | Grandin | 1042, 1045, 1050 |
| Teknika | 0058, 0060, 0061, 0062 | | | Audio Dynamics | 1000 | Grundig | 1046, 1050, 1062 |
| Teleavia | 0216 | Yorx | 0209, 0218 | Baird | 1042, 1043, 1047 | Hanseatic | 1045, 1046 |
| Telecor | 0218 | Zanussi | 0210 | Basic Line | 1044, 1050 | Harley Davidson | 1005 |
| Telefunken | 0065, 0213, 0216 | Zenith | 0058, 0060, 0100, 0105, 0119, 0121, 0154 | Baur | 1046 | Harman/Kardon | 1000 |
| Telegazi | 0218 | | | Beaumarck | 1002, 1014 | Harwood | 1006 |
| Teletech | 0208, 0214, 0217 | | | Bell & Howell | 1001 | HCM | 1050 |
| Teleton | 0207 | | | Blaupunkt | 1046, 1048 | Headquarter | 1001 |
| Televideo | 0200 | | | Broksonic | 1012, 1013 | Hinari | 1044, 1050 |
| Tensai | 0208, 0209, 0213, 0218 | | | Bush | 1044, 1050, 1066 | Hisawa | 1044 |
| Tesmet | 0213 | | | Calix | 1003 | Hitachi | 1007, 1010, 1039, 1042, 1043, 1046, 1049 |
| Tevion | 0206, 0208 | | | Candle | 1002, 1003 | Hughes Network Systems | 1010 |
| Textet | 0200, 0207 | | | Canon | 1004 | Hypson | 1044, 1050 |
| Thomson | 0191, 0192, 0207, 0213, 0216, 0226 | | | CCE | 1006 | Imperial | 1042 |
| Thorn | 0212, 0217 | | | CGE | 1042, 1043 | Inno Hit | 1046, 1050 |
| TMK | 0060, 0061 | | | Cimline | 1044, 1050 | Innovation | 1044, 1048 |
| Tokai | 0213 | | | Citizen | 1002, 1003 | Instant Replay | 1004 |
| Tokyo | 0200, 0207 | | | Colortyme | 1000 | Interbuy | 1045 |
| Toshiba | 0027, 0043, 0053, 0054, 0064, 0078, 0089, 0090, 0106, 0107, 0127, 0131, 0140, 0146, 0159, 0197, 0225, 0231, 0237 | | | Colt | 1006 | Intervision | 1042 |
| | 0211, 0215 | | | Craig | 1002, 1003, 1006, 1014 | Irradio | 1045, 1050 |
| Towada | 0200 | | | Crown | 1050 | ITT | 1043, 1047 |
| Transtec | 0204 | | | Curtis Mathes | 1000, 1002, 1004, 1009 | ITV | 1045 |
| Trident | 0204 | | | Cybernex | 1002, 1014 | JC Penney | 1000, 1001, 1002, 1003, 1004, 1006 |
| Tristar | 0218 | | | Daewoo | 1005, 1038, 1061, 1067 | JCL | 1004 |
| Triumph | 0204 | | | Dansai | 1050 | Jensen | 1007 |
| Uher | 0211, 0213 | | | Dantax | 1044 | JVC | 1000, 1001, 1007, 1011, 1017, 1036, 1043 |
| Ultravox | 0200, 0205, 0207, 0214, 0215 | | | DBX | 1000 | Kaisui | 1050 |
| United | 0217 | | | De Graaf | 1046, 1049 | Karcher | 1046 |
| Universum | 0127, 0128, 0129, 0201, 0206, 0213, 0214, 0215, 0217 | | | Decca | 1042, 1043, 1046 | Kendo | 1044 |
| Univox | 0212 | | | Denon | 1010 | Kenwood | 1000, 1001, 1007, 1011, 1043 |
| Vestel | 0210, 0211, 0213, 0214, 0215, 0217 | | | Dimensia | 1009 | KLH | 1006 |
| Vexa | 0208, 0217 | | | Dual | 1043, 1046 | Kodak | 1003, 1004 |
| Victor | 0213 | | | Dumont | 1042, 1046, 1047, 1049 | Korpel | 1050 |
| VIDEOLAGIC | 0200 | | | Dynatech | 1005 | Leyco | 1050 |
| Videologique | 0200, 0207, 0209, 0218 | | | Electrohome | 1003 | LG | 1003, 1042, 1045, 1071 |
| Videosat | 0214 | | | Electroponic | 1003 | Lifetec | 1044, 1048 |
| VideoSystem | 0213 | | | Elta | 1050 | Lloyd's | 1005 |
| Videotechnic | 0200 | | | Emerson | 1003, 1004, 1005, 1012, 1013 | Loewe | 1048 |
| Vidtech | 0060, 0061 | | | Etzuko | 1050 | Loewe Opta | 1045, 1046 |
| Viewsonic | 0076, 0077, 0092, 0099, 0172, 0173 | | | Ferguson | 1043 | Logik | 1006, 1050 |
| Visiola | 0200, 0207 | | | Fidelity | 1042 | Luxor | 1047 |
| Vision | 0213 | | | Finlandia | 1046, 1047, 1049 | LXI | 1003 |
| Vortec | 0213, 0217 | | | Finlux | 1042, 1043, 1046, 1047, 1049 | M Electronic | 1042 |
| Voxson | 0205, 0210, 0211, 0213 | | | FIRST LINE | 1044, 1045, 1049, 1050 | Magnasonic | 1047 |
| Waltham | 0207, 0212 | | | Fisher | 1001, 1047 | Magnavox | 1004, 1018, 1033 |
| Wards | 0057, 0058, 0060, 0061, 0063 | | | Flint | 1044 | Magnin | 1003, 1014 |
| Watson | 0213, 0217, 0218 | | | Formenti/Phoenix | 1046 | Manesth | 1050 |
| Watt Radio | 0200, 0207, 0212, 0215 | | | Fuji | 1004 | Marantz | 1000, 1001, 1004, 1046, 1051 |
| Wega | 0205 | | | Fujitsu | 1042 | Marta | 1003 |
| | | | | Funai | 1005, 1042 | Matsui | 1044, 1045 |
| | | | | Galaxy | 1042 | Matsushita | 1004 |
| | | | | Garrard | 1005 | Mediator | 1046 |
| | | | | GBC | 1050 | Medion | 1044, 1048 |
| | | | | GE | 1002, 1004, 1009, 1014, 1030 | MEI | 1004 |
| | | | | GEC | 1046 | | |
| | | | | Geloso | 1050 | | |
| | | | | General Technic | 1044, 1048 | | |
| | | | | Go Video | 1014 | | |

TV/DVD

| | |
|-----------|------------------------|
| Aiwa | 0139, 2055 |
| Apex | 0132, 2049 |
| Broksonic | 0138, 2060 |
| Bush | 0230, 2112 |
| JVC | 0136, 2053 |
| Panasonic | 0137, 0254, 2054, 2110 |
| RCA | 0133, 0135, 2050, 2051 |
| Sylvania | 0134, 2052 |
| Thomson | 0226, 2109 |
| Toshiba | 0131, 0231, 2048, 2111 |

TV/DVD/VCR

| | |
|-----------|------------------|
| Panasonic | 0141, 1040, 2057 |
| Samsung | 0241, 1070, 2113 |
| Sharp | 0143, 1028, 2059 |
| Sylvania | 0142, 1041, 2058 |
| Toshiba | 0140, 1029, 2056 |

TV/VCR

| | |
|-----------|------------------------------------|
| Aiwa | 0237, 1066 |
| Bush | 0237, 1066 |
| Daewoo | 0155, 0238, 1038, 1067 |
| GE | 0147, 1030 |
| Goodmans | 0240, 1069 |
| Grundig | 0236, 1062 |
| Hitachi | 0156, 1039 |
| JVC | 0153, 1036 |
| Magnavox | 0150, 1033 |
| Orion | 0235, 1065 |
| Panasonic | 0151, 1034 |
| Philips | 0150, 0232, 0233, 1033, 1062, 1063 |
| Quasar | 0152, 1035 |
| RCA | 0149, 1032 |
| Roadstar | 0237, 1066 |
| Samsung | 0144, 0239, 1027, 1068 |
| Sharp | 0145, 1028 |
| Sony | 0234, 1064 |
| Sylvania | 0148, 1031 |
| Tatung | 0237, 1066 |
| Toshiba | 0146, 0237, 1029, 1066 |
| Zenith | 0154, 1037 |

VCR

| | |
|-----------|------------------------------|
| Admiral | 1008, 1013 |
| Adventura | 1005 |
| Aiwa | 1005, 1042, 1043, 1044, 1066 |
| Akai | 1007, 1043 |
| Akiba | 1050 |
| Akura | 1043, 1050 |

| | | | | | | | |
|-----------------|---|-----------------------|--|----------------|--|--------------------|--|
| Memorex | 1001, 1002, 1003, 1004, 1005, 1008, 1013, 1014, 1042, 1045, 1047 | Pathe Marconi | 1043 | Samsung | 1002, 1014, 1021, 1027, 1052, 1068, 1070 | Tatung | 1007, 1042, 1043, 1046, 1066 |
| Memphis | 1050 | Penney | 1010, 1014 | Sanky | 1008 | TCM | 1044, 1048 |
| Metz | 1048 | Pentax | 1010, 1049 | Sansui | 1007, 1011, 1013, 1043 | Teac | 1005, 1007 |
| MGA | 1014 | Perdio | 1042 | Sanyo | 1001, 1002, 1014, 1047 | Technics | 1004, 1048 |
| MGN Technology | 1002, 1014 | Philco | 1004, 1051 | SBR | 1046 | Teknika | 1003, 1004, 1005 |
| Micromaxx | 1044, 1048 | Philips | 1004, 1025, 1033, 1046, 1056, 1057, 1059, 1062, 1063 | Schaub Lorenz | 1042, 1043, 1047 | Teleavia | 1043 |
| Microstar | 1044, 1048 | Philips Magnavox | 1018 | Schneider | 1042, 1044, 1045, 1046, 1050 | Telefunken | 1043 |
| Migros | 1042 | Phonola | 1046 | Scott | 1012 | Tenosal | 1050 |
| Minolta | 1010 | Pilot | 1003 | Sears | 1001, 1003, 1004, 1010 | Tensai | 1042, 1045, 1050 |
| Mitsubishi | 1011, 1042, 1046 | Pioneer | 1011, 1046 | SEG | 1050 | Tevion | 1044, 1048 |
| Montgomery Ward | 1008 | Prinz | 1042 | SEI-Sinudyne | 1046 | Thomson | 1043, 1058 |
| Motorola | 1004, 1008 | Profex | 1050 | Seleco | 1043 | Thorn | 1043, 1047 |
| MTC | 1002, 1014 | Profitronic | 1014 | Sentron | 1050 | TMK | 1002, 1014 |
| Multitech | 1002, 1005, 1006, 1042, 1046, 1050 | Proscan | 1009 | Sharp | 1008, 1023, 1028, 1053, 1073 | Tokai | 1045, 1050 |
| Murphy | 1042 | Prosonic | 1044 | Shintom | 1006, 1047, 1050 | Tonsai | 1050 |
| National | 1048 | Protex | 1006 | Shivaki | 1045 | Toshiba | 1013, 1024, 1029, 1043, 1046, 1066, 1075 |
| NEC | 1000, 1001, 1007, 1011, 1043, 1051 | Pye | 1046, 1056 | Shogun | 1002, 1014 | Totevision | 1002, 1003, 1014 1050 |
| Neckermann | 1043, 1046 | Quarter | 1001 | Siemens | 1045, 1047 | Towada | 1050 |
| NEI | 1046 | Quartz | 1001, 1047 | Signature 2000 | 1008 | Towika | 1050 |
| Nesco | 1050 | Quasar | 1004, 1035 | Silva | 1045 | Uher | 1045 |
| Nikko | 1003 | Quelle | 1042, 1046, 1047 | Singer | 1004, 1006 | Unitech | 1002, 1014 |
| Noblex | 1002, 1014 | Radio Shack | 1003 | Sinudyne | 1046 | Universum | 1042, 1045, 1046 |
| Nokia | 1043, 1047 | Radio Shack/Realistic | 1001, 1002, 1003, 1004, 1005, 1008 | Sontec | 1045 | Vector Research | 1000 |
| Nordmende | 1043 | Radiola | 1046 | Sony | 1016, 1019, 1055, 1060, 1064, 1074 | Video Concepts | 1000 |
| Oceanic | 1042, 1043 | Radix | 1003 | STS | 1004, 1010 | Videon | 1044, 1048 |
| Okano | 1044 | Randex | 1003 | Sunkai | 1044 | Videosonic | 1002, 1014 |
| Olympus | 1004 | RCA | 1002, 1004, 1009, 1010, 1014, 1015, 1022, 1032 | Sunstar | 1042 | Wards | 1002, 1003, 1004, 1005, 1006, 1008, 1010, 1014 |
| Optimus | 1003, 1008 | Realistic | 1001, 1002, 1003, 1004, 1005, 1008 | Suntronic | 1042 | Weltblick | 1045 |
| Orion | 1012, 1013, 1044, 1065 | Rex | 1043 | Sunwood | 1050 | White Westinghouse | 1013 |
| Orson | 1042 | RFT | 1046 | Sylvania | 1004, 1005, 1031, 1041 | XR-1000 | 1004, 1005, 1006 |
| Osaki | 1042, 1045, 1050 | Roadstar | 1045, 1050, 1066 | Symphonic | 1005 | Yamaha | 1000, 1001, 1007 |
| Otto Versand | 1046 | Saba | 1043 | Taisho | 1044 | Yamishi | 1050 |
| Palladium | 1043, 1045, 1050 | Saisho | 1044, 1050 | Tandy | 1001 | Yokan | 1050 |
| Panasonic | 1004, 1020, 1034, 1040, 1048, 1054, 1072 | Salora | 1047 | Tashiko | 1003, 1042 | Yoko | 1045, 1050 |
| | | | | | | Zenith | 1013, 1026, 1037 |



© 2008 YAMAHA CORPORATION All rights reserved.

YAMAHA ELECTRONICS CORPORATION, USA 6660 ORANGETHORPE AVE., BUENA PARK, CALIF. 90620, U.S.A.
 YAMAHA CANADA MUSIC LTD. 135 MILNER AVE., SCARBOROUGH, ONTARIO M1S 3R1, CANADA
 YAMAHA ELECTRONIK EUROPA G.m.b.H. SIEMENSSTR. 22-34, 25462 RELLINGEN BEI HAMBURG, GERMANY
 YAMAHA ELECTRONIQUE FRANCE S.A. RUE AMBROISE CROIZAT BP70 CROISSY-BEAUBOURG 77312 MARNE-LA-VALLEE CEDEX02. FRANCE
 YAMAHA ELECTRONICS (UK) LTD. YAMAHA HOUSE, 200 RICKMANSWORTH ROAD WATFORD, HERTS WD18 7GQ, ENGLAND
 YAMAHA SCANDINAVIA A.B. J A WETTERGRENS GATA 1, BOX 30053, 400 43 VÄSTRA FRÖLUNDA, SWEDEN
 YAMAHA MUSIC AUSTRALIA PTY, LTD. 17-33 MARKET ST., SOUTH MELBOURNE, 3205 VIC., AUSTRALIA

YAMAHA CORPORATION
 Printed in China ☞ WN25670

The circled numbers and alphabets correspond to those in the Owner's Manual.

Les nombres et lettres dans un cercle correspondent à ceux du mode d'emploi.

■ Front panel/Face avant

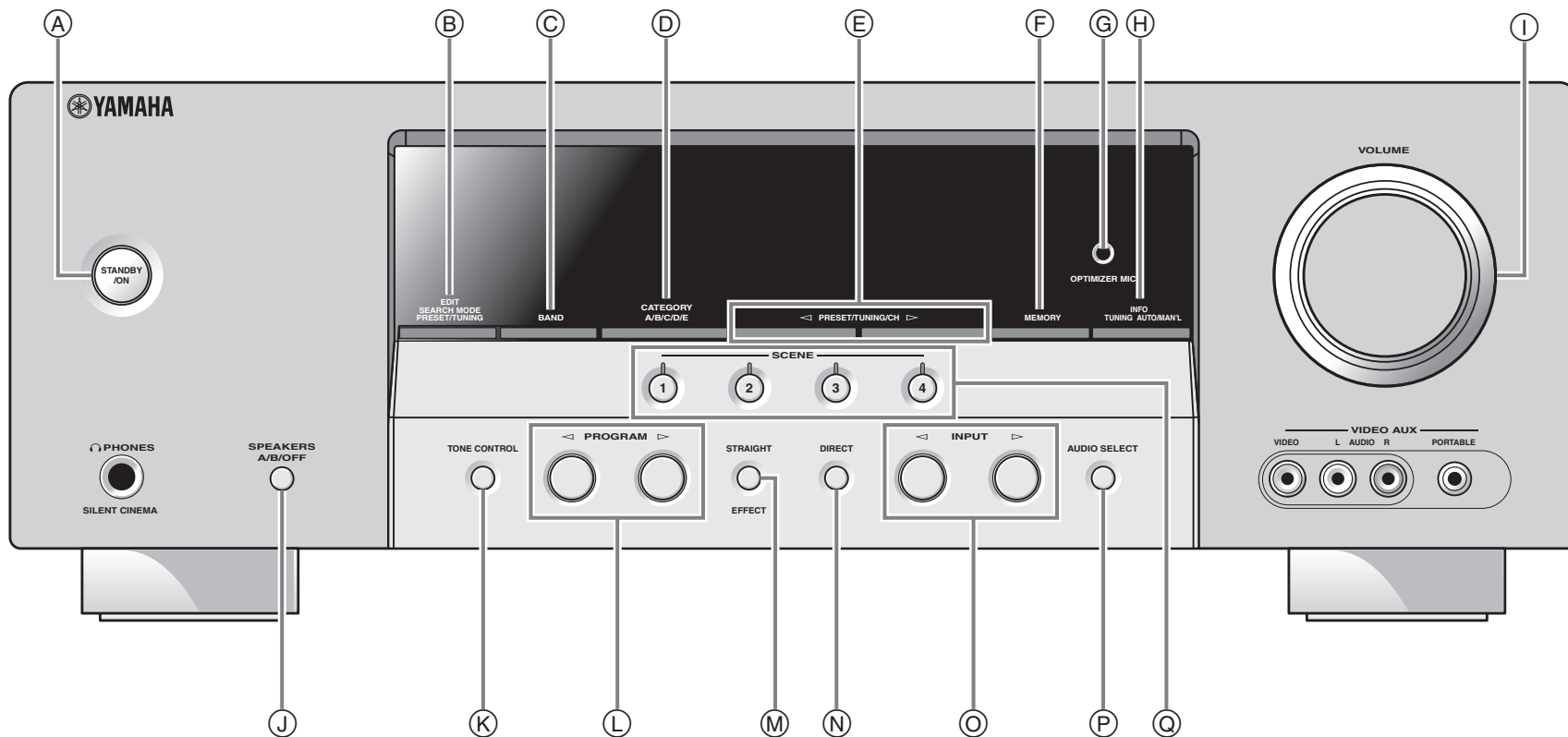

Remote control/Boîtier de télécommande

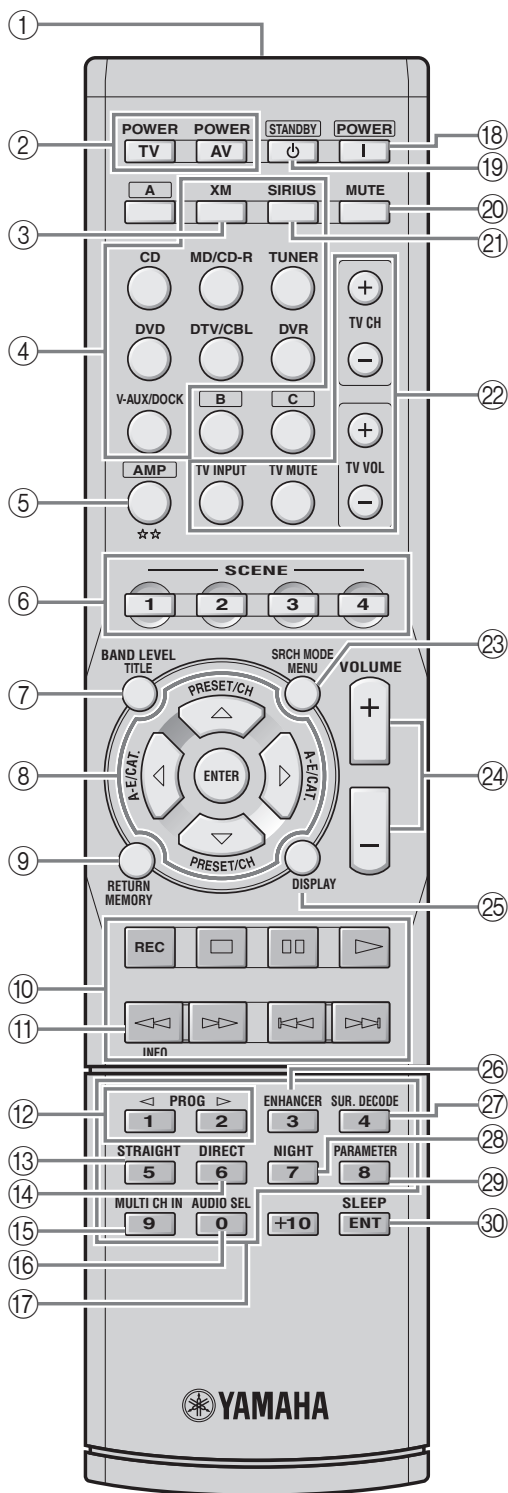

Free Manuals Download Website

<http://myh66.com>

<http://usermanuals.us>

<http://www.somanuals.com>

<http://www.4manuals.cc>

<http://www.manual-lib.com>

<http://www.404manual.com>

<http://www.luxmanual.com>

<http://aubethermostatmanual.com>

Golf course search by state

<http://golfingnear.com>

Email search by domain

<http://emailbydomain.com>

Auto manuals search

<http://auto.somanuals.com>

TV manuals search

<http://tv.somanuals.com>