



UCA

# ***RX-V496***

---

*Natural Sound AV Receiver*  
*Ampli-tuner audio-vidéo*

OWNER'S MANUAL  
MODE D'EMPLOI

# SAFETY INSTRUCTIONS

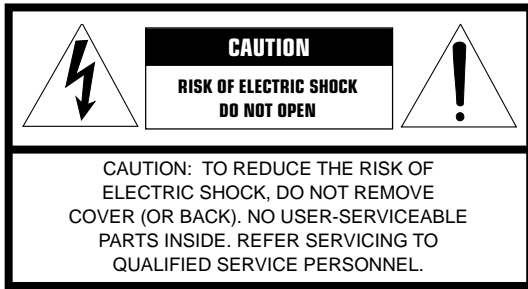

## • Explanation of Graphical Symbols

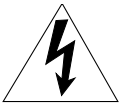

The lightning flash with arrowhead symbol, within an equilateral triangle, is intended to alert you to the presence of uninsulated "dangerous voltage" within the product's enclosure that may be of sufficient magnitude to constitute a risk of electric shock to persons.



The exclamation point within an equilateral triangle is intended to alert you to the presence of important operating and maintenance (servicing) instructions in the literature accompanying the appliance.

## **WARNING**

**TO REDUCE THE RISK OF FIRE OR ELECTRIC SHOCK, DO NOT EXPOSE THIS UNIT TO RAIN OR MOISTURE.**

- 1 Read Instructions – All the safety and operating instructions should be read before the unit is operated.
- 2 Retain Instructions – The safety and operating instructions should be retained for future reference.
- 3 Heed Warnings – All warnings on the unit and in the operating instructions should be adhered to.
- 4 Follow Instructions – All operating and other instructions should be followed.
- 5 Water and Moisture – The unit should not be used near water – for example, near a bathtub, washbowl, kitchen sink, laundry tub, in a wet basement, or near a swimming pool, etc.
- 6 Carts and Stands – The unit should be used only with a cart or stand that is recommended by the manufacturer.
- 6A A unit and cart combination should be moved with care. Quick stops, excessive force, and uneven surfaces may cause the unit and cart combination to overturn.
- 7 Wall or Ceiling Mounting – The unit should be mounted to a wall or ceiling only as recommended by the manufacturer.



- 8 Ventilation – The unit should be situated so that its location or position does not interfere with its proper ventilation. For example, the unit should not be situated on a bed, sofa, rug, or similar surface, that may block the ventilation openings; or placed in a built-in installation, such as a bookcase or cabinet that may impede the flow of air through the ventilation openings.
- 9 Heat – The unit should be situated away from heat sources such as radiators, stoves, or other appliances that produce heat.
- 10 Power Sources – The unit should be connected to a power supply only of the type described in the operating instructions or as marked on the unit.
- 11 Power-Cord Protection – Power-supply cords should be routed so that they are not likely to be walked on or pinched by items placed upon or against them, paying particular attention to cords at plugs, convenience receptacles, and the point where they exit from the unit.
- 12 Cleaning – The unit should be cleaned only as recommended by the manufacturer.
- 13 Nonuse Periods – The power cord of the unit should be unplugged from the outlet when left unused for a long period of time.
- 14 Object and Liquid Entry – Care should be taken so that objects do not fall into and liquids are not spilled into the inside of the unit.
- 15 Damage Requiring Service – The unit should be serviced by qualified service personnel when:
  - A. The power-supply cord or the plug has been damaged; or
  - B. Objects have fallen, or liquid has been spilled into the unit; or
  - C. The unit has been exposed to rain; or
  - D. The unit does not appear to operate normally or exhibits a marked change in performance; or
  - E. The unit has been dropped, or the cabinet damaged.
- 16 Servicing – The user should not attempt to service the unit beyond those means described in the operating instructions. All other servicing should be referred to qualified service personnel.
- 17 Power Lines – An outdoor antenna should be located away from power lines.
- 18 Grounding or Polarization – Precautions should be taken so that the grounding or polarization is not defeated.

**19 For US customers only:**

Outdoor Antenna Grounding – If an outside antenna is connected to this unit, be sure the antenna system is grounded so as to provide some protection against voltage surges and built-up static charges. Article 810 of the National Electrical Code, ANSI/NFPA 70, provides information with regard to proper grounding of the mast and supporting structure, grounding of the lead-in wire to an antenna discharge unit, size of grounding conductors, location of antenna discharge unit, connection to grounding electrodes, and requirements for the grounding electrode.

**Note to CATV system installer:**

This reminder is provided to call the CATV system installer's attention to Article 820-40 of the NEC that provides guidelines for proper grounding and, in particular, specifies that the cable ground shall be connected to the grounding system of the building, as close to the point of cable entry as practical.

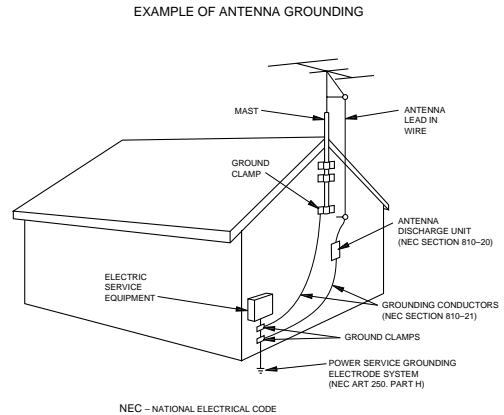
**FCC INFORMATION (for US customers only)****1. IMPORTANT NOTICE : DO NOT MODIFY THIS UNIT!**

This product, when installed as indicated in the instructions contained in this manual, meets FCC requirements. Modifications not expressly approved by Yamaha may void your authority, granted by the FCC, to use the product.

**2. IMPORTANT :** When connecting this product to accessories and/or another product use only high quality shielded cables. Cable/s supplied with this product MUST be used. Follow all installation instructions. Failure to follow instructions could void your FCC authorization to use this product in the USA.**3. NOTE :** This product has been tested and found to comply with the requirements listed in FCC Regulations, Part 15 for Class "B" digital devices. Compliance with these requirements provides a reasonable level of assurance that your use of this product in a residential environment will not result in harmful interference with other electronic devices.

This equipment generates/uses radio frequencies and, if not installed and used according to the instructions found in the users manual, may cause interference harmful to the operation of other electronic devices.

Compliance with FCC regulations does not guarantee that interference will not occur in all installations. If this product is found to be the source of interference, which can be determined by turning the unit "OFF" and "ON", please try to eliminate the problem by using one of the following measures:

Relocate either this product or the device that is being affected by the interference.

Utilize power outlets that are on different branch (circuit breaker or fuse) circuits or install AC line filter/s.

In the case of radio or TV interference, relocate/reorient the antenna. If the antenna lead-in is 300 ohm ribbon lead, change the lead-in to coaxial type cable.

If these corrective measures do not produce satisfactory results, please contact the local retailer authorized to distribute this type of product. If you can not locate the appropriate retailer, please contact Yamaha Electronics Corp., U.S.A. 6660 Orangethorpe Ave, Buena Park, CA 90620.

The above statements apply ONLY to those products distributed by Yamaha Corporation of America or its subsidiaries.

**We Want You Listening For A Lifetime**

YAMAHA and the Electronic Industries Association's Consumer Electronics Group want you to get the most out of your equipment by playing it at a safe level. One that lets the sound come through loud and clear without annoying blaring or distortion – and, most importantly, without affecting your sensitive hearing.

Since hearing damage from loud sounds is often undetectable until it is too late, YAMAHA and the Electronic Industries Association's Consumer Electronics Group recommend you to avoid prolonged exposure from excessive volume levels.



## CAUTION: READ THIS BEFORE OPERATING YOUR UNIT.

1. To assure the finest performance, please read this manual carefully. Keep it in a safe place for future reference.
2. Install this unit in a cool, dry, clean place — away from windows, heat sources, sources of excessive vibration, dust, moisture and cold. Avoid sources of humming (transformers, motors). To prevent fire or electrical shock, do not expose the unit to rain or water.
3. Never open the cabinet. If something drops into the unit, contact your dealer.
4. Do not use force on switches, controls or connection wires. When moving the unit, first disconnect the power cord and then the wires connected to other component. Never pull the wires themselves.
5. The openings on the cover assure proper ventilation of the unit. If these openings are obstructed, the temperature inside the unit will rise rapidly. Therefore, avoid placing objects against these openings, and install the unit in a well-ventilated area to prevent fire and damage.
6. The voltage used must be the same as that specified on this unit. Using this unit with a higher voltage than specified is dangerous and may result in fire or other accidents. YAMAHA will not be held responsible for any damage resulting from the use of this unit with a voltage other than that specified.
7. Digital signals generated by this unit may interfere with other component such as tuners, receivers and TVs. Move this unit farther away from such component if interference is observed.
8. Always set VOLUME to the “∞” position before starting the audio source play. Increase the volume gradually to an appropriate level after playback has been started.
9. Do not attempt to clean the unit with chemical solvents; this might damage the finish. Use a clean, dry cloth.
10. Be sure to read the “TROUBLESHOOTING” section regarding common operating errors before concluding that the unit is faulty.
11. When not planning to use this unit for a long period of time (e.g., a vacation), disconnect the AC power cord from the wall outlet.
12. To prevent lightning damage, disconnect the AC power cord and disconnect the antenna cable when there is an electrical storm.
13. Grounding or polarization — Precautions should be taken so that the grounding or polarization of the unit is not defeated.
14. AC outlet — Do not connect audio component to the AC outlet on the rear panel if that component requires more power than the outlet is rated to provide.

This unit is not disconnected from the AC power source as long as it is connected to the wall outlet, even if this unit itself is turned off. This state is called the standby mode. In this state, this unit is designed to consume a very small quantity of power.

### IMPORTANT

Please record the serial number of this unit in the space below.

MODEL:

Serial No.:

The serial number is located on the rear of the unit. Retain this Owner's Manual in a safe place for future reference.

### WARNING

TO REDUCE THE RISK OF FIRE OR ELECTRIC SHOCK, DO NOT EXPOSE THIS UNIT TO RAIN OR MOISTURE.

### FOR CANADIAN CUSTOMERS

To prevent electric shock, match wide blade of plug to wide slot and fully insert.

This Class B digital apparatus complies with Canadian ICES-003.



# FEATURES

## 5-Channel Power Amplification

- ◆ Minimum RMS Output (0.06% THD, 20 Hz – 20 kHz)  
[U.S.A. and Canada models]  
Main: 70 W + 70 W (8 Ω)  
Center: 70 W (8 Ω)  
Rear: 70 W + 70 W (8 Ω)  
[Australia model]  
Main: 65 W + 65 W (8 Ω)  
Center: 65 W (8 Ω)  
Rear: 65 W + 65 W (8 Ω)

## Multi-mode Digital Sound Field Processing

- ◆ Digital Sound Field Processor (DSP)
- ◆ Dolby Digital Decoder
- ◆ Dolby Pro Logic Decoder
- ◆ DTS Decoder
- ◆ CINEMA DSP: Theater-like Sound Experience by the Combination of YAMAHA DSP Technology and Dolby Digital, Dolby Pro Logic or DTS
- ◆ Automatic Input Balance Control for Dolby Pro Logic decoding

## Sophisticated FM/AM Tuner

- ◆ 40-Station Random Access Preset Tuning
- ◆ Automatic Preset Tuning
- ◆ Preset Station Shifting Capability (Preset Editing)

## Other Features

- ◆ “SET MENU” which Provides You with 11 Items for Optimizing This Unit for Your Audio/Video System
- ◆ Test Tone Generator for Easier Speaker Balance Adjustment
- ◆ 6-Channel External Decoder Input for Other Future Formats
- ◆ Video Signal Input/Output Capability (Including S Video Connections)
- ◆ 2 Optical/1 Coaxial Digital Signal Input Terminals
- ◆ SLEEP Timer
- ◆ Remote Control with Preset Manufacturer Codes



Manufactured under license from Dolby Laboratories. “Dolby”, “Pro Logic” and the double-D symbol are trademarks of Dolby Laboratories. Confidential Unpublished Works. ©1992 – 1997 Dolby Laboratories, Inc. All rights reserved.



Manufactured under license from Digital Theater Systems, Inc. US Pat. No. 5,451,942 and other world-wide patents issued and pending. “DTS”, “DTS Digital Surround”, are trademarks of Digital Theater Systems, Inc. Copyright 1996 Digital Theater Systems, Inc. All Rights Reserved.

# CONTENTS

<b>INTRODUCTION</b>	<b>INTRODUCTION</b>
FEATURES .....	1
CONTENTS .....	1
GETTING STARTED .....	2
CONTROLS AND FUNCTIONS .....	4

<b>PREPARATION</b>	<b>PREPARATION</b>
SPEAKER SETUP .....	8
CONNECTIONS .....	9
ADJUSTING THE SPEAKER BALANCE .....	18

<b>BASIC OPERATION</b>	<b>BASIC OPERATION</b>
PLAYING A SOURCE .....	20
DIGITAL SOUND FIELD PROCESSOR (DSP) EFFECT .....	24
SOUND FIELD PROGRAM .....	25
TUNING .....	28
RECORDING A SOURCE ON TAPE, MD OR VIDEO CASSETTE .....	32

<b>ADVANCED OPERATION</b>	<b>ADVANCED OPERATION</b>
SET MENU .....	33
DELAY TIME AND SPEAKER OUTPUT LEVELS .....	37
SLEEP TIMER .....	39
PRESET REMOTE CONTROL .....	40

<b>APPENDIX</b>	<b>APPENDIX</b>
TROUBLESHOOTING .....	47
SPECIFICATIONS .....	50
GLOSSARY .....	52
INDEX .....	53

indicates a tip for your operation.



# GETTING STARTED

## Checking the Package Contents

Check that the following items are included in your package.

### Remote control

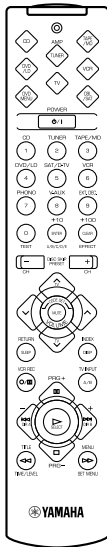

### Batteries (AAA, R03, UM-4 type)

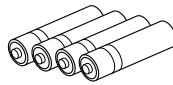

### Antenna adapter (U.S.A. and Canada models only)

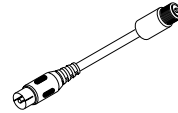

### Indoor FM antenna

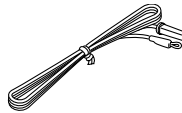

### Quick reference card

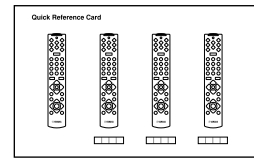

### AM loop antenna



### Connection guide

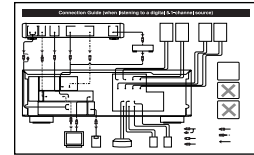

## Battery Installation in the Remote Control

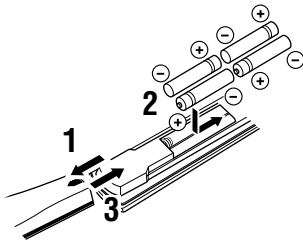

- 1** Turn the remote control over and slide the battery compartment cover in the direction of the arrow.
- 2** Insert the batteries (AAA, R03 or UM-4 type) according the polarity markings on the inside of the battery compartment.
- 3** Close the battery compartment cover.

## Battery Replacement

If the remote control operates only when it is close to the unit, the batteries are weak. Replace all the batteries with new ones.

Be sure to replace the batteries within about two minutes. If it takes longer than two minutes, the codes preset for the remote control will return to the factory settings. (Refer to pages 40 to 46 about the remote control.)

### Notes

- Use only AAA, R03 or UM-4 batteries for replacement.
- Be sure the battery polarity is correct. (See the illustration inside the battery compartment.)
- Remove the batteries if the remote control will not be used for an extended period of time.
- If the batteries have leaked, dispose of them immediately. Avoid touching the leaked material or letting it come into contact with clothing, etc. Clean the battery compartment thoroughly before installing new batteries.

## Using the Remote Control

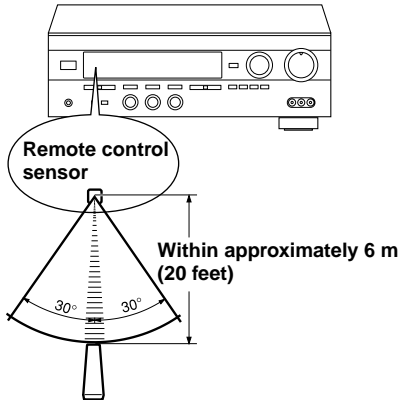

The remote control transmits a directional infrared beam. Be sure to aim the remote control directly at the infrared sensor during operation. When the sensor is covered or there is a large object between the remote control and the sensor, the sensor cannot receive signals. The sensor may not be able to receive signals properly when it is exposed to direct sunlight or a strong artificial light (such as a fluorescent or strobe light). In this case, change the direction of the light or reposition the unit to avoid direct lighting.

### Notes

- Handle the remote control with care.
- Do not spill water, tea or other liquids on the remote control.
- Do not drop the remote control.
- Do not leave or store the remote control in the following conditions:
  - high humidity or temperature such as near a heater, stove or bath;
  - dusty places; or
  - extremely low temperature.



# CONTROLS AND FUNCTIONS

## Front Panel

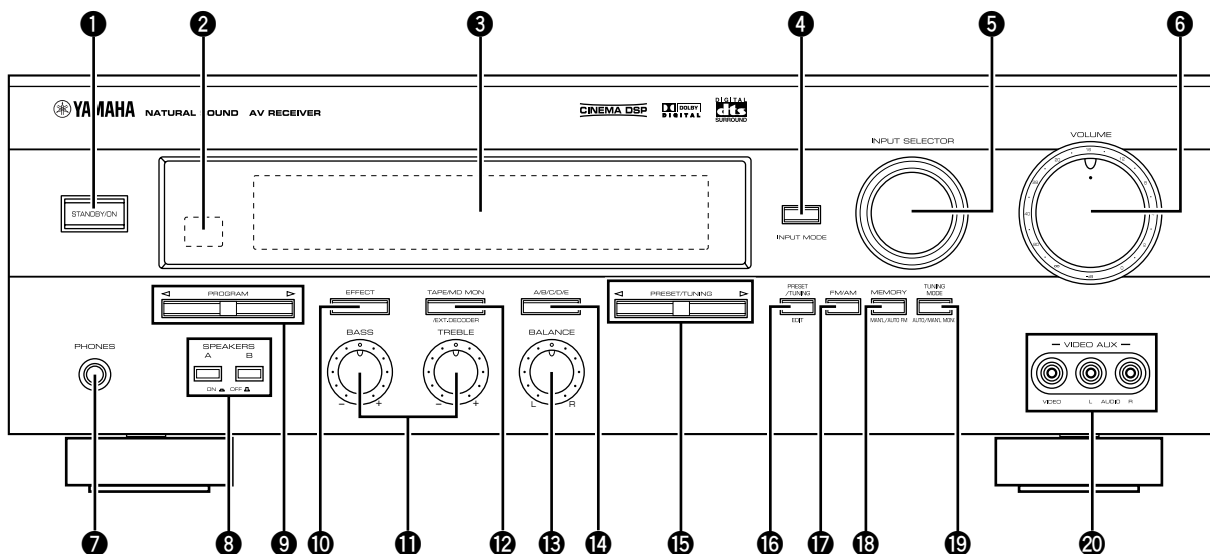

### 1 STANDBY/ON

Press this switch to turn on the power of this unit or to set this unit in the standby mode. Before turning the power on, set VOLUME to the “∞” position.

#### Standby mode

In this mode, this unit consumes a very small quantity of power to receive infrared-signals from the remote control.

### 2 Remote control sensor

This receives signals from the remote control.

### 3 Display

This shows various information. (Refer to page 6 for details.)

### 4 INPUT MODE

Press this button to select the input mode among AUTO, DTS and ANALOG for the DVD/LD, TV/digital TV and satellite tuner sources.

### 5 INPUT SELECTOR

Turn this selector to select the input source (TUNER, CD, PHONO, V-AUX, VCR, SAT/D-TV, DVD/LD) that you want to listen to or watch. The arrow for the selected input source indicator lights up on the display.

### 6 VOLUME

Turn this control to turn up or down the volume.

### 7 PHONES jack

Connect the headphones to the PHONES jack. You can listen to the sound to be output from the main speakers through the headphones.

When using headphones only, set both SPEAKERS A and B to the OFF position and press EFFECT to turn off the effect speakers (center and rear) (so that no DSP program name appear on the display).

### 8 SPEAKERS

Set A or B (or both A and B) to the ON position for the main speaker system (connected to this unit) that you want to use. Set the button(s) to the OFF position for the main speaker system that you don't want to use.

### 9 PROGRAM selector

Press ◀ or ▶ to select a DSP program when the effect speakers (center and rear) are turned on. The name of the selected program appears on the display.

### 10 EFFECT

Press this button to turn on or off the effect speakers (center and rear). If you turn them off, all Dolby Digital and DTS audio signals are directed to the right and left main speakers. In that case, the output levels of the right and left speakers may not match.



**11 Tone controls**

These controls are only effective for the sound from the main speakers.

**a) BASS**

Turn this control clockwise to increase or counterclockwise to decrease the low-frequency response. The “0” position produces a flat response.

**b) TREBLE**

Turn this control clockwise to increase or counterclockwise to decrease the high-frequency response. The “0” position produces a flat response.

**12 TAPE/MD MON / EXT. DECODER**

Press this button to select a tape or an MD source. The “TAPE/MD MONITOR” indicator lights up on the display. When you press the button next, the “TAPE/MD MONITOR” indicator goes off, “EXT. DECODER” appears on the display and you can listen to a source connected to the EXTERNAL DECODER INPUT terminals.

**13 BALANCE**

This control is only effective for the sound from the main speakers.

Turn the control to adjust the balance of the output volume from the right and left main speakers to compensate for sound imbalance caused by the speaker location or listening room conditions.

**14 A/B/C/D/E**

Press this button to select one of a group (A to E) of preset stations.

**15 PRESET/TUNING**

When “>” appears

This button is used to select a preset station number (1 to 8). Press ► to select a higher and ◀ to select a lower preset station number.

When “>” goes off

This button is used for tuning. Press ► to tune in to higher frequencies, and ◀ to tune in to lower frequencies.

**16 PRESET/TUNING, EDIT**

Press this button to turn on or off “>” on the display and switch the function between for storing a broadcasting station (preset tuning) and for tuning. This button is also used to exchange the assignment of two preset stations with each other.

**17 FM/AM**

Press this button to switch the reception band between FM and AM.

**18 MEMORY (MAN'L/AUTO FM)**

Press this button to store the broadcasting stations. Hold down this button for more than three seconds to begin automatic preset tuning.

**19 TUNING MODE (AUTO/MAN'L MONO)**

Press this button to switch the tuning mode between automatic and manual. To use the automatic tuning method, press this button so that the “AUTO” indicator lights up on the display. To use the manual tuning method, press this button so that the “AUTO” indicator goes off.

**20 VIDEO AUX terminals**

Connect an auxiliary audio or video input source such as a camcorder to these terminals. Use INPUT SELECTOR to select the source connected to these terminals.

## Display

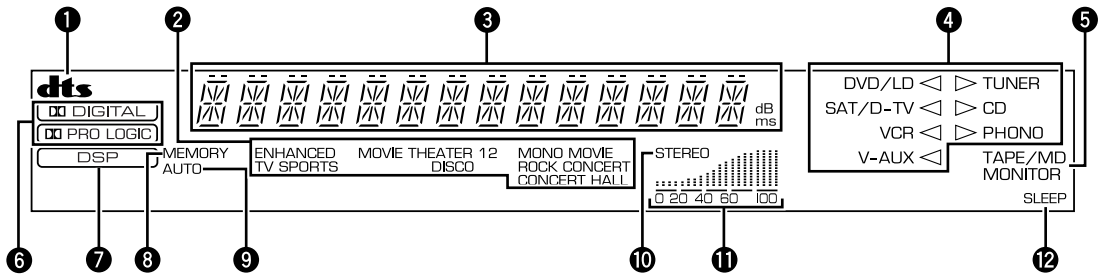

### 1 dts indicator

The “dts” indicator lights up when the built-in DTS decoder is turned on.

### 2 DSP program indicators

The name of the selected DSP program lights up in the following cases:

- When the tuner is selected as the input source.
- When DSP program No. 2, 3 or the subprogram “ENHANCED” of No.1 is selected.

### 3 Multi-information display

This display shows various information: for example the name of the selected DSP program and the various settings during adjustment with the SET MENU. The current station frequency and band (FM or AM) also appear when the tuner is selected as the input source.

### 4 Input source indicators

One of the arrows for these indicators lights up depending on which source is selected.

### 5 TAPE/MD MONITOR indicator

This lights up when the tape deck or MD recorder, etc. is selected as the input source by pressing TAPE/MD MON / EXT. DECODER (or TAPE/MD).

### 6 DIGITAL and PRO LOGIC indicators

“DIGITAL” lights up when the built-in Dolby Digital decoder is on and the signals of the selected source are encoded with Dolby Digital. “PRO LOGIC” lights up when the built-in Dolby Pro Logic decoder is on.

### 7 DSP indicator

“DSP” lights up when the built-in digital sound field processor is on.

### 8 MEMORY indicator

This flashes for about five seconds after pressing MEMORY. During this period, the displayed station can be stored in the memory.

### 9 AUTO indicator

This lights up when the unit is in the automatic tuning mode.

### 10 STEREO indicator

This lights up when an FM stereo broadcast with sufficient signal strength is being received.

### 11 Signal-level indicator

This indicates the signal level of the station being received. If multipath interference is detected, the indication decreases.

### 12 SLEEP indicator

This lights up while the built-in SLEEP timer is on.

## Remote Control

This section describes basic operation of this unit with the remote control. First, press AMP(TUNER) on the component selector. Refer to “PRESET REMOTE CONTROL” on page 40 for full details.

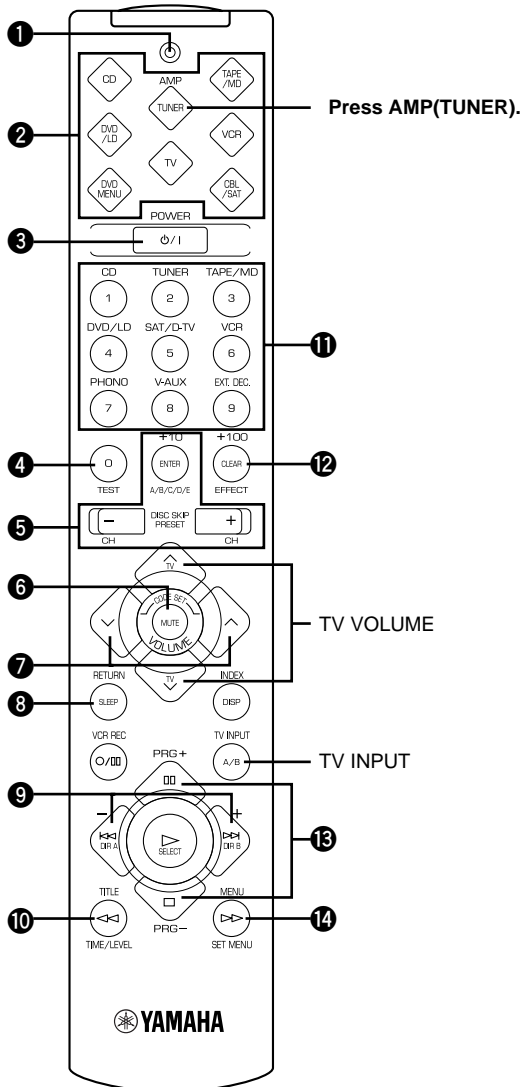

### 1 Indicator

This flashes in red when pressing a button on the remote control. If it flashes rapidly several times, press the selected button again.

### 2 Component selector buttons

Press one of these buttons which corresponds to the component you want to control with the remote control. (The proper code must be set for your component. Refer to “Setup codes” on page 45.) When the component selector button has been pressed, the remote control is set to that component operation mode.

### 3 POWER

Each time you press this button, the unit switches between the power on and standby mode.

### 4 TEST

Press this button to output the test tone for each speaker.

### 5 A/B/C/D/E, PRESET +/-

These buttons are used to select a preset station.

A/B/C/D/E: To select one of a group (A to E) of preset stations

PRESET +/-: To select a preset station number (1 to 8)

### 6 MUTE

Press this button to mute the sound. To cancel mute, press this button again.

### 7 VOLUME

These buttons are used to adjust the volume level.

∧: To turn up the volume

∨: To turn down the volume

### 8 SLEEP

Press this button to set the SLEEP timer.

### 9 +/-

These buttons adjust the settings of the SET MENU and TIME/LEVEL mode.

### 10 TIME/LEVEL

Press this button to select the items in the TIME/LEVEL mode.

### 11 Input selector buttons

These buttons select the input source.

CD: To play a CD

TUNER: To listen to an FM or AM broadcast

TAPE/MD: To play a tape or MD

DVD/LD: To play a DVD or LD

SAT/D-TV: To watch a TV or satellite broadcast

VCR: To play a video cassette

PHONO: To play an analog record

V-AUX: To use a camcorder

EXT. DEC.: To play other multi-channel source

### 12 EFFECT

Press this button to turn on or off the effect speakers (center and rear).

### 13 PRG+, PRG-

Press these buttons to select a DSP program.

### 14 SET MENU

Press this button to select the items in the SET MENU.



# SPEAKER SETUP

## Speakers to Be Used

This unit is designed to provide the best sound-field quality with a 5-speaker system, using main speakers, rear speakers and a center speaker. If you use different brands of speakers (with different tonal qualities) in your system, the tone of a moving human voice and other types of sound may not shift smoothly. We recommend that you use speakers from the same manufacture or speakers with the same tonal quality.

The main speakers are used for the main source sound plus the effect sounds. They will probably be the speakers from your present stereo system. The rear speakers are used for the effect and surround sounds, and the center speaker is for the center sounds (dialog, vocals, etc.). If for some reason it is not practical to use a center speaker, you can do without it. Best results, however, are obtained with the full system.

The main speakers should be high-performance models and have enough power-handling capacity to accept the maximum output of your audio system. The other speakers do not have to be equal to the main speakers. For precise sound localization, however, it is ideal to use high-performance models that can reproduce sounds over the full range for the center speaker and the rear speakers.

### ■ Use of a subwoofer expands your sound field

It is also possible to further expand your system with the addition of a subwoofer. The use of a subwoofer is effective not only for reinforcing bass frequencies from any or all channels, but also for reproducing the LFE (low frequency effect) channel with high fidelity when playing back a source encoded with Dolby Digital or DTS. The YAMAHA Active Servo Processing Subwoofer System is ideal for natural and lively bass reproduction.

## Speaker Placement

Refer to the following diagram when you place the speakers.

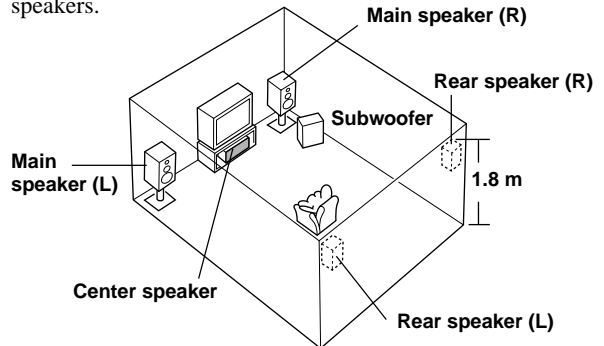

### ■ Main speakers

Place the right and left main speakers an equal distance from the ideal listening position. The distance of each speaker from each side of the TV monitor should be the same.

### ■ Rear speakers

Place these speakers behind your listening position, facing slightly inwards, nearly 1.8 m (approx. 6 feet) above the floor.

### ■ Center speaker

Align the front face of the center speaker with the front face of your TV monitor. Place the speaker as close to the monitor as possible, such as directly over or under the monitor and centrally between the main speakers.

#### Note

- If the center speaker is not used, the sound will be heard from the right and left main speakers. In that case, "CENTER SP" in the SET MENU is set to the NONE position. (Refer to page 34 for details.)

### ■ Subwoofer

The position of the subwoofer is not so critical, because low bass sounds are not highly directional. But it is better to place the subwoofer near the main speakers. Turn it slightly toward the center of the room to reduce the wall reflections.

#### CAUTION

Some types of speakers interfere with a TV monitor. If this problem occurs, move the speakers away from the monitor. If you cannot avoid installing the center speaker or subwoofer near the TV monitor, use magnetically shielded speakers.



# CONNECTIONS

## Before Connecting Components

### CAUTION

Never connect this unit and other components to mains power until all connections between components have been completed.

Be sure all connections are made correctly, that is to say L (left) to L, R (right) to R, “+” to “+” and “-” to “-”. Some components require different connection methods and have different terminal names. Refer to the instructions for each component to be connected to this unit.

When you connect other YAMAHA audio components (such as a tape deck, MD recorder and CD player or changer), connect it to the terminals with the same number labels as **1**, **3**, **4** etc. YAMAHA applies this labeling system to all its products.

Use RCA-type pin plug cables for connecting audio/video components with the exception described later.

The input and output terminals for pin plugs can be distinguished as follows:

Yellow	video signals (composite)		
White	analog audio signals for the left channel		
Red	analog audio signals for the right channel		
	coaxial digital signals		

After completing all connections, check them again to make sure they are correct.

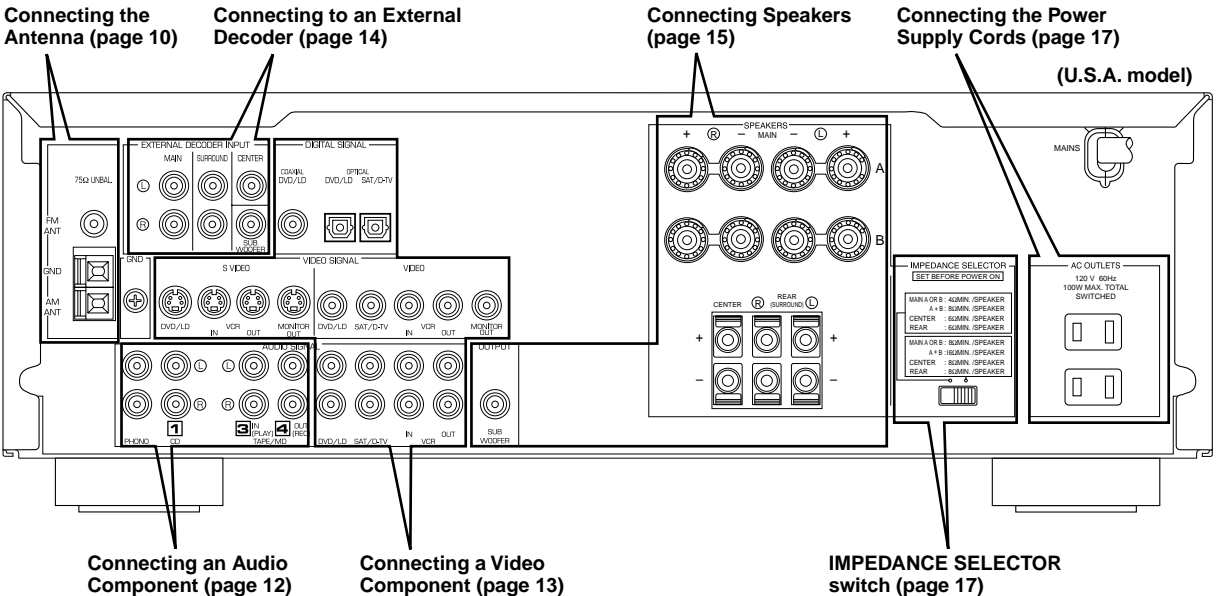

## Connecting the Antennas

Both AM and FM indoor antennas are included with this unit. In general, these antennas should provide sufficient signal strength. However, a properly installed outdoor antenna provides clearer reception than an indoor one. If you experience poor reception quality, an outdoor antenna may improve the quality.

Connect each antenna correctly to the designated terminals.

### Indoor FM antenna (included)

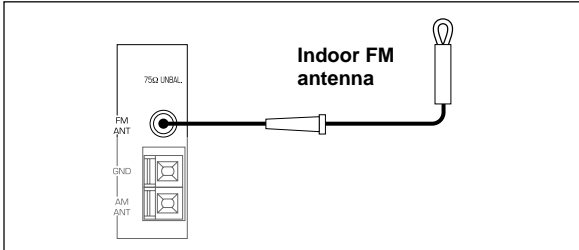

Firmly insert the connector into the FM ANT terminal. The indoor FM antenna is only a simple antenna. For reception with better sound quality, installing the outdoor FM antenna (commercially available) is recommended.

**Note**

- Do not connect an outdoor FM antenna and the indoor FM antenna at the same time.

### Outdoor FM antenna

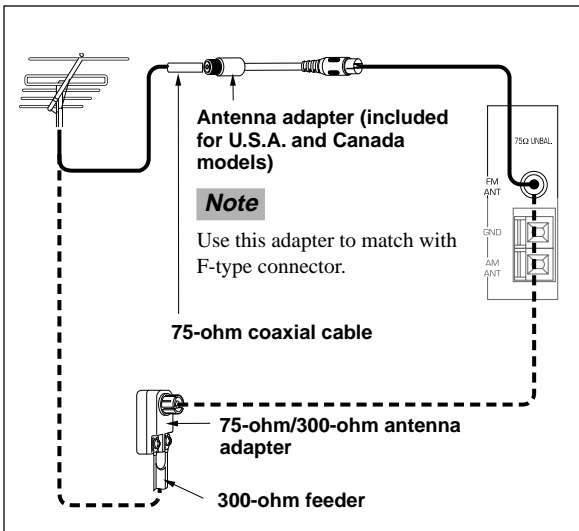

**Note**

Use this adapter to match with F-type connector.

You may be unable to obtain good FM radio reception depending on your local conditions (distance from the broadcasting station, interposing buildings and mountains, etc.). Consult your dealer or authorized service center and be sure to install an antenna that suits your local conditions.

Install the outdoor FM antenna (commercially available) in a high place as far away from any roads as possible to avoid being affected by automobile ignition noise.

## ■ AM loop antenna (included)

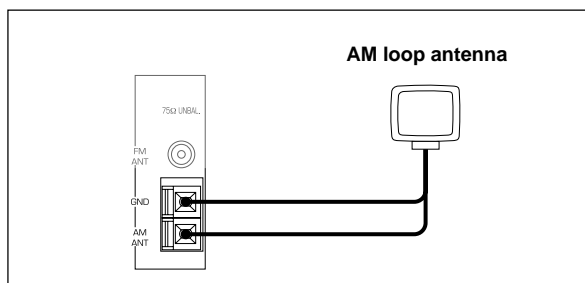

The AM loop antenna can be removed from the stand and attached to a wall, etc. However, note that the reception sensitivity may deteriorate if the antenna is attached to a metal or steel reinforced wall.

### Notes

- The AM loop antenna should be placed away from this unit.
- The AM loop antenna should always be connected, even if an outdoor AM antenna is connected to this unit.

## ■ Connecting the AM loop antenna

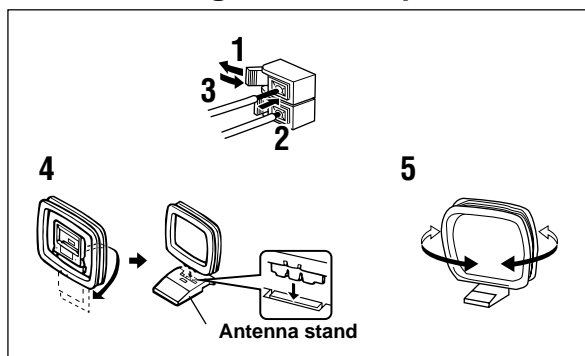

- 1** Press the tab and unlock the terminal hole.
- 2** Insert the AM loop antenna lead wires into the AM ANT and GND terminals.
- 3** Return the tab to its original position to lock the lead wires. Lightly pull the lead wires to confirm a good connection.
- 4** Attach the loop antenna to the antenna stand.
- 5** Orient the AM loop antenna so that the best reception is obtained.

## ■ Outdoor AM antenna

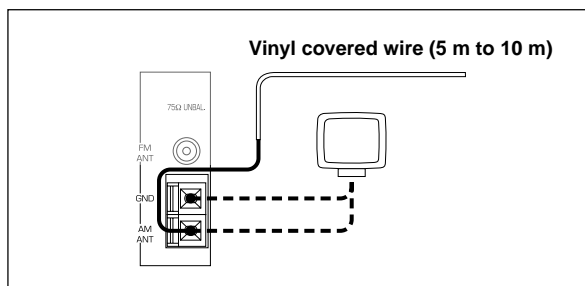

If you cannot obtain good reception with the AM loop antenna, connect 5 m to 10 m of vinyl covered wire to the AM ANT terminal and extend it outdoors from a window.

## ■ Ground (GND terminal)

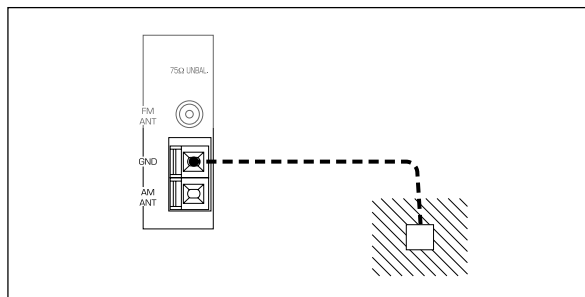

For maximum safety and minimum interference, connect the antenna GND terminal to a good earth ground. A good earth ground is a metal stake driven into moist earth.

## Connecting an Audio Component

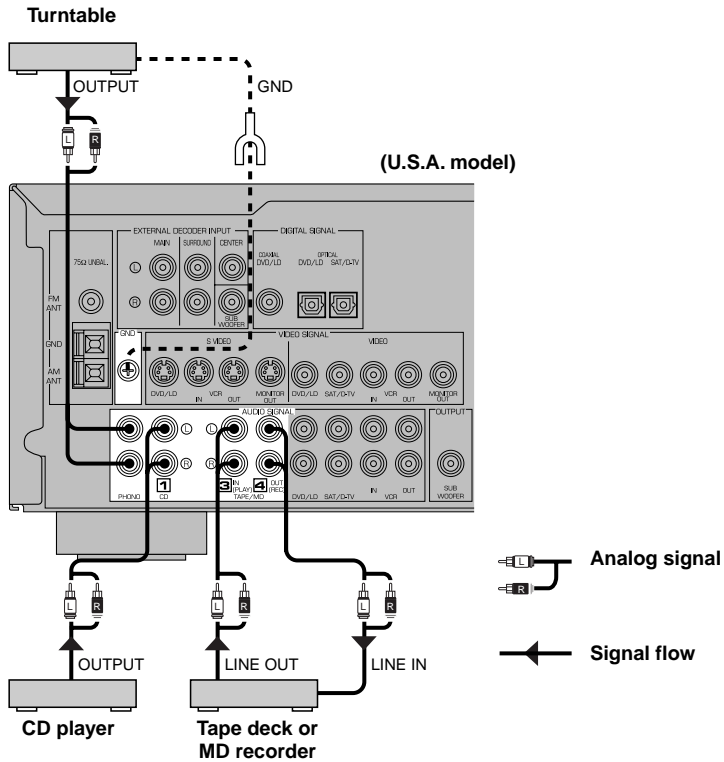

Be sure to connect the right channel (R), left channel (L), input (IN) and output (OUT) properly.

### ■ PHONO terminals

These terminals are used to connect a turntable with an MM or high-output MC cartridge. If you have a turntable with a low-output MC cartridge, use an inline boosting transformer or MC head amplifier when connecting to these terminals.



Connecting the ground (earth) wire of the turntable to the GND terminal will normally minimize hum, but in some cases, better results may be obtained with the ground wire disconnected.



## Connecting a Video Component

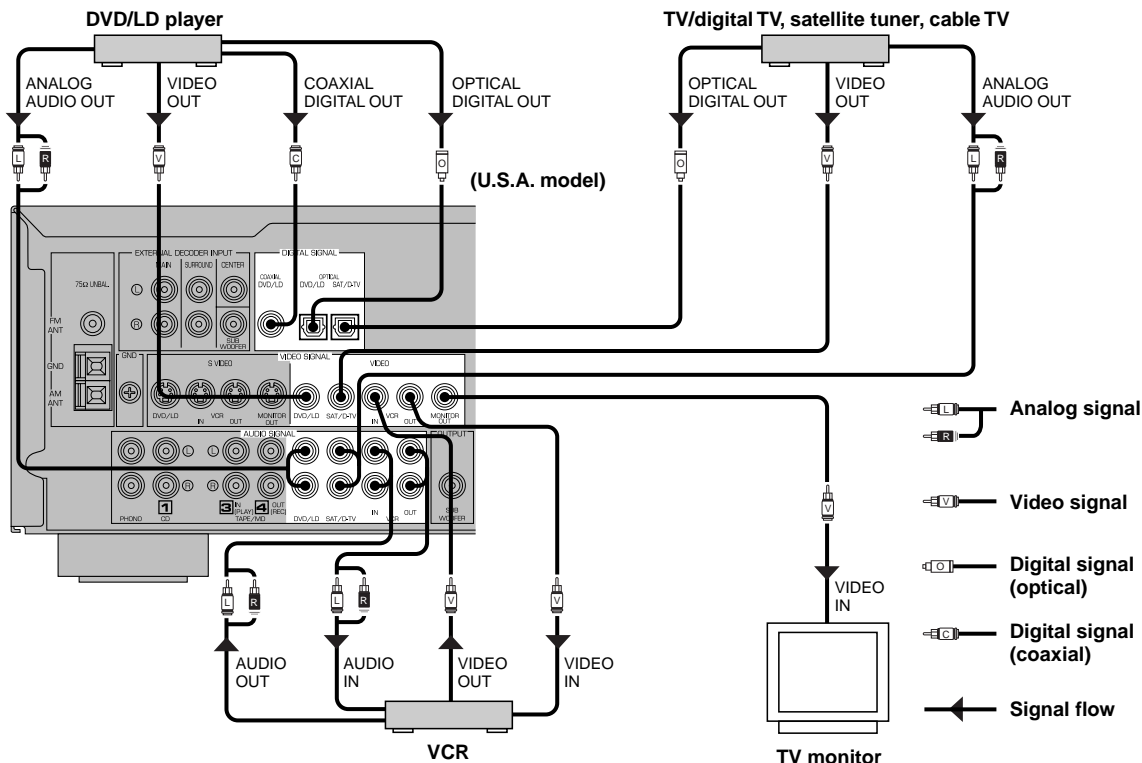

PREPARATION

### ■ Audio signal terminals

Be sure to connect the right channel (R), left channel (L), input (IN) and output (OUT) properly.

### ■ Video signal terminals

Be sure to connect the input (IN) and output (OUT) properly.

### ■ Digital audio signal terminals

If your DVD/LD player, TV/digital TV or satellite tuner, etc. has coaxial or optical digital signal output terminals, they can be connected to this unit's COAXIAL and/or OPTICAL digital signal input terminals. To make a connection between the optical digital signal terminals, remove the cover from each terminal, and then connect them by using a commercially available optical fiber cable that conforms to EIA standards. Other cables might not function correctly.

When making connections between the digital signal terminals, you should connect the components to the same-named analog audio signal terminals of this unit, because a digital signal cannot be recorded by a tape deck, MD recorder or VCR connected to this unit.

### Notes

- Be sure to attach the covers when the OPTICAL terminals are not being used in order to protect them from dust.
- If your LD player has a Dolby Digital RF signal output terminal, be sure to use the RF demodulator (separately purchased).
- No sound will be heard when connecting your LD player's Dolby Digital RF signal output terminal directly to this unit's COAXIAL DVD/LD digital signal input terminal.



- The input signal from the DVD/LD input terminals is selected in the following order of priority with the input mode set to AUTO: COAXIAL terminal → OPTICAL terminal → Analog terminal. Refer to page 22 for details.
- All digital signal input terminals are applicable to sampling frequencies of 32 kHz, 44.1 kHz and 48 kHz.

English

## S VIDEO terminals

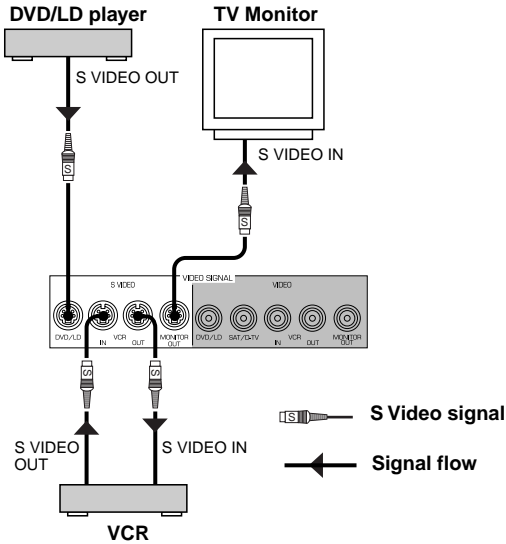

If your VCR, TV monitor or DVD/LD player has “S” (high-resolution) video terminals, they can be connected to this unit’s S VIDEO terminals. Connect the VCR’s “S” video input and output terminals to this unit’s S VIDEO VCR OUT and IN terminals, respectively. Connect the monitor’s “S” video input terminal to this unit’s S VIDEO MONITOR OUT terminal. Connect the DVD/LD player’s “S” video output terminal to this unit’s S VIDEO DVD/LD terminal. Otherwise, connect the composite video terminals of your VCR, TV monitor or DVD/LD player to this unit’s composite video terminals.

### Notes

- Use a special S VIDEO cable (commercially available) for the S VIDEO connection.
- If video signals are input from both the S VIDEO input and composite input terminals, the signals will be directed to their respective output terminals.

## VIDEO AUX terminals (on the front panel)

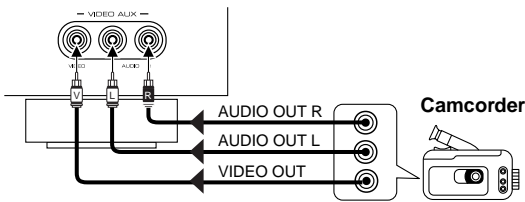

These terminals are used to connect any video input source such as a camcorder to this unit.

## Connecting to an External Decoder

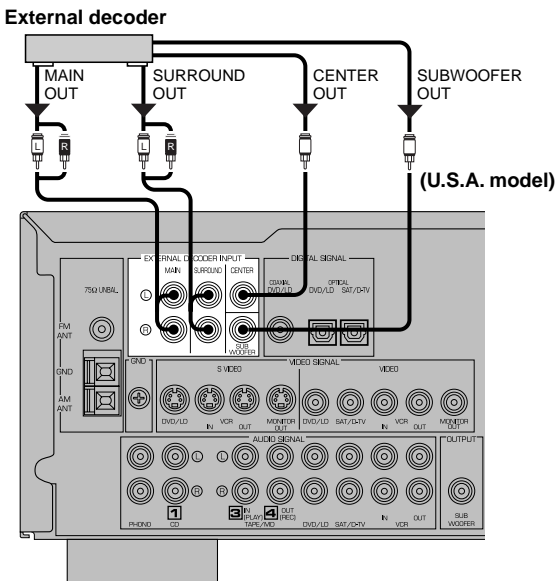

This unit has additional 6-channel audio signal input terminals for connecting an external decoder to this unit. Connect the 6-channel audio signal output terminals of the decoder to the EXTERNAL DECODER INPUT terminals of this unit.

### Notes

- When a source connected to these terminals is selected, the digital sound field processor cannot be used.
- The settings of “CENTER SP”, “REAR SP”, “MAIN SP” and “BASS OUT” in the SET MENU have no effect on a source connected to these terminals. The setting of “MAIN LVL” is effective. (Refer to pages 34 and 35 for details.)

## Connecting Speakers

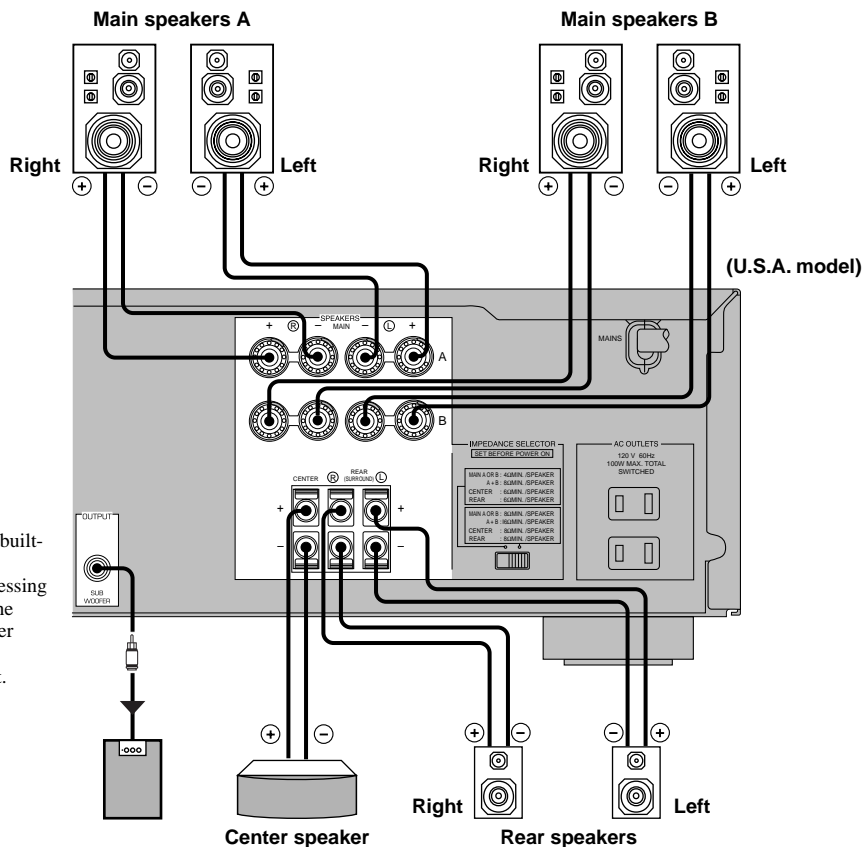

### Subwoofer connection

If you have a subwoofer with built-in amplifier, including the YAMAHA Active Servo Processing Subwoofer System, connect the input terminal of the subwoofer system to the SUBWOOFER OUTPUT terminal of this unit.

Be sure to connect the right channel (R), left channel (L), “+” (red) and “-” (black) properly. If the connections are faulty, no sound will be heard from the speakers, and if the polarity of the speaker connections is incorrect, the sound will be unnatural and lack bass.

### CAUTIONS

- Use speakers with the specified impedance shown on the rear panel of this unit.
- Do not let the bare speaker wires touch each other and do not let them touch any metal part of this unit. This could damage the unit and/or speakers.

### ■ Main speaker terminals

One or two speaker systems can be connected to these terminals. If you use only one speaker system, connect it to either of the SPEAKERS A or B terminals.

### ■ Rear speaker terminals

A rear speaker system can be connected to these terminals.

### ■ Center speaker terminal

A center speaker can be connected to this terminal.

## ■ Speaker cables

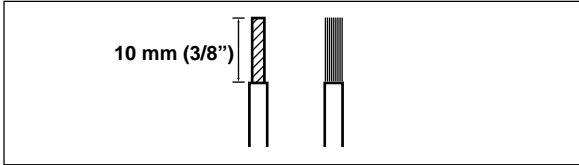

- 1** Remove approx. 10 mm (3/8") of insulation from each of the speaker cable.
- 2** Twist the exposed wires of the cable together to prevent short circuits.

## ■ Connecting to the MAIN SPEAKERS terminals

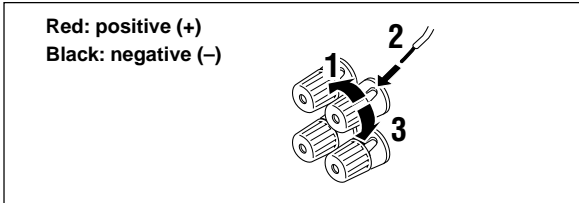

- 1** Unscrew the knob.
- 2** Insert one bare wire into the hole in the side of each terminal.
- 3** Tighten the knob to secure the wire.

## ■ Connecting to the REAR and CENTER SPEAKERS terminals

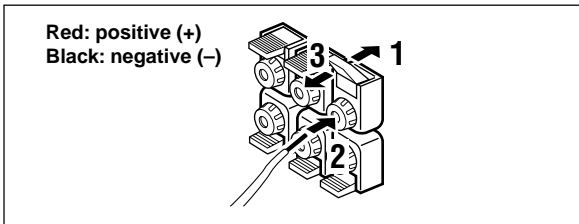

- 1** Open the tab.
- 2** Insert one bare wire into the hole of each terminal.
- 3** Return the tab to secure the wire.

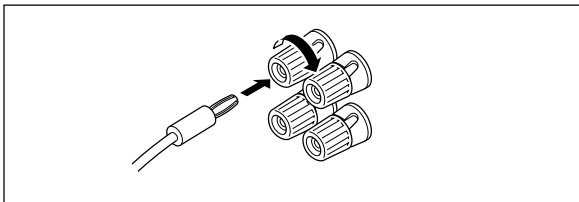

Banana plug connections are also possible. Simply insert the banana plug connector into the corresponding terminal.

## IMPEDANCE SELECTOR Switch

### WARNING

Do not change the IMPEDANCE SELECTOR switch setting while the power to this unit is on, otherwise the unit may be damaged.

If this unit fails to turn on when STANDBY/ON is pressed, the IMPEDANCE SELECTOR switch may not be fully slide to either position. If so, slide the switch to either position fully when this unit is in the standby mode.

Select the right or left position according to the impedance of speakers in your system. Be sure to move this switch only when this unit is in the standby mode.

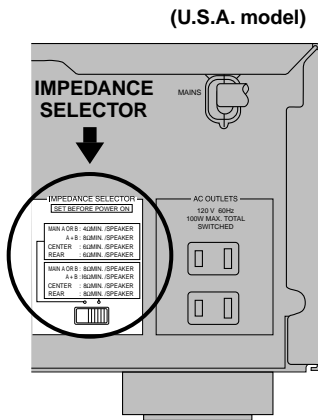

If you use	left position	right position
Center speaker	The impedance must be 6 Ω or higher.	The impedance must be 8 Ω or higher.
Rear speakers	The impedance of each speaker must be 6 Ω or higher.	The impedance of each speaker must be 8 Ω or higher.
Main speakers	If you use one pair of main speakers, the impedance of each speaker must be 4 Ω or higher.	If you use one pair of main speakers, the impedance of each speaker must be 8 Ω or higher.
	If you use two pairs of main speakers, the impedance of each speaker must be 8 Ω or higher.	If you use two pairs of main speakers, the impedance of each speaker must be 16 Ω or higher. [Canada model only] The impedance of each speaker must be 8 Ω or higher.

PREPARATION

## Connecting the Power Supply Cords

After completing all connections, connect the AC power cord to an AC power outlet. Disconnect the AC power cord if you will not use this unit for a long period of time.

### ■ AC OUTLETS (SWITCHED)

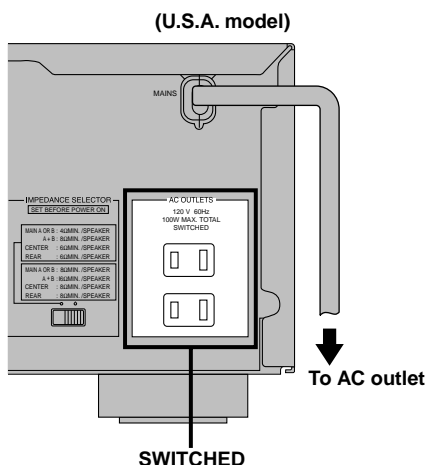

U.S.A. and Canada models ..... 2 OUTLETS  
 Australia model ..... 1 OUTLET  
 Use these outlets to connect the power cords from your components to this unit. The power to the AC OUTLET(S) is controlled by this unit's STANDBY/ON (or POWER). These outlets will supply power to any connected component whenever this unit is turned on. The maximum power (total power consumption of components) that can be connected to the AC OUTLET(S) is 100 W.

English



# ADJUSTING THE SPEAKER BALANCE

This procedure lets you adjust the sound output level balance between the main, center and rear speakers by using the built-in test tone generator. When this adjustment is performed, the sound output level heard at the listening position will be the same from each speaker. This is important for the best performance of the digital sound field processor, the Dolby Pro Logic decoder, Dolby Digital decoder and DTS decoder.

## Before You Start Adjusting

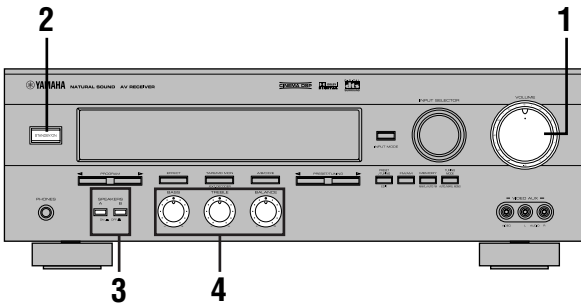

**1** Set VOLUME to the “∞” position.

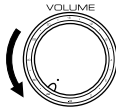

**2** Turn the power on.



**3** Press SPEAKERS A or B to select the main speakers to be used.

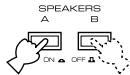

If you use two main speaker systems, press both A and B.

**4** Set BASS, TREBLE and BALANCE to the “0” position.

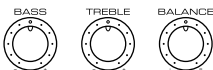

## Using the Test Tone

The adjustment of each speaker sound output level should be performed at your listening position with the remote control. After completing the adjustments, use VOLUME (∧/∨) at your listening position to check if the adjustments are satisfactory.

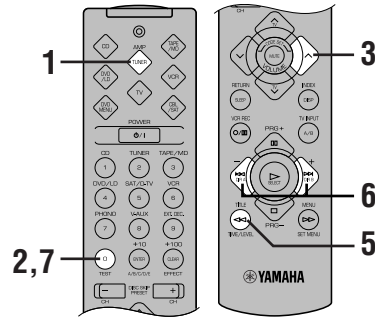

**1** Press AMP(TUNER) on the component selector.



**2** Press TEST.

“TEST LEFT” appears on the display.



TEST LEFT

**3** Turn up the volume.

You will hear a test tone (like pink noise) from each speaker for about two seconds in following order: left main speaker, center speaker, right main speaker, right rear speaker and left rear speaker. The display changes as shown below.

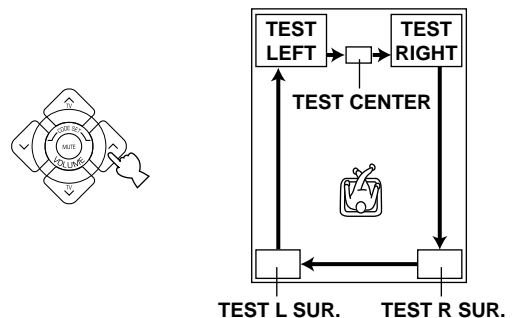

### Notes

- If the test tone cannot be heard, turn down the volume, set the unit in the standby mode and check the speaker connections.
- If the test tone cannot be heard from the center speaker, check the setting of “CENTER SP” in the SET MENU.

- 4** Adjust **BALANCE** on the front panel so that the sound output level of the right main speaker and the left main speaker is the same.

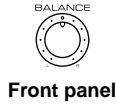

- 5** Press **TIME/LEVEL** repeatedly to select the speaker to be adjusted. “CENTER”, “R SUR.” or “L SUR.” appears on the display.



- 6** Press **+** to raise and **-** to lower the level. Adjust the sound output levels of the center speaker and the rear speakers so that they become almost the same as that of the main speakers.

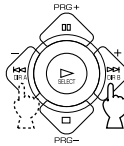

While adjusting, the test tone is heard from the selected speaker.

**Note**

- You cannot adjust the delay time while the test tone is being heard even if “DELAY” appears on the display.

- 7** When the adjustment is complete, press **TEST**. “TEST OFF” appears on the display and the test tone stops.



**Note**

- If “CENTER SP” in the SET MENU is set to the NONE position, the sound output level of the center speaker cannot be adjusted in step 6. The center channel sound is automatically output from the right and left main speakers.



- Once you have completed the adjustments, you can only adjust the overall volume level of your audio system by using **VOLUME** (or **VOLUME** (∧/∨)).
- If there is insufficient sound output from the center and rear speakers, you may decrease the main speaker output level by setting “MAIN LVL” in the SET MENU to “-10 dB”. (Refer to page 35 for details.)

# PLAYING A SOURCE

When using the remote control, press AMP(TUNER) on the component selector.

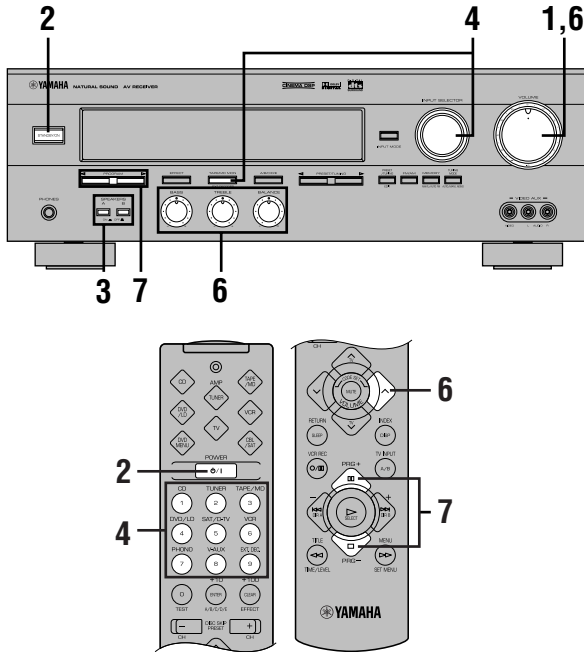

**4** Select the desired input source with **INPUT SELECTOR** (or the input selector buttons). (Turn on the TV monitor for video sources.)

The name of the selected input source appears for a moment and the arrow for the selected input source indicator lights up on the display.

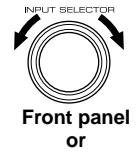

Front panel or

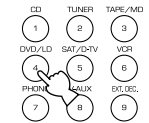

Remote control



Input source

**a.** To select a tape or an MD source

Press TAPE/MD MON / EXT. DECODER (or TAPE/MD) so that the “TAPE/MD MONITOR” indicator lights up on the display.

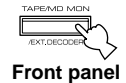

Front panel

**b.** To select a source connected to the **EXTERNAL DECODER INPUT terminals**

Press TAPE/MD MON / EXT. DECODER repeatedly (or EXT. DEC.) until “EXT. DECODER” appears on the display.

**1** Set **VOLUME** to the “∞” position.

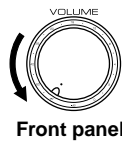

Front panel

**2** Turn the power on.



Front panel

or



Remote control

**3** Press **SPEAKERS A or B** to select the main speakers to be used.

If you use two main speaker systems, press both A and B.

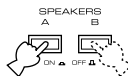

Front panel

## Notes

- An audio source can not be played if the “TAPE/MD MONITOR” indicator lights up or if “EXT. DECODER” appears. Press TAPE/MD MON / EXT. DECODER twice (or TAPE/MD once) to turn off the “TAPE/MD MONITOR” indicator. Press TAPE/MD MON / EXT. DECODER once (or EXT. DEC.) to turn off “EXT. DECODER”.
- If you select and play a video source when the “TAPE/MD MONITOR” indicator lights up or “EXT. DECODER” appears, the play back result will be a video image from the video source and the sound from the audio source selected by using TAPE/MD MON / EXT. DECODER (or TAPE/MD or EXT. DEC.).



For the DVD/LD, TV/digital TV and satellite tuner sources, the current input mode is also shown. Refer to page 22 for details about the input mode.



**5 Play the source.**

Refer to the instructions for the source component (and page 28 for details about tuning).

**Note**

- When controlling an audio/video component (tape deck, MD recorder, CD player, DVD/LD player, etc.) with the remote control, press one of the component selector buttons, (TAPE/MD, CD, DVD/LD, etc.), which corresponds to the component you want to control. Refer to "PRESET REMOTE CONTROL" on page 40.

**6 Adjust the volume to the desired output level.**

If desired, adjust BASS, TREBLE, BALANCE, etc. These controls are only effective for the sound from the main speakers.

- BASS controls the low-frequency response.
- TREBLE controls the high-frequency response.
- BALANCE adjusts the balance of the output volume from the right and left main speakers.

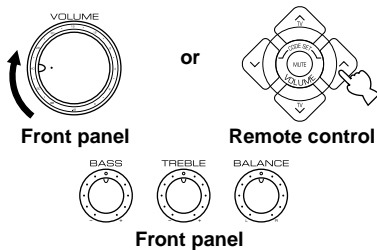
**7 Use the digital sound field processor.**

Refer to page 24.

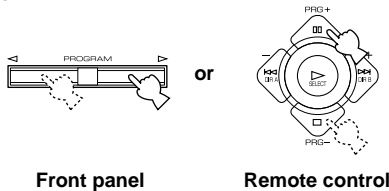
**To mute the sound**

Press **MUTE** on the remote control.

To cancel mute, press MUTE.

**Note**

- During muting, "MUTE ON" appears on the display.

**When you have finished using this unit**

Press **STANDBY/ON** (or **POWER**) to set this unit in the standby mode.

**BGV (background video) function**

The BGV function allows you to combine a video image from a video source with a sound from an audio source. (For example, you can listen to classical music while you are watching a video.) This function can only be controlled with the remote control.

Play a video source, and then select an audio source with the input selector buttons on the remote control. The BGV function does not work if you select the audio source with **INPUT SELECTOR** on the front panel.

## Input Mode (for the DVD/LD and TV/digital TV and satellite tuner sources)

This unit allows you to switch the input mode for sources that send both digital and analog signals to this unit. The AUTO, DTS and ANALOG input modes are provided.

When you turn on the power of this unit, the input mode for the DVD/LD source is always set to AUTO and for TV/digital TV or satellite tuner source is set according to "SAT INPUT" in the SET MENU. (Refer to page 36 for details.)

### AUTO

In this mode, the input signal is selected in the following order of priority:

1. Digital signal encoded with Dolby Digital or DTS
2. Normal digital signal (PCM)
3. Analog signal (ANALOG)

#### Note

- If digital signals are input from both the OPTICAL and COAXIAL terminals, the digital signal from the COAXIAL terminal is selected.

### DTS

In this mode, only a digital signal encoded with DTS is selected, even if other signals are being input at the same time.

### ANALOG

In this mode, only an analog signal is selected, even if a digital signal is being input at the same time. Select this mode when you want to use an analog signal instead of a digital signal.

## Switching the input mode

Press INPUT MODE (or the input selector button that you have pressed to select the input source on the remote control) repeatedly until the desired input mode is shown on the display.



Front panel

or

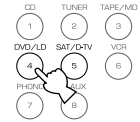

Remote control

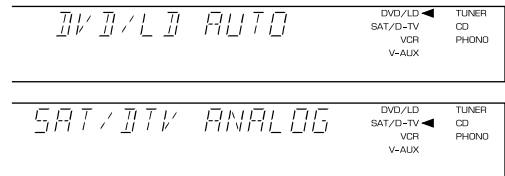

#### Notes

- Set the input mode to AUTO to play a DVD/LD source encoded with Dolby Digital.
- Set the input mode to ANALOG to play a normal 2-channel source with a Dolby Surround program.
- The sound output may be interrupted for some LD and DVD players in the following situation: The input mode is set to AUTO. A search is performed while playing the disc encoded with Dolby Digital or DTS, and then disc playing is restored. The sound output is interrupted for a moment because the digital signal was selected again.
- The input mode cannot be changed for the CD, TUNER, TAPE/MD, VCR, PHONO and VIDEO AUX sources because only analog signals are used for these.
- The current input mode appears on the display when the DVD/LD, TV/digital TV or satellite tuner source is selected or the input mode is changed.

## ■ Notes on playing a source encoded with DTS

- If “DATA ERROR” appears on the display while playing an LD source encoded with DTS, stop playback and turn the player off and then on again.
- If the digital output data of the player has been processed in any way, you may not be able to perform DTS decoding even if you make a digital connection between this unit and the player.
- If you play an LD source encoded with DTS and set the input mode to ANALOG, there will be the noise of an unprocessed DTS signal. When you want to play a DTS source, be sure to connect the source to the digital input terminal and set the input mode to AUTO or DTS.
- If you switch the input mode to ANALOG while playing a source encoded with a DTS signal, this unit reproduces no sound.
- If you play an LD source encoded with DTS and set the input mode to AUTO, there will be a short noise at first while the unit recognizes the DTS signal and turns on the DTS decoder. This is not a malfunction, and can be avoided by setting the input mode to DTS beforehand. In addition, if you continue to play an LD encoded with DTS with the input mode setting left to AUTO, this unit automatically switches to the “DTS-decoding” mode to prevent noise from being generated during subsequent operation. (The “**dts**” indicator lights up on the display.) No sound will be heard if a normal PCM LD is played in this mode. (The “**dts**” indicator will flash.) To play a normal disk, set the input mode to AUTO again.

## ■ Notes on playing an LD source

- Some audio/video component, such as LD player, output different audio signals through their analog and digital terminals. Change the input mode as necessary.
- If the input mode is set to AUTO for the LD source, this unit automatically determines which type of signal the LD source contains. If this unit detects a Dolby Digital or DTS signal, the decoder automatically switches to the appropriate setting and reproduces 5.1 channel sound.
- If the LD player is transmitting signals by a non-normal method, this unit cannot detect the Dolby Digital or DTS signal. In this case, the decoder automatically switches to PCM or analog.
- If the LD source does not contain a digital soundtrack, connect the LD player to the analog terminals and set the input mode to AUTO or ANALOG.
- While you are operating the LD player, if you switch from the pause or chapter forwarding function to normal playback, you may hear the PCM or analog sound an instant before the Dolby Digital sound is played.

# DIGITAL SOUND FIELD PROCESSOR (DSP) EFFECT

## Selecting a DSP Program

You can enhance your listening experience by selecting a DSP program. Refer to pages 25 to 27 for details about each program.

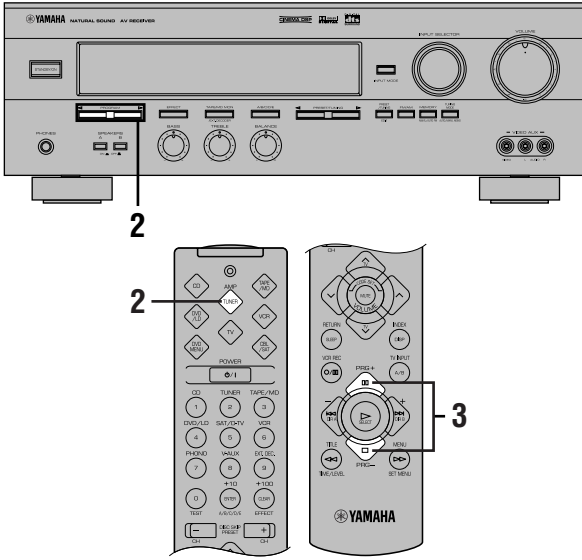

- Press PRG+ or PRG- repeatedly to select the desired program.

The name of the selected program appears on the display.

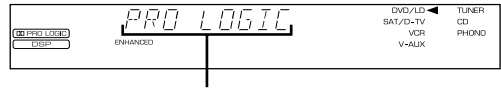
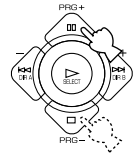

DSP program name



If desired, adjust the delay time and the sound output level of each speaker. (Refer to pages 37 and 38 for details.)

### Notes

- You can select a DSP program for each of the input sources. Once you select a program, it is linked with the input source selected at that time. So, when you select the input source next time, the same program is automatically selected.
- When a monaural source is being played with PRO LOGIC/Normal or PRO LOGIC/ENHANCED, no sound will be heard from the main speakers and the rear speakers. Sound can only be heard from the center speaker. However, if "CENTER SP" in the SET MENU is set to the NONE position, the center channel sound is output from the main speakers.
- When a source connected to the EXTERNAL DECODER INPUT terminals of this unit is selected, the digital sound field processor cannot be used.

## On the front panel

- Make sure that the effect speakers (center, rear, and subwoofer) are turned on.

- Press PROGRAM ► or ◀ repeatedly to select the desired program.

The name of the selected program appears on the display.

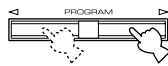

DSP program name

## On the remote control

- Make sure that the effect speakers (center, rear, and subwoofer) are turned on.

- Press AMP(TUNER) on the component selector.



## Canceling the Sound Effect (turning off the effect speakers)

Press EFFECT to cancel the sound effect and monitor only the main sound.

Press EFFECT again to turn the sound effect back on.



Front panel or



Remote control

### Notes

- If the sound effect is canceled when Dolby Digital or DTS is decoding, the sounds of all channels are mixed and output from the main speakers.
- If you turn off the sound effect when Dolby Digital or DTS is decoding, it may happen that the sound is output faintly or not output normally, depending on the source. In that case, turn back on the sound effect.



# SOUND FIELD PROGRAM

This unit incorporates a sophisticated, multi-program digital sound field processor (DSP). This processor allows you to electronically expand and change the shape of the audio sound field from both audio and video sources, creating a theater-like experience in your listening room. You can create outstanding audio sound by selecting a suitable DSP program (this will, of course, depend on what you are listening to).

When you select a CINEMA DSP program, one of the built-in decoders (Dobly Pro Logic, Dolby Digital and DTS) is turned on according to which type of signals the source being played contains.

The following list gives you a brief description of the sound fields produced by each of the DSP programs. Keep in mind that most of these are precise digital re-creations of actual acoustic environments.

## ■ For movie or audio/video sources (Program No. 1 to No. 5: CINEMA DSP programs)

No.	PROGRAM	SUBPROGRAM	FEATURES
1	■■/DTS SURROUND	<b>[1] PRO LOGIC/Normal ( <input checked="" type="checkbox"/> PRO LOGIC )</b> • Input source: Dolby Surround 2-ch Dolby Digital • Output channel: 4 channels • DSP: —	The built-in Dolby Pro Logic decoder, Dolby Digital decoder or DTS decoder precisely reproduces the sound and effect of a source encoded with Dolby Surround, Dolby Digital or DTS. The realization of a highly efficient decoding process improves cross talk and channel separation, and makes sound positioning smoother and more precise. In this program, the digital sound field processor is not turned on.
		<b>[2] DOLBY DIGITAL/Normal ( <input checked="" type="checkbox"/> DIGITAL )</b> • Input source: Dolby Digital • Output channel: 5.1 channels • DSP: —	
		<b>[3] DTS DIGITAL SUR/Normal ( <input checked="" type="checkbox"/> )</b> • Input source: DTS • Output channel: 5.1 channels • DSP: —	
		<b>[4] PRO LOGIC/ENHANCED ( <input checked="" type="checkbox"/> PRO LOGIC <input type="checkbox"/> DSP )</b> • Input source: Dolby Surround 2-ch Dolby Digital • Output channel: 4 channels • DSP: 1 (surround)	This program ideally simulates the multi-surround speaker systems of the 35 mm-film movie theater. Dolby Pro Logic decoding, Dolby Digital decoding or DTS decoding and digital sound field processing are precisely performed without altering the original sound orientation. The surround effect produced by the sound field folds around the viewer naturally from the rear to the right and left and toward the screen.
		<b>[5] DOLBY DIGITAL/ENHANCED ( <input checked="" type="checkbox"/> DIGITAL <input type="checkbox"/> DSP )</b> • Input source: Dolby Digital • Output channel: 5.1 channels • DSP: 2 (surround L, R)	
		<b>[6] DTS DIGITAL SUR/ENHANCED ( <input checked="" type="checkbox"/> <input type="checkbox"/> DSP )</b> • Input source: DTS • Output channel: 5.1 channels • DSP: 2 (surround L, R)	

No.	PROGRAM	SUBPROGRAM	FEATURES
2	<b>MOVIE THEATER 1</b>	<p><b>[1] 70 mm SPECTACLE</b>  <input checked="" type="checkbox"/> PRO LOGIC <input type="checkbox"/> DSP )</p> <ul style="list-style-type: none"> <li>• Input source: Dolby Surround 2-ch Dolby Digital</li> <li>• Output channel: 3 channels</li> <li>• DSP: 2 (presence &amp; surround)</li> </ul> <p><b>[2] DGTL SPECTACLE</b>  <input checked="" type="checkbox"/> DIGITAL <input type="checkbox"/> DSP )</p> <ul style="list-style-type: none"> <li>• Input source: Dolby Digital</li> <li>• Output channel: 5.1 channels</li> <li>• DSP: 3 (presence &amp; surround L, R)</li> </ul> <p><b>[3] DTS SPECTACLE ( <b>dts</b> <input type="checkbox"/> DSP )</b></p> <ul style="list-style-type: none"> <li>• Input source: DTS</li> <li>• Output channel: 5.1 channels</li> <li>• DSP: 3 (presence &amp; surround L, R)</li> </ul> <hr/> <p><b>[4] 70 mm SCI-FI ( <input checked="" type="checkbox"/> PRO LOGIC <input type="checkbox"/> DSP )</b></p> <ul style="list-style-type: none"> <li>• Input source: Dolby Surround 2-ch Dolby Digital</li> <li>• Output channel: 3 channels</li> <li>• DSP: 2 (presence &amp; surround)</li> </ul> <p><b>[5] DGTL SCI-FI ( <input checked="" type="checkbox"/> DIGITAL <input type="checkbox"/> DSP )</b></p> <ul style="list-style-type: none"> <li>• Input source: Dolby Digital</li> <li>• Output channel: 5.1 channels</li> <li>• DSP: 3 (presence &amp; surround L, R)</li> </ul> <p><b>[6] DTS SCI-FI ( <b>dts</b> <input type="checkbox"/> DSP )</b></p> <ul style="list-style-type: none"> <li>• Input source: DTS</li> <li>• Output channel: 5.1 channels</li> <li>• DSP: 3 (presence &amp; surround L, R)</li> </ul>	<p>This program creates the extremely wide sound field of a movie theater. It precisely reproduces the source sound in detail, giving both the video and the sound field incredible reality. It is ideal for any kind of video source encoded with Dolby Surround, Dolby Digital or DTS (especially large-scale movie productions).</p> <hr/> <p>Clearly reproduces dialog and sound effects in the latest sound form of science fiction films, thus creating a broad and expansive cinematic space amid the silence. You can enjoy science fiction films in a virtual-space sound field that includes Dolby Surround, Dolby Digital and DTS-encoded software employing the most advanced techniques.</p>
3	<b>MOVIE THEATER 2</b>	<p><b>[1] 70 mm ADVENTURE</b>  <input checked="" type="checkbox"/> PRO LOGIC <input type="checkbox"/> DSP )</p> <ul style="list-style-type: none"> <li>• Input source: Dolby Surround 2-ch Dolby Digital</li> <li>• Output channel: 3 channels</li> <li>• DSP: 2 (presence &amp; surround)</li> </ul> <p><b>[2] DGTL ADVENTURE</b>  <input checked="" type="checkbox"/> DIGITAL <input type="checkbox"/> DSP )</p> <ul style="list-style-type: none"> <li>• Input source: Dolby Digital</li> <li>• Output channel: 5.1 channels</li> <li>• DSP: 3 (presence &amp; surround L, R)</li> </ul> <p><b>[3] DTS ADVENTURE ( <b>dts</b> <input type="checkbox"/> DSP )</b></p> <ul style="list-style-type: none"> <li>• Input source: DTS</li> <li>• Output channel: 5.1 channels</li> <li>• DSP: 3 (presence &amp; surround L, R)</li> </ul> <hr/> <p><b>[4] 70 mm GENERAL ( <input checked="" type="checkbox"/> PRO LOGIC <input type="checkbox"/> DSP )</b></p> <ul style="list-style-type: none"> <li>• Input source: Dolby Surround 2-ch Dolby Digital</li> <li>• Output channel: 3 channels</li> <li>• DSP: 2 (presence &amp; surround)</li> </ul> <p><b>[5] DGTL GENERAL ( <input checked="" type="checkbox"/> DIGITAL <input type="checkbox"/> DSP )</b></p> <ul style="list-style-type: none"> <li>• Input source: Dolby Digital</li> <li>• Output channel: 5.1 channels</li> <li>• DSP: 3 (presence &amp; surround L, R)</li> </ul> <p><b>[6] DTS GENERAL ( <b>dts</b> <input type="checkbox"/> DSP )</b></p> <ul style="list-style-type: none"> <li>• Input source: DTS</li> <li>• Output channel: 5.1 channels</li> <li>• DSP: 3 (presence &amp; surround L, R)</li> </ul>	<p>Ideal for precisely reproducing the sound of the newest multi-track films. The sound field is made to be similar to that of the newest movie theaters, so the reverberations of the sound field itself are restrained as much as possible. The data for the sound field of an opera house are used for the front presence, so the three-dimensional feeling of the sound field is emphasized, and dialog is precisely oriented on the screen. By using the data for the sound field of a concert hall on the surround sound field, powerful reverberations are generated. You can enjoy watching action, adventure movies, etc. with strong presence.</p> <hr/> <p>This program is for reproducing sounds on a multi-track film, and is characterized by a soft and extensive sound field. The front presence of the sound field is relatively narrow. It spatially spreads all around and toward the screen, restraining echo effect of conversations without losing clarity. For the surround sound field, the harmony of music or chorus sounds beautifully in a wide space at the rear of the sound field.</p>

No.	PROGRAM	FEATURES
4	<b>MONO MOVIE</b> <ul style="list-style-type: none"> <li>• Input source: Monaural</li> <li>• Output channel: 1 channel</li> <li>• DSP: 1</li> </ul>	This program is designed specifically to enhance monaural sources. Compared to a strictly mono setting, the sound image is wider and slightly forward of the speaker pair, lending an immediacy to the overall sound. It is particularly effective for old mono movie, news broadcasts and dialog.
5	<b>TV SPORTS</b> <ul style="list-style-type: none"> <li>• Input source: Audio/Video</li> <li>• Output channel: 2 to 5.1 channels</li> <li>• DSP: 2 to 3 (presence &amp; surround)</li> </ul>	This program is furnished with a tight sound field in which the sound will not spread excessively at the front, but the rear surround produces dynamic sound expansion. It is the most suitable for sports programs.

## ■ For Hi-Fi audio sources

No.	PROGRAM	FEATURES
6	<b>DISCO</b> <ul style="list-style-type: none"> <li>• Input source: 2-ch PCM/Analog audio</li> <li>• Output channel: 2 channels</li> <li>• DSP: 1</li> </ul>	This program simulates the acoustic environment of a disco in the heart of a lively city. The sound is dense and highly concentrated.
7	<b>ROCK CONCERT</b> <ul style="list-style-type: none"> <li>• Input source: 2-ch PCM/Analog audio</li> <li>• Output channel: 2 channels</li> <li>• DSP: 1</li> </ul>	This program is ideally suited for rock music. You will experience a dynamic and lively sound field.
8	<b>CONCERT HALL</b> <ul style="list-style-type: none"> <li>• Input source: 2-ch PCM/Analog audio</li> <li>• Output channel: 2 channels</li> <li>• DSP: 1</li> </ul>	This program creates the expansive ambience of a large concert hall. It is suited for orchestra and opera music.

## **CINEMA DSP: Dolby Surround + DSP/Dolby Digital + DSP/DTS + DSP**

### ■ Dolby Pro Logic + 2 digital sound fields

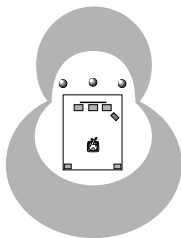

Digital sound fields are created in both the presence and rear surround zones of the Dolby Pro Logic-decoded sound field. They create a wide acoustic environment and emphasize the surround effect in the room, letting you feel as much presence as if you were watching a movie in a popular Dolby Stereo theater.

### ■ Dolby Digital or DTS + 3 digital sound fields

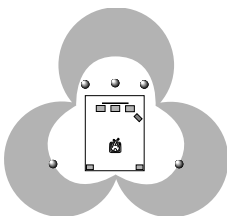

Digital sound fields are created in the presence zone and independently on the left and right surround zones of the Dolby Digital-decoded or DTS-decoded sound field. They create a wide acoustic environment and strong surround effect in the room without losing high channel separation. With the wide dynamic range of Dolby Digital or DTS sound, this sound field combination lets you feel as if you were watching a movie in the newest Dolby Digital theater or DTS-installed theater. This is the most ideal home theater sound at the present time.



# TUNING

Automatic tuning is effective when station signals are strong and there is no interference. However, if the signal from the station you want to select is weak, you must tune in to it manually (manual tuning).

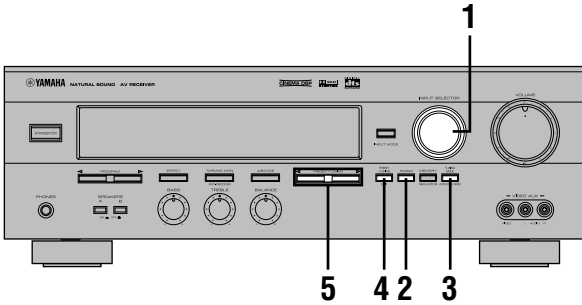

## Automatic Tuning

**1** Use **INPUT SELECTOR** to select the tuner as the input source.

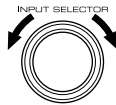

**2** Press **FM/AM** to select the reception band (FM or AM).

“FM” or “AM” appears on the display.



**3** Press **TUNING MODE** so that the “AUTO” indicator lights up on the display.



**4** Press **PRESET/TUNING (EDIT)** to turn “>” off.

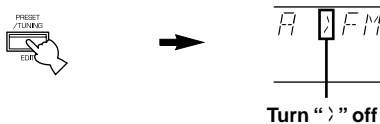

**5** Press **PRESET/TUNING** ► once to tune in to a higher frequency and ◀ once to tune in to a lower frequency.

Press the button again if the tuning search does not stop at the desired station.



### Note

• If you tune in manually to an FM station, it will be automatically received in monaural mode to increase the signal quality.



- Use the manual tuning method if the tuning search does not stop at the desired station (because the signal from the station is weak).
- When tuned in to a station, the frequency of the received station is shown on the display.

## Manual Tuning

**1** Use **INPUT SELECTOR** to select the tuner as the input source.

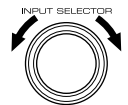

**2** Press **FM/AM** to select the reception band (FM or AM).

“FM” or “AM” appears on the display.



**3** Press **TUNING MODE** so that the “AUTO” indicator goes off.



**4** Press **PRESET/TUNING (EDIT)** to turn “>” off.

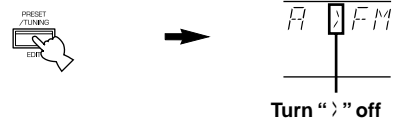

**5** Press **PRESET/TUNING** ► or ◀ to tune in to the desired station.

To continue the tuning search, hold down the button.

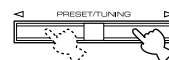



## Automatic Preset Tuning (for FM stations only)

You can make use of the automatic preset tuning function for FM stations only. This function enables the unit to automatically tune in with strong signals and to sequentially store up to 40 FM stations (5 groups x 8 stations).

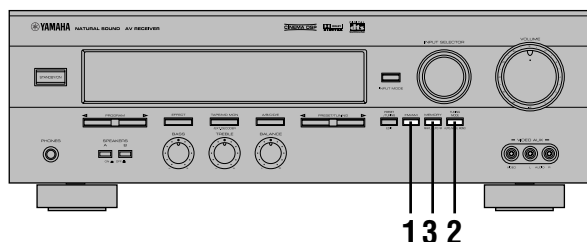

### 1 Press FM/AM to select the FM band.



### 2 Press TUNING MODE so that the "AUTO" indicator lights up on the display.



### 3 Hold down MEMORY for about three seconds.

The preset number, the "MEMORY" and "AUTO" indicators flash. After about five seconds, automatic preset tuning begins from the frequency currently displayed toward the higher frequencies.

Received stations are sequentially stored as A1, A2 ... A8. If more than 8 stations have been tuned, they are stored as preset station numbers in other groups (B, C, D and E) in that order.

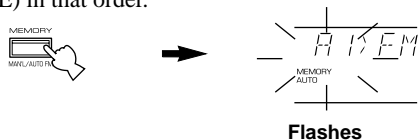

## Automatic preset tuning options

You can select the preset number from which the unit will store FM stations and/or begin tuning toward lower frequencies. Before automatic preset tuning begins (after pressing MEMORY in step 3),

1. Press A/B/C/D/E and PRESET/TUNING to select the preset number with which the first station will be stored. The automatic preset tuning will stop when stations have all been stored up to E8.
2. Press PRESET/TUNING (EDIT) to turn ">" off and then press PRESET/TUNING ◀ to begin tuning toward lower frequencies.

## When automatic preset tuning is completed

The display shows the frequency of the last preset station. Check the contents and the number of preset stations by following the procedure in the section "To Recall a Preset Station" on page 30.

### Notes

- A new setting can be stored in place of the former one.
- You can manually replace a preset station with another FM or AM station by simply using the manual preset tuning method.
- Even if the number of received stations is not enough to be stored up to E8, automatic preset tuning is automatically ended after searching for all stations.
- Only FM stations with sufficient signal strength are stored by automatic preset tuning. If the station you want to store is weak in signal strength, tune in to it manually in monaural mode and store it by using the manual preset tuning method.

### Memory back-up

The memory back-up circuit prevents the stored data from being lost when this unit is set in the standby mode. If, however, the power cord is disconnected from the AC power outlet or the power is cut for more than one week, the memory will be erased. If so, store the stations again by using preset tuning methods.

## Manual Preset Tuning

You can also store up to 40 stations (5 groups x 8 stations) manually.

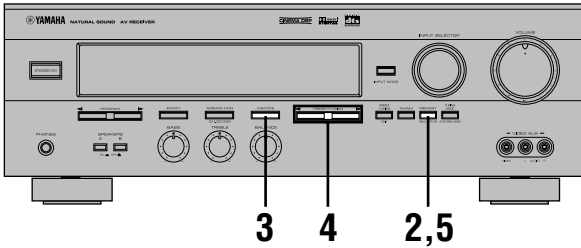

### 1 Tune in to the desired station.

Refer to page 28 for the tuning procedure.

### 2 Press MEMORY.

The “MEMORY” indicator flashes for about five seconds.

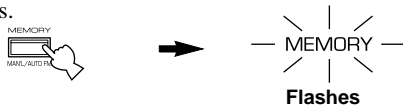

### 3 Press A/B/C/D/E repeatedly to select the desired group (A to E) of preset stations before the “MEMORY” indicator goes off.

Make sure that “>” appears on the display. The selected group appears on the display.



### 4 Press PRESET/TUNING > or < to select a preset station number (1 to 8) with which you want to store the station before the “MEMORY” indicator goes off.

Press > to select a higher preset station number and < to select a lower preset station number.

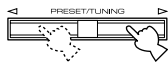

### 5 Press MEMORY before the “MEMORY” indicator goes off.

The displayed station has been stored as the preset group and number you have selected, and the reception band and frequency appear on the display.

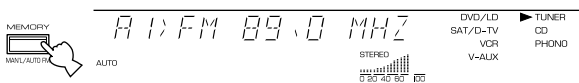

### 6 Repeat steps 1 to 5 to store other stations.

#### Notes

- A new setting can be stored in place of the former one.
- The reception mode (stereo or monaural) is stored along with the station frequency.

## To Recall a Preset Station

You can recall any desired station simply by selecting the preset station number with which it was stored.

You can also recall a preset station with the remote control. Press AMP(TUNER) on the component selector and press TUNER on the input selector.

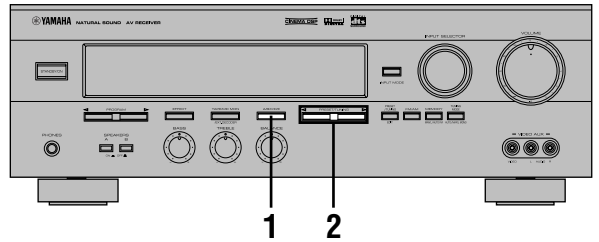

### 1 Press A/B/C/D/E to select the required group of preset stations.

Make sure that “>” appears on the display.

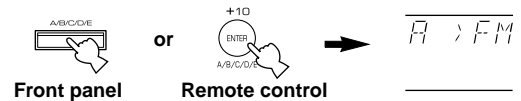

### 2 Press PRESET/TUNING > or < (or PRESET +/-) to select a preset station number (1 to 8).

The preset group and number appear on the display along with the reception band, frequency and signal strength information.

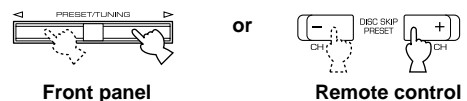

## Exchanging Preset Stations

You can exchange the assignment of two preset stations with each other.

- **Example: If you want to exchange preset station “E1” with “A5”.**

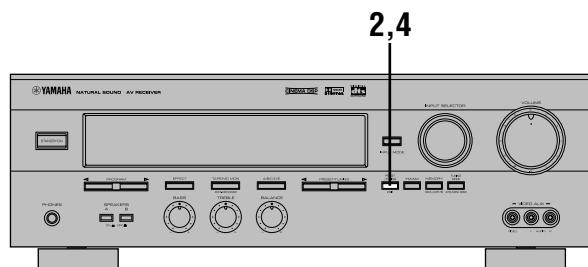

### 1 Recall preset station “E1”.

Refer to the procedure in the section “To Recall a Preset Station” on page 30.

### 2 Hold down (PRESET/TUNING) EDIT for about three second.

“E1” and the “MEMORY” indicator flash.

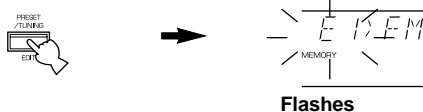

### 3 Recall preset station “A5” by using the buttons on the front panel.

“A5” and the “MEMORY” indicator flash.

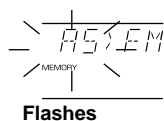

### 4 Press (PRESET/TUNING) EDIT again.

The display shows the exchange of stations has been completed.

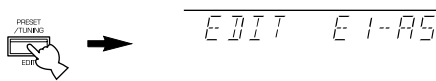



# RECORDING A SOURCE ON TAPE, MD OR VIDEO CASSETTE

Recording adjustments and other operations are performed from the tape deck, MD recorder or VCR. Refer to the instructions for these components.

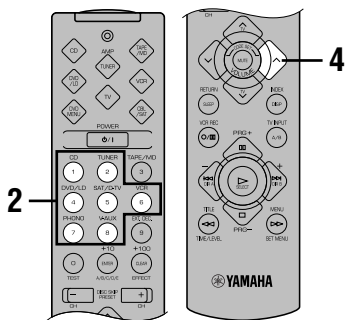
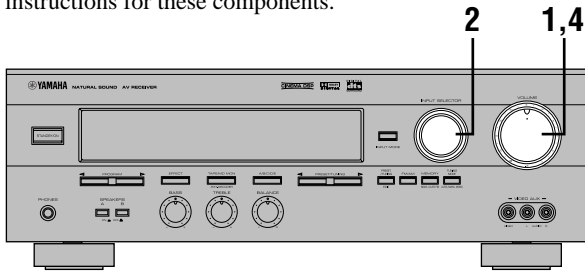

If a tape deck or MD recorder is being used for recording, you can monitor the sounds being recorded by pressing TAPE/MD MON / EXT. DECODER (or TAPE/MD).

### Notes

- The DSP program and the setting of VOLUME, BASS, TREBLE and BALANCE have no effect on the material being recorded.
- Composite video and S video signals pass independently through this unit's video circuits. Therefore, when recording or dubbing video signals, if your video source component is connected to provide only an S video (or only a composite video) signal, you can record only an S video (or only a composite video) signal by your VCR.
- A source connected to this unit only through the digital terminals cannot be recorded by the tape deck, MD recorder or VCR connected to this unit.
- A source connected to the EXTERNAL DECODER INPUT terminals of this unit cannot be recorded.
- Check the copyright laws in your country to record from records, CDs, radio, etc. Recording of copyrighted material may infringe copyright laws.

If you play back a video source that uses scrambled or encoded signals to prevent it from being dubbed, the picture itself may be disturbed due to those signals.

**1** Set VOLUME to the "∞" position.

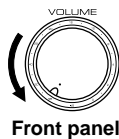

Front panel

**2** Select the source you want to record.

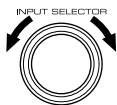

Front panel

or

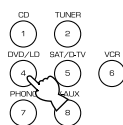

Remote control

**3** Begin recording by the tape deck, MD recorder or VCR connected to this unit.

**4** Play the source and then turn up the volume to confirm the input source.

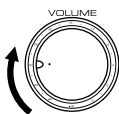

Front panel

or

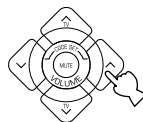

Remote control



# SET MENU

This unit provides you with the following items in the SET MENU to maximize the performance of your system and expand your enjoyment for audio listening and video watching.

1. CENTER SP
2. REAR SP
3. MAIN SP
4. BASS OUT
5. MAIN LVL
6. D.D. LFE
7. D-RANGE
8. DTS LFE
9. CNTR DELAY
10. MEM. GUARD
11. SAT INPUT

- 2 Press SET MENU repeatedly to select the item you want to adjust.

The selected item appears on the display.

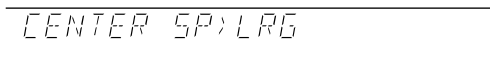

- 3 Press + or - repeatedly to adjust the setting.

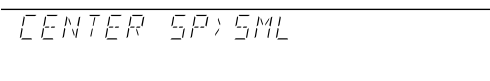
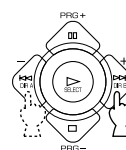

- 4 Repeat steps 2 and 3 to adjust the setting of any other item in the same way.

## Adjusting Items in the SET MENU

Adjustments should be performed with the remote control while watching the information on the display.

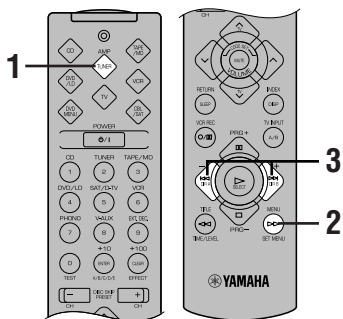

- 1 Press AMP(TUNER) on the component selector.



### Memory back-up

The memory back-up circuit prevents the stored data from being lost when this unit is set in the standby mode. If, however, the power cord is disconnected from the AC power outlet or the power is cut for more than one week, the settings of the SET MENU will automatically return to the preset positions and values. If so, adjust the settings of the SET MENU again.

## Description of Each Item

### 1. CENTER SP

Choices: LRG (Large)/SML (Small)/NONE

Preset position: LRG (Large)

CENTER SP>LRG

#### LRG (Large)

Select this position if your center speaker is approximately the same size as the main speakers. In this position, full-range signals on the center channel are directed to the center speaker.

#### SML (Small)

Select this position if you use a center speaker that is smaller than the main speakers. In this position, low bass signals (below 90 Hz) on the center channel are distributed to the SUBWOOFER OUTPUT terminal (or to the right and left main speakers if "BASS OUT" is set to the MAIN position).

#### NONE

Select this position if you do not have a center speaker (4-speaker system). In this position, full-range signals on the center channel are directed to the right and left main speakers.

### 2. REAR SP

Choices: LARGE/SMALL

Preset position: LARGE

REAR SP>LARGE

#### LARGE

Select this position if your rear speakers have high ability for bass reproduction, or if a subwoofer is connected in parallel to the rear speaker. In this position, full-range signals on the rear channels are directed to the rear speakers.

#### SMALL

Select this position if your rear speakers do not have high ability for bass reproduction. In this position, low bass signals (below 90 Hz) on the rear channels are distributed to the SUBWOOFER OUTPUT terminal (or to the right and left main speakers if "BASS OUT" is set to the MAIN position).

### 3. MAIN SP

Choices: LARGE/SMALL

Preset position: LARGE

MAIN SP>LARGE

#### LARGE

Select this position if your main speakers have high ability for bass reproduction. In this position, full-range signals on the main channels are directed to the right and left main speakers.

#### SMALL

Select this position if your main speakers do not have high ability for bass reproduction. However, if your system does not include a subwoofer, do not select this position. In this position, low bass signals (below 90 Hz) on the main channels are distributed to the SUBWOOFER OUTPUT terminal if "BASS OUT" is set to the SW or BOTH position.

### 4. BASS OUT

Choices: SW/MAIN/BOTH

Preset position: BOTH

BASS OUT>BOTH

#### SW

Select this position if your system includes a subwoofer. In this position, signals on the LFE channel and other low bass signals that are distributed from other channels are directed to the SUBWOOFER OUTPUT terminal when playing a source encoded with Dolby Digital or DTS.

#### Note

- When playing a 2-channel source (tape, MD, CD, video cassette etc.), select the BOTH position to direct low bass signals (below 90 Hz) to the SUBWOOFER OUTPUT terminals.

#### MAIN

Select this position if your system does not include a subwoofer. In this position, besides full-range signals on the main channels, signals on the LFE channel and other low bass signals (below 90 Hz) that are distributed from other channels are directed to the right and left main speakers.

#### BOTH

Select this position if your system includes a subwoofer. In this position, signals on the LFE channel are directed to the SUBWOOFER OUTPUT terminal. Low bass signals on the main channels are directed to both the main speakers and the SUBWOOFER OUTPUT terminal.

## 5. MAIN LVL

Choices: NORM (Normal)/-10 dB

Preset position: NORM (Normal)

MAIN LVL > NORM

### NORM (Normal)

Normally select this position.

#### -10 dB

Select this position if the sound output from the main speakers is too loud and cannot be balanced with the sound output from the center and rear speakers. In this position, the sound output from the main speakers is attenuated.

#### Notes

- The setting of “CENTER SP”, “REAR SP”, “MAIN SP” and “BASS OUT” have no effect on a source connected to the EXTERNAL DECODER INPUT terminals on the rear of this unit.
- Once you have adjusted appropriately for “CENTER SP”, “REAR SP”, “MAIN SP”, “BASS OUT” and “MAIN LVL”, you do not have to change any settings unless your speaker system is modified.

## 6. D.D. LFE (Adjusting the output level of the LFE channel for Dolby Digital)

Control range: -20 dB to 0 dB (in 1 dB steps)

Preset value: 0 dB

D \ D \ LFE 0dB

#### Note

- This adjustment is only effective when Dolby Digital is being decoded and the selected source encoded with Dolby Digital contains LFE signals.

This adjusts the output level of the LFE channel. If the LFE signals are mixed with signals of other channels and they are directed to the same speakers, the ratio of the LFE signal level to the level of the other signals can be adjusted.

## 7. D-RANGE (Adjusting the dynamic range)

Choices: MAX/STD (Standard)/MIN

Preset position: MAX

D-RANGE > MAX

#### Note

- This adjustment is only effective when Dolby Digital is being decoded.

“Dynamic range” is the difference between the maximum level and the minimum level of sounds. Sounds on a movie originally designed for movie theaters feature a very wide dynamic range. Dolby Digital technology can modify the original sound track into a home audio format with this wide dynamic range unchanged. Powerful sounds of extremely wide dynamic range are not always suitable for home use. Depending on the condition of your listening environment, it may not be possible to increase the sound output to a level as high as that in a movie theater. However, at the normal level suitable for listening in your room, the low-level parts of source sound often cannot be heard well because they will be lost among noise in your environment. Dolby Digital technology has also made it possible to reduce an original sound track’s dynamic range for a home audio format by “compressing” the sound data.

#### MAX

In this position, a source encoded with Dolby Digital is reproduced in the original sound track’s wide dynamic range to provide you with powerful sounds just like those in a movie theater. Selecting this position will be even better if you can listen to a source at a high output level in a room specially soundproofed for audio/video enjoyment.

#### STD (Standard)

In this position, a source encoded with Dolby Digital is reproduced in the “compressed” dynamic range of the source that is suitable for low-level listening.

#### MIN

In this position, the dynamic range is more reduced than in the STD position. Selecting this position will be effective when you must listen to a source at a low level.

#### Note

- It may happen that sound is output faintly or not output normally depending on the source. In that case, select the MAX or STD position.

## 8. DTS LFE (Adjusting the output level of the LFE channel for DTS)

Control range: -10 dB to +10 dB (in 1 dB steps)

Preset value: 0 dB

DTS LFE 0<sup>dB</sup>

### Note

- This adjustment is effective only when DTS is being decoded and the selected source encoded with DTS contains LFE signals.

This adjusts the output level of the LFE channel. If the LFE signals are mixed with signals of other channels and they are directed to the same speakers, the ratio of the LFE signal level to the level of the other signals can be adjusted.

## 9. CNTR DELAY (Adjusting the delay of the center sound)

Control range: 0 ms to 5 ms (in 1 ms steps)

Preset value: 0 ms

CNTR DELAY 0<sub>ms</sub>

### Note

- This adjustment is only effective when Dolby Digital or DTS is being decoded and the selected source encoded with Dolby Digital or DTS contains center channel signals.

This adjusts the delay between the main sound (on the main channels) and dialog, etc. (on the center channel). The larger the value, the later the dialog, etc. is generated.

This makes sounds from the left main, center and right main speakers reach your listening position at the same time. This is achieved by delaying the sound from the center speaker if the distance from the center speaker to your listening position is shorter than the distance from the right and left main speaker to your listening position.

## 10. MEM. GUARD (Locking the settings)

Choices: ON/OFF

Preset position: OFF

MEM. GUARD OFF

If you wish to prevent accidental alterations to the settings of the SET MENU and other adjustments on this unit, select the ON position. The following settings on this unit can be locked:

- Settings of other items in the SET MENU
- Settings in the TIME/LEVEL mode
- Settings when using TEST

## 11. SAT INPUT (Selecting the initial input mode for a source connected to the SAT/D-TV input terminals)

Choices: AUTO/LAST

Preset position: AUTO

SAT INPUT AUTO

The input mode for a source connected to the SAT/D-TV input terminals of this unit can be automatically set when the power of this unit is turned on. Refer to page 22 for details about the input mode.

### AUTO

In this position, the input mode is always set to AUTO.

### LAST

In this position, the input mode is automatically set to that selected the last time when the power of this unit was turned on.





# DELAY TIME AND SPEAKER OUTPUT LEVELS

When using the digital sound field processor with the Dolby Pro Logic decoder, Dolby Digital decoder or DTS decoder, you can adjust the delay time between the main sound and sound effect, and each speaker's output level as you wish.

## Delay Time

You can adjust the time difference between the beginning of the sound from the main speakers and the beginning of the sound effect from the rear speakers. The larger the value, the later the sound effect is generated. The delay time can be individually adjusted to all DSP programs.

### Notes

- Adding too much delay will cause an unnatural effect with some sources.
- The sound is momentarily interrupted while adjusting the delay time.

	Program	Control range (ms)	Preset value
1.	PRO LOGIC/Normal	15 to 30	20
	DOLBY DIGITAL/Normal	0 to 15	5
	DTS DIGITAL SUR/Normal	0 to 15	5
	PRO LOGIC/ENHANCED	15 to 30	20
	DOLBY DIGITAL/ENHANCED	0 to 15	5
	DTS DIGITAL SUR/ENHANCED	0 to 15	5
2.	70 mm SPECTACLE	15 to 30	23
	DGTL SPECTACLE	1 to 99	15
	DTS SPECTACLE	1 to 99	15
	70 mm SCI-FI	15 to 30	20
	DGTL SCI-FI	1 to 99	16
	DTS SCI-FI	1 to 99	16
3.	70 mm ADVENTURE	15 to 30	20
	DGTL ADVENTURE	1 to 99	15
	DTS ADVENTURE	1 to 99	15
	70 mm GENERAL	15 to 30	20
	DGTL GENERAL	1 to 99	15
	DTS GENERAL	1 to 99	15
4.	MONO MOVIE	1 to 99	49
5.	TV SPORTS	1 to 99	9
6.	DISCO	1 to 99	40
7.	ROCK CONCERT	1 to 99	16
8.	CONCERT HALL	1 to 99	44

## Sound Output Level of the Center, Right Rear and Left Rear Speakers, and Subwoofer

If desired, you can adjust the sound output level of each speaker even if it has already been adjusted in "ADJUSTING THE SPEAKER BALANCE" on pages 18 and 19.

### Notes

- The sound output level of the center speaker cannot be adjusted when the input signal is analog, PCM audio, or encoded with Dolby Digital in 2-channel.
- If "CENTER SP" in the SET MENU is set to the NONE position, the sound output level of the center speaker cannot be adjusted. This is because the center channel sound is automatically output from the right and left main speakers.
- Once the sound output level has been adjusted, the level will be the same for all DSP programs.

Speaker	Control range (dB)	Preset value
Center	-20 to +10	0
Right rear	-20 to +10	0
Left rear	-20 to +10	0
Subwoofer	-20 to 0	0

## Adjusting Method

Adjustments should be performed with the remote control while watching the information on the display.

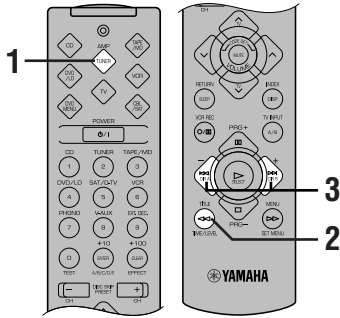

- 1** Press AMP(TUNER) on the component selector.



- 2** Press TIME/LEVEL repeatedly to select the item you want to adjust.

Each time you press TIME/LEVEL, the selected item changes and appears on the display as below.

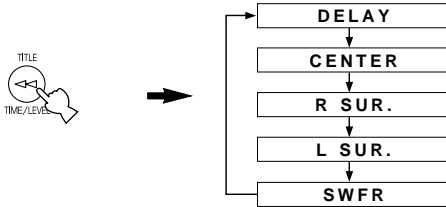

### Note

- Depending on the setting of the SET MENU, you may not be able to select all these items.

- 3** Press + or – to adjust the delay time or speaker output levels.

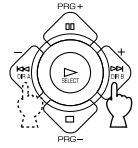

- 4** Repeat steps 2 and 3 to adjust the settings of any other item.

### Memory back-up

The memory back-up circuit prevents the stored data from being lost when this unit is set in the standby mode. If, however, the power cord is disconnected from the AC power outlet or the power is cut for more than one week, the latest values for the delay time and the center/rear/subwoofer output levels that were set will automatically return to the preset values. If so, adjust the delay time and output levels again.



# SLEEP TIMER

The SLEEP timer can be used to automatically set this unit in the standby mode. This timer is useful when you are going to sleep while enjoying a broadcast or other desired input source. The SLEEP timer can only be set with the remote control.

### Notes

- First press AMP(TUNER), TAPE/MD, CD or DVD/LD on the component selector to set the SLEEP timer for this unit.
- The SLEEP timer is effective for the components connected to the AC OUTLET(S) on the rear panel of this unit.

## Setting the SLEEP Timer

**1** Play a source you want to enjoy when you are going to sleep.

**2** Press SLEEP repeatedly to select the desired SLEEP time.



Each time you press SLEEP, the SLEEP time will change as below:

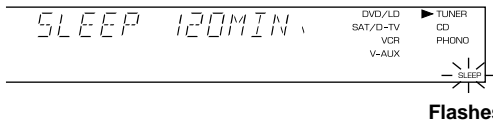
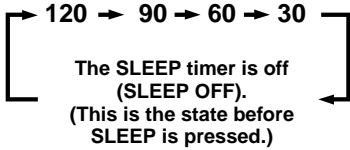

**3** The “SLEEP” indicator soon lights up on the display after the SLEEP timer has been set. The display returns to the previous indication.

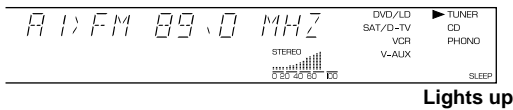

## Canceling the Selected SLEEP Timer

Press SLEEP repeatedly until “SLEEP OFF” appears on the display.

It will soon disappear and the “SLEEP” indicator will go off.

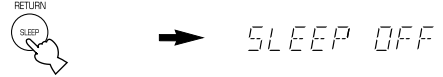

### Note

- The SLEEP timer can also be canceled by setting the unit in the standby mode by using POWER on the remote control (or STANDBY/ON), or by disconnecting the AC power cord from the AC power outlet.



# PRESET REMOTE CONTROL

The provided remote control is factory set to control not only this unit but also most YAMAHA audio components connected to it.

There are eight component selector buttons. Press one of these buttons which corresponds to the component you want to control with the remote control. For example, if you press CD on the component selector, the remote control is set to the CD operation mode, allowing the CD player to be controlled by the buttons on the remote control.

## AMP(TUNER)

You can perform the basic operations of this unit. Refer to page 7.

## CD

The code for a YAMAHA CD player is factory set.

## DVD/LD & DVD MENU

An LD player can be controlled in the DVD/LD mode. A DVD player can be controlled in the DVD/LD and DVD MENU modes. The code for a YAMAHA DVD player is factory set. If the remote control does not operate your YAMAHA DVD player, you need to set the code number "0048".

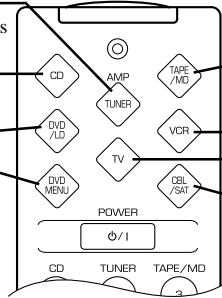

## TAPE/MD

The code for a YAMAHA tape deck is factory set. (The code for the YAMAHA MD recorder can also be set.)

## VCR

A VCR can be controlled.

## TV

A TV can be controlled.

## CBL/SAT

A cable TV or satellite tuner can be controlled.

### Note

- The button functions on the remote control differ depending on the operation mode. Refer to the following pages for details.

## Controlling the Components Connected to This Unit

### Example: To control YAMAHA CD player

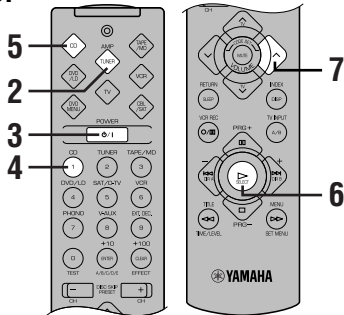

**5** Press CD on the component selector.



**6** Press .  
Refer to page 42 for the CD player operation buttons.

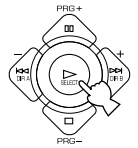

**7** Adjust the volume.



**1** Make sure that VOLUME is set to the "∞" position.

**2** Press AMP(TUNER) on the component selector.



**3** Turn on the power.



**4** Press CD on the input selector.



If you set the remote control with the manufacturers' codes **listed from page i at the end of this manual**, you can control other brands of components. Refer to "Setup codes" on page 45 for details.

## Description of Each Mode

### ■ TAPE/MD MODE

**Note**

- TV VOLUME functions if you have set the code for your TV.

**TAPE/MD**  
Press TAPE/MD.

**POWER**  
(TAPE) This button turns this unit on if you have set the code for a YAMAHA tape deck. This button turns on the tape deck that has a remote control with a power button if you have set the code for another manufacturer.  
(MD) This button turns this unit on if you have set the code for the YAMAHA MD recorder.

**Input selector buttons**

**EFFECT**

**VOLUME**

**MUTE**

**SLEEP**

**TV VOLUME**

**DISPLAY (MD)**

**DECK A/B (TAPE)**  
This button selects deck A or B on a double-cassette tape deck.

**PAUSE (MD)**  
This button gives a pause in operation.

**DIR B (TAPE)**  
This button selects the playing direction of deck B.

**SKIP+ (MD)**  
This button skips to the next track.

**STOP**  
This button stops operation on a tape deck or MD recorder.

**FAST FORWARD (TAPE)**  
This button winds a tape fast forward.

**SEARCH (MD)**  
This button initiates a fast-forward search on the track that is playing to find the point from which you want to listen.

**O/■ REC/PAUSE**  
This button gives a pause in recording on a tape deck or MD recorder.

**▶ PLAY**  
This button plays a tape or an MD.

**◀◀ DIR A (TAPE)**  
This button selects the playing direction of deck A.

**SKIP- (MD)**  
This button skips to the previous track.

**◀◀ REWIND (TAPE)**  
This button rewinds a tape.

**SEARCH (MD)**  
This button initiates a backward search on the track that is playing to find the point from which you want to listen.

The dark-shaded buttons do not function. Refer to the instructions for details of each component.

## CD MODE

### Note

- TV VOLUME and TV INPUT function if you have set the code for your TV.

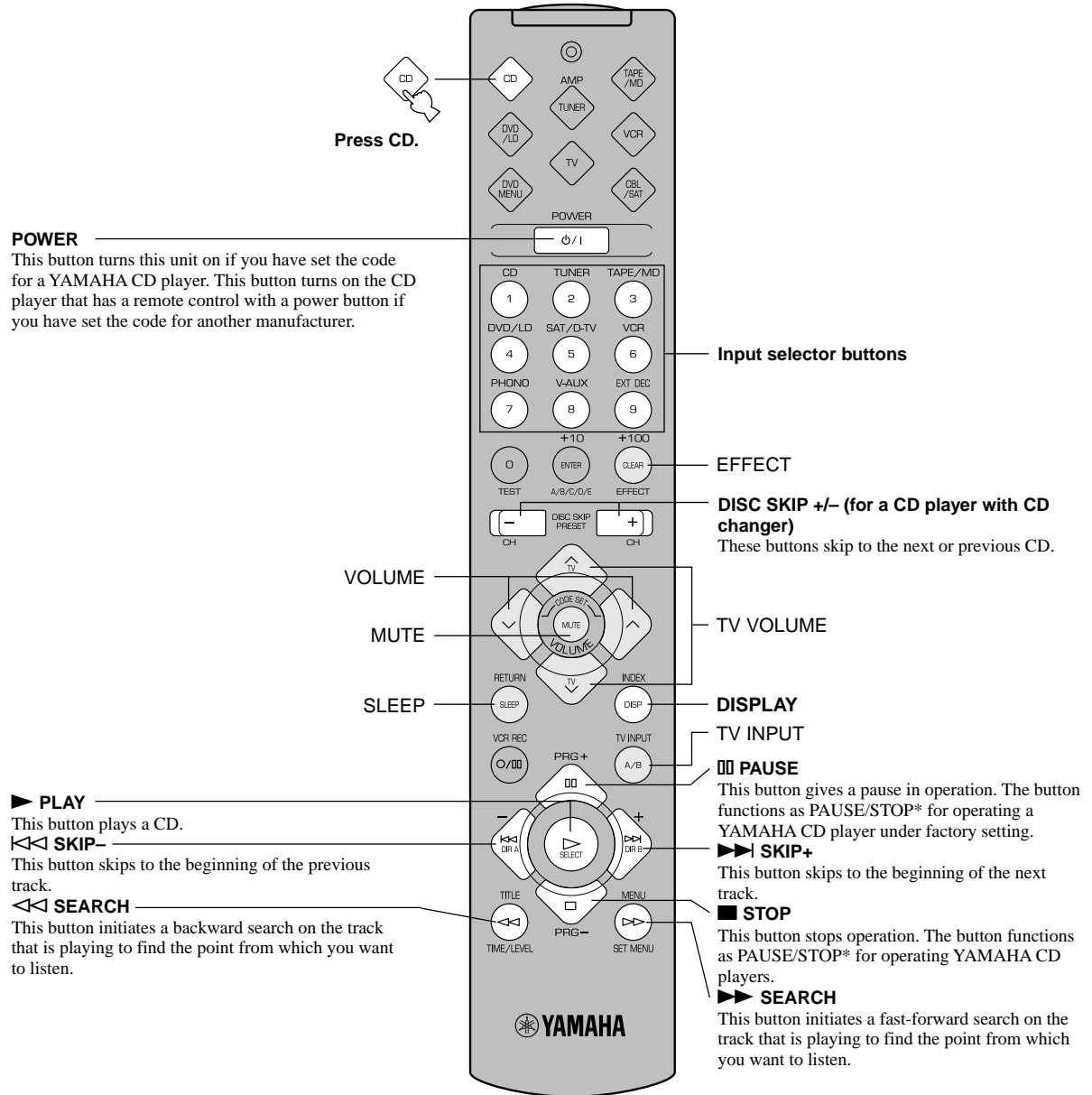

### PAUSE/STOP function

Press the button once to give a pause in operation and press once more to stop operation.

The dark-shaded buttons do not function. Refer to the instructions for details of each component.

## DVD/LD MODE

### Note

- TV VOLUME and TV INPUT function if you have set the code for your TV.

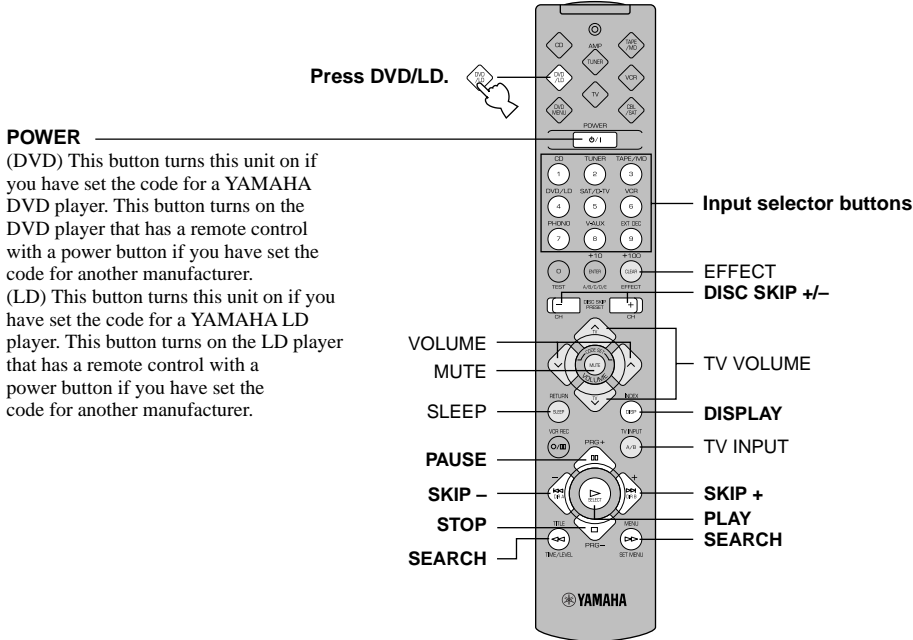

## DVD MENU MODE

### Note

- TV VOLUME and TV INPUT function if you have set the code for your TV.

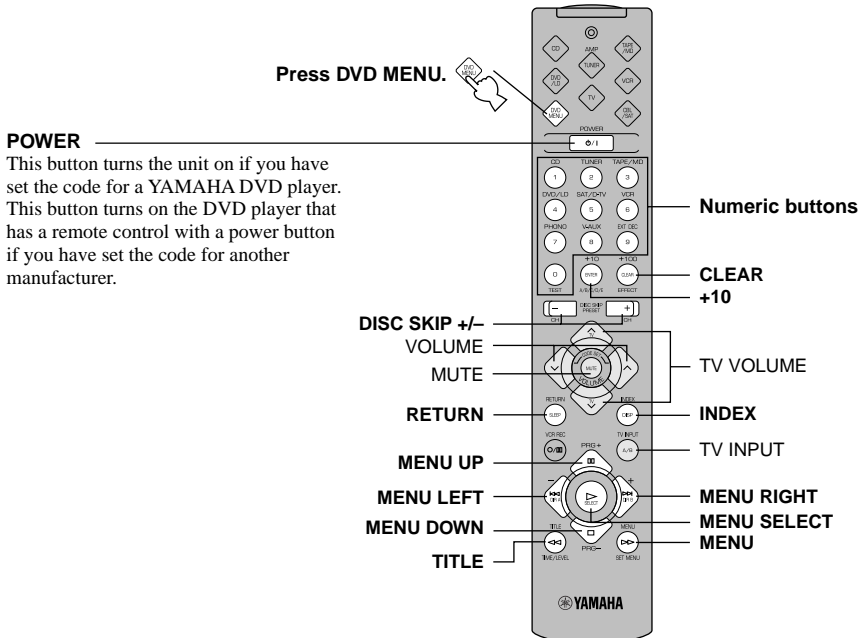

The dark-shaded buttons do not function. Refer to the instructions for details of each component.

## VCR MODE

### Note

- TV VOLUME, TV INPUT and TV SLEEP function if you have set the code for your TV.

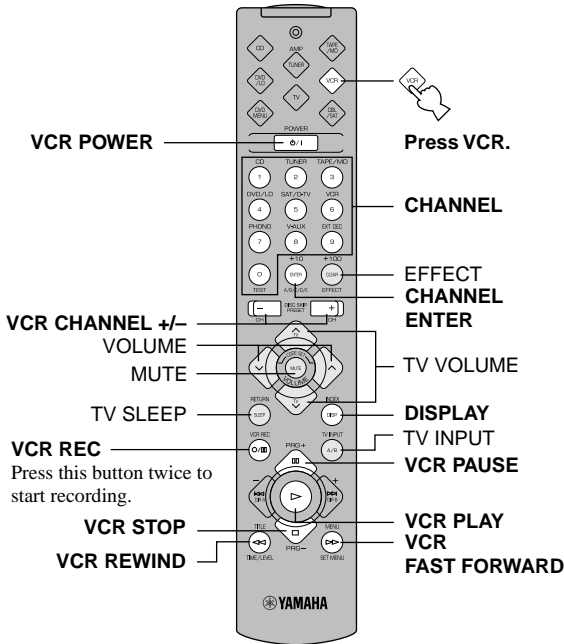

## CBL/SAT MODE

### Note

- TV VOLUME, TV INPUT and TV SLEEP function if you have set the code for your TV.

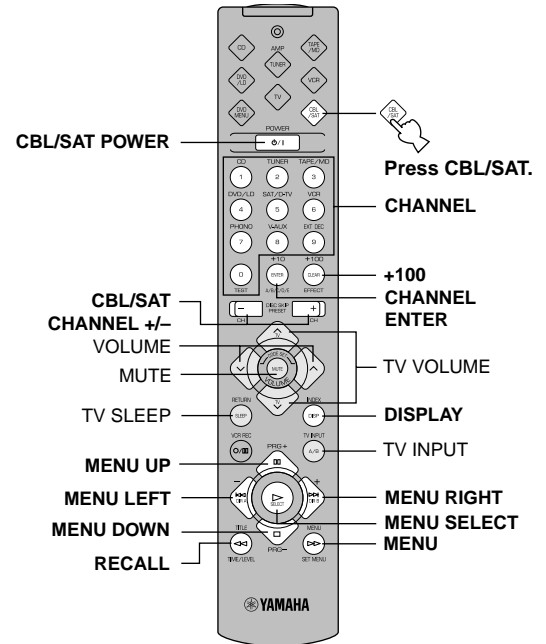

## TV MODE

### Note

- You can control your VCR if you have set the code for it.

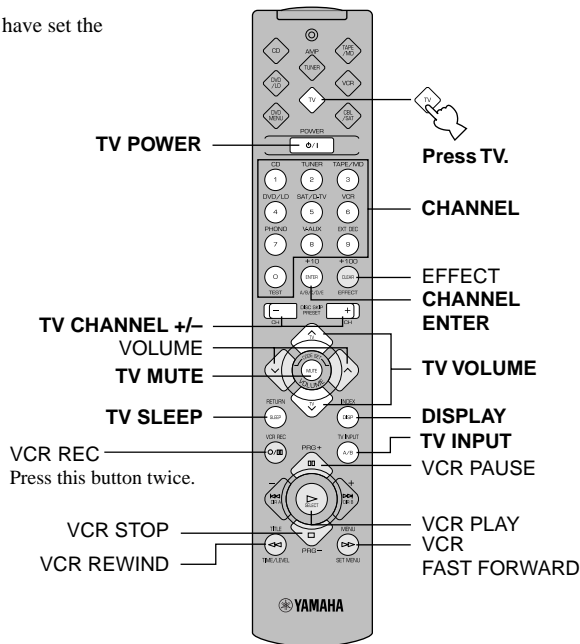

The dark-shaded buttons do not function. Refer to the instructions for details of each component.



## Advanced Information

### ■ Setup codes

You can set the code for the manufacturer of your component after pressing the component selector buttons other than AMP(TUNER).

#### 1 Turn on your component to be used.

2 Press one of the component selector buttons which corresponds to the component to be controlled.



3 Press both VOLUME buttons (▲▼) at the same time for about four seconds.

The indicator flashes twice.

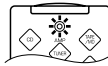
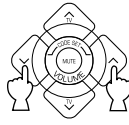

4 Use the numeric buttons to enter the four-digit manufacturer's code for the component to be used. Make sure that the indicator flashes twice.

If the indicator does not flash, repeat step 3 and re-enter the code.

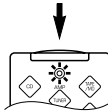
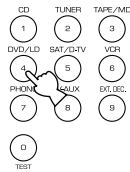

5 Press POWER (or any other button) on the remote control to check if you have set the code correctly.

If your component cannot be controlled with the remote control, try setting another code for the same manufacturer.



### Notes

- You can set only one code for one mode.
- In the DVD/LD and DVD MENU modes:
  - Be sure to press DVD/LD on the component selector before entering the code for the DVD/LD player. The code set in the DVD/LD mode is also simultaneously set in the DVD MENU mode. You cannot set the code for a DVD player after pressing DVD MENU on the component selector.
  - DVD MENU operations cannot be performed for some DVD players.
- A second (and third) VCR can be controlled. Refer to "To use a second (and third) VCR" for details.
- If your component does not respond to any of the codes listed for the manufacturer, use the original remote control supplied with your component.

### ■ To use a second (and third) VCR

You can control a second (and third) VCR in the CBL/SAT and DVD MENU modes if a cable TV or satellite tuner, or DVD player is not being used.

#### Note

- If you want to control a second (and third) VCR in the DVD MENU mode, you must set the code for an LD player in the DVD/LD mode.

#### 1 Turn on the VCR to be used.

2 Press CBL/SAT or DVD MENU on the component selector.



3 Press both VOLUME buttons (▲▼) at the same time for about four seconds.

The indicator flashes twice.



4 Use the numeric buttons to enter the four-digit code for the second (and third) VCR. Make sure that the indicator flashes twice.

If the indicator does not flash, repeat step 3 and re-enter the code.

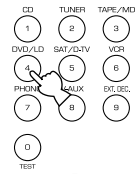

5 Press POWER (or any other button) on the remote control to check if you have set the code correctly.

If the VCR cannot be controlled with the remote control, try setting another code for the same manufacturer.



## ■ Returning to the factory-set codes

To return all components to the factory-set codes, follow these steps.

- 1 Press one of the component selector buttons other than AMP(TUNER).**



- 2 Press both VOLUME buttons (↖↗) at the same time for about four seconds.**

The indicator flashes twice.

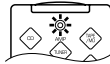

- 3 Enter the code number "9990".**

Make sure that the indicator flashes twice.

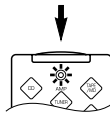
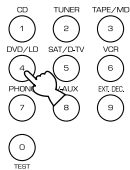

To return each component to the factory-set codes, follow these steps.

- 1 Press one of the component selector buttons which corresponds to the component to be returned to the factory-set code.**



- 2 Press both VOLUME buttons (↖↗) at the same time for about four seconds.**

The indicator flashes twice.

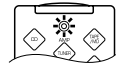

- 3 Enter the code number "0000".**

Make sure that the indicator flashes twice.

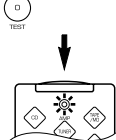
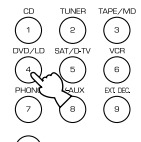

The following codes are factory set.

Component selector button	Component	Code
TV	TV	0101
CBL/SAT	Satellite tuner	0006
VCR	VCR	0002
DVD/LD	DVD player	0008 (YAMAHA DVD player)
CD	CD player	0005 (YAMAHA CD player)
TAPE/MD	Tape deck	0004 (YAMAHA Tape deck)

We recommend that you write all the code numbers you have set on the "Quick Reference Card".



# TROUBLESHOOTING

If the unit fails to operate normally, check the following points to determine whether the fault can be corrected by the simple measures suggested. If it cannot be corrected, or if the fault is not listed in the SYMPTOM column, disconnect the power cord and contact your authorized YAMAHA dealer or service center.

## ■ General

SYMPTOM	CAUSE	REMEDY	Refer to page
<b>The unit fails to turn on when STANDBY/ON is pressed, or enters in the standby mode soon after the power has been turned on.</b>	The power cord is not connected or the plug is not completely inserted.	Firmly connect the power cord.	17
	The IMPEDANCE SELECTOR switch on the rear panel is not fully set to the right or left position.	Set the switch fully to the right or left position when the unit is in the standby mode.	17
<b>The unit does not work normally.</b>	The internal microcomputer has been frozen by an external electric shock (lightning, excessive static electricity, etc.) or by a power supply with low voltage.	Set the unit in the standby mode and disconnect the AC power cord from the AC power outlet. After about 30 seconds have passed, connect the power and operate the unit again.	—
<b>No sound and/or no picture.</b>	Incorrect input or output cable connections.	Connect the cables properly. If the problem persists, the cables may be defective.	12, 13
	An appropriate input source has not been selected.	Select an appropriate input source with INPUT SELECTOR or TAPE/MD MON / EXT. DECODER (or the input selector buttons).	20
	The speaker connections are not secure.	Secure the connections.	15
	SPEAKERS have not been set properly.	Set SPEAKERS corresponding to the speakers in use to the ON position.	20
	The sound is muted.	Set VOLUME to the “∞” position, press MUTE to cancel a mute and adjust the volume.	21
	Digital signals other than PCM audio and the signals encoded with Dolby Digital or DTS which this unit cannot reproduce are being input to this unit by a CD-ROM, etc.	Play a source whose signals this unit can reproduce.	—
<b>No picture.</b>	There is no S VIDEO connection between this unit and the TV monitor, although S video signals are being input to this unit.	Connect the monitor’s “S” video input terminal to this unit’s S VIDEO MONITOR OUT terminal.	14
<b>The sound suddenly goes off.</b>	The protection circuit has been activated because of a short circuit, etc.	Set the unit in the standby mode and then turn on to reset the protection circuit.	—
	The SLEEP timer has functioned.	Turn on the power, and play the source again.	39
<b>Only the speaker on one side can be heard.</b>	Incorrect cable connections.	Connect the cables properly. If the problem persists, the cables may be defective.	15
	Incorrect setting of BALANCE.	Adjust it to the appropriate position.	21
<b>No sound from the effect speakers.</b>	The sound effect is off.	Press EFFECT to turn it on.	24
	A Dolby Surround, Dolby Digital or DTS decoding DSP program is being used with material not encoded with Dolby Surround, Dolby Digital or DTS.	Select another DSP program.	27
<b>No sound from the center speaker.</b>	The sound output level of the center speaker is set to minimum.	Raise the level of the center speaker.	37
	“CENTER SP” in the SET MENU is set to the NONE position.	Select the LRG or SML position.	34
	Incorrect DSP program is selected.	Select the appropriate program.	25, 26, 27
	The source encoded with Dolby Digital or DTS does not have a center channel signal.		—
<b>No sound from the rear speakers.</b>	The output level of the rear speakers is set to minimum.	Raise the output level of the rear speakers.	37
	A monaural source is being played with the PRO LOGIC/Normal or PRO LOGIC/ENHANCED program.	Select another DSP program suitable for the monaural source.	27

SYMPTOM	CAUSE	REMEDY	Refer to page
<b>No sound from the subwoofer.</b>	“BASS OUT” in the SET MENU is set to the SW or MAIN position when playing a 2-channel source.	Select the BOTH position.	34
	The source does not contain low bass signals (below 90 Hz).		—
<b>A “humming” sound can be heard.</b>	Incorrect cable connections.	Firmly connect the audio plugs. If the problem persists, the cables may be defective.	12, 13
	No connection from the turntable to the GND terminal.	Make the GND connection between the turntable and this unit.	12
<b>The volume level is low while playing a record.</b>	The record is being played on a turntable with an MC cartridge.	The turntable should be connected to the unit through the MC head amplifier.	12
<b>The volume level cannot be increased, or the sound is distorted.</b>	The component connected to the TAPE/MD OUT (REC) terminals of this unit is in the standby mode.	Turn on the power to the component.	—
<b>The sound effect cannot be recorded.</b>	It is not possible to record the sound effect by a tape deck or MD recorder connected to the TAPE/MD OUT (REC) terminals of this unit.		32
<b>The DVD/LD, TV/digital TV or satellite tuner source cannot be recorded by tape deck, MD recorder or VCR connected to this unit.</b>	The DVD/LD player, TV/digital TV or satellite tuner is connected to the unit only through the digital terminals.	Make additional connections between the analog terminals.	13
<b>Adjusting this unit by using SET MENU, TIME/LEVEL or TEST cannot be performed.</b>	“MEM. GUARD” in the SET MENU is set to the ON position.	Set “MEM. GUARD” to the OFF position.	36

■ **Tuner**

SYMPTOM	CAUSE	REMEDY	Refer to page	
<b>FM</b>	<b>FM stereo reception is noisy.</b>	The characteristics of FM stereo broadcasts may cause this problem when the transmitter is too far away or the antenna input is poor.	Check the antenna connections. Try using a high-quality directional FM antenna. Use the manual tuning method.	10, 28
	<b>There is distortion, and clear reception cannot be obtained even with a good FM antenna.</b>	There is multipath interference.	Adjust the antenna position to eliminate multipath interference.	10
	<b>The desired station cannot be tuned in with the automatic tuning method.</b>	The station is too weak.	Use the manual tuning method. Use a high-quality directional FM antenna.	10, 28
	<b>Previously preset stations can no longer be tuned in.</b>	The unit has been disconnected for a long period.	Re-store the stations.	29
<b>AM</b>	<b>The desired station cannot be tuned in with the automatic tuning method.</b>	The signal is weak or the antenna connections are loose.	Tighten the AM loop antenna connections and orient it for best reception. Use the manual tuning method.	11, 28
	<b>There are continuous cracking and hissing noises.</b>	Noises result from lightning, fluorescent lamps, motors, thermostats and other electrical equipment.	Use an outdoor antenna and a ground wire. This will help somewhat, but it is difficult to eliminate all noise.	11
	<b>There are buzzing and whining noises (especially in the evening).</b>	A TV set is being used nearby.	Move this unit away from the TV.	—

## ■ Remote control

SYMPTOM	CAUSE	REMEDY	Refer to page
The remote control does not work.	Direct sunlight or lighting (from an inverter type of fluorescent lamp, etc.) is striking the remote control sensor of this unit.	Reposition the unit.	3
	The batteries are weak.	Replace all batteries with new ones.	2
The unit or other component cannot be controlled.	The component to be controlled has not been selected.	Press one of the component selector buttons which corresponds to the component to be controlled.	40
	The manufacturer's code has not been set properly.	Enter the code again.	45
		Try setting another code for the same manufacturer.	

## ■ Others

SYMPTOM	CAUSE	REMEDY	Refer to page
The sound is degraded when listening with headphones to a tape deck or CD player connected to this unit.	This unit is in the standby mode.	Turn on the power of the unit.	—
There is noise interference from digital or high-frequency equipment, or the unit.	The unit is too close to the digital or high-frequency equipment.	Move the unit further away from such equipment.	—

## ■ When playing back a source encoded with DTS

SYMPTOM	CAUSE	REMEDY	Refer to page
A loud hissing noise is heard when playing back a source encoded with DTS.	The player which plays back the source is not connected to a digital audio signal input terminal of this unit.	The player must be connected to a digital audio signal input terminal of this unit besides the analog audio signal terminal connections.	13
	The input mode is set to ANALOG on this unit.	Set a proper input mode to turn on the built-in DTS decoder.	22
A percussive noise is heard when playing back a source encoded with DTS.	If the input mode is set to AUTO, depending on some sources, there may be a noise heard while this unit is identifying the format of the input signal.	Set the input mode of the currently selected input source to DTS.	22
No sound is heard when playing back a source encoded with DTS, even if the input mode is set to AUTO on this unit.	The built-in DTS decoder does not function because the player has a digital volume control and it is set at a position other than "maximum," "neutral" or "ineffective."	Set the player's digital volume control at the maximum, neutral or ineffective position.	—
No sound is heard when playing back an MD or DAT on which has been recorded a source encoded with DTS.	A source encoded with DTS cannot be recorded on an MD or DAT.		—
No sound is heard when playing back a source (CD, etc.) even if the currently selected input mode is AUTO.	In the AUTO mode, the DTS-decoding mode cannot be automatically changed to the normal (PCM) digital signal input mode.	Set the input mode to AUTO again.	23

### Notes

- It is necessary to use a DTS decoder to play back a source encoded with DTS, so the player which plays back the source must be connected to a digital audio input terminal of this unit in the way described in this manual. If this connection is not made or only a D-to-A converter is being used without using a DTS decoder, only a loud hissing noise will be heard when you play back the source.
- If you make a search (or skip, etc.) operation while playing back a source encoded with DTS, the "dts" indicator goes off. This is because this unit automatically changes the DTS-decoding mode to the standard (PCM) digital signal input mode to prevent a noise from being output.



# SPECIFICATIONS

## AUDIO SECTION

- Minimum RMS Output Power  
20 Hz to 20 kHz, 0.06% THD, 8 ohms  
Main L/R, Center, Rear L/R ..... 70 W\*/65 W  
1 kHz, 0.09% THD, 8 ohms  
Main L/R, Center, Rear L/R ..... 80 W\*/70 W
- Maximum Output Power (EIAJ)  
1 kHz, 10% THD, 8 ohms ..... 100 W
- DIN Standard Output Power  
1 kHz, 0.7% THD, 4 ohms ..... 100 W
- IEC Output Power  
1 kHz, 0.06% THD, 8 ohms ..... 70 W
- Dynamic Power (IHF)  
8/6/4/2 ohms ..... 100/120/140/160 W\*, 90/110/130/150 W
- Damping Factor  
20 Hz to 20 kHz, 8 ohms ..... 60
- Frequency Response  
CD etc. to MAIN L/R ..... 20 Hz to 20 kHz,  $\pm 0.5$  dB
- Total Harmonic Distortion (20 Hz to 20 kHz)  
CD etc. to MAIN L/R, 1/2 power, 8 ohms ..... 0.025%
- Signal-to-Noise Ratio (IHF-A Network)  
CD etc. to MAIN L/R  
(150 mV, Input Shorted) ..... 96 dB  
(250 mV, Input Shorted) ..... 100 dB
- Residual Noise (IHF-A Network)  
MAIN L/R ..... 150  $\mu$ V
- Input Sensitivity/Impedance  
CD etc. .... 150 mV/47 k-ohms  
EXT. DECODER ..... 150 mV/40 – 47 k-ohms
- Output Level/Impedance  
REC OUT ..... 150 mV/1.2 k-ohms  
SUBWOOFER ..... 4.0 V/1.2 k-ohms  
PHONES ..... 0.47 V/390 ohms
- Channel Separation (Vol. –30 dB)  
CD etc. (Input 5.1 k-ohms Terminated, 1 kHz/10 kHz)  
..... 60 dB/45 dB
- Tone Control Characteristics  
BASS: Boost/cut .....  $\pm 10$  dB/50 Hz  
TREBLE: Boost/cut .....  $\pm 10$  dB/20 kHz

\* for U.S.A. and Canada models

## VIDEO SECTION

- Video Signal Type ..... NTSC or PAL
- Video Signal Level ..... 1 Vp-p/75 ohms
- Signal-to-Noise Ratio ..... 50 dB
- Monitor Out Frequency Response ..... 5 Hz to 10 MHz, –3 dB

## FM SECTION

- Tuning Range ..... 87.5/87.50 to 107.9/108.00 MHz
- Usable Sensitivity (DIN)  
Mono (S/N 26 dB) ..... 0.9  $\mu$ V  
Stereo (S/N 46 dB) ..... 28  $\mu$ V
- Selectivity (two signals, 40 kHz Dev.,  $\pm 300$  kHz) ..... 55 dB
- Signal-to-Noise Ratio (Mono/Stereo)  
DIN ..... 75 dB/69 dB  
IHF ..... 81 dB/75 dB
- Harmonic Distortion (1 kHz)  
Mono/Stereo ..... 0.1/0.2%
- Stereo Separation (1 kHz) ..... 48 dB
- Frequency Response ..... 20 Hz to 15 kHz,  $\pm 1$  dB
- Antenna Input ..... 75 ohms, Unbalanced

## AM SECTION

- Tuning Range ..... 530/531 to 1,710/1,611 kHz
- Usable Sensitivity ..... 300  $\mu$ V/m
- Signal-to-Noise Ratio ..... 52 dB
- Antenna ..... Loop antenna

## GENERAL

- Power Supply  
[U.S.A. and Canada models] ..... AC 120 V, 60 Hz  
[Europe, U.K. and Singapore models] ..... AC 230 V, 50 Hz  
[Australia model] ..... AC 240 V, 50 Hz  
[China model] ..... AC 220 V, 50 Hz  
[General model] ..... AC 110/120/220/240 V, 50/60 Hz
- Power Consumption ..... approx. 220 W
- AC Outlets (100 W max. total)  
[U.K. and Australia models] ..... 1 (SWITCHED)  
[Other models] ..... 2 (SWITCHED)
- Dimensions (W x H x D)  
..... 435 x 151 x 391 mm (17-1/8" x 5-15/16" x 15-3/8")
- Weight ..... 10 kg (22 lbs.)
- Accessories ..... AM loop antenna  
..... Indoor FM antenna  
..... 75-ohm/300-ohm antenna adapter (U.K. model only)  
..... Antenna adapter (U.S.A. and Canada models only)  
..... Remote control  
..... Batteries

Specifications are subject to change without notice.



## GLOSSARY

### ■ Dolby Surround

Dolby Surround uses four discrete channels and five speakers to reproduce realistic and dynamic sound effects: two main channels (left and right), a center channel for dialog, and a rear channel for special sound effects. The rear channel reproduces sound within a narrow frequency range. Most video tapes and laser discs include Dolby Surround encoding, as do many TV and cable broadcasts. The Dolby Pro Logic decoder built into this unit employs a digital signal processing system that stabilizes each channel for even more accurate sound positioning than is available with standard analog processors.

### ■ Dolby Digital

Dolby Digital is a digital surround sound system that provides completely independent multi-channel audio to you. Dolby Digital provides five full-range channels in what is sometimes referred to as a “3/2” configuration: three front channels (left, center and right), and two surround channels. A sixth bass-only effect channel is also provided for output of LFE (low frequency effect), or low bass effects that are independent of other channels. (This is called the “LFE channel”.) This channel is counted as 0.1, thus giving rise to the term 5.1 channels in total.

The wide dynamic range of sound reproduced by the five full-range channels and precise sound orientation by digital sound processing provides listeners with excitement and realism that have never been experienced before.

### ■ DTS (Digital Theater System) Digital Surround

DTS was developed to replace analog soundtracks of movies with six discrete channels of digital soundtracks, and it is now installed in many theaters around the world. The DTS digital playback system changed the way we experienced movies in theaters with six discrete channels of superb digital audio.

DTS technology, through intense research and development has made it possible to deliver similar encode/decode discrete technology to home audio surround-sound entertainment.

DTS Digital Surround is an encode/decode system which delivers six channels of master-quality, 20-bit audio; technically, it is 5.1 channels, which means 5 full-range (left, center, right and two surround) channels, plus a subwoofer (LFE) channel (as “0.1”). It is compatible with the 5.1 speaker configurations that are currently available for home theater systems.

### ■ CINEMA DSP CINEMA DSP

The Dolby Surround and Dolby Digital sound and DTS systems show their full ability in a large movie theater, because movie sounds are originally designed to be reproduced in a large movie theater that uses a multitude of speakers. Trying to create a sound environment similar to that of a movie theater in your home is difficult because of the room size, material inside the walls, the number of speakers, and so on. In other words, your listening room is very different from a movie theater.

However, YAMAHA DSP technology allows you to create nearly the same sound experience as that of a large movie theater in your home by compensating for the lack of presence and dynamics in the listening room with original digital sound fields combined with Dolby Surround, Dolby Digital or DTS Digital Surround sounds.

The YAMAHA “CINEMA DSP” logo indicates those programs that are created by the combination of YAMAHA DSP technology and Dolby Surround, Dolby Digital or DTS.

### ■ LFE 0.1 Channel

This channel is for reproduction of low bass signals. The frequency range for this channel is 20 Hz to 120 Hz. This channel is called the channel 0.1 because it only reproduces a low frequency range compared to the full-range from 20 Hz to 20 kHz that is reproduced by the 5 channels in a Dolby Digital or DTS 5.1 channel system.

### ■ S VIDEO Signal

The S VIDEO signal is separated and transmitted as the Y signal which indicates the luminance and the C signal which indicates the chroma of the video signal (composite signal). Using the S VIDEO terminal eliminates video signal transmission loss and allows recording and playback of even more beautiful images.



# INDEX

<b>A</b>		
Accessories .....	2	
AC outlet .....	17	
Antennas .....	10, 11	
<b>B</b>		
BALANCE .....	21	
BGV (background video) function .....	21	
<b>C</b>		
Canceling sound effect .....	24	
CINEMA DSP .....	27, 51	
Connections		
Antennas .....	10, 11	
Audio components (tape deck/MD recorder, CD player and turntable) .....	12	
Digital connections .....	13	
Speakers .....	15	
TV monitor .....	13	
Video components (DVD/LD player, VCR and TV/ digital TV, satellite tuner) .....	13	
<b>D</b>		
Delay time (TIME/LEVEL mode) .....	37	
Display .....	6	
Dolby Digital .....	51	
Dolby Surround .....	51	
DSP program .....	24 to 27	
DTS Digital Surround .....	51	
<b>E</b>		
External decoder .....	14	
<b>F</b>		
Front panel .....	4	
<b>I</b>		
IMPEDANCE SELECTOR switch .....	17	
Input mode .....	22	
<b>L</b>		
LFE .....	35, 36, 51	
<b>M</b>		
Muting .....	21	
<b>P</b>		
Playing .....	20	
Preset stations		
To recall a preset station .....	30	
Exchanging preset stations .....	31	
Preset tuning		
Automatic preset tuning .....	29	
Manual preset tuning .....	30	
<b>R</b>		
Recording .....	32	
Remote control		
Basic operations .....	7	
Batteries .....	2	
Component selector .....	7, 40	
Factory-set code .....	46	
Manufacturer's codes .....	i (at the end of this manual)	
Setup codes .....	45	
<b>S</b>		
SET MENU .....	33	
Sleep timer .....	39	
Speaker		
Output levels (TIME/LEVEL mode) .....	37	
Output mode (SET MENU) .....	34, 35	
Speaker balance (test tone) .....	18	
Placement .....	8	
STANDBY/ON .....	4	
<b>T</b>		
Test tone .....	18, 19	
Tone controls .....	21	
Tuning		
Automatic tuning .....	28	
Manual tuning .....	28	



# LIST OF MANUFACTURER'S CODES

## LISTES DES CODES FABRICANT

TV		Elin		1001		Kaypani		1021		Penny		0161, 0361, 0521,	
A-Mark	1161	Elta	0331	Kenwood	0361, 1031, 1111							0531, 0621, 0731,	
A Tandy	0941	Emerson	0001, 0021, 0061,	Kloss	0631, 0721, 1131							0751, 0761, 0781,	
Abex	1151		0071, 0081, 0091,	KTV	0921, 0941, 1011,							0791, 0861, 0931,	
Admira	1141		0111, 0811, 0821,		1051, 1111							0941, 1031, 1041,	
Adventura	1131		0831, 0841, 0851,	Leyco	1001							1111, 1151, 1161	
Aiko	1121		0861, 0871, 0901,	Liesenk & Tter	1001					Peony		1561, 1621	
Akai	0331, 1101, 1111		0921, 0941, 0981,	Lloytron	0941					Philco		0361, 0581, 0591,	
Alba	0431		1011, 1031, 1051,	Loewe	1001							0601, 0611, 0631,	
Alleron	1091		1081, 1091	Logik	0991, 1771							0961, 1031, 1111	
Ambassador	1081	Envision	0361, 1111	Luxman	0351, 0971					Philips		0101, 0401, 1001	
Amstrad	0481, 1081	Erres	1001	Lxi	0101, 0621, 0761,					Phonola		1001	
Anam	0251, 1041, 1051,	Etron	0331		0861, 0981					Pilot		0941, 1031, 1111	
	1061, 1071	Ferguson	1001	Magnavox	0101, 0341, 0391,					Pioneer		0511, 0551, 0871,	
Anam National	1041	Finlux	1001		0401, 0411, 0421,							1331	
AOC	0361, 1021, 1031,	Fisher	0171, 0801, 0981		0581, 0591, 0601,							0941, 1031, 1121	
	1111, 1161	Formenti	0441		0611, 0631, 0661,							0931	
Archer	1161	Formonti	1001		0961, 1111					Prism		0751	
Audiosonic	1001	Fortress	1141	Majestic	0991					Proscan		0761	
Audiovox	1051, 1161	Fujitsu	1091	Marantz	0101, 0221, 0361,					Protech		1001	
Awai	1481	Funai	1051, 1091, 1341,		1001, 1111					Proton		0501, 0861, 0941,	
Bauer	0441		1361, 1411, 1451,	Mark	1001							1021, 1161	
Baur	1001		1501, 1521	Matsui	0271, 0331, 1001					Pulsar		0891	
Beijing	1511, 1551, 1561	Futuretech	1051	Mediator	1001					Pulser		1031	
Belcor	1031	GE	0131, 0161, 0201,	Megatron	0691, 0861, 1161					Quasar		0251, 0751, 1041	
Bell & Howell	0981, 0991		0751, 0761, 0771,	MEI	1011					Quelle		1001	
Beon	1001		0781, 0791, 0811,	M Electronic	1001					Radio Shack		0541, 0941, 1031,	
Bradford	1051		0861, 1041	Memorex	0331, 0571, 0861,							1051, 1151	
Brockwood	1031	GEC	0271, 1001		0971, 0981, 0991,							1001	
Broksonic	1161	Gemini	0391		1771					Radiola		0051, 0141, 0151,	
Bush	1001	Genexxa	0431	Metz	1791, 1831, 1891,					RCA		0181, 0411, 0491,	
Candle	0351, 0361, 0961,	Gibralter	0891, 1031, 1111		1901, 1911, 1921,							0531, 0761, 0771,	
	0971, 1111, 1131	GoldStar	0031, 0121, 0351,		1931, 1941							0871, 1031	
Capehart	1021		0411, 0731, 0741,	MGA	0361, 0561, 0571,					Realistic		0541, 0861, 0941,	
Carver	0101		0861, 0941, 0971,		0861, 1031, 1111							0971, 0981, 1031,	
Cathay	1001		1001, 1031, 1111,	Midland	0751, 0761, 0891,							1051, 1111, 1151	
Celebrity	0951		1151		0941, 1151					Rhapsody		1011	
Centurion	0411	Goodmans/Tashiko	0271, 0661,	Mitsubishi	0221, 0321, 0561,					R-line		1001	
Changhong	1541, 1551, 1561,		1001		0571, 0661, 0861,					Runco		0891, 1111	
	1621	Granada	1001		1031, 1101, 1381					Saisho		0331, 1081	
Citizen	0351, 0361, 0921,	Grundig	1781, 1791, 1801,	Montgomery	1091					Sampo		0361, 0941, 1021,	
	0931, 0941, 0961,		1811, 1821, 1831,	Motorola	1041, 1141							1111, 1151	
	0971, 1111, 1121,		1841, 1851, 1861,	MTC	0351, 0361, 0881,					Samsung		0331, 0341, 0351,	
	1131		1871, 1881		0931, 0971, 1011,							0361, 0861, 0931,	
Clairtone	1011	Gunpy	1051, 1091		1031, 1111							0941, 0971, 1001,	
Clarivox	1001	H/K	0721	Multitech	0881, 1051							1031, 1111, 1151,	
Concerto	0351, 0971	Hallmark	0861	NAD	0551, 0621, 0861							1461	
Conrowa	1751	Hanseatic	1001	NEC	0241, 0351, 0361,					Samsux		0941	
Contec	0901, 0911, 1011,	Harvard	1051, 1061		0661, 0971, 1031,					Sanyo		0171, 0231, 0271,	
	1051	Hinari	1001, 1091		1111, 1321, 1711							0661, 0801, 0911,	
Corando	0941	Hitachi	0181, 0351, 0671,	Neckermann	1001							0981, 1231, 1251,	
Craig	0251, 1051		0681, 0691, 0701,	Nei	1001							1261	
Crown	0941, 1051		0711, 0871, 0941,	Nikkai	0271, 0431, 1001,					SBR		1001	
Curtis Mathes	0161, 0361, 0931,		0971, 1351		1151					Schneider		1001	
	0941, 0981, 1111	Hypson	1001	Nikko	0861, 1111, 1121					Scimitsu		1031	
CXC	1051	Ima	1051	Novabeam	0721					Scotch		0861	
Daewoo	0291, 0301, 0331,	Indiana	1001	NTC	1121					Scott		0831, 0861, 0941,	
	0721, 0941, 1001,	Infinity Reference	0101	Onwa	1051							1031, 1051, 1091	
	1031, 1121, 1191,	Interfunk	1001	Optimus	0551					Sears		0101, 0161, 0171,	
	1531, 1581, 1591,	ITT	0611	Optonica	0541, 1141							0351, 0481, 0521,	
	1601	Janeil	1131	Orion	0831, 1001							0621, 0761, 0801,	
Dansai	1001	JBL	0101	Osaki	0271, 1151							0861, 0971, 0981,	
Daytron	0941, 1031	JCB	0951	Otto Versand	1001							1091	
Decca	0271, 1001	Jensen	0311	Panasonic	0101, 0191, 0251,					Shanghai		1561, 1681	
Dixi	0331, 1001, 1071	Jinxing	1531, 1541, 1551,		0751, 1041, 1311,					Sharp		0461, 0471, 0541,	
Dumont	0891, 1031		1561, 1571, 1621,		1371, 1431							0661, 0911, 0941,	
Dynatech	0881		1631, 1641, 1651,	Panda	1541, 1721							1141, 1241, 1271	
Electroband	0951, 1011		1691, 1731									1031	
Electrohome	0941	JVC	0261, 0281, 0641,							Shogun		0661, 0911, 0941,	
Electron	0941		0651, 0661, 0841							Signature		0991, 1771	
		Kawasho	0901										

Simpson	0581, 0961
Solavox	1151
Sonoko	1001
Sontec	1001
Sony	0371, 0451, 0661, 0841, 0951, 1281, 1441
Soundesign	0861, 0961, 1051, 1091
Soundwave	1001
Spectricon	1161
Squareview	0481
SSS	1031, 1051
Star-lite	1051
Suprem	0951
Supre-macy	1131
Surpa	0351, 0971
Sylvania	0101, 0361, 0441, 0581, 0591, 0601, 0611, 0631, 0961, 1111
Symphonic	0481
Sysline	1001
Tandy	0271, 0431, 1141
Tatung	0271, 0881, 1001, 1041, 1161
Tcl	1561, 1631, 1701
Technics	0751
Techwood	0351, 0751, 0971
Teknika	0101, 0351, 0571, 0931, 0941, 0961, 0971, 0991, 1031, 1051, 1091, 1121, 1131, 1771
Teletech	0331
Tera	0501
Thakral	1671
Thorm	1001
TMK	0351, 0861, 0971, 1081
Toshiba	0381, 0521, 0621, 0661, 0931, 0981, 1301
Tosonic	1011
Totevision	0941
Trical	0911
Universal	0781, 0791
Universum	1001
Vector Research	0361, 1111
Vestel	1001
Victor	0651, 1201, 1211, 1221
Video Concept	1101
Vidikron	0101, 0211
Vidtech	0861, 1031
Viking	1131
Wards	0101, 0361, 0451, 0541, 0581, 0591, 0601, 0611, 0771, 0781, 0791, 0861, 0971, 0991, 1031, 1091, 1111, 1771
Watson	1001
Xogego	1611, 1621, 1661, 1741, 1761
Yamaha	0221, 0361, 0571, 1031, 1111, 1141, 1381
Yoko	1001
Zenith	0011, 0041, 0891, 0991, 1771
Zonda	1161

## CABLE

ABC	0256, 0376
Antronix	0136
Archer	0136, 0286
BBT	0076
Cabletime	0166
Cablevision	0196
Colour Voice	0306, 0346
Comtronics	0216, 0276
Eagle Comtronics	0276
Eastern	0066
Electricord	0206
Electus	0266
GE	0116, 0126
GEC Cable System	0196
Hamlin H5	0676
Hamlin H6	0666
Hamlin H6S	0656
Hamlin H8	0646
Hamlin H9	0636
Jerrold	0256
Jerrold 400L	0626
Jerrold 450L	0616
Jerrold 550	0606
Jerrold Osd Catv	0596
Jerrold Sprucer	0436
Magnavox/Philips	0416, 0426
Mamm	0296
Memorex	0386
Movie Time	0146, 0206
Northcoast	0016
NSC	0146
Oak	0106
Oak Sigma 450	0546
Oak Sigma 550	0536
Panasonic TZ 120/130	0476
Panasonic TZ 170/180	0446
Panasonic TZ140	0466
Panasonic TZ150/160	0456
Paragon	0386
Philips	0036, 0216, 0306, 0316, 0326, 0336, 0346
Pioneer	0006, 0086
Pioneer BR50	0846
Pioneer BR60/70/80/81/82	0696
Pioneer BR90	0556
Pulsar	0386
RCA Digital Satellite System	0396, 0406
Realistic	0136
Regency/Eastern	0686
Runco	0386
Samsung	0276
Scientific Atlanta 175/475	0576
Scientific Atlanta 75	0366, 0586
Scientific Atlanta 8650	0566
Signal	0276
SL Marx	0276
Spectavision	0236
Standard Components	0186
Starcom V	0256
Stargate	0276
Sylvania/Texscan	0376, 0496
Teknika	0176
Teleservice	0056
Television	0276
Texscan	0186, 0376
TFC	0026
Tocom	0226, 0356
Tocom 5503A	0526
Tocom 5503VIP/5507	0516
Tocom TC56	0506
Toshiba	0386
Tudi	0046

Unika	0136
Universal	0136, 0156, 0206, 0286
Videoway	0096
Viewstar	0216
Zenith	0246, 0386, 0486

## SATELLITE TUNER

Alpha Star	0826
Chaparral	0756
Echostar	0836
General Instrument	0776
HTS	0836
Hughes Network Systems	0816
Jerrold	0776, 0786
Panasonic	0806
Primestar	0776, 0786
RCA	0766
Sony	0796

## VCR

A Tandy	0902
Adventura	0992
Aiko	0982
Aiwa	0992
Akai	0262, 0942, 0952, 0962, 0972
American High	0932
Amstrad	0992
ASA	0002, 0912
Asha	0922
Audio Dynamics	0202
Audiovox	0912
Beaumarck	0922
Bell & Howell	0902
Blaupunkt	0412
Broksonic	0872, 0882, 0892
Bush	0852
Calix	0912
Canon	0862, 0932
CCE	0852, 0982
Citizen	0912, 0982
Colt	0852
Craig	0832, 0842, 0852, 0912, 0922
Curtis Mathes	0662, 0822, 0932
Cybernex	0922
Daewoo	0802, 0812, 0982
DBX	0202
Dynatech	0472, 0992
Electrohome	0912
Electrophonic	0912
Emerex	0792
Emerson	0072, 0132, 0142, 0152, 0162, 0172, 0182, 0192, 0212, 0702, 0712, 0722, 0732, 0742, 0752, 0762, 0772, 0782, 0872, 0882, 0892, 0912, 0952, 0992, 1072
Finlux	0002, 0992
Fisher	0682, 0692, 0842, 0902
Fuji	0672, 0932
Funai	0992
Garrard	0992
GE	0662, 0822, 0932
Go Video	0642, 0652
GoldStar	0082, 0632, 0912
Goodmans	0402
Gradiente	0992
Granda	0612, 0902
Grundig	0002
H/K	1082
Harley Davidson	0992
Harmon/Kardon	0632, 1082
Harwood	0752, 0852
Headquarter	0612
HI-Q	0842
Hinari	0852
Hitachi	0102, 0562, 0572, 0582, 0592, 0602, 0992
ITT	0942
JVC	0202, 0522, 0532, 0542, 0552
Kenwood	0202, 0542, 0612, 0632, 0902
KLH	0852
Kodak	0912, 0932
Lloyd	0992
Logik	0852
Luxor	0942
LXI	0022, 0912
Magnavox	0002, 0482, 0492, 0502, 0512, 0932
Magnin	0922
Marantz	0002, 0202, 0402, 0632, 0932
Marta	0912
Matsui	0722
Matsushita	0932
MEI	0222, 0932
Memorex	0232, 0242, 0472, 0512, 0612, 0842, 0902, 0912, 0922, 0932, 0992
MGA	0762, 0952
MGA Technology	0922
Minolta	0592, 0602
Mitsubishi	0452, 0462, 0542, 0762, 0952, 1082
Motorola	0472, 0932
MTC	0922, 0992
Multitech	0852, 0992
NAD	0442
NEC	0122, 0202, 0292, 0422, 0432, 0542, 0632
Nikko	0912
Noblex	0922
Olympus	0412, 0932
Optimus	0442, 0472, 0912
Optonica	0402
Orion	0212, 0722, 0742, 0772
Osaki	0912
Panasonic	0012, 0052, 0092, 0222, 0372, 0382, 0392, 0412, 0932
Penny	0202, 0432, 0602, 0632, 0692, 0912, 0922, 0932
Pentax	0592, 0602
Perdio	0992
Philco	0002, 0932
Philips	0002, 0282, 0402, 0492, 0932
Pilot	0912
Pioneer	0442, 0542
Proscan	1002, 1012, 1022, 1032, 1042, 1052, 1062
Pulsar	0512
Quarter	0612
Quartz	0272, 0612
Quasar	0382, 0392, 0932
Radio Shack	0912, 0992
Radix	0912
Randex	0912

RCA	0112, 0382, 0392, 0482, 0592, 0602, 0662, 0822, 0942
Realistic	0402, 0472, 0612, 0682, 0842, 0902, 0912, 0922, 0932, 0992
Ricoh	0352, 0362
Saisho	0212, 0582, 0722, 0732, 0742, 0772
Salora	0612, 0762
Samsung	0212, 0312, 0922, 0962
Sanky	0472, 0512
Sansui	0292, 0542, 0832
Sanyo	0242, 0612, 0842, 0902, 0922
SBR	0002, 0282
Schneider	0852
Scott	0342, 0712, 0762, 0872, 0882, 0892
Sears	0302, 0592, 0602, 0612, 0682, 0692, 0842, 0902, 0912, 0932
Sharp	0402, 0472
Shintom	0852
Shogun	0922
Singer	0852
Sony	0032, 0332, 0352, 0362, 0672, 0792, 0932
STS	0602
Sunpak	0352
Sylvania	0002, 0492, 0502, 0762, 0932, 0992
Symphonic	0992
Tandy	0992
Tashiko	0712, 0992
Teac	0992
Technics	0932
Teknika	0322, 0912, 0932, 0992
Telefunken	0252
TMK	0212, 0732, 0772, 0922
Toshiba	0062, 0302, 0342, 0622, 0682, 0712, 0762
Totevision	0912, 0922
Unitech	0922
Vector Research	0202, 0432, 0632
Victor	0532, 0542, 0552
Video Concepts	0202, 0432, 0632, 0952
Wards	0322, 0402, 0472, 0482, 0602, 0712, 0842, 0852, 0922, 0932, 0992
Yamaha	0202, 0632, 0762
Zenith	0042, 0362, 0512, 0672

## DVD PLAYER

Akai	0108
JVC	0168
Onkyo	0128
Panasonic	0048
Philips	0188
Pioneer	0208, 0228
Samsung	0148
Sharp	0068
Sony	0028
Toshiba	0088
Yamaha	0008, 0048

## LD PLAYER

Aiwa	0157
Denon	0147
Disco Vision	0017
Funai	0157
Hitachi (E)	0017
Kenwood	0087, 0107
Magnavox	0027
Marantz	0027
Mitsubishi	0137
NAD	0137
Panasonic	0077, 0177
Philips	0027
Pioneer	0037, 0017, 0137
RCA	0167
Realistic	0157
Sharp	0127
Sony	0047, 0057, 0117
Victor	0097
Yamaha	0007, 0067

## CD PLAYER

Acoustic Research	1295
ADC	0025, 0065
Adcom	0205, 0255, 1015
ADS	0265
Aiwa	0295, 0945, 1035, 1055
Akai	0175, 0485, 0535
Alpine	1215, 1305
Audio-Technica	0545
BSR	0245, 0655, 0775
California Audio Lab	0055
Capetronic	1205
Carrera	0245
Carver	0285, 1135
Casio	0345
Crown	0185
Curtis Maths	0345
Denon	0275, 0875, 0885
Deual (E)	0505
Dynamic Bass (H)	0555
Emerson	0205, 0325, 1105
Eroica	1275
Fisher	0095, 0555, 0925, 1005
Garrard	0365
Genexxa	0305, 0325, 1105
GoldStar	1225, 1265, 1135, 1335
H/K	0105, 0175, 0465, 0995
Hitachi	0195, 0505, 0205, 0815
Inkel	0115, 0395
JVC	0315
Kenwood	0045, 0095, 0405, 0585, 0725, 0735, 0745, 0755, 0895
Kyocera	0025
Luxman	0075, 0425, 0675, 0705, 0715, 0985
Magnavox	0165, 0215, 0645, 0955
Marantz	0215, 0235, 0375, 0785, 1345
McIntosh	0355, 1085
MCS	0905, 1315
Memorex	0205, 0225, 0235, 0305, 0325, 1105

MGA	0135
Mission	0215
Mitsubishi	0135, 0445
MTC	1255
NAD	0035, 0615, 0685, 0695
Nakamichi	0125, 0435, 0515
NEC	0255, 0905, 0965
Nikko	0545, 1005
Onkyo	0155, 0455, 0495, 0805, 1155
Optimus	0225, 0245, 0555, 0595, 0845, 0855, 0865, 0895, 0935
Panasonic	0055, 0825, 1095, 1125
Penny	0905
Philips	0165, 0215
Pioneer	0305, 0935, 1045
Proton	0215, 1185
Quasar	0055
RCA	0205, 0915, 1115
Realistic	0205, 0225, 0235, 0325, 0555, 0845
Revox	1175
Rotel	0215
Saba Telecommander (E)	0505
SAE	0215
Samsung	1285
Sansui	0215, 0625, 0975, 1025, 1105
Sanyo	0145, 0555, 0635, 0765
Scott	0325, 1105
Sears	0345
Sharp	0235, 0665, 0895, 1065, 1075
Sherwood	0115, 0235, 0395, 0475
Siemens Garrard	1245
Signature	0175
Sontec	1165
Sony	0065, 0565, 0865, 1145
Staron	1235
STS	0025
Sylvania	0215
Symphonic	0335
Tandy	0305
Tangberg	1195
Teac	0235, 0335, 0385, 0525, 0795, 0835, 1355
Technics	0055, 0605, 1095
Techwood	1325
Telefunken (E)	0505
Thomson (E)	0505
Toshiba	0035, 0685
Vector Research	0065, 1135
Victor	0315
Wards	0175
Yamaha	0005, 0015, 0575, 1065

## TAPE DECK

Aiwa	0094, 0214, 0224
Akai	0184
Carver	0094
Denon	0304
Fisher	0144
Garrard	0194, 0204
JVC	0274, 0284, 0294
Kenwood	0124, 0134, 0154, 0234, 0244, 0264
Magnavox	0094
Marantz	0094, 0344
Mitsubishi	0184
Onkyo	0364, 0374
Optimus	0034, 0064, 0204, 0334
Philips	0094
Pioneer	0034, 0044, 0064
Revox	0354
Sansui	0094, 0344
Sharp	0264
Sherwood	0334
Sony	0054, 0084, 0324
Teac	0194, 0254
Technics	0074, 0314
Victor	0294
Wards	0034
Yamaha	0004, 0014

## MD RECORDER

Yamaha	0024
--------	------



---

**YAMAHA ELECTRONICS CORPORATION, USA** 6660 ORANGETHORPE AVE., BUENA PARK, CALIF. 90620, U.S.A.  
**YAMAHA CANADA MUSIC LTD.** 135 MILNER AVE., SCARBOROUGH, ONTARIO M1S 3R1, CANADA  
**YAMAHA ELECTRONIK EUROPA G.m.b.H.** SIEMENSSTR. 22-34, 25462 RELINGEN BEI HAMBURG, F.R. OF GERMANY  
**YAMAHA ELECTRONIQUE FRANCE S.A.** RUE AMBROISE CROIZAT BP70 CROISSY-BEAUBOURG 77312 MARNE-LA-VALLÉE CEDEX02, FRANCE  
**YAMAHA ELECTRONICS (UK) LTD.** YAMAHA HOUSE, 200 RICKMANSWORTH ROAD WATFORD, HERTS WD1 7JS, ENGLAND  
**YAMAHA SCANDINAVIA A.B.** J A WETTERGRENS GATA 1, BOX 30053, 400 43 VÄSTRA FRÖLUNDA, SWEDEN  
**YAMAHA MUSIC AUSTRALIA PTY, LTD.** 17-33 MARKET ST., SOUTH MELBOURNE, 3205 VIC., AUSTRALIA

**YAMAHA CORPORATION**  
Printed in Malaysia ID V502840-2

# Quick Reference Card

AMP(TUNER)		TAPE/MD		CD		DVD/LD	
<b>POWER</b>		<b>POWER</b>		<b>POWER</b>		<b>POWER</b>	
<b>Input selector buttons</b>		<b>Input selector buttons</b>		<b>Input selector buttons</b>		<b>Input selector buttons</b>	
<b>A/B/C/D/E TEST</b>		<b>EFFECT</b>		<b>EFFECT</b>		<b>EFFECT</b>	
<b>VOLUME</b>		<b>VOLUME</b>		<b>VOLUME</b>		<b>VOLUME</b>	
<b>MUTE</b>		<b>MUTE</b>		<b>MUTE</b>		<b>MUTE</b>	
<b>SLEEP</b>		<b>SLEEP</b>		<b>SLEEP</b>		<b>SLEEP</b>	
<b>TV INPUT</b>		<b>REC/PAUSE</b>		<b>TV INPUT</b>		<b>TV INPUT</b>	
<b>PRG+, PRG-</b>		<b>PLAY</b>		<b>PAUSE</b>		<b>PAUSE</b>	
<b>TIME LEVEL</b>		<b>DIR A (TAPE)</b>		<b>SKIP-</b>		<b>SKIP+</b>	
		<b>SKIP- (MD)</b>		<b>SEARCH</b>		<b>SEARCH</b>	
		<b>REWIND (TAPE)</b>		<b>STOP</b>		<b>STOP</b>	
		<b>SEARCH (MD)</b>					
		<b>STOP</b>					
		<b>FAST FORWARD (TAPE)</b>					
		<b>SEARCH (MD)</b>					
		<b>STOP</b>					
		<b>DISC SKIP+/-</b>					
		<b>DISPLAY (MD)</b>					
		<b>DECK A/B (TAPE)</b>					
		<b>DISPLAY</b>					
		<b>TV INPUT</b>					
		<b>PAUSE</b>					
		<b>SKIP+</b>					
		<b>SEARCH</b>					
		<b>STOP</b>					

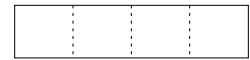

# Quick Reference Card

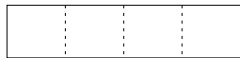
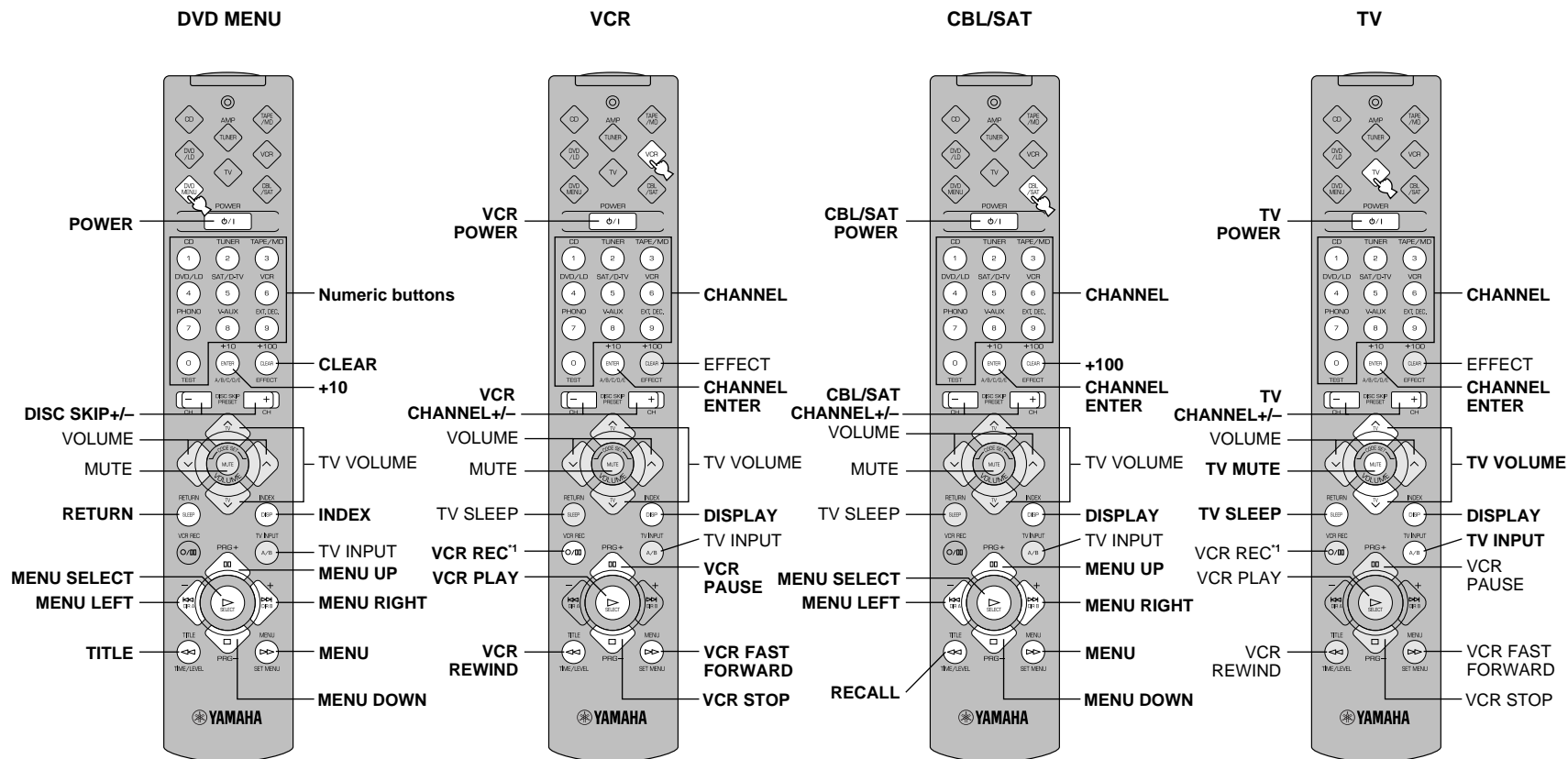

\*1 Press this button twice to start recording.  
 Appuyer deux fois sur cette touche pour commencer l'enregistrement.  
 Drücken Sie diese Taste zweimal, um die Aufnahme zu starten.  
 Tryck två gånger på den här knappen för att börja spela in.

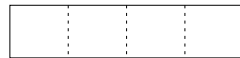
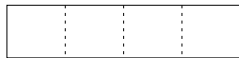

Premere due volte questo tasto per iniziare la registrazione.  
 Presione dos veces este botón para empezar a grabar.  
 Druk tweemaal op deze toets om met opnemen te beginnen.  
 按此按钮两次即可开始录像。

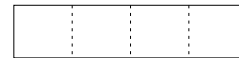

# Connection Guide (when listening to a digital 5.1-channel source)

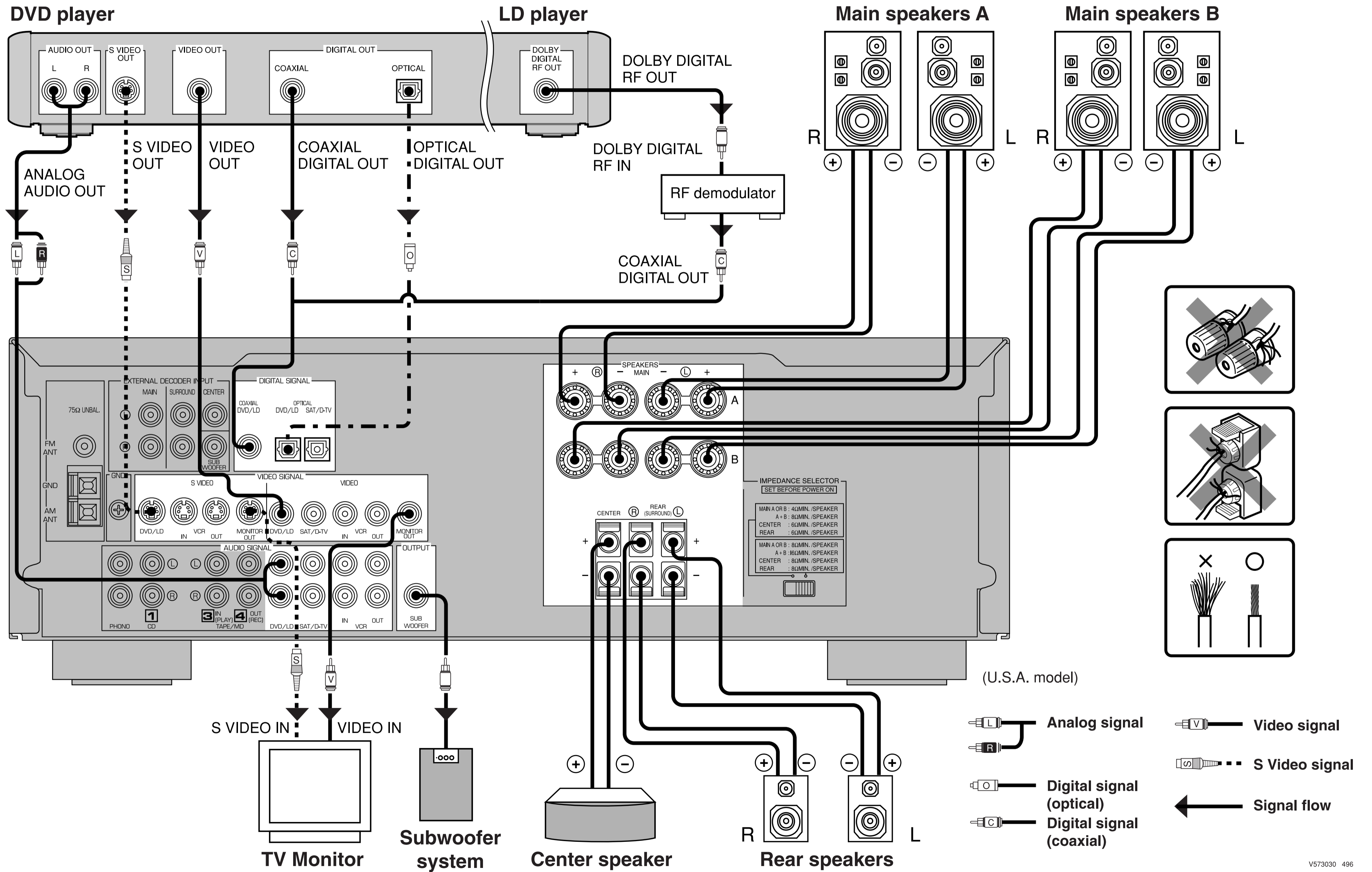

## Free Manuals Download Website

<http://myh66.com>

<http://usermanuals.us>

<http://www.somanuals.com>

<http://www.4manuals.cc>

<http://www.manual-lib.com>

<http://www.404manual.com>

<http://www.luxmanual.com>

<http://aubethermostatmanual.com>

Golf course search by state

<http://golfingnear.com>

Email search by domain

<http://emailbydomain.com>

Auto manuals search

<http://auto.somanuals.com>

TV manuals search

<http://tv.somanuals.com>