



AV Receiver RX-V671 Easy Setup Guide

English for Canada

This document explains how to set up a 5.1- or 7.1-channel system and play back surround sound of a BD/DVD on this unit. For more information, refer to "Owner's Manual" on the supplied CD-ROM.

A PDF format of this guide and "Owner's Manual" can be downloaded from the following website.

<http://download.yamaha.com/>

1 Preparations

Accessories

Check that the following accessories are supplied with this product.

- Remote control

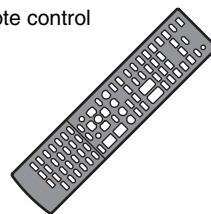

- Batteries (AAA, R03, UM-4) (x 2)

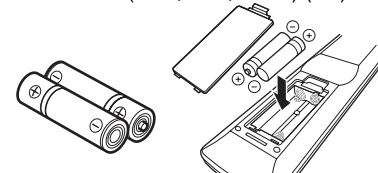

Insert into the remote control in the correct polarity (+/-).

- YPAO microphone



- VIDEO AUX input cover



- AM antenna



- FM antenna



- CD-ROM
(Owner's Manual)



- Safety Brochure



- Easy Setup Guide
(this document)



Cables necessary for connections

You need to separately prepare the following cables to build the system based on this document.

- Speaker cables (depending on the number of speakers)
- HDMI cable (x 2)
- Audio pin cable (x 1)
- Digital optical cable (x 1) (unnecessary if your TV supports ARC)

2 Placing the speakers

Set up the speakers in the room by using the following diagram as a reference.
For information on other speaker systems, refer to "Owner's Manual".

5.1-channel system

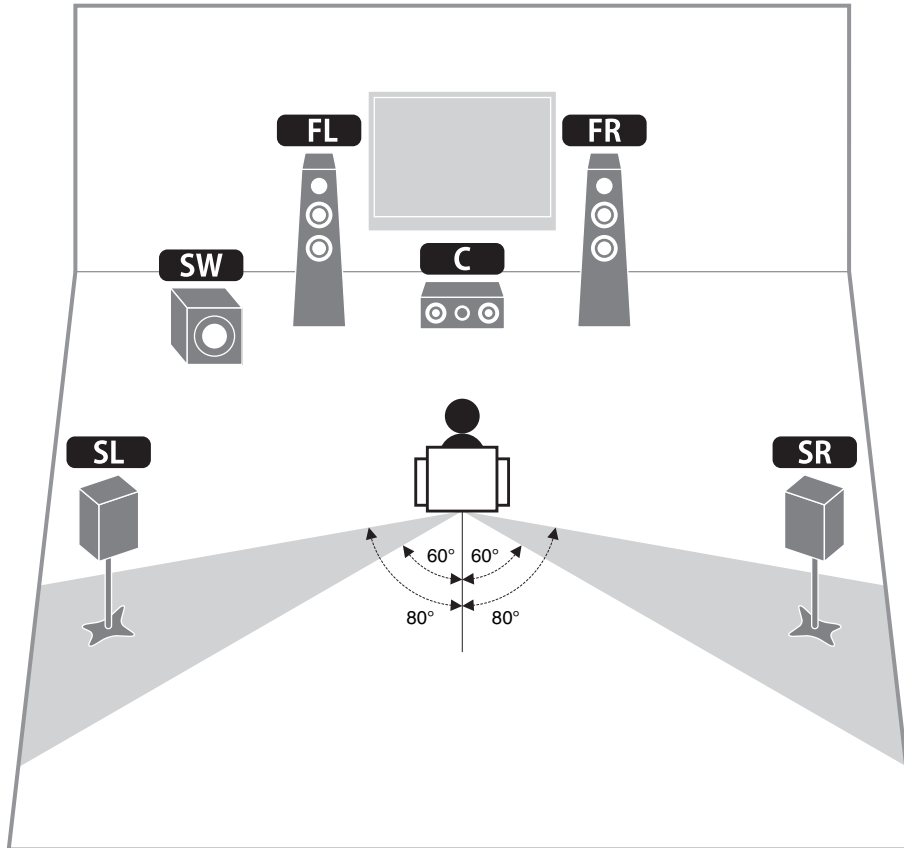

7.1-channel system

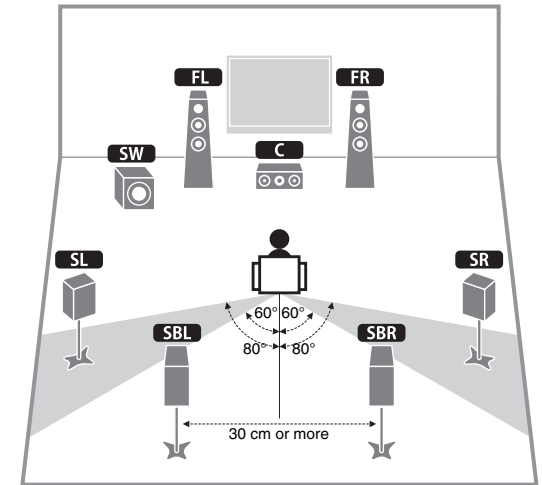

- FL** Front speaker (L)
- FR** Front speaker (R)
- C** Center speaker
- SL** Surround speaker (L)
- SR** Surround speaker (R)
- SBL** Surround back speaker (L)
- SBR** Surround back speaker (R)
- SW** Subwoofer

3 Connecting the speakers/subwoofer

- This unit is configured for 8-ohm speakers at the factory. When connecting 6-ohm speakers, set the speaker impedance of this unit to "6 Ω MIN". For details, see "Setting the speaker impedance" (p.16) in "Owner's Manual".
- Use a subwoofer equipped with built-in amplifier.
- Remove the power cable of this unit from an AC wall outlet and turn off the subwoofer before connecting the speakers.
- Be careful that the core of the speaker cable does not touch anything or come into contact with the metal areas of this unit. This may damage this unit or the speakers. If the speaker cables short circuit, "CHECK SP WIRES" will appear on the front display when this unit is turned on.

Connecting speaker cables

Speaker cables have two wires. One is for connecting the negative (-) terminal of the unit and the speaker, and the other is for the positive (+) terminal. If the wires are colored to prevent confusion, connect the black wire to the negative and the other wire to the positive.

- 1 Remove approximately 10 mm of insulation from the ends of the speaker cable, and twist the bare wires of the cable together firmly.
- 2 Loosen the speaker terminal.
- 3 Insert the bare wires of the cable into the gap on the side (upper right or bottom left) of the terminal.
- 4 Tighten the terminal.

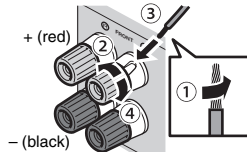

Using a banana plug

- 1 Tighten the speaker terminal.
- 2 Insert a banana plug into the end of the terminal.

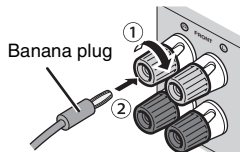

1 Connect the front speakers (FL / FR) to the FRONT (L/R) terminals.

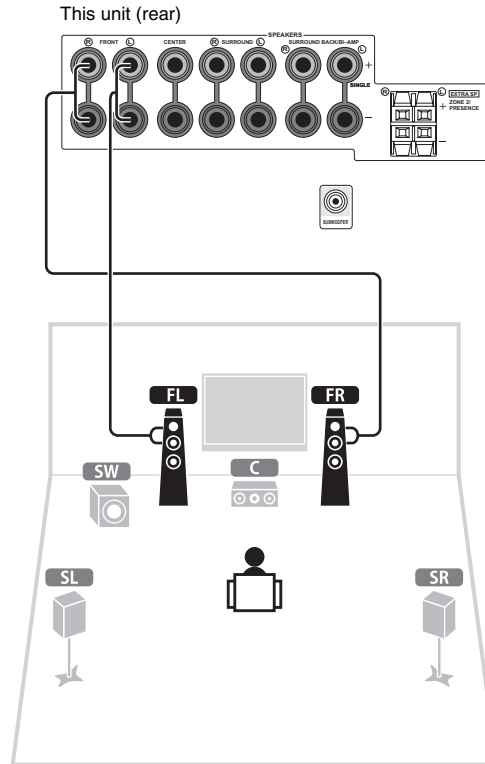

2 Connect the center speaker (C) to the CENTER terminal.

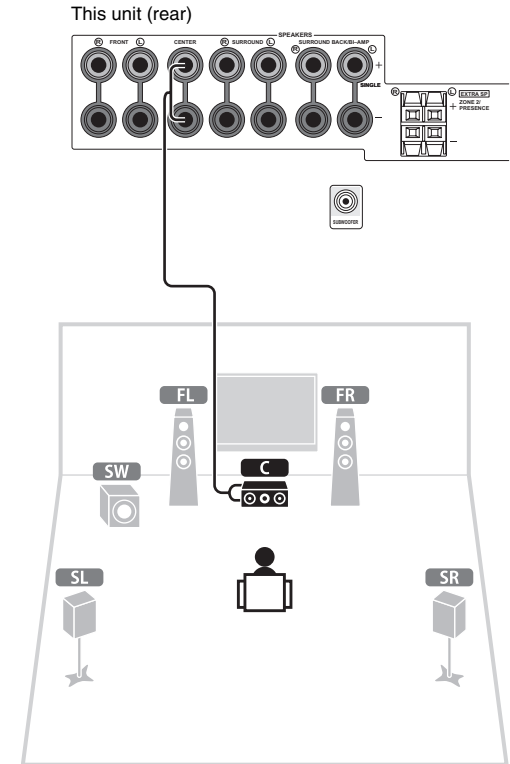

3 Connect the surround speakers (**SL** / **SR**) to the SURROUND (**L** / **R**) terminals.

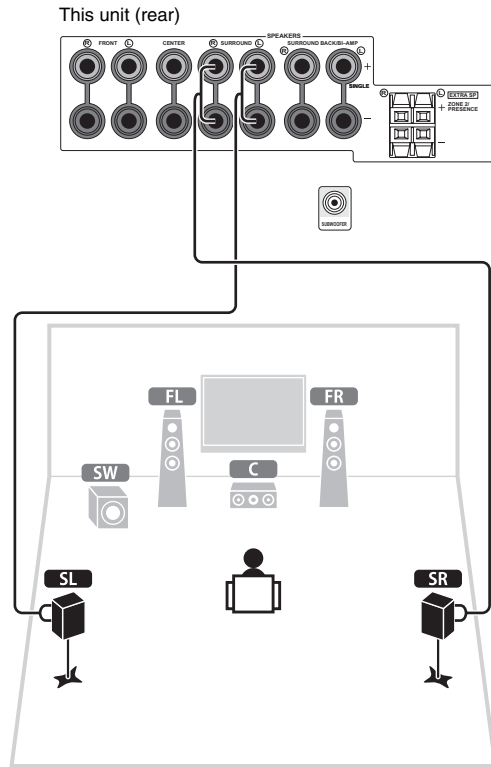

4 Connect the subwoofer (**SW**) to the SUBWOOFER jack.

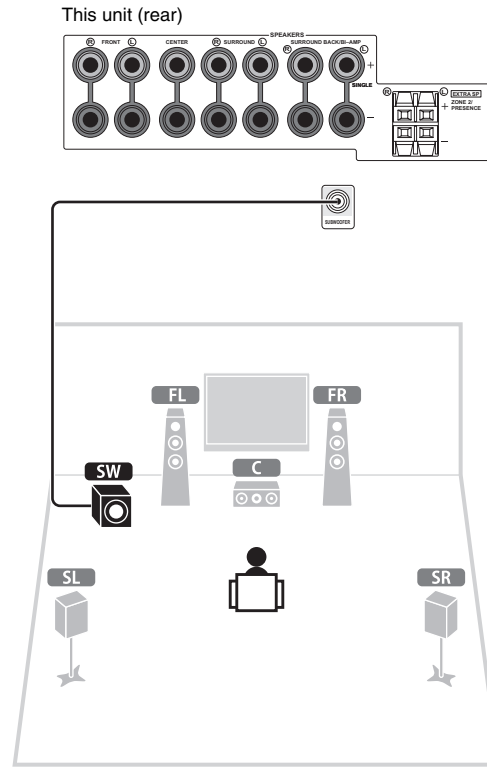

For 7.1-channel system

Connect the surround back speakers (**SBL** / **SBR**) to the SURROUND BACK (**L** / **R**) terminals.

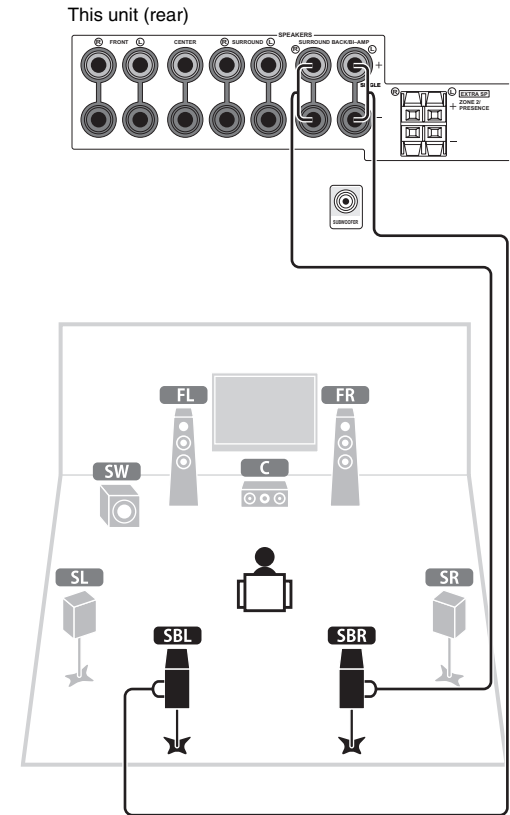

Use an audio pin cable to connect the subwoofer (**SW**).

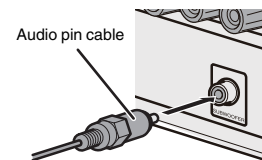

4 Connecting the external devices

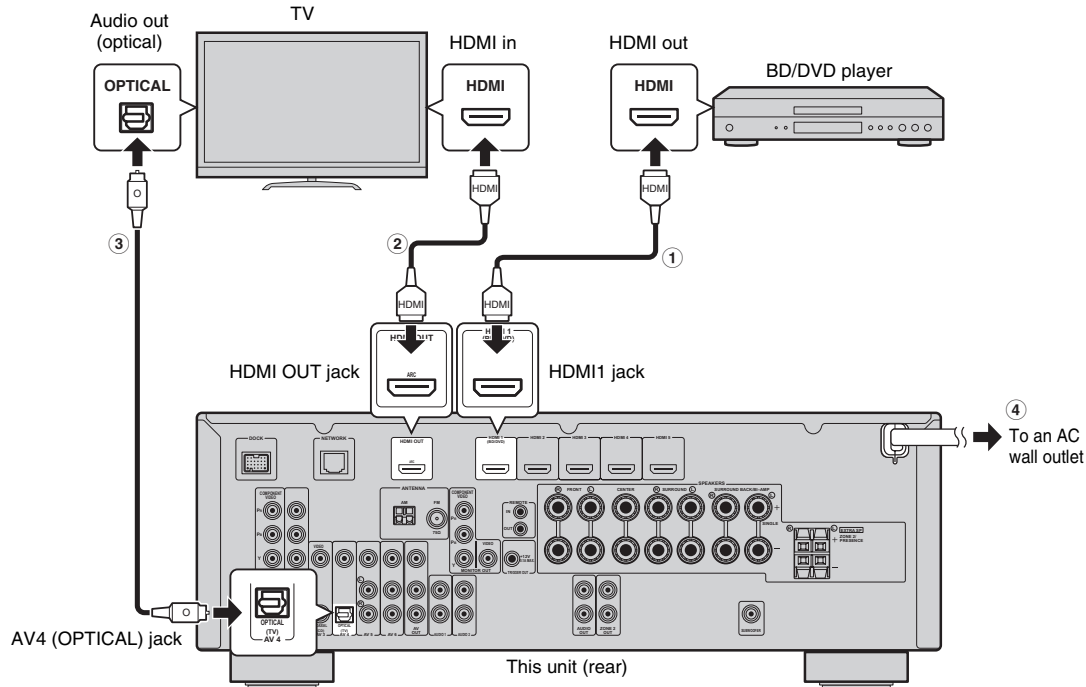

1 Connect the external devices to this unit.

- ① Connect the BD/DVD player and this unit with an HDMI cable.
If the BD/DVD player is currently connected to the TV directly with an HDMI cable, disconnect the cable from the TV and connect it to this unit.
- ② Connect the TV and this unit with another HDMI cable.
- ③ Connect the TV and this unit with a digital optical cable.
This connection is required to play back TV audio on this unit. If your TV supports ARC (Audio Return Channel), this connection is unnecessary.
- ④ Connect the power cable to an AC wall outlet.



- For information on how to connect radio antennas or other external devices, see "SETUP" in "Owner's Manual".

2 Turn on this unit, TV and BD/DVD player. 3 With the remote control of the TV, switch the TV input to display the video from this unit.

The connections are complete. Move to the next page to optimize the speaker settings.

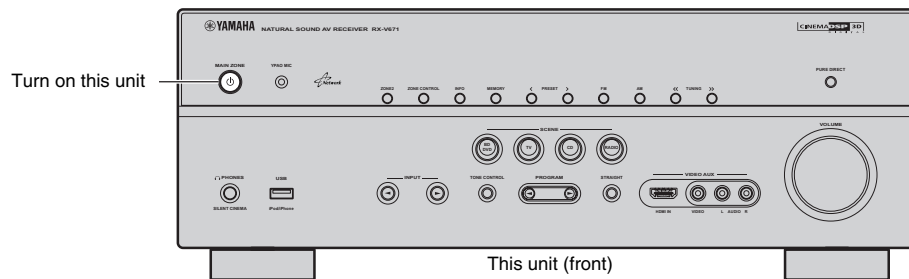

5 Optimizing the speaker settings automatically (YPAO)

By using the Yamaha Parametric room Acoustic Optimizer (YPAO) function, this unit automatically detects speaker connections and distances from the listening position, and optimizes the speaker settings such as volume balance and acoustic parameters to suit your room.

- During the measuring process, the test tones are output at high volume. Take care that the test tone does not frighten small children. Also, refrain from using this function at night when it may be a nuisance to others.
- During the measuring process, you cannot adjust the volume.
- During the measuring process, keep the room as quiet as possible.
- Do not connect headphones.
- If your subwoofer supports the auto-standby function, disable it.
- YPAO measurement is not performed correctly when any obstacles are in the room.
- During the measuring process (about 3 minutes), keep stuff in the corners or remove it from the room.

Preparing for YPAO

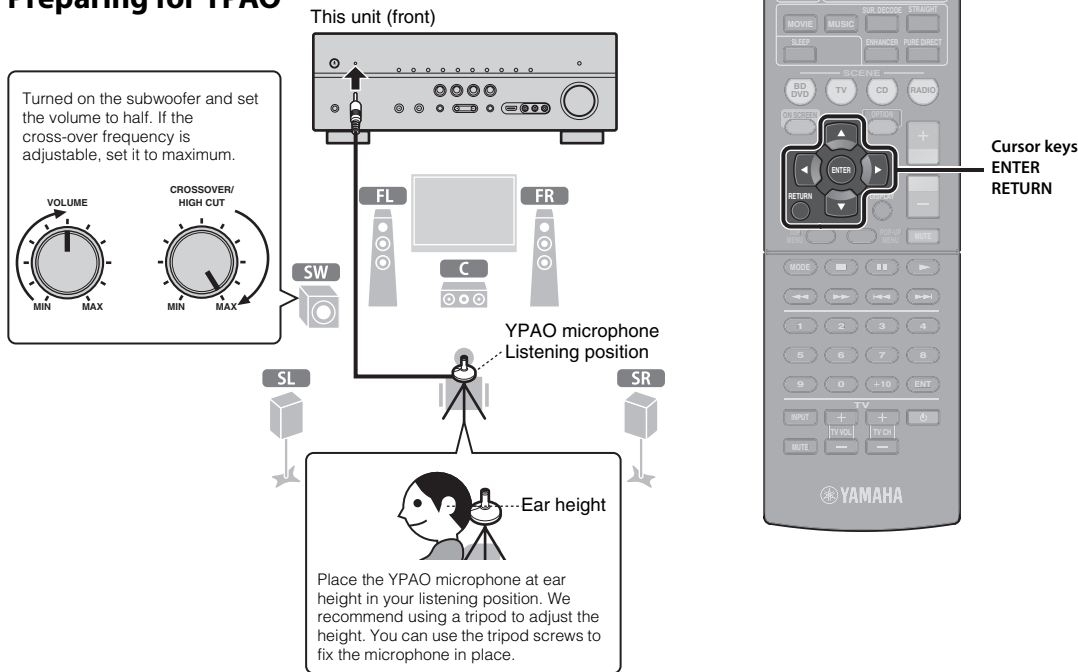

1 Connect the YPAO microphone to the YPAO MIC jack on the front panel.

The following screen appears on the TV.

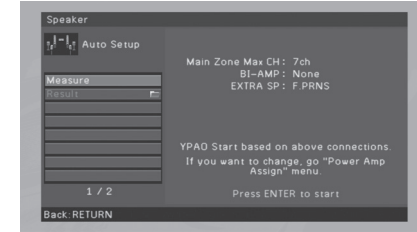

- To cancel the operation, disconnect the YPAO microphone before starting the measurement.

2 To start the measurement, use the cursor keys to select "Measure" and press ENTER.

The measurement will start in 10 seconds.

The following screen appears on the TV when the measurement finishes.

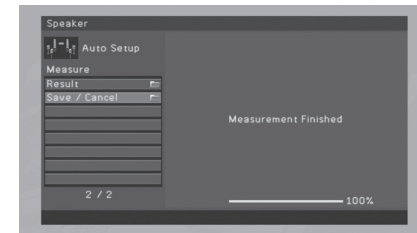

- If any error message (such as E-1) or warning message (such as W-2) appears, see "Error messages" (p.37) or "Warning messages" (p.38) in "Owner's Manual".
- If the warning message "W-1:Out of Phase" appears, see "If 'W-1:Out of Phase' appears" (next page).

- 3 Use the cursor keys to select “Save/Cancel” and press ENTER.**

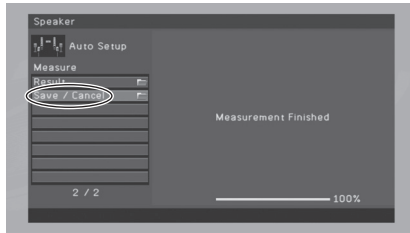

- 4 Use the cursor keys to select “SAVE” and press ENTER.**

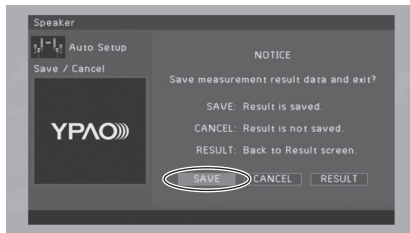

- 5 Disconnect the YPAO microphone from this unit.**
Now optimization of the speaker settings is complete.

- Since the YPAO microphone is sensitive to heat, do not place the microphone in any place where it will be subjected to direct sunlight or high temperatures (top of an AV equipment, etc).

If “W-1: Out of Phase” appears

Follow the procedure below to check the speaker connections.
Depending on the type of speakers or room environment, this message may appear even if the speakers are connected correctly.

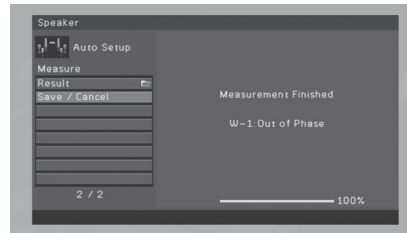

- ① Use the cursor keys to select “Result” and press ENTER.
- ② Use the cursor keys to select “Wiring”.
- ③ Check the cable connections (+/-) of the speaker indicated with “Reverse”.

If the speaker is connected correctly:

You can save the current settings.
Press RETURN and proceed to step 3.

If the speaker is connected incorrectly:

Turn off this unit, reconnect the speaker cable, and then try YPAO measurement again.

6 Playing back a BD/DVD

Now let's play back a BD/DVD.
We recommend playing back multichannel audio (5.1-channel or more) to feel surround sound produced by this unit.

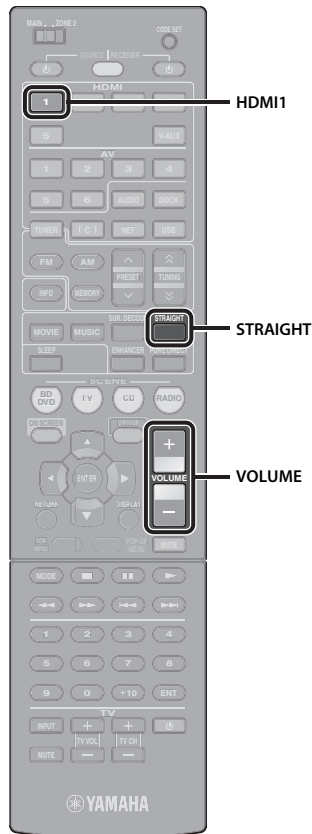

1 Press HDMI1 to select “HDMI1” as the input source.



2 Start playback on the BD/DVD player.
3 Press STRAIGHT repeatedly to select “STRAIGHT”.



- When “STRAIGHT” (straight decode) is enabled, each speaker produces each channel audio signal directly (without sound field processing). If you play back 5.1-channel audio on the 7.1-channel system, no sounds will be heard from the surround back speakers.

4 Press VOLUME to adjust the volume.



Now the basic setup procedure is complete.

If you cannot have surround sound

Only the front speakers work on multichannel audio
Check the digital audio output setting on the BD/DVD player.

It may be set to output 2-channel audio (PCM, etc.) only.

No sound is heard from a specific speaker

See “Troubleshooting” (p.104) in “Owner’s Manual”.

Much more features!

This unit has various other functions.
Please refer to “Owner’s Manual” on the supplied CD-ROM and utilize this unit effectively.

Connecting other playback devices (p.26)

Connect audio devices (CD player, etc.), game console, camcorder, and many others.

Selecting the sound mode (p.41)

Select the desired sound program (CINEMA DSP) or surround decoder suitable for movies, music, games, sports programs and other uses.

Playing back from iPod (p.49)

By using a USB cable supplied with iPod, an optional Yamaha iPod dock or an optional Yamaha iPod wireless system, you can enjoy iPod music on this unit.

- **Listening to FM/AM radio (p.46)**
- **Playing back music stored on a USB storage device (p.56)**
- **Playing back the network contents (p.59 to p.62)**
- **Selecting the input source and favorite settings at once (p.40)**

For more information, see “What you can do with this unit” (p.6).

Free Manuals Download Website

<http://myh66.com>

<http://usermanuals.us>

<http://www.somanuals.com>

<http://www.4manuals.cc>

<http://www.manual-lib.com>

<http://www.404manual.com>

<http://www.luxmanual.com>

<http://aubethermostatmanual.com>

Golf course search by state

<http://golfingnear.com>

Email search by domain

<http://emailbydomain.com>

Auto manuals search

<http://auto.somanuals.com>

TV manuals search

<http://tv.somanuals.com>